

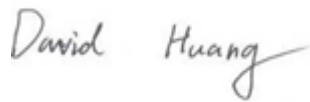

RF TEST REPORT



Report No.: 17071091-FCC-R5

Supersede Report No.: N/A

Applicant	TECNO MOBILE LIMITED	
Product Name	Mobile phone	
Model No.	K8	
Serial No.	N/A	
Test Standard	FCC Part 22(H):2016, FCC Part 24(E):2016, FCC Part 27: 2016; ANSI/TIA-603-D: 2010	
Test Date	October 17 to November 07, 2017	
Issue Date	November 08, 2017	
Test Result	<input checked="" type="checkbox"/> Pass <input type="checkbox"/> Fail	
Equipment complied with the specification	<input checked="" type="checkbox"/>	
Equipment did not comply with the specification	<input type="checkbox"/>	
		
Loren Luo Test Engineer	David Huang Checked By	
This test report may be reproduced in full only Test result presented in this test report is applicable to the tested sample only		

Issued by:

SIEMIC (SHENZHEN-CHINA) LABORATORIES

Zone A, Floor 1, Building 2 Wan Ye Long Technology Park

South Side of Zhoushi Road, Bao' an District, Shenzhen, Guangdong China 518108

Phone: +86 0755 2601 4629801 Email: China@siemic.com.cn

Laboratories Introduction

SIEMIC, headquartered in the heart of Silicon Valley, with superior facilities in US and Asia, is one of the leading independent testing and certification facilities providing customers with one-stop shop services for Compliance Testing and Global Certifications.



In addition to testing and certification, SIEMIC provides initial design reviews and compliance management throughout a project. Our extensive experience with China, Asia Pacific, North America, European, and International compliance requirements, assures the fastest, most cost effective way to attain regulatory compliance for the global markets.

Accreditations for Conformity Assessment

Country/Region	Scope
USA	EMC, RF/Wireless, SAR, Telecom
Canada	EMC, RF/Wireless, SAR, Telecom
Taiwan	EMC, RF, Telecom, SAR, Safety
Hong Kong	RF/Wireless, SAR, Telecom
Australia	EMC, RF, Telecom, SAR, Safety
Korea	EMI, EMS, RF, SAR, Telecom, Safety
Japan	EMI, RF/Wireless, SAR, Telecom
Singapore	EMC, RF, SAR, Telecom
Europe	EMC, RF, SAR, Telecom, Safety

Test Report	17071091-FCC-R5
Page	3 of 111

This page has been left blank intentionally.

CONTENTS

1. REPORT REVISION HISTORY	5
2. CUSTOMER INFORMATION	5
3. TEST SITE INFORMATION	5
4. EQUIPMENT UNDER TEST (EUT) INFORMATION	6
5. TEST SUMMARY	9
6. MEASUREMENTS, EXAMINATION AND DERIVED RESULTS	10
6.1 RF EXPOSURE (SAR).....	10
6.2 RF OUTPUT POWER.....	11
6.3 PEAK-AVERAGE RATIO.....	35
6.4 OCCUPIED BANDWIDTH.....	39
6.5 SPURIOUS EMISSIONS AT ANTENNA TERMINALS.....	61
6.6 SPURIOUS RADIATED EMISSIONS.....	65
6.7 BAND EDGE.....	70
6.8 BAND EDGE 27.53(M).....	83
6.9 FREQUENCY STABILITY	89
ANNEX A. TEST INSTRUMENT.....	93
ANNEX B. EUT AND TEST SETUP PHOTOGRAPHS.....	95
ANNEX C. TEST SETUP AND SUPPORTING EQUIPMENT.....	107
ANNEX C.II. EUT OPERATING CONKITIONS.....	109
ANNEX D. USER MANUAL / BLOCK DIAGRAM / SCHEMATICS / PARTLIST.....	110
ANNEX E. DECLARATION OF SIMILARITY.....	111

1. Report Revision History

Report No.	Report Version	Description	Issue Date
17071091-FCC-R5	NONE	Original	November 08, 2017

2. Customer information

Applicant Name	TECNO MOBILE LIMITED
Applicant Add	ROOMS 05-15, 13A/F., SOUTH TOWER, WORLD FINANCE CENTRE, HARBOUR CITY, 17 CANTON ROAD, TSIM SHA TSUI, KOWLOON, HONG KONG
Manufacturer	SHENZHEN TECNO TECHNOLOGY CO.,LTD.
Manufacturer Add	1-4th Floor,3rd Building,Pacific Industrial Park,No.2088,Shenyan Road,Yantian District,Shenzhen,Guangdong,China

3. Test site information

Test Lab A:

Lab performing tests	SIEMIC (Shenzhen-China) LABORATORIES
Lab Address	Zone A, Floor 1, Building 2 Wan Ye Long Technology Park South Side of Zhoushi Road, Bao' an District, Shenzhen, Guangdong China 518108
FCC Test Site No.	535293
IC Test Site No.	4842E-1
Test Software	Radiated Emission Program-To Shenzhen v2.0

Test Lab B:

Lab performing tests	SIEMIC (Nanjing-China) Laboratories
Lab Address	2-1 Longcang Avenue Yuhua Economic and Technology Development Park, Nanjing, China
FCC Test Site No.	694825
IC Test Site No.	4842B-1
Test Software	EZ_EMG(ver.lcp-03A1)

Note: We just perform Radiated Spurious Emission above 18GHz in the test Lab. B.

4. Equipment under Test (EUT) Information

Description of EUT:	Mobile phone
Main Model:	K8
Serial Model:	N/A
Date EUT received:	October 17, 2017
Test Date(s):	October 17 to November 07, 2017
Equipment Category :	PCE
Antenna Gain:	GSM850: -0.2dBi PCS1900: 1.7dBi UMTS-FDD Band V: -0.2dBi UMTS-FDD Band IV: 1.7dBi UMTS-FDD Band II: 1.7dBi LTE Band II:1.7dBi LTE Band IV: 1.7dBi LTE Band VII:2.5dBi Bluetooth/BLE: 2.0dBi WIFI: 2.0dBi GPS:1.7dBi
Antenna Type:	PIFA antenna
Type of Modulation:	GSM / GPRS: GMSK EGPRS: GMSK,8PSK UMTS-FDD: QPSK LTE Band: QPSK, 16QAM 802.11b/g/n: DSSS, OFDM Bluetooth: GFSK, π /4DQPSK, 8DPSK BLE: GFSK GPS:BPSK

	GSM850 TX: 824.2 ~ 848.8 MHz; RX: 869.2 ~ 893.8 MHz
	PCS1900 TX: 1850.2 ~ 1909.8 MHz; RX: 1930.2 ~ 1989.8 MHz
	UMTS-FDD Band V TX: 826.4 ~ 846.6 MHz; RX: 871.4 ~ 891.6 MHz
	UMTS-FDD Band IV TX:1712.4 ~ 1752.6 MHz;
	RX : 2112.4 ~ 2152.6 MHz
	UMTS-FDD Band II TX:1852.4 ~ 1907.6 MHz;
	RX: 1932.4 ~ 1987.6 MHz
RF Operating Frequency (ies):	LTE Band II TX: 1850.7 ~ 1909.3MHz; RX : 1930.7 ~ 1989.3 MHz
	LTE Band IV TX: 1710.7 ~ 1754.3 MHz; RX : 2110.7~ 2154.3 MHz
	LTE Band VII TX: 2502.5 ~ 2567.5 MHz; RX : 2622.5 ~ 2687.5 MHz
	WIFI: 802.11b/g/n(20M): 2412-2462 MHz
	WIFI: 802.11n(40M): 2422-2452 MHz
	Bluetooth& BLE: 2402-2480 MHz
	GPS: 1575.42 MHz
Maximum Conducted AV Power to Antenna:	LTE band II: 23.04 dBm
	LTE band IV: 22.62dBm
	LTE band VII: 22.44 dBm
ERP/EIRP:	LTE band II: 20.18dBm / EIRP
	LTE band IV: 20.18dBm / EIRP
	LTE band VII: 19.94 dBm / EIRP
Port:	USB Port, Earphone Port
Number of Channels:	GSM 850: 124CH
	PCS1900: 299CH
	UMTS-FDD Band V: 102CH
	UMTS-FDD Band IV: 202CH
	UMTS-FDD Band II: 277CH
	WIFI :802.11b/g/n(20M): 11CH
	WIFI :802.11n(40M): 7CH
	Bluetooth: 79CH
	BLE: 40CH
	GPS:1CH

Input Power: Adapter:
Model: CU-52JT
Input: AC100-240V~50/60Hz,200mA
Output: DC 5.0V~1.2A
Battery:
Model: BL-30RT
Rating: 3.85V, 3000mAh, 11.55Wh
Limited charge voltage: 4.4V

Trade Name : TECNO

GPRS/EGPRS Multi-slot class 8/10/11/12

FCC ID: 2ADYY-K8

5. Test Summary

The product was tested in accordance with the following specifications.

All testing has been performed according to below product classification:

FCC Rules	Description of Test	Result
§ 1.1307; § 2.1093	RF Exposure (SAR)	Compliance
§2.1046; § 22.913(a); § 24.232(c); § 27.50(c.10); § 27.50(d.4)	RF Output Power	Compliance
§ 24.232 (d); § 27.50(d)	Peak-Average Ratio	Compliance
§ 2.1049; § 22.905; § 22.917; § 24.238; § 27.53(a.5)	99% & -26 dB Occupied Bandwidth	Compliance
§ 2.1051; § 22.917(a); § 24.238(a); § 27.53(h)	Spurious Emissions at Antenna Terminal	Compliance
§ 2.1053; § 22.917(a); § 24.238(a); § 27.53(h)	Field Strength of Spurious Radiation	Compliance
§ 22.917(a); § 24.238(a);	Out of band emission, Band Edge	Compliance
§ 27.53(m)	Band Edge 27.53(m)	Compliance
§ 2.1055; § 22.355; § 24.235; § 27.5(h); § 27.54	Frequency stability vs. temperature Frequency stability vs. voltage	Compliance

Note: Testing was performed by configuring EUT to maximum output power status, the declared output power class for different

Measurement Uncertainty

Emissions		
Test Item	Description	Uncertainty
Band Edge and Radiated Spurious Emissions	Confidence level of approximately 95% (in the case where distributions are normal), with a coverage factor of 2 (for EUTs < 0.5m X 0.5m X 0.5m)	+5.6dB/-4.5dB
-	-	-

6. MEASUREMENTS, EXAMINATION AND DERIVED RESULTS

6.1 RF Exposure (SAR)

Test Result: Pass

The EUT is a portable device, thus requires SAR evaluation;

Please refer to RF Exposure Evaluation Report: 17071091-FCC-H.

6.2 RF Output Power

Temperature	25°C
Relative Humidity	57%
Atmospheric Pressure	1023mbar
Test date :	October 27, 2017
Tested By :	Loren Luo

Requirement(s):

Spec	Item	Requirement	Applicable
§22.913 (a)	a)	ERP:38.45dBm	<input checked="" type="checkbox"/>
§24.232 (c)	b)	EIRP:33dBm	<input checked="" type="checkbox"/>
§27.50 (c)	c)	EIRP: 30dBm	<input checked="" type="checkbox"/>

Test Setup

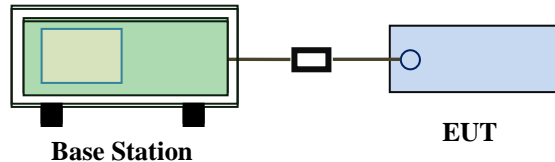

Test Procedure

For Conducted Power:

- The transmitter output port was connected to base station.
- Set EUT at maximum power through base station.
- Select lowest, middle, and highest channels for each band and different test mode.

For ERP/EIRP:

- The transmitter was placed on a wooden turntable, and it was transmitting into a non-radiating load which was also placed on the turntable.
- The measurement antenna was placed at a distance of 3 meters from the EUT. During the tests, the antenna height and polarization as well as EUT azimuth were varied in order to identify the maximum level of emissions from the EUT. The test was performed by placing the EUT on 3-orthogonal axis.
- The frequency range up to tenth harmonic of the fundamental frequency was investigated.

	<ul style="list-style-type: none"> - Remove the EUT and replace it with substitution antenna. A signal generator was connected to the substitution antenna by a non-radiating cable. The absolute levels of the spurious emissions were measured by the substitution. - Spurious emissions in dB = 10 log (TX power in Watts/0.001) – the absolute level - Spurious attenuation limit in dB = 43 + 10 Log10 (power out in Watts).
Remark	
Result	<input checked="" type="checkbox"/> Pass <input type="checkbox"/> Fail

Test Data Yes N/A
 Test Plot Yes (See below) N/A

Conducted Power

LTE Band II:

BW (MHz)	Ch	Freq. (MHz)	Mode	UL RB Allocation	UL RB Offset	MPR	Average power (dBm)	Tune up Power tolerant
20MHz	18700	1860.0	QPSK	1	0	0	22.45	22 ± 1
				1	49	0	22.47	22 ± 1
				1	99	0	22.37	22 ± 1
				50	0	1	22.51	22 ± 1
				50	24	1	22.51	22 ± 1
				50	49	1	22.48	22 ± 1
			100	0	1	22.55	22 ± 1	
			16QAM	1	0	1	21.39	21.5 ± 1
			1	49	1	21.48	21.5 ± 1	
			1	99	1	21.29	21.5 ± 1	
			50	0	2	21.30	21.5 ± 1	
			50	24	2	21.49	21.5 ± 1	
	50	49	2	21.47	21.5 ± 1			
	100	0	2	21.29	21.5 ± 1			
	18900	1880.0	QPSK	1	0	0	22.55	22 ± 1
				1	49	0	22.61	22 ± 1
				1	99	0	22.62	22 ± 1
				50	0	1	22.46	22 ± 1
				50	24	1	22.36	22 ± 1
				50	49	1	22.42	22 ± 1
			100	0	1	22.43	22 ± 1	
			16QAM	1	0	1	21.43	21.5 ± 1
			1	49	1	21.49	21.5 ± 1	
			1	99	1	21.35	21.5 ± 1	
50			0	2	21.36	21.5 ± 1		
50			24	2	21.42	21.5 ± 1		
50	49	2	21.37	21.5 ± 1				
100	0	2	21.37	21.5 ± 1				
19100	1900.0	QPSK	1	0	0	22.38	22 ± 1	
			1	49	0	22.41	22 ± 1	
			1	99	0	22.44	22 ± 1	
			50	0	1	22.33	22 ± 1	
			50	24	1	22.33	22 ± 1	
			50	49	1	22.29	22 ± 1	
		100	0	1	22.40	22 ± 1		
		16QAM	1	0	1	21.36	21.5 ± 1	
		1	49	1	21.45	21.5 ± 1		
		1	99	1	21.27	21.5 ± 1		
		50	0	2	21.38	21.5 ± 1		
		50	24	2	21.39	21.5 ± 1		
50	49	2	21.31	21.5 ± 1				
100	0	2	21.42	21.5 ± 1				

BW (MHz)	Ch	Freq. (MHz)	Mode	UL RB Allocation	UL RB Offset	MPR	Average power (dBm)	Tune up Power tolerant
15MHz	18675	1857.5	QPSK	1	0	0	22.46	22 ± 1
				1	37	0	22.51	22 ± 1
				1	74	0	22.40	22 ± 1
				36	0	1	22.37	22 ± 1
				36	16	1	22.30	22 ± 1
				36	35	1	22.35	22 ± 1
				75	0	1	22.51	22 ± 1
			16QAM	1	0	1	21.39	21.3 ± 1
				1	37	1	21.38	21.3 ± 1
				1	74	1	21.48	21.3 ± 1
				36	0	2	21.48	21.3 ± 1
				36	16	2	21.49	21.3 ± 1
				36	35	2	21.42	21.3 ± 1
				75	0	2	21.37	21.3 ± 1
	18900	1880.0	QPSK	1	0	0	22.49	22 ± 1
				1	37	0	22.53	22 ± 1
				1	74	0	22.44	22 ± 1
				36	0	1	22.66	22 ± 1
				36	16	1	22.69	22 ± 1
				36	35	1	22.57	22 ± 1
				75	0	1	22.65	22 ± 1
			16QAM	1	0	1	21.36	21.5 ± 1
				1	37	1	21.36	21.5 ± 1
				1	74	1	21.37	21.5 ± 1
				36	0	2	21.38	21.5 ± 1
				36	16	2	21.26	21.5 ± 1
				36	35	2	21.29	21.5 ± 1
				75	0	2	21.59	21.5 ± 1
	19125	1902.5	QPSK	1	0	0	22.32	22 ± 1
				1	37	0	22.26	22 ± 1
1				74	0	22.39	22 ± 1	
36				0	1	22.42	22 ± 1	
36				16	1	22.35	22 ± 1	
36				35	1	22.47	22 ± 1	
75				0	1	22.48	22 ± 1	
16QAM			1	0	1	21.26	21.5 ± 1	
			1	37	1	21.20	21.5 ± 1	
			1	74	1	21.36	21.5 ± 1	
			36	0	2	21.26	21.5 ± 1	
			36	16	2	21.34	21.5 ± 1	
			36	35	2	21.19	21.5 ± 1	
			75	0	2	21.35	21.5 ± 1	

BW (MHz)	Ch	Freq. (MHz)	Mode	UL RB Allocation	UL RB Offset	MPR	Average power (dBm)	Tune up Power tolerant
10MHz	18650	1855	QPSK	1	0	0	22.75	22.5 ± 1
				1	24	0	22.69	22.5 ± 1
				1	49	0	22.67	22.5 ± 1
				25	0	1	21.93	22.5 ± 1
				25	12	1	21.87	22.5 ± 1
				25	24	1	21.96	22.5 ± 1
				50	0	1	21.85	22.5 ± 1
			16QAM	1	0	1	21.62	21.5 ± 1
				1	24	1	21.52	21.5 ± 1
				1	49	1	21.66	21.5 ± 1
				25	0	2	21.65	21.5 ± 1
				25	12	2	21.60	21.5 ± 1
				25	24	2	21.70	21.5 ± 1
				50	0	2	20.84	21.5 ± 1
	18900	1880.0	QPSK	1	0	0	21.84	22 ± 1
				1	24	0	21.82	22 ± 1
				1	49	0	21.84	22 ± 1
				25	0	1	21.02	22 ± 1
				25	12	1	21.02	22 ± 1
				25	24	1	21.00	22 ± 1
				50	0	1	21.10	22 ± 1
			16QAM	1	0	1	20.80	21.3 ± 1
				1	24	1	20.90	21.3 ± 1
				1	49	1	20.86	21.3 ± 1
				25	0	2	20.85	21.3 ± 1
				25	12	2	20.87	21.3 ± 1
				25	24	2	20.85	21.3 ± 1
				50	0	2	20.36	21.3 ± 1
	19150	1905	QPSK	1	0	0	21.87	22 ± 1
				1	24	0	21.82	22 ± 1
1				49	0	21.96	22 ± 1	
25				0	1	21.06	22 ± 1	
25				12	1	21.03	22 ± 1	
25				24	1	21.03	22 ± 1	
50				0	1	21.87	22 ± 1	
16QAM			1	0	1	21.52	21.5 ± 1	
			1	24	1	21.62	21.5 ± 1	
			1	49	1	21.56	21.5 ± 1	
			25	0	2	21.44	21.5 ± 1	
			25	12	2	21.44	21.5 ± 1	
			25	24	2	21.45	21.5 ± 1	
			50	0	2	20.91	21.5 ± 1	

BW (MHz)	Ch	Freq. (MHz)	Mode	UL RB Allocation	UL RB Offset	MPR	Average power (dBm)	Tune up Power tolerant
5MHz	18625	1852.5	QPSK	1	0	0	22.89	22.5 ± 1
				1	12	0	22.79	22.5 ± 1
				1	24	0	22.87	22.5 ± 1
				12	0	1	21.91	22.5 ± 1
				12	6	1	21.89	22.5 ± 1
				12	11	1	21.86	22.5 ± 1
				25	0	1	21.90	22.5 ± 1
			16QAM	1	0	1	22.39	21.5 ± 1
				1	12	1	22.30	21.5 ± 1
				1	24	1	22.41	21.5 ± 1
				12	0	2	22.48	21.5 ± 1
				12	6	2	22.46	21.5 ± 1
				12	11	2	22.48	21.5 ± 1
				25	0	2	20.86	21.5 ± 1
	18900	1880.0	QPSK	1	0	0	22.30	21.5 ± 1
				1	12	0	22.34	21.5 ± 1
				1	24	0	22.34	21.5 ± 1
				12	0	1	21.13	21.5 ± 1
				12	6	1	21.09	21.5 ± 1
				12	11	1	21.20	21.5 ± 1
				25	0	1	21.15	21.5 ± 1
			16QAM	1	0	1	21.40	21.3 ± 1
				1	12	1	21.48	21.3 ± 1
				1	24	1	21.39	21.3 ± 1
				12	0	2	21.33	21.3 ± 1
				12	6	2	21.34	21.3 ± 1
				12	11	2	21.31	21.3 ± 1
25				0	2	20.34	21.3 ± 1	
19175	1907.5	QPSK	1	0	0	21.94	21.5 ± 1	
			1	12	0	21.92	21.5 ± 1	
			1	24	0	22.02	21.5 ± 1	
			12	0	1	20.79	21.5 ± 1	
			12	6	1	20.82	21.5 ± 1	
			12	11	1	20.80	21.5 ± 1	
			25	0	1	21.62	21.5 ± 1	
		16QAM	1	0	1	21.05	21.3 ± 1	
			1	12	1	20.97	21.3 ± 1	
			1	24	1	21.13	21.3 ± 1	
			12	0	2	21.01	21.3 ± 1	
			12	6	2	21.14	21.3 ± 1	
			12	11	2	21.02	21.3 ± 1	
			25	0	2	20.39	21.3 ± 1	

BW (MHz)	Ch	Freq. (MHz)	Mode	UL RB Allocation	UL RB Offset	MPR	Average power (dBm)	Tune up Power tolerant
3MHz	18625	1852.5	QPSK	1	0	0	22.98	22.5 ± 1
				1	7	0	23.04	22.5 ± 1
				1	14	0	22.90	22.5 ± 1
				8	0	1	21.96	22.5 ± 1
				8	4	1	22.04	22.5 ± 1
				8	7	1	21.86	22.5 ± 1
				15	0	1	21.93	22.5 ± 1
			16QAM	1	0	1	21.73	21.5 ± 1
				1	7	1	21.78	21.5 ± 1
				1	14	1	21.77	21.5 ± 1
				8	0	2	20.85	21.5 ± 1
				8	4	2	20.93	21.5 ± 1
				8	7	2	20.77	21.5 ± 1
				15	0	2	20.84	21.5 ± 1
	18900	1880.0	QPSK	1	0	0	22.46	21.5 ± 1
				1	7	0	20.93	21.5 ± 1
				1	14	0	22.47	21.5 ± 1
				8	0	1	21.47	21.5 ± 1
				8	4	1	21.55	21.5 ± 1
				8	7	1	21.52	21.5 ± 1
				15	0	1	21.54	21.5 ± 1
			16QAM	1	0	1	21.43	21.5 ± 1
				1	7	1	21.46	21.5 ± 1
				1	14	1	21.50	21.5 ± 1
				8	0	2	20.35	21.5 ± 1
				8	4	2	20.39	21.5 ± 1
				8	7	2	20.30	21.5 ± 1
				15	0	2	20.57	21.5 ± 1
	19175	1907.5	QPSK	1	0	0	21.50	22 ± 1
				1	7	0	21.54	22 ± 1
1				14	0	21.59	22 ± 1	
8				0	1	21.82	22 ± 1	
8				4	1	21.81	22 ± 1	
8				7	1	21.88	22 ± 1	
15				0	1	21.78	22 ± 1	
16QAM			1	0	1	21.11	21.3 ± 1	
			1	7	1	21.20	21.3 ± 1	
			1	14	1	21.19	21.3 ± 1	
			8	0	2	20.44	21.3 ± 1	
			8	4	2	20.43	21.3 ± 1	
			8	7	2	20.39	21.3 ± 1	
			15	0	2	20.65	21.3 ± 1	

BW (MHz)	Ch	Freq. (MHz)	Mode	UL RB Allocation	UL RB Offset	MPR	Average power (dBm)	Tune up Power tolerant
1.4MHz	18607	1850.7	QPSK	1	0	0	22.47	22 ± 1
				1	2	0	22.52	22 ± 1
				1	5	0	22.52	22 ± 1
				3	0	0	22.45	22 ± 1
				3	1	0	22.51	22 ± 1
				3	2	0	22.37	22 ± 1
			6	0	1	21.44	22 ± 1	
			16QAM	1	0	1	21.21	21.3 ± 1
				1	2	1	21.12	21.3 ± 1
				1	5	1	21.23	21.3 ± 1
				3	0	1	21.17	21.3 ± 1
				3	1	1	21.31	21.3 ± 1
	3	2		1	21.11	21.3 ± 1		
	6	0	2	20.36	21.3 ± 1			
	18900	1880.0	QPSK	1	0	0	21.91	22 ± 1
				1	2	0	21.92	22 ± 1
				1	5	0	21.82	22 ± 1
				3	0	0	21.86	22 ± 1
				3	1	0	21.86	22 ± 1
				3	2	0	21.94	22 ± 1
			6	0	1	21.90	22 ± 1	
			16QAM	1	0	1	20.91	21.5 ± 1
				1	2	1	20.83	21.5 ± 1
				1	5	1	20.94	21.5 ± 1
3				0	1	21.01	21.5 ± 1	
3				1	1	20.82	21.5 ± 1	
3	2	1		20.84	21.5 ± 1			
6	0	2	20.96	21.5 ± 1				
19193	1909.3	QPSK	1	0	0	22.06	22 ± 1	
			1	2	0	22.01	22 ± 1	
			1	5	0	22.14	22 ± 1	
			3	0	0	22.14	22 ± 1	
			3	1	0	22.04	22 ± 1	
			3	2	0	22.19	22 ± 1	
		6	0	1	21.41	22 ± 1		
		16QAM	1	0	1	21.08	21.5 ± 1	
			1	2	1	21.08	21.5 ± 1	
			1	5	1	21.06	21.5 ± 1	
			3	0	1	21.10	21.5 ± 1	
			3	1	1	21.16	21.5 ± 1	
3	2		1	21.02	21.5 ± 1			
6	0	2	20.53	21.5 ± 1				

LTE band IV:

BW (MHz)	Ch	Freq. (MHz)	Mode	UL RB Allocation	UL RB Offset	MPR	Average power (dBm)	Tune up Power tolerant
20MHz	20050	1720.0	QPSK	1	0	0	22.21	22±1
				1	49	0	22.25	22±1
				1	99	0	22.23	22±1
				50	0	1	22.19	22±1
				50	24	1	22.21	22±1
				50	49	1	22.29	22±1
				100	0	1	21.88	22±1
			16QAM	1	0	1	21.38	21.3±1
				1	49	1	21.39	21.3±1
				1	99	1	21.40	21.3±1
				50	0	2	21.40	21.3±1
				50	24	2	21.35	21.3±1
				50	49	2	21.39	21.3±1
				100	0	2	20.68	21.3±1
	20175	1732.5	QPSK	1	0	0	22.32	22±1
				1	49	0	22.33	22±1
				1	99	0	22.34	22±1
				50	0	1	22.25	22±1
				50	24	1	22.34	22±1
				50	49	1	22.22	22±1
				100	0	1	22.41	22±1
			16QAM	1	0	1	21.18	22±1
				1	49	1	21.20	22±1
				1	99	1	21.15	22±1
				50	0	2	21.09	22±1
				50	24	2	21.16	22±1
				50	49	2	21.11	22±1
				100	0	2	21.36	22±1
	20300	1745.0	QPSK	1	0	0	22.28	22±1
				1	49	0	22.25	22±1
1				99	0	22.18	22±1	
50				0	1	22.23	22±1	
50				24	1	22.27	22±1	
50				49	1	22.32	22±1	
100				0	1	22.26	22±1	
16QAM			1	0	1	21.25	21.5±1	
			1	49	1	21.35	21.5±1	
			1	99	1	21.22	21.5±1	
			50	0	2	21.15	21.5±1	
			50	24	2	21.27	21.5±1	
			50	49	2	21.25	21.5±1	
			100	0	2	21.28	21.5±1	

BW (MHz)	Ch	Freq. (MHz)	Mode	UL RB Allocation	UL RB Offset	MPR	Average power (dBm)	Tune up Power tolerant
15MHz	20025	1717.5	QPSK	1	0	0	22.24	22.3 ± 1
				1	37	0	22.24	22.3 ± 1
				1	74	0	22.27	22.3 ± 1
				36	0	1	21.25	22.3 ± 1
				36	16	1	21.33	22.3 ± 1
				36	35	1	21.35	22.3 ± 1
				75	0	1	22.31	22.3 ± 1
			16QAM	1	0	1	21.12	21.5 ± 1
				1	37	1	21.10	21.5 ± 1
				1	74	1	21.10	21.5 ± 1
				36	0	2	21.16	21.5 ± 1
				36	16	2	21.14	21.5 ± 1
				36	35	2	21.04	21.5 ± 1
				75	0	2	21.29	21.5 ± 1
	20175	1732.5	QPSK	1	0	0	22.19	22 ± 1
				1	37	0	22.15	22 ± 1
				1	74	0	22.28	22 ± 1
				36	0	1	22.18	22 ± 1
				36	16	1	22.09	22 ± 1
				36	35	1	22.15	22 ± 1
				75	0	1	21.86	22 ± 1
			16QAM	1	0	1	21.32	21.5 ± 1
				1	37	1	21.29	21.5 ± 1
				1	74	1	21.25	21.5 ± 1
				36	0	2	21.25	21.5 ± 1
				36	16	2	21.30	21.5 ± 1
				36	35	2	21.22	21.5 ± 1
				75	0	2	20.66	21.5 ± 1
	20325	1747.5	QPSK	1	0	0	22.23	22 ± 1
				1	37	0	22.15	22 ± 1
1				74	0	22.23	22 ± 1	
36				0	1	21.45	22 ± 1	
36				16	1	21.49	22 ± 1	
36				35	1	21.53	22 ± 1	
75				0	1	22.18	22 ± 1	
16QAM			1	0	1	21.45	21.5 ± 1	
			1	37	1	21.42	21.5 ± 1	
			1	74	1	21.42	21.5 ± 1	
			36	0	2	21.39	21.5 ± 1	
			36	16	2	21.45	21.5 ± 1	
			36	35	2	21.46	21.5 ± 1	
			75	0	2	21.36	21.5 ± 1	

BW (MHz)	Ch	Freq. (MHz)	Mode	UL RB Allocation	UL RB Offset	MPR	Average power (dBm)	Tune up Power tolerant
10MHz	20000	1715.0	QPSK	1	0	0	22.25	22 ± 1
				1	24	0	22.16	22 ± 1
				1	49	0	22.25	22 ± 1
				25	0	1	21.26	22 ± 1
				25	12	1	21.17	22 ± 1
				25	24	1	21.20	22 ± 1
			50	0	1	21.26	22 ± 1	
			16QAM	1	0	1	21.10	21.3 ± 1
				1	24	1	21.14	21.3 ± 1
				1	49	1	21.17	21.3 ± 1
				25	0	2	21.04	21.3 ± 1
				25	12	2	21.19	21.3 ± 1
	25	24		2	21.14	21.3 ± 1		
	20175	1732.5	QPSK	1	0	0	22.47	22 ± 1
				1	24	0	22.51	22 ± 1
				1	49	0	22.47	22 ± 1
				25	0	1	21.45	22 ± 1
				25	12	1	21.35	22 ± 1
				25	24	1	21.53	22 ± 1
			50	0	1	21.41	22 ± 1	
			16QAM	1	0	1	21.42	21.5 ± 1
				1	24	1	21.52	21.5 ± 1
				1	49	1	21.49	21.5 ± 1
				25	0	2	21.36	21.5 ± 1
25				12	2	21.45	21.5 ± 1	
25	24	2		21.43	21.5 ± 1			
20350	1750.0	QPSK	1	0	0	22.08	22 ± 1	
			1	24	0	22.14	22 ± 1	
			1	49	0	22.14	22 ± 1	
			25	0	1	21.35	22 ± 1	
			25	12	1	21.44	22 ± 1	
			25	24	1	21.29	22 ± 1	
		50	0	1	21.42	22 ± 1		
		16QAM	1	0	1	21.66	21.5 ± 1	
			1	24	1	21.58	21.5 ± 1	
			1	49	1	21.69	21.5 ± 1	
			25	0	2	21.70	21.5 ± 1	
			25	12	2	21.60	21.5 ± 1	
25	24		2	21.67	21.5 ± 1			
50	0	2	20.52	21.5 ± 1				

BW (MHz)	Ch	Freq. (MHz)	Mode	UL RB Allocation	UL RB Offset	MPR	Average power (dBm)	Tune up Power tolerant
5MHz	20000	1715.0	QPSK	1	0	0	22.16	22 ± 1
				1	12	0	22.20	22 ± 1
				1	24	0	22.22	22 ± 1
				12	0	1	21.24	22 ± 1
				12	6	1	21.14	22 ± 1
				12	11	1	21.30	22 ± 1
				25	0	1	21.23	22 ± 1
			16QAM	1	0	1	21.59	21.5 ± 1
				1	12	1	21.63	21.5 ± 1
				1	24	1	21.65	21.5 ± 1
				12	0	2	21.53	21.5 ± 1
				12	6	2	21.57	21.5 ± 1
				12	11	2	21.58	21.5 ± 1
				25	0	2	20.35	21.5 ± 1
	20175	1732.5	QPSK	1	0	0	22.39	22 ± 1
				1	12	0	22.42	22 ± 1
				1	24	0	22.31	22 ± 1
				12	0	1	21.46	22 ± 1
				12	6	1	21.39	22 ± 1
				12	11	1	21.39	22 ± 1
				25	0	1	21.39	22 ± 1
			16QAM	1	0	1	21.38	21.3 ± 1
				1	12	1	21.36	21.3 ± 1
				1	24	1	21.46	21.3 ± 1
				12	0	2	21.42	21.3 ± 1
				12	6	2	21.37	21.3 ± 1
				12	11	2	21.46	21.3 ± 1
				25	0	2	20.50	21.3 ± 1
20350	1750.0	QPSK	1	0	0	22.58	22 ± 1	
			1	12	0	22.60	22 ± 1	
			1	24	0	22.49	22 ± 1	
			12	0	1	21.65	22 ± 1	
			12	6	1	21.59	22 ± 1	
			12	11	1	21.59	22 ± 1	
			25	0	1	21.58	22 ± 1	
		16QAM	1	0	1	21.56	21.5 ± 1	
			1	12	1	21.62	21.5 ± 1	
			1	24	1	21.49	21.5 ± 1	
			12	0	2	21.52	21.5 ± 1	
			12	6	2	21.64	21.5 ± 1	
			12	11	2	21.63	21.5 ± 1	
			25	0	2	20.68	21.5 ± 1	

BW (MHz)	Ch	Freq. (MHz)	Mode	UL RB Allocation	UL RB Offset	MPR	Average power (dBm)	Tune up Power tolerant
3MHz	19965	1711.5	QPSK	1	0	0	22.27	22±1
				1	7	0	22.24	22±1
				1	14	0	22.29	22±1
				8	0	1	21.23	22±1
				8	4	1	21.33	22±1
				8	7	1	21.27	22±1
				15	0	1	22.32	22±1
			16QAM	1	0	1	21.07	21.3±1
				1	7	1	21.07	21.3±1
				1	14	1	21.00	21.3±1
				8	0	2	20.37	21.3±1
				8	4	2	20.32	21.3±1
				8	7	2	20.37	21.3±1
				15	0	2	21.29	21.3±1
	20175	1732.5	QPSK	1	0	0	22.29	21.3±1
				1	7	0	20.32	21.3±1
				1	14	0	22.36	21.3±1
				8	0	1	21.88	21.3±1
				8	4	1	21.83	21.3±1
				8	7	1	21.88	21.3±1
				15	0	1	21.65	21.3±1
			16QAM	1	0	1	21.19	21.5±1
				1	7	1	21.29	21.5±1
				1	14	1	21.16	21.5±1
				8	0	2	20.83	21.5±1
				8	4	2	20.83	21.5±1
				8	7	2	20.91	21.5±1
				15	0	2	20.57	21.5±1
	20385	1753.5	QPSK	1	0	0	22.32	22±1
				1	7	0	22.37	22±1
1				14	0	22.38	22±1	
8				0	1	21.65	22±1	
8				4	1	21.63	22±1	
8				7	1	21.67	22±1	
15				0	1	22.13	22±1	
16QAM			1	0	1	21.23	21.3±1	
			1	7	1	21.16	21.3±1	
			1	14	1	21.32	21.3±1	
			8	0	2	20.56	21.3±1	
			8	4	2	20.46	21.3±1	
			8	7	2	20.61	21.3±1	
			15	0	2	21.28	21.3±1	

BW (MHz)	Ch	Freq. (MHz)	Mode	UL RB Allocation	UL RB Offset	MPR	Average power (dBm)	Tune up Power tolerant
1.4MHz	19957	1710.7	QPSK	1	0	0	22.29	22 ± 1
				1	2	0	22.29	22 ± 1
				1	5	0	22.20	22 ± 1
				3	0	0	22.37	22 ± 1
				3	1	0	22.34	22 ± 1
				3	2	0	22.45	22 ± 1
			6	0	1	21.27	22 ± 1	
			16QAM	1	0	1	21.09	21.3 ± 1
				1	2	1	21.08	21.3 ± 1
				1	5	1	21.09	21.3 ± 1
				3	0	1	20.99	21.3 ± 1
				3	1	1	21.16	21.3 ± 1
	3	2		1	21.16	21.3 ± 1		
	20175	1732.5	QPSK	1	0	0	22.51	22.3 ± 1
				1	2	0	22.47	22 ± 1
				1	5	0	22.43	22 ± 1
				3	0	0	22.44	22 ± 1
				3	1	0	22.50	22 ± 1
				3	2	0	22.43	22 ± 1
			6	0	1	21.45	22 ± 1	
			16QAM	1	0	1	21.37	21.3 ± 1
				1	2	1	21.32	21.3 ± 1
				1	5	1	21.35	21.3 ± 1
				3	0	1	21.46	21.3 ± 1
3				1	1	21.45	21.3 ± 1	
3	2	1		21.41	21.3 ± 1			
20393	1754.3	QPSK	1	0	0	22.52	22 ± 1	
			1	2	0	22.44	22 ± 1	
			1	5	0	22.51	22 ± 1	
			3	0	0	22.60	22 ± 1	
			3	1	0	22.58	22 ± 1	
			3	2	0	22.62	22 ± 1	
		6	0	1	21.59	22 ± 1		
		16QAM	1	0	1	21.19	21.3 ± 1	
			1	2	1	21.14	21.3 ± 1	
			1	5	1	21.18	21.3 ± 1	
			3	0	1	21.12	21.3 ± 1	
			3	1	1	21.18	21.3 ± 1	
3	2		1	21.16	21.3 ± 1			
6	0	2	20.47	21.3 ± 1				

LTE band VII:

BW (MHz)	Ch	Freq. (MHz)	Mode	UL RB Allocation	UL RB Offset	MPR	Average power (dBm)	Tune up Power tolerant
20MHz	20850	2510	QPSK	1	0	0	22.23	22±1
				1	49	0	22.13	22±1
				1	99	0	22.15	22±1
				50	0	1	21.63	22±1
				50	24	1	21.73	22±1
				50	49	1	21.65	22±1
				100	0	1	22.03	22±1
			16QAM	1	0	1	21.25	21.5±1
				1	49	1	21.32	21.5±1
				1	99	1	21.26	21.5±1
				50	0	2	21.19	21.5±1
				50	24	2	21.16	21.5±1
				50	49	2	21.24	21.5±1
				100	0	2	21.80	21.5±1
	21100	2535	QPSK	1	0	0	22.16	22±1
				1	49	0	22.09	22±1
				1	99	0	22.15	22±1
				50	0	1	21.82	22±1
				50	24	1	21.89	22±1
				50	49	1	21.80	22±1
				100	0	1	22.05	22±1
			16QAM	1	0	1	21.15	21.3±1
				1	49	1	21.14	21.3±1
				1	99	1	21.15	21.3±1
				50	0	2	21.21	21.3±1
				50	24	2	21.17	21.3±1
				50	49	2	21.07	21.3±1
				100	0	2	21.42	21.3±1
	21350	2560	QPSK	1	0	0	22.13	22±1
				1	49	0	22.19	22±1
1				99	0	22.18	22±1	
50				0	1	21.73	22±1	
50				24	1	21.82	22±1	
50				49	1	21.75	22±1	
100				0	1	22.12	22±1	
16QAM			1	0	1	21.21	21.3±1	
			1	49	1	21.23	21.3±1	
			1	99	1	21.28	21.3±1	
			50	0	2	21.24	21.3±1	
			50	24	2	21.22	21.3±1	
			50	49	2	21.12	21.3±1	
			100	0	2	21.38	21.3±1	

BW (MHz)	Ch	Freq. (MHz)	Mode	UL RB Allocation	UL RB Offset	MPR	Average power (dBm)	Tune up Power tolerant
15MHz	20825	1717.5	QPSK	1	0	0	22.28	22 ± 1
				1	37	0	22.18	22 ± 1
				1	74	0	22.21	22 ± 1
				36	0	1	21.20	22 ± 1
				36	16	1	21.26	22 ± 1
				36	35	1	21.25	22 ± 1
				75	0	1	21.98	22 ± 1
			16QAM	1	0	1	21.39	21.5 ± 1
				1	37	1	21.40	21.5 ± 1
				1	74	1	21.35	21.5 ± 1
				36	0	2	21.30	21.5 ± 1
				36	16	2	21.37	21.5 ± 1
				36	35	2	21.47	21.5 ± 1
				75	0	2	20.87	21.5 ± 1
	21100	1732.5	QPSK	1	0	0	22.36	22 ± 1
				1	37	0	22.39	22 ± 1
				1	74	0	22.44	22 ± 1
				36	0	1	21.86	22 ± 1
				36	16	1	21.77	22 ± 1
				36	35	1	21.95	22 ± 1
				75	0	1	22.01	22 ± 1
			16QAM	1	0	1	21.28	21.5 ± 1
				1	37	1	21.21	21.5 ± 1
				1	74	1	21.26	21.5 ± 1
				36	0	2	21.28	21.5 ± 1
				36	16	2	21.32	21.5 ± 1
				36	35	2	21.31	21.5 ± 1
				75	0	2	21.75	21.5 ± 1
21375	1747.5	QPSK	1	0	0	22.11	22 ± 1	
			1	37	0	22.08	22 ± 1	
			1	74	0	22.03	22 ± 1	
			36	0	1	21.67	22 ± 1	
			36	16	1	21.73	22 ± 1	
			36	35	1	21.65	22 ± 1	
			75	0	1	22.10	22 ± 1	
		16QAM	1	0	1	21.21	21.5 ± 1	
			1	37	1	21.23	21.5 ± 1	
			1	74	1	21.26	21.5 ± 1	
			36	0	2	21.14	21.5 ± 1	
			36	16	2	21.31	21.5 ± 1	
			36	35	2	21.29	21.5 ± 1	
			75	0	2	21.18	21.5 ± 1	

BW (MHz)	Ch	Freq. (MHz)	Mode	UL RB Allocation	UL RB Offset	MPR	Average power (dBm)	Tune up Power tolerant
10MHz	20800	2502	QPSK	1	0	0	21.85	21.5±1
				1	24	0	21.84	21.5±1
				1	49	0	21.88	21.5±1
				25	0	1	21.26	21.5±1
				25	12	1	21.33	21.5±1
				25	24	1	21.19	21.5±1
				50	0	1	20.95	21.5±1
			16QAM	1	0	1	20.84	21.3±1
				1	24	1	20.85	21.3±1
				1	49	1	20.89	21.3±1
				25	0	2	20.85	21.3±1
				25	12	2	20.79	21.3±1
				25	24	2	20.90	21.3±1
				50	0	2	20.36	21.3±1
	21100	2535	QPSK	1	0	0	21.99	22±1
				1	24	0	22.00	22±1
				1	49	0	21.91	22±1
				25	0	1	21.33	22±1
				25	12	1	21.40	22±1
				25	24	1	21.42	22±1
				50	0	1	21.27	22±1
			16QAM	1	0	1	20.98	21.3±1
				1	24	1	21.02	21.3±1
				1	49	1	20.95	21.3±1
				25	0	2	21.03	21.3±1
				25	12	2	21.00	21.3±1
				25	24	2	20.90	21.3±1
				50	0	2	20.40	21.3±1
	21400	2565	QPSK	1	0	0	21.64	22±1
				1	24	0	21.57	22±1
1				49	0	21.64	22±1	
25				0	1	21.52	22±1	
25				12	1	21.47	22±1	
25				24	1	21.55	22±1	
50				0	1	21.66	22±1	
16QAM			1	0	1	20.36	21.3±1	
			1	24	1	20.27	21.3±1	
			1	49	1	20.45	21.3±1	
			25	0	2	20.26	21.3±1	
			25	12	2	20.26	21.3±1	
			25	24	2	20.36	21.3±1	
			50	0	2	20.78	21.3±1	

BW (MHz)	Ch	Freq. (MHz)	Mode	UL RB Allocation	UL RB Offset	MPR	Average power (dBm)	Tune up Power tolerant
5MHz	19975	1712.5	QPSK	1	0	0	22.02	22 ± 1
				1	12	0	22.01	22 ± 1
				1	24	0	21.99	22 ± 1
				12	0	1	21.38	22 ± 1
				12	6	1	21.35	22 ± 1
				12	11	1	21.41	22 ± 1
				25	0	1	21.22	22 ± 1
			16QAM	1	0	1	21.64	21.5 ± 1
				1	12	1	21.74	21.5 ± 1
				1	24	1	21.58	21.5 ± 1
				12	0	2	21.59	21.5 ± 1
				12	6	2	21.66	21.5 ± 1
				12	11	2	21.61	21.5 ± 1
				25	0	2	20.52	21.5 ± 1
	20175	1732.5	QPSK	1	0	0	22.40	22 ± 1
				1	12	0	22.38	22 ± 1
				1	24	0	22.40	22 ± 1
				12	0	1	21.39	22 ± 1
				12	6	1	21.45	22 ± 1
				12	11	1	21.41	22 ± 1
				25	0	1	21.30	22 ± 1
			16QAM	1	0	1	21.33	21.3 ± 1
				1	12	1	21.23	21.3 ± 1
				1	24	1	21.42	21.3 ± 1
				12	0	2	21.33	21.3 ± 1
				12	6	2	21.28	21.3 ± 1
				12	11	2	21.34	21.3 ± 1
				25	0	2	20.40	21.3 ± 1
	20375	1752.5	QPSK	1	0	0	21.76	21.5 ± 1
				1	12	0	21.78	21.5 ± 1
1				24	0	21.69	21.5 ± 1	
12				0	1	20.72	21.5 ± 1	
12				6	1	20.78	21.5 ± 1	
12				11	1	20.74	21.5 ± 1	
25				0	1	21.60	21.5 ± 1	
16QAM			1	0	1	20.58	21.5 ± 1	
			1	12	1	20.63	21.5 ± 1	
			1	24	1	20.57	21.5 ± 1	
			12	0	2	20.54	21.5 ± 1	
			12	6	2	20.65	21.5 ± 1	
			12	11	2	20.57	21.5 ± 1	
			25	0	2	20.52	21.5 ± 1	

ERP & EIRP

EIRP for LTE Band II (Part 24E)

Frequency (MHz)	BW (MHz)	Modulation	RB Size/Offset	Substituted level (dBm)	Antenna Polarization	Antenna Gain correction (dBi)	Cable Loss (dB)	Absolute Level (dBm)	Limit (dBm)
1850.7	1.4	QPSK	1/0	12.64	V	7.88	0.85	19.67	33.01
1880	1.4	QPSK	1/0	12.08	V	7.88	0.85	19.11	33.01
1909.3	1.4	QPSK	1/0	12.23	V	7.88	0.85	19.26	33.01
1850.7	1.4	QPSK	1/0	10.57	H	7.88	0.85	17.6	33.01
1880	1.4	QPSK	1/0	10.73	H	7.88	0.85	17.76	33.01
1909.3	1.4	QPSK	1/0	10.07	H	7.88	0.85	17.1	33.01
1850.7	1.4	16-QAM	1/0	11.38	V	7.88	0.85	18.41	33.01
1880	1.4	16-QAM	1/0	11.08	V	7.88	0.85	18.11	33.01
1909.3	1.4	16-QAM	1/0	11.25	V	7.88	0.85	18.28	33.01
1850.7	1.4	16-QAM	1/0	10.14	H	7.88	0.85	17.17	33.01
1880	1.4	16-QAM	1/0	9.6	H	7.88	0.85	16.63	33.01
1909.3	1.4	16-QAM	1/0	9.73	H	7.88	0.85	16.76	33.01
1851.5	3	QPSK	1/0	13.15	V	7.88	0.85	20.18	33.01
1880	3	QPSK	1/0	12.63	V	7.88	0.85	19.66	33.01
1908.5	3	QPSK	1/0	11.67	V	7.88	0.85	18.7	33.01
1851.5	3	QPSK	1/0	11.17	H	7.88	0.85	18.2	33.01
1880	3	QPSK	1/0	11.3	H	7.88	0.85	18.33	33.01
1908.5	3	QPSK	1/0	9.59	H	7.88	0.85	16.62	33.01
1851.5	3	16-QAM	1/0	11.9	V	7.88	0.85	18.93	33.01
1880	3	16-QAM	1/0	11.6	V	7.88	0.85	18.63	33.01
1908.5	3	16-QAM	1/0	11.28	V	7.88	0.85	18.31	33.01
1851.5	3	16-QAM	1/0	9.9	H	7.88	0.85	16.93	33.01
1880	3	16-QAM	1/0	9.67	H	7.88	0.85	16.7	33.01
1908.5	3	16-QAM	1/0	9.99	H	7.88	0.85	17.02	33.01
1852.5	5	QPSK	1/24	13.04	V	7.88	0.85	20.07	33.01
1880	5	QPSK	1/0	12.47	V	7.88	0.85	19.5	33.01
1907.5	5	QPSK	1/24	12.19	V	7.88	0.85	19.22	33.01
1852.5	5	QPSK	1/24	11.93	H	7.88	0.85	18.96	33.01
1880	5	QPSK	1/0	11.21	H	7.88	0.85	18.24	33.01
1907.5	5	QPSK	1/24	10.28	H	7.88	0.85	17.31	33.01
1852.5	5	16-QAM	1/24	12.58	V	7.88	0.85	19.61	33.01
1880	5	16-QAM	1/0	11.57	V	7.88	0.85	18.6	33.01
1907.5	5	16-QAM	1/24	11.3	V	7.88	0.85	18.33	33.01
1852.5	5	16-QAM	1/24	10.98	H	7.88	0.85	18.01	33.01
1880	5	16-QAM	1/0	9.64	H	7.88	0.85	16.67	33.01

1907.5	5	16-QAM	1/24	9.85	H	7.88	0.85	16.88	33.01
1855	10	QPSK	1/0	12.92	V	7.88	0.85	19.95	33.01
1880	10	QPSK	1/0	12.01	V	7.88	0.85	19.04	33.01
1905	10	QPSK	1/49	12.13	V	7.88	0.85	19.16	33.01
1855	10	QPSK	1/0	11	H	7.88	0.85	18.03	33.01
1880	10	QPSK	1/0	10.32	H	7.88	0.85	17.35	33.01
1905	10	QPSK	1/49	10.36	H	7.88	0.85	17.39	33.01
1855	10	16-QAM	1/0	11.79	V	7.88	0.85	18.82	33.01
1880	10	16-QAM	1/0	10.97	V	7.88	0.85	18	33.01
1905	10	16-QAM	1/49	11.73	V	7.88	0.85	18.76	33.01
1855	10	16-QAM	1/0	10.31	H	7.88	0.85	17.34	33.01
1880	10	16-QAM	1/0	9.49	H	7.88	0.85	16.52	33.01
1905	10	16-QAM	1/49	10.3	H	7.88	0.85	17.33	33.01
1857.5	15	QPSK	1/0	12.63	V	7.88	0.85	19.66	33.01
1880	15	QPSK	1/0	12.66	V	7.88	0.85	19.69	33.01
1902.5	15	QPSK	1/0	12.49	V	7.88	0.85	19.52	33.01
1857.5	15	QPSK	1/0	11.11	H	7.88	0.85	18.14	33.01
1880	15	QPSK	1/0	11.07	H	7.88	0.85	18.1	33.01
1902.5	15	QPSK	1/0	10.69	H	7.88	0.85	17.72	33.01
1857.5	15	16-QAM	1/0	11.56	V	7.88	0.85	18.59	33.01
1880	15	16-QAM	1/0	11.53	V	7.88	0.85	18.56	33.01
1902.5	15	16-QAM	1/0	11.43	V	7.88	0.85	18.46	33.01
1857.5	15	16-QAM	1/0	9.56	H	7.88	0.85	16.59	33.01
1880	15	16-QAM	1/0	10.48	H	7.88	0.85	17.51	33.01
1902.5	15	16-QAM	1/0	9.82	H	7.88	0.85	16.85	33.01
1860	20	QPSK	1/0	12.62	V	7.88	0.85	19.65	33.01
1880	20	QPSK	1/0	12.72	V	7.88	0.85	19.75	33.01
1900	20	QPSK	1/0	12.55	V	7.88	0.85	19.58	33.01
1860	20	QPSK	1/0	11.47	H	7.88	0.85	18.5	33.01
1880	20	QPSK	1/0	11.63	H	7.88	0.85	18.66	33.01
1900	20	QPSK	1/0	10.1	H	7.88	0.85	17.13	33.01
1860	20	16-QAM	1/0	11.56	V	7.88	0.85	18.59	33.01
1880	20	16-QAM	1/0	11.6	V	7.88	0.85	18.63	33.01
1900	20	16-QAM	1/0	11.53	V	7.88	0.85	18.56	33.01
1860	20	16-QAM	1/0	9.22	H	7.88	0.85	16.25	33.01
1880	20	16-QAM	1/0	9.72	H	7.88	0.85	16.75	33.01
1900	20	16-QAM	1/0	9.58	H	7.88	0.85	16.61	33.01

EIRP for LTE Band IV (Part 27)

Frequency (MHz)	BW (MHz)	Modulation	RB Size/Offset	Substituted level (dBm)	Antenna Polarization	Antenna Gain correction (dBi)	Cable Loss (dB)	Absolute Level (dBm)	Limit (dBm)
1710.7	1.4	QPSK	1/0	12.64	V	7.95	0.79	19.8	30
1732.5	1.4	QPSK	1/0	12.95	V	7.95	0.79	20.11	30
1754.3	1.4	QPSK	1/0	12.96	V	7.95	0.79	20.12	30
1710.7	1.4	QPSK	1/0	10.83	H	7.95	0.79	17.99	30
1732.5	1.4	QPSK	1/0	10.84	H	7.95	0.79	18	30
1754.3	1.4	QPSK	1/0	11.19	H	7.95	0.79	18.35	30
1710.7	1.4	16-QAM	1/5	11.53	V	7.95	0.79	18.69	30
1732.5	1.4	16-QAM	1/0	11.81	V	7.95	0.79	18.97	30
1754.3	1.4	16-QAM	1/0	11.63	V	7.95	0.79	18.79	30
1710.7	1.4	16-QAM	1/5	9.5	H	7.95	0.79	16.66	30
1732.5	1.4	16-QAM	1/0	9.86	H	7.95	0.79	17.02	30
1754.3	1.4	16-QAM	1/0	9.51	H	7.95	0.79	16.67	30
1711.5	3	QPSK	1/0	12.71	V	7.95	0.79	19.87	30
1732.5	3	QPSK	1/0	12.73	V	7.95	0.79	19.89	30
1753.5	3	QPSK	1/0	12.76	V	7.95	0.79	19.92	30
1711.5	3	QPSK	1/0	11.1	H	7.95	0.79	18.26	30
1732.5	3	QPSK	1/0	10.82	H	7.95	0.79	17.98	30
1753.5	3	QPSK	1/0	10.71	H	7.95	0.79	17.87	30
1711.5	3	16-QAM	1/0	11.51	V	7.95	0.79	18.67	30
1732.5	3	16-QAM	1/0	11.63	V	7.95	0.79	18.79	30
1753.5	3	16-QAM	1/0	11.67	V	7.95	0.79	18.83	30
1711.5	3	16-QAM	1/0	10.14	H	7.95	0.79	17.3	30
1732.5	3	16-QAM	1/0	9.91	H	7.95	0.79	17.07	30
1753.5	3	16-QAM	1/0	9.56	H	7.95	0.79	16.72	30
1712.5	5	QPSK	1/0	12.6	V	7.95	0.79	19.76	30
1732.5	5	QPSK	1/0	12.83	V	7.95	0.79	19.99	30
1752.5	5	QPSK	1/24	13.02	V	7.95	0.79	20.18	30
1712.5	5	QPSK	1/0	11.28	H	7.95	0.79	18.44	30
1732.5	5	QPSK	1/0	11.27	H	7.95	0.79	18.43	30
1752.5	5	QPSK	1/24	11.94	H	7.95	0.79	19.1	30
1712.5	5	16-QAM	1/0	12.03	V	7.95	0.79	19.19	30
1732.5	5	16-QAM	1/0	11.82	V	7.95	0.79	18.98	30
1752.5	5	16-QAM	1/24	12	V	7.95	0.79	19.16	30
1712.5	5	16-QAM	1/0	10.07	H	7.95	0.79	17.23	30
1732.5	5	16-QAM	1/0	10.02	H	7.95	0.79	17.18	30

1752.5	5	16-QAM	1/24	9.67	H	7.95	0.79	16.83	30
1715	10	QPSK	1/0	12.69	V	7.95	0.79	19.85	30
1732.5	10	QPSK	1/49	12.91	V	7.95	0.79	20.07	30
1750	10	QPSK	1/0	12.52	V	7.95	0.79	19.68	30
1715	10	QPSK	1/0	10.29	H	7.95	0.79	17.45	30
1732.5	10	QPSK	1/49	11.62	H	7.95	0.79	18.78	30
1750	10	QPSK	1/0	10.11	H	7.95	0.79	17.27	30
1715	10	16-QAM	1/0	11.54	V	7.95	0.79	18.7	30
1732.5	10	16-QAM	1/49	11.93	V	7.95	0.79	19.09	30
1750	10	16-QAM	1/0	12.1	V	7.95	0.79	19.26	30
1715	10	16-QAM	1/0	10.49	H	7.95	0.79	17.65	30
1732.5	10	16-QAM	1/49	10.15	H	7.95	0.79	17.31	30
1750	10	16-QAM	1/0	10.52	H	7.95	0.79	17.68	30
1717.5	15	QPSK	1/0	12.68	V	7.95	0.79	19.84	30
1732.5	15	QPSK	1/74	12.72	V	7.95	0.79	19.88	30
1747.5	15	QPSK	1/0	12.67	V	7.95	0.79	19.83	30
1717.5	15	QPSK	1/0	11.24	H	7.95	0.79	18.4	30
1732.5	15	QPSK	1/74	11.16	H	7.95	0.79	18.32	30
1747.5	15	QPSK	1/0	10.63	H	7.95	0.79	17.79	30
1717.5	15	16-QAM	1/0	11.56	V	7.95	0.79	18.72	30
1732.5	15	16-QAM	1/74	11.69	V	7.95	0.79	18.85	30
1747.5	15	16-QAM	1/0	11.89	V	7.95	0.79	19.05	30
1717.5	15	16-QAM	1/0	10.51	H	7.95	0.79	17.67	30
1732.5	15	16-QAM	1/74	9.75	H	7.95	0.79	16.91	30
1747.5	15	16-QAM	1/0	10.6	H	7.95	0.79	17.76	30
1720	20	QPSK	1/99	12.67	V	7.95	0.79	19.83	30
1732.5	20	QPSK	1/99	12.78	V	7.95	0.79	19.94	30
1745	20	QPSK	1/0	12.72	V	7.95	0.79	19.88	30
1720	20	QPSK	1/99	11.46	H	7.95	0.79	18.62	30
1732.5	20	QPSK	1/99	10.79	H	7.95	0.79	17.95	30
1745	20	QPSK	1/0	10.48	H	7.95	0.79	17.64	30
1720	20	16-QAM	1/99	11.84	V	7.95	0.79	19	30
1732.5	20	16-QAM	1/99	11.59	V	7.95	0.79	18.75	30
1745	20	16-QAM	1/0	11.69	V	7.95	0.79	18.85	30
1720	20	16-QAM	1/99	9.82	H	7.95	0.79	16.98	30
1732.5	20	16-QAM	1/99	9.14	H	7.95	0.79	16.3	30
1745	20	16-QAM	1/0	9.2	H	7.95	0.79	16.36	30

ERP for LTE Band VII (Part 27)

Frequency (MHz)	BW (MHz)	Modulation	RB Size/Offset	Substituted level (dBm)	Antenna Polarization	Antenna Gain correction (dBi)	Cable Loss (dB)	Absolute Level (dBm)	Limit (dBm)
2502.5	5	QPSK	1/0	11.42	V	8.93	0.83	19.52	30
2535	5	QPSK	1/0	11.8	V	8.93	0.83	19.9	30
2567.5	5	QPSK	1/24	11.16	V	8.93	0.83	19.26	30
2502.5	5	QPSK	1/0	9.8	H	8.93	0.83	17.9	30
2535	5	QPSK	1/0	10.18	H	8.93	0.83	18.28	30
2567.5	5	QPSK	1/24	9.32	H	8.93	0.83	17.42	30
2502.5	5	16-QAM	1/0	11.04	V	8.93	0.83	19.14	30
2535	5	16-QAM	1/0	10.73	V	8.93	0.83	18.83	30
2567.5	5	16-QAM	1/24	9.98	V	8.93	0.83	18.08	30
2502.5	5	16-QAM	1/0	9.42	H	8.93	0.83	17.52	30
2535	5	16-QAM	1/0	9.17	H	8.93	0.83	17.27	30
2567.5	5	16-QAM	1/24	7.64	H	8.93	0.83	15.74	30
2505	10	QPSK	1/0	11.25	V	8.93	0.83	19.35	30
2535	10	QPSK	1/49	11.31	V	8.93	0.83	19.41	30
2565	10	QPSK	1/0	11.04	V	8.93	0.83	19.14	30
2505	10	QPSK	1/0	9.32	H	8.93	0.83	17.42	30
2535	10	QPSK	1/49	8.97	H	8.93	0.83	17.07	30
2565	10	QPSK	1/0	8.92	H	8.93	0.83	17.02	30
2505	10	16-QAM	1/0	10.24	V	8.93	0.83	18.34	30
2535	10	16-QAM	1/49	10.35	V	8.93	0.83	18.45	30
2565	10	16-QAM	1/0	9.76	V	8.93	0.83	17.86	30
2505	10	16-QAM	1/0	8.89	H	8.93	0.83	16.99	30
2535	10	16-QAM	1/49	8.05	H	8.93	0.83	16.15	30
2565	10	16-QAM	1/0	7.73	H	8.93	0.83	15.83	30
2507.5	15	QPSK	1/0	11.68	V	8.93	0.83	19.78	30
2535	15	QPSK	1/74	11.84	V	8.93	0.83	19.94	30
2562.5	15	QPSK	1/0	11.51	V	8.93	0.83	19.61	30
2507.5	15	QPSK	1/0	10.46	H	8.93	0.83	18.56	30
2535	15	QPSK	1/74	10.81	H	8.93	0.83	18.91	30
2562.5	15	QPSK	1/0	9.89	H	8.93	0.83	17.99	30
2507.5	15	16-QAM	1/0	10.79	V	8.93	0.83	18.89	30
2535	15	16-QAM	1/74	10.66	V	8.93	0.83	18.76	30
2562.5	15	16-QAM	1/0	10.61	V	8.93	0.83	18.71	30

2507.5	15	16-QAM	1/0	8.42	H	8.93	0.83	16.52	30
2535	15	16-QAM	1/74	9.33	H	8.93	0.83	17.43	30
2562.5	15	16-QAM	1/0	9.28	H	8.93	0.83	17.38	30
2510	20	QPSK	1/99	11.55	V	8.93	0.83	19.65	30
2535	20	QPSK	1/99	11.55	V	8.93	0.83	19.65	30
2560	20	QPSK	1/0	11.53	V	8.93	0.83	19.63	30
2510	20	QPSK	1/99	10.15	H	8.93	0.83	18.25	30
2535	20	QPSK	1/99	9.69	H	8.93	0.83	17.79	30
2560	20	QPSK	1/0	9.09	H	8.93	0.83	17.19	30
2510	20	16-QAM	1/99	10.66	V	8.93	0.83	18.76	30
2535	20	16-QAM	1/99	10.55	V	8.93	0.83	18.65	30
2560	20	16-QAM	1/0	10.61	V	8.93	0.83	18.71	30
2510	20	16-QAM	1/99	8.77	H	8.93	0.83	16.87	30
2535	20	16-QAM	1/99	8.88	H	8.93	0.83	16.98	30
2560	20	16-QAM	1/0	8.83	H	8.93	0.83	16.93	30

6.3 Peak-Average Ratio

Temperature	25°C
Relative Humidity	57%
Atmospheric Pressure	1023mbar
Test date :	October 27, 2017
Tested By :	Loren Luo

Requirement(s):

Spec	Item	Requirement	Applicable
§24.232(d) § 27.50(d)	a)	The peak-to-average ratio (PAR) of the transmission may not exceed 13 dB.	<input checked="" type="checkbox"/>

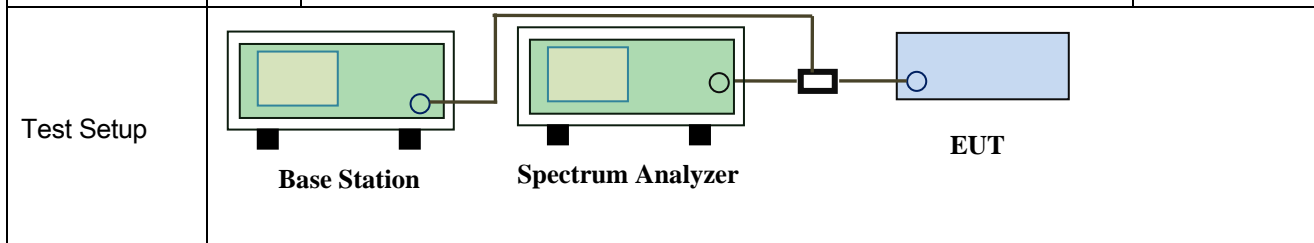

Test Procedure	<p>According with KDB 971168 v02r02</p> <p>5.7.2 Alternate procedure for PAPR</p> <p>5.1.2 Peak power measurements with a peak power meter</p> <p>The total peak output power may be measured using a broadband peak RF power meter. The power meter must have a video bandwidth that is greater than or equal to the emission bandwidth and utilize a fast-responding diode detector.</p> <p>5.2.3 Average power measurement with average power meter</p> <p>As an alternative to the use of a spectrum/signal analyzer or EMI receiver to perform a measurement of the total in-band average output power, a wideband RF average power meter with a thermocouple detector or equivalent can be used under certain conditions</p> <p>If the EUT can be configured to transmit continuously (i.e., the burst duty</p>
----------------	---

	<p>cycle \geq 98%) and at all times the EUT is transmitting at its maximum output power level, then a conventional wide-band RF power meter can be used. If the EUT cannot be configured to transmit continuously (i.e., the burst duty cycle $<$ 98%), then there are two options for the use of an average power meter. First, a gated average power meter can be used to perform the measurement if the gating parameters can be adjusted such that the power is measured only over active transmission bursts at maximum output power levels. A conventional average power meter can also be used if the measured burst duty cycle is constant (i.e., duty cycle variations are less than \pm 2 percent) by performing the measurement over the on/off burst cycles and then correcting (increasing) the measured level by a factor equal to $10\log(1/\text{duty cycle})$</p>
Remark	
Result	<input checked="" type="checkbox"/> Pass <input type="checkbox"/> Fail

Test Data Yes N/A
 Test Plot Yes (See below) N/A

LTE Band II (part 24E)

BW(MHz)	Frequency (MHz)	Mode	Modulation	Conducted Power (dBm)		Peak-Average Ratio (PAR)
				Peak	Average	
1.4	1880	RB 1/0	QPSK	22.32	21.91	0.41
			16QAM	21.23	20.91	0.32
3	1880	RB 1/0	QPSK	22.95	22.46	0.49
			16QAM	21.75	21.43	0.32
5	1880	RB 1/0	QPSK	22.64	22.3	0.34
			16QAM	21.76	21.4	0.36
10	1880	RB 1/0	QPSK	22.34	21.84	0.5
			16QAM	21.17	20.8	0.37
15	1880	RB 1/0	QPSK	22.85	22.49	0.36
			16QAM	21.78	21.36	0.42
20	1880	RB 1/0	QPSK	22.93	22.55	0.38
			16QAM	21.78	21.43	0.35

LTE Band IV (part 27)

BW(MHz)	Frequency (MHz)	Mode	Modulation	Conducted Power (dBm)		Peak-Average Ratio (PAR)
				Peak	Average	
1.4	1732.5	RB 1/0	QPSK	22.98	22.51	0.47
			16QAM	21.74	21.37	0.37
3	1732.5	RB 1/0	QPSK	22.75	22.29	0.46
			16QAM	21.66	21.19	0.47
5	1732.5	RB 1/0	QPSK	22.71	22.39	0.32
			16QAM	21.84	21.38	0.46
10	1732.5	RB 1/0	QPSK	22.91	22.47	0.44
			16QAM	21.88	21.42	0.46
15	1732.5	RB 1/0	QPSK	22.55	22.19	0.36
			16QAM	21.79	21.32	0.47
20	1732.5	RB 1/0	QPSK	22.72	22.32	0.4
			16QAM	21.53	21.18	0.35

LTE Band VII (part 27)

BW(MHz)	Frequency (MHz)	Mode	Modulation	Conducted Power (dBm)		Peak-Average Ratio (PAR)
				Peak	Average	
5	2535	RB 1/0	QPSK	22.89	22.4	0.49
			16QAM	21.79	21.33	0.46
10	2535	RB 1/0	QPSK	22.36	21.99	0.37
			16QAM	21.42	20.98	0.44
15	2535	RB 1/0	QPSK	22.84	22.36	0.48
			16QAM	21.69	21.28	0.41
20	2535	RB 1/0	QPSK	22.49	22.16	0.33
			16QAM	21.63	21.15	0.48

6.4 Occupied Bandwidth

Temperature	25°C
Relative Humidity	57%
Atmospheric Pressure	1023mbar
Test date :	October 27, 2017
Tested By :	Loren Luo

Requirement(s):

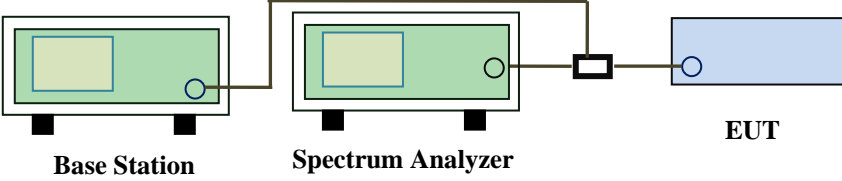
Spec	Item	Requirement	Applicable
§2.1049, §22.917, §22.905 §24.238 §27.53(a)	a)	99% Occupied Bandwidth(kHz)	<input checked="" type="checkbox"/>
	b)	26 dB Bandwidth(kHz)	<input checked="" type="checkbox"/>
Test Setup	 <p style="text-align: center;"> Base Station Spectrum Analyzer EUT </p>		
Test Procedure	<ul style="list-style-type: none"> - The EUT was connected to Spectrum Analyzer and Base Station via power divider. - The 99% and 26 dB occupied bandwidth (BW) of the middle channel for the highest RF powers. 		
Remark			
Result	<input checked="" type="checkbox"/> Pass <input type="checkbox"/> Fail		

Test Data Yes N/A

Test Plot Yes (See below) N/A

LTE Band II (Part 24E)

BW(MHz)	Channel	Frequency (MHz)	Modulation	99% Occupied Bandwidth (MHz)	26 dB Bandwidth (MHz)
1.4	18607	1850	16QAM	1.1032	1.309
			QPSK	1.1063	1.301
1.4	18900	1880	16QAM	1.1005	1.367
			QPSK	1.1129	1.323
1.4	19193	1909	16QAM	1.1169	1.291
			QPSK	1.1058	1.288
3	18615	1852	16QAM	2.7747	3.143
			QPSK	2.7587	3.126
3	18900	1880	16QAM	2.7761	3.160
			QPSK	2.7824	3.109
3	19185	1909	16QAM	2.7644	3.136
			QPSK	2.7591	3.132
5	18625	1853	16QAM	4.5371	5.110
			QPSK	4.5358	5.107
5	18900	1880	16QAM	4.5519	5.242
			QPSK	4.5428	5.296
5	19175	1908	16QAM	4.5347	5.128
			QPSK	4.5491	5.104
10	18650	1855	16QAM	9.0910	10.385
			QPSK	9.0864	10.416
10	18900	1880	16QAM	9.1163	10.464
			QPSK	9.1351	10.640
10	19150	1905	16QAM	9.0983	10.302
			QPSK	9.1049	10.408
15	18675	1858	16QAM	13.5272	15.037
			QPSK	13.5282	15.065
15	18900	1880	16QAM	13.5514	15.372
			QPSK	13.6026	15.308
15	19125	1903	16QAM	13.5059	15.039
			QPSK	13.5237	15.077

20	18700	1860	16QAM	17.9462	19.753
			QPSK	17.9621	19.665
20	18900	1880	16QAM	17.9412	19.500
			QPSK	17.9262	19.444
20	19100	1900	16QAM	17.8999	19.317
			QPSK	17.8174	19.511

LTE Band IV (Part 27)

BW(MHz)	Channel	Frequency (MHz)	Modulation	99% Occupied Bandwidth (MHz)	26 dB Bandwidth (MHz)
1.4	19957	1711	16QAM	1.1075	1.302
			QPSK	1.1106	1.294
1.4	20175	1733	16QAM	1.1059	1.284
			QPSK	1.1193	1.283
1.4	20393	1754	16QAM	1.1047	1.288
			QPSK	1.1028	1.295
3	19965	1712	16QAM	2.7576	3.103
			QPSK	2.7548	3.106
3	20175	1733	16QAM	2.7501	3.114
			QPSK	2.7481	3.105
3	20385	1754	16QAM	2.7563	3.116
			QPSK	2.7505	3.111
5	19975	1713	16QAM	4.5319	5.099
			QPSK	4.5314	5.099
5	20175	1733	16QAM	4.5148	5.063
			QPSK	4.5167	5.070
5	20375	1753	16QAM	4.5442	5.094
			QPSK	4.5371	5.095
10	20000	1715	16QAM	9.0548	10.219
			QPSK	9.0543	10.175
10	20175	1733	16QAM	9.0946	10.334
			QPSK	9.1024	10.234
10	20350	1750	16QAM	9.0918	10.350
			QPSK	9.0973	10.337
15	20025	1718	16QAM	13.4792	14.948
			QPSK	13.4801	14.951
15	20175	1733	16QAM	13.5123	15.082
			QPSK	13.5085	15.025
15	20325	1748	16QAM	13.4751	14.980
			QPSK	13.4898	14.973

20	20050	1720	16QAM	17.8958	19.958
			QPSK	17.8709	19.440
20	20175	1733	16QAM	17.9726	19.770
			QPSK	17.9400	19.721
20	20300	1745	16QAM	17.8704	19.448
			QPSK	17.9136	19.445

LTE Band VII (Part 27) result

BW(MHz)	Channel	Frequency (MHz)	Modulation	99% Occupied Bandwidth (MHz)	26 dB Bandwidth (MHz)
5	20775	2503	16QAM	4.5354	5.117
			QPSK	4.5442	5.125
5	21100	2535	16QAM	4.5293	5.015
			QPSK	4.5439	5.065
5	21425	2568	16QAM	4.5354	5.114
			QPSK	4.5280	5.117
10	20800	2505	16QAM	9.0624	10.390
			QPSK	9.0847	10.432
10	21100	2535	16QAM	9.0631	10.218
			QPSK	9.0696	10.299
10	21400	2565	16QAM	9.0590	10.103
			QPSK	9.0513	10.138
15	20825	2508	16QAM	13.4639	15.094
			QPSK	13.4755	15.075
15	21100	2535	16QAM	13.4865	14.997
			QPSK	13.4845	14.972
15	21400	2563	16QAM	13.5427	15.025
			QPSK	13.4942	15.083
20	20850	2510	16QAM	17.8924	19.611
			QPSK	17.9004	19.735
20	21100	2535	16QAM	17.8397	19.440
			QPSK	17.8921	19.463
20	21350	2560	16QAM	17.9109	19.469
			QPSK	17.9156	19.543

Test Plots

LTE Band II (Part 24E)

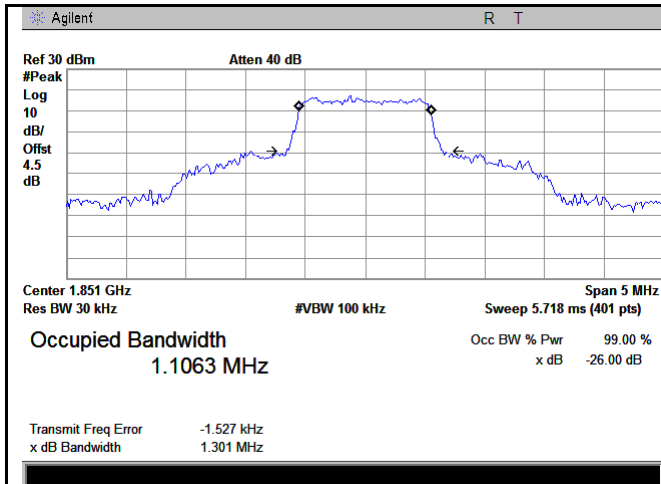

LTE band II - Low CH QPSK-1.4

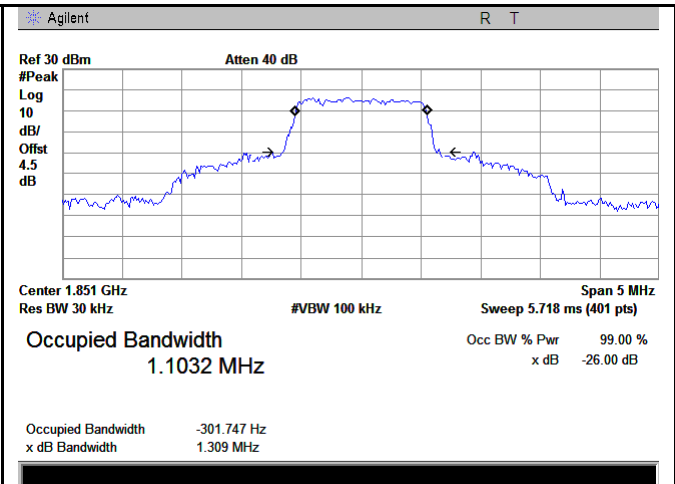

LTE band II - Low CH 16QAM-1.4

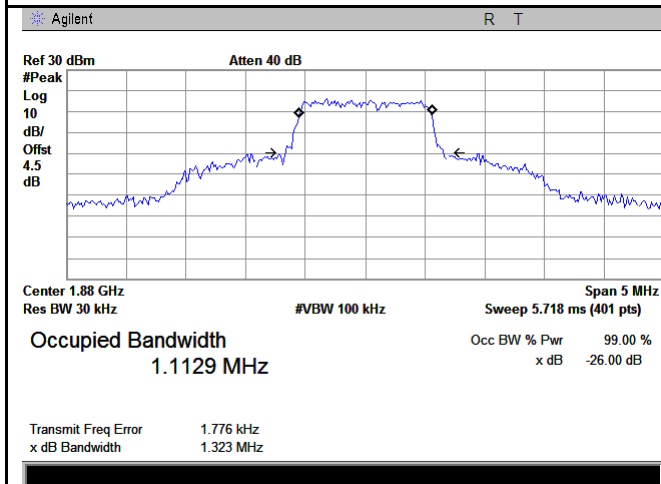

LTE band II - Middle CH QPSK-1.4

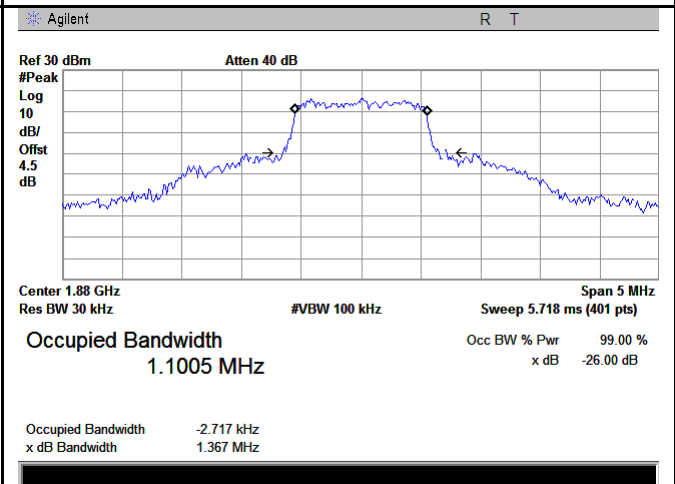

LTE band II - Middle CH 16QAM-1.4

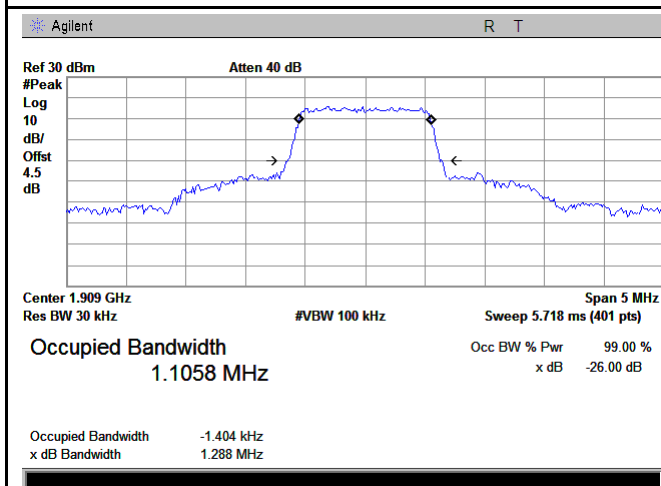

LTE band II - High CH QPSK-1.4

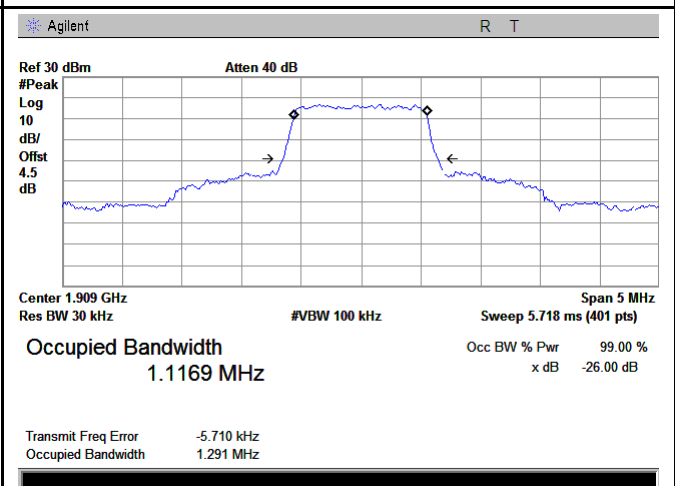

LTE band II - High CH 16QAM-1.4

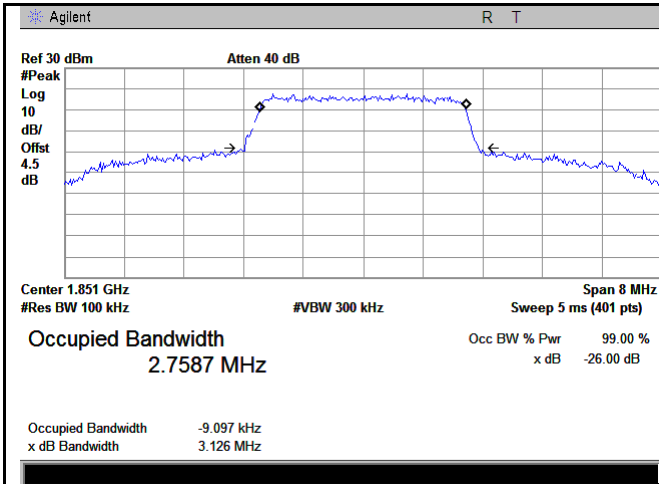

LTE band II - Low CH QPSK-3

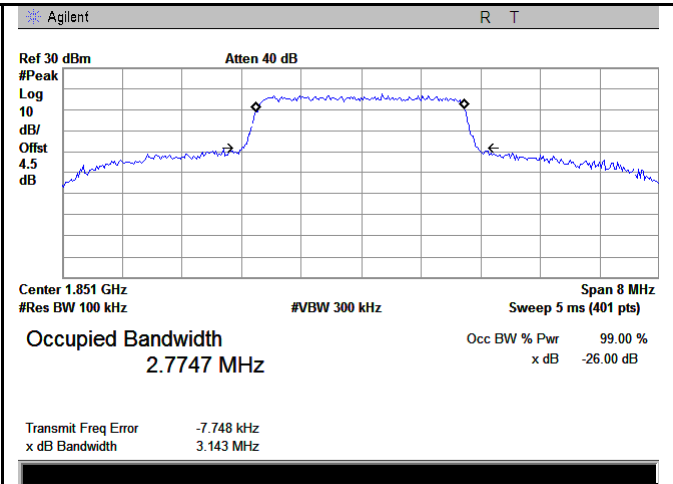

LTE band II - Low CH 16QAM-3

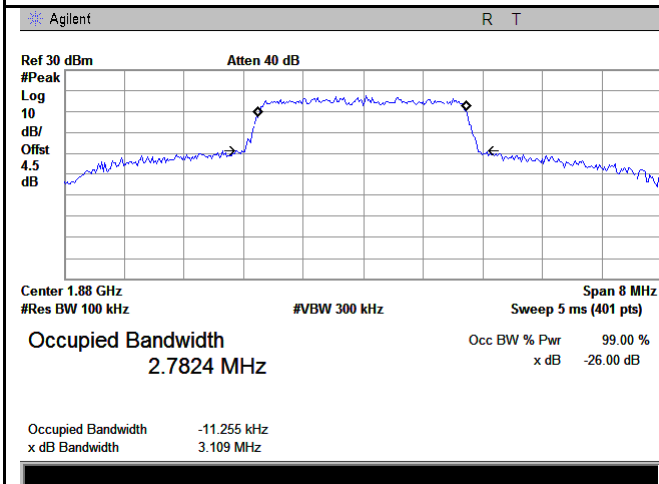

LTE band II - Middle CH QPSK-3

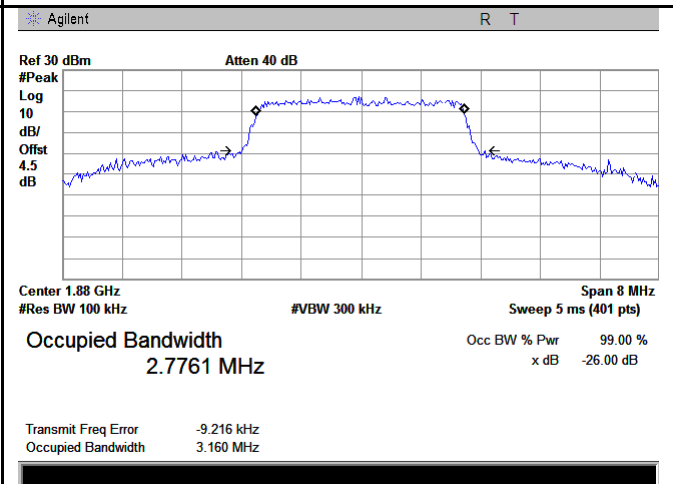

LTE band II - Middle CH 16QAM-3

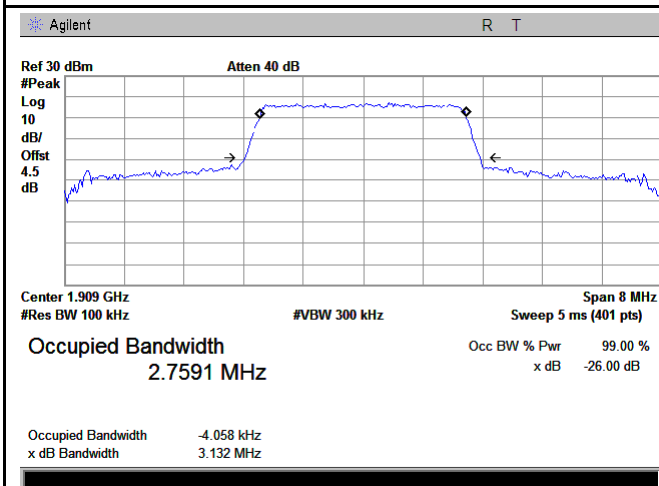

LTE band II - High CH QPSK-3

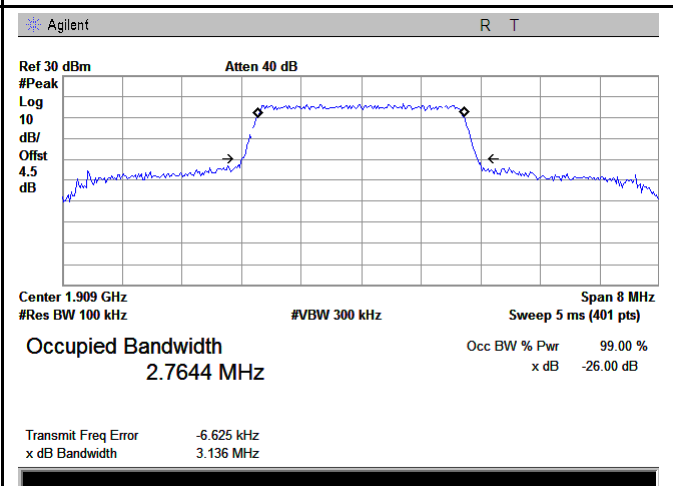

LTE band II - High CH 16QAM-3

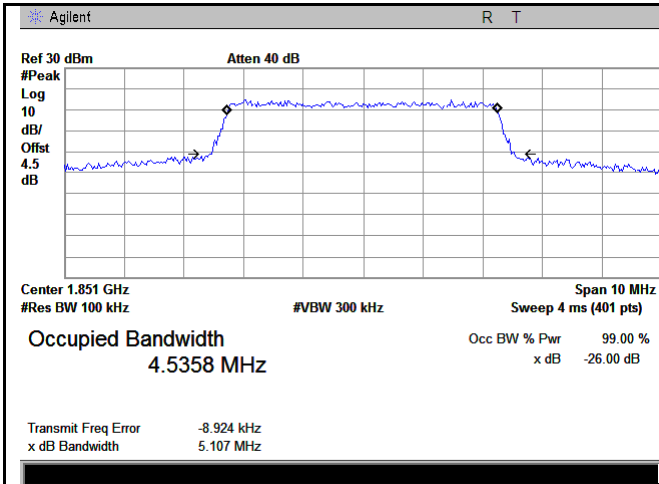

LTE band II - Low CH QPSK-5

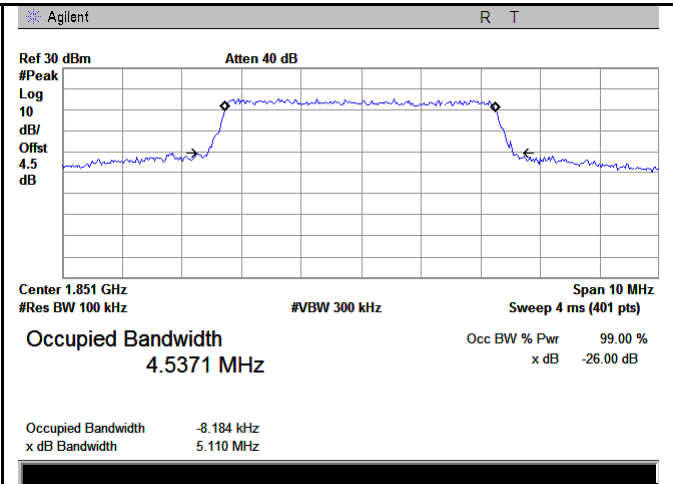

LTE band II - Low CH 16QAM-5

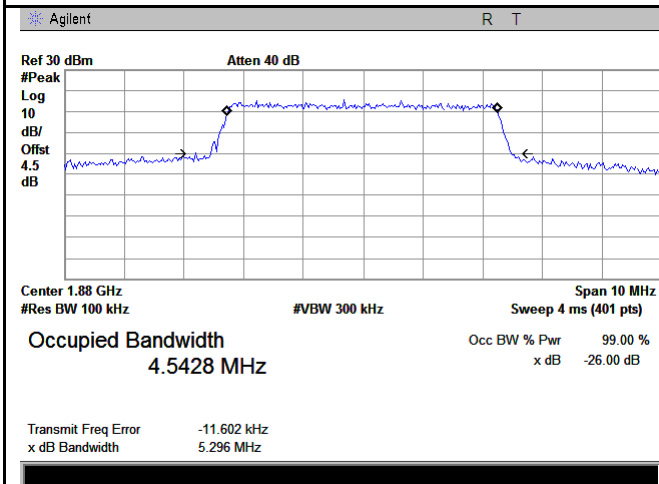

LTE band II - Middle CH QPSK-5

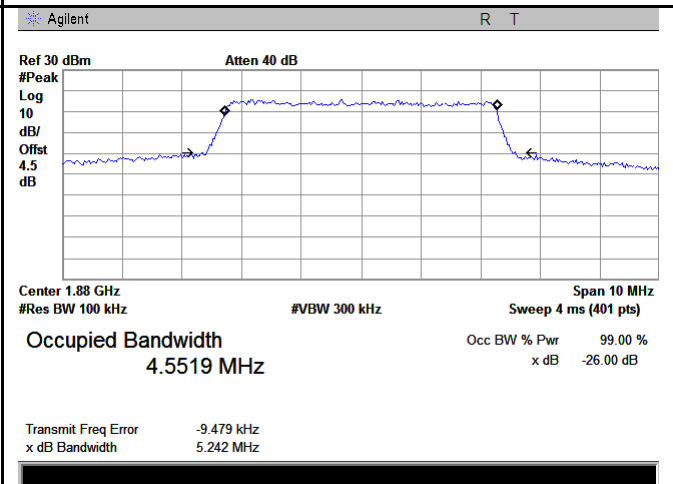

LTE band II - Middle CH 16QAM-5

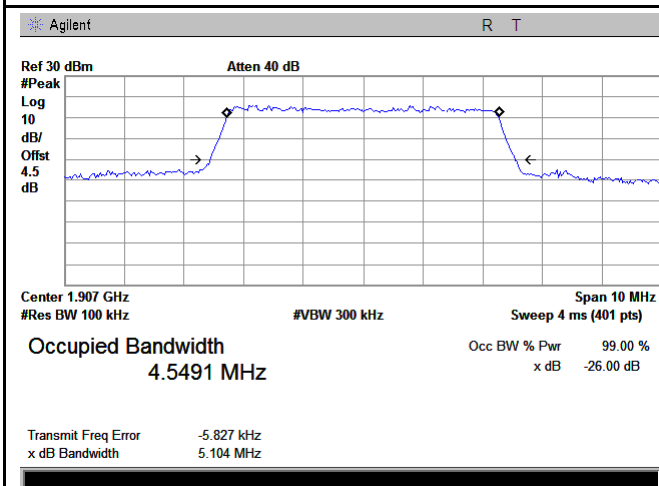

LTE band II - High CH QPSK-5

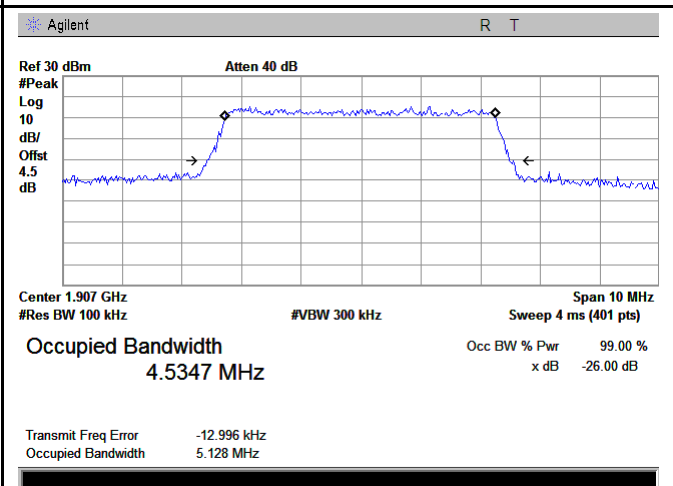

LTE band II - High CH 16QAM-5

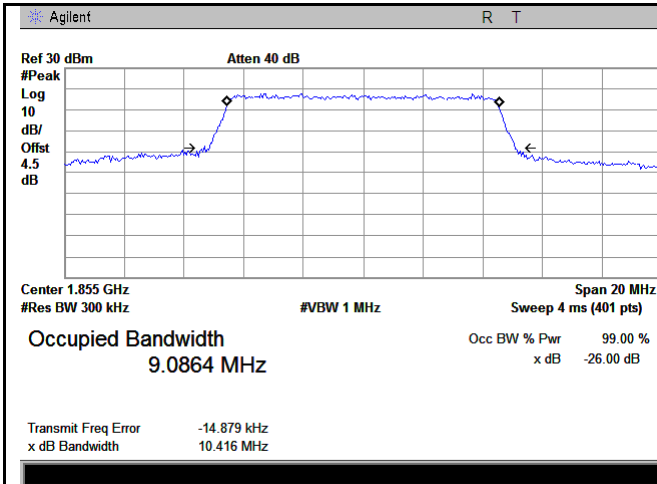

LTE band II - Low CH QPSK-10

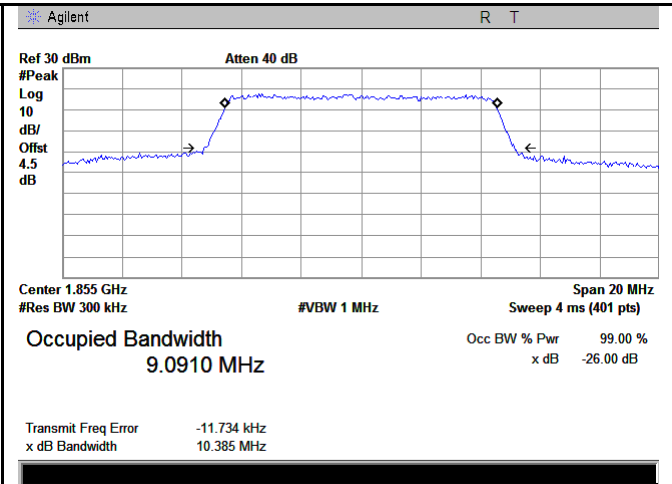

LTE band II - Low CH 16QAM-10

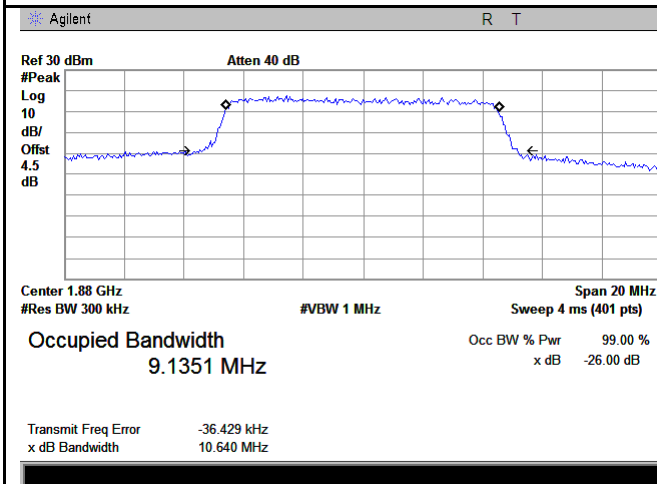

LTE band II - Middle CH QPSK-10

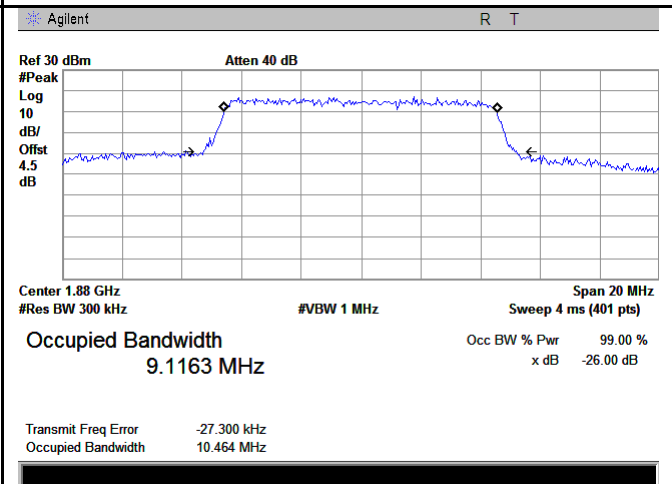

LTE band II - Middle CH 16QAM-10

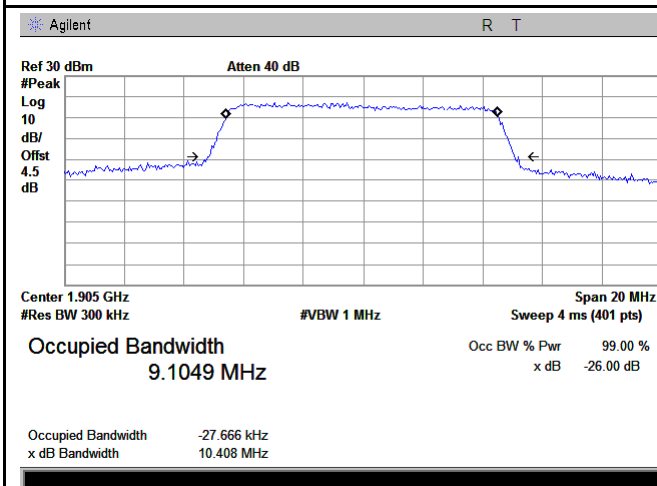

LTE band II - High CH QPSK-10

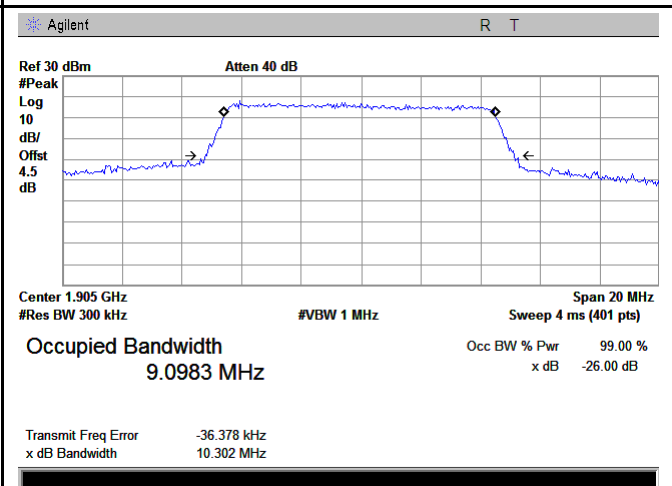

LTE band II - High CH 16QAM-10

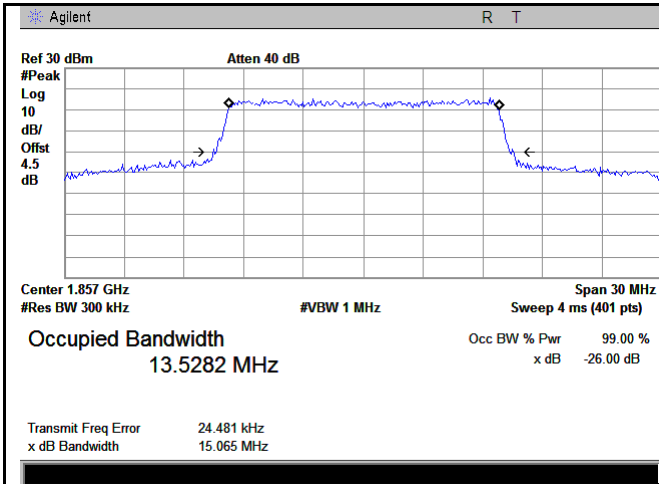

LTE band II - Low CH QPSK-15

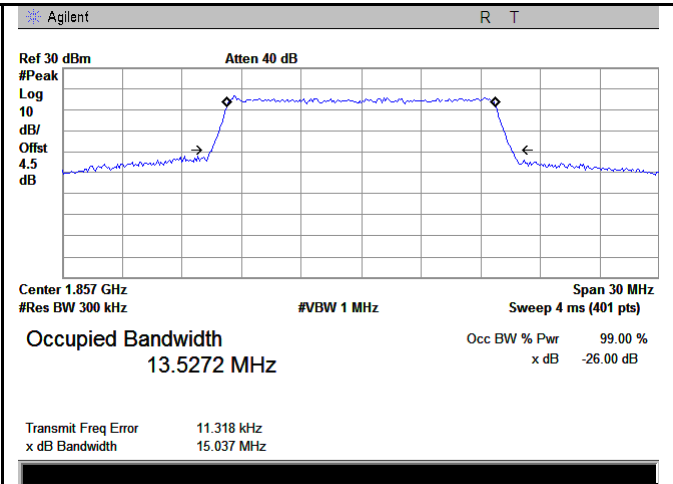

LTE band II - Low CH 16QAM-15

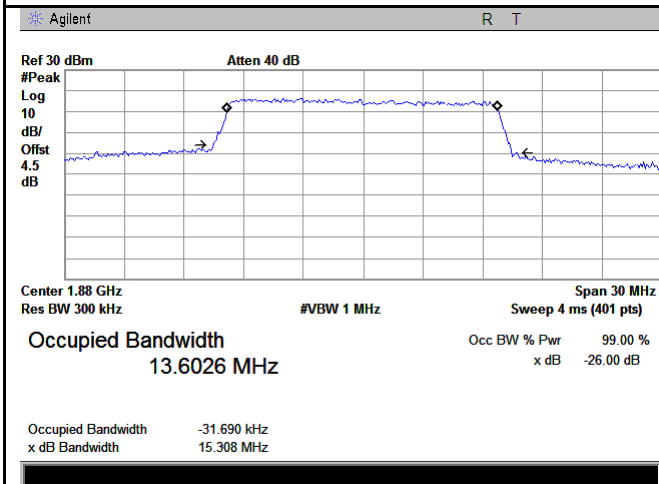

LTE band II - Middle CH QPSK-15

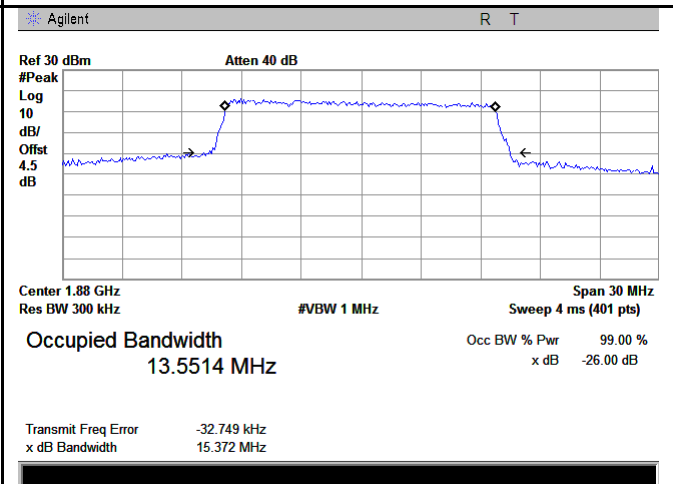

LTE band II - Middle CH 16QAM-15

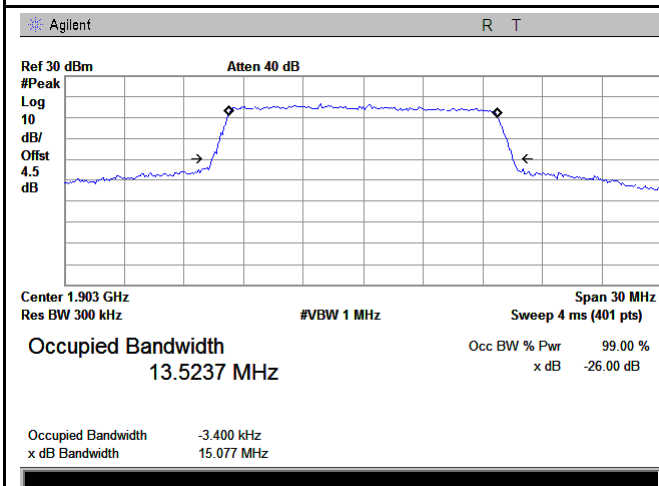

LTE band II - High CH QPSK-15

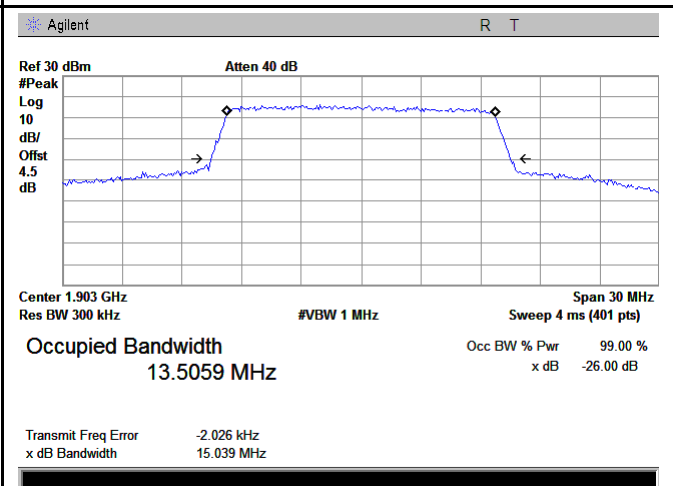

LTE band II - High CH 16QAM-15

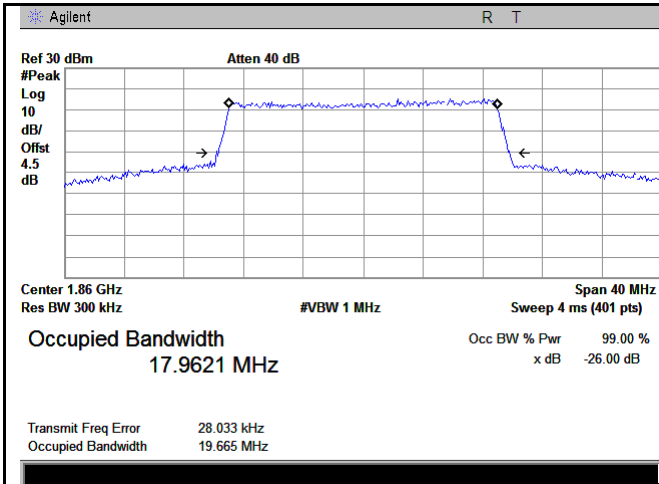

LTE band II - Low CH QPSK-20

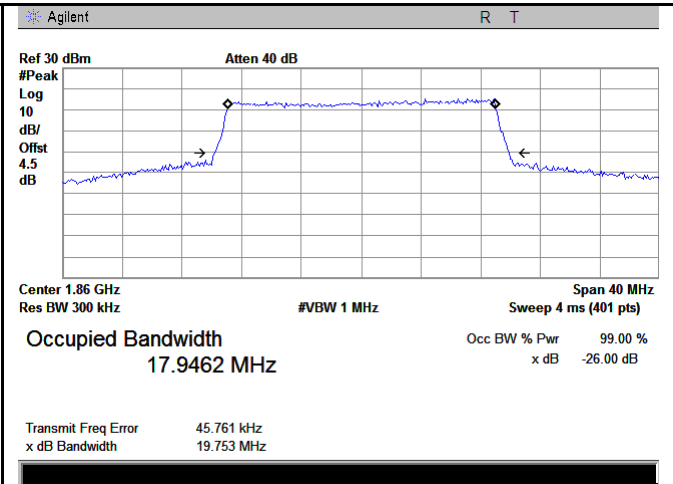

LTE band II - Low CH 16QAM-20

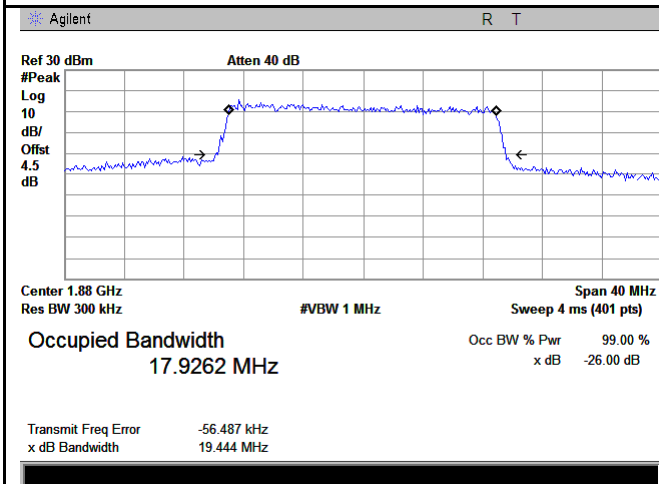

LTE band II - Middle CH QPSK-20

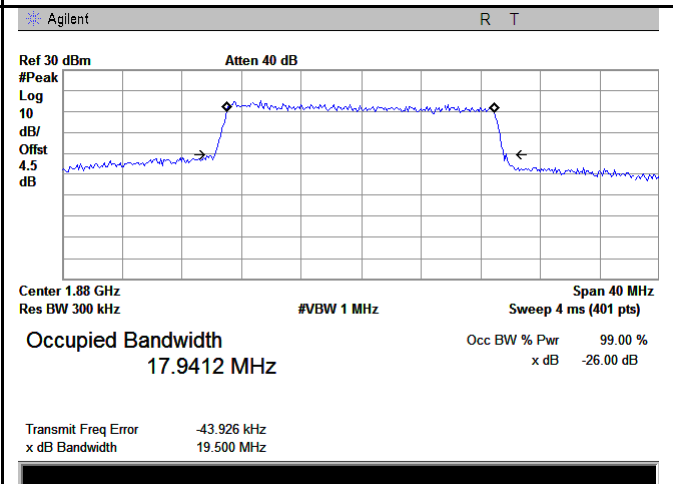

LTE band II - Middle CH 16QAM-20

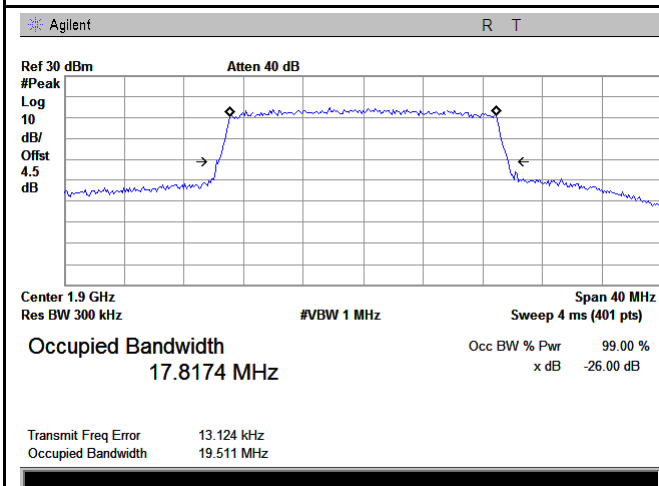

LTE band II - High CH QPSK-20

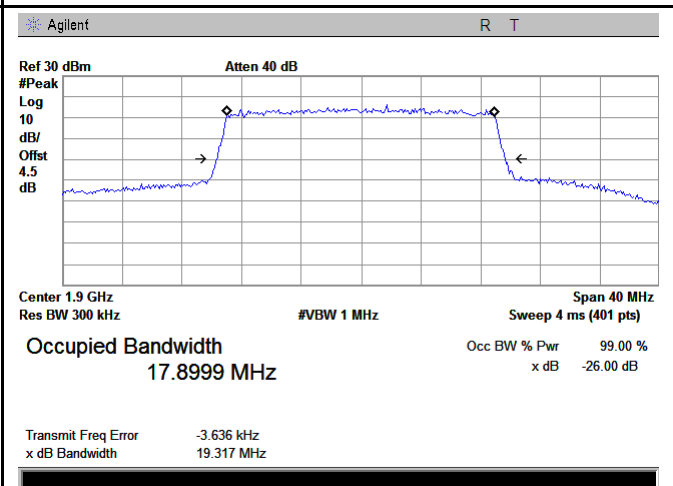

LTE band II - High CH 16QAM-20

LTE band IV (Part 27)

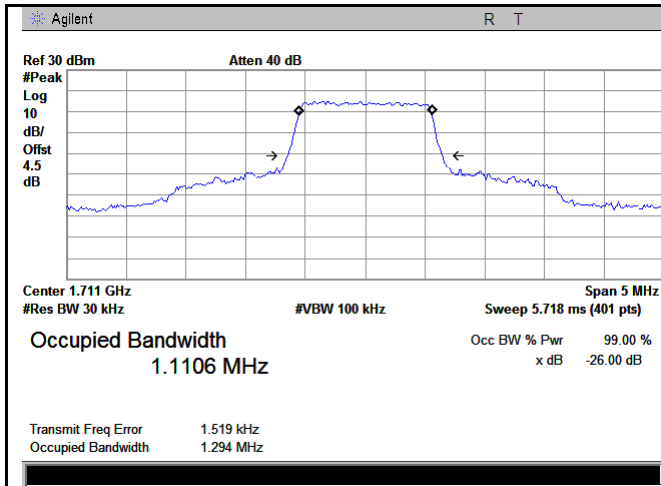

LTE band IV - Low CH QPSK-1.4

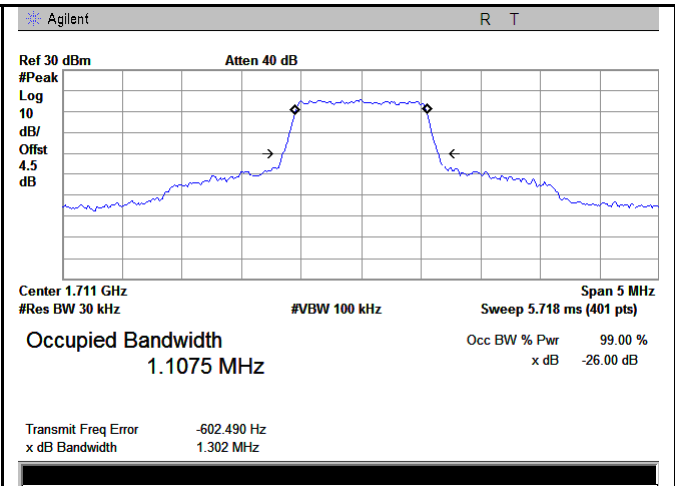

LTE band IV - Low CH 16QAM-1.4

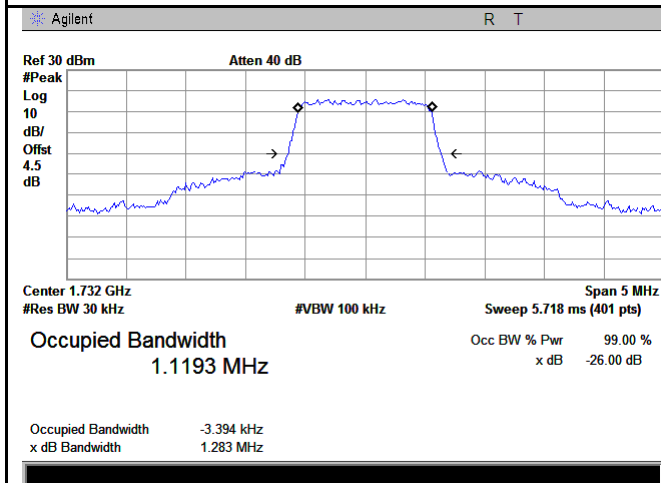

LTE band IV - Middle CH QPSK-1.4

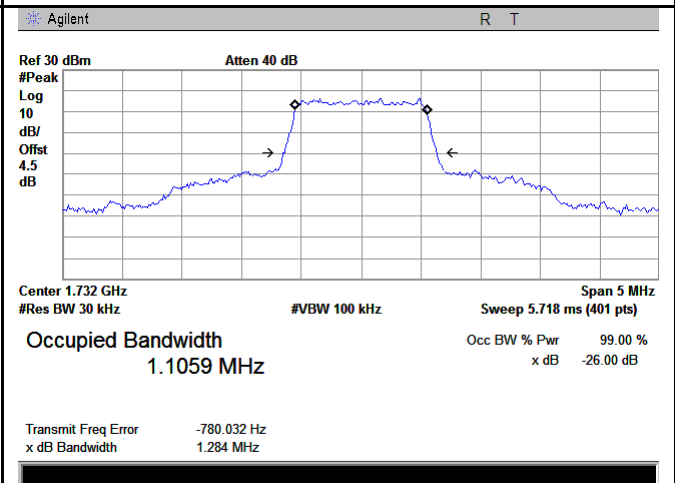

LTE band IV - Middle CH 16QAM-1.4

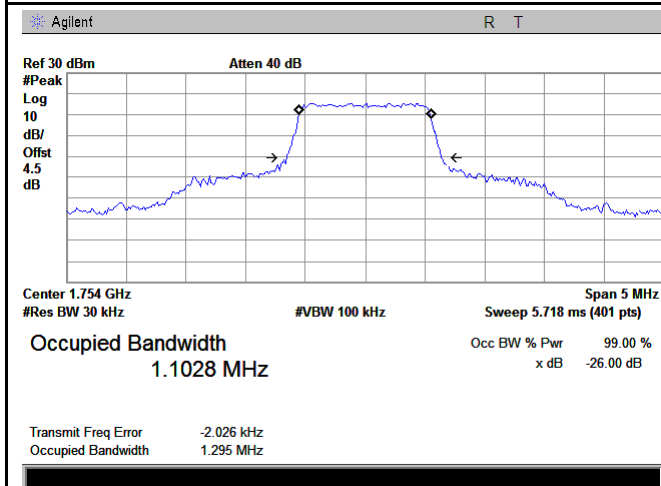

LTE band IV - High CH QPSK-1.4

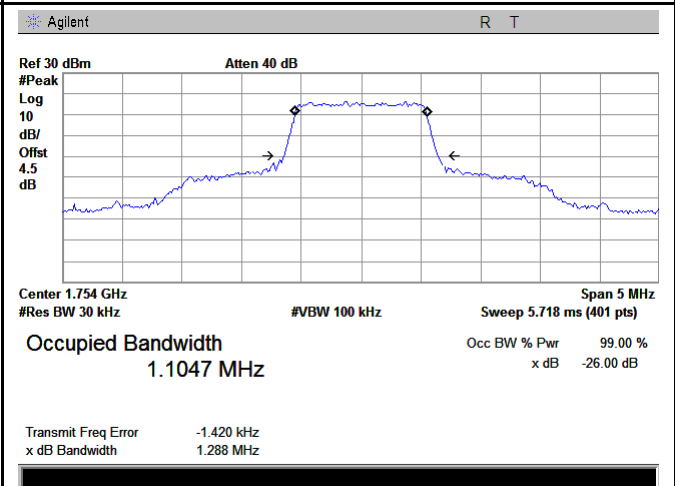

LTE band IV - High CH 16QAM-1.4

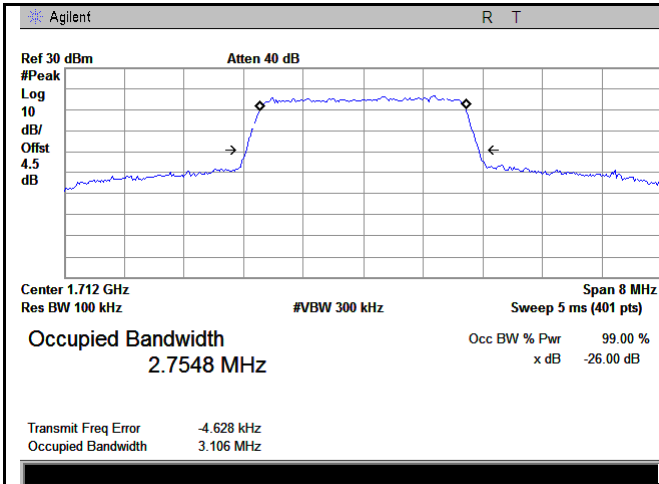

LTE band IV - Low CH QPSK-3

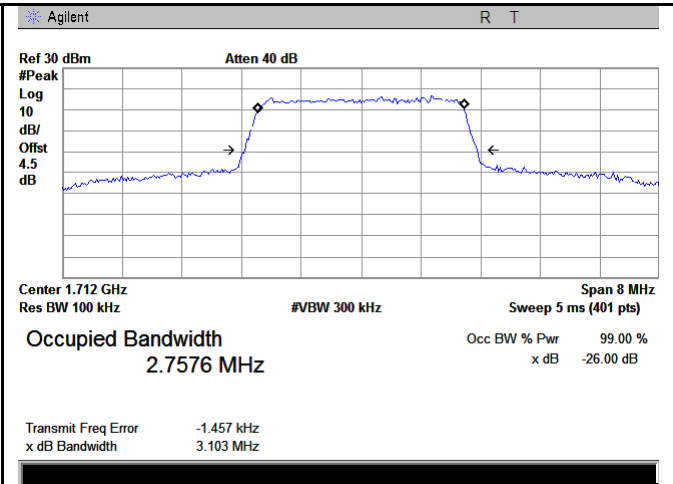

LTE band IV - Low CH 16QAM-3

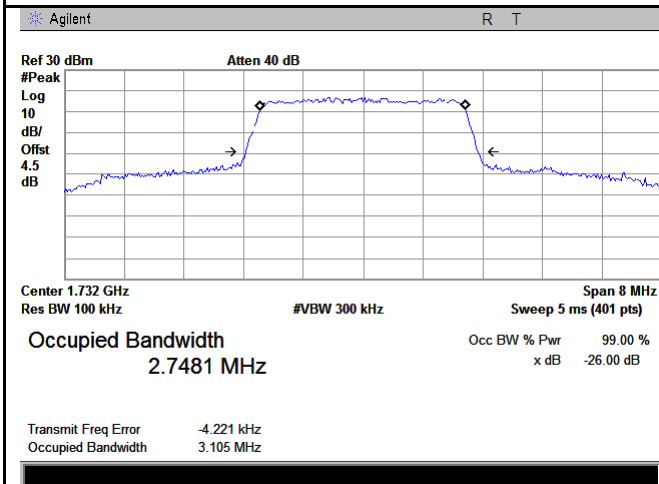

LTE band IV - Middle CH QPSK-3

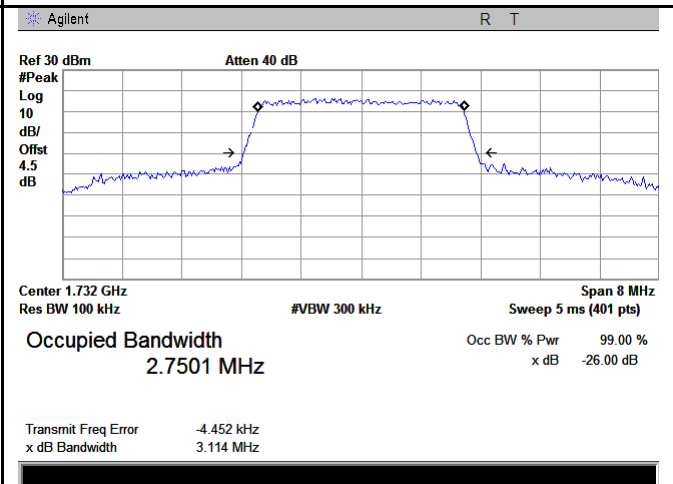

LTE band IV - Middle CH 16QAM-3

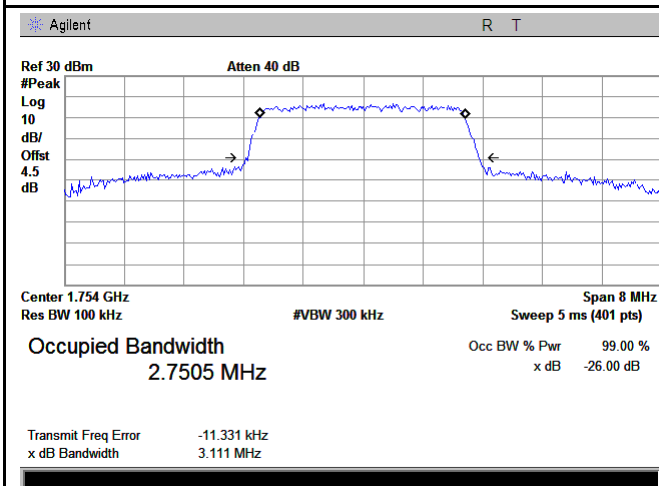

LTE band IV - High CH QPSK-3

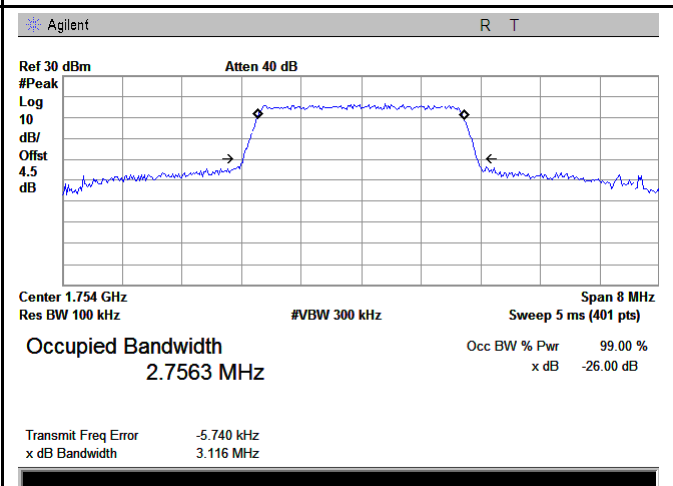

LTE band IV - High CH 16QAM-3

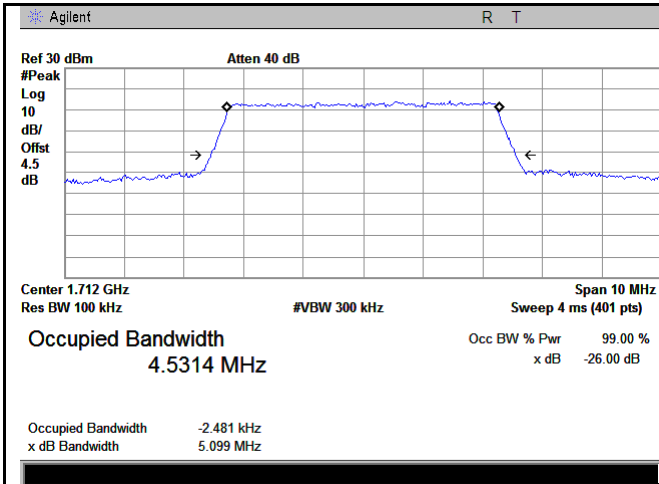

LTE band IV - Low CH QPSK-5

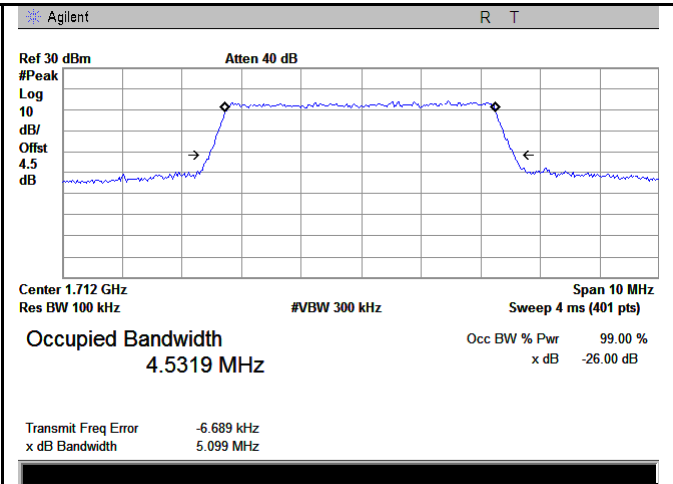

LTE band IV - Low CH 16QAM-5

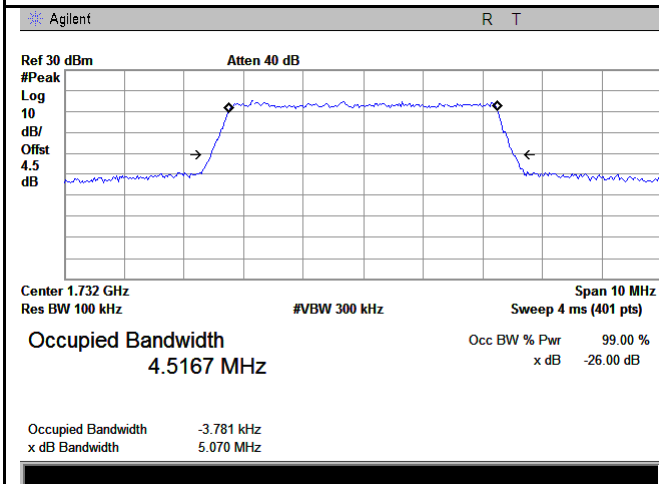

LTE band IV - Middle CH QPSK-5

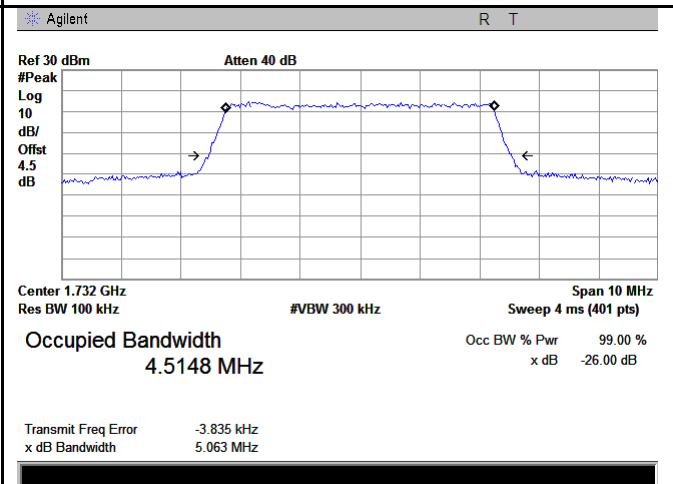

LTE band IV - Middle CH 16QAM-5

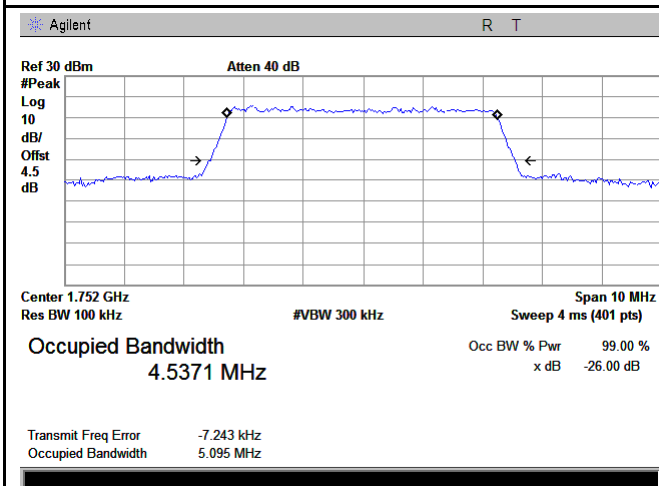

LTE band IV - High CH QPSK-5

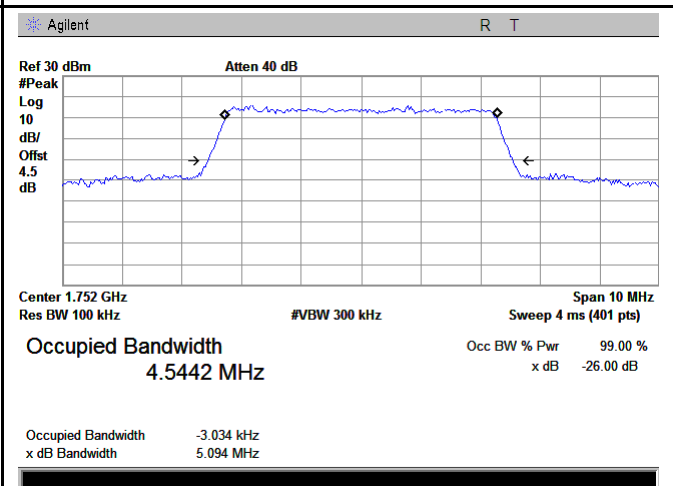

LTE band IV - High CH 16QAM-5

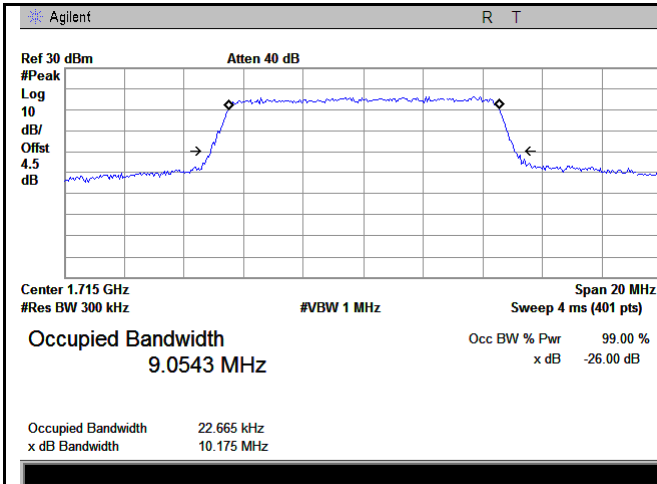

LTE band IV - Low CH QPSK-10

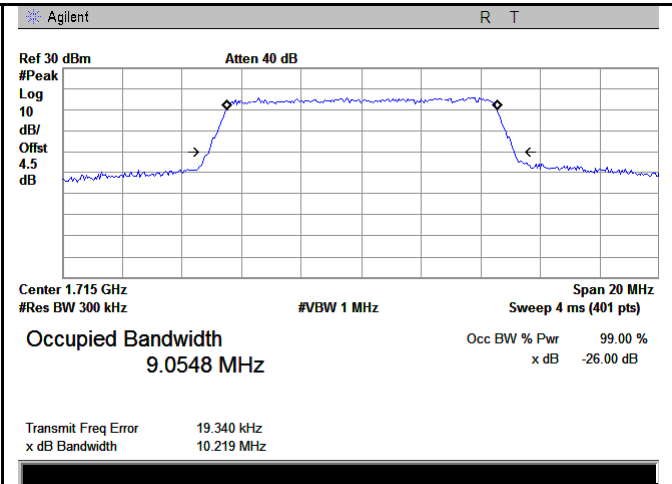

LTE band IV - Low CH 16QAM-10

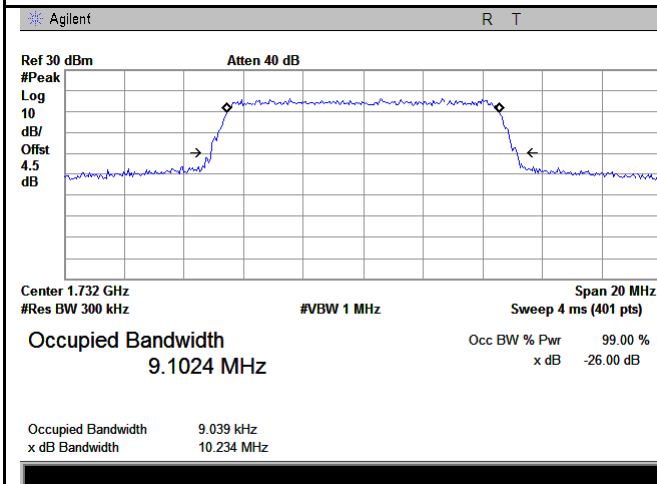

LTE band IV - Middle CH QPSK-10

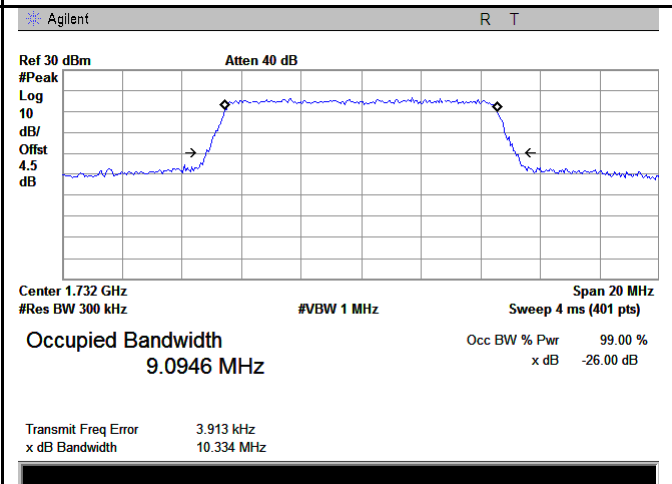

LTE band IV - Middle CH 16QAM-10

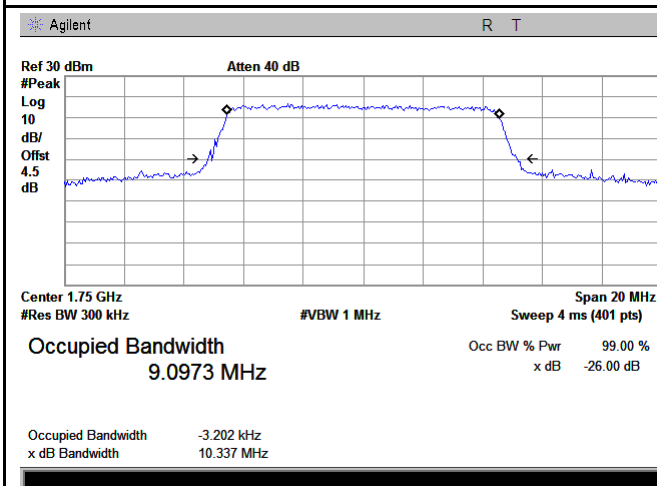

LTE band IV - High CH QPSK-10

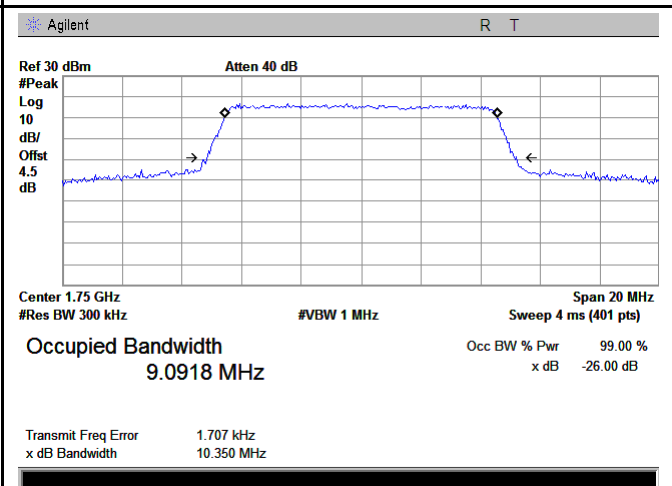

LTE band IV - High CH 16QAM-10

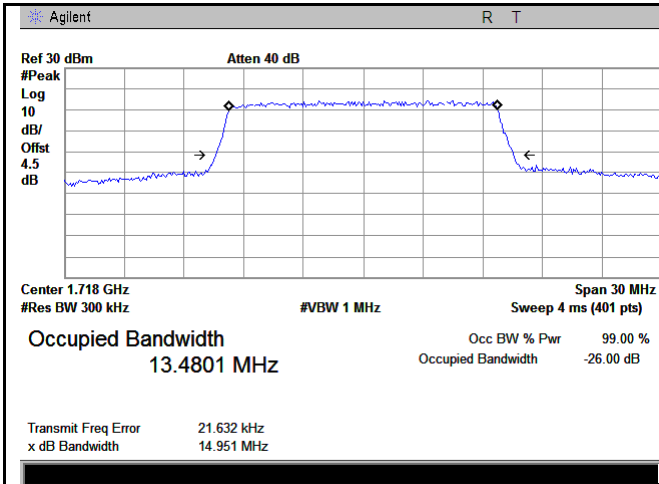

LTE band IV - Low CH QPSK-15

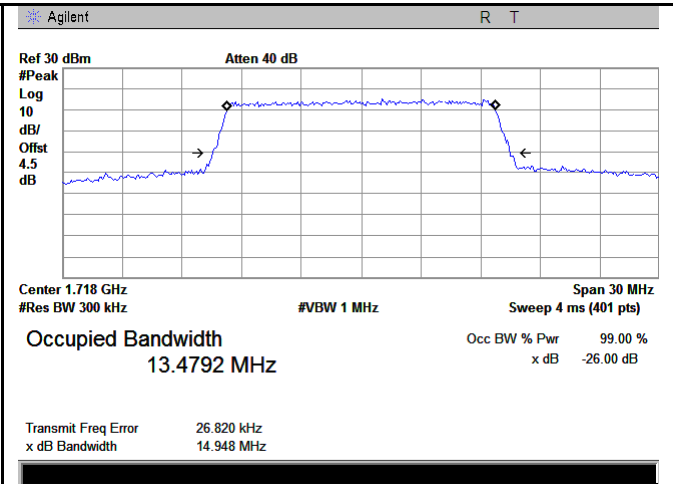

LTE band IV - Low CH 16QAM-15

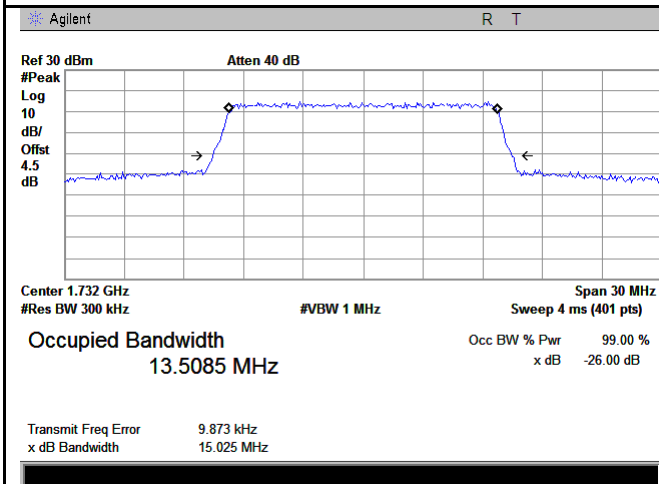

LTE band IV - Middle CH QPSK-15

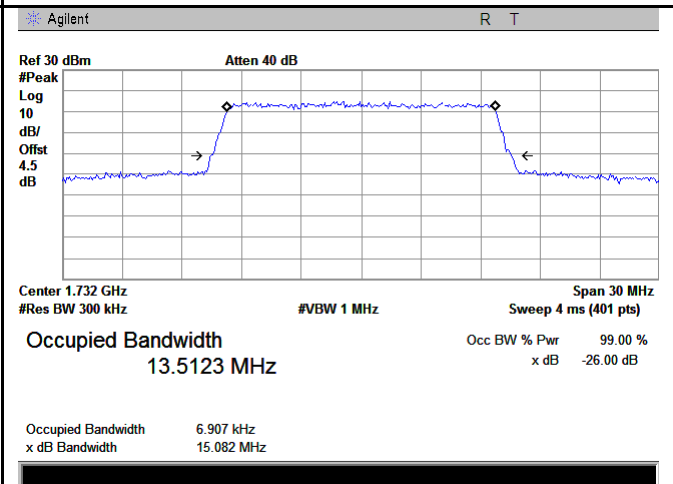

LTE band IV - Middle CH 16QAM-15

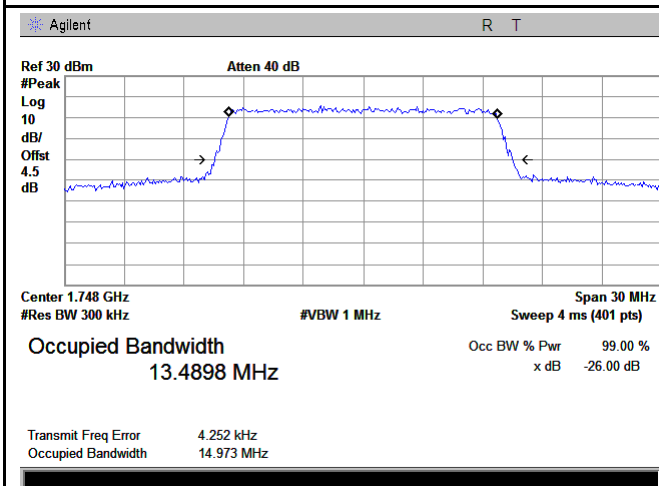

LTE band IV - High CH QPSK-15

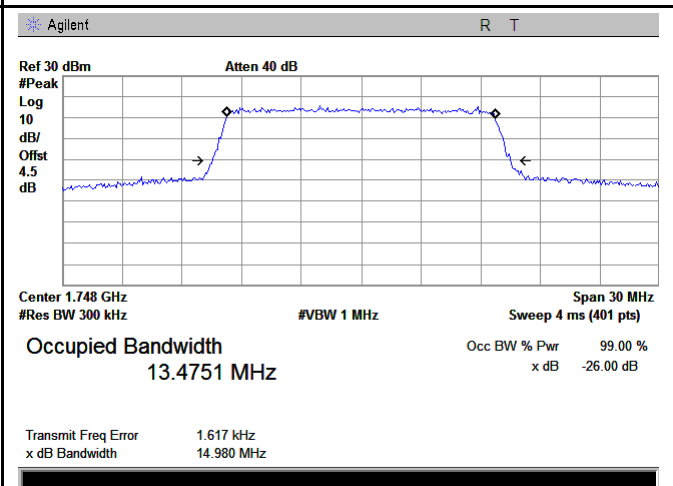

LTE band IV - High CH 16QAM-15

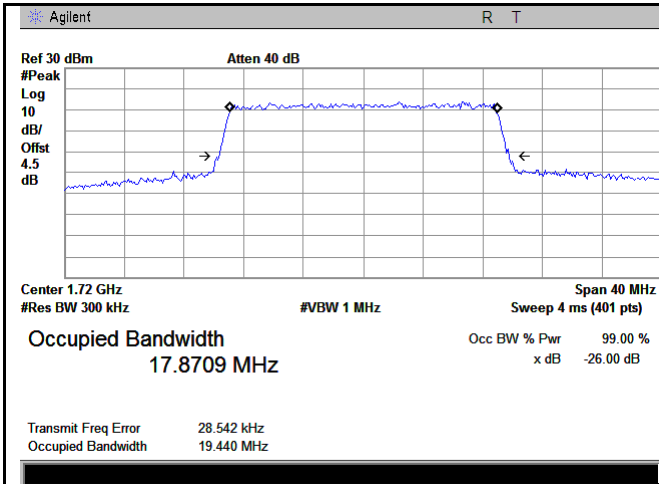

LTE band IV - Low CH QPSK-20

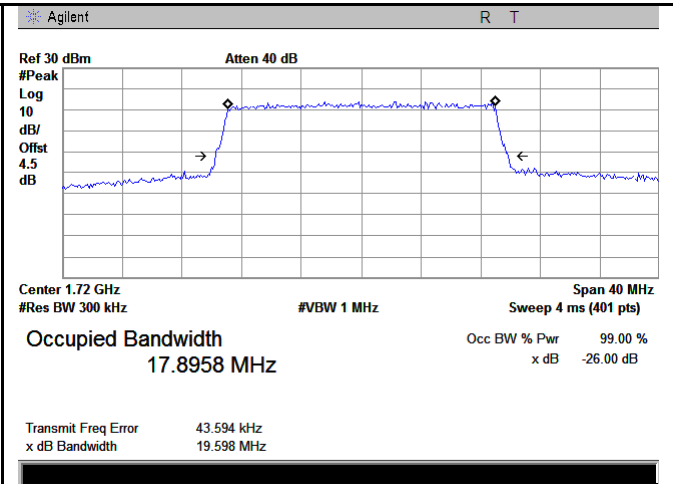

LTE band IV - Low CH 16QAM-20

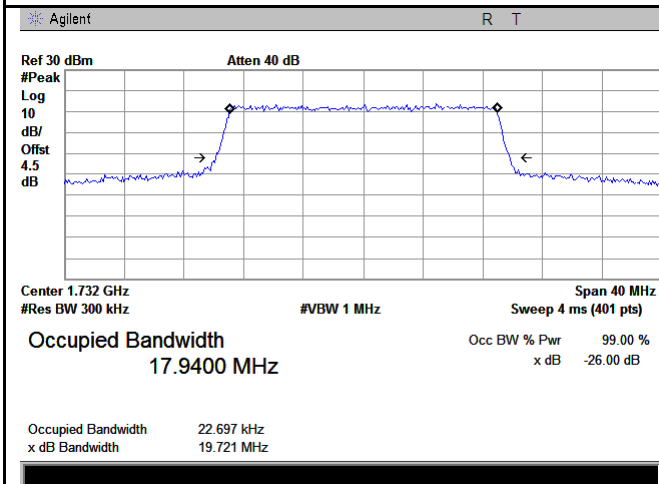

LTE band IV - Middle CH QPSK-20

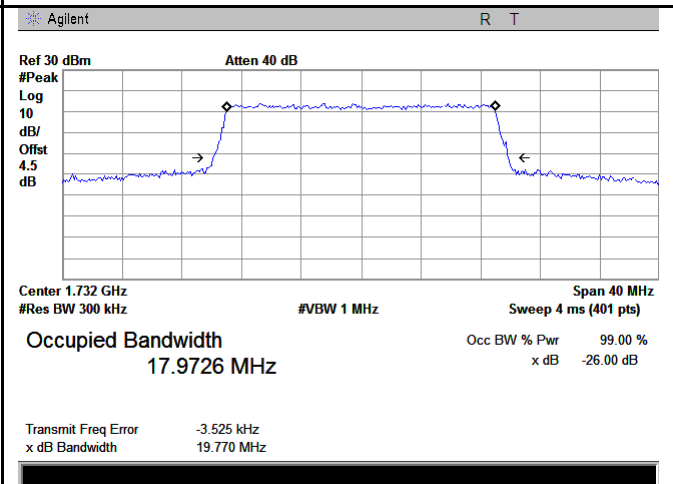

LTE band IV - Middle CH 16QAM-20

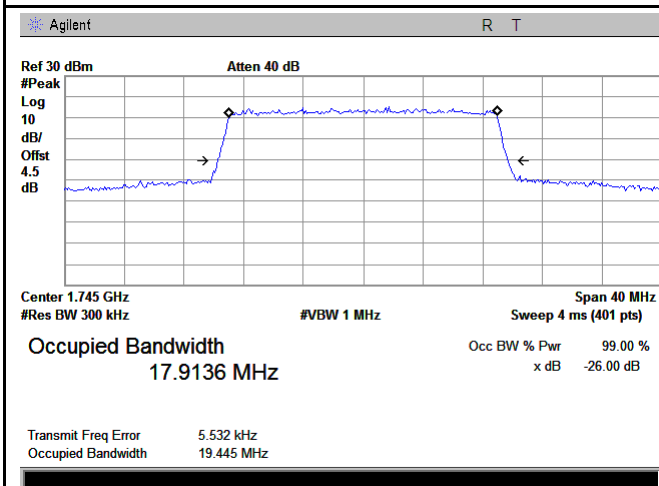

LTE band IV - High CH QPSK-20

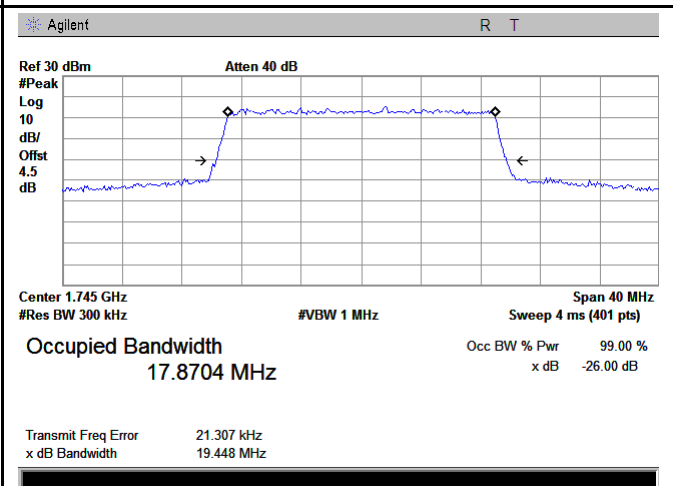

LTE band IV - High CH 16QAM-20

LTE band VII (Part 27)

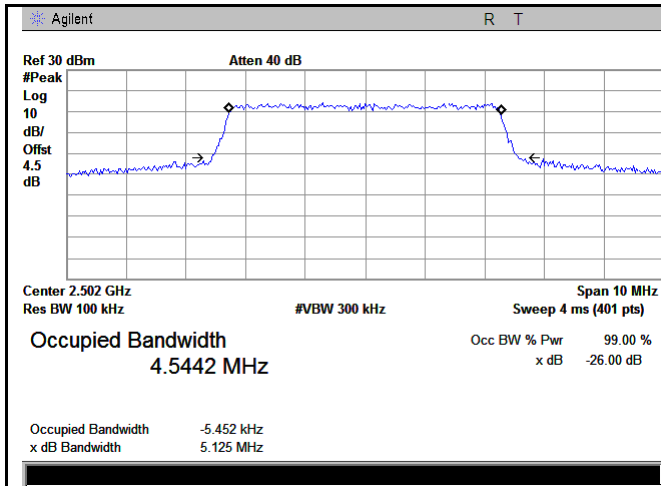

LTE band VII - Low CH QPSK-5

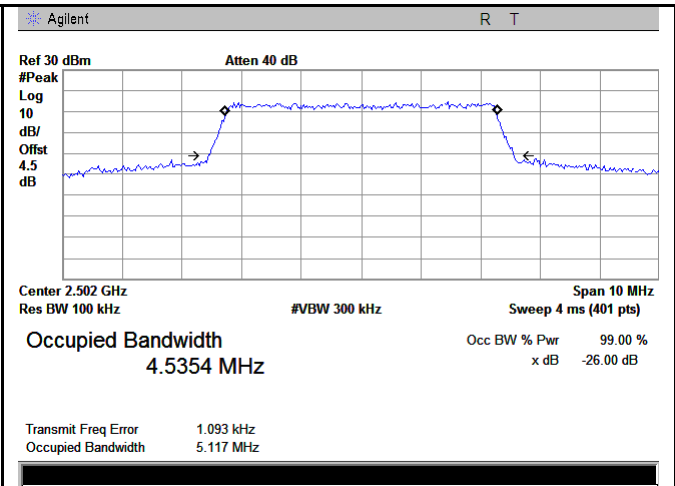

LTE band VII - Low CH 16QAM-5

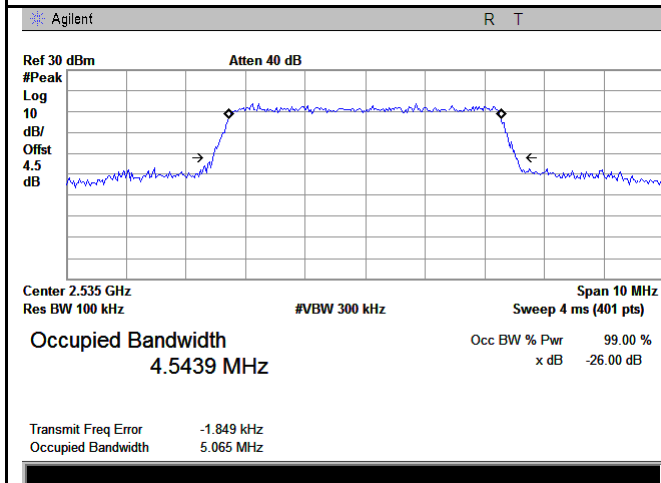

LTE band VII - Middle CH QPSK-5

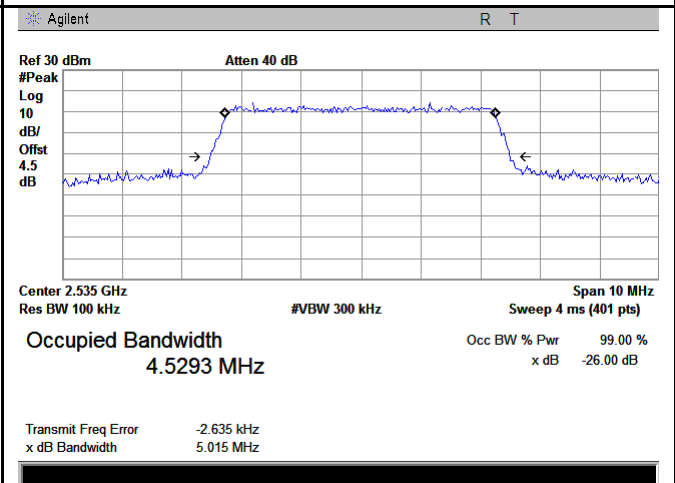

LTE band VII - Middle CH 16QAM-5

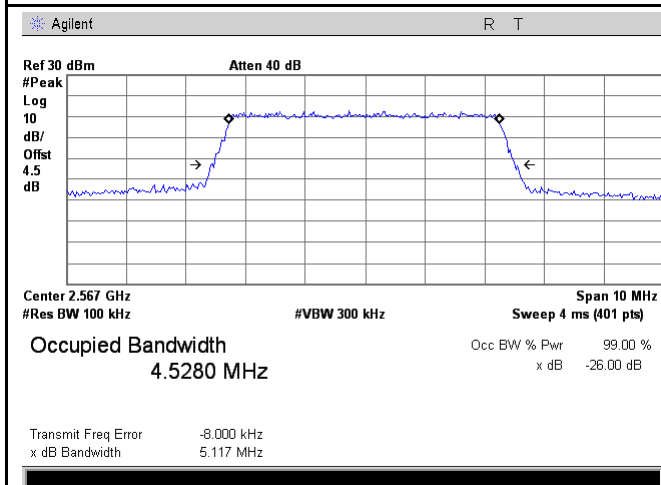

LTE band VII - High CH QPSK-5

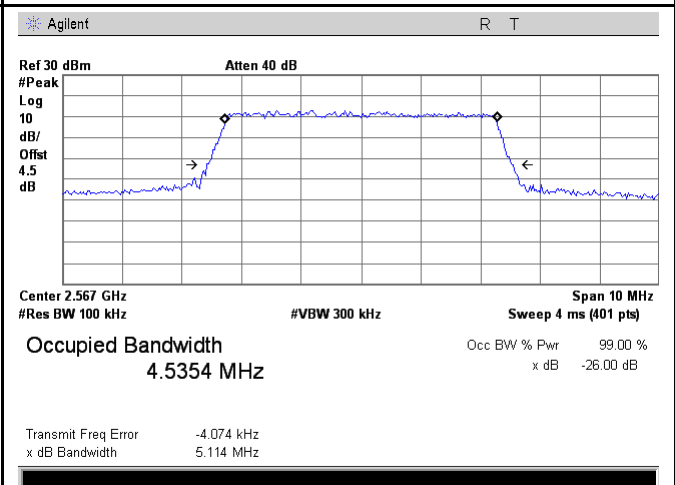

LTE band VII - High CH 16QAM-5

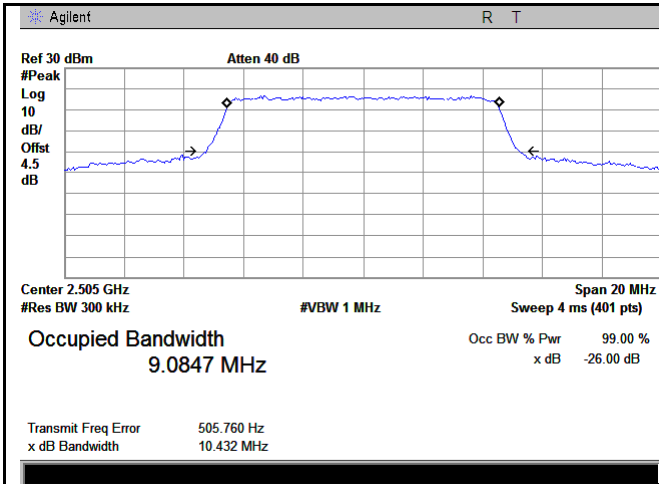

LTE band VII - Low CH QPSK-10

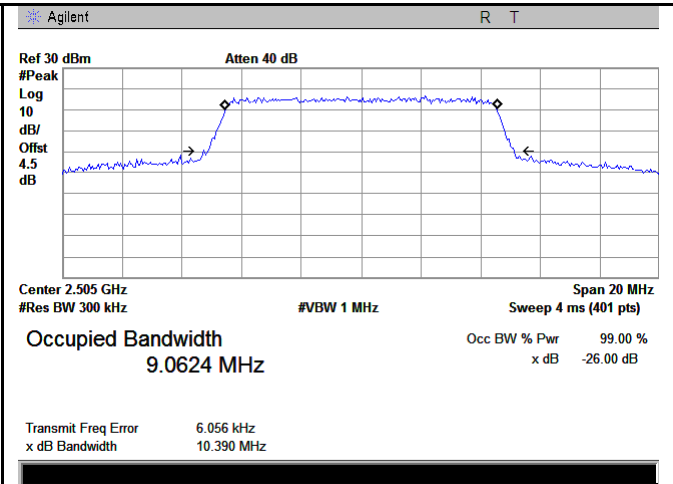

LTE band VII - Low CH 16QAM-10

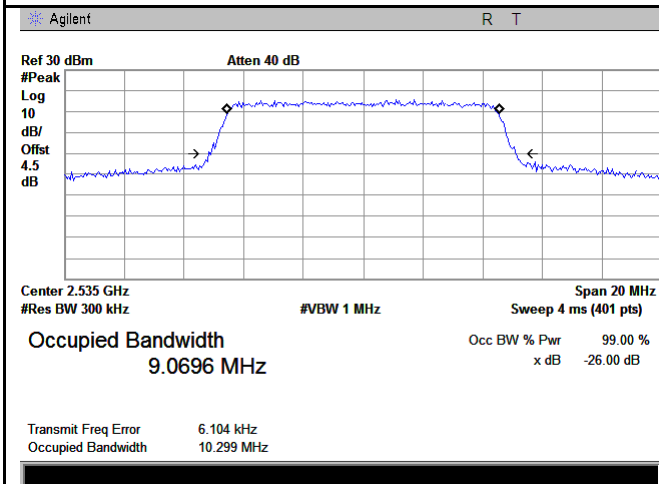

LTE band VII - Middle CH QPSK-10

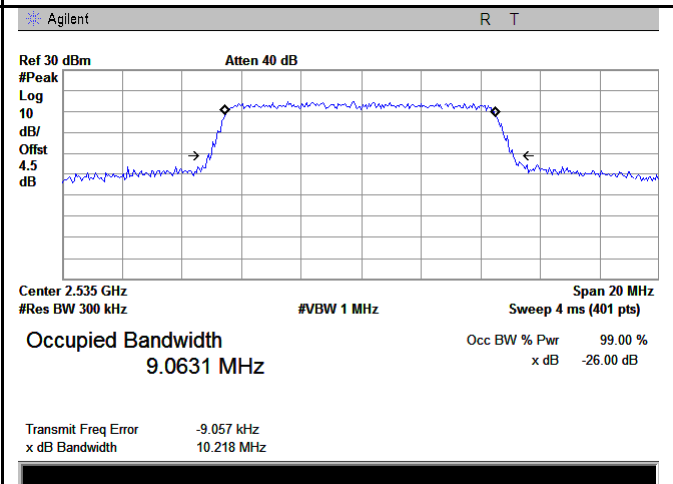

LTE band VII - Middle CH 16QAM-10

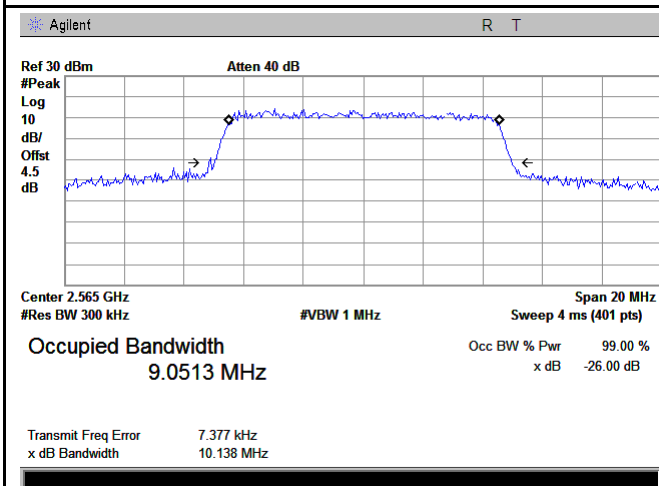

LTE band VII - High CH QPSK-10

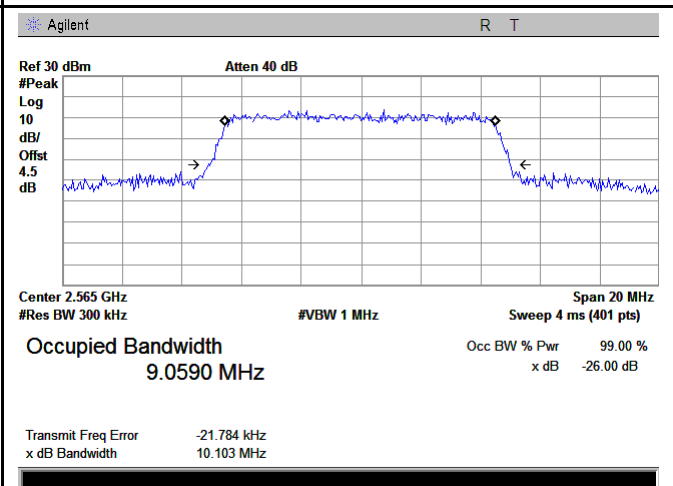

LTE band VII - High CH 16QAM-10

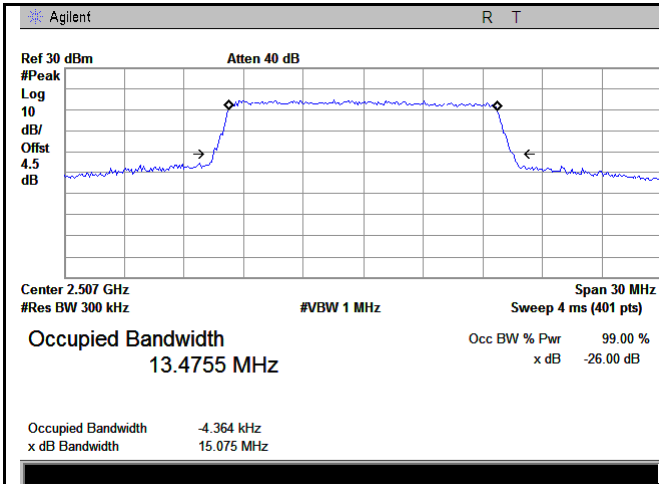

LTE band VII - Low CH QPSK-15

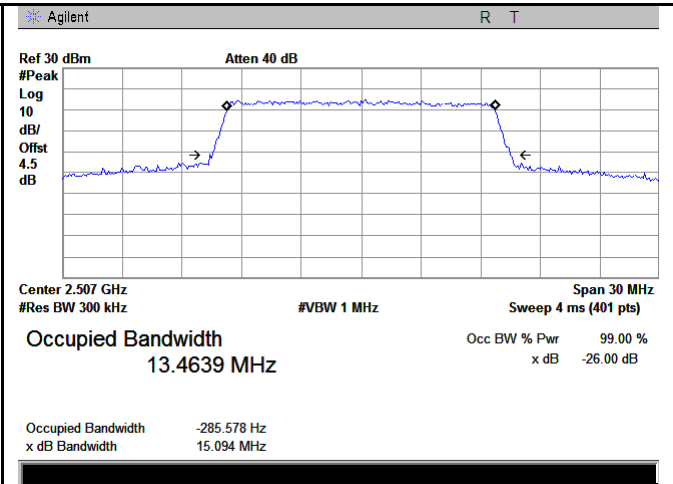

LTE band VII - Low CH 16QAM-15

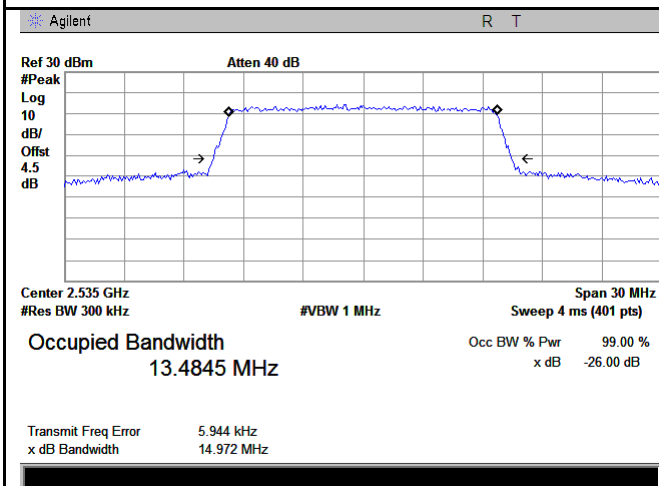

LTE band VII - Middle CH QPSK-15

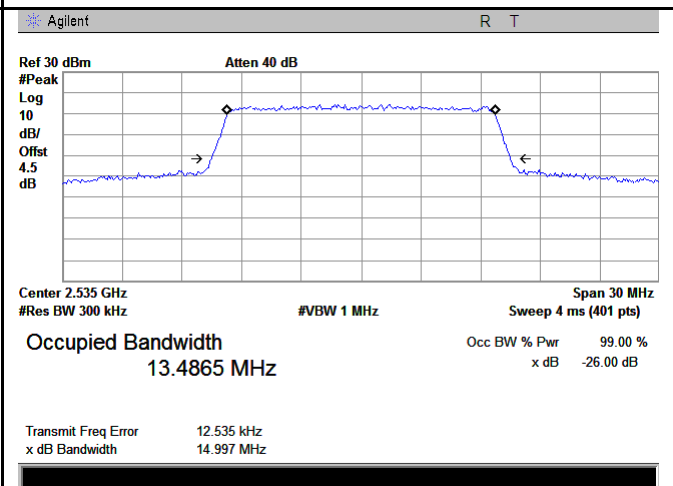

LTE band VII - Middle CH 16QAM-15

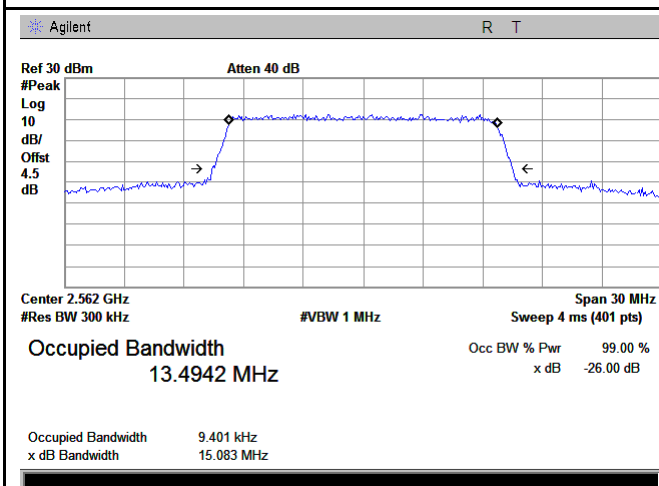

LTE band VII - High CH QPSK-15

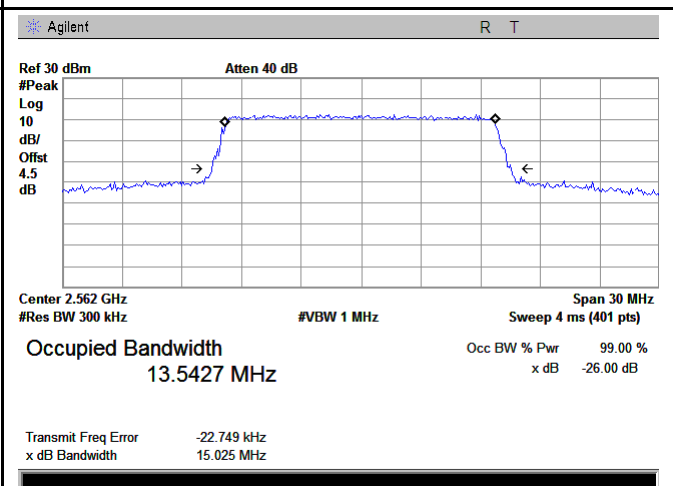

LTE band VII - High CH 16QAM-15

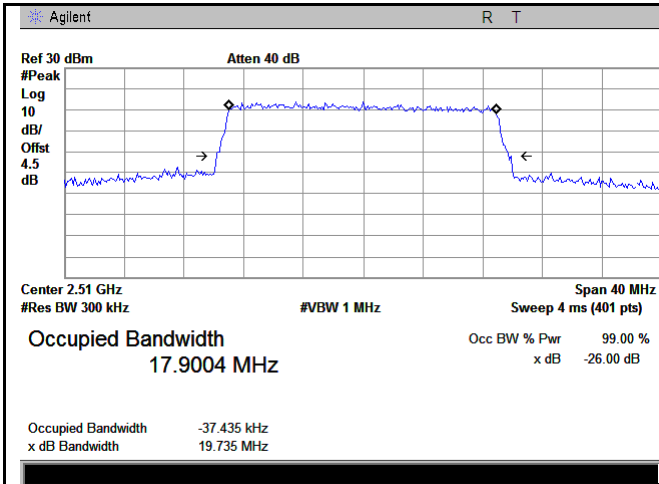

LTE band VII - Low CH QPSK-20

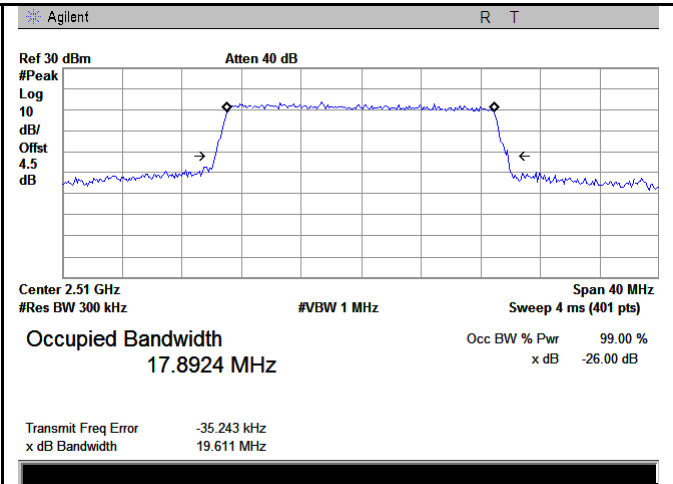

LTE band VII - Low CH 16QAM-20

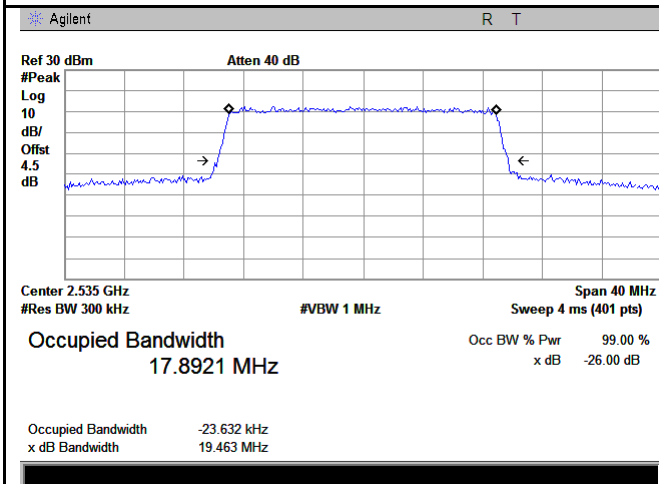

LTE band VII - Middle CH QPSK-20

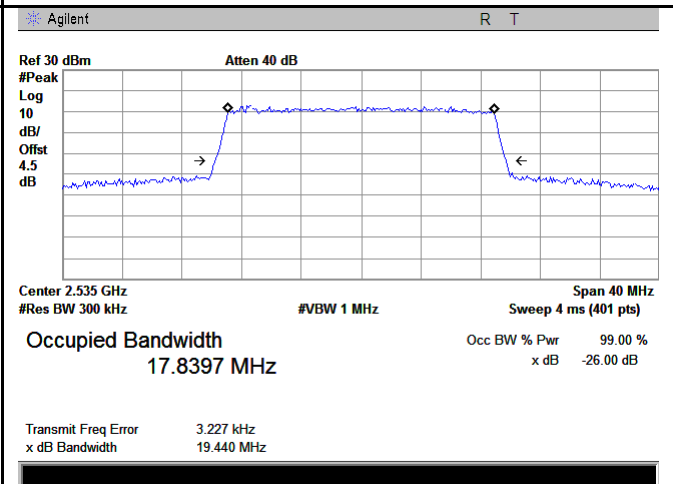

LTE band VII - Middle CH 16QAM-20

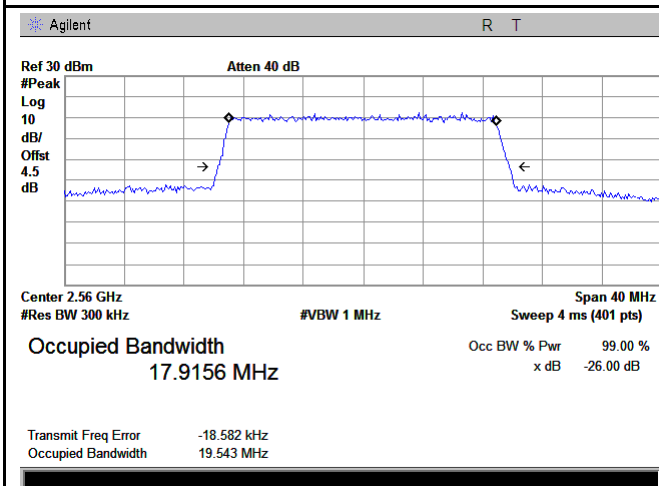

LTE band VII - High CH QPSK-20

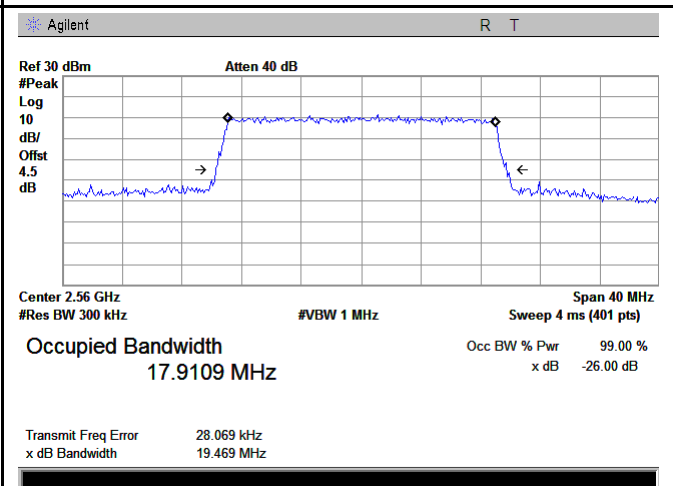

LTE band VII - High CH 16QAM-20

6.5 Spurious Emissions at Antenna Terminals

Temperature	25°C
Relative Humidity	57%
Atmospheric Pressure	1023mbar
Test date :	October 27, 2017
Tested By :	Loren Luo

Requirement(s):

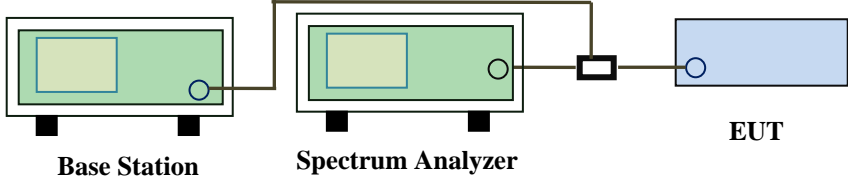
Spec	Item	Requirement	Applicable
§2.1051, §22.917(a)& §24.238(a) § 27.53(h)	a)	The power of any emission outside of the authorized operating frequency ranges must be lower than the transmitter power (P) by a factor of at least $43 + 10 \log(P)$ dB	<input checked="" type="checkbox"/>
Test Setup	 <p style="text-align: center;">Base Station Spectrum Analyzer EUT</p>		
Test Procedure	<ul style="list-style-type: none"> - The EUT was connected to Spectrum Analyzer and Base Station via power divider. - The Band Edges of low and high channels for the highest RF powers were measured. - Setting RBW as roughly BW/100. 		
Remark			
Result	<input checked="" type="checkbox"/> Pass <input type="checkbox"/> Fail		

Test Data Yes N/A
 Test Plot Yes (See below) N/A

Test Plots 30MHz-5GHz
LTE band II (Part 24E)

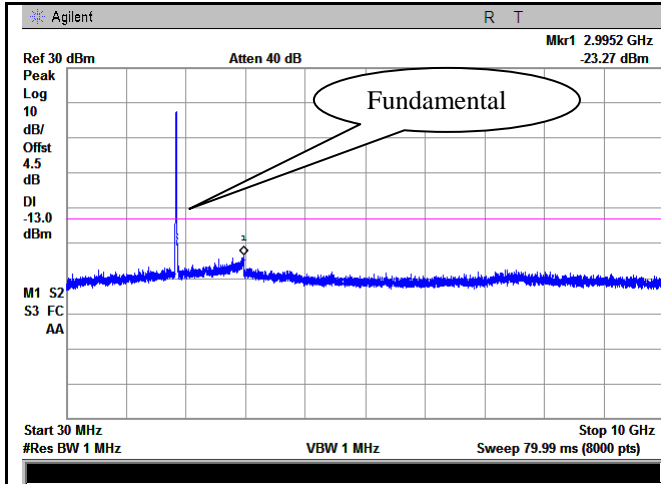

LTE band II - Low Channel-1

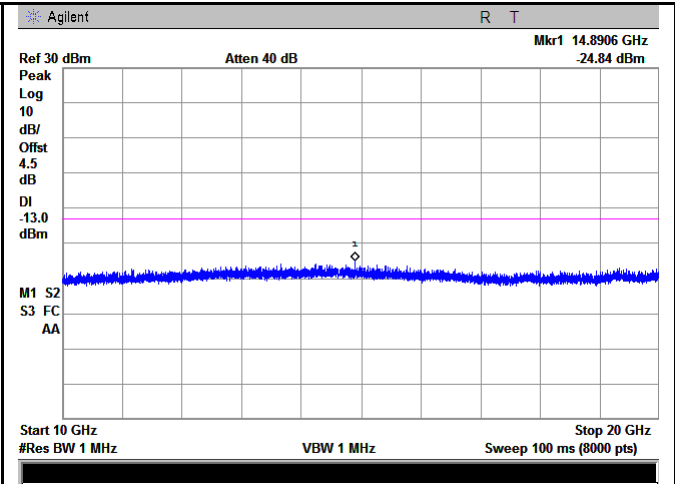

LTE band II - Low Channel-2

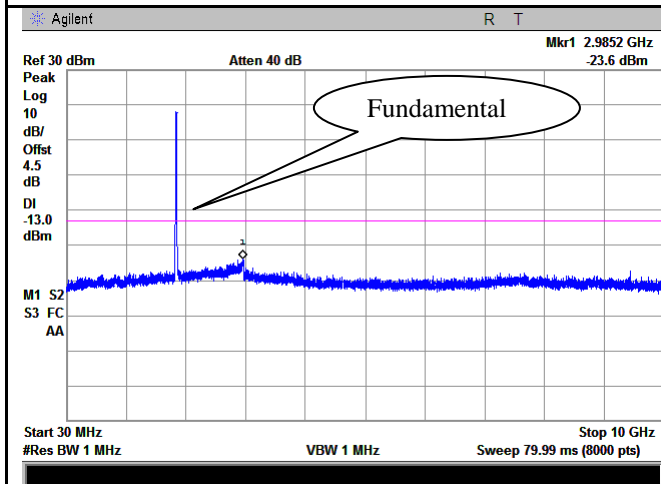

LTE band II Middle Channel-1

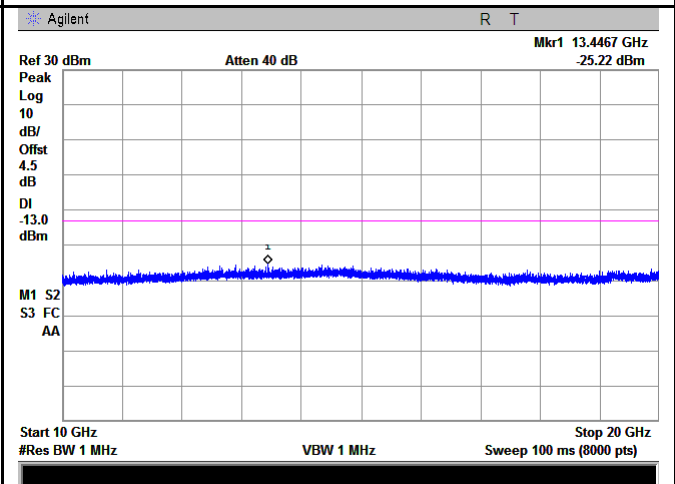

LTE band II Middle Channel-2

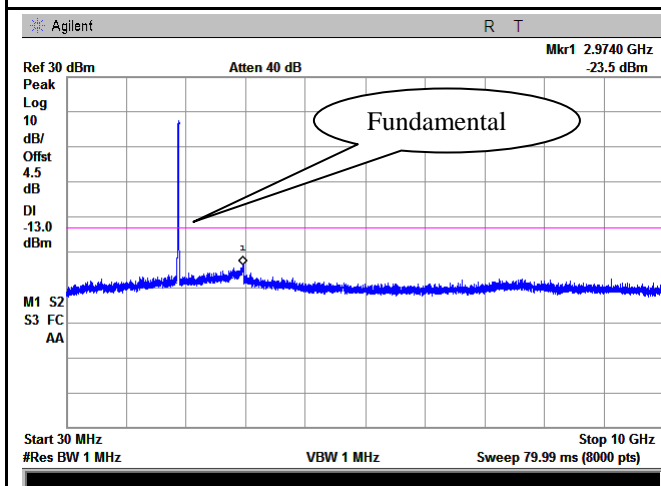

LTE band II - High Channel-1

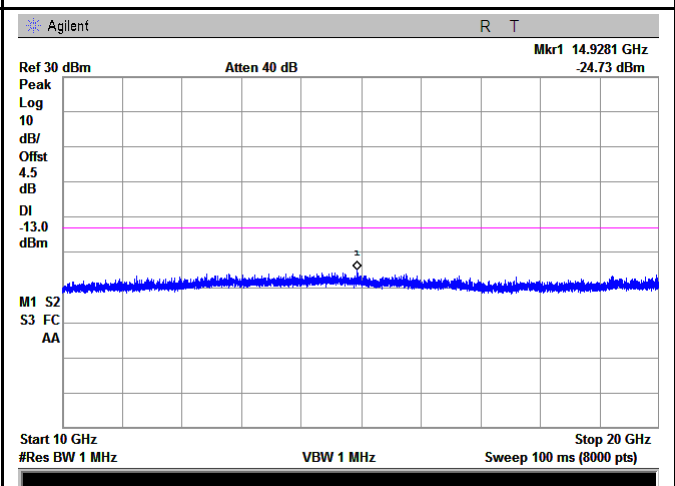

LTE band II - High Channel-2

LTE band IV (Part27) result

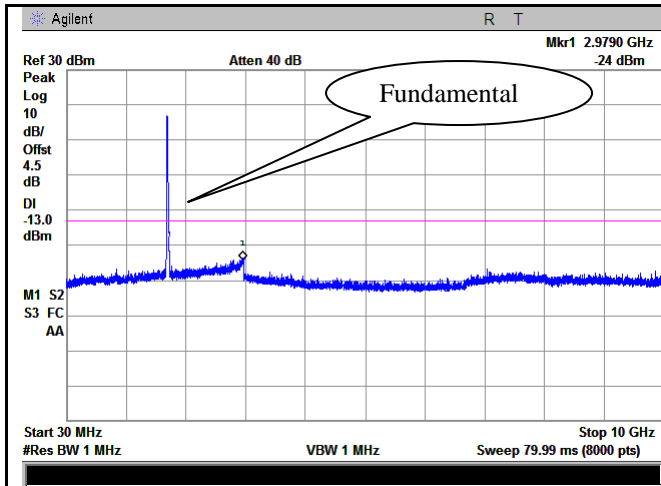

LTE band IV - Low Channel-1

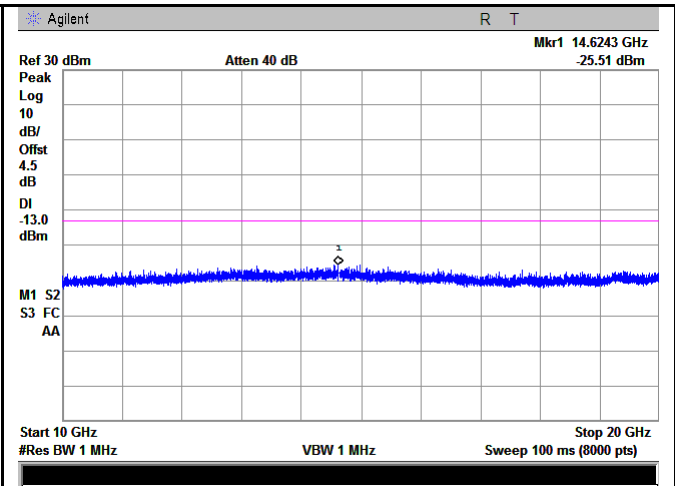

LTE band IV - Low Channel-2

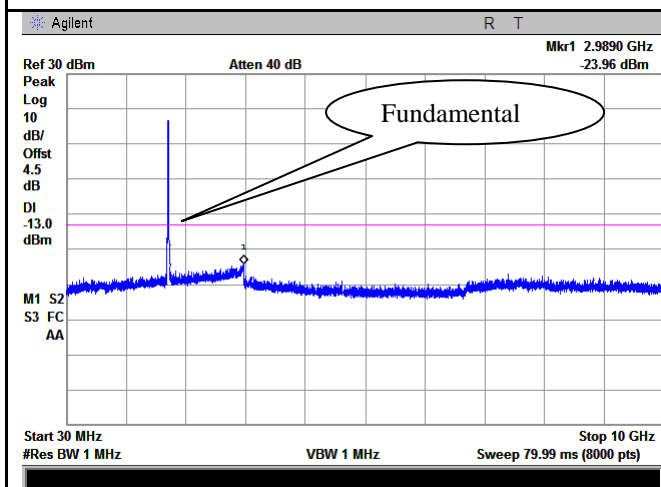

LTE band IV - Middle Channel-1

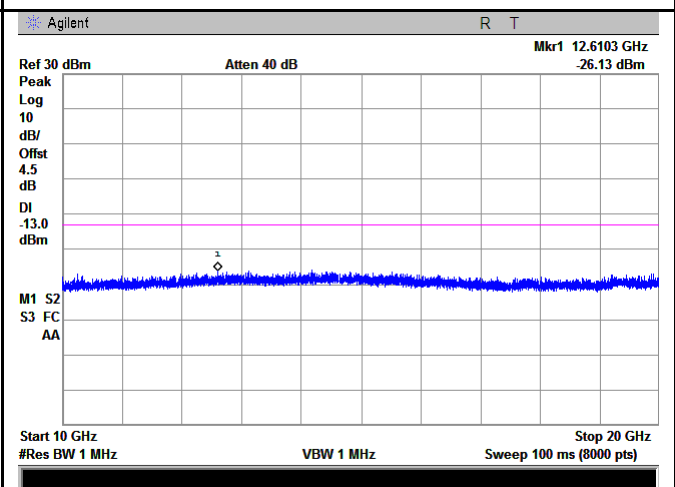

LTE band IV - Middle Channel-2

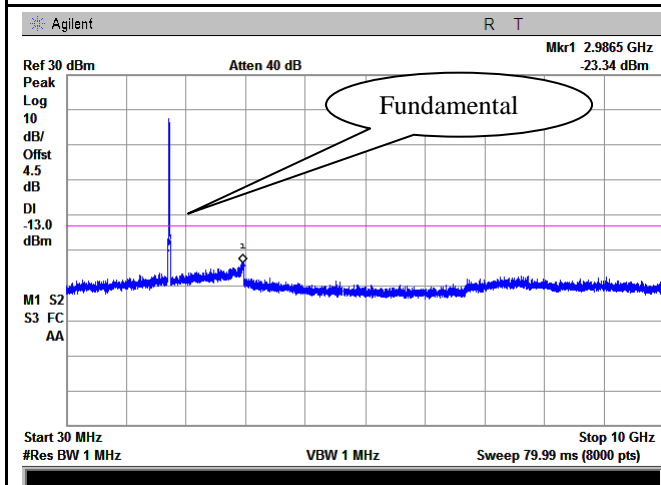

LTE band IV - High Channel-1

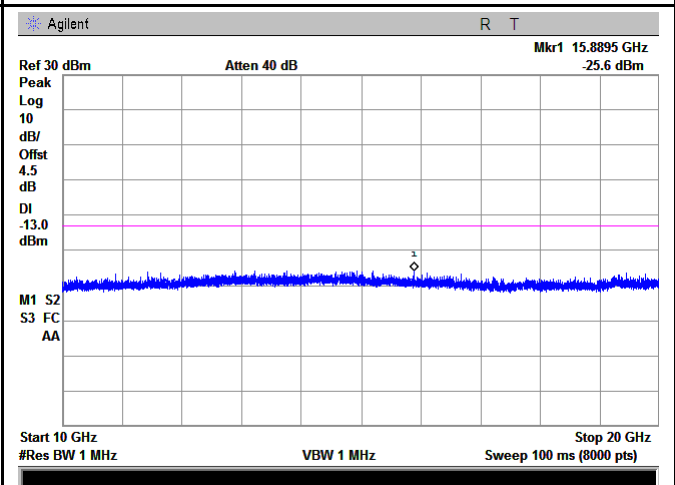

LTE band IV - High Channel-2

LTE band VII (Part 27)

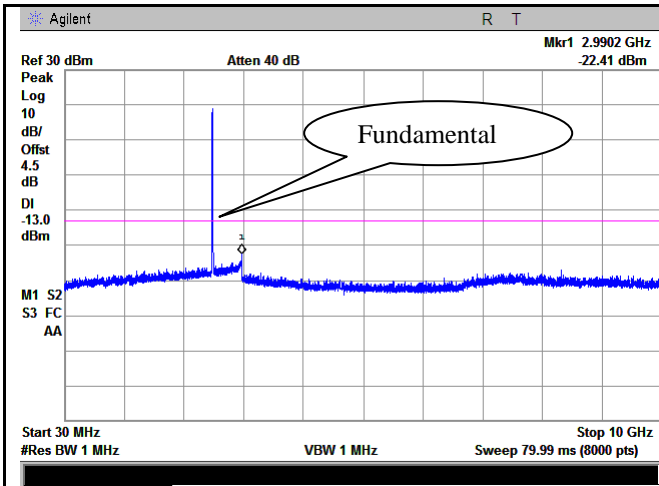

LTE band VII - Low Channel-1

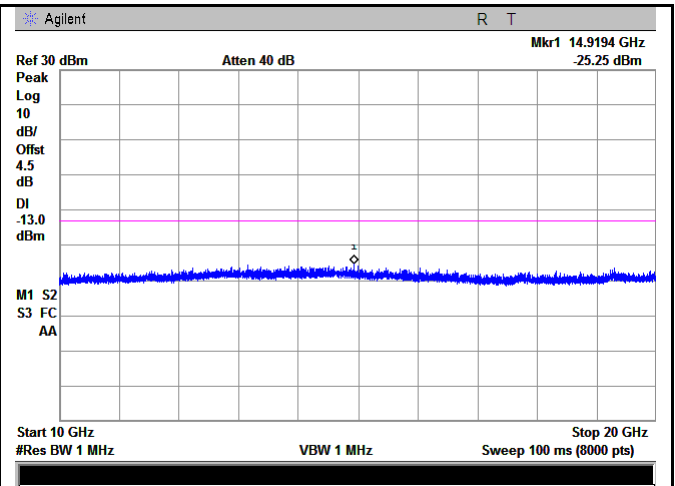

LTE band VII - Low Channel-2

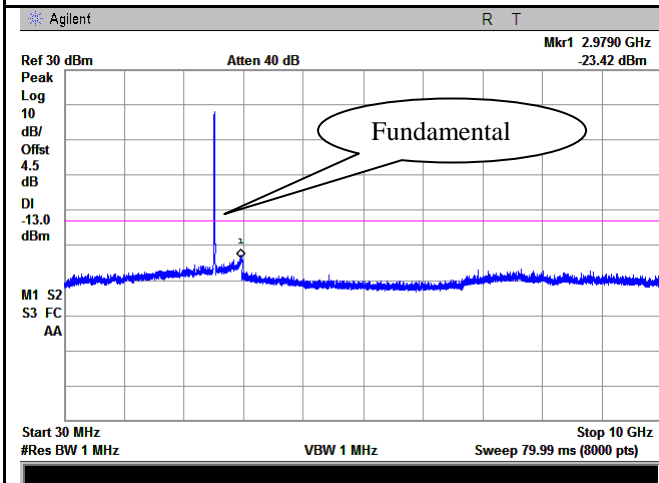

LTE band VII - Middle Channel-1

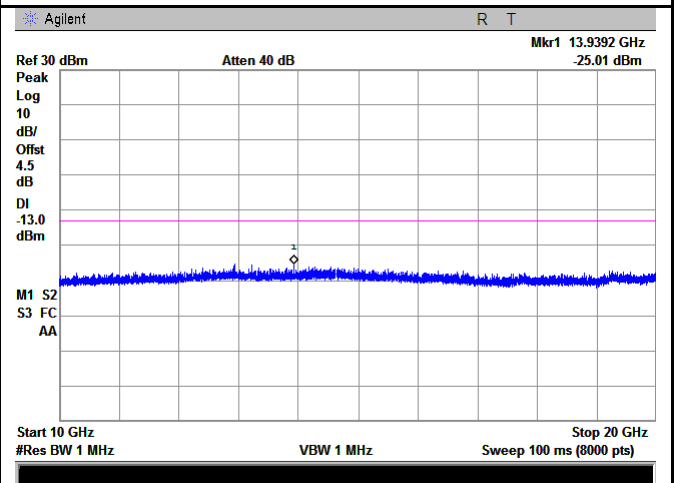

LTE band VII - Middle Channel-2

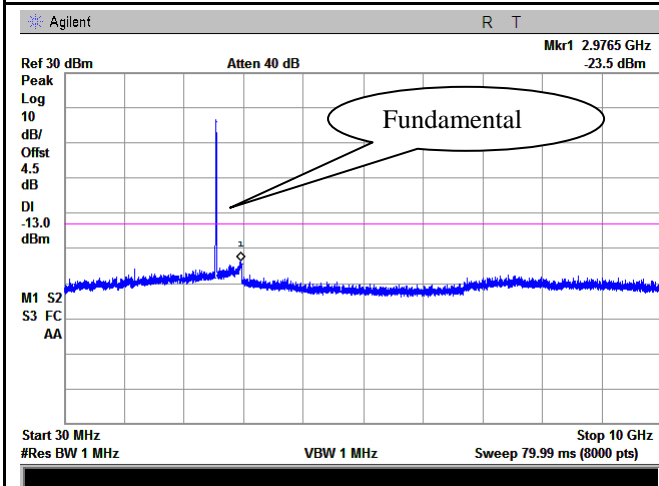

LTE band VII - High Channel-1

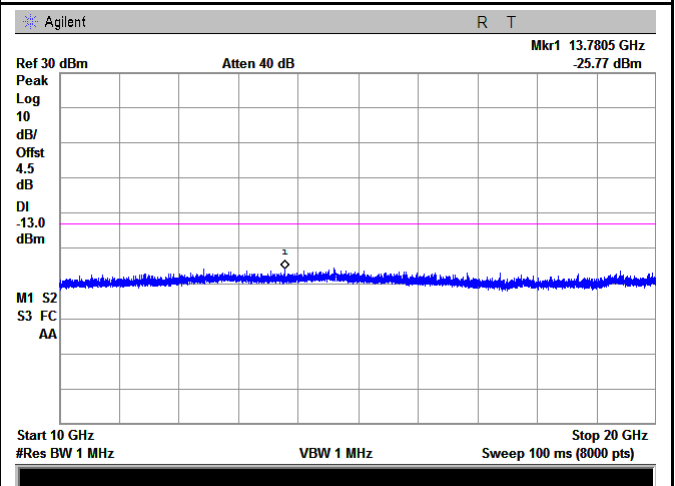

LTE band VII - High Channel-2

6.6 Spurious Radiated Emissions

Temperature	24°C
Relative Humidity	54%
Atmospheric Pressure	1020mbar
Test date :	October 29, 2017
Tested By :	Loren Luo

Requirement(s):

Spec	Item	Requirement	Applicable
§2.1053, §22.917 & §24.238 § 27.53(h)	a)	The power of any emission outside of the authorized operating frequency ranges must be attenuated below the transmitter power (P) by a factor of at least $43 + 10 \log (P)$ dB. The spectrum is scanned from 30 MHz up to a frequency including its 10th harmonic.	<input checked="" type="checkbox"/>

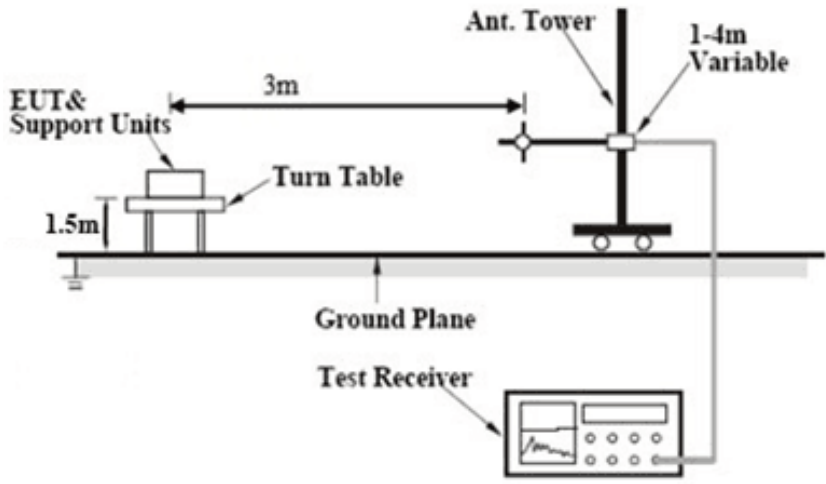
Test setup	
------------	--

Test Procedure	<ol style="list-style-type: none"> The transmitter was placed on a wooden turntable, and it was transmitting into a non-radiating load which was also placed on the turntable. The measurement antenna was placed at a distance of 3 meters from the EUT. During the tests, the antenna height and polarization as well as EUT azimuth were varied in order to identify the maximum level of emissions from the EUT. The test was performed by placing the EUT on 3-orthogonal axis. Remove the EUT and replace it with substitution antenna. A signal generator was connected to the substitution antenna by a non-radiating cable. The absolute levels of the spurious emissions were measured by the substitution. Sample Calculation: EUT Field Strength = Raw Amplitude (dBµV/m) – Amplifier Gain (dB) + Antenna
----------------	--

Test Report	17071091-FCC-R5
Page	66 of 111

	Factor (dB) + Cable Loss (dB) + Filter Attenuation (dB, if used)
Remark	
Result	<input checked="" type="checkbox"/> Pass <input type="checkbox"/> Fail

Test Data Yes N/A

Test Plot Yes (See below) N/A

LTE band II (Part 24E) result

Low channel

Frequency (MHz)	Substituted level (dBm)	Polarity (H/V)	Antenna Gain Correction (dB)	Cable Loss (dB)	Corrected Reading (dBm)	Limit (dBm)	Margin (dB)
3720	-39.97	V	10.25	2.73	-32.45	-13	-19.45
3720	-45.74	H	10.25	2.73	-38.22	-13	-25.22
287.2	-39.08	V	5.6	0.22	-33.7	-13	-20.7
412	-42.8	H	6.1	0.24	-36.94	-13	-23.94

Middle channel

Frequency (MHz)	Substituted level (dBm)	Polarity (H/V)	Antenna Gain Correction (dB)	Cable Loss (dB)	Corrected Reading (dBm)	Limit (dBm)	Margin (dB)
3760	-40.67	V	10.25	2.73	-33.15	-13	-20.15
3760	-38.48	H	10.25	2.73	-30.96	-13	-17.96
945.6	-37.73	V	6.29	0.44	-31.88	-13	-18.88
500	-42.46	H	6.05	0.35	-36.76	-13	-23.76

High channel

Frequency (MHz)	Substituted level (dBm)	Polarity (H/V)	Antenna Gain Correction (dB)	Cable Loss (dB)	Corrected Reading (dBm)	Limit (dBm)	Margin (dB)
3800	-46.22	V	10.36	2.73	-38.59	-13	-25.59
3800	-40.95	H	10.36	2.73	-33.32	-13	-20.32
620.5	-40.22	V	6.2	0.32	-34.34	-13	-21.34
757.5	-42.67	H	6.43	0.44	-36.68	-13	-23.68

Note:

- 1, The testing has been conformed to $10 \times 1907.5 \text{ MHz} = 19,075 \text{ MHz}$
- 2, All other emissions more than 30 dB below the limit
- 3, X-Axis, Y-Axis and -Axis were investigated. The results above show only the worst case.
- 4, The radiated spurious test above 18GHz is subcontracted to SIEMIC (Nanjing-China) Laboratories. and found 30dB below the limit at least.

LTE band IV(Part27) result

Low channel

Frequency (MHz)	Substituted level (dBm)	Polarity (H/V)	Antenna Gain Correction (dB)	Cable Loss (dB)	Corrected Reading (dBm)	Limit (dBm)	Margin (dB)
3440	-43.3	V	10.06	2.52	-35.76	-13	-22.76
3440	-38.55	H	10.06	2.52	-31.01	-13	-18.01
626.8	-46.22	V	6.19	0.36	-40.39	-13	-27.39
354.5	-43.22	H	5.89	0.27	-37.6	-13	-24.6

Middle channel

Frequency (MHz)	Substituted level (dBm)	Polarity (H/V)	Antenna Gain Correction (dB)	Cable Loss (dB)	Corrected Reading (dBm)	Limit (dBm)	Margin (dB)
3465	-46.02	V	10.09	2.52	-38.45	-13	-25.45
3465	-39.54	H	10.09	2.52	-31.97	-13	-18.97
69.4	-40.86	V	-1.02	0.08	-41.96	-13	-28.96
564.1	-40	H	6.3	0.33	-34.03	-13	-21.03

High channel

Frequency (MHz)	Substituted level (dBm)	Polarity (H/V)	Antenna Gain Correction (dB)	Cable Loss (dB)	Corrected Reading (dBm)	Limit (dBm)	Margin (dB)
3490	-41.96	V	10.09	2.52	-34.39	-13	-21.39
3490	-41.88	H	10.09	2.52	-34.31	-13	-21.31
97.3	-45.21	V	-0.19	0.16	-45.56	-13	-32.56
809.1	-37.68	H	6.04	0.5	-32.14	-13	-19.14

Note:

- 1, The testing has been conformed to $10 \times 1752.5\text{MHz} = 17,525\text{MHz}$
- 2, All other emissions more than 30 dB below the limit
- 3, X-Axis, Y-Axis and -Axis were investigated. The results above show only the worst case.

LTE band VII(Part27) result

Low channel

Frequency (MHz)	Substituted level (dBm)	Polarity (H/V)	Antenna Gain Correction (dB)	Cable Loss (dB)	Corrected Reading (dBm)	Limit (dBm)	Margin (dB)
5020	-37.98	V	10.29	0.98	-28.67	-13	-15.67
5020	-40.41	H	10.29	0.98	-31.1	-13	-18.1
886.7	-38.56	V	6.11	0.43	-32.88	-13	-19.88
969	-43.52	H	6.35	0.51	-37.68	-13	-24.68

Middle channel

Frequency (MHz)	Substituted level (dBm)	Polarity (H/V)	Antenna Gain Correction (dB)	Cable Loss (dB)	Corrected Reading (dBm)	Limit (dBm)	Margin (dB)
5070	-44.3	V	10.3	0.99	-34.99	-13	-21.99
5070	-37.3	H	10.3	0.99	-27.99	-13	-14.99
625.4	-41.3	V	6.17	0.37	-35.5	-13	-22.5
106	-41.31	H	-0.16	0.18	-41.65	-13	-28.65

High channel

Frequency (MHz)	Substituted level (dBm)	Polarity (H/V)	Antenna Gain Correction (dB)	Cable Loss (dB)	Corrected Reading (dBm)	Limit (dBm)	Margin (dB)
5120	-39.33	V	10.32	1	-30.01	-13	-17.01
5120	-45.18	H	10.32	1	-35.86	-13	-22.86
89.2	-44.38	V	1.31	0.16	-43.23	-13	-30.23
815.1	-44.67	H	6.17	0.44	-38.94	-13	-25.94

Note:

1, The testing has been conformed to $10 \times 2567.5 \text{ MHz} = 25,675 \text{ MHz}$

2, All other emissions more than 30 dB below the limit

3, X-Axis, Y-Axis and -Axis were investigated. The results above show only the worst case.

4, The radiated spurious test above 18GHz is subcontracted to SIEMIC (Nanjing-China) Laboratories. and found 30dB below the limit at least.

6.7 Band Edge

Temperature	25°C
Relative Humidity	57%
Atmospheric Pressure	1023mbar
Test date :	October 27, 2017
Tested By :	Loren Luo

Requirement(s):

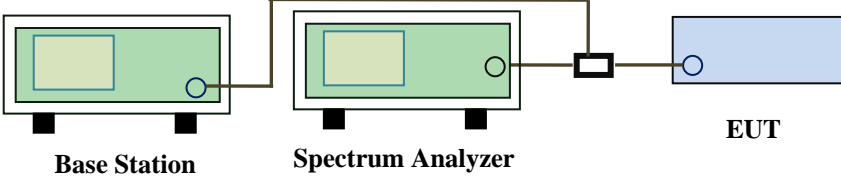
Spec	Item	Requirement	Applicable
§22.917(a) §24.238(a) § 27.53(h)	a)	The power of any emission outside of the authorized operating frequency ranges must be lower than the transmitter power (P) by a factor of at least $43 + 10 \log (P)$ dB.	<input checked="" type="checkbox"/>
Test setup	 <p>The diagram shows a Base Station (green box) connected to a Spectrum Analyzer (green box) and an EUT (blue box) via a power divider (black box). The Base Station and Spectrum Analyzer are connected to each other, and the Spectrum Analyzer is connected to the power divider, which then splits the signal to the EUT.</p>		
Procedure	<ul style="list-style-type: none"> - The EUT was connected to Spectrum Analyzer and Base Station via power divider. - The Band Edges of low and high channels for the highest RF powers were measured. Setting RBW as roughly BW/100. 		
Remark			
Result	<input checked="" type="checkbox"/> Pass <input type="checkbox"/> Fail		

Test Data Yes N/A

Test Plot Yes (See below) N/A

LTE band II (Part 24E) result

BW(MHz)	Channel	Frequency (MHz)	Mode	Emission (dBm)	Limit (dBm)
1.4	18607	1850	QPSK	-14.65	-13
			16QAM	-14.62	-13
1.4	18900	1910	QPSK	-20.96	-13
			16QAM	-20.34	-13
3	18615	1850	QPSK	-13.87	-13
			16QAM	-13.93	-13
3	19185	1910	QPSK	-16.63	-13
			16QAM	-17.89	-13
5	18625	1850	QPSK	-13.94	-13
			16QAM	-14.25	-13
5	19175	1910	QPSK	-16.41	-13
			16QAM	-17.38	-13
10	18650	1850	QPSK	-14.66	-13
			16QAM	-14.22	-13
10	19150	1910	QPSK	-17.46	-13
			16QAM	-17.11	-13
15	18675	1850	QPSK	-16.25	-13
			16QAM	-14.66	-13
15	19125	1910	QPSK	-19.06	-13
			16QAM	-18.90	-13
20	18700	1848	QPSK	-18.09	-13
			16QAM	-17.17	-13
20	19100	1911	QPSK	-20.90	-13
			16QAM	-20.03	-13

LTE band IV (Part 27) result

BW(MHz)	Channel	Frequency (MHz)	Mode	Emission (dBm)	Limit (dBm)
1.4	19957	1710	QPSK	-23.52	-13
			16QAM	-22.77	-13
1.4	20393	1755	QPSK	-20.25	-13
			16QAM	-21.13	-13
3	19965	1710	QPSK	-18.80	-13
			16QAM	-18.47	-13
3	20385	1755	QPSK	-16.95	-13
			16QAM	-16.84	-13
5	19975	1710	QPSK	-17.99	-13
			16QAM	-18.01	-13
5	20375	1755	QPSK	-16.35	-13
			16QAM	-16.17	-13
10	20000	1710	QPSK	-20.03	-13
			16QAM	-19.62	-13
10	20350	1755	QPSK	-17.15	-13
			16QAM	-17.31	-13
15	20025	1710	QPSK	-20.19	-13
			16QAM	-18.33	-13
15	20325	1755	QPSK	-19.96	-13
			16QAM	-17.11	-13
20	20050	1710	QPSK	-19.90	-13
			16QAM	-21.06	-13
20	20300	1755	QPSK	-19.88	-13
			16QAM	-20.21	-13

Test Plots

LTE band II (Part 24E)

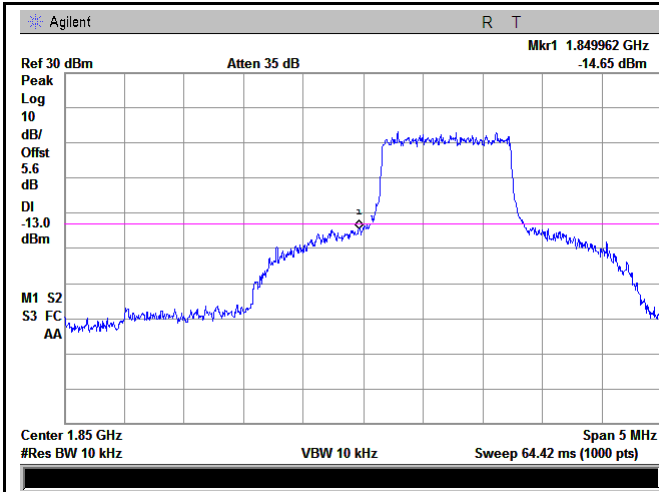

LTE band II - Low Channel QPSK-1.4

Note: Offset=Cable loss (4.5) + 10log
 $(13.01/10)=4.5+1.1=5.6\text{dB}$

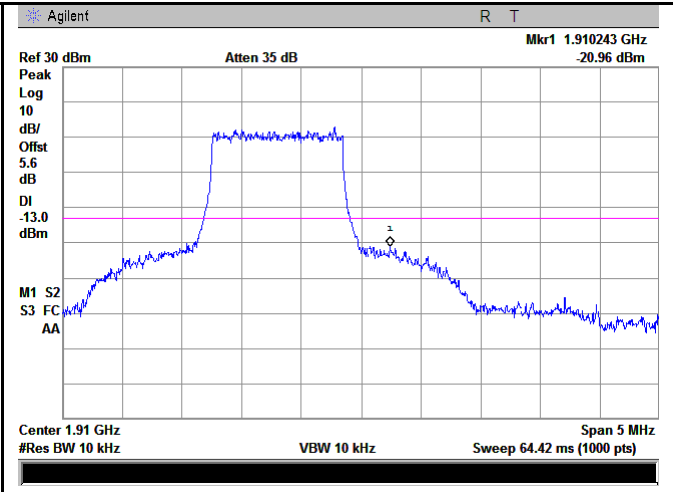

LTE band II - High Channel QPSK-1.4

Note: Offset=Cable loss (4.5) + 10log
 $(12.88/10)=4.5+1.1=5.6\text{dB}$

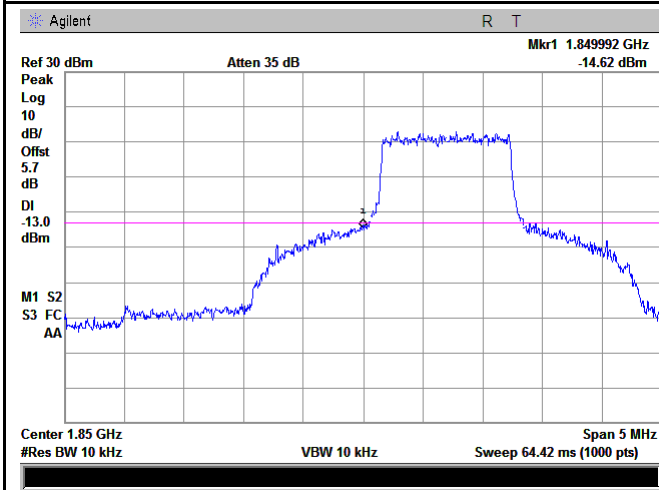

LTE band II - Low Channel 16QAM-1.4

Note: Offset=Cable loss (4.5) + 10log
 $(13.09/10)=4.5+1.2=5.7\text{ dB}$

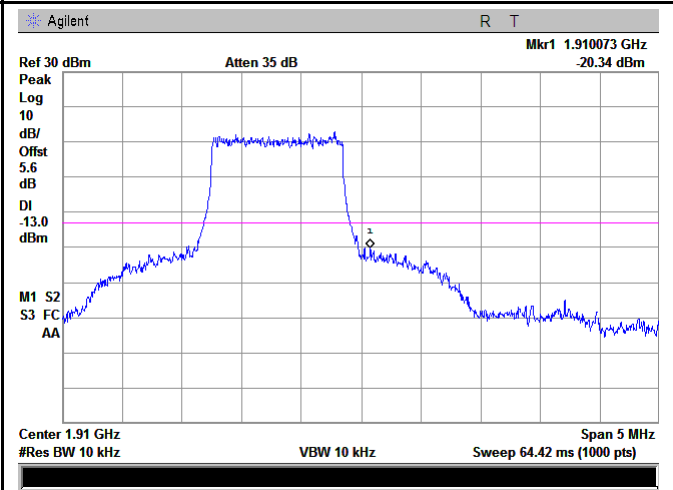

LTE band II - High Channel 16QAM-1.4

Note: Offset=Cable loss (4.5) + 10log
 $(12.91/10)=4.5+1.1=5.6\text{ dB}$

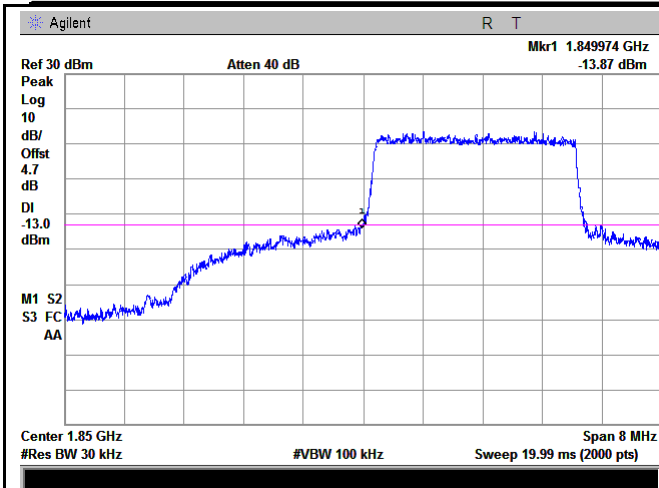

LTE band II - Low Channel QPSK-3

Note: Offset=Cable loss (4.5) + 10log
 $(31.26/30)=4.5+0.2=4.7\text{ dB}$

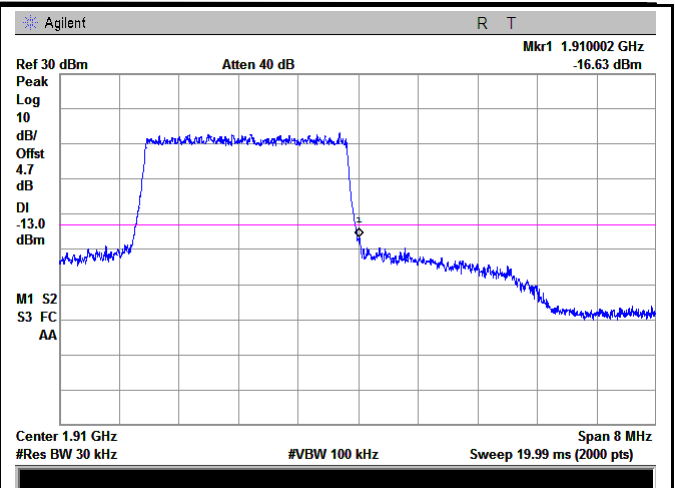

LTE band II - High Channel QPSK-3

Note: Offset=Cable loss (4.5) + 10log
 $(31.23/30)=4.5+0.2=4.7\text{ dB}$

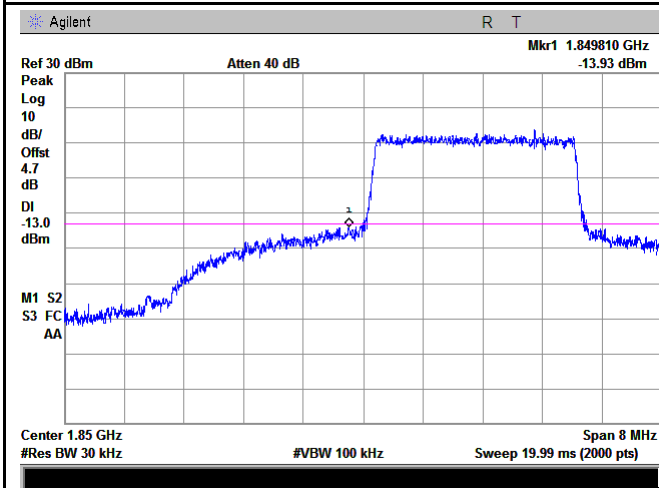

LTE band II - Low Channel 16QAM-3

Note: Offset=Cable loss (4.5) + 10log
 $(31.43/30)=4.5+0.2=4.7\text{ dB}$

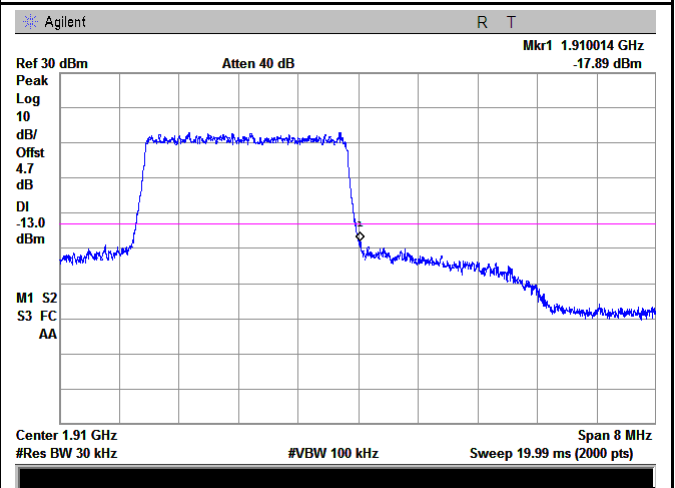

LTE band II - High Channel 16QAM-3

Note: Offset=Cable loss (4.5) + 10log
 $(31.36/30)=4.5+0.2=4.7\text{ dB}$

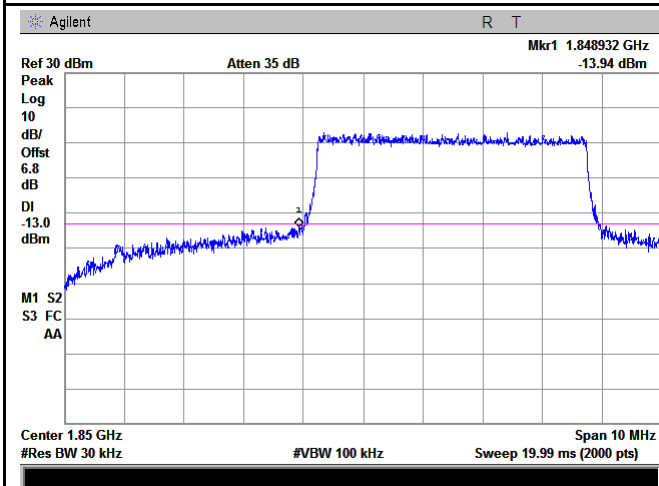

LTE band II - Low Channel QPSK-5

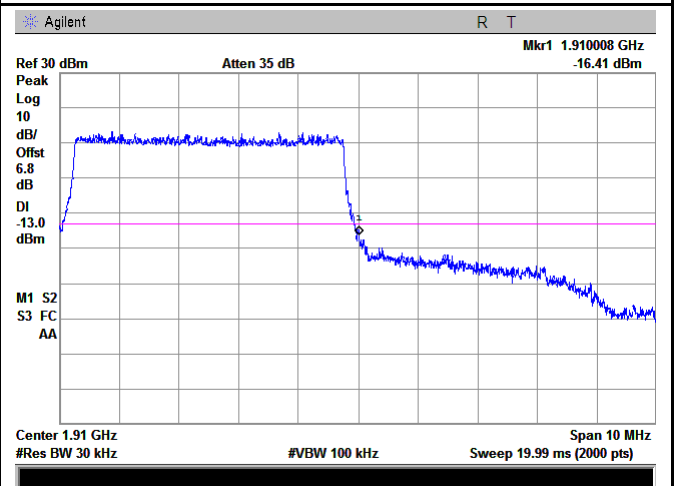

LTE band II - High Channel QPSK-5

Note: Offset=Cable loss (4.5) + 10log
 $(51.07/30)=4.5+2.3=6.8$ dB

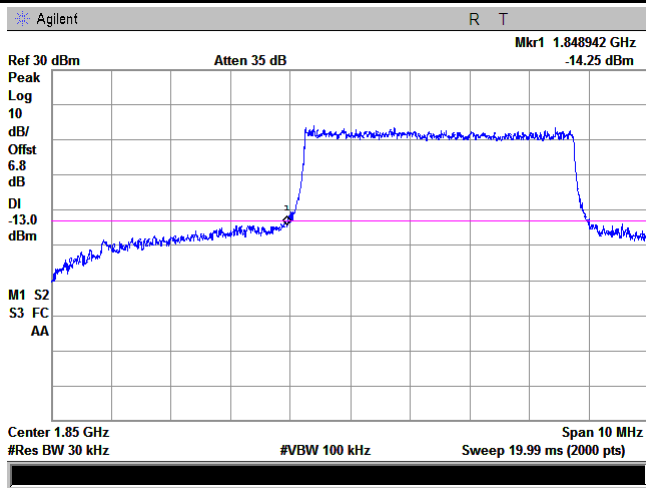

LTE band II - Low Channel 16QAM-5

Note: Offset=Cable loss (4.5) + 10log
 $(51.04/30)=4.5+2.3=6.8$ dB

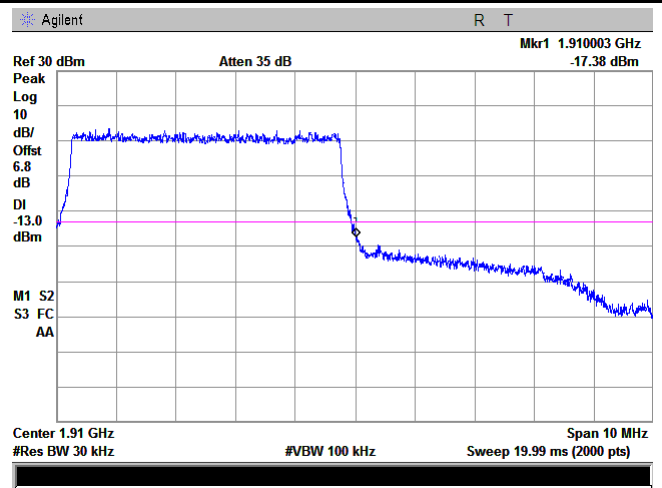

LTE band II - High Channel 16QAM-5

Note: Offset=Cable loss (4.5) + 10log
 $(51.11/30)=4.5+2.3=6.8$ dB

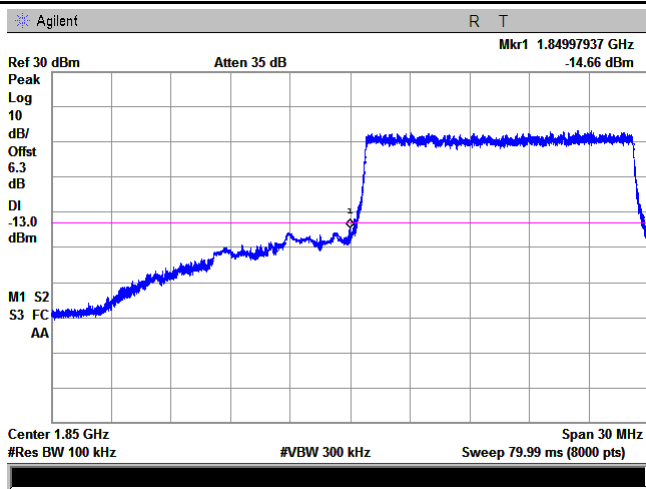

LTE band II - Low Channel QPSK-10

Note: Offset=Cable loss (4.5) + 10log
 $(51.28/30)=4.5+2.3=6.8$ dB

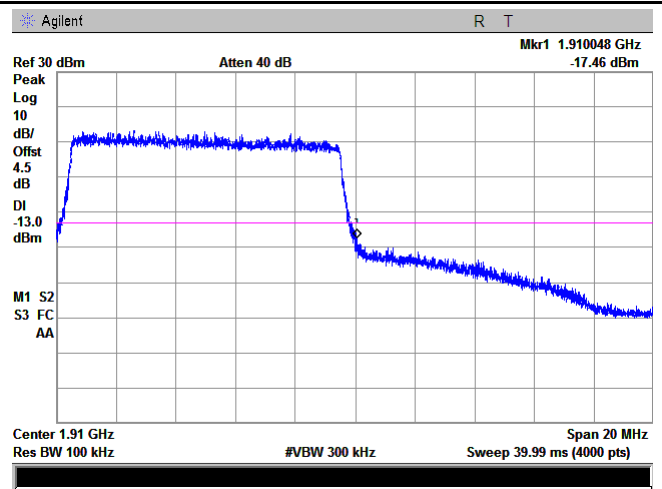

LTE band II - High Channel QPSK-10

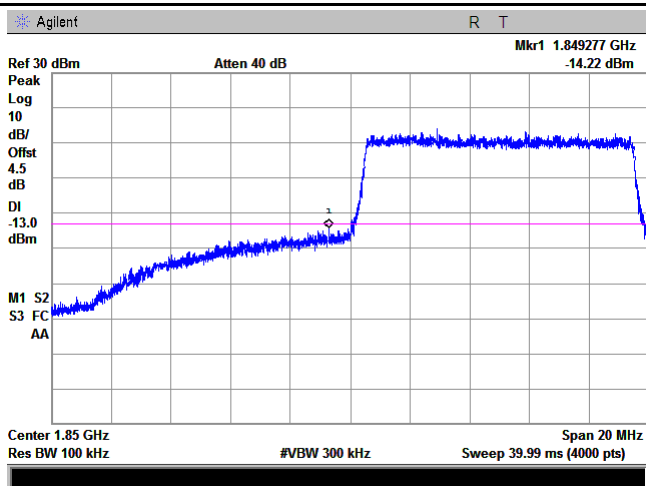

LTE band II - Low Channel 16QAM-10

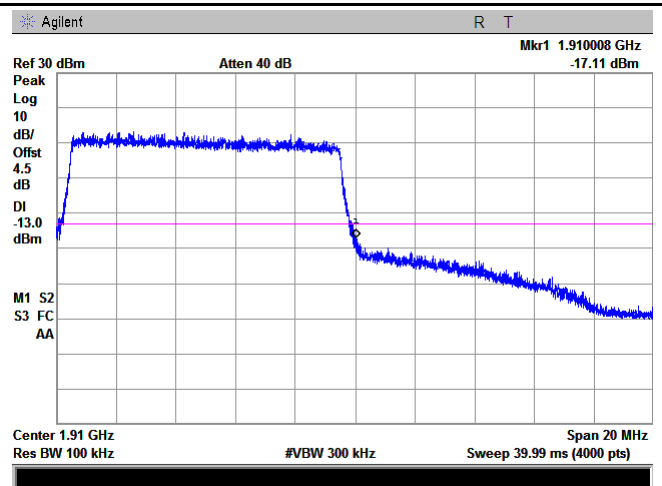

LTE band II - High Channel 16QAM-10

Note: Offset=Cable loss (4.5) + 10log
 $(103.9/100)=4.5+0.0=4.5$ dB

Note: Offset=Cable loss (4.5) + 10log
 $(103/100)=4.5+0.0=4.5$ dB

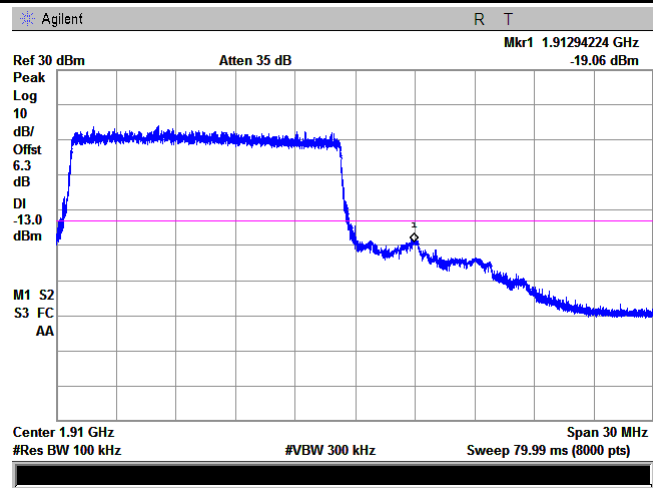
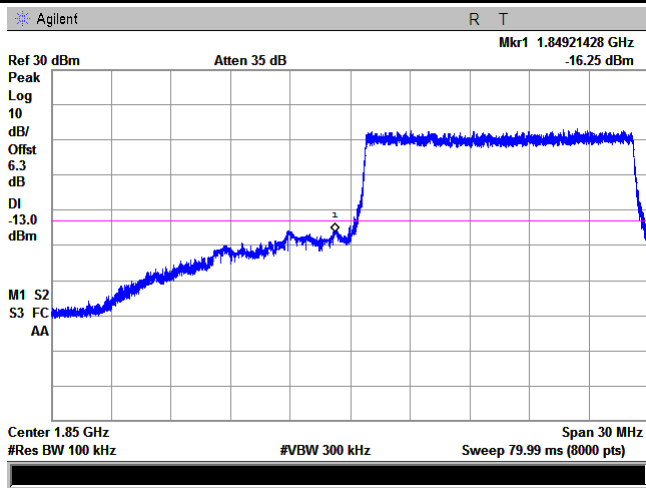

LTE band II - Low Channel QPSK-15

LTE band II - High Channel QPSK-15

Note: Offset=Cable loss (4.5) + 10log
 $(151/100)=4.5+1.8=6.3$ dB

Note: Offset=Cable loss (4.5) + 10log
 $(150.8/100)=4.5+1.8=6.3$ dB

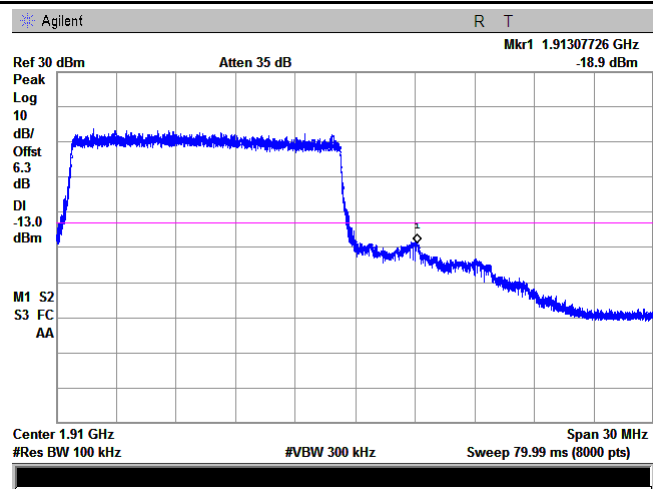
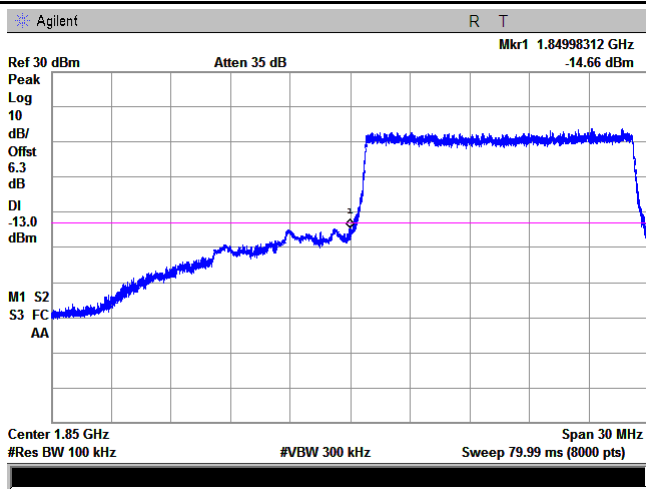

LTE band II - Low Channel 16QAM-15

LTE band II - High Channel 16QAM-15

Note: Offset=Cable loss (4.5) + 10log
 $(150.4/100)=4.5+1.8=6.3$ dB

Note: Offset=Cable loss (4.5) + 10log
 $(150.4/100)=4.5+1.8=6.3$ dB

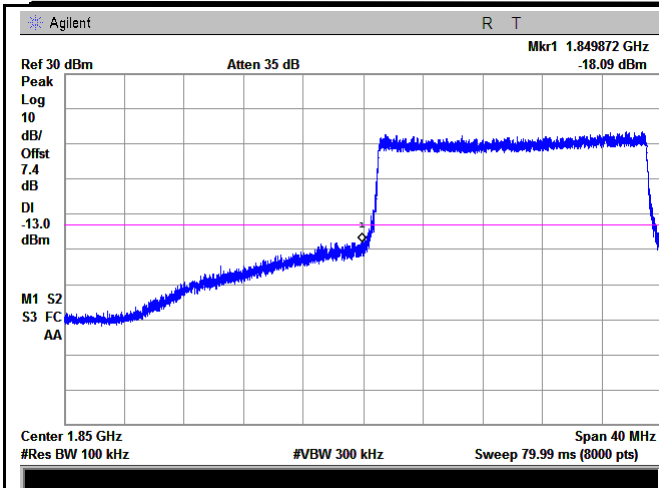

LTE band II - Low Channel QPSK-20

Note: Offset=Cable loss (4.5) + 10log
(196.7/100)=4.5+2.9=7.4 dB

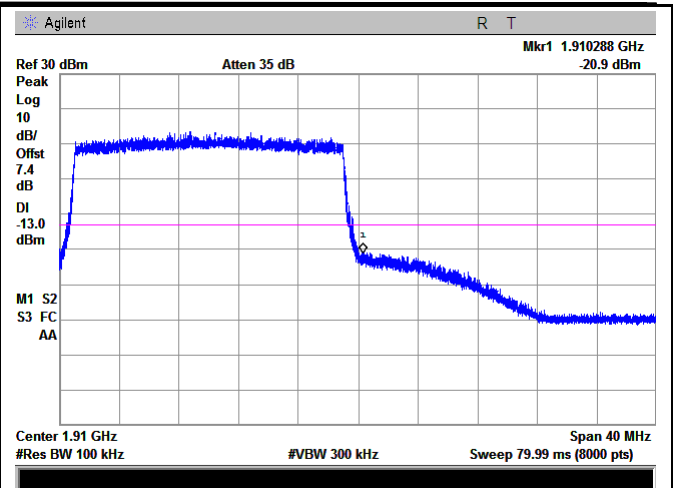

LTE band II - High Channel QPSK-20

Note: Offset=Cable loss (4.5) + 10log
(195.1/100)=4.5+2.9=7.4 dB

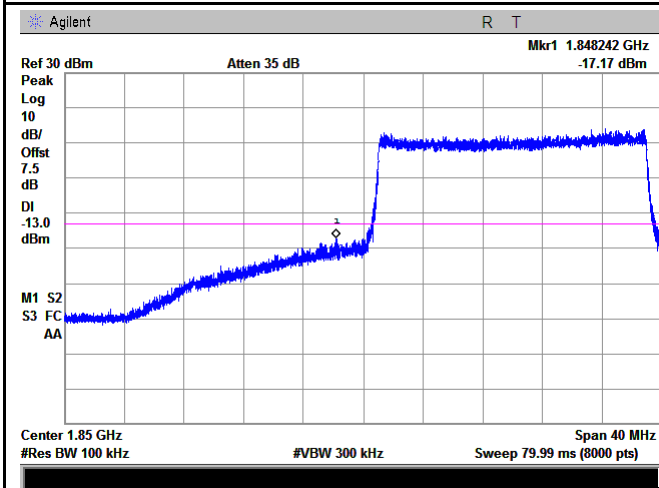

LTE band II - Low Channel 16QAM-20

Note: Offset=Cable loss (4.5) + 10log
(197.5/100)=4.5+3.0=7.5 dB

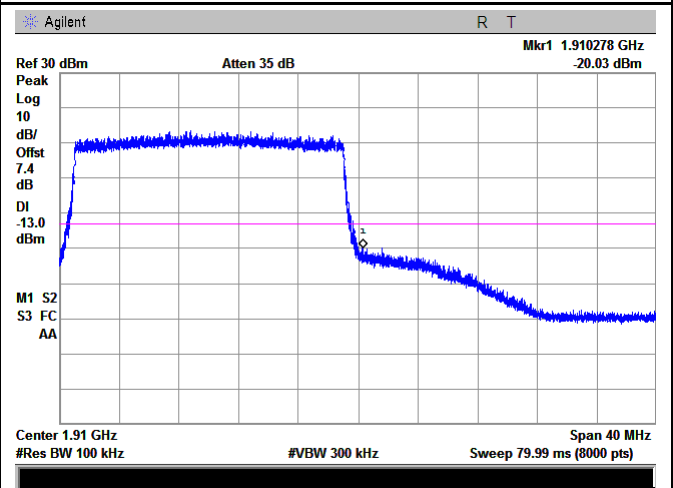

LTE band II - High Channel 16QAM-20

Note: Offset=Cable loss (4.5) + 10log
(193.2/100)=4.5+2.9=7.4 dB

LTE band IV (Part 27)

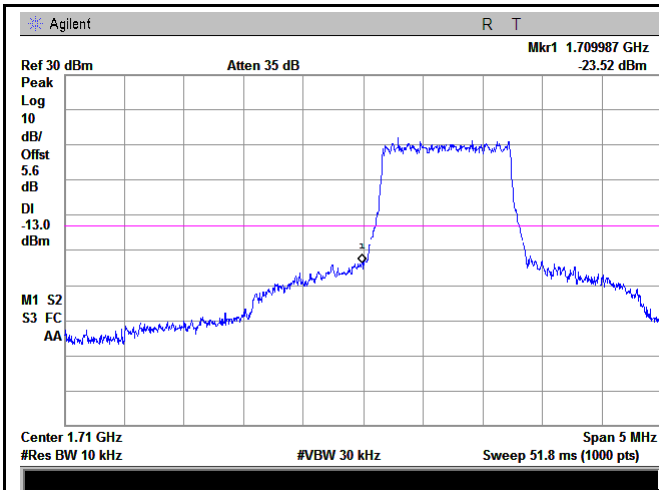

LTE band IV - Low Channel QPSK-1.4

Note: Offset=Cable loss (4.5) + 10log
 (12.94/10)=4.5+1.1=5.6 dB

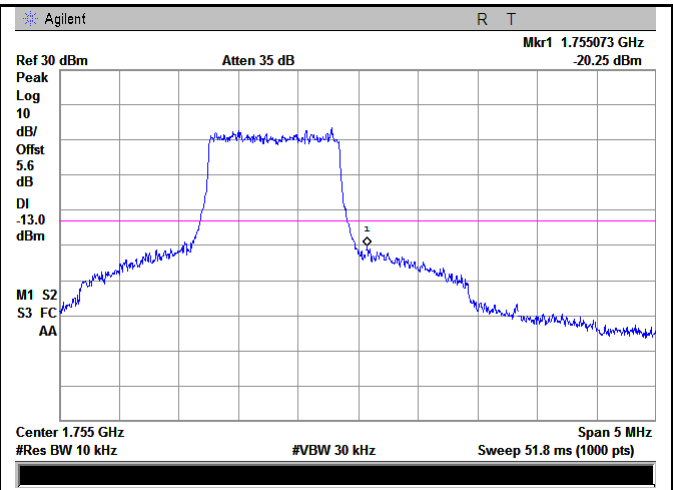

LTE band IV - High Channel QPSK-1.4

Note: Offset=Cable loss (4.5) + 10log
 (12.95/10)=4.5+1.1=5.6 dB

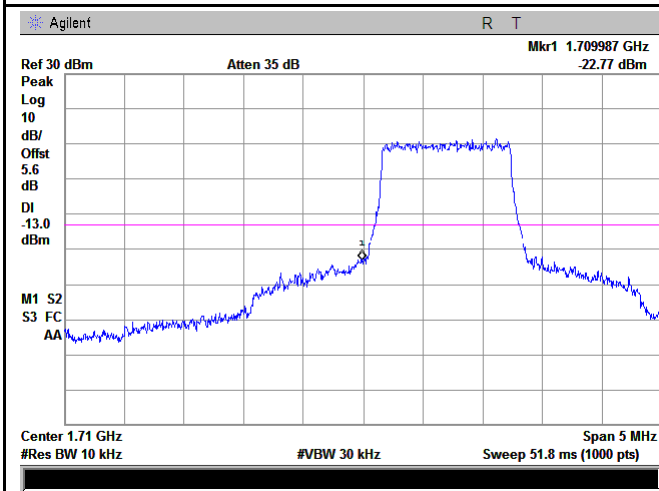

LTE band IV - Low Channel 16QAM-1.4

Note: Offset=Cable loss (4.5) + 10log
 (13.02/10)=4.5+1.1=5.6 dB

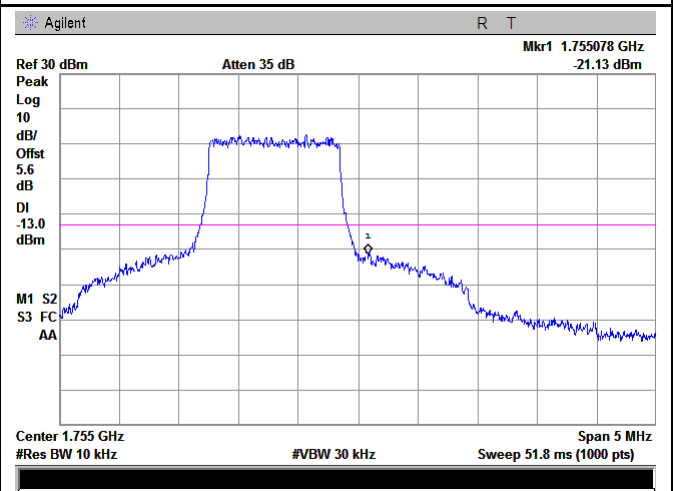

LTE band IV - High Channel 16QAM-1.4

Note: Offset=Cable loss (4.5) + 10log
 ((12.88/10)=4.5+1.1=5.6 dB

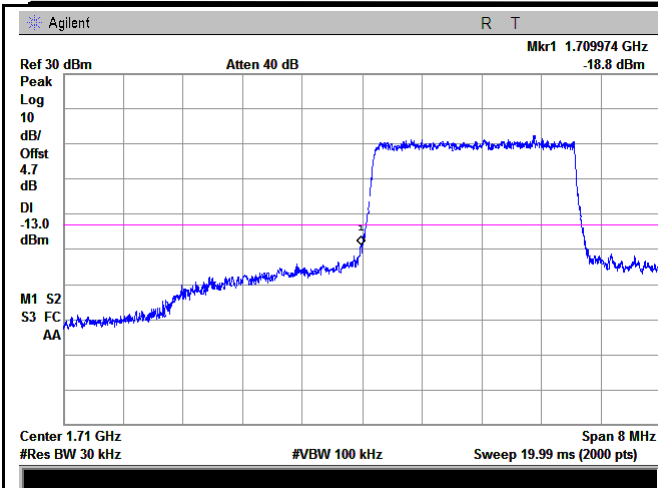

LTE band IV - Low Channel QPSK-3

Note: Offset=Cable loss (4.5) + 10log
 (31.06/30)=4.5+0.2=4.7 dB

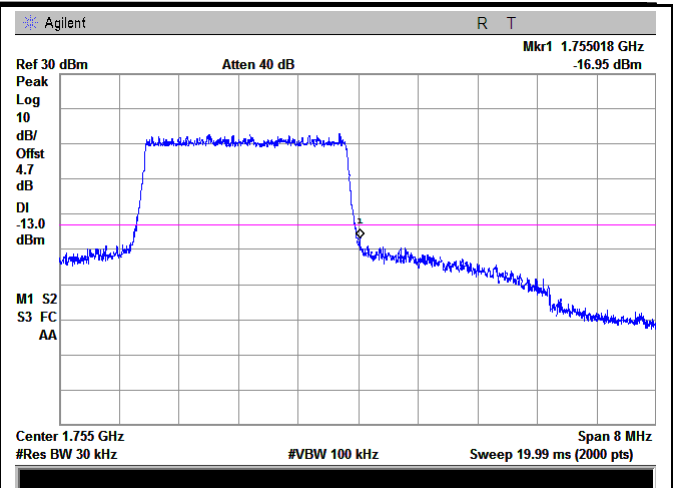

LTE band IV - High Channel QPSK-3

Note: Offset=Cable loss (4.5) + 10log
 (31.11/30)=4.5+0.2=4.7 dB

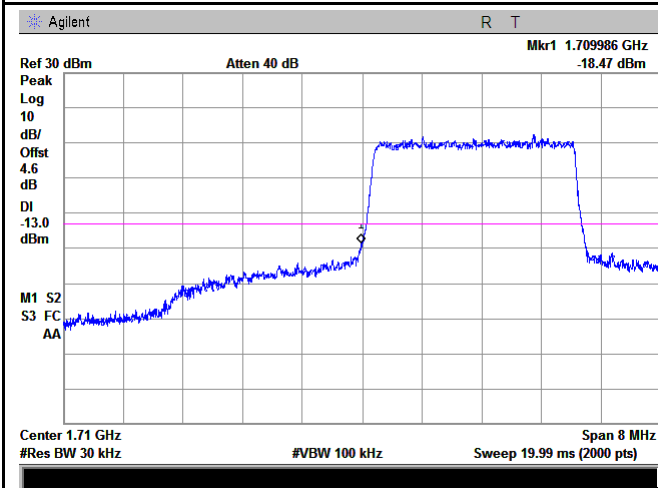

LTE band IV - Low Channel 16QAM-3

Note: Offset=Cable loss (4.5) + 10log
 (31.03/30)=4.5+0.1=4.6 dB

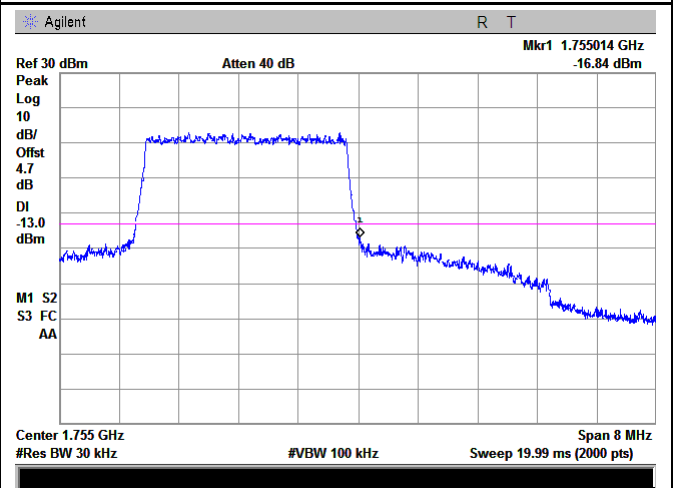

LTE band IV - High Channel 16QAM-3

Note: Offset=Cable loss (4.5) + 10log
 (31.16/30)=4.5+0.2=4.7 dB

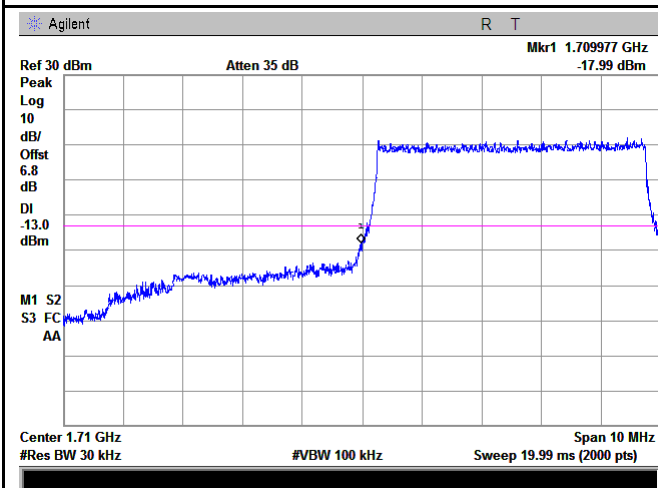

LTE band IV - Low Channel QPSK-5

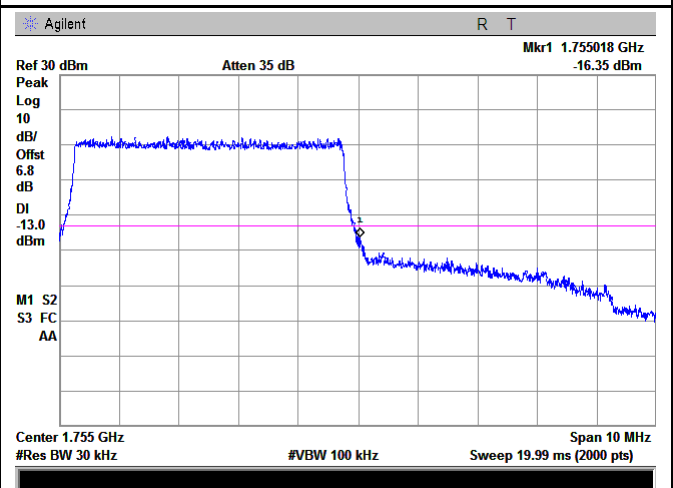

LTE band IV - High Channel QPSK-5

Note: Offset=Cable loss (4.5) + 10log
 $(50.99/30)=4.5+2.3=6.8$ dB

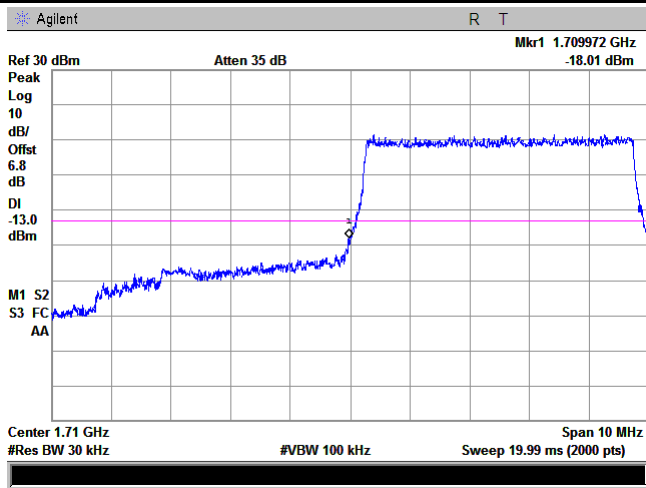

LTE band IV - Low Channel 16QAM-5

Note: Offset=Cable loss (4.5) + 10log
 $(50.95/30)=4.5+2.3=6.8$ dB

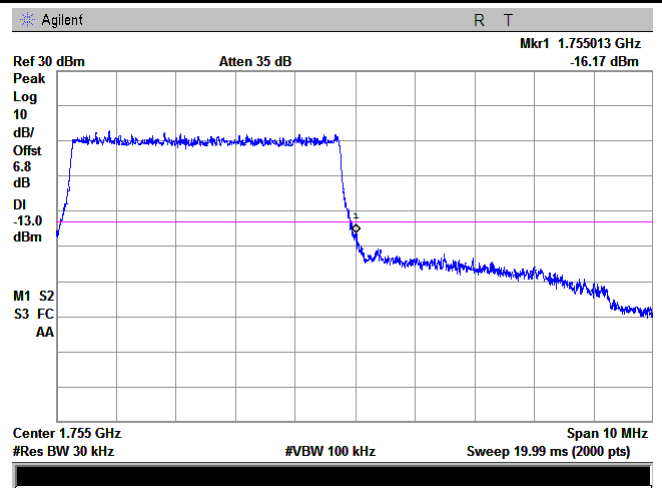

LTE band IV - High Channel 16QAM-5

Note: Offset=Cable loss (4.5) + 10log
 $(50.99/30)=4.5+2.3=6.8$ dB

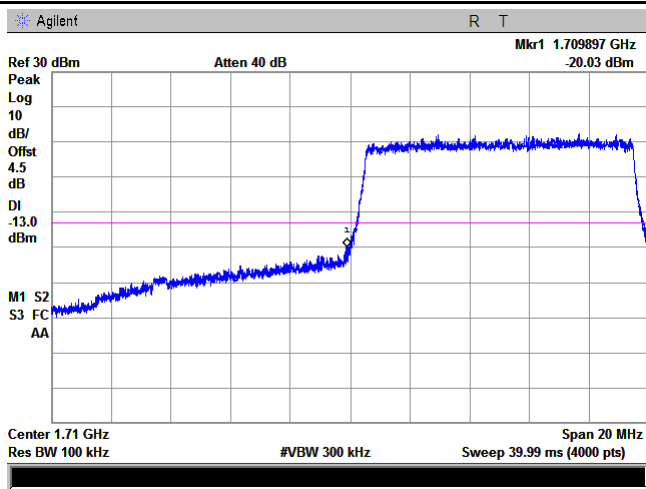

LTE band IV - Low Channel QPSK-10

Note: Offset=Cable loss (4.5) + 10log
 $(50.64/30)=4.5+2.3=6.8$ dB

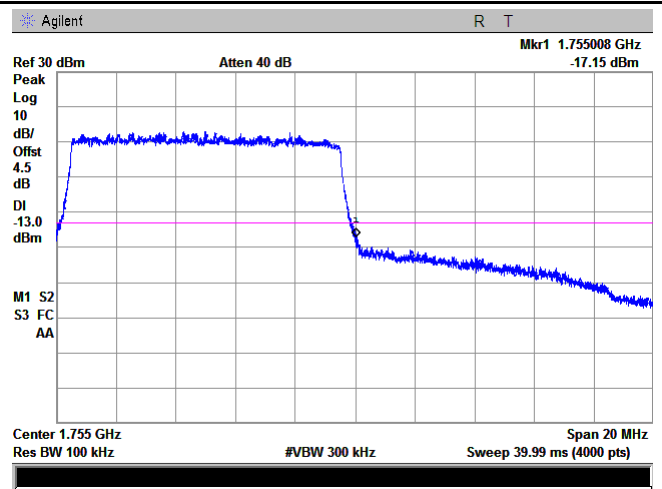

LTE band IV - High Channel QPSK-10

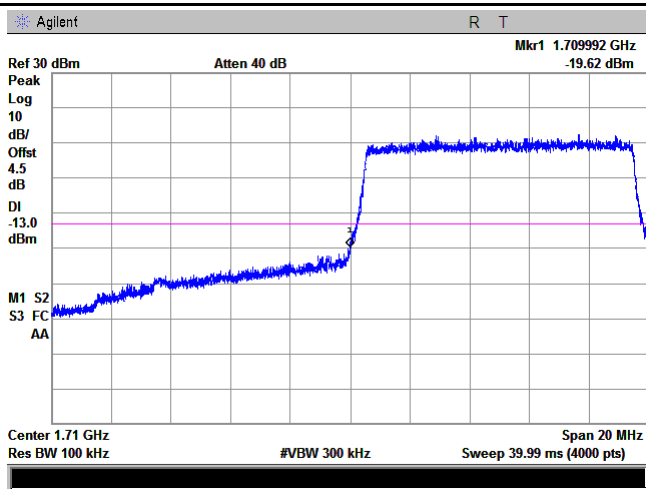

LTE band IV - Low Channel 16QAM-10

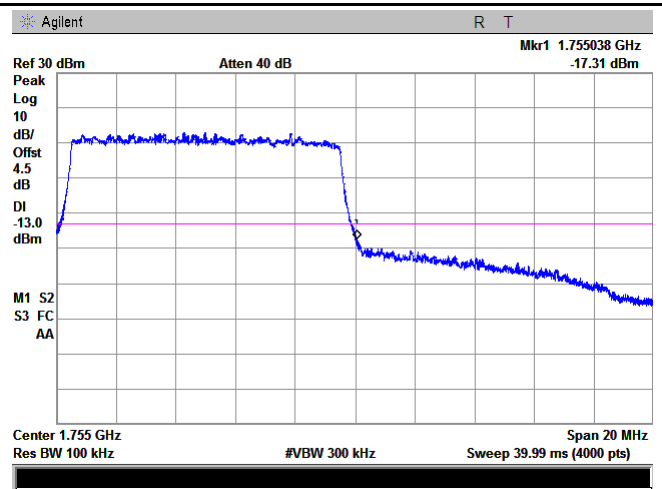

LTE band IV - High Channel 16QAM-10

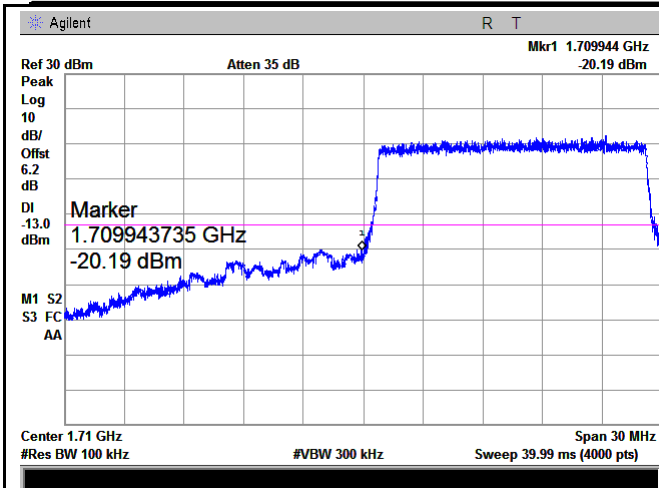

LTE band IV - Low Channel QPSK-15

Note: Offset=Cable loss (4.5) + 10log
(149.5/100)=4.5+1.7=6.2 dB

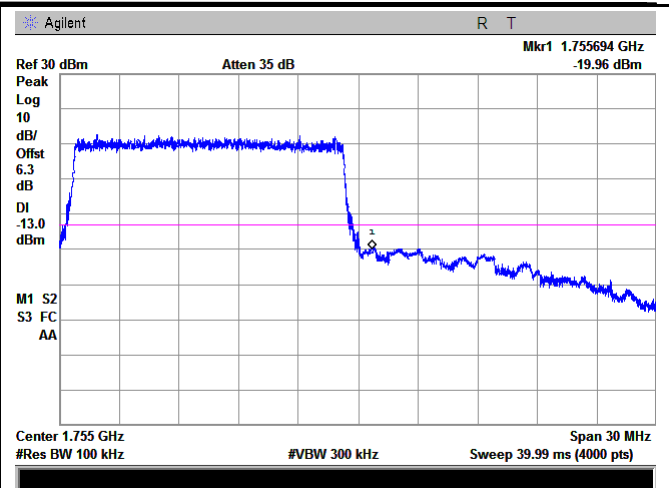

LTE band IV - High Channel QPSK-15

Note: Offset=Cable loss (4.5) + 10log
(149.7/100)=4.5+1.8=6.3 dB

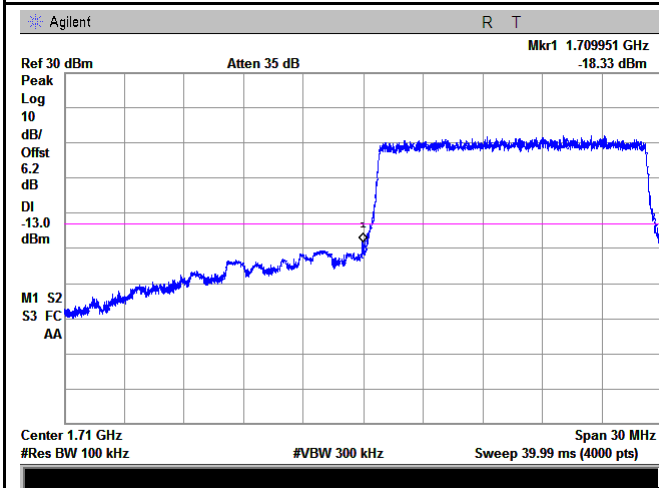

LTE band IV - Low Channel 16QAM-15

Note: Offset=Cable loss (4.5) + 10log
(149.5/100)=4.5+1.7=6.2 dB

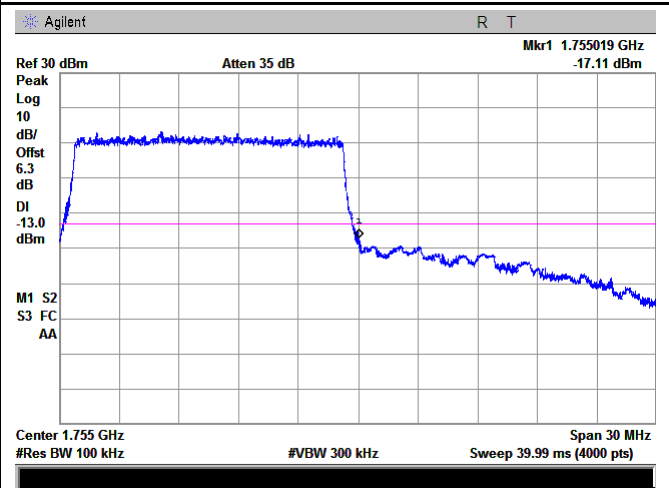

LTE band IV - High Channel 16QAM-15

Note: Offset=Cable loss (4.5) + 10log
(149.8/100)=4.5+1.8=6.3 dB

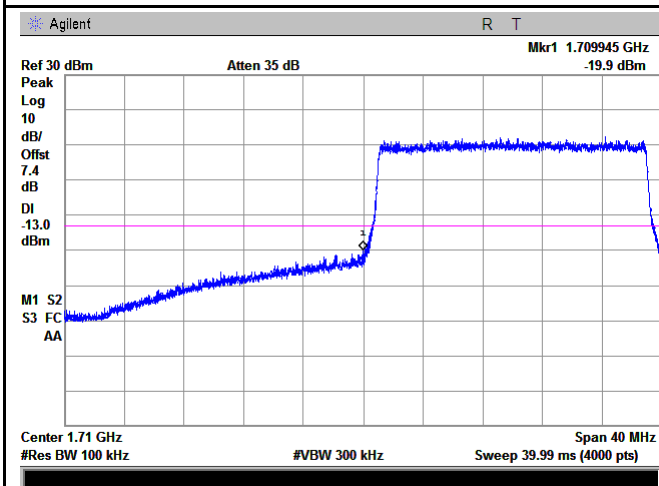

LTE band IV - Low Channel QPSK-20

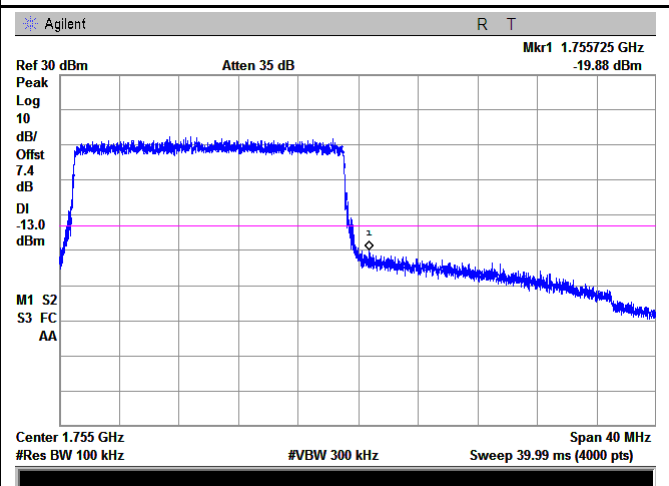

LTE band IV - High Channel QPSK-20

Note: Offset=Cable loss (4.5) + 10log
 (194.4/100)=4.5+2.9=7.4 dB

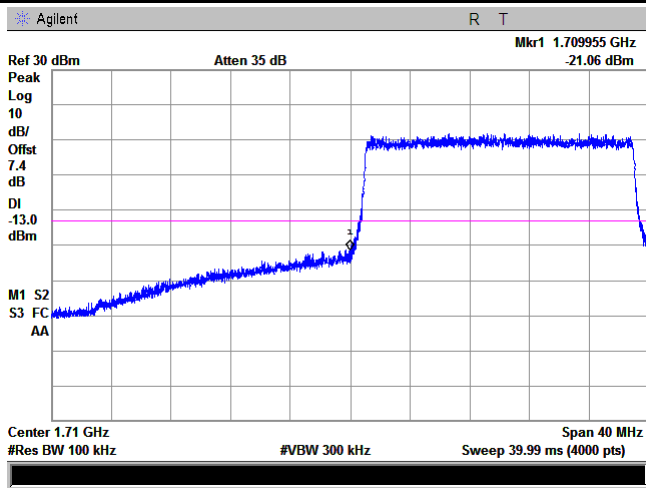

LTE band IV - Low Channel 16QAM-20

Note: Offset=Cable loss (4.5) + 10log
 (199.6/100)=4.5+2.9=7.5dB

Note: Offset=Cable loss (4.5) + 10log
 (194.5/100)=4.5+2.9=7.4 dB

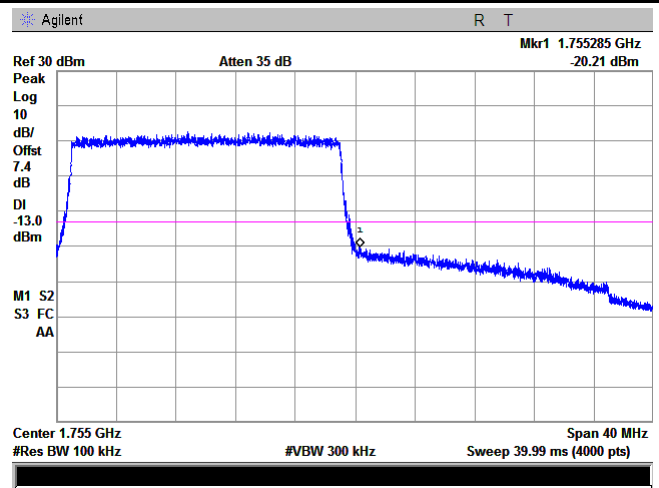

LTE band IV - High Channel 16QAM-20

Note: Offset=Cable loss (4.5) + 10log
 (194.5/100)=4.5+2.9=7.4 dB

6.8 Band Edge 27.53(m)

Temperature	25°C
Relative Humidity	57%
Atmospheric Pressure	1023mbar
Test date :	October 27, 2017
Tested By :	Loren Luo

Requirement(s):

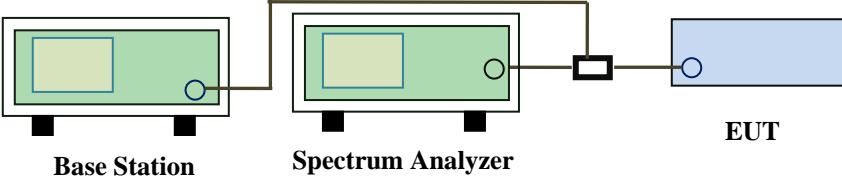
Spec	Requirement	Applicable
§27.53(m)	According to FCC 27.53(m)(4) specified that power of any emission outside of the channel edge must be attenuated below the transmitting power(P) by a factor shall be not less than $43+10\log(P)$ dB at the channel edge, the limit of emission equal to -13dBm. And $55+10\log(P)$ dB at 5.5MHz from the channel edges, the limit of emission equal to -25dBm. In the 1MHz bands immediately outside and adjacent to the frequency block a resolution bandwidth of at least one percent of the emission bandwidth of the fundamental emission of the transmitter may be employed.	<input checked="" type="checkbox"/>
Test Setup	 <p style="text-align: center;">Base Station Spectrum Analyzer EUT</p>	
Test Procedure	<ul style="list-style-type: none"> - The EUT was connected to Spectrum Analyzer and Base Station via power divider. - The 99% and 26 dB occupied bandwidth (BW) of the middle channel for the highest RF powers. 	
Remark		
Result	<input checked="" type="checkbox"/> Pass <input type="checkbox"/> Fail	

Test Data Yes N/A

Test Plot Yes (See below) N/A

LTE band VII (Part 27) result

BW(MHz)	Channel	Frequency (MHz)	Mode	Emission (dBm)	Limit (dBm)
5	20775	2500	QPSK	-15.42	-13
			16QAM	-15.05	-13
5	21425	2570	QPSK	-21.38	-13
			16QAM	-19.12	-13
10	20800	2500	QPSK	-17.74	-13
			16QAM	-16.41	-13
10	21400	2570	QPSK	-21.47	-13
			16QAM	-23.13	-13
15	20825	2500	QPSK	-16.30	-13
			16QAM	-16.36	-13
15	21400	2570	QPSK	-26.37	-13
			16QAM	-22.87	-13
20	20850	2500	QPSK	-20.39	-13
			16QAM	-20.66	-13
20	21350	2570	QPSK	-23.69	-13
			16QAM	-26.10	-13

LTE band VII (Part 27)

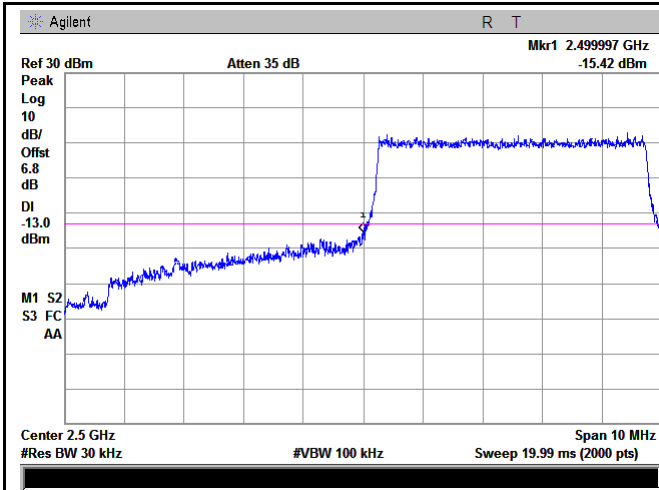

LTE band VII - Low Channel QPSK-5

Note: Offset=Cable loss (4.5) + 10log
 (51.25/30)=4.5+2.3=6.8 dB

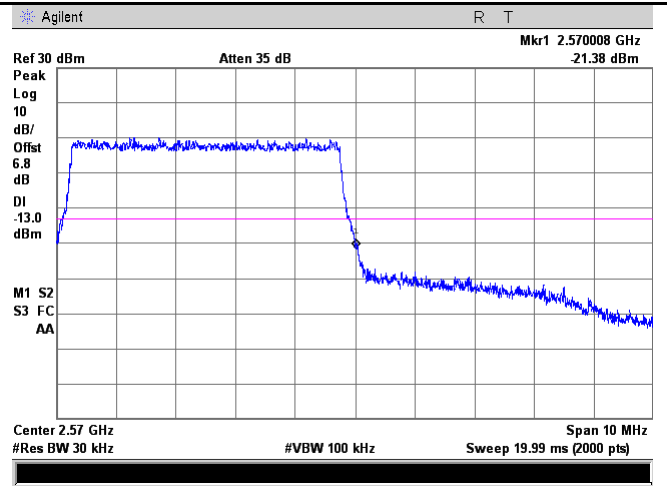

LTE band VII - High Channel QPSK-5

Note: Offset=Cable loss (4.5) + 10log
 (51.17/30)=4.5+2.3=6.8 dB

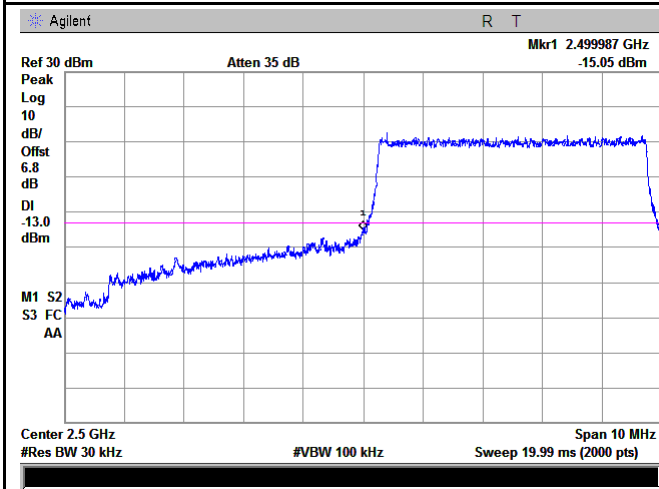

LTE band VII - Low Channel 16QAM-5

Note: Offset=Cable loss (4.5) + 10log
 (51.17/30)=4.5+2.3=6.8 dB

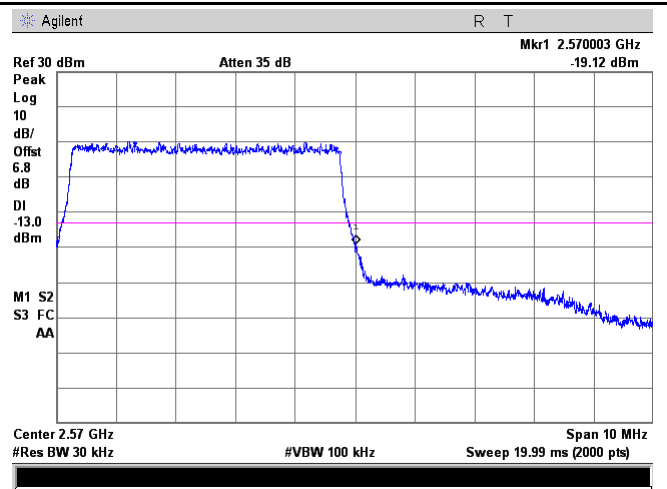

LTE band VII - High Channel 16QAM-5

Note: Offset=Cable loss (4.5) + 10log
 (51.14/30)=4.5+2.3=6.8 dB

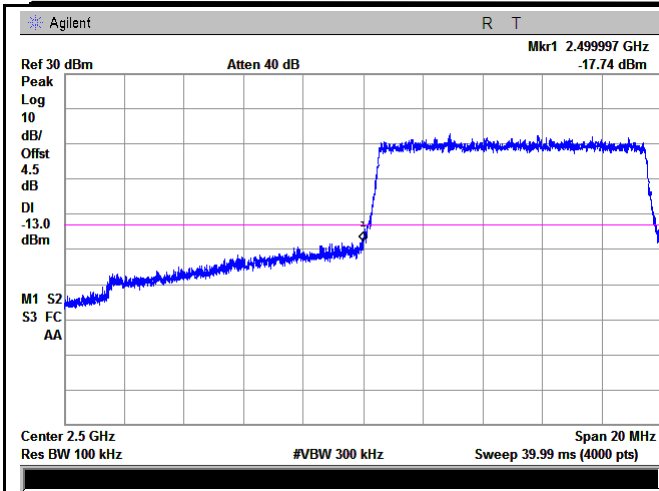

LTE band VII - Low Channel QPSK-10

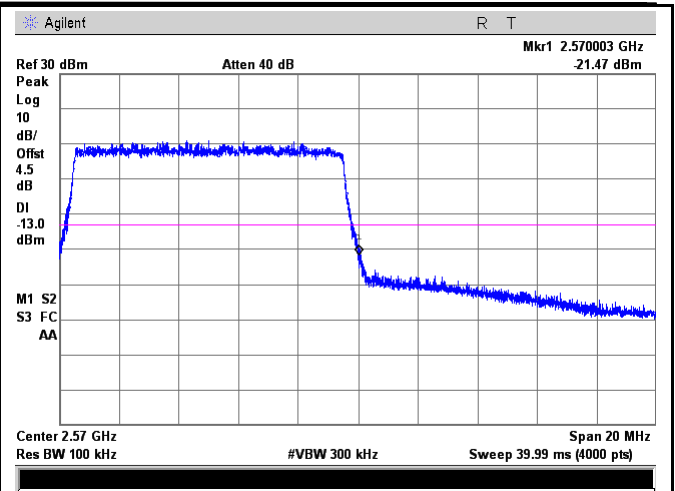

LTE band VII - High Channel QPSK-10

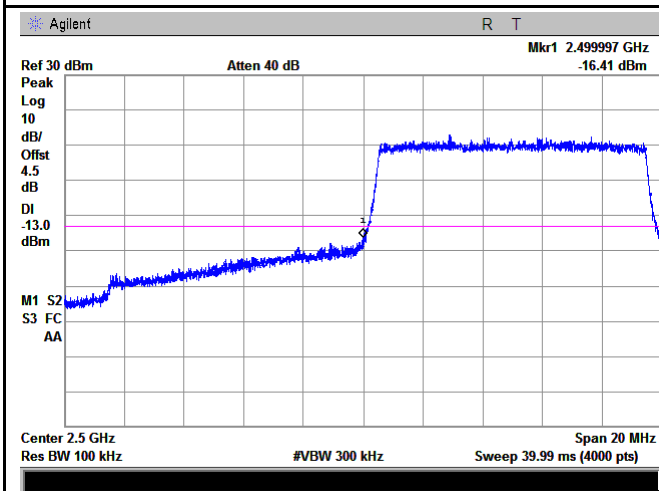

LTE band VII - Low Channel 16QAM-10

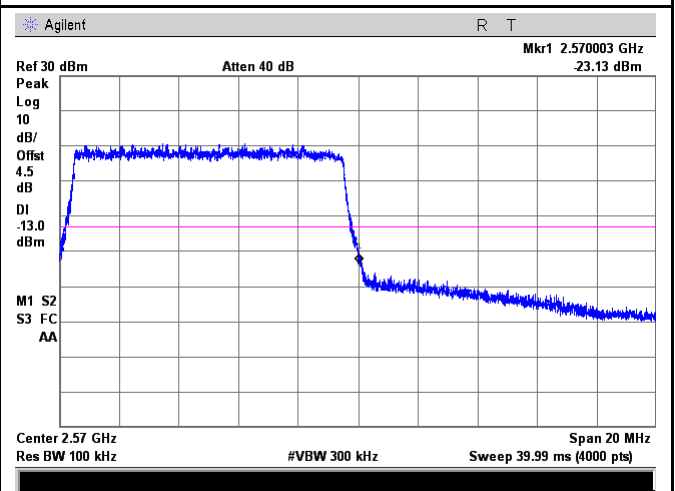

LTE band VII - High Channel 16QAM-10

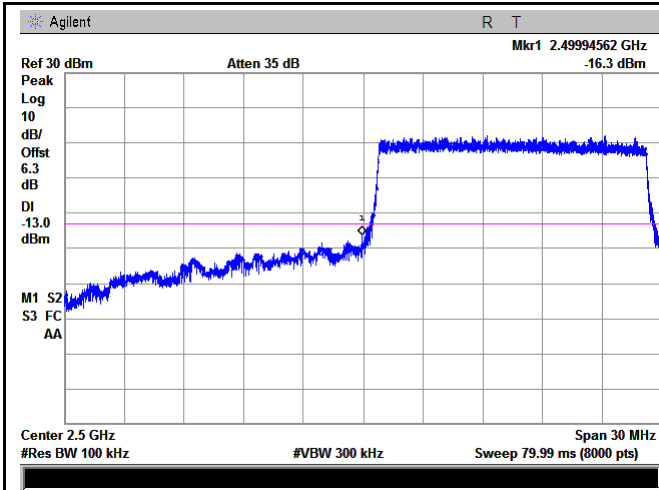

LTE band VII - Low Channel QPSK-15

Note: Offset=Cable loss (4.5) + 10log
(150.8/100)=4.5+1.8=6.3 dB

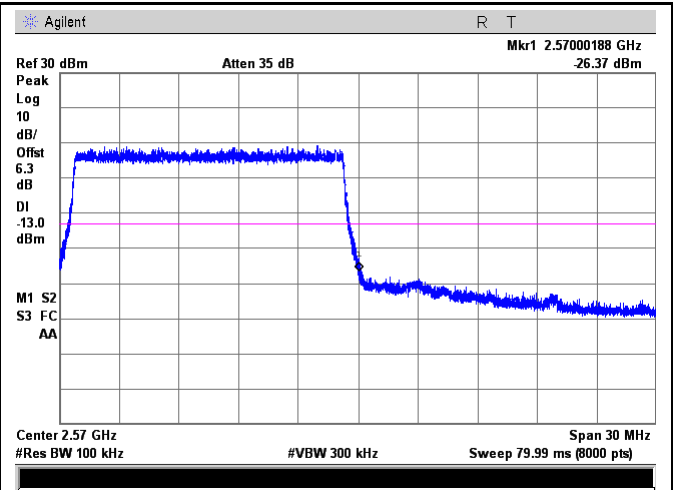

LTE band VII - High Channel QPSK-15

Note: Offset=Cable loss (4.5) + 10log
(150.8/100)=4.5+1.8=6.3 dB

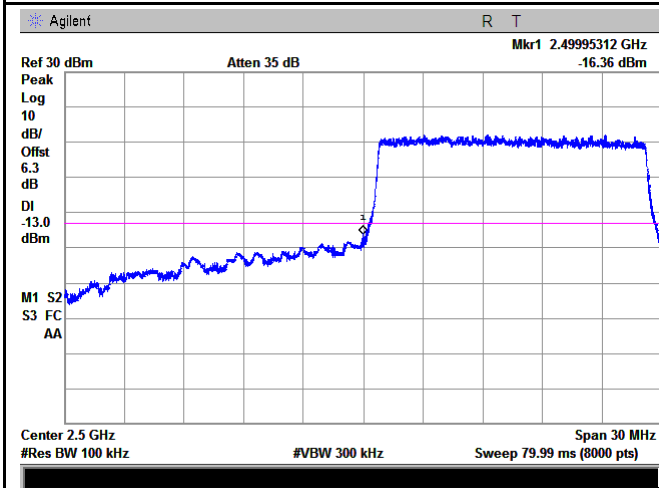

LTE band VII - Low Channel 16QAM-15

Note: Offset=Cable loss (4.5) + 10log
(150.9/100)=4.5+1.8=6.3dB

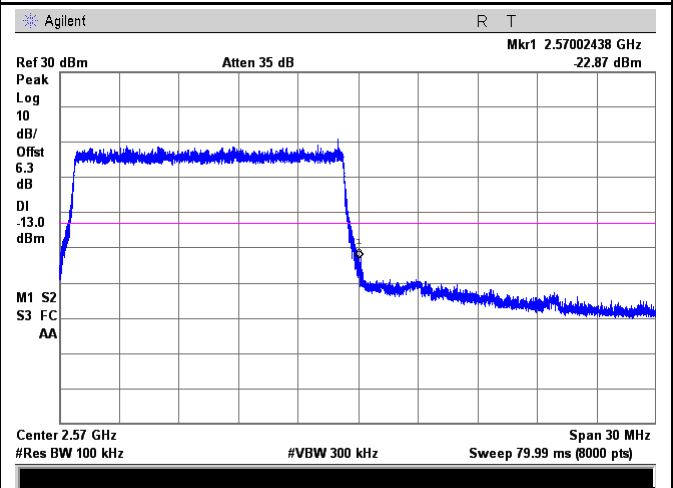

LTE band VII - High Channel 16QAM-15

Note: Offset=Cable loss (4.5) + 10log
(150.3/100)=4.5+1.8=6.3 dB

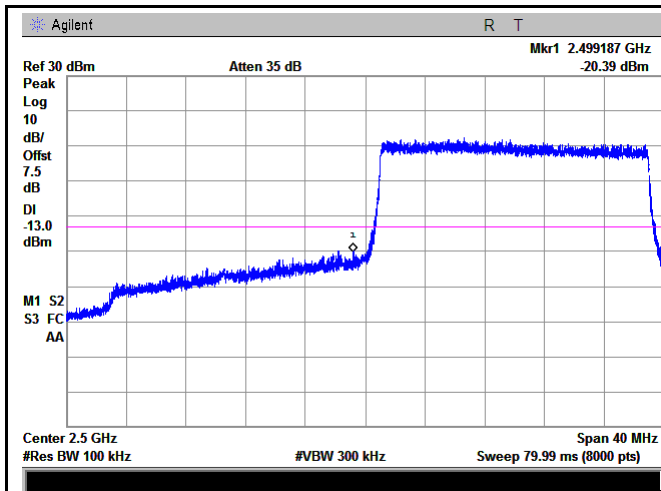

LTE band VII - Low Channel QPSK-20

Note: Offset=Cable loss (4.5) + 10log
(197.4/100)=4.5+3.0=7.5 dB

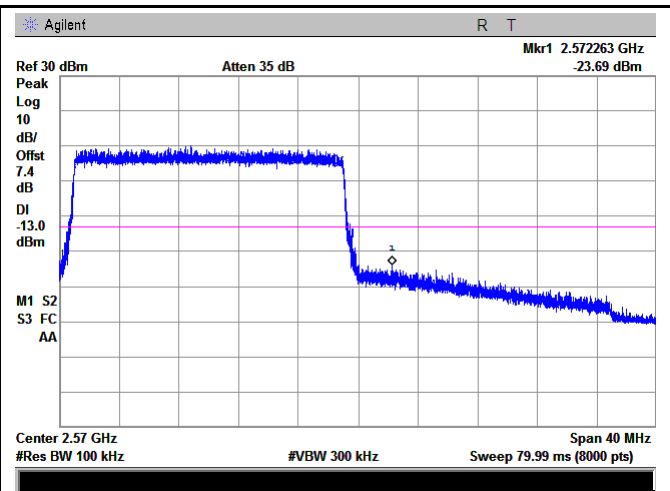

LTE band VII - High Channel QPSK-20

Note: Offset=Cable loss (4.5) + 10log
(195.4/100)=4.5+2.9=7.4dB

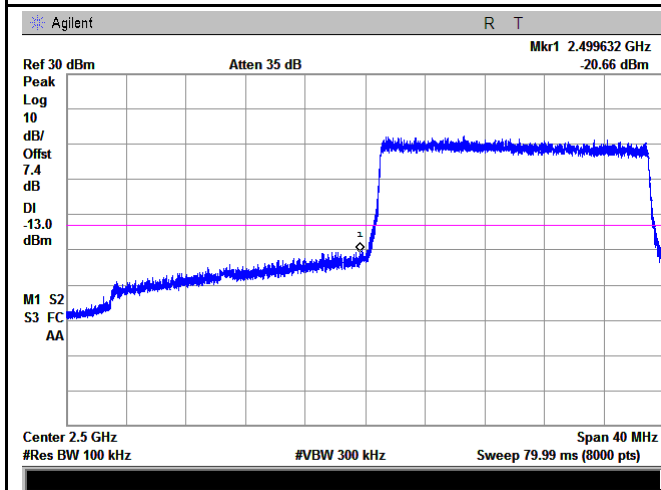

LTE band VII - Low Channel 16QAM-20

Note: Offset=Cable loss (4.5) + 10log
(196.1/100)=4.5+2.9=7.4 dB

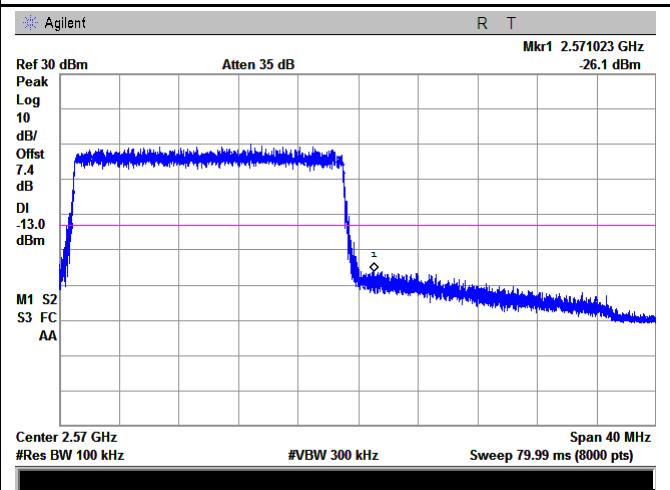

LTE band VII - High Channel 16QAM-20

Note: Offset=Cable loss (4.5) + 10log
(194.7/100)=4.5+2.9=7.4 dB

6.9 Frequency Stability

Temperature	25°C
Relative Humidity	57%
Atmospheric Pressure	1023mbar
Test date :	October 27, 2017
Tested By :	Loren Luo

Requirement(s):

Spec	Item	Requirement	Applicable																																
§2.1055, §22.355 & §24.235 § 27.5(h); § 27.54	a)	<p>According to §22.355, the carrier frequency of each transmitter in the Public Mobile Services must be maintained within the tolerances given in Table below:</p> <p>Frequency Tolerance for Transmitters in the Public Mobile Services</p> <table border="1"> <thead> <tr> <th>Frequency Range (MHz)</th> <th>Base, fixed (ppm)</th> <th>Mobile ≤ 3 watts (ppm)</th> <th>Mobile ≤ 3 watts (ppm)</th> </tr> </thead> <tbody> <tr> <td>25 to 50</td> <td>20.0</td> <td>20.0</td> <td>50.0</td> </tr> <tr> <td>□□to 450</td> <td>5.0</td> <td>5.0</td> <td>50.0</td> </tr> <tr> <td>450 to 512</td> <td>2.5</td> <td>5.0</td> <td>5□0</td> </tr> <tr> <td>821 to 896</td> <td>1.5</td> <td>2.5</td> <td>2.5</td> </tr> <tr> <td>928 to 929.</td> <td>5.0</td> <td>N/A</td> <td>N/A</td> </tr> <tr> <td>929 to 960.</td> <td>1.5</td> <td>N/A</td> <td>N/A</td> </tr> <tr> <td>2110 to 2220</td> <td>10.0</td> <td>N/A</td> <td>N/A</td> </tr> </tbody> </table> <p>According to §24.235, the frequency stability shall be sufficient to ensure that the fundamental emissions stay within the authorized frequency block.</p> <p>According to §27.54, The frequency stability shall be sufficient to ensure that the fundamental emissions stay within the authorized bands of operation.</p>	Frequency Range (MHz)	Base, fixed (ppm)	Mobile ≤ 3 watts (ppm)	Mobile ≤ 3 watts (ppm)	25 to 50	20.0	20.0	50.0	□□to 450	5.0	5.0	50.0	450 to 512	2.5	5.0	5□0	821 to 896	1.5	2.5	2.5	928 to 929.	5.0	N/A	N/A	929 to 960.	1.5	N/A	N/A	2110 to 2220	10.0	N/A	N/A	<input checked="" type="checkbox"/>
		Frequency Range (MHz)	Base, fixed (ppm)	Mobile ≤ 3 watts (ppm)	Mobile ≤ 3 watts (ppm)																														
		25 to 50	20.0	20.0	50.0																														
		□□to 450	5.0	5.0	50.0																														
		450 to 512	2.5	5.0	5□0																														
		821 to 896	1.5	2.5	2.5																														
		928 to 929.	5.0	N/A	N/A																														
		929 to 960.	1.5	N/A	N/A																														
		2110 to 2220	10.0	N/A	N/A																														

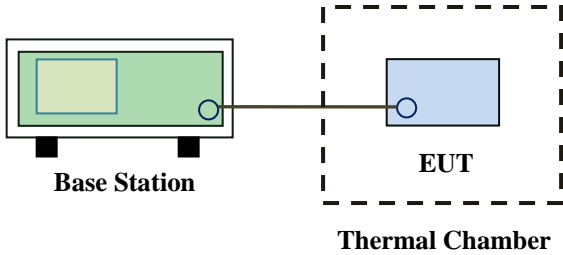
Test setup	 <p>The diagram illustrates the test setup. On the left, a green rectangular box labeled 'Base Station' is shown. A horizontal line connects it to a blue rectangular box labeled 'EUT' (Equipment Under Test) located inside a dashed-line rectangular box labeled 'Thermal Chamber'.</p>
Procedure	<p>A communication link was established between EUT and base station. The frequency error was monitored and measured by base station under variation of ambient temperature and variation of primary supply voltage.</p> <p>Limit: The frequency stability of the transmitter shall be maintained within $\pm 0.00025\%$ ($\pm 2.5\text{ppm}$) of the center frequency.</p>
Remark	<p>Frequency Stability versus Temperature: The Frequency tolerance of the carrier signal shall be maintained within 2.5ppm of the operating frequency over a temperature variation of -10°C to $+55^{\circ}\text{C}$ at normal supply voltage.</p>
Result	<p><input checked="" type="checkbox"/> Pass <input type="checkbox"/> Fail</p>

Test Data Yes N/A

Test Plot Yes (See below) N/A

LTE band II (Part 24E) result

Middle Channel, $f_0 = 1880$ MHz				
Temperature (°C)	Power Supplied (V _{DC})	Frequency Error (Hz)	Frequency Error (ppm)	Limit (ppm)
-10	3.85	-15	0.0080	2.5
0		-17	0.0090	2.5
10		-11	0.0059	2.5
20		-17	0.0090	2.5
30		-18	0.0096	2.5
40		-10	0.0053	2.5
50		-17	0.0090	2.5
55		-16	0.0085	2.5
25	4.4	-18	0.0096	2.5
	3.6	-19	0.0101	2.5

LTE band IV (Part 27) result

Middle Channel, $f_0 = 1732.5$ MHz				
Temperature (°C)	Power Supplied (V _{DC})	Frequency Error (Hz)	Frequency Error (ppm)	Limit (ppm)
-10	3.85	-13	0.0075	2.5
0		-10	0.0058	2.5
10		-18	0.0104	2.5
20		-17	0.0098	2.5
30		-18	0.0104	2.5
40		-18	0.0104	2.5
50		-14	0.0081	2.5
55		-8	0.0046	2.5
25	4.4	-10	0.0058	2.5
	3.6	-15	0.0087	2.5

LTE band VII (Part 27) result

Middle Channel, $f_0 = 2535$ MHz				
Temperature (°C)	Power Supplied (V _{DC})	Frequency Error (Hz)	Frequency Error (ppm)	Limit (ppm)
-10	3.85	-14	0.0055	2.5
0		-11	0.0043	2.5
10		-11	0.0043	2.5
20		-19	0.0075	2.5
30		-18	0.0071	2.5
40		-11	0.0043	2.5
50		-11	0.0043	2.5
55		-16	0.0063	2.5
25		4.4	-13	0.0051
	3.6	-11	0.0043	2.5

Annex A. TEST INSTRUMENT

Instrument	Model	Serial #	Cal Date	Cal Due	In use
RF Conducted Test					
Agilent ESA-E SERIES SPECTRUM ANALYZER	E4407B	MY45108319	09/14/2017	09/13/2018	<input checked="" type="checkbox"/>
Power Splitter	1#	1#	08/30/2017	08/29/2018	<input checked="" type="checkbox"/>
Universal Radio Communication Tester	CMU200	121393	09/23/2017	09/22/2018	<input checked="" type="checkbox"/>
Temperature/Humidity Chamber	UHL-270	001	10/07/2017	10/06/2018	<input checked="" type="checkbox"/>
DC Power Supply	E3640A	MY40004013	09/15/2017	09/14/2018	<input checked="" type="checkbox"/>
RF Power Sensor	Dare RPR3006C/P/W	AY554013	09/15/2017	09/14/2018	<input checked="" type="checkbox"/>
Radiated Emissions					
EMI test receiver	ESL6	100262	09/15/2017	09/14/2018	<input checked="" type="checkbox"/>
OPT 010 AMPLIFIER (0.1-1300MHz)	8447E	2727A02430	08/30/2017	08/29/2018	<input checked="" type="checkbox"/>
Horn Antenna	BBHA9170	3145226D1	09/27/2017	09/26/2018	<input checked="" type="checkbox"/>
Microwave Preamplifier (1 ~ 26.5GHz)	8449B	3008A02402	03/23/2017	03/22/2018	<input checked="" type="checkbox"/>
Bilog Antenna (30MHz~6GHz)	JB6	A110712	09/19/2017	09/18/2018	<input checked="" type="checkbox"/>
Bilog Antenna (30MHz~2GHz)	JB1	A112017	09/19/2017	09/18/2018	<input checked="" type="checkbox"/>
Double Ridge Horn Antenna (1 ~18GHz)	AH-118	71259	09/22/2017	09/21/2018	<input checked="" type="checkbox"/>
Double Ridge Horn Antenna (1 ~18GHz)	AH-118	71283	09/22/2017	09/21/2018	<input checked="" type="checkbox"/>
SYNTHESIZED SIGNAL GENERATOR	8665B	3744A01293	09/15/2017	09/14/2018	<input checked="" type="checkbox"/>
Power Amplifier	SMC150D	R1553-0313	03/08/2017	03/07/2018	<input checked="" type="checkbox"/>
Power Amplifier	S61-25	R1553-0516	05/26/2017	05/25/2018	<input checked="" type="checkbox"/>
Power Amplifier	S41-25D	R1553-0314	05/26/2017	05/25/2018	<input checked="" type="checkbox"/>



Test Report	17071091-FCC-R5
Page	94 of 111

Tunable Notch Filter	3NF-800/1000- S	AA4	08/30/2017	08/29/2018	<input checked="" type="checkbox"/>
----------------------	--------------------	-----	------------	------------	-------------------------------------

Annex B. EUT And Test Setup Photographs

Annex B.i. Photograph: EUT External Photo

Whole Package View



Adapter - Label View



EUT - Front View



EUT - Rear View



EUT - Top View



EUT - Bottom View

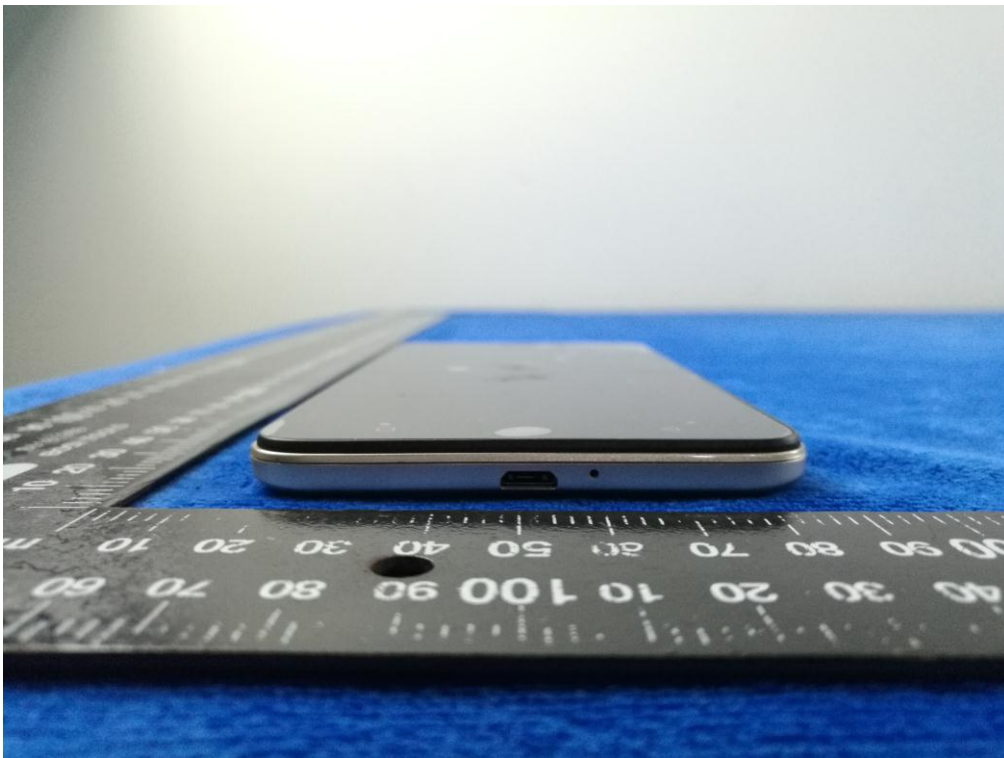

EUT - Left View



EUT - Right View



Annex B.ii. Photograph: EUT Internal Photo

Cover Off - Top View 1



Cover Off - Top View 2



Battery - Front View



Battery - Rear View



Mainboard with Shielding - Front View

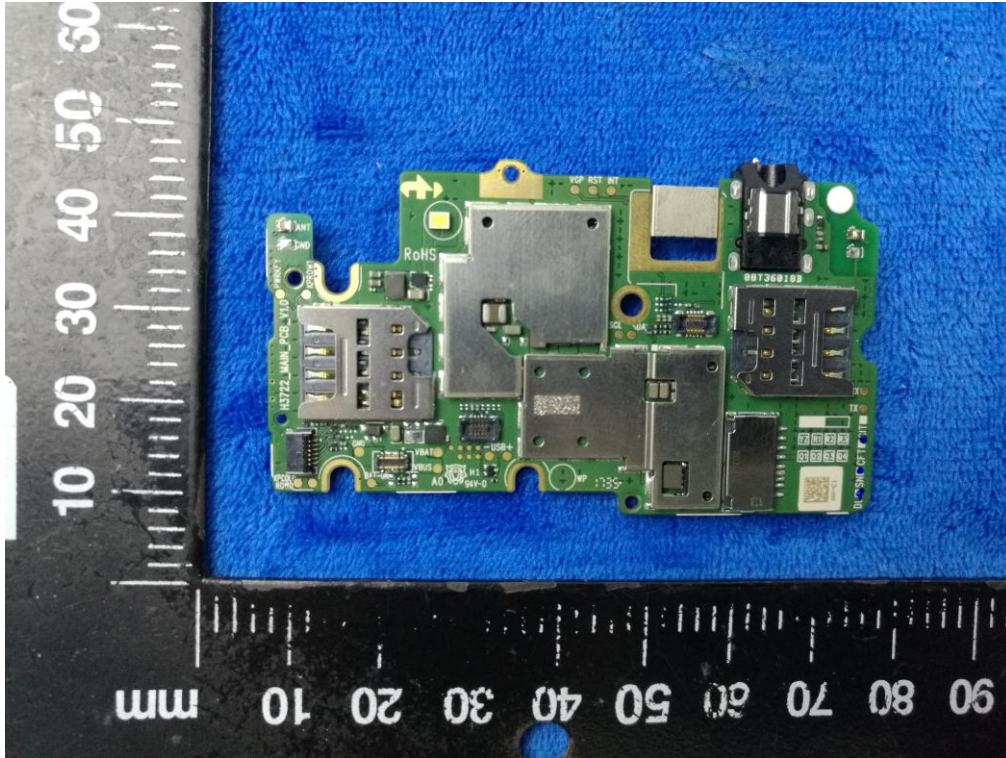

Mainboard without Shielding - Front View

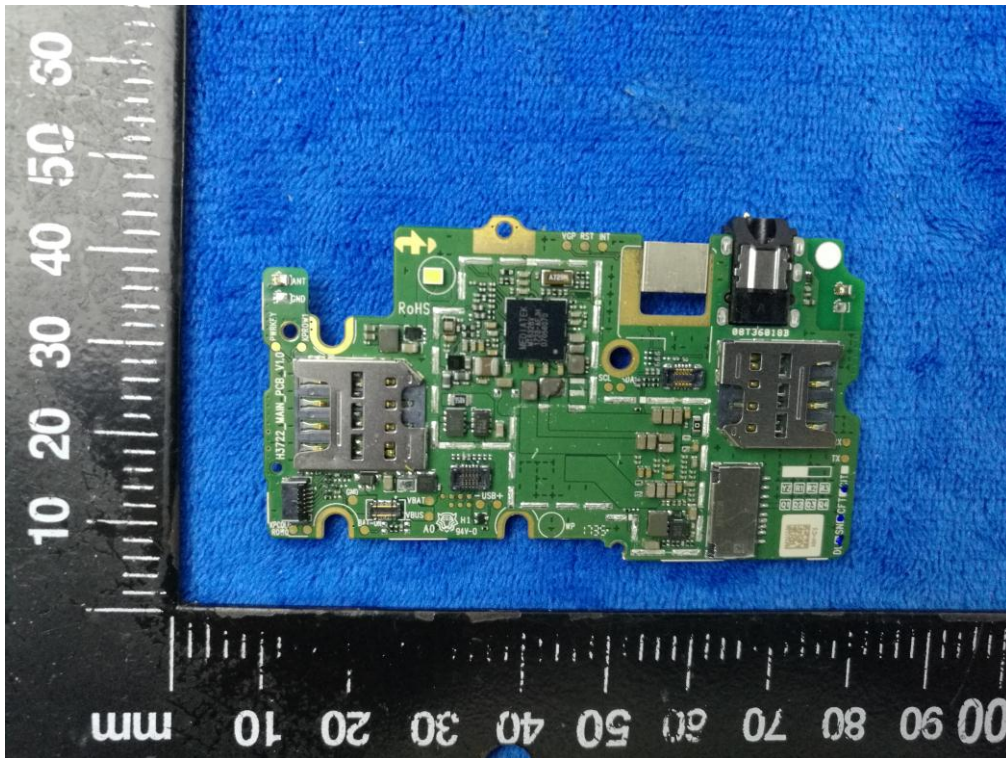

Mainboard with Shielding – Rear View

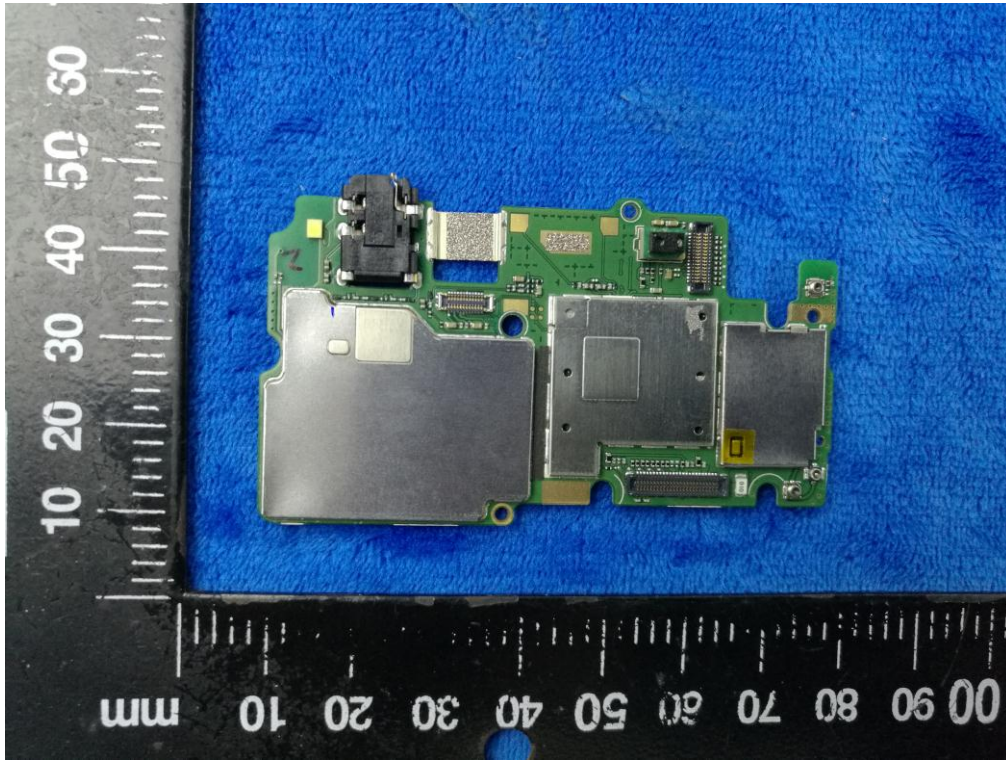

Mainboard without Shielding – Rear View

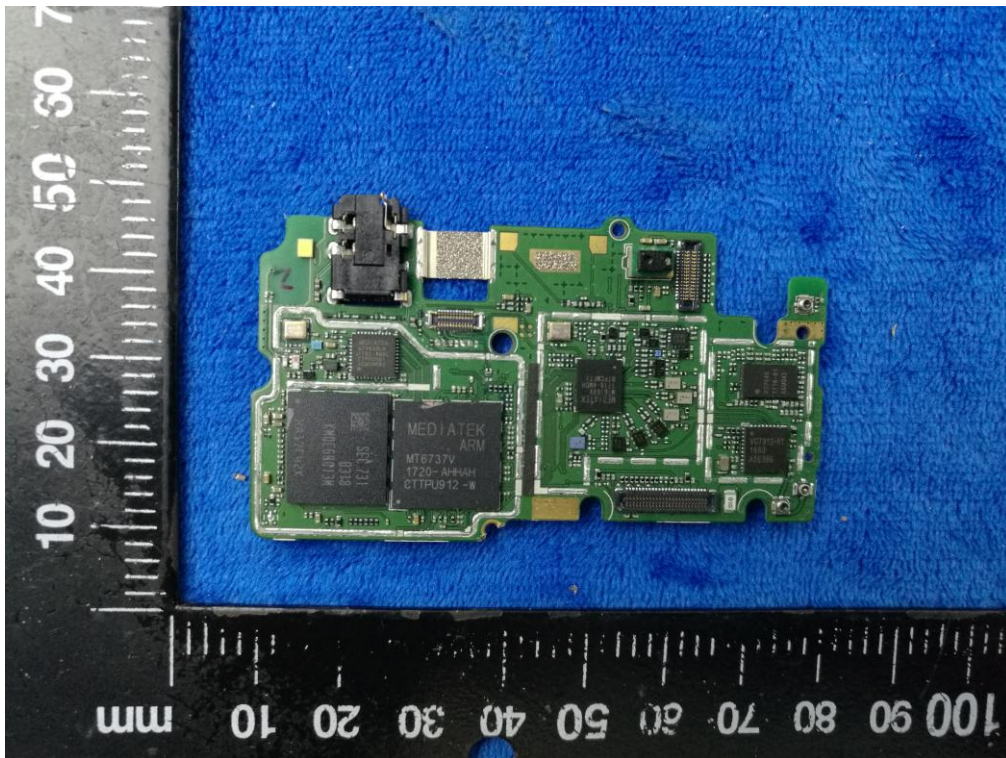

LCD – Front View



LCD – Rear View



GSM/PCS/UMTS-FDD/LTE Antenna View



WIFI/BT/BLE/GPS - Antenna View

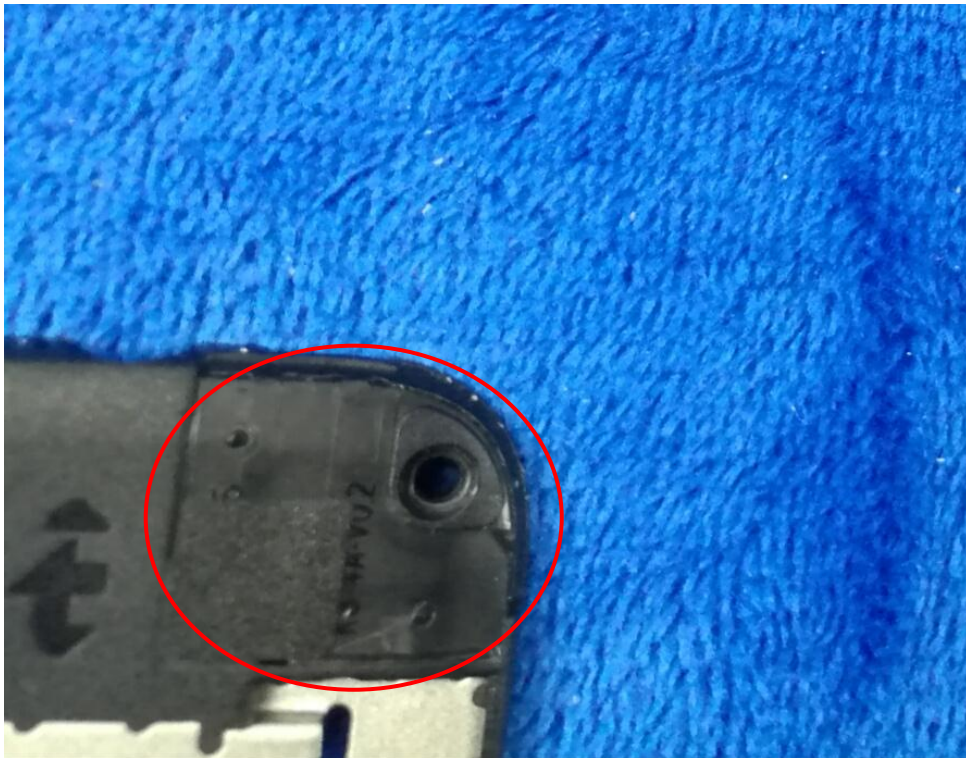

RXD- Antenna View



Annex B.iii. Photograph: Test Setup Photo

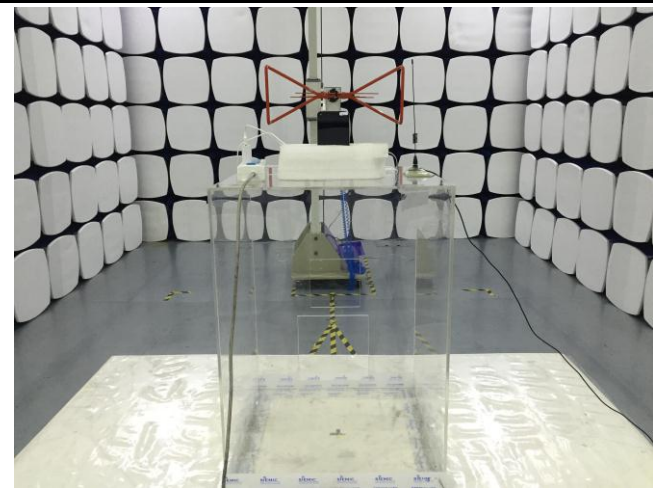

Radiated Spurious Emissions Test Setup Below 1GHz

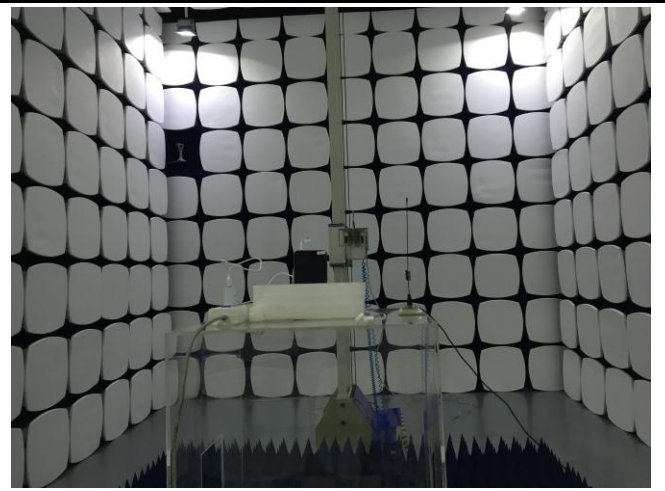

Radiated Spurious Emissions Test Setup Above
1GHz

Annex C. TEST SETUP AND SUPPORTING EQUIPMENT

Annex C.ii. TEST SET UP BLOCK

Block Configuration Diagram for Radiated Emissions

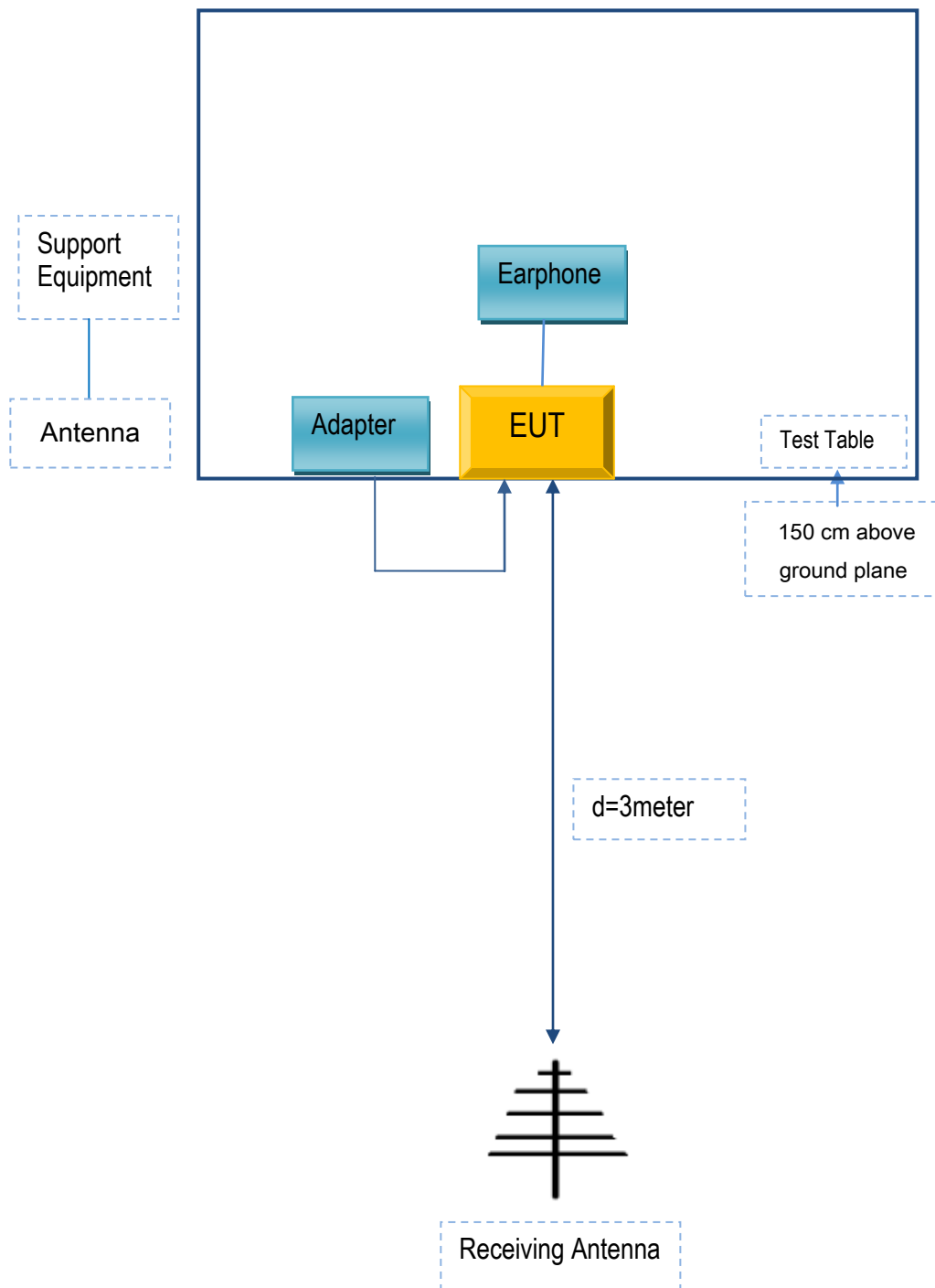

Annex C. ii. SUPPORTING EQUIPMENT DESCRIPTION

The following is a description of supporting equipment and details of cables used with the EUT.

Supporting Equipment:

Manufacturer	Equipment Description	Model	Serial No
TECNO MOBILE LIMITED	Adapter	CU-52JT	N/A
TECNO MOBILE LIMITED	Earphone	K8	N/A

Supporting Cable:

Cable type	Shield Type	Ferrite Core	Length	Serial No
USB Cable	Un-shielding	No	0.8m	N/A

Annex C.ii. EUT OPERATING CONKITIONS

N/A

Test Report	17071091-FCC-R5
Page	110 of 111

Annex D. User Manual / Block Diagram / Schematics / Partlist

Please see the attachment

Test Report	17071091-FCC-R5
Page	111 of 111

Annex E. DECLARATION OF SIMILARITY

N/A