

# RF TEST REPORT

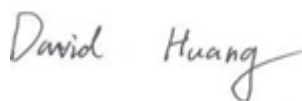

Report No.: 17071091-FCC-R1

Supersede Report No.: N/A

Applicant	TECNO MOBILE LIMITED	
Product Name	Mobile phone	
Model No.	K8	
Serial No.	N/A	
Test Standard	FCC Part 22(H):2016 ;FCC Part 24(E):2016; FCC Part 27:2016; ANSI/TIA-603-D: 2010	
Test Date	October 17 to November 07, 2017	
Issue Date	November 08, 2017	
Test Result	<input checked="" type="checkbox"/> Pass <input type="checkbox"/> Fail	
Equipment complied with the specification	<input checked="" type="checkbox"/>	
Equipment did not comply with the specification	<input type="checkbox"/>	
		
Loren Luo Test Engineer	David Huang Checked By	
This test report may be reproduced in full only Test result presented in this test report is applicable to the tested sample only		

Issued by:

**SIEMIC (SHENZHEN-CHINA) LABORATORIES**

Zone A, Floor 1, Building 2 Wan Ye Long Technology Park

South Side of Zhoushi Road, Bao' an District, Shenzhen, Guangdong China 518108

Phone: +86 0755 2601 4629801 Email: [China@siemic.com.cn](mailto:China@siemic.com.cn)

## Laboratories Introduction

SIEMIC, headquartered in the heart of Silicon Valley, with superior facilities in US and Asia, is one of the leading independent testing and certification facilities providing customers with one-stop shop services for Compliance Testing and Global Certifications.



In addition to testing and certification, SIEMIC provides initial design reviews and compliance management throughout a project. Our extensive experience with China, Asia Pacific, North America, European, and International compliance requirements, assures the fastest, most cost effective way to attain regulatory compliance for the global markets.

### Accreditations for Conformity Assessment

Country/Region	Scope
USA	EMC, RF/Wireless, SAR, Telecom
Canada	EMC, RF/Wireless, SAR, Telecom
Taiwan	EMC, RF, Telecom, SAR, Safety
Hong Kong	RF/Wireless, SAR, Telecom
Australia	EMC, RF, Telecom, SAR, Safety
Korea	EMI, EMS, RF, SAR, Telecom, Safety
Japan	EMI, RF/Wireless, SAR, Telecom
Singapore	EMC, RF, SAR, Telecom
Europe	EMC, RF, SAR, Telecom, Safety

Test Report	17071091-FCC-R1
Page	3 of 106

This page has been left blank intentionally.

# CONTENTS

1. REPORT REVISION HISTORY .....	5
2. CUSTOMER INFORMATION .....	5
3. TEST SITE INFORMATION .....	6
4. EQUIPMENT UNDER TEST (EUT) INFORMATION .....	7
5. TEST SUMMARY .....	11
6. MEASUREMENTS, EXAMINATION AND DERIVED RESULTS .....	12
6.1 RF EXPOSURE (SAR).....	12
6.2 RF OUTPUT POWER.....	13
6.3 PEAK-AVERAGE RATIO.....	26
6.4 OCCUPIED BANDWIDTH.....	31
6.5 SPURIOUS EMISSIONS AT ANTENNA TERMINALS.....	46
6.6 SPURIOUS RADIATED EMISSIONS.....	62
6.7 BAND EDGE.....	69
6.8 FREQUENCY STABILITY .....	83
ANNEX A. TEST INSTRUMENT.....	88
ANNEX B. EUT AND TEST SETUP PHOTOGRAPHS.....	90
ANNEX C. TEST SETUP AND SUPPORTING EQUIPMENT.....	102
ANNEX C.II. EUT OPERATING CONKITIONS .....	104
ANNEX D. USER MANUAL / BLOCK DIAGRAM / SCHEMATICS / PARTLIST .....	105
ANNEX E. DECLARATION OF SIMILARITY.....	106

## 1. Report Revision History

Report No.	Report Version	Description	Issue Date
17071091-FCC-R1	NONE	Original	November 08, 2017

## 2. Customer information

Applicant Name	TECNO MOBILE LIMITED
Applicant Add	ROOMS 05-15, 13A/F., SOUTH TOWER, WORLD FINANCE CENTRE, HARBOUR CITY, 17 CANTON ROAD, TSIM SHA TSUI, KOWLOON, HONG KONG
Manufacturer	SHENZHEN TECNO TECHNOLOGY CO.,LTD.
Manufacturer Add	1-4th Floor,3rd Building,Pacific Industrial Park,No.2088,Shenyan Road,Yantian District,Shenzhen,Guangdong,China

### 3. Test site information

Test Lab A:

Lab performing tests	SIEMIC (Shenzhen-China) LABORATORIES
Lab Address	Zone A, Floor 1, Building 2 Wan Ye Long Technology Park South Side of Zhoushi Road, Bao' an District, Shenzhen, Guangdong China 518108
FCC Test Site No.	535293
IC Test Site No.	4842E-1
Test Software	Radiated Emission Program-To Shenzhen v2.0

Test Lab B:

Lab performing tests	SIEMIC (Nanjing-China) Laboratories
Lab Address	2-1 Longcang Avenue Yuhua Economic and Technology Development Park, Nanjing, China
FCC Test Site No.	694825
IC Test Site No.	4842B-1
Test Software	EZ_EMV(ver.lcp-03A1)

Note: We just perform Radiated Spurious Emission above 18GHz in the test Lab. B.

## 4. Equipment under Test (EUT) Information

Description of EUT:	Mobile phone
Main Model:	K8
Serial Model:	N/A
Date EUT received:	October 17, 2017
Test Date(s):	October 17 to November 07, 2017
Equipment Category :	PCE
Antenna Gain:	GSM850: -0.2dBi PCS1900: 1.7dBi UMTS-FDD Band V: -0.2dBi UMTS-FDD Band IV: 1.7dBi UMTS-FDD Band II: 1.7dBi LTE Band II:1.7dBi LTE Band IV: 1.7dBi LTE Band VII:2.5dBi Bluetooth/BLE: 2.0dBi WIFI: 2.0dBi GPS:1.7dBi
Antenna Type:	PIFA antenna
Type of Modulation:	GSM / GPRS: GMSK EGPRS: GMSK,8PSK UMTS-FDD: QPSK LTE Band: QPSK, 16QAM 802.11b/g/n: DSSS, OFDM Bluetooth: GFSK, $\pi$ /4DQPSK, 8DPSK BLE: GFSK GPS:BPSK





GSM Voice:GSM850: 30.07dBm / ERP  
                   PCS1900: 30.92dBm / EIRP  
 GPRS:GSM850: 30.04 dBm / ERP  
                   PCS1900: 30.88 dBm / EIRP  
 EGPRS(MCS5):GSM850: 24.16 dBm / ERP  
                   PCS1900: 27.15 dBm / EIRP  
 RMC:UMTS-FDD Band V: 20.28dBm / ERP  
 ERP/EIRP:      UMTS-FDD Band II: 24.14 dBm / EIRP  
                   UMTS-FDD Band IV: 24.22 dBm / EIRP  
 HSDPA:UMTS-FDD Band V: 19.67dBm / ERP  
                   UMTS-FDD Band II: 23.60 dBm / EIRP  
                   UMTS-FDD Band IV: 23.46dBm / EIRP  
 HSUPA:UMTS-FDD Band V: 19.67 dBm / ERP  
                   UMTS-FDD Band II: 23.56dBm / EIRP  
                   UMTS-FDD Band IV: 22.48dBm / EIRP

GSM 850: 124CH  
 PCS1900: 299CH  
 UMTS-FDD Band V: 102CH  
 UMTS-FDD Band IV: 202CH  
 UMTS-FDD Band II: 277CH  
 Number of Channels: WIFI :802.11b/g/n(20M): 11CH  
                           WIFI :802.11n(40M): 7CH  
                           Bluetooth: 79CH  
                           BLE: 40CH  
                           GPS:1CH

Port:                  USB Port, Earphone Port

Adapter:  
 Model: CU-52JT  
 Input: AC100-240V~50/60Hz,200mA  
 Input Power:      Output: DC 5.0V~1.2A  
 Battery:  
 Model: BL-30RT  
 Rating: 3.85V, 3000mAh, 11.55Wh  
 Limited charge voltage: 4.4V

Trade Name :          TECNO



Test Report	17071091-FCC-R1
Page	10 of 106

GPRS/EGPRS Multi-slot class      8/10/11/12

FCC ID:                                      2ADYY-K8

## 5. Test Summary

The product was tested in accordance with the following specifications.

All testing has been performed according to below product classification:

FCC Rules	Description of Test	Result
§ 1.1307; § 2.1093	RF Exposure (SAR)	Compliance
§2.1046; § 22.913(a); § 24.232(c); § 27.50(c.10) ; § 27.50(d.4)	RF Output Power	Compliance
§ 24.232 (d) ; § 27.50(d)	Peak-Average Ratio	Compliance
§ 2.1049; § 22.905; § 22.917; § 24.238; § 27.53(a.5)	99% & -26 dB Occupied Bandwidth	Compliance
§ 2.1051; § 22.917(a); § 24.238(a); § 27.53(h)	Spurious Emissions at Antenna Terminal	Compliance
§ 2.1053; § 22.917(a); § 24.238(a); § 27.53(h)	Field Strength of Spurious Radiation	Compliance
§ 22.917(a); § 24.238(a); § 27.53(h)	Out of band emission, Band Edge	Compliance
§ 2.1055; § 22.355; § 24.235; § 27.5(h); § 27.54	Frequency stability vs. temperature Frequency stability vs. voltage	Compliance

Note: Testing was performed by configuring EUT to maximum output power status, the declared output power class for different

### Measurement Uncertainty

Emissions		
Test Item	Description	Uncertainty
Band Edge and Radiated Spurious Emissions	Confidence level of approximately 95% (in the case where distributions are normal), with a coverage factor of 2 (for EUTs < 0.5m X 0.5m X 0.5m)	+5.6dB/-4.5dB
-	-	-

## **6. MEASUREMENTS, EXAMINATION AND DERIVED RESULTS**

### 6.1 RF Exposure (SAR)

Test Result: Pass

The EUT is a portable device, thus requires SAR evaluation;

Please refer to RF Exposure Evaluation Report: 17071091-FCC-H.

## 6.2 RF Output Power

Temperature	26°C
Relative Humidity	56%
Atmospheric Pressure	1022mbar
Test date :	October 26, 2017
Tested By :	Loren Luo

### Requirement(s):

Spec	Item	Requirement	Applicable
§22.913 (a)	a)	ERP:38.45dBm	<input checked="" type="checkbox"/>
§24.232 (c)	b)	EIRP:33dBm	<input checked="" type="checkbox"/>
§27.50 (c)	c)	EIRP: 30dBm	<input checked="" type="checkbox"/>

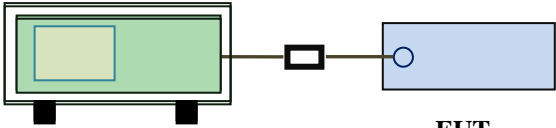
Test Setup	 <p style="text-align: center;">Base Station                      EUT</p>
------------	---

Test Procedure	<p>For Conducted Power:</p> <ul style="list-style-type: none"> <li>- The transmitter output port was connected to base station.</li> <li>- Set EUT at maximum power through base station.</li> <li>- Select lowest, middle, and highest channels for each band and different test mode.</li> </ul> <p>For ERP/EIRP:</p> <p>According with KDB 971168 v02r02</p> <ul style="list-style-type: none"> <li>- The transmitter was placed on a wooden turntable, and it was transmitting into a non-radiating load which was also placed on the turntable.</li> <li>- The measurement antenna was placed at a distance of 3 meters from the EUT. During the tests, the antenna height and polarization as well as EUT azimuth were varied in order to identify the maximum level of emissions from the EUT. The test was performed by placing the EUT on 3-orthogonal axis.</li> <li>- The frequency range up to tenth harmonic of the fundamental</li> </ul>
----------------	---

	<p>frequency was investigated.</p> <ul style="list-style-type: none"> <li>- Remove the EUT and replace it with substitution antenna. A signal generator was connected to the substitution antenna by a non-radiating cable. The absolute levels of the spurious emissions were measured by the substitution.</li> <li>- Spurious emissions in dB = <math>10 \log (\text{TX power in Watts}/0.001)</math> – the absolute level</li> <li>- Spurious attenuation limit in dB = <math>43 + 10 \text{ Log}_{10} (\text{power out in Watts})</math>.</li> </ul>
Remark	
Result	<input checked="" type="checkbox"/> Pass <input type="checkbox"/> Fail

Test Data     Yes                       N/A  
 Test Plot     Yes (See below)             N/A

## Conducted Power

### GSM Mode:

Burst Average Power (dBm);								
Band	GSM850				PCS1900			
Channel	128	190	251	Tune up Power tolerant	512	661	810	Tune up Power tolerant
Frequency (MHz)	824.2	836.6	848.8	/	1850.2	1880	1909.8	/
GSM Voice (1 uplink),GMSK	32.31	32.25	<b>32.42</b>	32±1	29.12	29.15	<b>29.22</b>	29±1
GPRS Multi-Slot Class 8 (1 uplink),GMSK	32.29	32.24	<b>32.39</b>	32±1	29.10	29.12	<b>29.18</b>	29±1
GPRS Multi-Slot Class 10 (2 uplink),GMSK	31.37	31.52	31.43	31±1	28.53	28.44	28.39	28±1
GPRS Multi-Slot Class 11 (3 uplink) GMSK	29.33	29.65	29.72	30±1	26.33	26.36	26.45	26±1
GPRS Multi-Slot Class 12 (4 uplink) GMSK	28.44	28.46	28.52	28±1	25.66	25.59	25.36	25±1
EGPRS Multi-Slot Class 8 (1 uplink) GMSK MCS1	32.30	32.22	<b>32.36</b>	32±1	29.17	29.11	<b>29.17</b>	29±1
EGPRS Multi-Slot Class 10 (2 uplink) GMSK MCS1	31.22	31.40	31.49	31±1	28.60	28.55	28.36	28±1
EGPRS Multi-Slot Class 11 (3 uplink) GMSK MCS1	29.57	29.65	29.42	29±1	26.74	26.59	26.47	27±1
EGPRS Multi-Slot Class 12 (4 uplink) GMSK MCS1	28.38	28.47	28.55	28±1	25.33	25.27	25.3	25±1
EGPRS Multi-Slot Class 8 (1 uplink) 8PSK MCS5	26.44	26.48	<b>26.51</b>	26±1	25.41	25.36	<b>25.45</b>	25±1

EGPRS Multi-Slot Class 10 (2 uplink) 8PSK MCS5	25.22	25.51	25.47	25±1	24.72	24.65	24.57	25±1
EGPRS Multi-Slot Class 11 (3 uplink) 8PSK MCS5	23.55	23.43	23.37	23±1	22.85	22.66	22.31	22±1
EGPRS Multi-Slot Class 12 (4 uplink) 8PSK MCS5	21.42	21.37	21.48	21.3±1	21.33	21.4	21.28	21.3±1

Remark :

GPRS, CS1 coding scheme.

EGPRS, MCS1 coding scheme.

EGPRS, MCS5 coding scheme.

Multi-Slot Class 8 , Support Max 4 downlink, 1 uplink , 5 working link

Multi-Slot Class 10 , Support Max 4 downlink, 2 uplink , 5 working link

Multi-Slot Class 11 , Support Max 4 downlink, 2 uplink , 5 working link

Multi-Slot Class 12 , Support Max 4 downlink, 4 uplink , 5 working link



## UMTS Mode:

### UMTS-FDD Band V

Band/ Time Slot configuration	Channel	Frequency	Average power (dBm)	Tune up Power tolerant
RMC 12.2kbps	4132	826.4	22.45	23±1
	4175	835	22.51	23±1
	4233	846.6	22.63	23±1
HSDPA Subtest1	4132	826.4	21.73	22±1
	4175	835	21.77	22±1
	4233	846.6	21.87	22±1
HSDPA Subtest2	4132	826.4	21.87	22±1
	4175	835	21.88	22±1
	4233	846.6	21.97	22±1
HSDPA Subtest3	4132	826.4	21.69	22±1
	4175	835	21.79	22±1
	4233	846.6	21.85	22±1
HSDPA Subtest4	4132	826.4	21.89	22±1
	4175	835	21.92	22±1
	4233	846.6	22.02	22±1
HSUPA Subtest1	4132	826.4	21.82	22±1
	4175	835	21.87	22±1
	4233	846.6	21.84	22±1
HSUPA Subtest2	4132	826.4	21.79	22±1
	4175	835	21.82	22±1
	4233	846.6	21.88	22±1
HSUPA Subtest3	4132	826.4	21.70	22±1
	4175	835	21.90	22±1
	4233	846.6	21.93	22±1
HSUPA Subtest4	4132	826.4	21.53	22±1
	4175	835	21.73	22±1
	4233	846.6	21.72	22±1
HSUPA Subtest5	4132	826.4	21.69	22±1
	4175	835	22.01	22±1
	4233	846.6	22.02	22±1

## UMTS-FDD Band II

Band/ Time Slot configuration	Channel	Frequency	Average power (dBm)	Tune up Power tolerant
RMC 12.2kbps	9262	1852.4	22.37	22±1
	9400	1880	22.42	22±1
	9538	1907.6	22.44	22±1
HSDPA Subtest1	9262	1852.4	21.71	21.3±1
	9400	1880	21.73	21.3±1
	9538	1907.6	21.80	21.3±1
HSDPA Subtest2	9262	1852.4	21.86	21.3±1
	9400	1880	21.90	21.3±1
	9538	1907.6	21.76	21.3±1
HSDPA Subtest3	9262	1852.4	21.75	21.3±1
	9400	1880	21.71	21.3±1
	9538	1907.6	21.64	21.3±1
HSDPA Subtest4	9262	1852.4	21.77	21.3±1
	9400	1880	21.83	21.3±1
	9538	1907.6	21.72	21.3±1
HSUPA Subtest1	9262	1852.4	21.75	21.3±1
	9400	1880	21.65	21.3±1
	9538	1907.6	21.77	21.3±1
HSUPA Subtest2	9262	1852.4	21.46	21.3±1
	9400	1880	21.69	21.3±1
	9538	1907.6	21.51	21.3±1
HSUPA Subtest3	9262	1852.4	21.64	21.3±1
	9400	1880	21.72	21.3±1
	9538	1907.6	21.70	21.3±1
HSUPA Subtest4	9262	1852.4	21.46	21.3±1
	9400	1880	21.45	21.3±1
	9538	1907.6	21.62	21.3±1
HSUPA Subtest5	9262	1852.4	21.76	21.3±1
	9400	1880	21.86	21.3±1
	9538	1907.6	21.82	21.3±1

## UMTS-FDD Band IV

Band/ Time Slot configuration	Channel	Frequency	Average power (dBm)	Tune up Power tolerant
RMC 12.2kbps	1313	1712.6	22.52	22±1
	1413	1732.6	22.41	22±1
	1512	1752.4	22.38	22±1
HSDPA Subtest1	1313	1712.6	21.86	21.5±1
	1413	1732.6	21.69	21.5±1
	1512	1752.4	21.76	21.5±1
HSDPA Subtest2	1313	1712.6	21.84	21.5±1
	1413	1732.6	21.84	21.5±1
	1512	1752.4	21.81	21.5±1
HSDPA Subtest3	1313	1712.6	21.85	21.5±1
	1413	1732.6	21.64	21.5±1
	1512	1752.4	21.76	21.5±1
HSDPA Subtest4	1313	1712.6	21.90	21.5±1
	1413	1732.6	21.79	21.5±1
	1512	1752.4	21.68	21.5±1
HSUPA Subtest1	1313	1712.6	21.75	21.5±1
	1413	1732.6	21.73	21.5±1
	1512	1752.4	21.63	21.5±1
HSUPA Subtest2	1313	1712.6	21.76	21.5±1
	1413	1732.6	21.52	21.5±1
	1512	1752.4	21.72	21.5±1
HSUPA Subtest3	1313	1712.6	21.73	21.5±1
	1413	1732.6	21.62	21.5±1
	1512	1752.4	21.61	21.5±1
HSUPA Subtest4	1313	1712.6	21.70	21.5±1
	1413	1732.6	21.47	21.5±1
	1512	1752.4	21.52	21.5±1
HSUPA Subtest5	1313	1712.6	22.00	21.5±1
	1413	1732.6	21.68	21.5±1
	1512	1752.4	21.73	21.5±1

## ERP & EIRP

### GSM Voice

#### ERP for Cellular Band (Part 22H)

Frequency (MHz)	Substituted level (dBm)	Antenna Polarization	Antenna Gain correction (dBi)	Cable Loss (dB)	Absolute Level (dBm)	Limit (dBm)
824.2	24.39	V	6.1	0.53	29.96	38.45
824.2	22.85	H	6.1	0.53	28.42	38.45
836.6	24.23	V	6.2	0.53	29.90	38.45
836.6	22.25	H	6.2	0.53	27.92	38.45
848.8	24.4	V	6.2	0.53	30.07	38.45
848.8	23.1	H	6.2	0.53	28.77	38.45

#### EIRP for PCS Band (Part 24E)

Frequency (MHz)	Substituted level (dBm)	Antenna Polarization	Antenna Gain correction (dBi)	Cable Loss (dB)	Absolute Level (dBm)	Limit (dBm)
1850.2	23.66	V	7.88	0.72	30.82	33
1850.2	22.91	H	7.88	0.72	30.07	33
1880	23.69	V	7.88	0.72	30.85	33
1880	21.98	H	7.88	0.72	29.14	33
1909.8	23.78	V	7.86	0.72	30.92	33
1909.8	21.92	H	7.86	0.72	29.06	33

**GPRS:**

**ERP for Cellular Band (Part 22H)**

Frequency (MHz)	Substituted level (dBm)	Antenna Polarization	Antenna Gain correction (dBi)	Cable Loss (dB)	Absolute Level (dBm)	Limit (dBm)
824.2	24.37	V	6.1	0.53	29.94	38.45
824.2	23.02	H	6.1	0.53	28.59	38.45
836.6	24.22	V	6.2	0.53	29.89	38.45
836.6	22.38	H	6.2	0.53	28.05	38.45
848.8	24.37	V	6.2	0.53	30.04	38.45
848.8	23.4	H	6.2	0.53	29.07	38.45

**EIRP for PCS Band (Part 24E)**

Frequency (MHz)	Substituted level (dBm)	Antenna Polarization	Antenna Gain correction (dBi)	Cable Loss (dB)	Absolute Level (dBm)	Limit (dBm)
1850.2	23.64	V	7.88	0.72	30.80	33
1850.2	22.59	H	7.88	0.72	29.75	33
1880	23.66	V	7.88	0.72	30.82	33
1880	21.76	H	7.88	0.72	28.92	33
1909.8	23.74	V	7.86	0.72	30.88	33
1909.8	22.72	H	7.86	0.72	29.86	33

**EGPRS (MCS5):**

**ERP for Cellular Band (Part 22H)**

Frequency (MHz)	Substituted level (dBm)	Antenna Polarization	Antenna Gain correction (dBi)	Cable Loss (dB)	Absolute Level (dBm)	Limit (dBm)
824.2	18.52	V	6.1	0.53	24.09	38.45
824.2	16.69	H	6.1	0.53	22.26	38.45
836.6	18.46	V	6.2	0.53	24.13	38.45
836.6	17.25	H	6.2	0.53	22.92	38.45
848.8	18.49	V	6.2	0.53	24.16	38.45
848.8	16.85	H	6.2	0.53	22.52	38.45

**EIRP for PCS Band (Part 24E)**

Frequency (MHz)	Substituted level (dBm)	Antenna Polarization	Antenna Gain correction (dBi)	Cable Loss (dB)	Absolute Level (dBm)	Limit (dBm)
1850.2	19.99	V	7.88	0.72	27.15	33
1850.2	18.07	H	7.88	0.72	25.23	33
1880	19.9	V	7.88	0.72	27.06	33
1880	18.75	H	7.88	0.72	25.91	33
1909.8	19.97	V	7.86	0.72	27.11	33
1909.8	18.32	H	7.86	0.72	25.46	33

## RMC

### ERP for UMTS-FDD Band V (Part 22H)

Frequency (MHz)	Substituted level (dBm)	Antenna Polarization	Antenna Gain correction (dBi)	Cable Loss (dB)	Absolute Level (dBm)	Limit (dBm)
826.4	14.53	V	6.1	0.53	20.10	38.45
826.4	13.39	H	6.1	0.53	18.96	38.45
835	14.49	V	6.2	0.53	20.16	38.45
835	13.61	H	6.2	0.53	19.28	38.45
846.6	14.61	V	6.2	0.53	20.28	38.45
846.6	13.49	H	6.2	0.53	19.16	38.45

### EIRP for UMTS-FDD Band II (Part 24E)

Frequency (MHz)	Substituted level (dBm)	Antenna Polarization	Antenna Gain correction (dBi)	Cable Loss (dB)	Absolute Level (dBm)	Limit (dBm)
1852.4	16.91	V	7.88	0.72	24.07	33
1852.4	15.78	H	7.88	0.72	22.94	33
1880	16.96	V	7.88	0.72	24.12	33
1880	15.63	H	7.88	0.72	22.79	33
1907.6	17	V	7.86	0.72	24.14	33
1907.6	15.94	H	7.86	0.72	23.08	33

### EIRP for UMTS-FDD Band IV (Part 27H)

Frequency (MHz)	Substituted level (dBm)	Antenna Polarization	Antenna Gain correction (dBi)	Cable Loss (dB)	Absolute Level (dBm)	Limit (dBm)
1712.4	16.96	V	7.95	0.69	24.22	30
1712.4	15.92	H	7.95	0.69	23.18	30
1740	16.87	V	7.93	0.69	24.11	30
1740	15.47	H	7.93	0.69	22.71	30
1752.6	16.85	V	7.92	0.69	24.08	30
1712.4	16.96	V	7.95	0.69	24.22	30

## HSDPA

### ERP for UMTS-FDD Band V (Part 22H)

Frequency (MHz)	Substituted level (dBm)	Antenna Polarization	Antenna Gain correction (dBi)	Cable Loss (dB)	Absolute Level (dBm)	Limit (dBm)
826.4	13.97	V	6.1	0.53	19.54	38.45
826.4	12.47	H	6.1	0.53	18.04	38.45
835	13.9	V	6.2	0.53	19.57	38.45
835	12.03	H	6.2	0.53	17.70	38.45
846.6	14	V	6.2	0.53	19.67	38.45
846.6	12.86	H	6.2	0.53	18.53	38.45

### EIRP for UMTS-FDD Band II (Part 24E)

Frequency (MHz)	Substituted level (dBm)	Antenna Polarization	Antenna Gain correction (dBi)	Cable Loss (dB)	Absolute Level (dBm)	Limit (dBm)
1852.4	16.4	V	7.88	0.72	23.56	33
1852.4	15.39	H	7.88	0.72	22.55	33
1880	16.44	V	7.88	0.72	23.60	33
1880	14.5	H	7.88	0.72	21.66	33
1907.6	16.36	V	7.86	0.72	23.50	33
1907.6	15.2	H	7.86	0.72	22.34	33

### EIRP for UMTS-FDD Band IV (Part 27H)

Frequency (MHz)	Substituted level (dBm)	Antenna Polarization	Antenna Gain correction (dBi)	Cable Loss (dB)	Absolute Level (dBm)	Limit (dBm)
1712.4	16.2	V	7.95	0.69	23.46	30
1712.4	15.17	H	7.95	0.69	22.43	30
1740	16.19	V	7.93	0.69	23.43	30
1740	14.22	H	7.93	0.69	21.46	30
1752.6	16.19	V	7.92	0.69	23.42	30
1752.6	14.69	H	7.92	0.69	21.92	30



## HSUPA

### ERP for UMTS-FDD Band V (Part 22H)

Frequency (MHz)	Substituted level (dBm)	Antenna Polarization	Antenna Gain correction (dBi)	Cable Loss (dB)	Absolute Level (dBm)	Limit (dBm)
826.4	13.9	V	6.1	0.53	19.47	38.45
826.4	12.15	H	6.1	0.53	17.72	38.45
835	13.88	V	6.2	0.53	19.55	38.45
835	11.9	H	6.2	0.53	17.57	38.45
846.6	14	V	6.2	0.53	19.67	38.45
846.6	12.63	H	6.2	0.53	18.30	38.45

### EIRP for UMTS-FDD Band II (Part 24E)

Frequency (MHz)	Substituted level (dBm)	Antenna Polarization	Antenna Gain correction (dBi)	Cable Loss (dB)	Absolute Level (dBm)	Limit (dBm)
1852.4	16.3	V	7.88	0.72	23.46	33
1852.4	15.5	H	7.88	0.72	22.66	33
1880	16.4	V	7.88	0.72	23.56	33
1880	15.13	H	7.88	0.72	22.29	33
1907.6	16.38	V	7.86	0.72	23.52	33
1907.6	14.87	H	7.86	0.72	22.01	33

### EIRP for UMTS-FDD Band IV (Part 27H)

Frequency (MHz)	Substituted level (dBm)	Antenna Polarization	Antenna Gain correction (dBi)	Cable Loss (dB)	Absolute Level (dBm)	Limit (dBm)
1712.4	15.22	V	7.95	0.69	22.48	30
1712.4	13.44	H	7.95	0.69	20.70	30
1740	15.15	V	7.93	0.69	22.39	30
1740	14.25	H	7.93	0.69	21.49	30
1752.6	15.2	V	7.92	0.69	22.43	30
1752.6	13.64	H	7.92	0.69	20.87	30

### 6.3 Peak-Average Ratio

Temperature	26°C
Relative Humidity	56%
Atmospheric Pressure	1022mbar
Test date :	October 26, 2017
Tested By :	Loren Luo

Requirement(s):

Spec	Item	Requirement	Applicable
§24.232(d) § 27.50(d)	a)	The peak-to-average ratio (PAR) of the transmission may not exceed 13 dB.	<input checked="" type="checkbox"/>

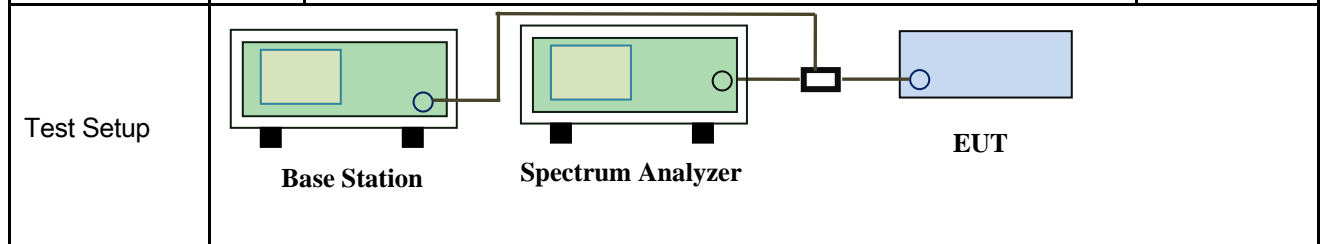

Test Procedure	<p><b>According with KDB 971168 v02r02</b></p> <p><b>5.7.2 Alternate procedure for PAPR</b></p> <p><b>5.1.2 Peak power measurements with a peak power meter</b></p> <p>The total peak output power may be measured using a broadband peak RF power meter. The power meter must have a video bandwidth that is greater than or equal to the emission bandwidth and utilize a fast-responding diode detector.</p> <p><b>5.2.3 Average power measurement with average power meter</b></p> <p>As an alternative to the use of a spectrum/signal analyzer or EMI receiver to perform a measurement of the total in-band average output power, a wideband RF average power meter with a thermocouple detector or equivalent can be used under certain conditions</p> <p>If the EUT can be configured to transmit continuously (i.e., the burst duty cycle <math>\geq 98\%</math>) and at all times the EUT is transmitting at its maximum output</p>
----------------	--

	<p>power level, then a conventional wide-band RF power meter can be used.</p> <p>If the EUT cannot be configured to transmit continuously (i.e., the burst duty cycle &lt; 98%), then there are two options for the use of an average power meter. First, a gated average power meter can be used to perform the measurement if the gating parameters can be adjusted such that the power is measured only over active transmission bursts at maximum output power levels. A conventional average power meter can also be used if the measured burst duty cycle is constant (i.e., duty cycle variations are less than <math>\pm 2</math> percent) by performing the measurement over the on/off burst cycles and then correcting (increasing) the measured level by a factor equal to <math>10\log(1/\text{duty cycle})</math></p>
Remark	
Result	<input checked="" type="checkbox"/> Pass <input type="checkbox"/> Fail

**Test Data**     Yes                       N/A  
**Test Plot**     Yes (See below)             N/A

**GSM : GSM 1900 PK-AV POWER (PART 24E)**

Frequency (MHz)	Conducted power(dBm)		Peak-Average Ratio(PAR)
	Peak	Average	
1850.2	30.22	29.12	1.1
1880	30.16	29.15	1.01
1909.8	30.18	29.22	0.96

**GPRS 1900 PK-AV POWER (PART 24E)**

Frequency (MHz)	Conducted power(dBm)		Peak-Average Ratio(PAR)
	Peak	Average	
1850.2	30.22	29.1	1.12
1880	30.14	29.12	1.02
1909.8	30.23	29.22	1.01

**EGPRS (MSC5) 1900 PK-AV POWER (PART 24E)**

Frequency (MHz)	Conducted power(dBm)		Peak-Average Ratio(PAR)
	Peak	Average	
1850.2	26.55	25.45	1.1
1880	26.41	25.36	1.05
1909.8	26.52	25.41	1.11

**RMC : UMTS-FDD Band II PK-AV POWER (PART 24E)**

Frequency (MHz)	Conducted power(dBm)		Peak-Average Ratio(PAR)
	Peak	Average	
1852.4	23.52	22.37	1.15
1880	23.62	22.42	1.2
1907.6	23.51	22.44	1.07

**UMTS-FDD Band IV PK-AV POWER (PART 27H)**

Frequency (MHz)	Conducted power(dBm)		Peak-Average Ratio(PAR)
	Peak	Average	
1713	23.69	22.52	1.17
1733	23.58	22.41	1.17
1752	23.44	22.38	1.06

**HSUPA : UMTS-FDD Band II PK-AV POWER (PART 24E)**

Frequency (MHz)	Conducted power(dBm)		Peak-Average Ratio(PAR)
	Peak	Average	
1852.4	23.26	21.75	1.51
1880	23.42	21.65	1.77
1907.6	23.19	21.77	1.42

**UMTS-FDD Band IV PK-AV POWER (PART 27H)**

Frequency (MHz)	Conducted power(dBm)		Peak-Average Ratio(PAR)
	Peak	Average	
1713	23.22	21.75	1.47
1733	23.52	21.73	1.79
1752	23.19	21.63	1.56

**HSDPA : UMTS-FDD Band II PK-AV POWER (PART 24E)**

Frequency (MHz)	Conducted power(dBm)		Peak-Average Ratio(PAR)
	Peak	Average	
1852.4	23.22	21.71	1.51
1880	23.15	21.73	1.42
1907.6	23.18	21.8	1.38

**UMTS-FDD Band IV PK-AV POWER (PART 27H)**

Frequency (MHz)	Conducted power(dBm)		Peak-Average Ratio(PAR)
	Peak	Average	
1713	23.16	21.86	1.3
1733	23.22	21.69	1.53
1752	23.62	21.76	1.86

## 6.4 Occupied Bandwidth

Temperature	26°C
Relative Humidity	56%
Atmospheric Pressure	1022mbar
Test date :	October 26, 2017
Tested By :	Loren Luo

### Requirement(s):

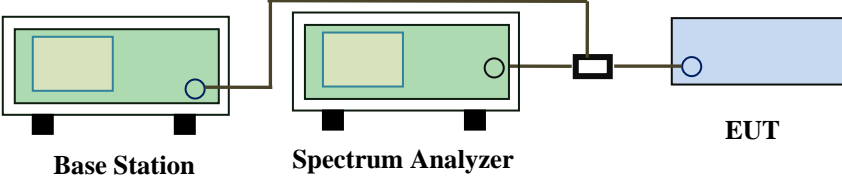
Spec	Item	Requirement	Applicable
§2.1049, §22.917, §22.905 §24.238 §27.53(a)	a)	99% Occupied Bandwidth(kHz)	<input checked="" type="checkbox"/>
	b)	26 dB Bandwidth(kHz)	<input checked="" type="checkbox"/>
Test Setup	 <p style="text-align: center;"> <span style="margin-right: 100px;">Base Station</span> <span style="margin-right: 100px;">Spectrum Analyzer</span> <span>EUT</span> </p>		
Test Procedure	<ul style="list-style-type: none"> <li>- The EUT was connected to Spectrum Analyzer and Base Station via power divider.</li> <li>- The 99% and 26 dB occupied bandwidth (BW) of the middle channel for the highest RF powers.</li> </ul>		
Remark			
Result	<input checked="" type="checkbox"/> Pass <input type="checkbox"/> Fail		

Test Data     Yes                       N/A  
 Test Plot     Yes (See below)             N/A

**GSM Voice:**

**Cellular Band (Part 22H) result**

Channel	Frequency (MHz)	99% Occupied Bandwidth (kHz)	26 dB Bandwidth (kHz)
128	824.2	247.7540	321.030
190	836.6	246.0196	320.531
251	848.8	246.7818	321.052

**PCS Band (Part 24E) result**

Channel	Frequency (MHz)	99% Occupied Bandwidth (kHz)	26 dB Bandwidth (kHz)
512	1850.2	246.7286	320.058
661	1880.0	252.2943	321.246
810	1909.8	245.8047	320.436

**GPRS:**

**Cellular Band (Part 22H) result**

Channel	Frequency (MHz)	99% Occupied Bandwidth (kHz)	26 dB Bandwidth (kHz)
128	824.2	244.8332	320.664
190	836.6	244.0516	320.387
251	848.8	247.5624	321.149

**PCS Band (Part 24E) result**

Channel	Frequency (MHz)	99% Occupied Bandwidth (kHz)	26 dB Bandwidth (kHz)
512	1850.2	246.2740	320.588
661	1880.0	248.0255	320.016
810	1909.8	247.3095	320.728



**EGPRS (MCS 5):**

**Cellular Band (Part 22H) result**

Channel	Frequency (MHz)	99% Occupied Bandwidth (kHz)	26 dB Bandwidth (kHz)
128	824.2	250.7865	320.777
190	836.6	244.8382	321.120
251	848.8	252.5136	321.225

**PCS Band (Part 24E) result**

Channel	Frequency (MHz)	99% Occupied Bandwidth (kHz)	26 dB Bandwidth (kHz)
512	1850.2	244.6422	320.244
661	1880.0	247.3812	323.014
810	1909.8	249.5094	320.105

**RMC:**

**UMTS-FDD Band V (Part 22H)**

Channel	Frequency (MHz)	99% Occupied Bandwidth (MHz)	26 dB Bandwidth (MHz)
4132	826.6	4.2130	4.898
4175	835.0	4.2123	4.912
4233	846.4	4.2075	4.915

**UMTS-FDD Band II (Part 24E)**

Channel	Frequency (MHz)	99% Occupied Bandwidth (MHz)	26 dB Bandwidth (MHz)
9262	1852.4	4.2052	4.912
9400	1880.0	4.2068	4.896
9538	1907.6	4.2628	4.957

**UMTS-FDD Band IV (Part 27)**

Channel	Frequency (MHz)	99% Occupied Bandwidth (MHz)	26 dB Bandwidth (MHz)
1313	1713	4.2102	4.880
1413	1733	4.2101	4.901
1512	1752	4.1952	4.890

**HSDPA:**

**UMTS-FDD Band V (Part 22H)**

Channel	Frequency (MHz)	99% Occupied Bandwidth (MHz)	26 dB Bandwidth (MHz)
4132	826.6	4.2195	4.914
4175	835.0	4.2034	4.871
4233	846.6	4.2090	4.911

**UMTS-FDD Band II (Part 24E)**

Channel	Frequency (MHz)	99% Occupied Bandwidth (MHz)	26 dB Bandwidth (MHz)
9262	1852.4	4.2036	4.908
9400	1880.0	4.2187	4.887
9538	1907.6	4.2513	4.956

**UMTS-FDD Band IV (Part 27)**

Channel	Frequency (MHz)	99% Occupied Bandwidth (MHz)	26 dB Bandwidth (MHz)
1313	1713	4.2139	4.882
1413	1733	4.1901	4.885
1512	1752	4.2059	4.913

**HSUPA:**

**UMTS-FDD Band V (Part 22H)**

Channel	Frequency (MHz)	99% Occupied Bandwidth (MHz)	26 dB Bandwidth (MHz)
4132	826.4	4.2211	4.916
4175	835.0	4.2110	4.914
4233	846.6	4.2082	4.899

**UMTS-FDD Band II (Part 24E)**

Channel	Frequency (MHz)	99% Occupied Bandwidth (MHz)	26 dB Bandwidth (MHz)
9262	1852.4	4.2121	4.915
9400	1880.0	4.2077	4.896
9538	1907.6	4.1917	4.861

**UMTS-FDD Band IV (Part 27)**

Channel	Frequency (MHz)	99% Occupied Bandwidth (MHz)	26 dB Bandwidth (MHz)
1313	1713	4.1994	4.875
1413	1733	4.2017	4.895
1512	1752	4.2127	4.900

### Test Plots

#### GMS Voice:

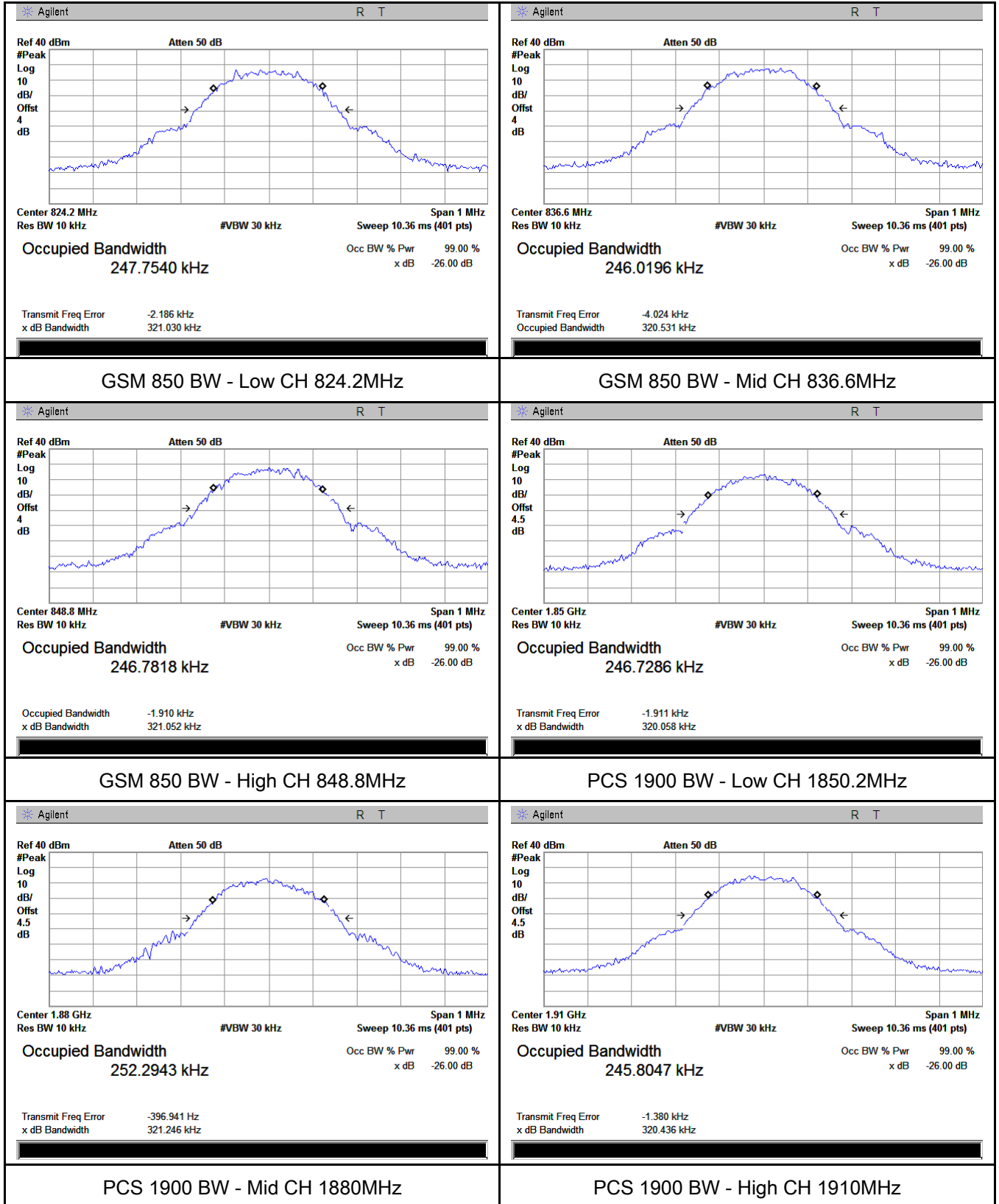

**GPRS:**

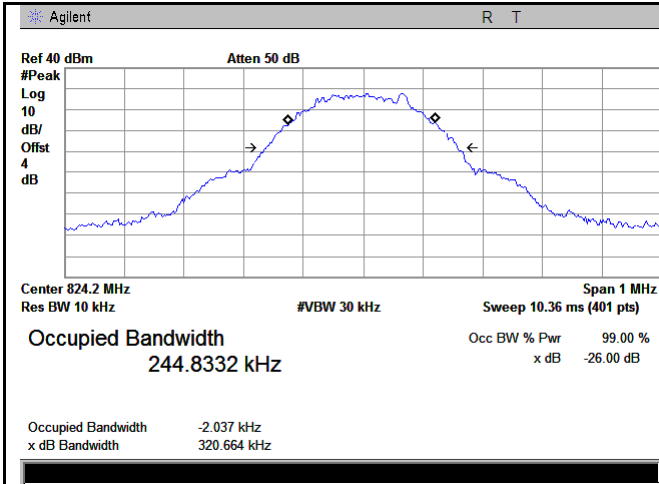

**GSM 850 BW - Low CH 824.2MHz**

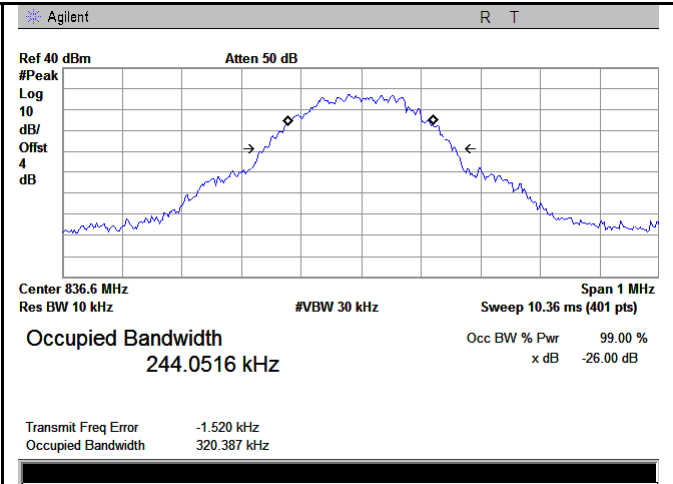

**GSM 850 BW - Mid CH 836.6MHz**

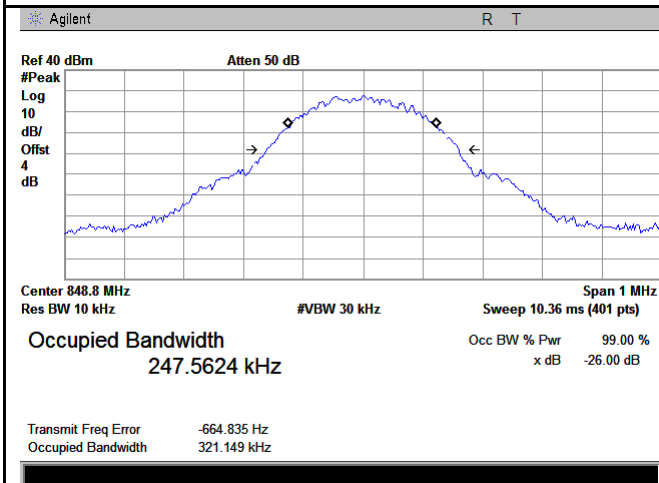

**GSM 850 BW - High CH 848.8MHz**

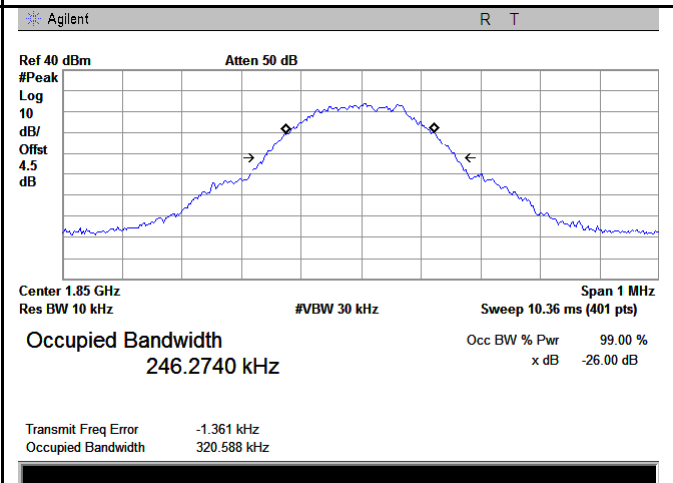

**PCS 1900 BW - Low CH 1850.2MHz**

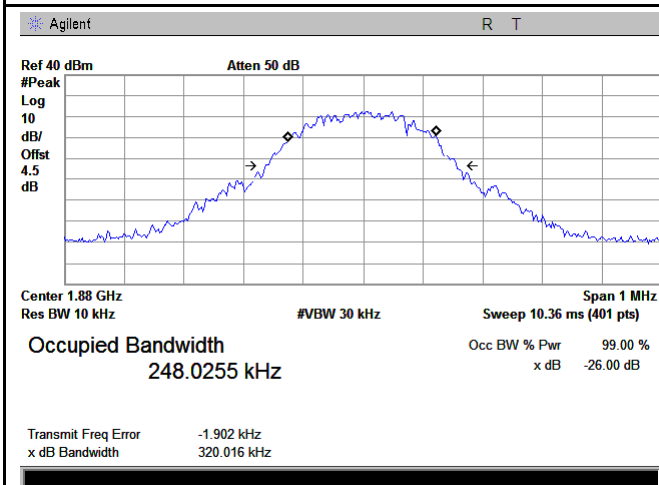

**PCS 1900 BW - Mid CH 1880MHz**

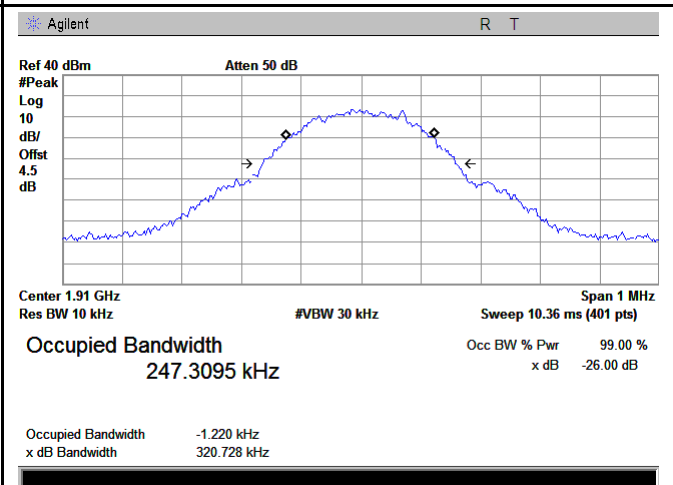

**PCS 1900 BW - High CH 1910MHz**

**EGPRS:**

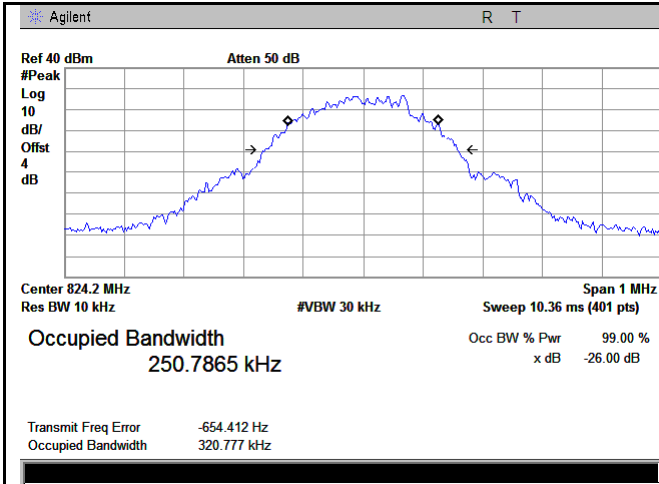

GSM 850 BW - Low CH 824.2MHz

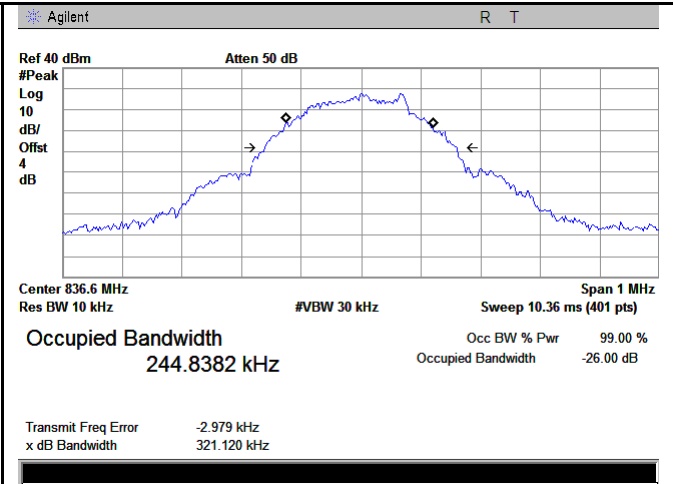

GSM 850 BW - Mid CH 836.6MHz

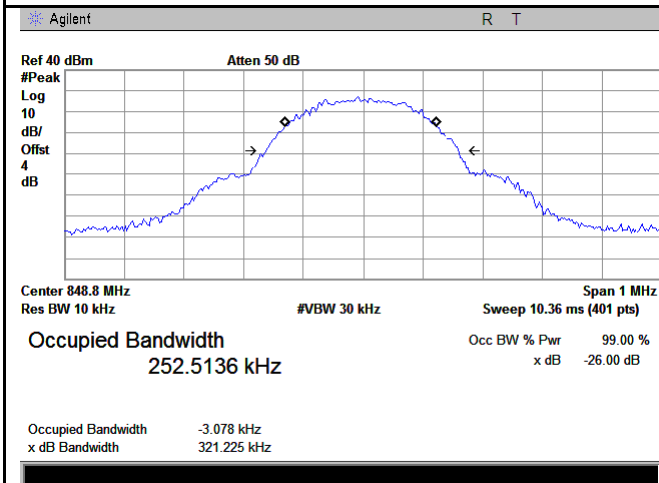

GSM 850 BW - High CH 848.8MHz

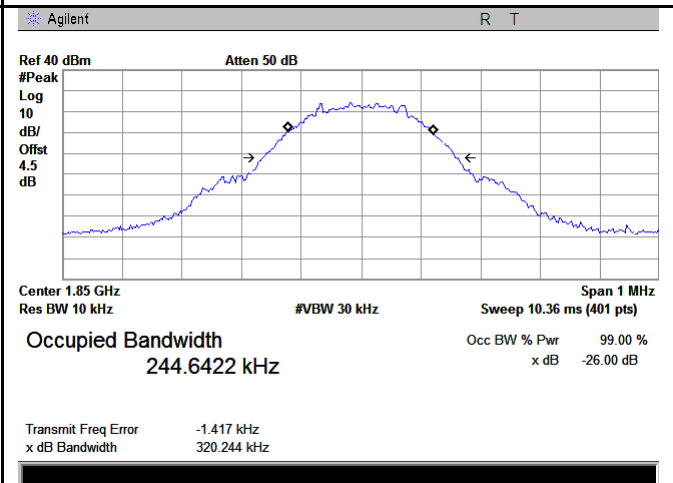

PCS 1900 BW - Low CH 1850.2MHz

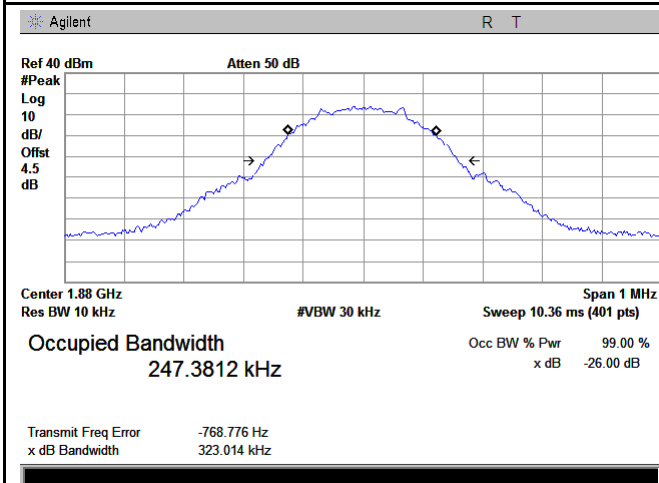

PCS 1900 BW - Mid CH 1880MHz

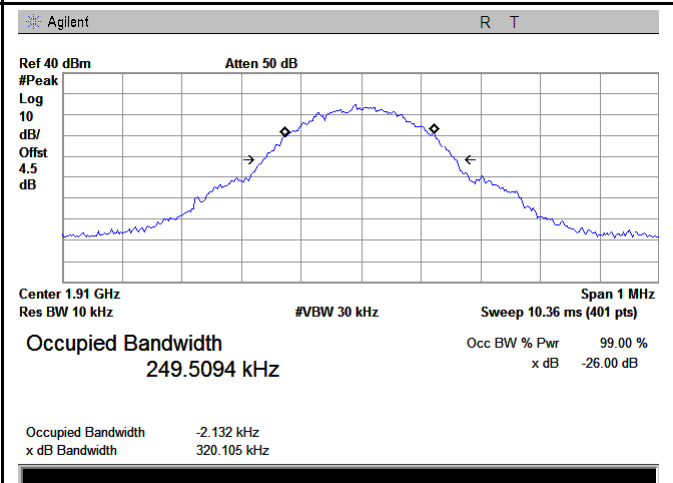

PCS 1900 BW - High CH 1910MHz

RMC:

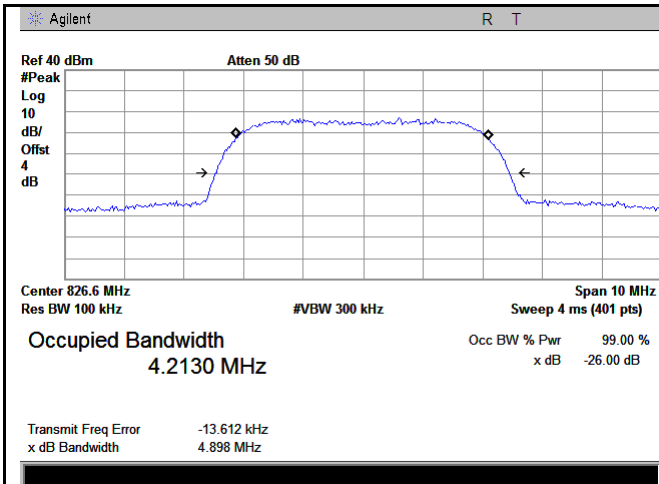

Band V BW - Low CH 826.6 MHz

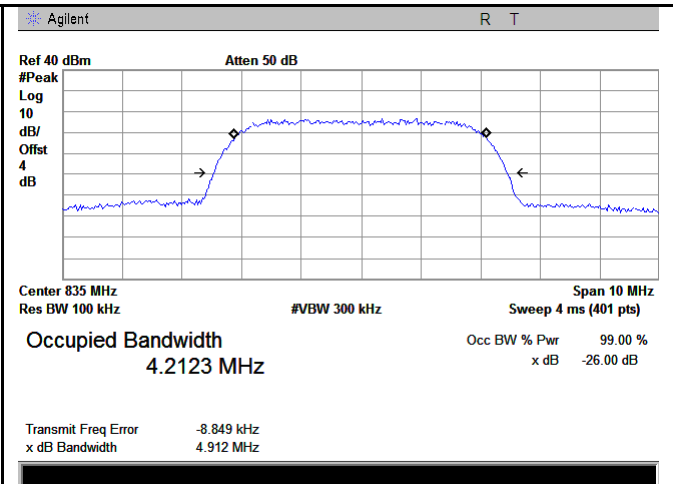

Band V BW - Mid CH 835.0 MHz

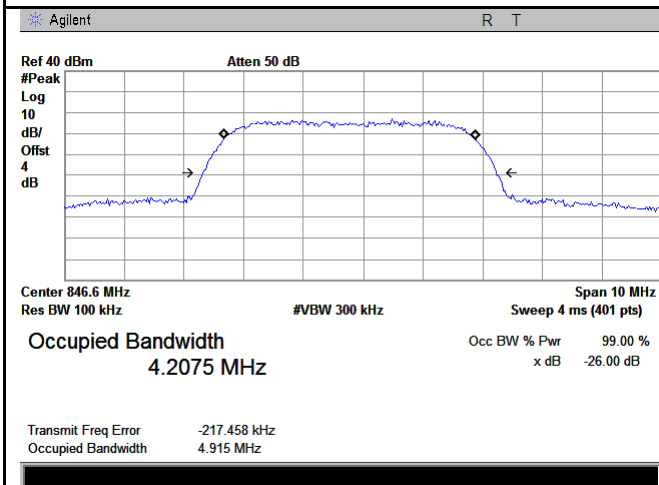

Band V BW - High CH 846.6 MHz

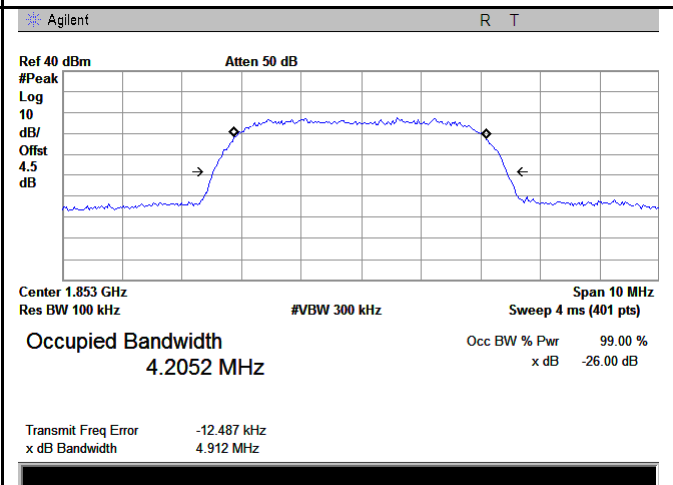

Band II BW - Low CH 1853MHz

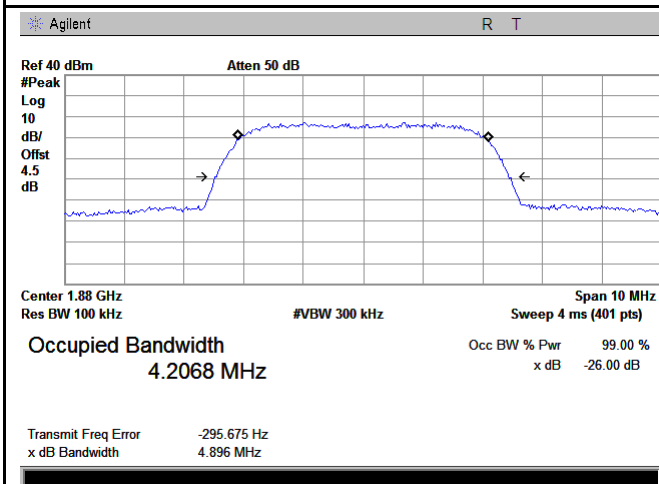

Band II BW - Mid CH 1880MHz

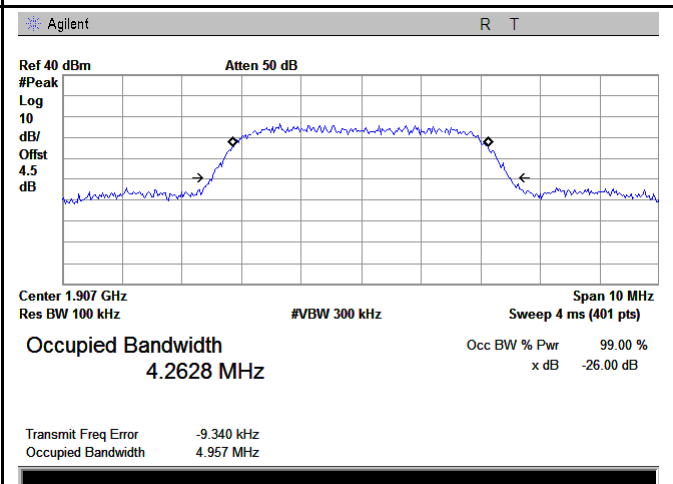

Band II BW - High CH 1907MHz



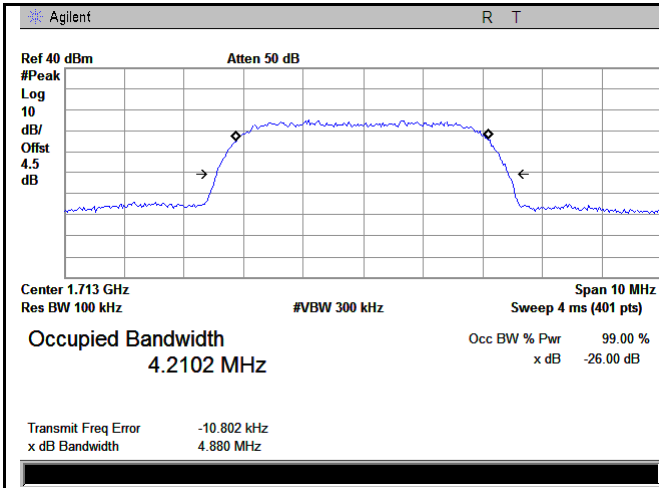

Band IV BW - Low CH 1713MHz

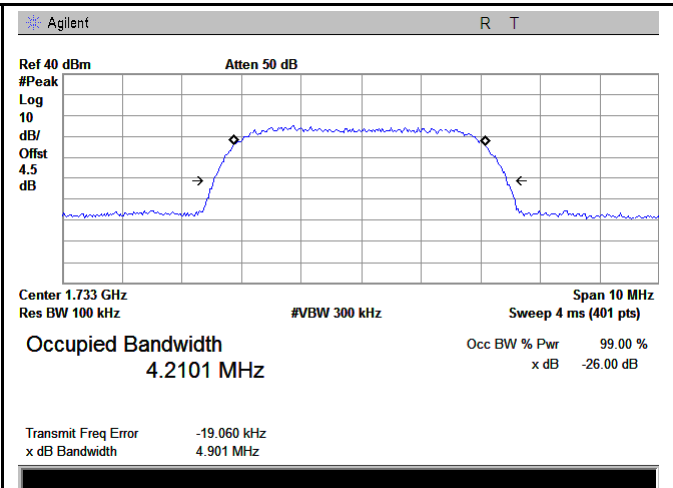

Band IVBW - Mid CH 1733MHz

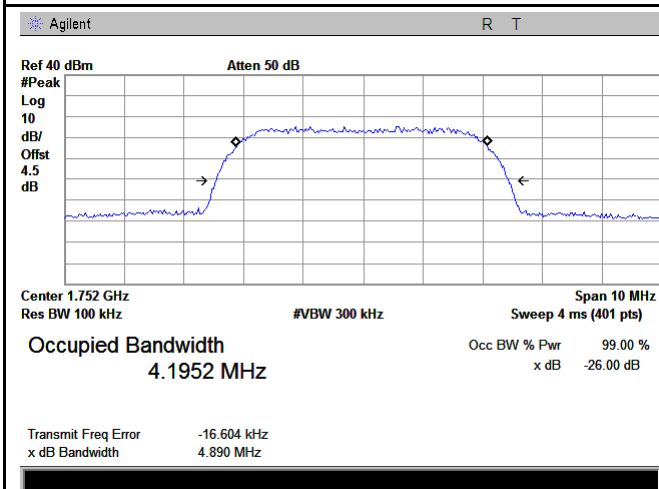

Band IV BW - High CH 1752MHz

HSDPA:

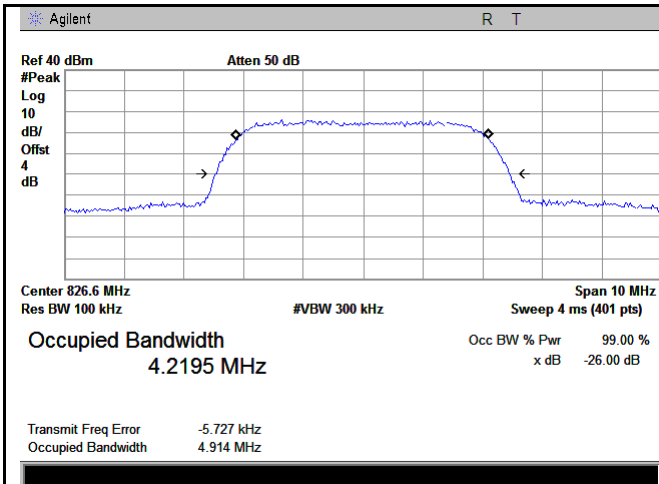

Band V BW - Low CH 826.6 MHz

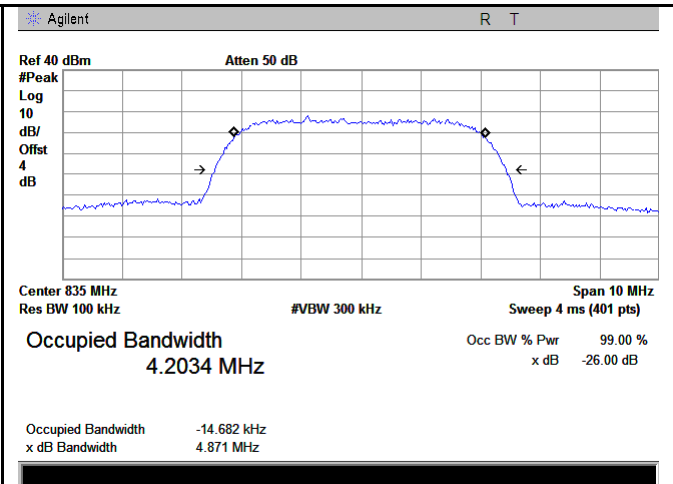

Band V BW - Mid CH 835.0 MHz

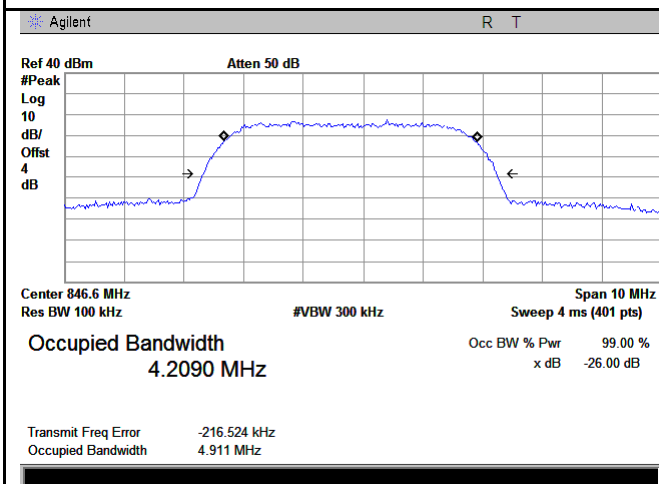

Band V BW - High CH 846.4 MHz

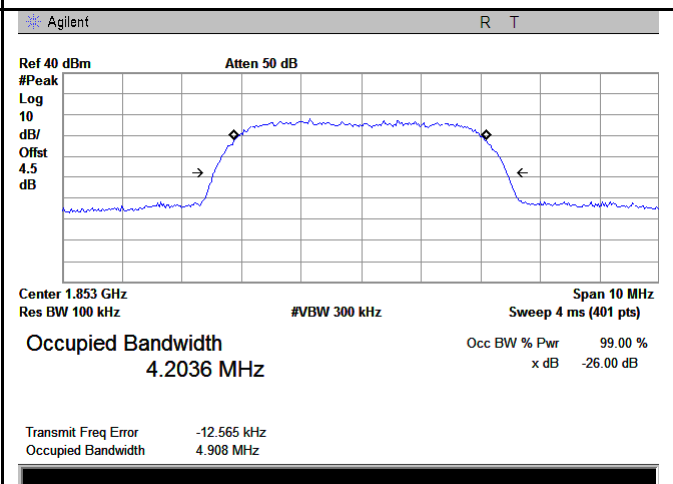

Band II BW - Low CH 1852.4MHz

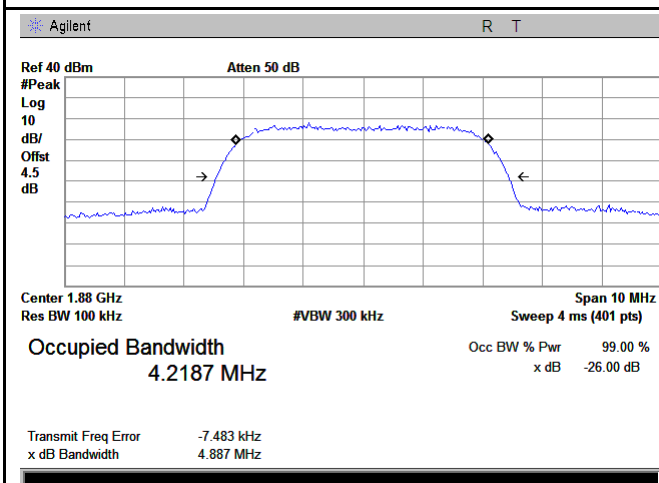

Band II BW - Mid CH 1880MHz

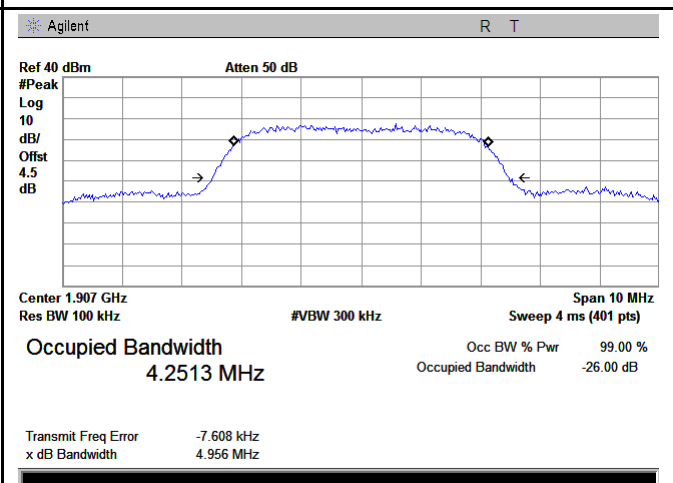

Band II BW - High CH 1907MHz

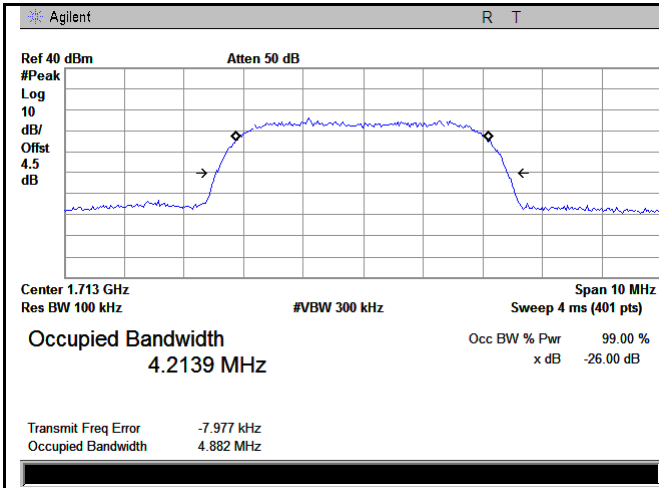

Band IV BW - Low CH 1713MHz

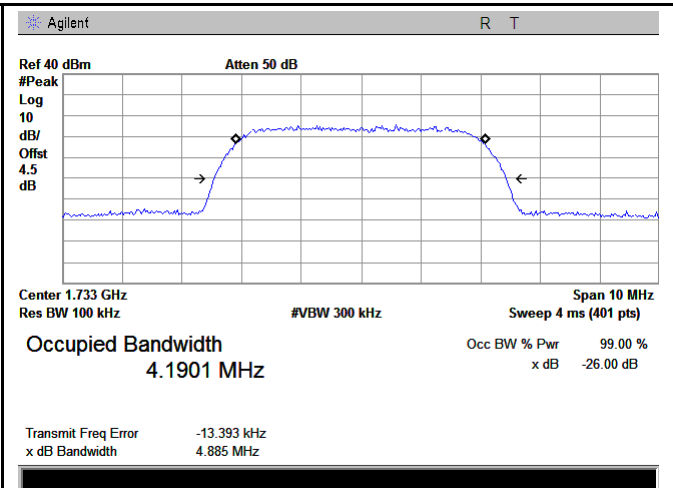

Band IVBW - Mid CH 1733MHz

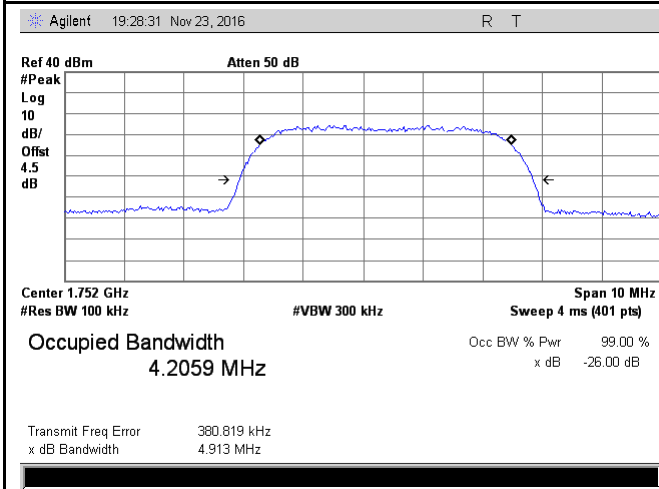

Band IV BW - High CH 1752MHz

HSUPA:

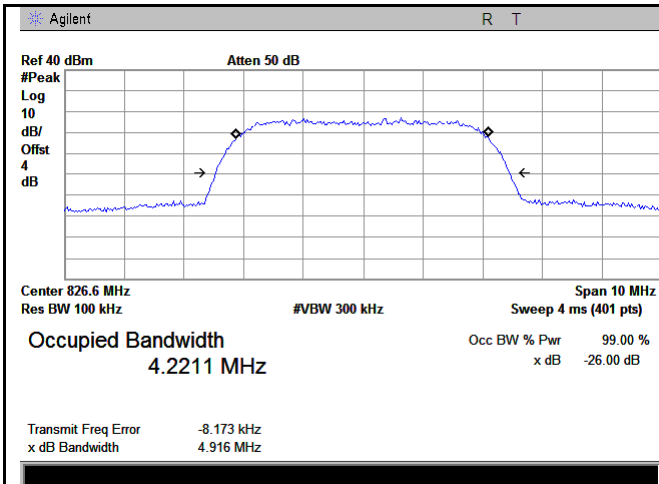

Band V BW - Low CH 826.6 MHz

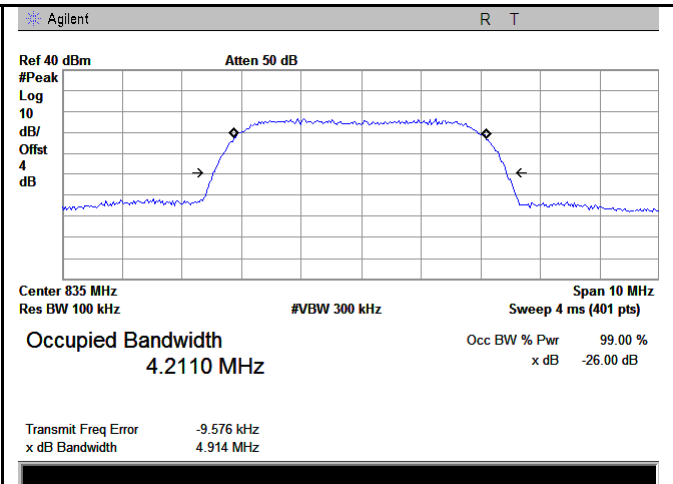

Band V BW - Mid CH 835.0 MHz

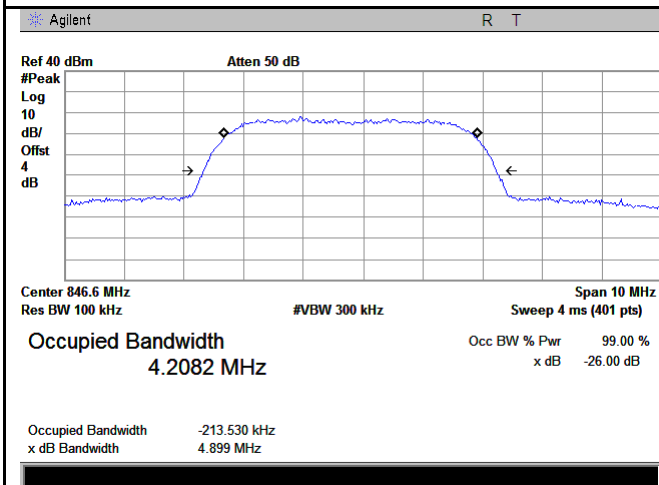

Band V BW - High CH 846.4 MHz

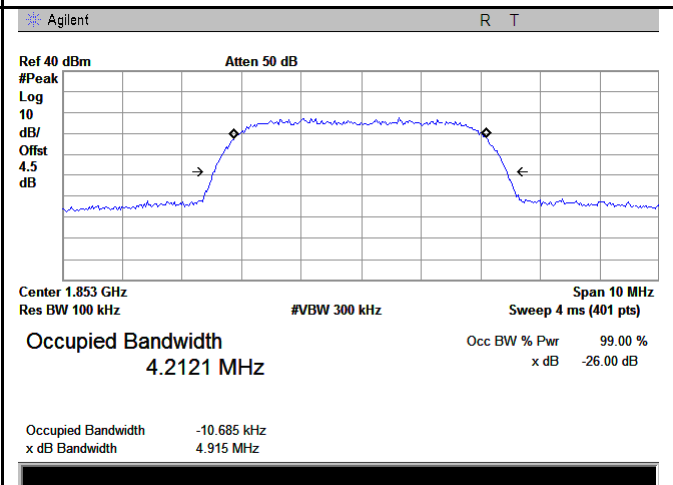

Band II BW - Low CH 1853MHz

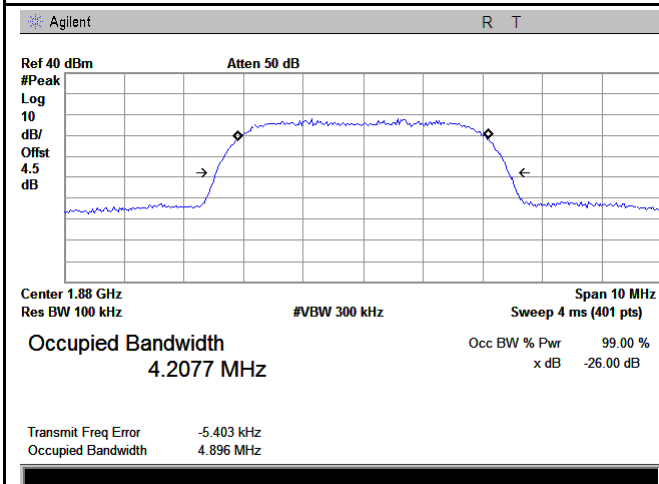

Band II BW - Mid CH 1880MHz

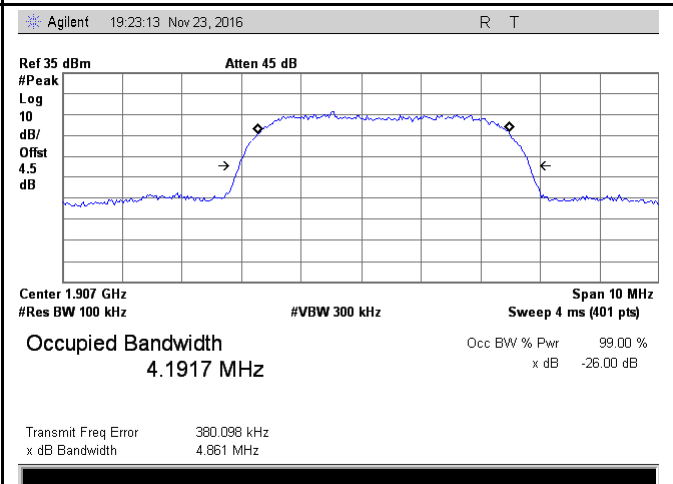

Band II BW - High CH 1907MHz

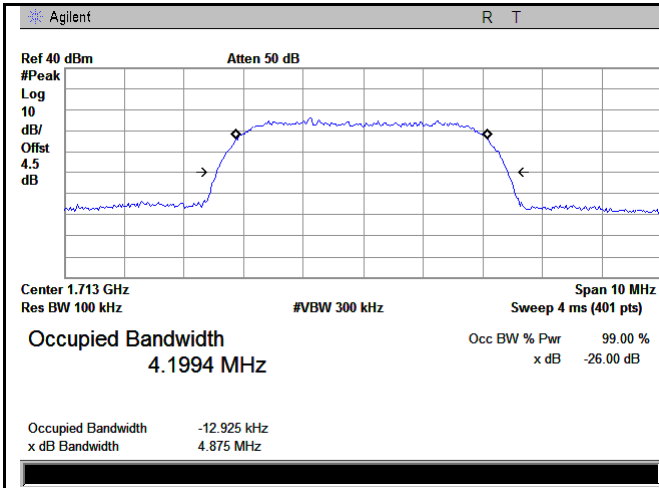

Band IV BW - Low CH 1713MHz

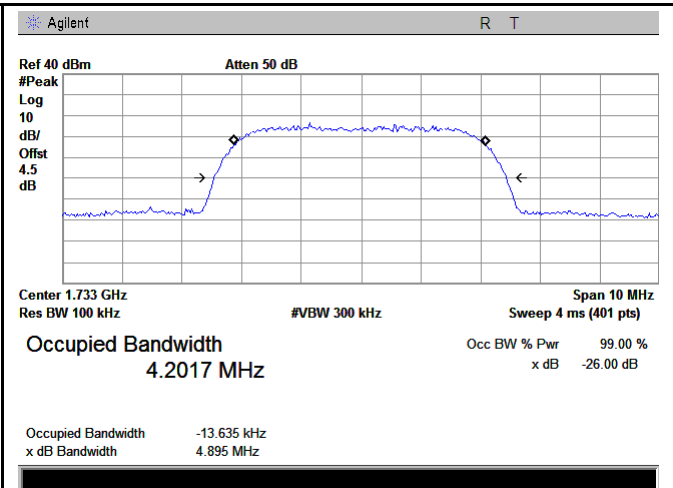

Band IVBW - Mid CH 1733MHz

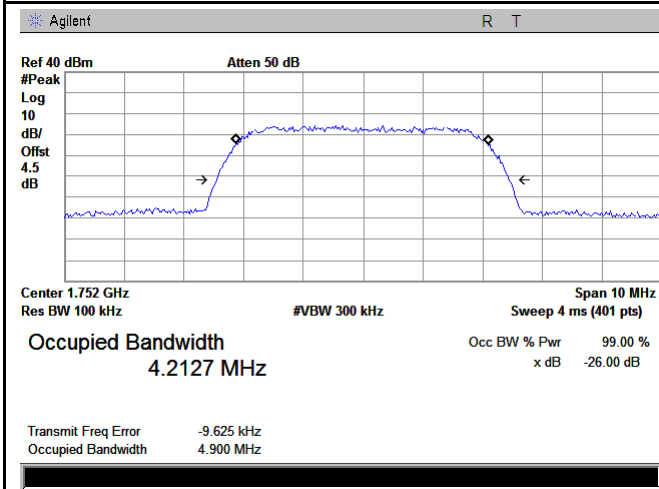

Band IV BW - High CH 1752MHz

## 6.5 Spurious Emissions at Antenna Terminals

Temperature	26°C
Relative Humidity	56%
Atmospheric Pressure	1022mbar
Test date :	October 26, 2017
Tested By :	Loren Luo

### Requirement(s):

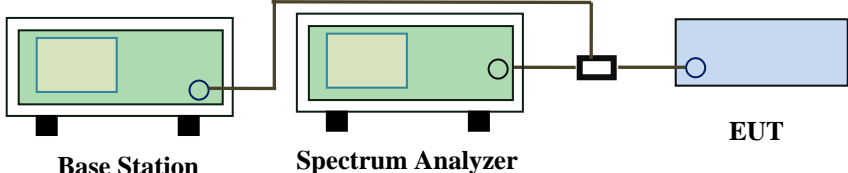
Spec	Item	Requirement	Applicable
§2.1051, §22.917(a)& §24.238(a) § 27.53(h)	a)	The power of any emission outside of the authorized operating frequency ranges must be lower than the transmitter power (P) by a factor of at least $43 + 10 \log(P)$ dB	<input checked="" type="checkbox"/>
Test Setup	 <p style="text-align: center;">Base Station      Spectrum Analyzer      EUT</p>		
Test Procedure	<ul style="list-style-type: none"> <li>- The EUT was connected to Spectrum Analyzer and Base Station via power divider.</li> <li>- The Band Edges of low and high channels for the highest RF powers were measured.</li> <li>- Setting RBW as roughly BW/100.</li> </ul>		
Remark			
Result	<input checked="" type="checkbox"/> Pass <input type="checkbox"/> Fail		

Test Data     Yes       N/A  
 Test Plot     Yes (See below)       N/A

### Test Plots

#### GSM Voice:

#### Cellular Band (Part 22H) result

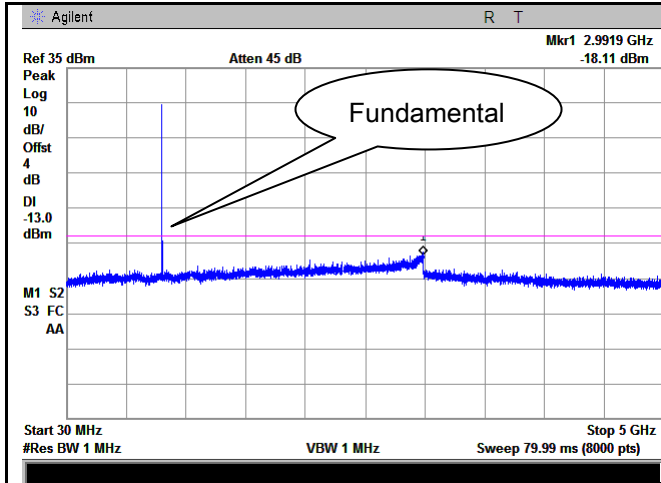

GSM 850 - Low Channel-1

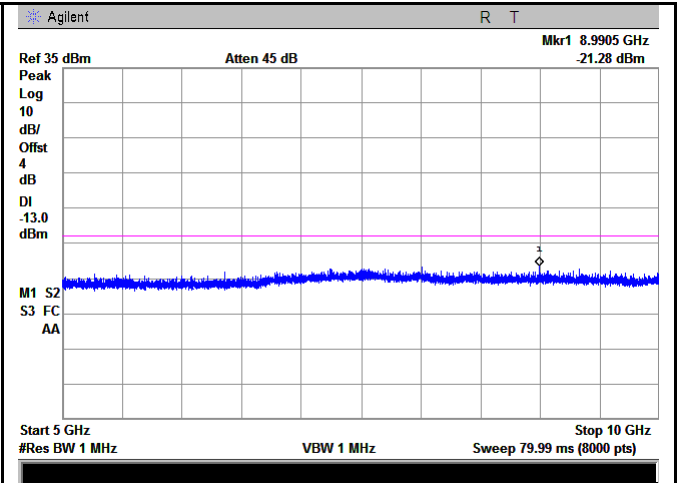

GSM 850 - Low Channel-2

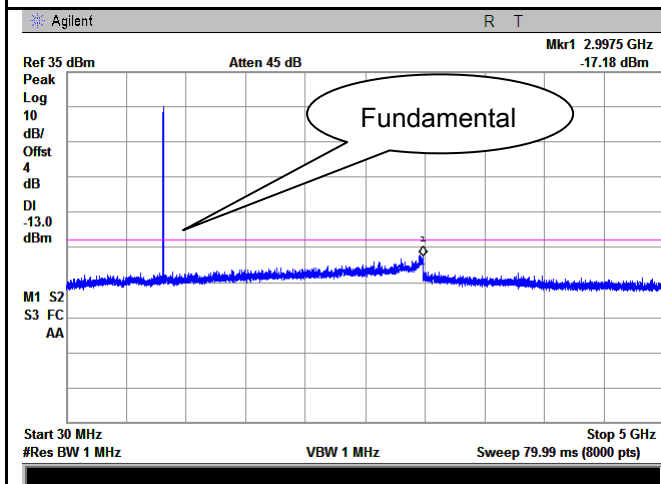

GSM 850 Middle Channel-1

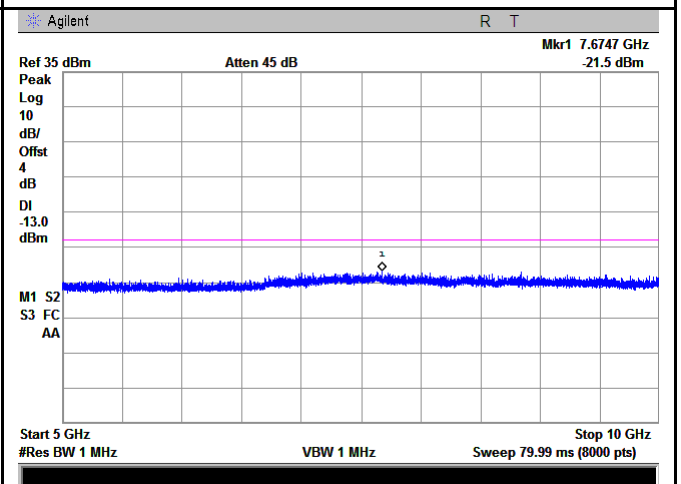

GSM 850 Middle Channel-2

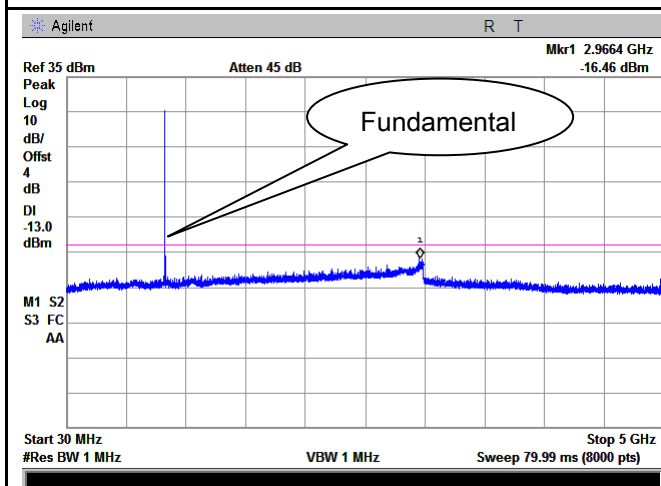

GSM 850 - High Channel-1

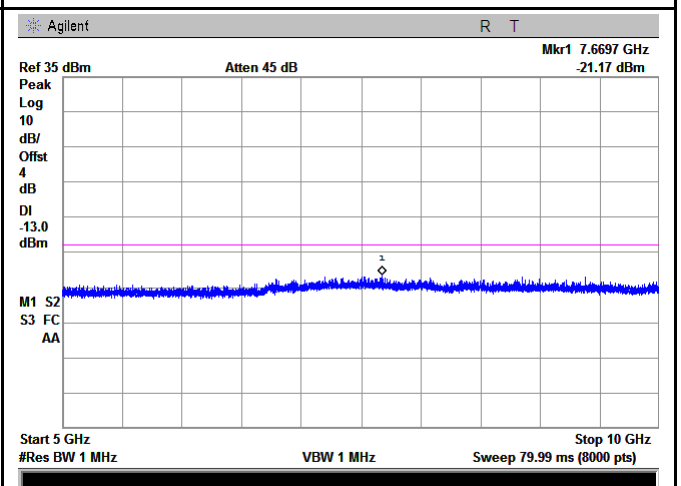

GSM 850 - High Channel-2

### PCS Band (Part24E) result

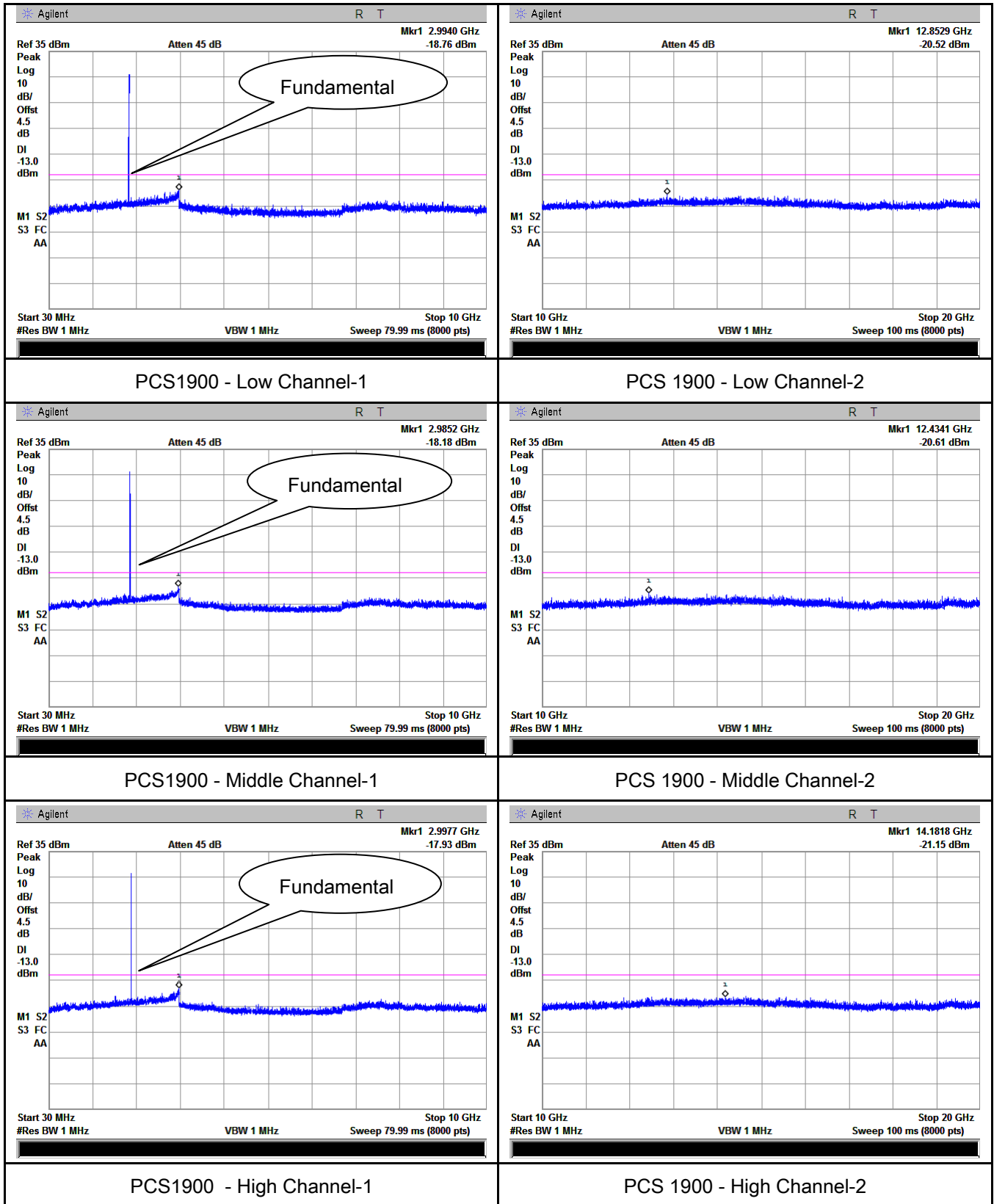



GPRS:

Cellular Band (Part 22H) result

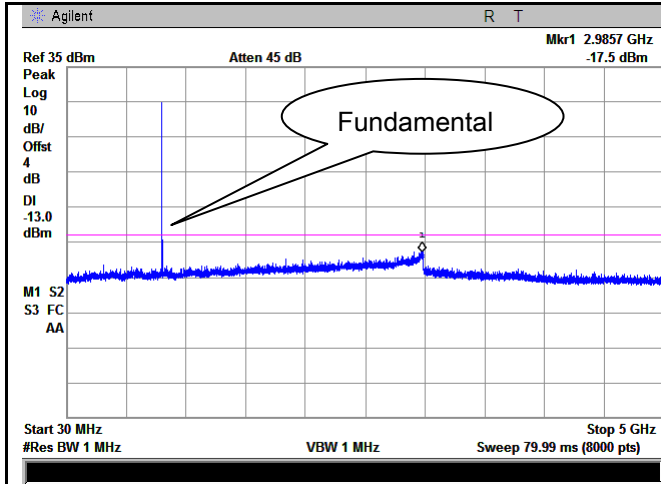

GSM 850 - Low Channel-1

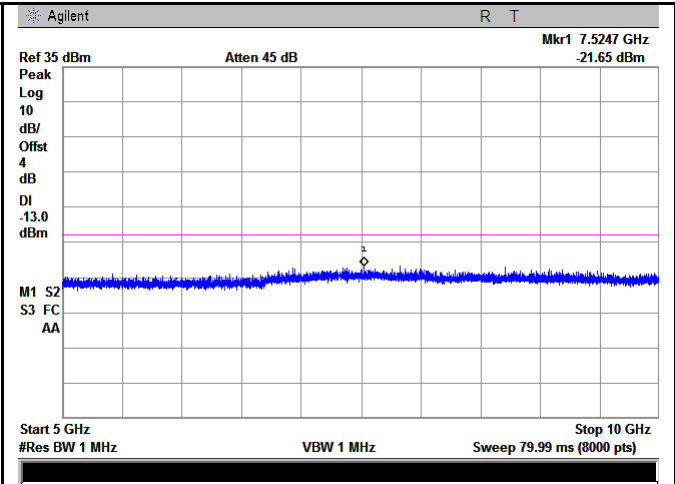

GSM 850 - Low Channel-2

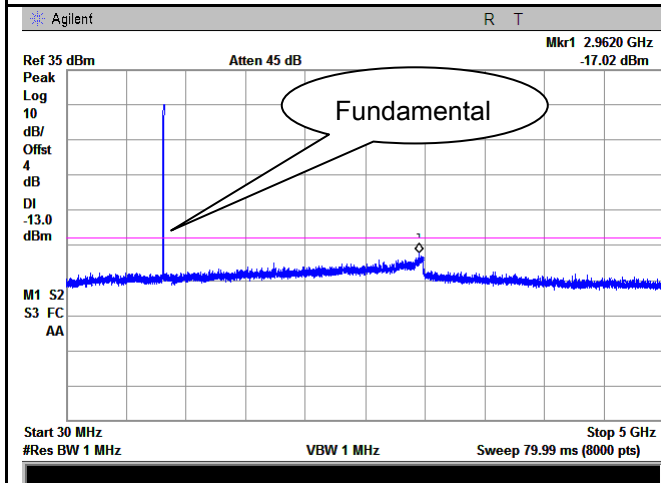

GSM 850 Middle Channel-1

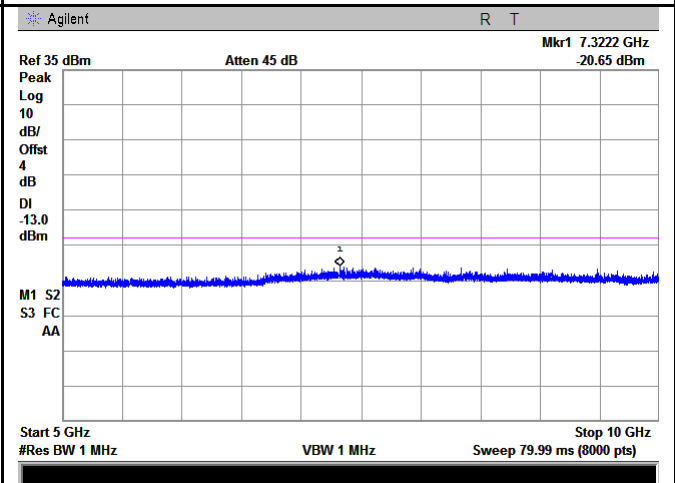

GSM 850 Middle Channel-2

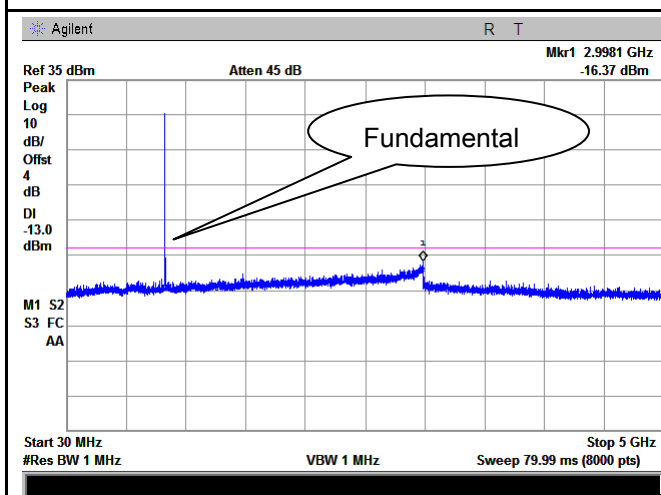

GSM 850 - High Channel-1

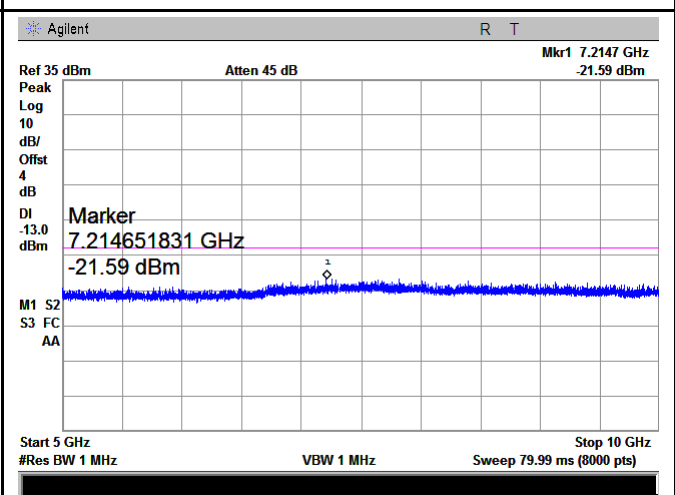

GSM 850 - High Channel-2

### PCS Band (Part24E) result

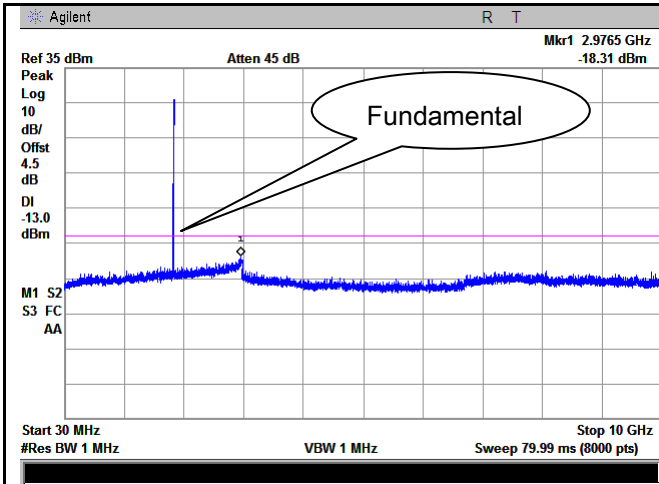

PCS1900 - Low Channel-1

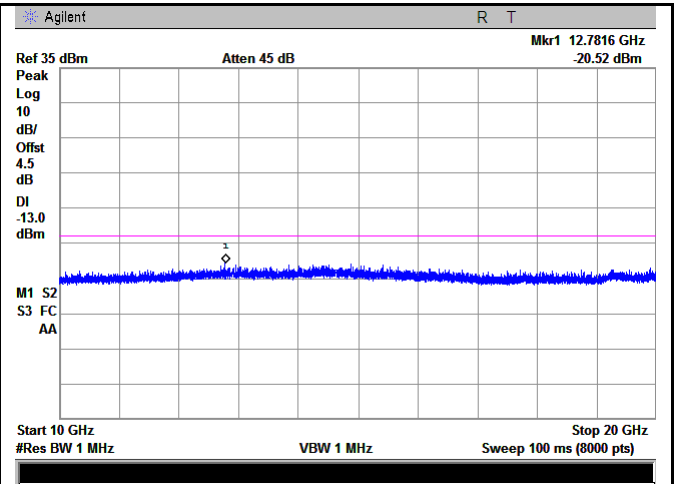

PCS 1900 - Low Channel-2

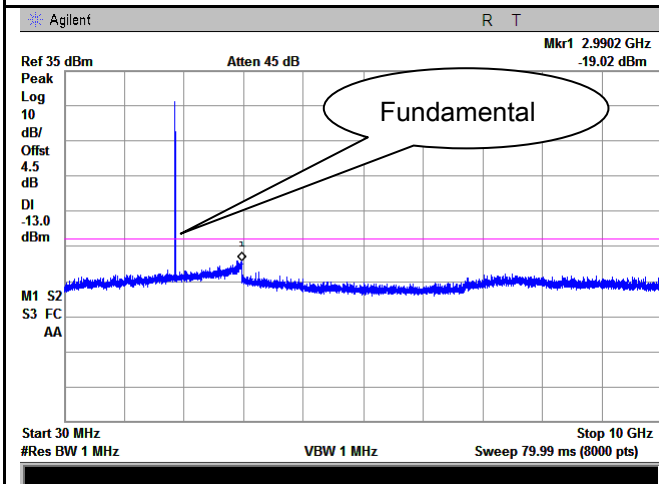

PCS1900 - Middle Channel-1

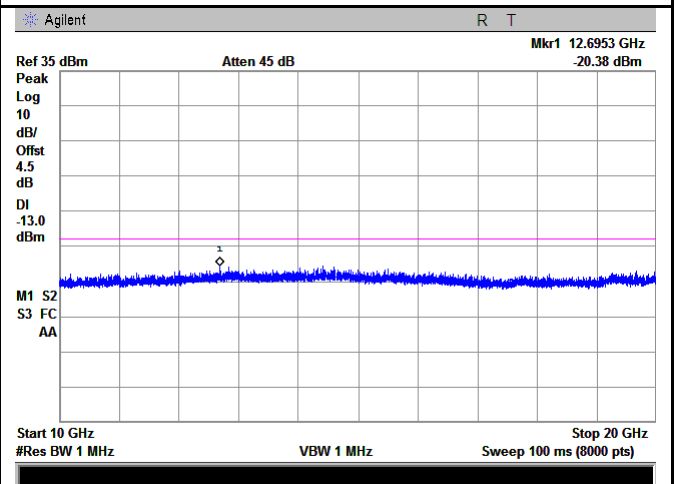

PCS 1900 - Middle Channel-2

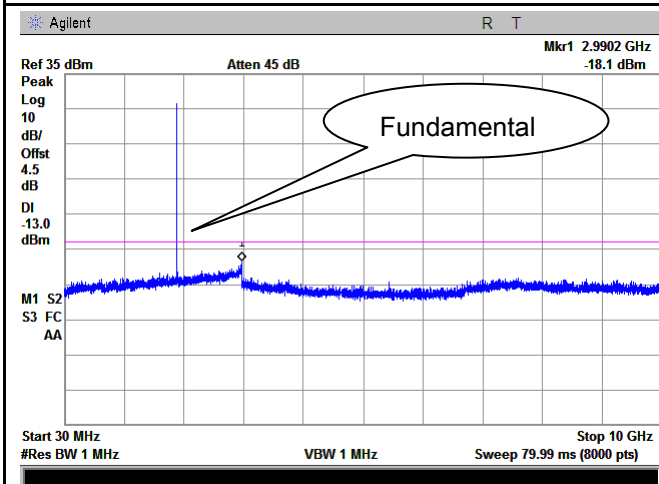

PCS1900 - High Channel-1

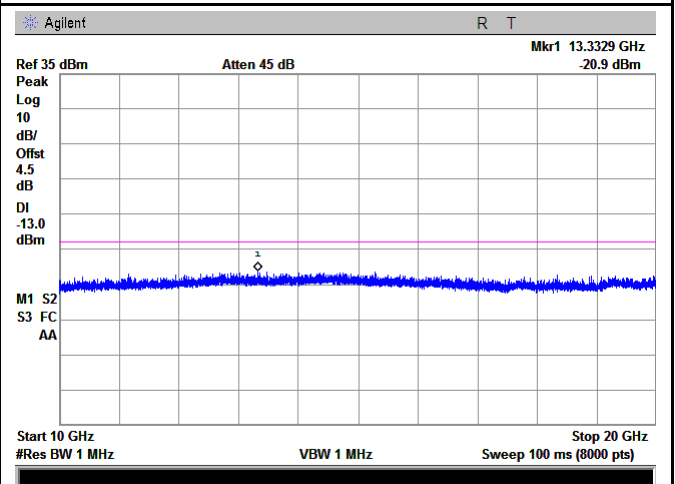

PCS 1900 - High Channel-2

**EGPRS (MCS 5):**  
**Cellular Band (Part 22H) result**

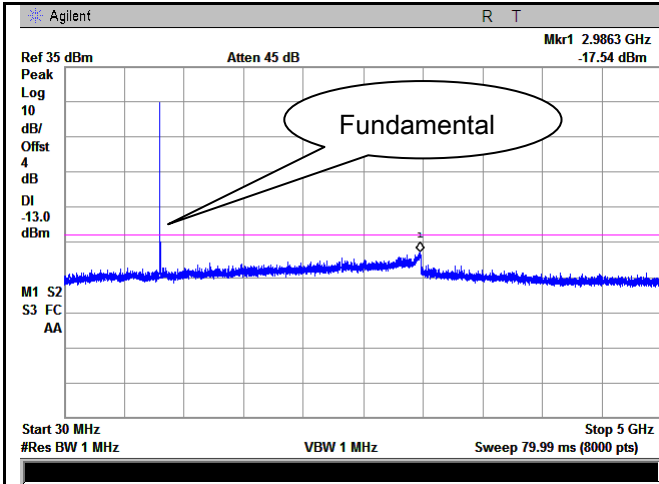

GSM 850 - Low Channel-1

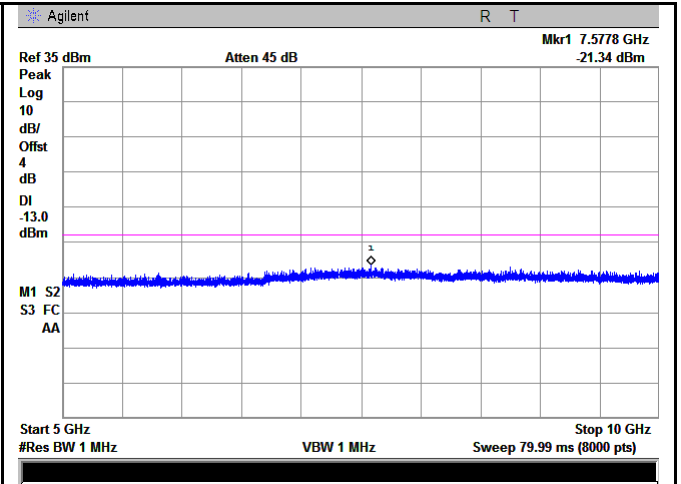

GSM 850 - Low Channel-2

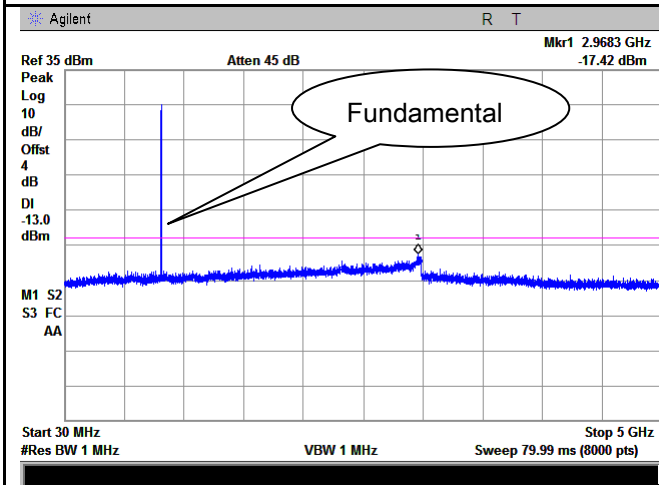

GSM 850 Middle Channel-1

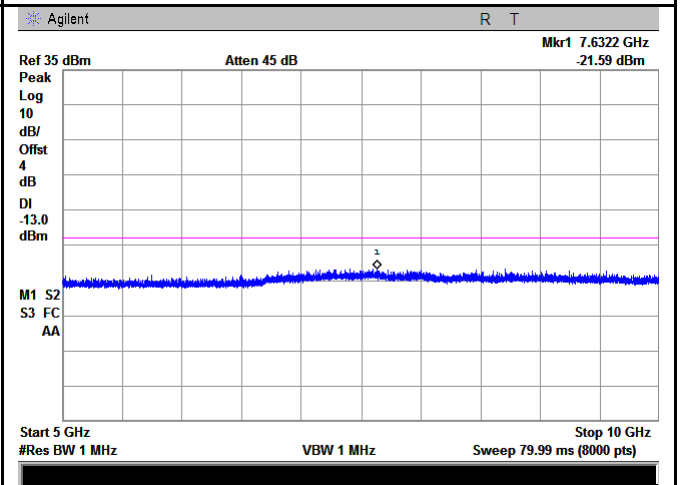

GSM 850 Middle Channel-2

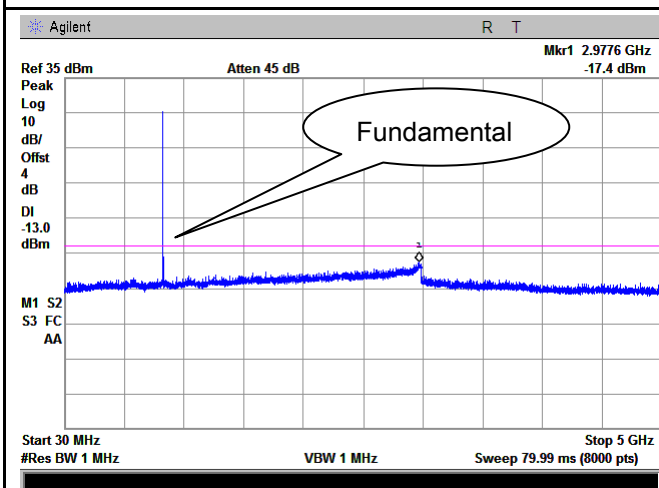

GSM 850 - High Channel-1

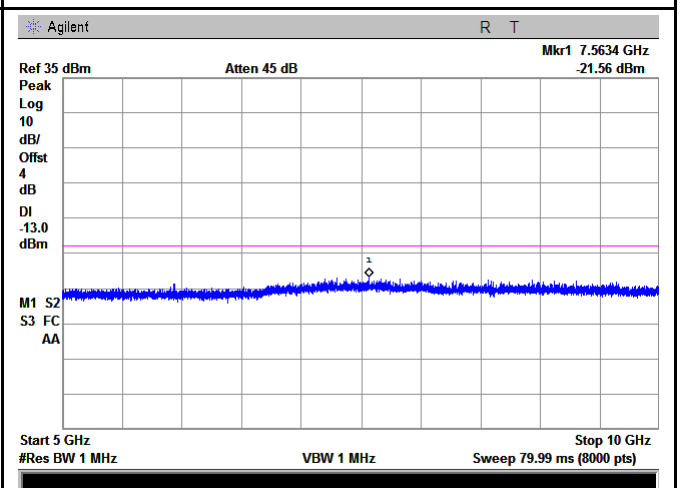

GSM 850 - High Channel-2

### PCS Band (Part24E) result

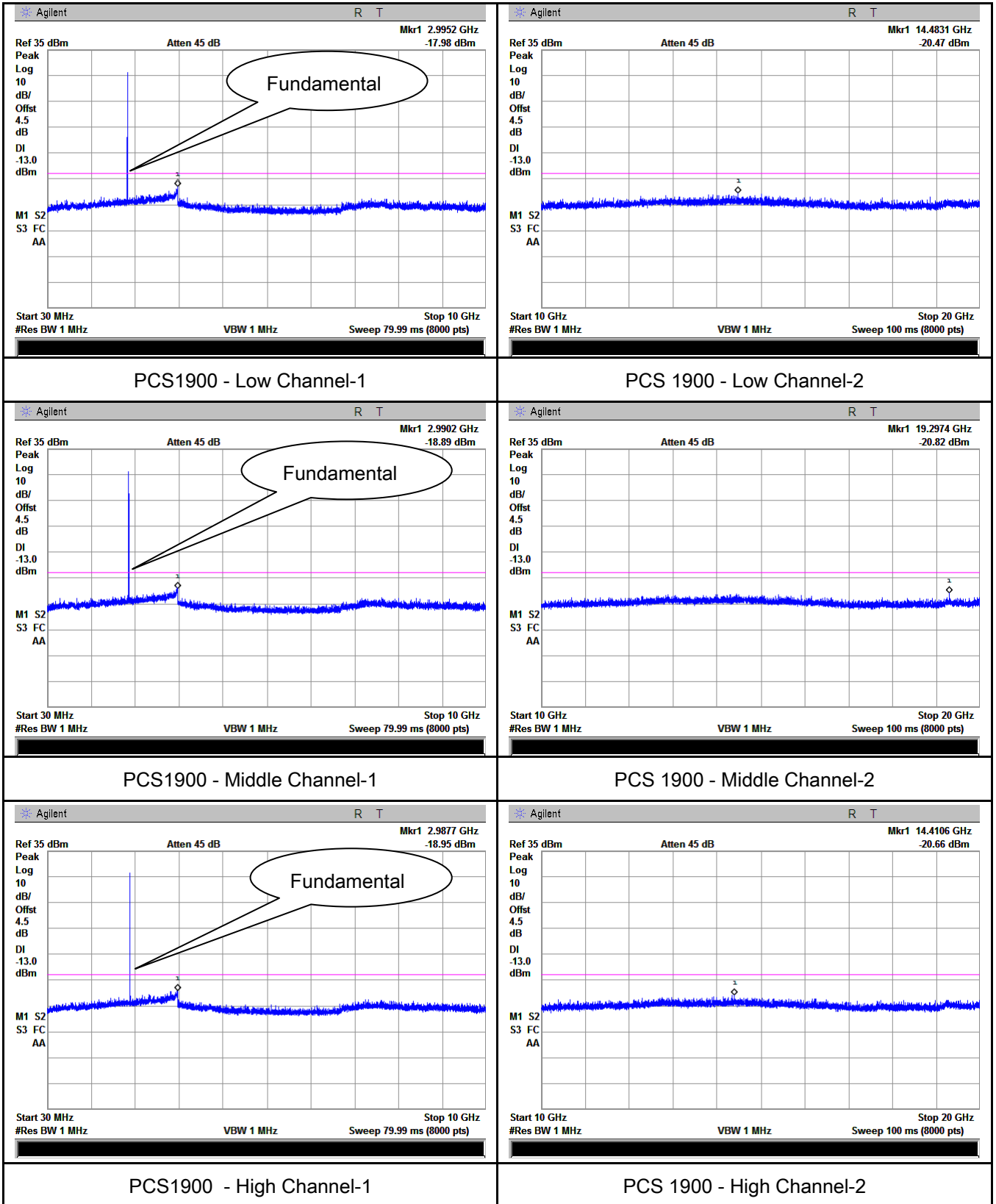

RMC

UMTS-FDD Band V (Part 22H)

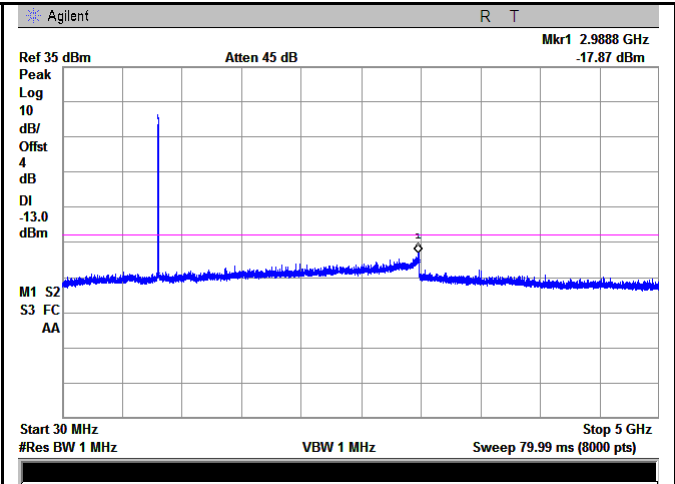
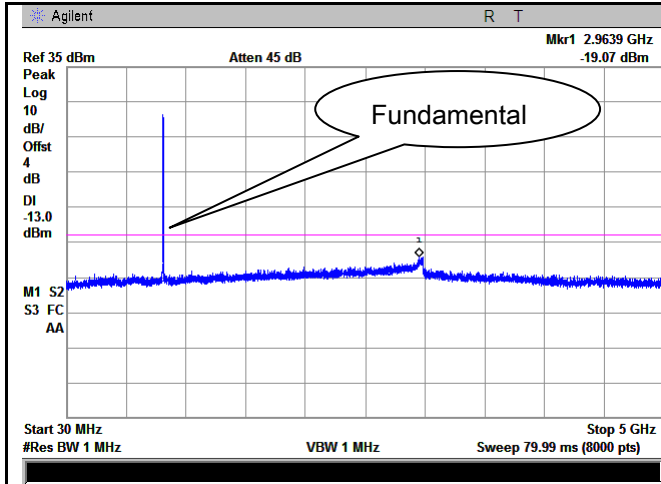

Band V - Low Channel-1

Band V - Low Channel-2

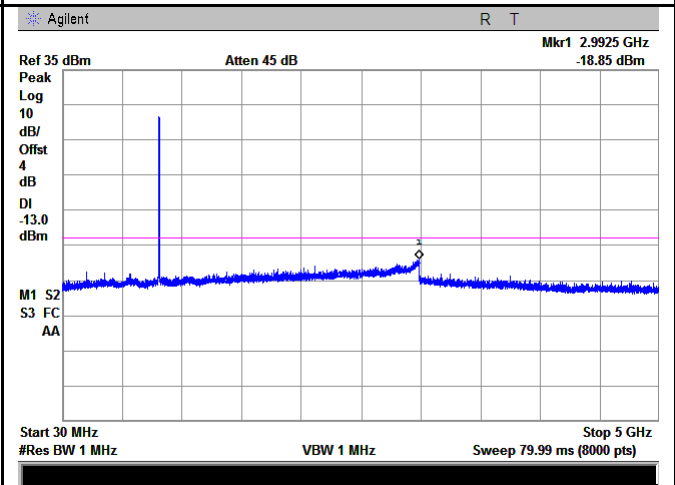
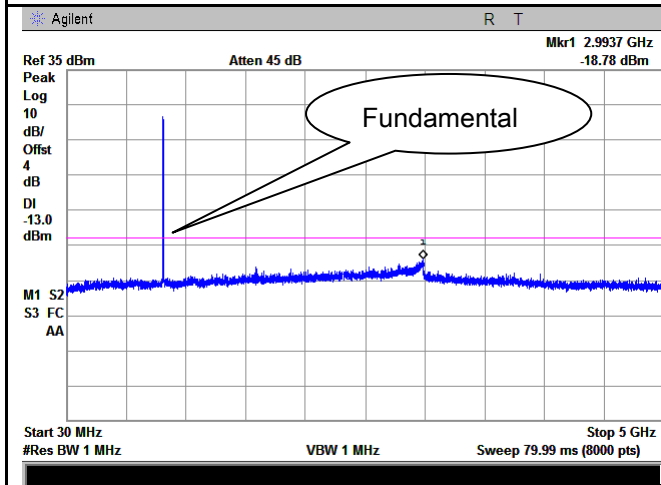

Band V - Middle Channel-1

Band V - Middle Channel-2

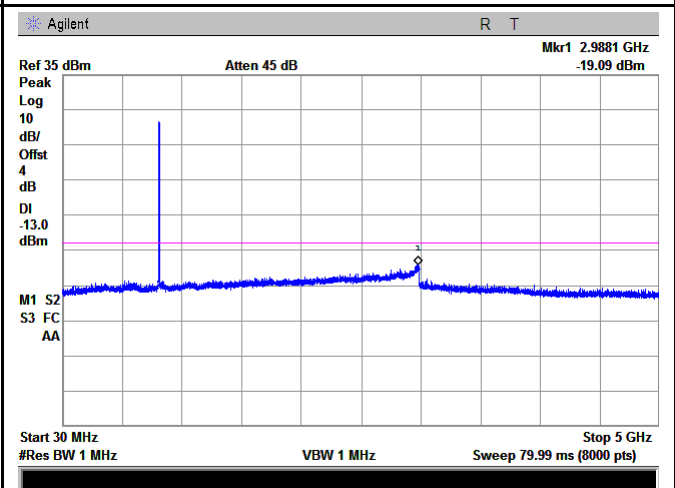
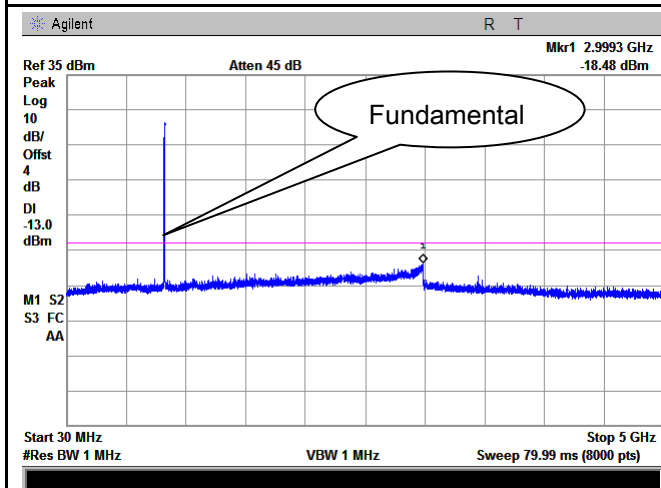

Band V - High Channel-1

Band V - High Channel-2

### UMTS-FDD Band II (Part 24E)

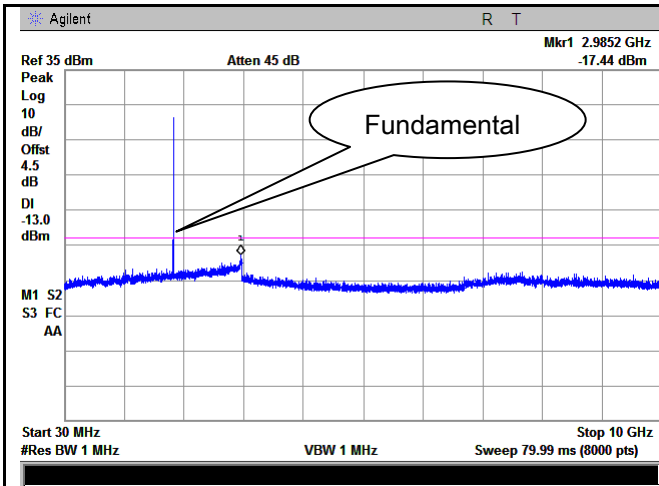

Band II - Low Channel-1

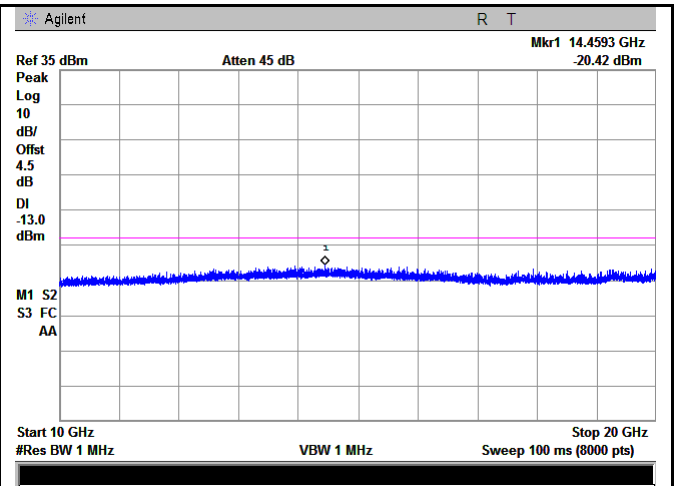

Band II - Low Channel-2

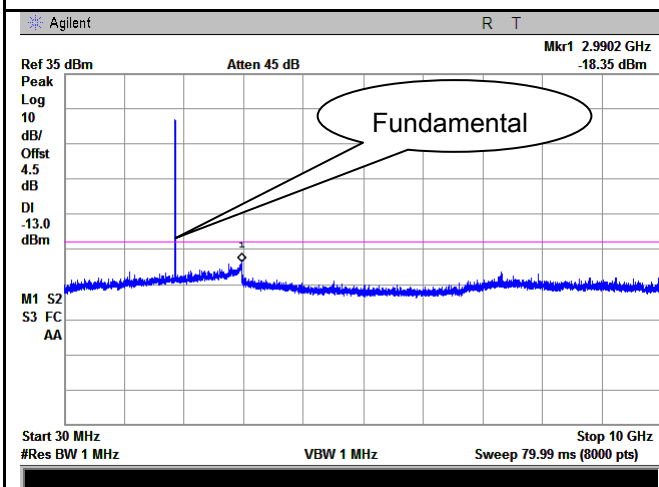

Band II - Middle Channel-1

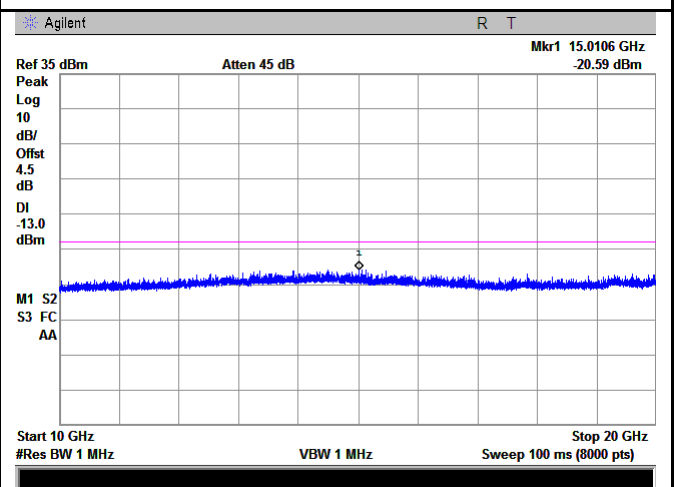

Band II - Middle Channel-2

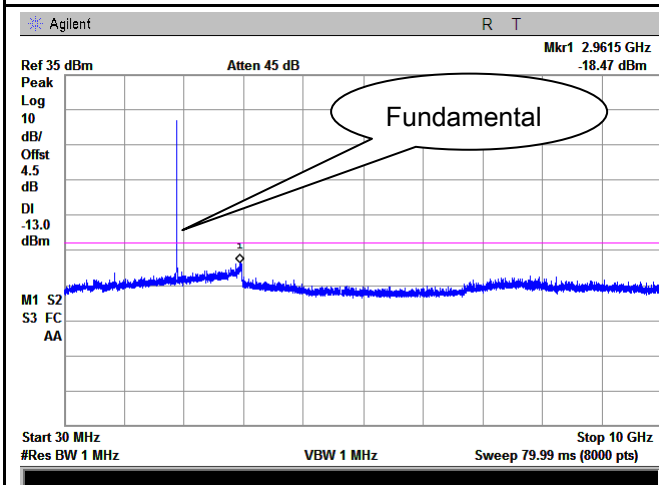

Band II - High Channel-1

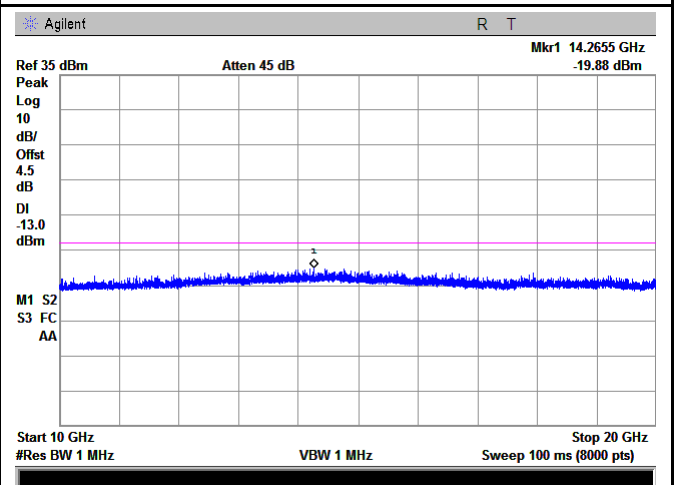

Band II - High Channel-2

### UMTS-FDD Band IV (Part 27)

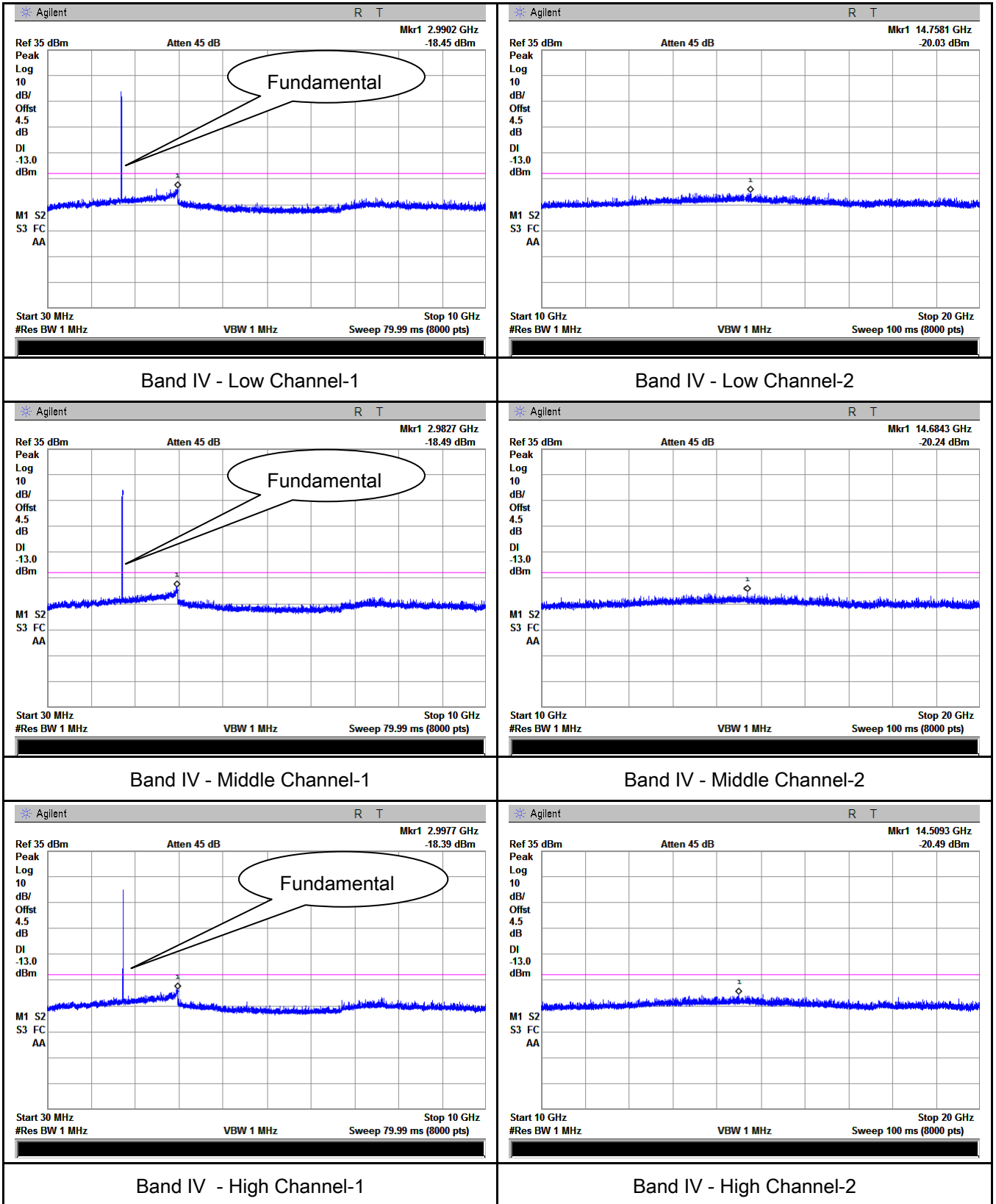

HSUPA:

UMTS-FDD Band V (Part 22H)

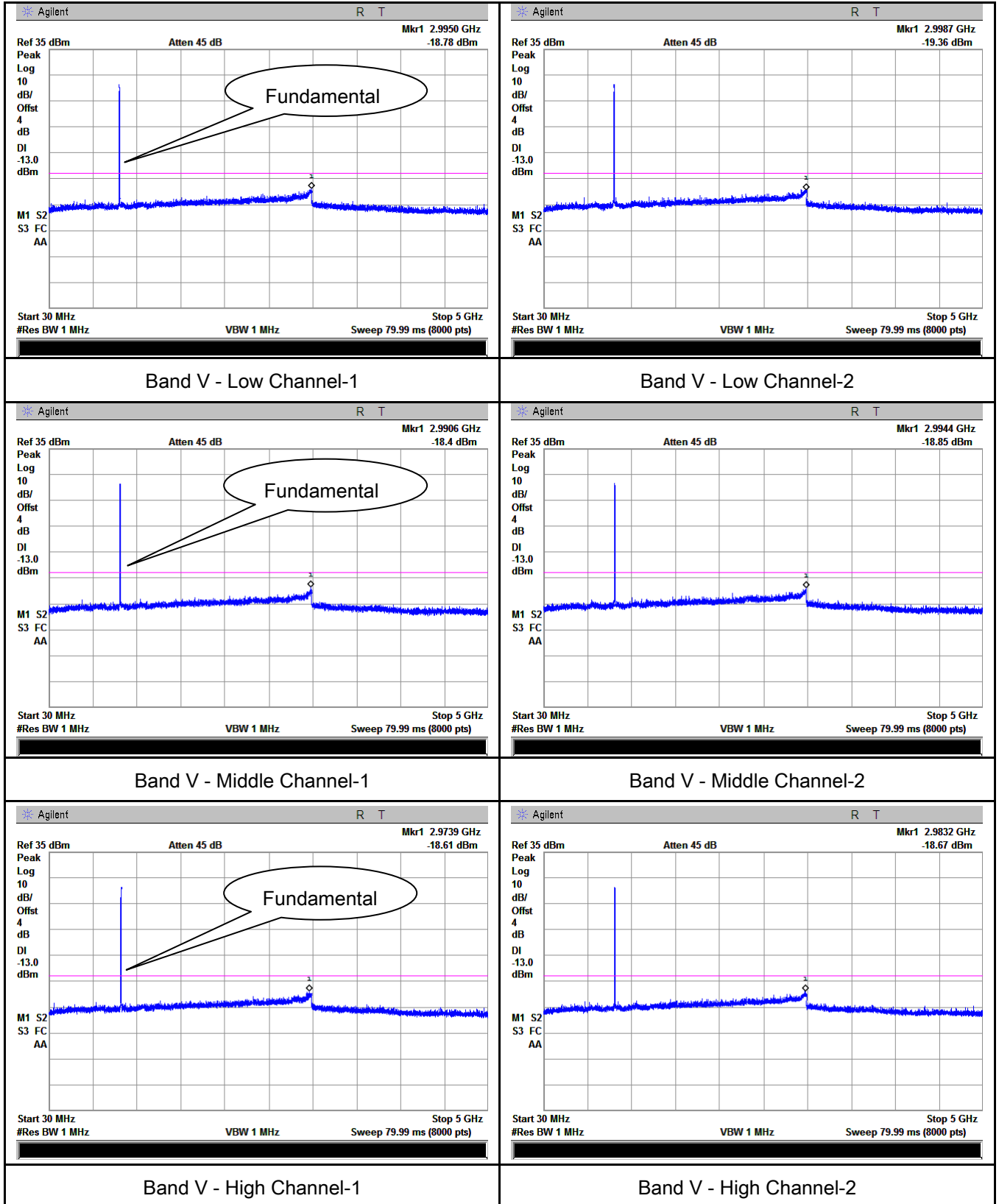



### UMTS-FDD Band II (Part 24E)

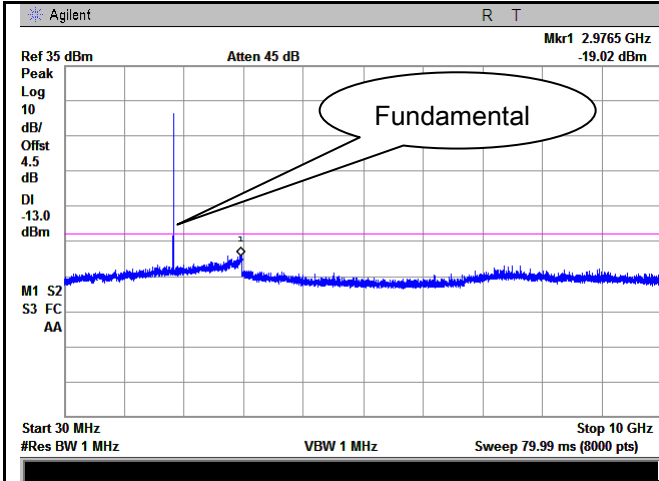

Band II - Low Channel-1

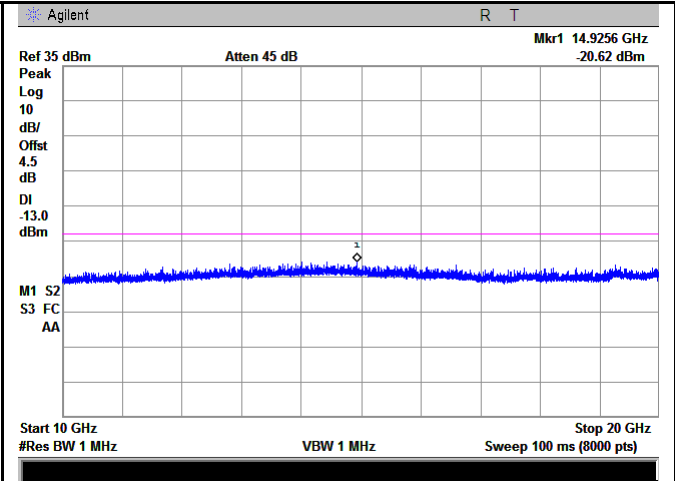

Band II - Low Channel-2

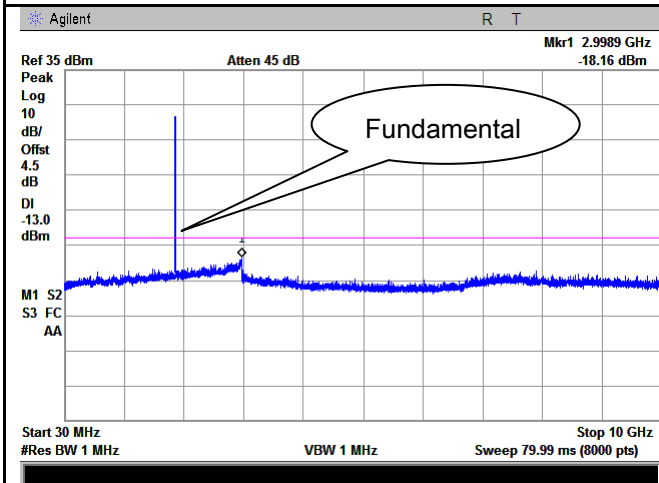

Band II - Middle Channel-1

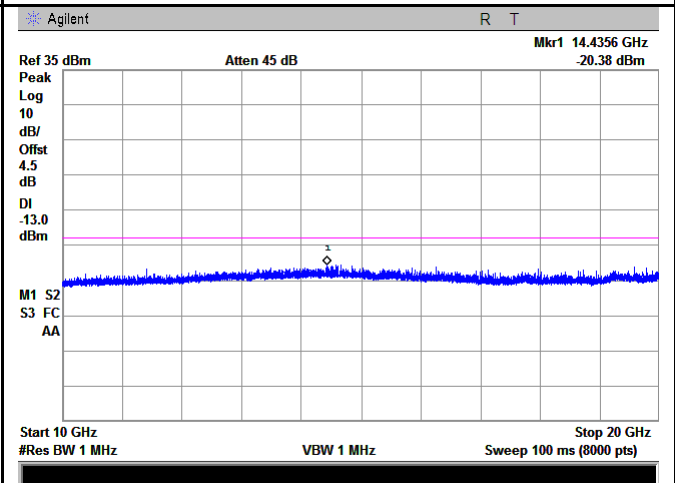

Band II - Middle Channel-2

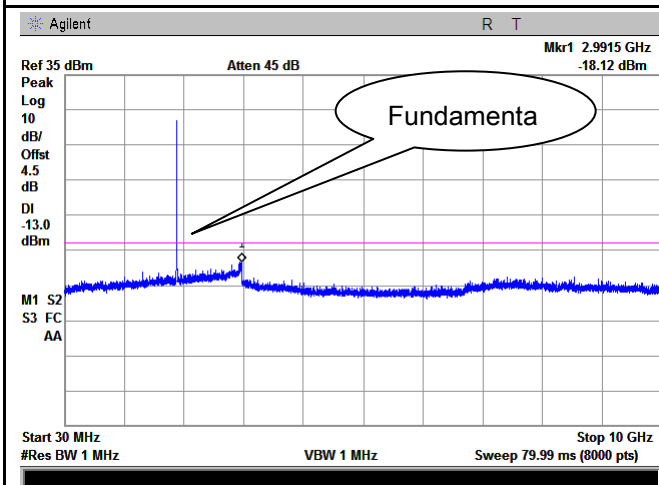

Band II - High Channel-1

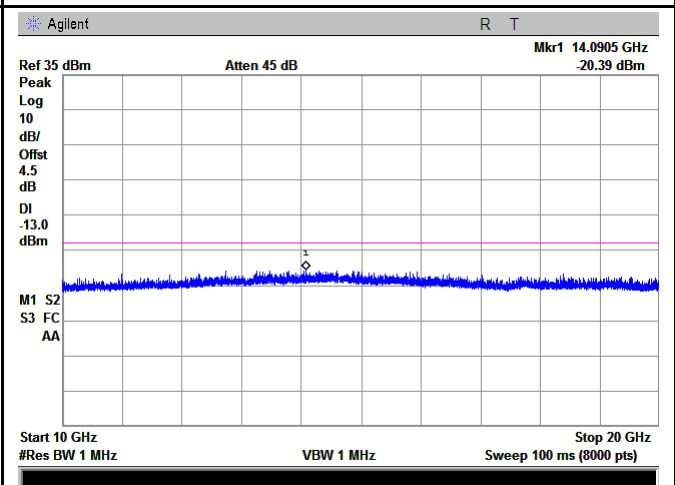

Band II - High Channel-2

### UMTS-FDD Band IV (Part 27)

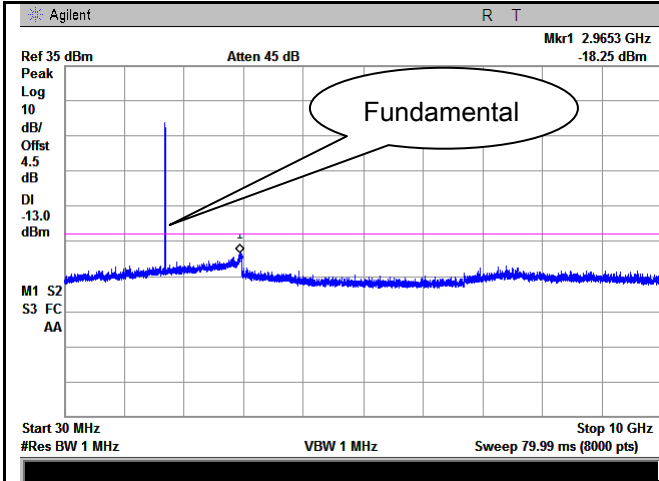

Band IV - Low Channel-1

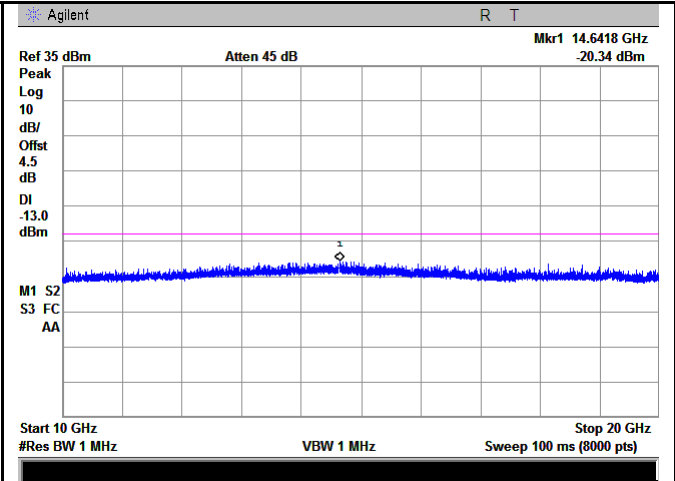

Band IV - Low Channel-2

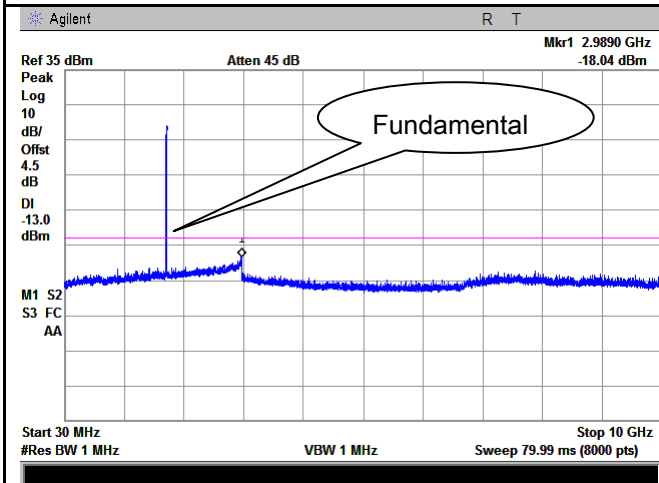

Band IV - Middle Channel-1

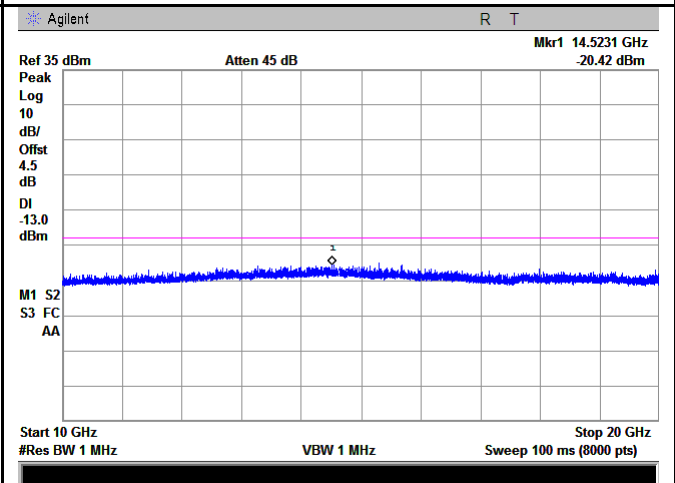

Band IV - Middle Channel-2

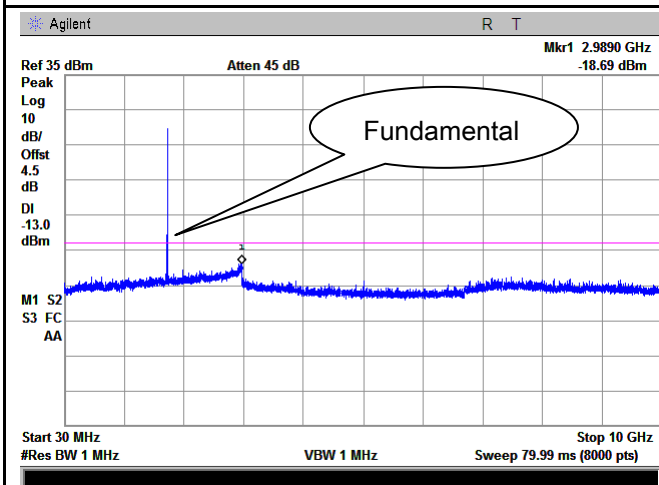

Band IV - High Channel-1

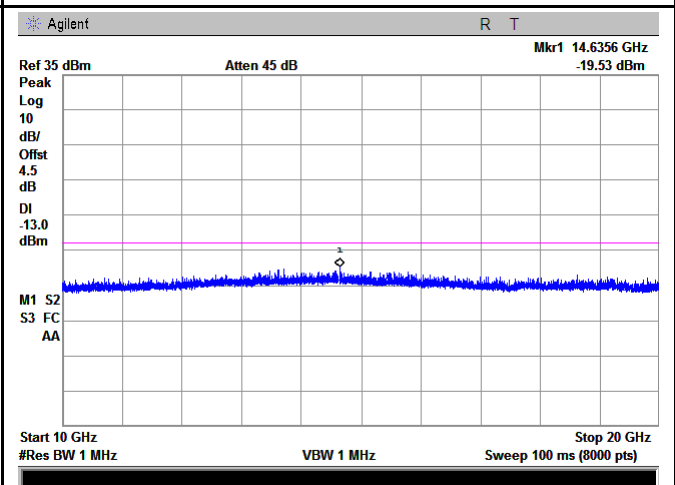

Band IV - High Channel-2

HSDPA:

UMTS-FDD Band V (Part 22H)

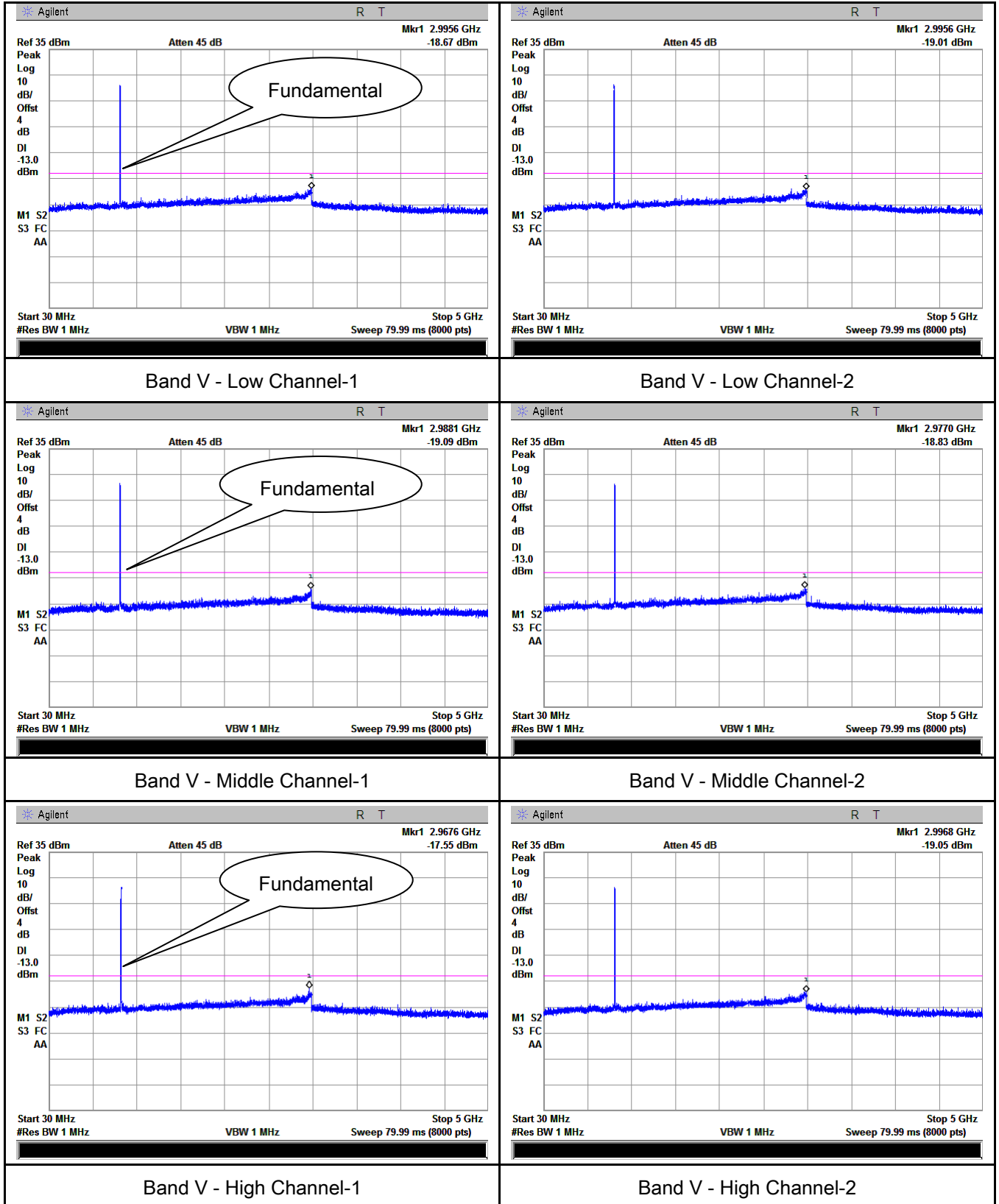

### UMTS-FDD Band II (Part 24E)

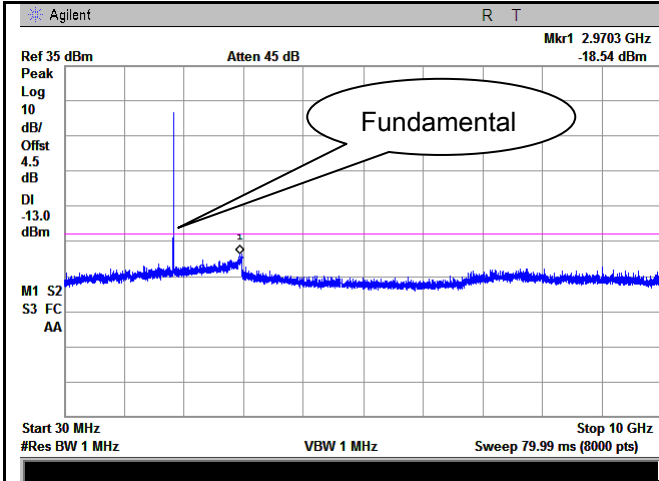

Band II - Low Channel-1

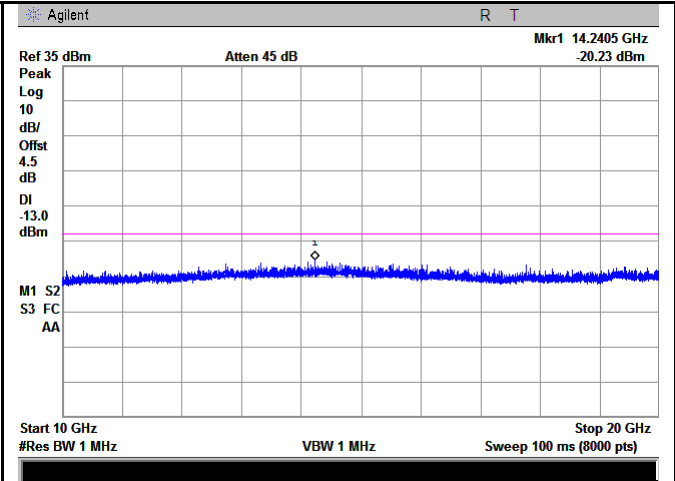

Band II - Low Channel-2

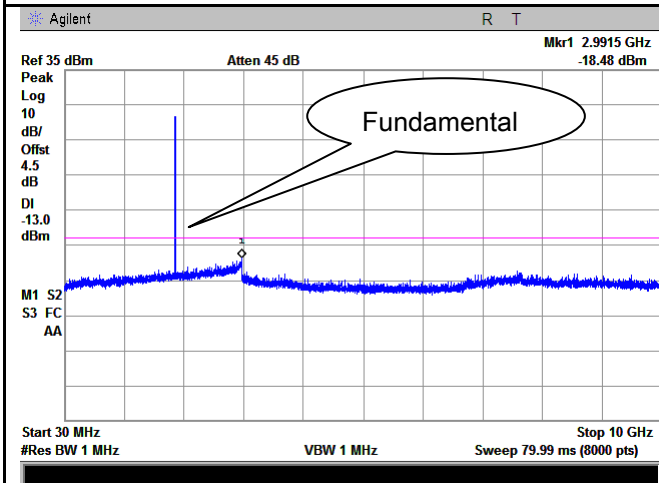

Band II - Middle Channel-1

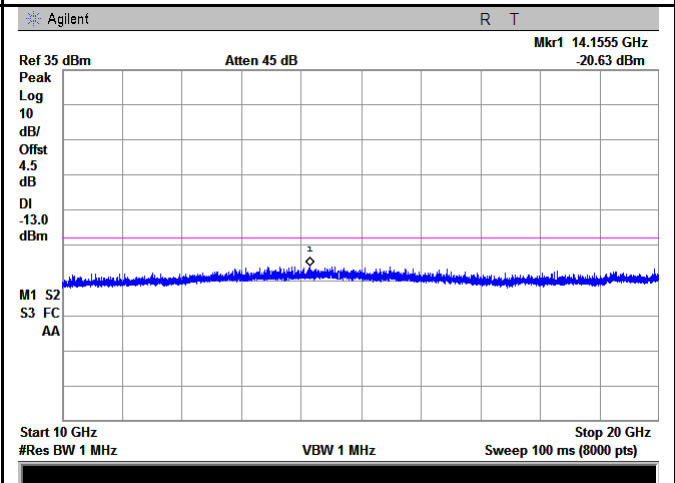

Band II - Middle Channel-2

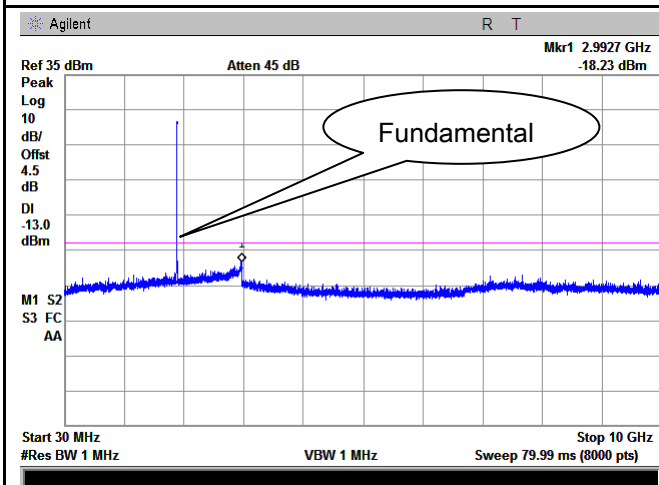

Band II - High Channel-1

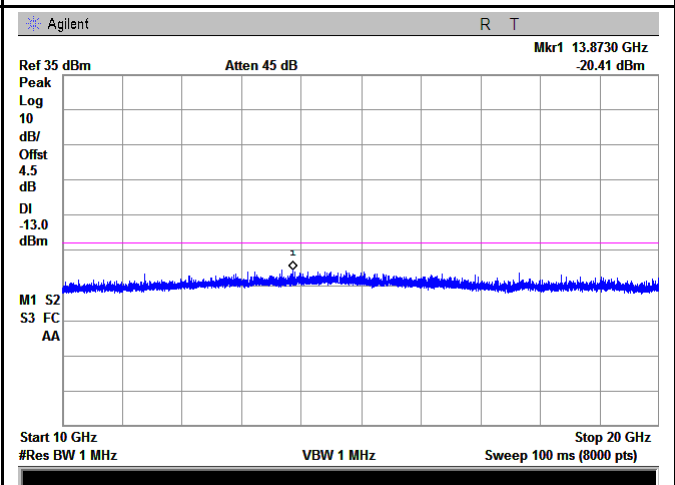

Band II - High Channel-2

### UMTS-FDD Band IV (Part 27)

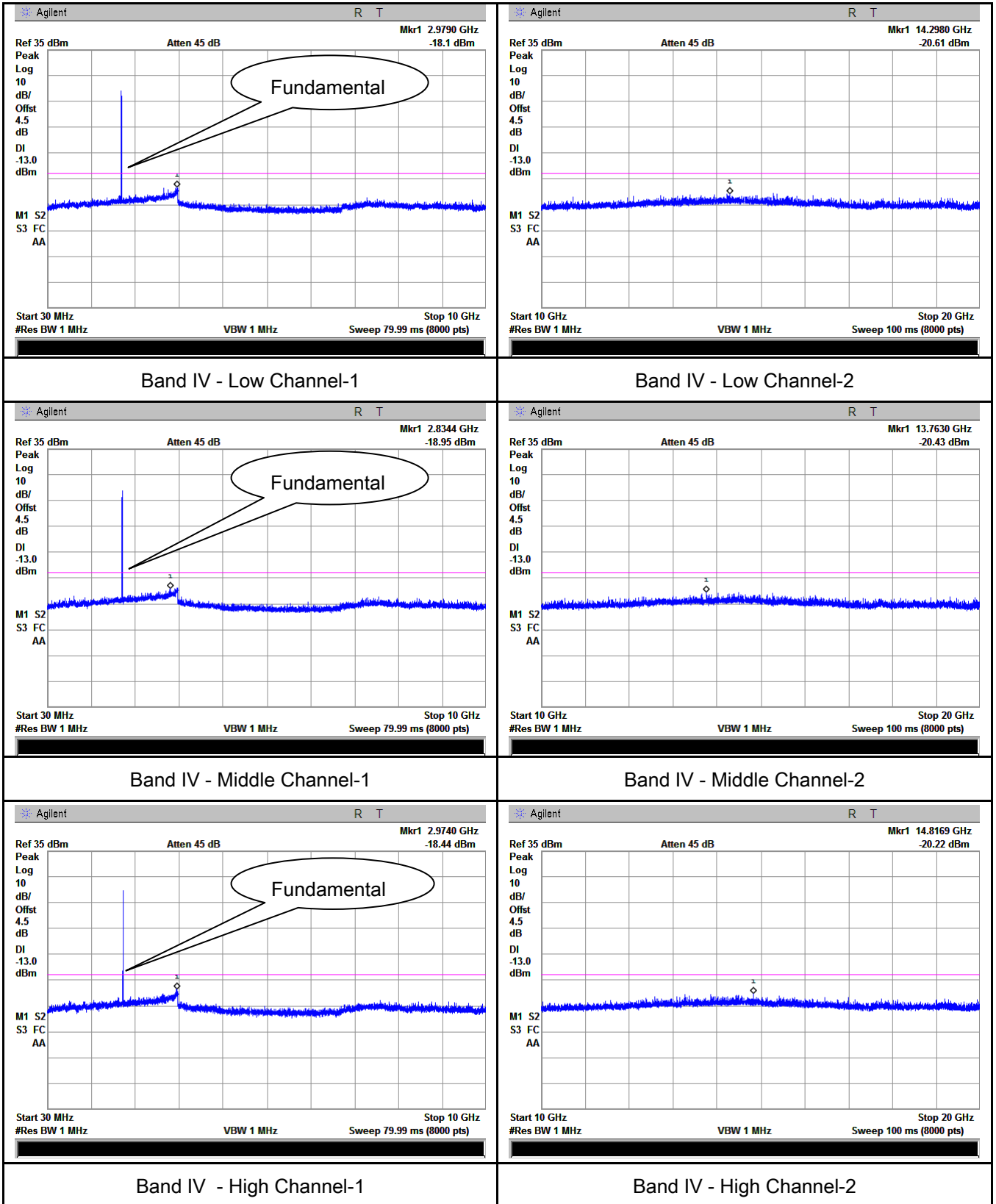

## 6.6 Spurious Radiated Emissions

Temperature	26°C
Relative Humidity	56%
Atmospheric Pressure	1022mbar
Test date :	October 26, 2017
Tested By :	Loren Luo

### Requirement(s):

Spec	Item	Requirement	Applicable
§2.1053, §22.917 & §24.238 § 27.53(h)	a)	The power of any emission outside of the authorized operating frequency ranges must be attenuated below the transmitter power (P) by a factor of at least $43 + 10 \log (P)$ dB. The spectrum is scanned from 30 MHz up to a frequency including its 10th harmonic.	<input checked="" type="checkbox"/>

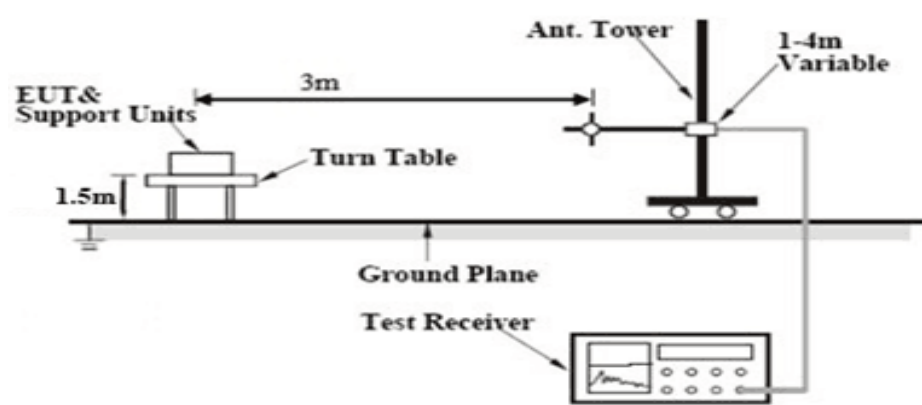
Test setup	
------------	--

Test Procedure	<ol style="list-style-type: none"> <li>The transmitter was placed on a wooden turntable, and it was transmitting into a non-radiating load which was also placed on the turntable.</li> <li>The measurement antenna was placed at a distance of 3 meters from the EUT. During the tests, the antenna height and polarization as well as EUT azimuth were varied in order to identify the maximum level of emissions from the EUT. The test was performed by placing the EUT on 3-orthogonal axis.</li> <li>Remove the EUT and replace it with substitution antenna. A signal generator was connected to the substitution antenna by a non-radiating cable. The absolute levels of the spurious emissions were measured by the substitution.</li> </ol> <p>Sample Calculation:</p> <p>EUT Field Strength = Raw Amplitude (dBµV/m) – Amplifier Gain (dB) + Antenna Factor (dB) + Cable Loss (dB) + Filter Attenuation (dB, if used)</p>
----------------	---

Remark	
Result	<input checked="" type="checkbox"/> Pass <input type="checkbox"/> Fail

Test Data  Yes  N/A  
 Test Plot  Yes (See below)  N/A

## Cellular Band (Part 22H) result

### Low channel

Frequency (MHz)	Substituted level (dBm)	Polarity (H/V)	Antenna Gain Correction (dB)	Cable Loss (dB)	Corrected Reading (dBm)	Limit (dBm)	Margin (dB)
1648.4	-43.26	V	7.95	0.67	-35.98	-13	-22.98
1648.4	-43.7	H	7.95	0.67	-36.42	-13	-23.42
825.7	-52.63	V	6.09	0.46	-47	-13	-34
604.6	-53.05	H	6.06	0.39	-47.38	-13	-34.38

### Middle channel

Frequency (MHz)	Substituted level (dBm)	Polarity (H/V)	Antenna Gain Correction (dB)	Cable Loss (dB)	Corrected Reading (dBm)	Limit (dBm)	Margin (dB)
1673.2	-42.62	V	7.95	0.67	-35.34	-13	-22.34
1673.2	-43.76	H	7.95	0.67	-36.48	-13	-23.48
522.1	-52.88	V	5.64	0.22	-47.46	-13	-34.46
915.6	-52.79	H	6.24	0.46	-47.01	-13	-34.01

### High channel

Frequency (MHz)	Substituted level (dBm)	Polarity (H/V)	Antenna Gain Correction (dB)	Cable Loss (dB)	Corrected Reading (dBm)	Limit (dBm)	Margin (dB)
1697.6	-43.55	V	7.95	0.68	-36.28	-13	-23.28
1697.6	-43.52	H	7.95	0.68	-36.25	-13	-23.25
890.8	-52.88	V	6.2	0.42	-47.1	-13	-34.10
339.9	-53.46	H	5.62	0.27	-48.11	-13	-35.11

#### Note:

- 1, The testing has been conformed to  $10 \times 848.8 \text{ MHz} = 8,488 \text{ MHz}$
- 2, All other emissions more than 30 dB below the limit
- 3, GSM voice, GPRS and EGPRS mode were investigated. The results above show only the worse cases
- 4, X-Axis, Y-Axis and Z-Axis were investigated. The results above show only the worst case.



## PCS Band (Part24E) result

### Low channel

Frequency (MHz)	Substituted level (dBm)	Polarity (H/V)	Antenna Gain Correction (dB)	Cable Loss (dB)	Corrected Reading (dBm)	Limit (dBm)	Margin (dB)
3700.4	-48.81	V	10.25	1	-39.56	-13	-26.56
3700.4	-49.17	H	10.25	1	-39.92	-13	-26.92
153.7	-53.65	V	5.6	0.25	-48.3	-13	-35.3
888.5	-52.78	H	6.22	0.41	-46.97	-13	-33.97

### Middle channel

Frequency (MHz)	Substituted level (dBm)	Polarity (H/V)	Antenna Gain Correction (dB)	Cable Loss (dB)	Corrected Reading (dBm)	Limit (dBm)	Margin (dB)
3760	-49.29	V	10.25	1.01	-40.05	-13	-27.05
3760	-48.32	H	10.25	1.01	-39.08	-13	-26.08
331.5	-52.31	V	5.6	0.23	-46.94	-13	-33.94
598.4	-53.95	H	6.05	0.34	-48.24	-13	-35.24

### High channel

Frequency (MHz)	Substituted level (dBm)	Polarity (H/V)	Antenna Gain Correction (dB)	Cable Loss (dB)	Corrected Reading (dBm)	Limit (dBm)	Margin (dB)
3819.6	-48.88	V	10.36	1.02	-39.54	-13	-26.54
3819.6	-50.09	H	10.36	1.02	-40.75	-13	-27.75
886.9	-54.06	V	6.2	0.42	-48.28	-13	-35.28
641.8	-52.33	H	6.06	0.35	-46.62	-13	-33.62

#### Note:

- 1, The testing has been conformed to  $10 \times 1909.8 \text{ MHz} = 19,098 \text{ MHz}$
- 2, All other emissions more than 30 dB below the limit
- 3, GSM voice, GPRS and EGPRS mode were investigated. The results above show only the worse cases
- 4, X-Axis, Y-Axis and Z-Axis were investigated. The results above show only the worst case.
- 5, The radiated spurious test above 18GHz is subcontracted to SIEMIC (Nanjing-China) Laboratories. and found 30dB below the limit at least.

## UMTS-FDD Band V (Part 22H)

### Low channel

Frequency (MHz)	Substituted level (dBm)	Polarity (H/V)	Antenna Gain Correction (dB)	Cable Loss (dB)	Corrected Reading (dBm)	Limit (dBm)	Margin (dB)
1652.8	-46.17	V	7.95	0.67	-38.89	-13	-25.89
1652.8	-45.3	H	7.95	0.67	-38.02	-13	-25.02
187.8	-51.63	V	3.73	0.17	-48.07	-13	-35.07
821.3	-52.71	H	6.17	0.45	-46.99	-13	-33.99

### Middle channel

Frequency (MHz)	Substituted level (dBm)	Polarity (H/V)	Antenna Gain Correction (dB)	Cable Loss (dB)	Corrected Reading (dBm)	Limit (dBm)	Margin (dB)
1670	-45.96	V	7.95	0.67	-38.68	-13	-25.68
1670	-45.36	H	7.95	0.67	-38.08	-13	-25.08
720	-51.76	V	6.41	0.43	-45.78	-13	-32.78
439	-52.58	H	5.96	0.26	-46.88	-13	-33.88

### High channel

Frequency (MHz)	Substituted level (dBm)	Polarity (H/V)	Antenna Gain Correction (dB)	Cable Loss (dB)	Corrected Reading (dBm)	Limit (dBm)	Margin (dB)
1693.2	-46.11	V	7.95	0.68	-38.84	-13	-25.84
1693.2	-45.9	H	7.95	0.68	-38.63	-13	-25.63
802.4	-52.35	V	6.2	0.42	-46.57	-13	-33.57
766	-53.81	H	6.41	0.47	-47.87	-13	-34.87

**Note:**

- 1, The testing has been conformed to  $10 \times 846.6 \text{ MHz} = 8,466 \text{ MHz}$
- 2, All other emissions more than 30 dB below the limit
- 3, RMC, HSUPA and HSDPA mode were investigated. The results above show only the worse cases
- 4, X-Axis, Y-Axis and Z-Axis were investigated. The results above show only the worst case.

## UMTS-FDD Band II (Part 24E)

### Low channel

Frequency (MHz)	Substituted level (dBm)	Polarity (H/V)	Antenna Gain Correction (dB)	Cable Loss (dB)	Corrected Reading (dBm)	Limit (dBm)	Margin (dB)
3704.8	-49.86	V	10.25	1	-40.61	-13	-27.61
3704.8	-49.24	H	10.25	1	-39.99	-13	-26.99
850.7	-53.3	V	6.19	0.44	-47.55	-13	-34.55
649.9	-54.14	H	6.07	0.34	-48.41	-13	-35.41

### Middle channel

Frequency (MHz)	Substituted level (dBm)	Polarity (H/V)	Antenna Gain Correction (dB)	Cable Loss (dB)	Corrected Reading (dBm)	Limit (dBm)	Margin (dB)
3760	-49.18	V	10.25	1.01	-39.94	-13	-26.94
3760	-50.24	H	10.25	1.01	-41	-13	-28
460.2	-54.51	V	6.05	0.28	-48.74	-13	-35.74
839.5	-52.52	H	6.15	0.41	-46.78	-13	-33.78

### High channel

Frequency (MHz)	Substituted level (dBm)	Polarity (H/V)	Antenna Gain Correction (dB)	Cable Loss (dB)	Corrected Reading (dBm)	Limit (dBm)	Margin (dB)
3815.2	-49.44	V	10.36	1.02	-40.1	-13	-27.1
3815.2	-49.14	H	10.36	1.02	-39.8	-13	-26.8
582.2	-52.56	V	6.36	0.35	-46.55	-13	-33.55
798.1	-53.22	H	6.43	0.47	-47.26	-13	-34.26

#### Note:

- 1, The testing has been conformed to  $10 \times 1907.6 \text{ MHz} = 19,076 \text{ MHz}$
- 2, All other emissions more than 30 dB below the limit
- 3, RMC, HSUPA and HSDPA mode were investigated. The results above show only the worse cases
- 4, X-Axis, Y-Axis and Z-Axis were investigated. The results above show only the worst case
- 5, The radiated spurious test above 18GHz is subcontracted to SIEMIC (Nanjing-China) Laboratories. and found 30dB below the limit at least.

### UMTS-FDD Band IV (Part 27)

#### Low channel

Frequency (MHz)	Substituted level (dBm)	Polarity (H/V)	Antenna Gain Correction (dB)	Cable Loss (dB)	Corrected Reading (dBm)	Limit (dBm)	Margin (dB)
3424.8	-44.23	V	10.07	0.96	-35.12	-13	-22.12
3424.8	-44.16	H	10.07	0.96	-35.05	-13	-22.05
831	-52.58	V	6.44	0.43	-46.57	-13	-33.57
905.3	-52.77	H	6.19	0.42	-47	-13	-34

#### Middle channel

Frequency (MHz)	Substituted level (dBm)	Polarity (H/V)	Antenna Gain Correction (dB)	Cable Loss (dB)	Corrected Reading (dBm)	Limit (dBm)	Margin (dB)
3480	-42.89	V	10.09	0.96	-33.76	-13	-20.76
3480	-43.16	H	10.09	0.96	-34.03	-13	-21.03
145.9	-51.81	V	0.98	0.2	-51.03	-13	-38.03
900.7	-51.73	H	6.17	0.41	-45.97	-13	-32.97

#### High channel

Frequency (MHz)	Substituted level (dBm)	Polarity (H/V)	Antenna Gain Correction (dB)	Cable Loss (dB)	Corrected Reading (dBm)	Limit (dBm)	Margin (dB)
3505.2	-44.35	V	10.09	0.97	-35.23	-13	-22.23
3505.2	-43.92	H	10.09	0.97	-34.8	-13	-21.8
748.2	-51.84	V	6.4	0.4	-45.84	-13	-32.84
203.5	-52.3	H	3.72	0.18	-48.76	-13	-35.76

**Note:**

- 1, The testing has been conformed to  $10 \times 1752.6 \text{MHz} = 17,526 \text{MHz}$
- 2, All other emissions more than 30 dB below the limit
- 3, RMC, HSUPA and HSDPA mode were investigated. The results above show only the worse cases.
- 4, X-Axis, Y-Axis and Z-Axis were investigated. The results above show only the worst case.

## 6.7 Band Edge

Temperature	26°C
Relative Humidity	56%
Atmospheric Pressure	1022mbar
Test date :	October 26, 2017
Tested By :	Loren Luo

### Requirement(s):

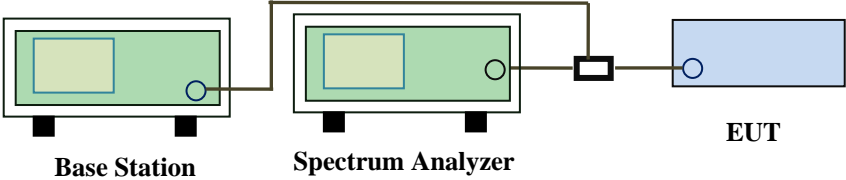
Spec	Item	Requirement	Applicable
§22.917(a) §24.238(a) § 27.53(h)	a)	The power of any emission outside of the authorized operating frequency ranges must be lower than the transmitter power (P) by a factor of at least $43 + 10 \log (P)$ dB.	<input checked="" type="checkbox"/>
Test setup	 <p>The diagram shows a Base Station (green box) and a Spectrum Analyzer (green box) connected to an EUT (blue box) via a power divider (black box). The Base Station and Spectrum Analyzer are connected to the power divider, which then splits the signal to the EUT.</p>		
Procedure	<ul style="list-style-type: none"> <li>- The EUT was connected to Spectrum Analyzer and Base Station via power divider.</li> <li>- The Band Edges of low and high channels for the highest RF powers were measured. Setting RBW as roughly BW/100.</li> </ul>		
Remark			
Result	<input checked="" type="checkbox"/> Pass <input type="checkbox"/> Fail		

Test Data     Yes       N/A  
 Test Plot     Yes (See below)       N/A

**GSM Voice:**

**Cellular Band (Part 22H) result**

Frequency (MHz)	Emission (dBm)	Limit (dBm)
823.9950	-17.83	-13
849.0175	-18.43	-13

**PCS Band (Part24E) result**

Frequency (MHz)	Emission (dBm)	Limit (dBm)
1849.983	-15.12	-13
1910.020	-15.20	-13

**GPRS:**

**Cellular Band (Part 22H) result**

Frequency (MHz)	Emission (dBm)	Limit (dBm)
823.9775	-18.98	-13
849.0225	-18.52	-13

**PCS Band (Part24E) result**

Frequency (MHz)	Emission (dBm)	Limit (dBm)
1849.9825	-15.15	-13
1910.0225	-14.43	-13

**EGPRS (MCS5):**

**Cellular Band (Part 22H) result**

Frequency (MHz)	Emission (dBm)	Limit (dBm)
823.9800	-17.54	-13
849.0200	-16.43	-13

**PCS Band (Part24E) result**

Frequency (MHz)	Emission (dBm)	Limit (dBm)
1849.9975	-14.76	-13
1910.0225	-15.95	-13

**RCM:**

**UMTS-FDD Band V (Part 22H)**

Frequency (MHz)	Emission (dBm)	Limit (dBm)
823.400	-27.95	-13
849.050	-26.03	-13

**UMTS-FDD Band II (Part 24E)**

Frequency (MHz)	Emission (dBm)	Limit (dBm)
1849.975	-25.32	-13
1910.025	-15.57	-13

**UMTS-FDD Band IV (Part 27)**

Frequency (MHz)	Emission (dBm)	Limit (dBm)
1709.075	-28.82	-13
1755.825	-30.04	-13

**HSUPA:**

**UMTS-FDD Band V (Part 22H)**

Frequency (MHz)	Emission (dBm)	Limit (dBm)
823.975	-28.47	-13
849.050	-25.37	-13

**UMTS-FDD Band II (Part 24E)**

Frequency (MHz)	Emission (dBm)	Limit (dBm)
1849.975	-25.33	-13
1911.100	-15.23	-13

**UMTS-FDD Band IV (Part 27)**

Frequency (MHz)	Emission (dBm)	Limit (dBm)
1709.050	-28.49	-13
1755.375	-30.33	-13

**HSDPA:**

**UMTS-FDD Band V (Part 22H)**

Frequency (MHz)	Emission (dBm)	Limit (dBm)
823.650	-28.30	-13
849.050	-25.97	-13

**UMTS-FDD Band II (Part 24E)**

Frequency (MHz)	Emission (dBm)	Limit (dBm)
1849.975	-23.97	-13
1910.025	-15.90	-13



### UMTS-FDD Band IV (Part 27)

Frequency (MHz)	Emission (dBm)	Limit (dBm)
1709.100	-27.77	-13
1755.025	-30.62	-13

**GSM Voice:  
Test Plots**

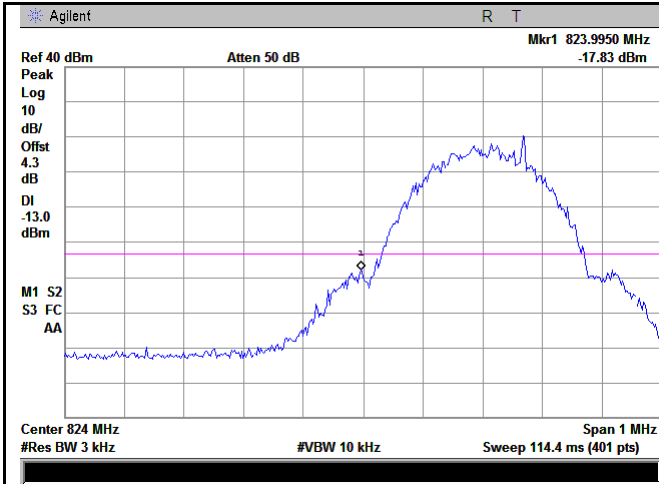

Cellular Band - Low Channel

Note: Offset=Cable loss (4.0) + 10log  
(3.21/3)=4.0+0.3=4.3dB

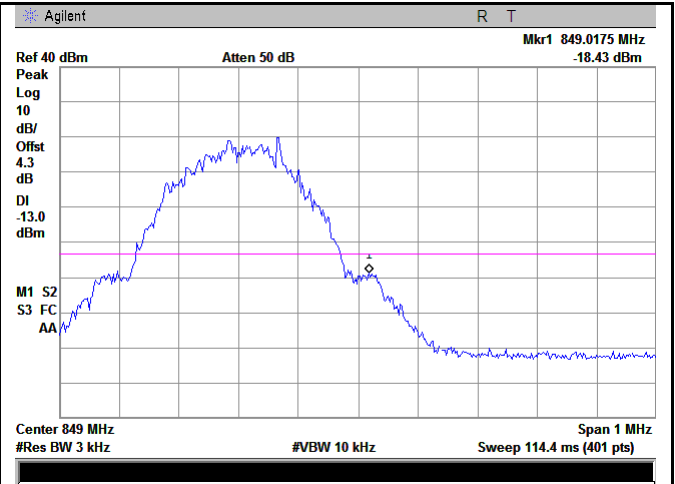

Cellular Band - High Channel

Note: Offset=Cable loss (4.0) + 10log  
(3.21/3)=4.0+0.3=4.3dB

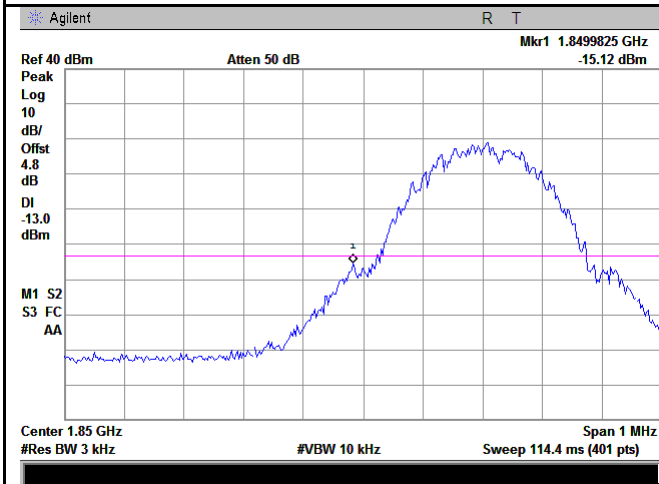

PCS Band - Low Channel

Note: Offset=Cable loss (4.0) + 10log  
(3.20/3)=4.5+0.3=4.8dB

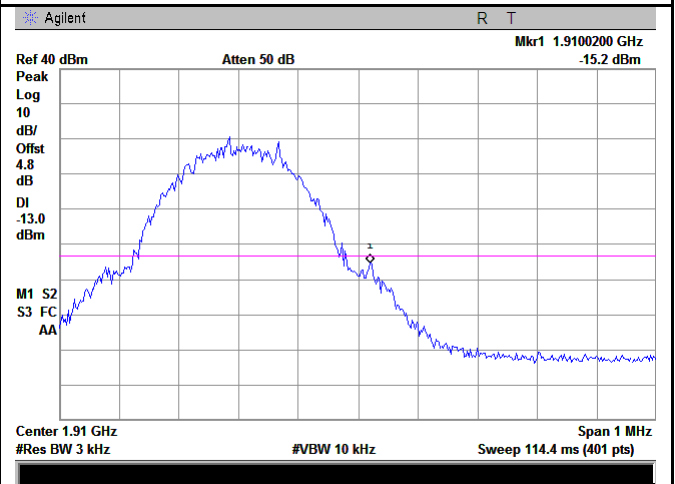

PCS Band - High Channel

Note: Offset=Cable loss (4.0) + 10log  
(3.20/3)=4.5+0.3=4.8dB

**GPRS:**

**Test Plots**

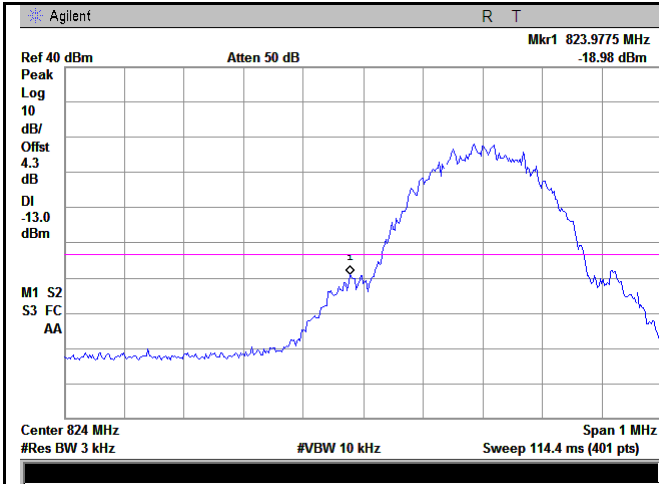

Cellular Band - Low Channel

Note: Offset=Cable loss (4.0) + 10log  
 (3.21/3)=4.0+0.3=4.3dB

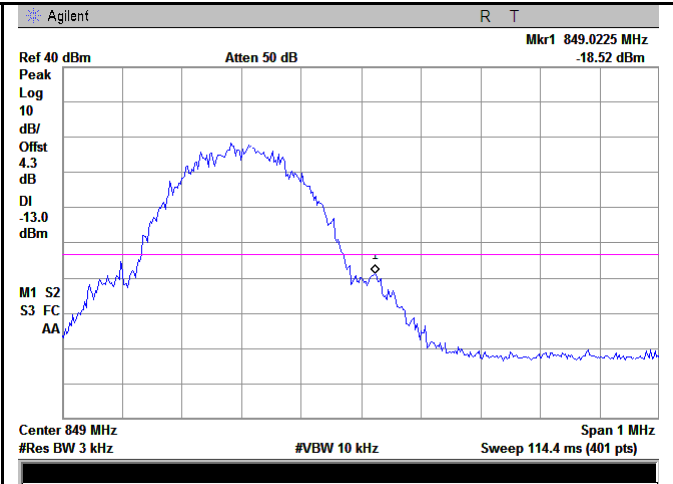

Cellular Band - High Channel

Note: Offset=Cable loss (4.0) + 10log  
 (3.21/3)=4.0+0.3=4.3dB

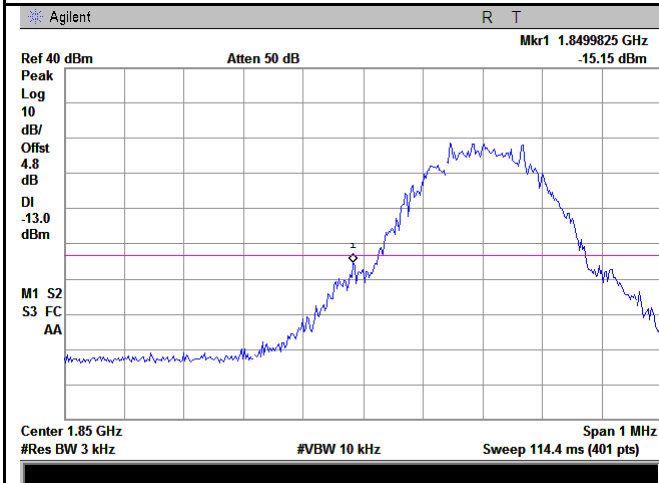

PCS Band - Low Channel

Note: Offset=Cable loss (4.5) + 10log  
 (3.21/3)=4.5+0.3=4.8dB

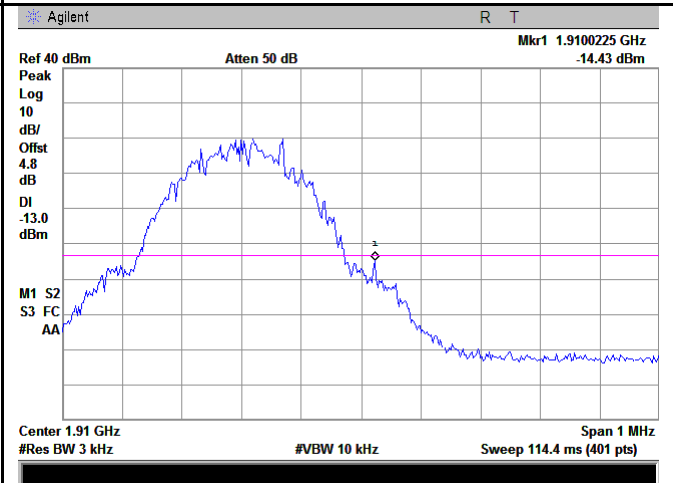

PCS Band - High Channel

Note: Offset=Cable loss (4.5) + 10log  
 (3.21/3)=4.5+0.3=4.8dB

## EGPRS (MCS5):

### Test Plots

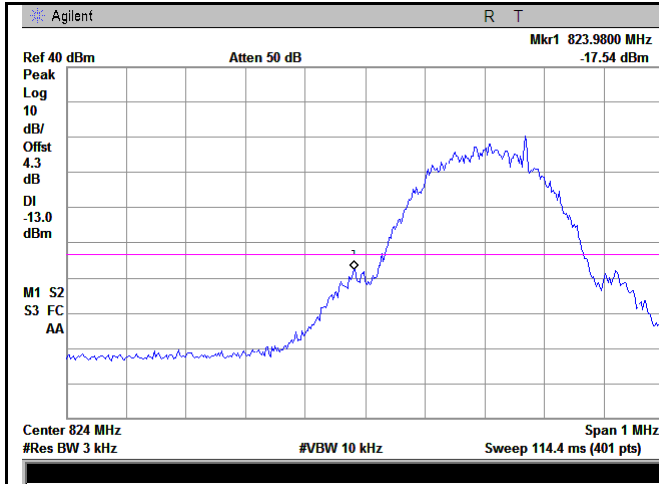

Cellular Band - Low Channel

Note: Offset=Cable loss (4.0) + 10log  
(3.21/3)=4.0+0.3=4.3dB

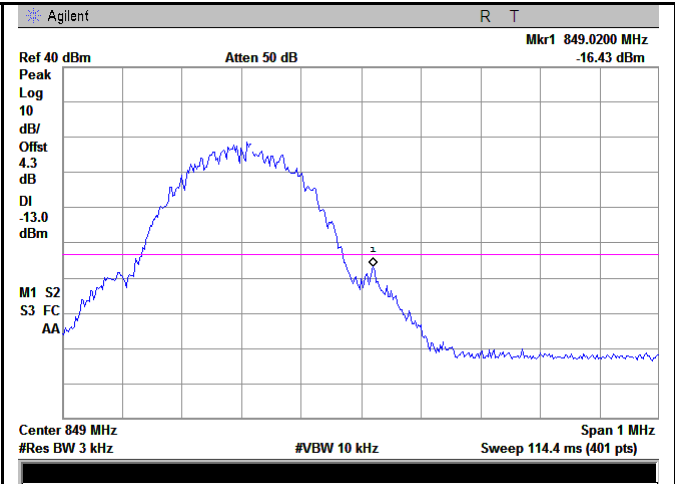

Cellular Band - High Channel

Note: Offset=Cable loss (4.0) + 10log  
(3.21/3)=4.0+0.3=4.3dB

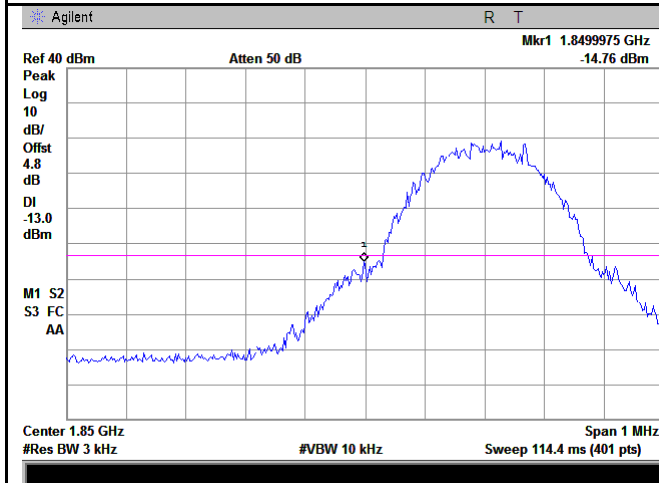

PCS Band - Low Channel

Note: Offset=Cable loss (4.5) + 10log  
(3.20/3)=4.5+0.3=4.8dB

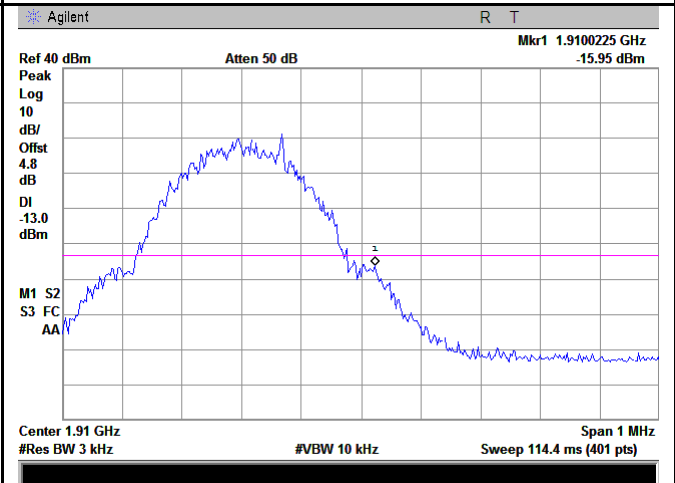

PCS Band - High Channel

Note: Offset=Cable loss (4.5) + 10log  
(3.20/3)=4.5+0.3=4.8dB

RMC:

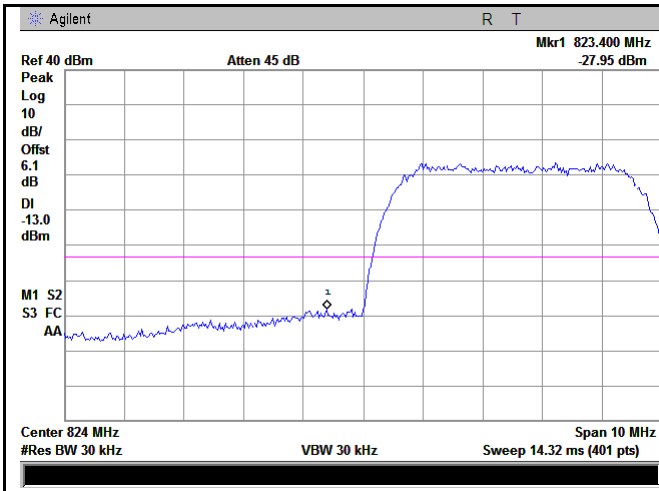

UMTS-FDD Band V - Low Channel

Note: Offset=Cable loss (4.0) + 10log  
(48.98/30)=4.0+2.1=6.1 dB

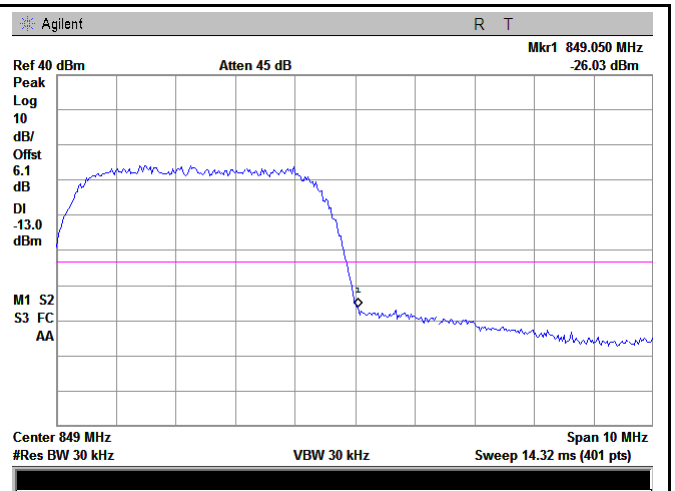

UMTS-FDD Band V - High Channel

Note: Offset=Cable loss (4.0) + 10log  
(49.15/30)=4.0+2.1=6.1 dB

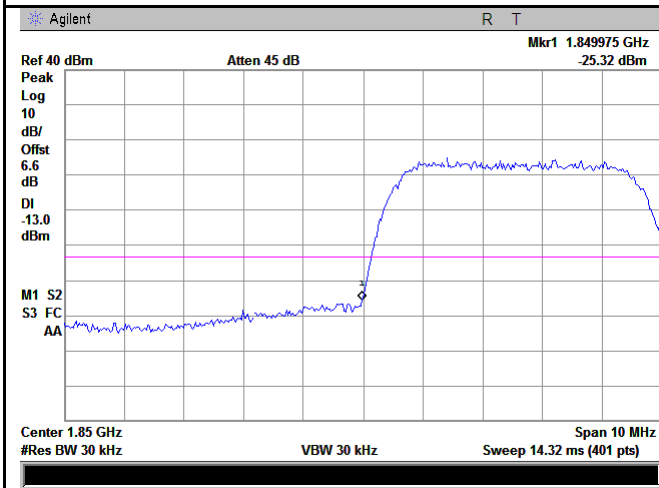

UMTS-FDD Band II - Low Channel

Note: Offset=Cable loss (4.5) + 10log  
(49.12/30)=4.5+2.1=6.6 dB

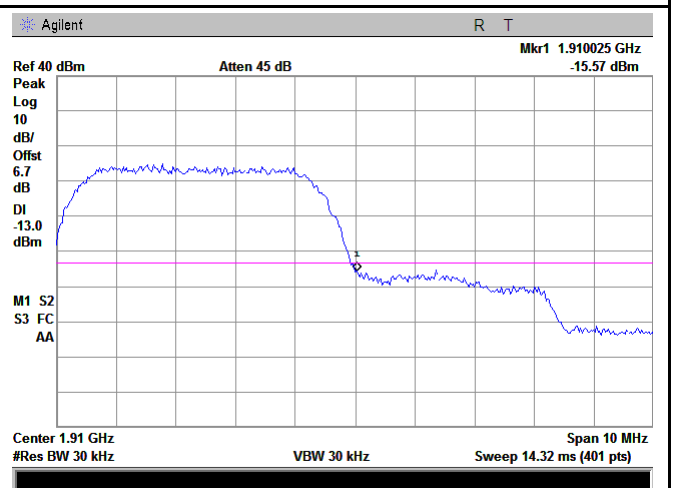

UMTS-FDD Band II - High Channel

Note: Offset=Cable loss (4.5) + 10log  
(49.57/30)=4.5+2.2=6.7 dB

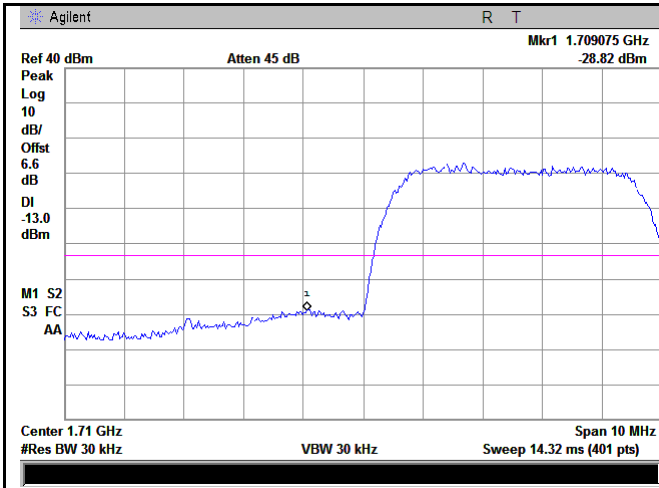

UMTS-FDD Band IV - Low Channel

Note: Offset=Cable loss (4.5) + 10log  
(48.88/30)=4.5+2.1=6.6 dB

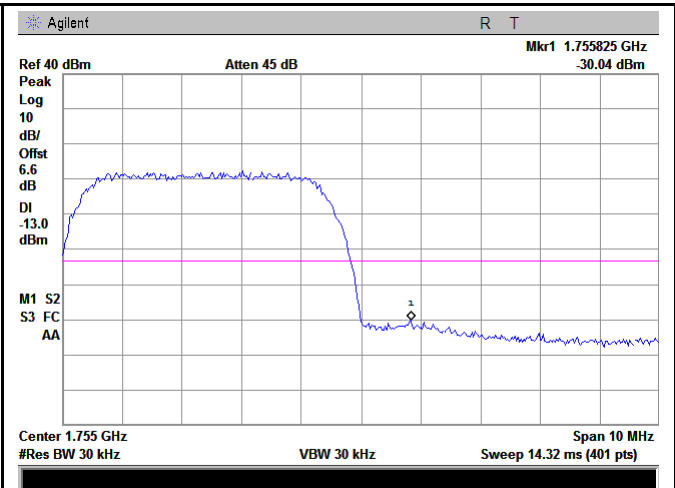

UMTS-FDD Band IV - High Channel

Note: Offset=Cable loss (4.0) + 10log  
(48.90/30)=4.5+2.1=6.6 dB

**HSUPA:**

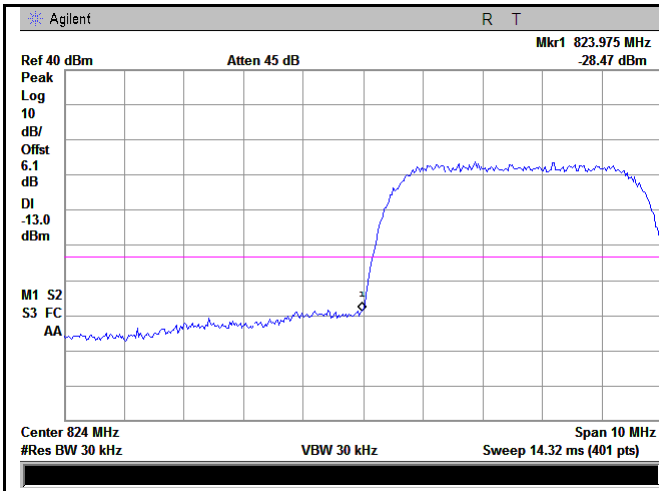

UMTS-FDD Band V - Low Channel

Note: Offset=Cable loss (4.0) + 10log  
(49.16/30)=4.0+2.1=6.1 dB

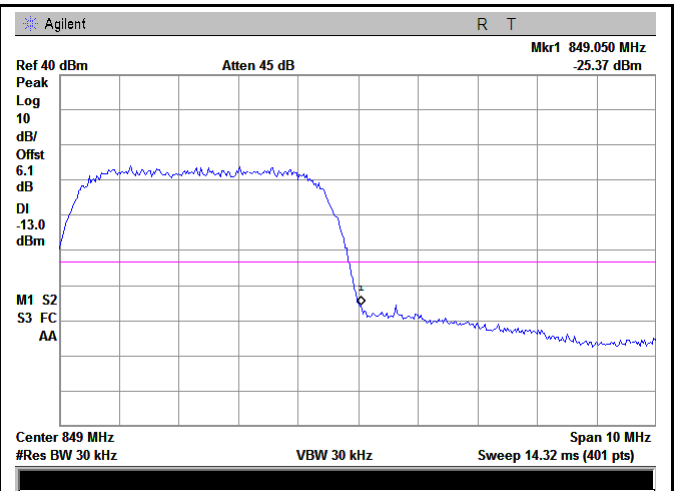

UMTS-FDD Band V - High Channel

Note: Offset=Cable loss (4.0) + 10log  
(48.99/30)=4.0+2.1=6.1 dB

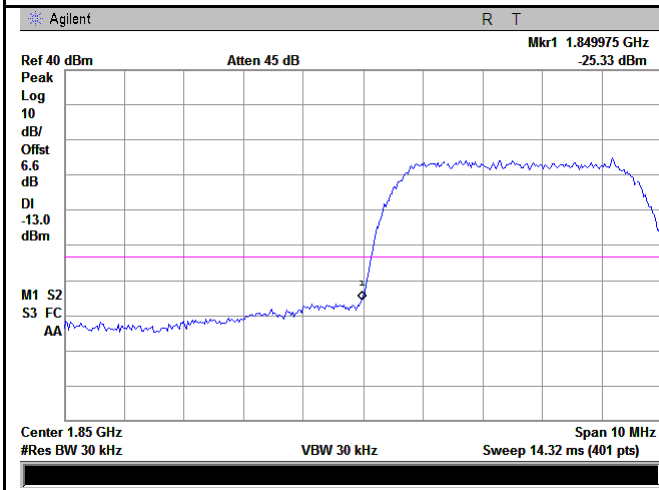

UMTS-FDD Band II - Low Channel

Note: Offset=Cable loss (4.5) + 10log  
(49.15/30)=4.5+2.1=6.6 dB

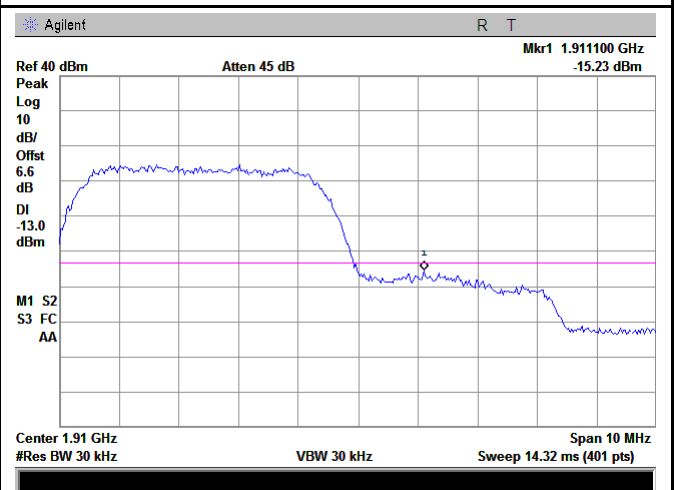

UMTS-FDD Band II - High Channel

Note: Offset=Cable loss (4.5) + 10log  
(48.61/30)=4.5+2.1=6.6 dB

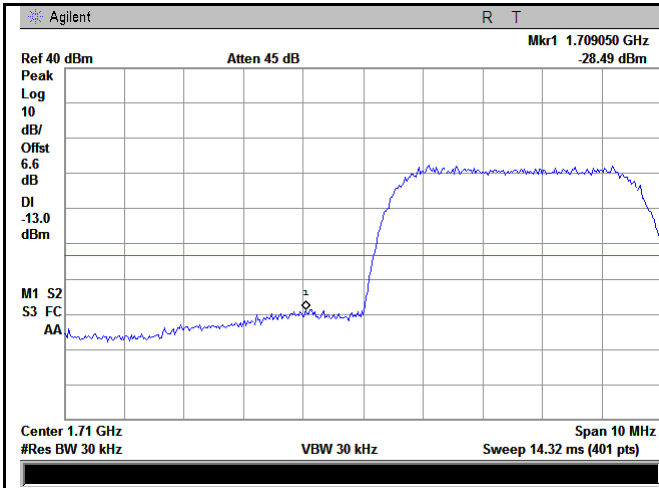

UMTS-FDD Band IV - Low Channel

Note: Offset=Cable loss (4.5) + 10log  
(48.75/30)=4.5+2.1=6.6 dB

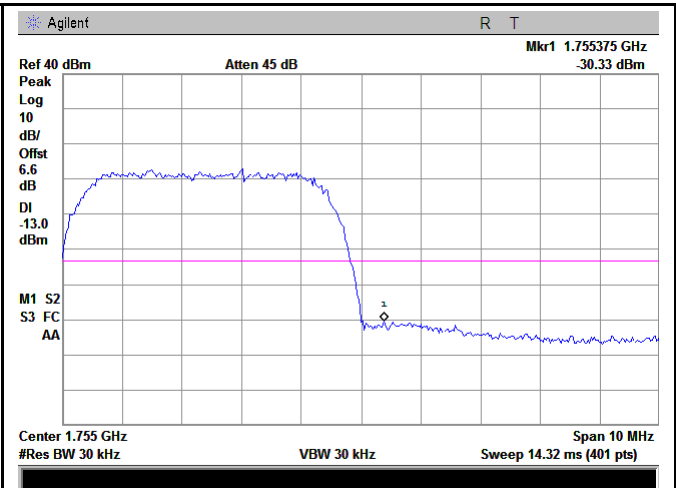

UMTS-FDD Band IV - High Channel

Note: Offset=Cable loss (4.5) + 10log  
(49.00/30)=4.5+2.1=6.6 dB



**HSDPA:**

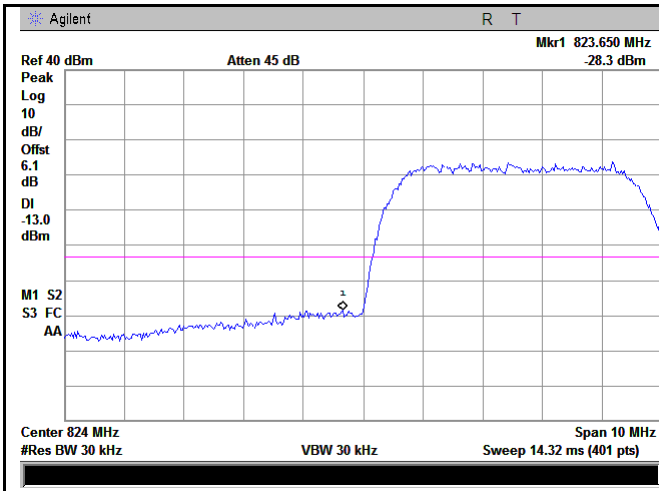

UMTS-FDD Band V - Low Channel

Note: Offset=Cable loss (4.0) + 10log  
(49.14/30)=4.0+2.1=6.1 dB

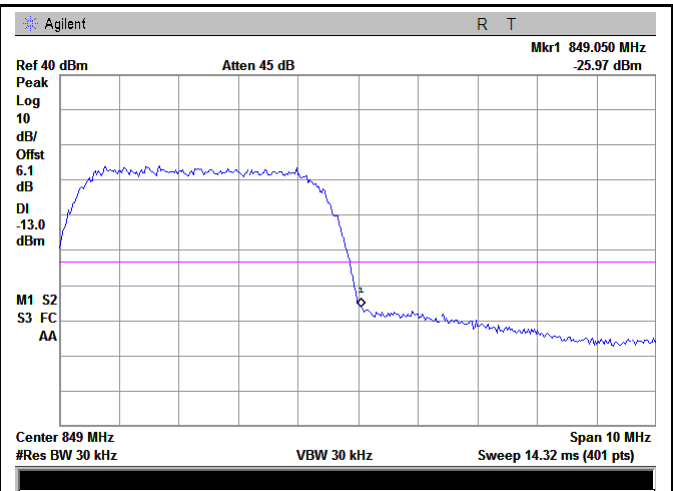

UMTS-FDD Band V - High Channel

Note: Offset=Cable loss (4.0) + 10log  
(49.11/30)=4.0+2.1=6.1 dB

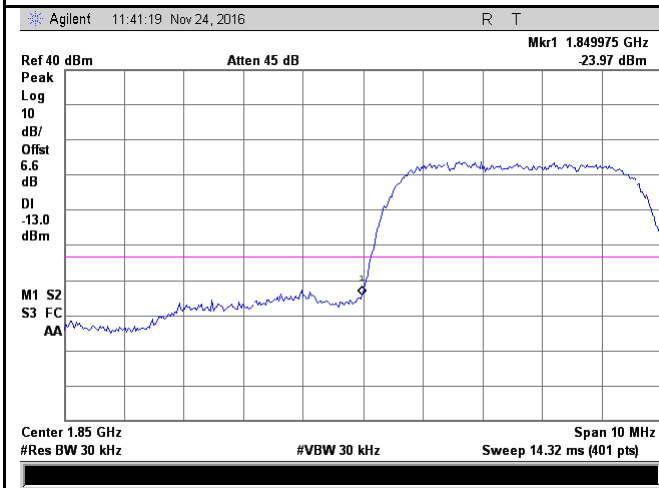

UMTS-FDD Band II - Low Channel

Note: Offset=Cable loss (4.5) + 10log  
(49.08/30)=4.5+2.1=6.6 dB

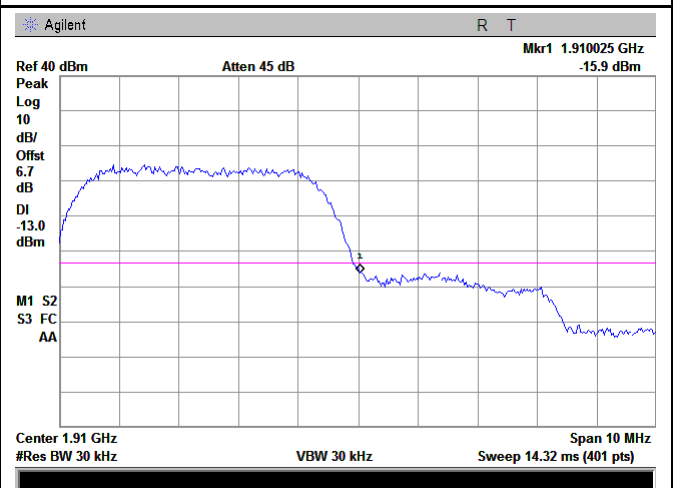

UMTS-FDD Band II - High Channel

Note: Offset=Cable loss (4.5) + 10log  
(49.56/30)=4.5+2.2=6.7 dB

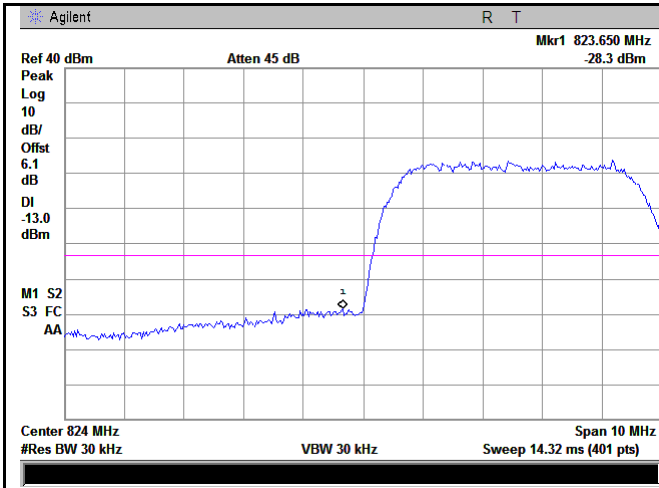

UMTS-FDD Band IV - Low Channel

Note: Offset=Cable loss (4.5) + 10log  
(48.82/30)=4.0+2.1=6.1 dB

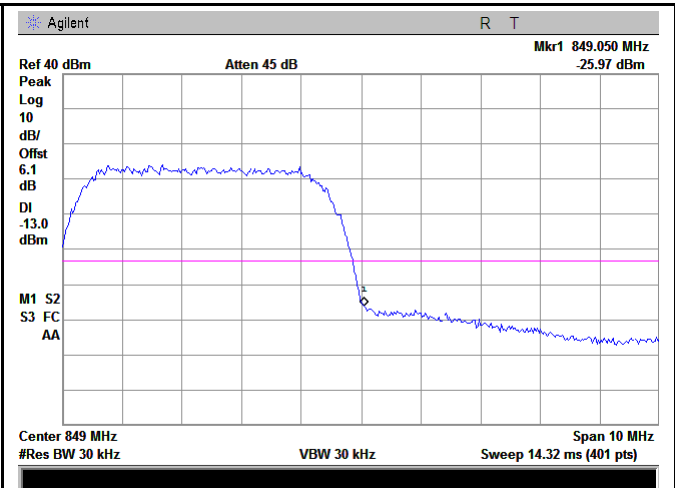

UMTS-FDD Band IV - High Channel

Note: Offset=Cable loss (4.5) + 10log  
(49.13/30)=4.0+2.1=6.1 dB

## 6.8 Frequency Stability

Temperature	26°C
Relative Humidity	56%
Atmospheric Pressure	1022mbar
Test date :	October 26, 2017
Tested By :	Loren Luo

### Requirement(s):

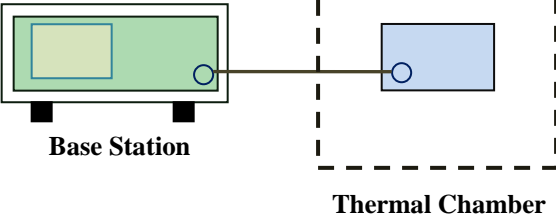
Spec	Item	Requirement	Applicable																																
§2.1055, §22.355 & §24.235 § 27.5(h); § 27.54	a)	According to §22.355, the carrier frequency of each transmitter in the Public Mobile Services must be maintained within the tolerances given in Table below:  Frequency Tolerance for Transmitters in the Public Mobile Services	<input checked="" type="checkbox"/>																																
		<table border="1"> <thead> <tr> <th>Frequency Range (MHz)</th> <th>Base, fixed (ppm)</th> <th>Mobile ≤ 3 watts (ppm)</th> <th>Mobile ≤ 3 watts (ppm)</th> </tr> </thead> <tbody> <tr> <td>25 to 50</td> <td>20.0</td> <td>20.0</td> <td>50.0</td> </tr> <tr> <td>50 to 450</td> <td>5.0</td> <td>5.0</td> <td>50.0</td> </tr> <tr> <td>450 to 512</td> <td>2.5</td> <td>5.0</td> <td>10</td> </tr> <tr> <td>821 to 896</td> <td>1.5</td> <td>2.5</td> <td>2.5</td> </tr> <tr> <td>928 to 929.</td> <td>5.0</td> <td>N/A</td> <td>N/A</td> </tr> <tr> <td>929 to 960.</td> <td>1.5</td> <td>N/A</td> <td>N/A</td> </tr> <tr> <td>2110 to 2220</td> <td>10.0</td> <td>N/A</td> <td>N/A</td> </tr> </tbody> </table>		Frequency Range (MHz)	Base, fixed (ppm)	Mobile ≤ 3 watts (ppm)	Mobile ≤ 3 watts (ppm)	25 to 50	20.0	20.0	50.0	50 to 450	5.0	5.0	50.0	450 to 512	2.5	5.0	10	821 to 896	1.5	2.5	2.5	928 to 929.	5.0	N/A	N/A	929 to 960.	1.5	N/A	N/A	2110 to 2220	10.0	N/A	N/A
		Frequency Range (MHz)		Base, fixed (ppm)	Mobile ≤ 3 watts (ppm)	Mobile ≤ 3 watts (ppm)																													
		25 to 50		20.0	20.0	50.0																													
		50 to 450		5.0	5.0	50.0																													
		450 to 512		2.5	5.0	10																													
		821 to 896		1.5	2.5	2.5																													
		928 to 929.		5.0	N/A	N/A																													
929 to 960.	1.5	N/A	N/A																																
2110 to 2220	10.0	N/A	N/A																																
According to §24.235, the frequency stability shall be sufficient to ensure that the fundamental emissions stay within the authorized frequency block.																																			
 <p style="text-align: center;"> <span>Base Station</span> <span style="margin-left: 100px;">Thermal Chamber</span> </p>																																			

Procedure	<p>A communication link was established between EUT and base station. The frequency error was monitored and measured by base station under variation of ambient temperature and variation of primary supply voltage.</p> <p>Limit: The frequency stability of the transmitter shall be maintained within <math>\pm 0.00025\%</math> (<math>\pm 2.5\text{ppm}</math>) of the center frequency.</p>
Remark	
Result	<input checked="" type="checkbox"/> Pass <input type="checkbox"/> Fail

Test Data     Yes                       N/A

Test Plot     Yes (See below)             N/A

**GSM Voice:**

**Cellular Band (Part 22H) result**

Middle Channel, $f_0 = 836.6$ MHz				
Temperature (°C)	Power Supplied (V <sub>DC</sub> )	Frequency Error (Hz)	Frequency Error (ppm)	Limit (ppm)
-10	3.85	20	0.0239	2.5
0		14	0.0167	2.5
10		18	0.0215	2.5
20		17	0.0203	2.5
30		13	0.0155	2.5
40		17	0.0203	2.5
50		19	0.0227	2.5
55		20	0.0239	2.5
25	4.4	20	0.0239	2.5
	3.6	16	0.0191	2.5

**PCS Band (Part 24E) result**

Middle Channel, $f_0 = 1880$ MHz				
Temperature (°C)	Power Supplied (V <sub>DC</sub> )	Frequency Error (Hz)	Frequency Error (ppm)	Limit (ppm)
-10	3.85	12	0.0064	2.5
0		15	0.0080	2.5
10		14	0.0074	2.5
20		13	0.0069	2.5
30		15	0.0080	2.5
40		17	0.0090	2.5
50		18	0.0096	2.5
55		16	0.0085	2.5
25	4.4	17	0.0090	2.5
	3.6	21	0.0112	2.5

RMC:

**UMTS-FDD Band V (Part 22H)**

Middle Channel, $f_0 = 835$ MHz				
Temperature (°C)	Power Supplied (V <sub>DC</sub> )	Frequency Error (Hz)	Frequency Error (ppm)	Limit (ppm)
-10	3.85	15	0.0180	2.5
0		16	0.0192	2.5
10		16	0.0192	2.5
20		14	0.0168	2.5
30		14	0.0168	2.5
40		11	0.0132	2.5
50		17	0.0204	2.5
55		15	0.0180	2.5
25	4.4	15	0.0180	2.5
	3.6	16	0.0192	2.5

**UMTS-FDD Band II (Part 24E)**

Middle Channel, $f_0 = 1880$ MHz				
Temperature (°C)	Power Supplied (V <sub>DC</sub> )	Frequency Error (Hz)	Frequency Error (ppm)	Limit (ppm)
-10	3.85	20	0.0106	2.5
0		16	0.0085	2.5
10		15	0.0080	2.5
20		14	0.0074	2.5
30		15	0.0080	2.5
40		17	0.0090	2.5
50		18	0.0096	2.5
55		19	0.0101	2.5
25	4.4	20	0.0106	2.5
	3.6	18	0.0096	2.5

**UMTS-FDD Band IV (Part 27)**

Middle Channel, $f_0 = 1733$ MHz				
Temperature (°C)	Power Supplied (V <sub>DC</sub> )	Frequency Error (Hz)	Frequency Error (ppm)	Limit (ppm)
-10	3.85	14	0.0168	2.5
0		14	0.0168	2.5
10		11	0.0132	2.5
20		13	0.0156	2.5
30		13	0.0156	2.5
40		15	0.0180	2.5
50		18	0.0216	2.5
55		19	0.0228	2.5
25		4.4	17	0.0204
	3.6	22	0.0263	2.5

## Annex A. TEST INSTRUMENT

Instrument	Model	Serial #	Cal Date	Cal Due	In use
<b>RF Conducted Test</b>					
Agilent ESA-E SERIES SPECTRUM ANALYZER	E4407B	MY45108319	09/14/2017	09/13/2018	<input checked="" type="checkbox"/>
Power Splitter	1#	1#	08/30/2017	08/29/2018	<input checked="" type="checkbox"/>
Universal Radio Communication Tester	CMU200	121393	09/23/2017	09/22/2018	<input checked="" type="checkbox"/>
Temperature/Humidity Chamber	UHL-270	001	10/07/2017	10/06/2018	<input checked="" type="checkbox"/>
DC Power Supply	E3640A	MY40004013	09/15/2017	09/14/2018	<input checked="" type="checkbox"/>
RF Power Sensor	Dare RPR3006C/P/W	AY554013	09/15/2017	09/14/2018	<input checked="" type="checkbox"/>
<b>Radiated Emissions</b>					
EMI test receiver	ESL6	100262	09/15/2017	09/14/2018	<input checked="" type="checkbox"/>
OPT 010 AMPLIFIER (0.1-1300MHz)	8447E	2727A02430	08/30/2017	08/29/2018	<input checked="" type="checkbox"/>
Horn Antenna	BBHA9170	3145226D1	09/27/2017	09/26/2018	<input checked="" type="checkbox"/>
Microwave Preamplifier (1 ~ 26.5GHz)	8449B	3008A02402	03/23/2017	03/22/2018	<input checked="" type="checkbox"/>
Bilog Antenna (30MHz~6GHz)	JB6	A110712	09/19/2017	09/18/2018	<input checked="" type="checkbox"/>
Bilog Antenna (30MHz~2GHz)	JB1	A112017	09/19/2017	09/18/2018	<input checked="" type="checkbox"/>
Double Ridge Horn Antenna (1 ~18GHz)	AH-118	71259	09/22/2017	09/21/2018	<input checked="" type="checkbox"/>
Double Ridge Horn Antenna (1 ~18GHz)	AH-118	71283	09/22/2017	09/21/2018	<input checked="" type="checkbox"/>
SYNTHESIZED SIGNAL GENERATOR	8665B	3744A01293	09/15/2017	09/14/2018	<input checked="" type="checkbox"/>
Power Amplifier	SMC150D	R1553-0313	03/08/2017	03/07/2018	<input checked="" type="checkbox"/>
Power Amplifier	S61-25	R1553-0516	05/26/2017	05/25/2018	<input checked="" type="checkbox"/>
Power Amplifier	S41-25D	R1553-0314	05/26/2017	05/25/2018	<input checked="" type="checkbox"/>





Test Report	17071091-FCC-R1
Page	89 of 106

Tunable Notch Filter	3NF-800/1000- S	AA4	08/30/2017	08/29/2018	<input checked="" type="checkbox"/>
----------------------	--------------------	-----	------------	------------	-------------------------------------

## Annex B. EUT And Test Setup Photographs

### Annex B.i. Photograph: EUT External Photo

Whole Package View



Adapter - Label View



EUT - Front View



EUT - Rear View



EUT - Top View



EUT - Bottom View

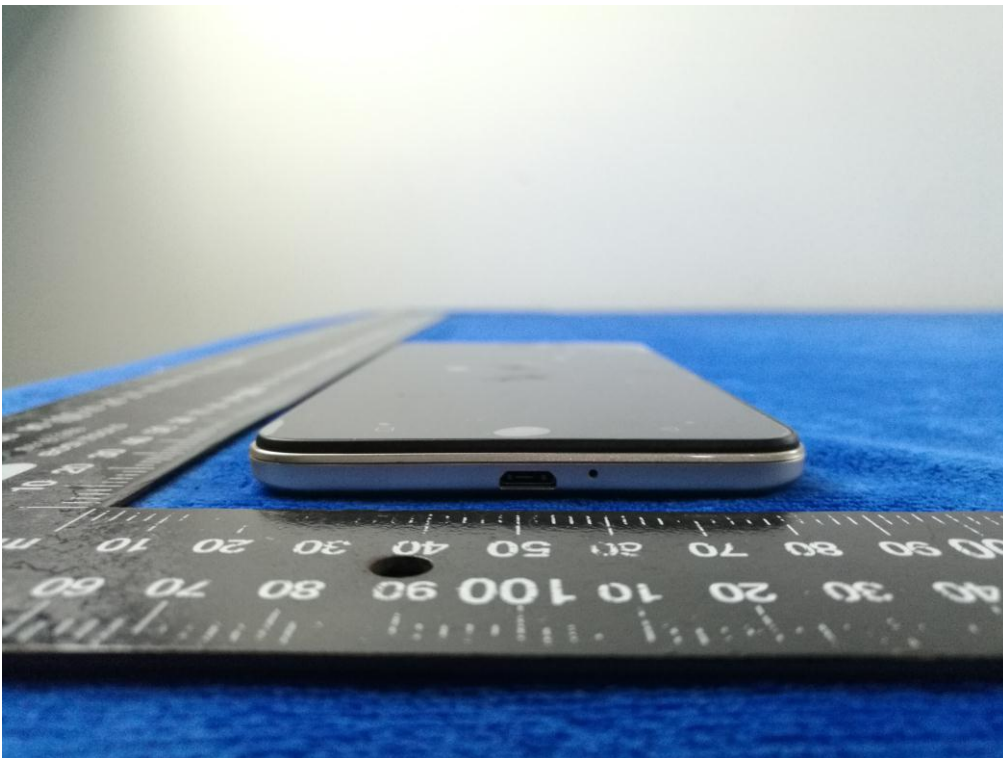



EUT - Left View



EUT - Right View



**Annex B.ii. Photograph: EUT Internal Photo**

Cover Off - Top View 1



Cover Off - Top View 2





Battery - Front View



Battery - Rear View







Mainboard with Shielding – Rear View

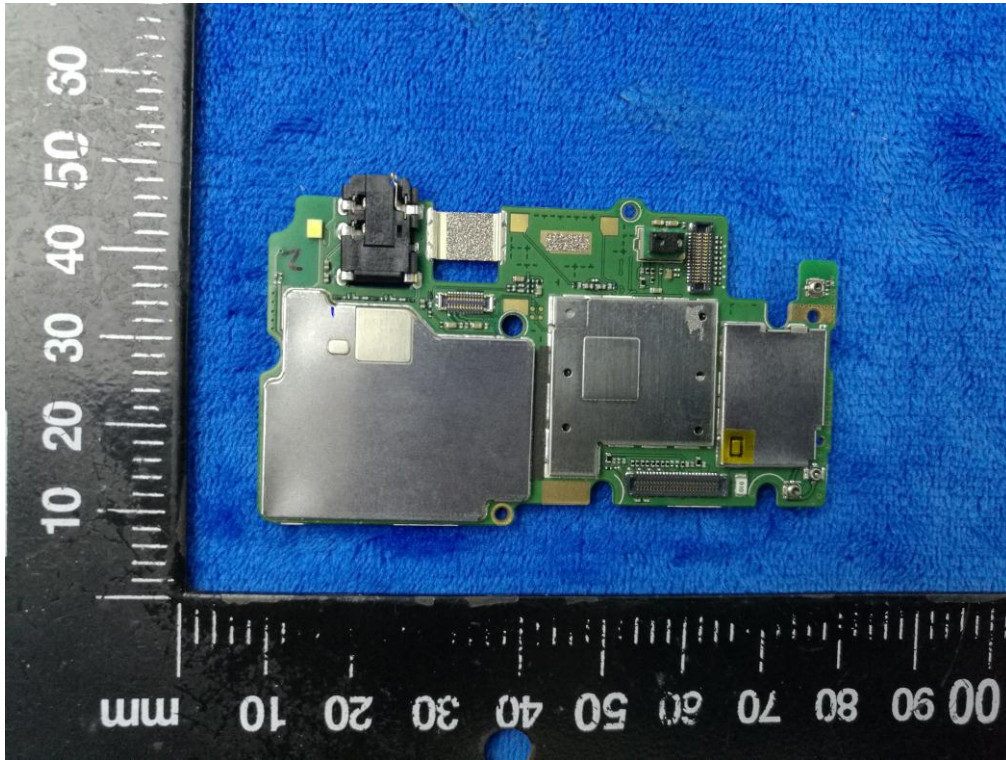

Mainboard without Shielding – Rear View

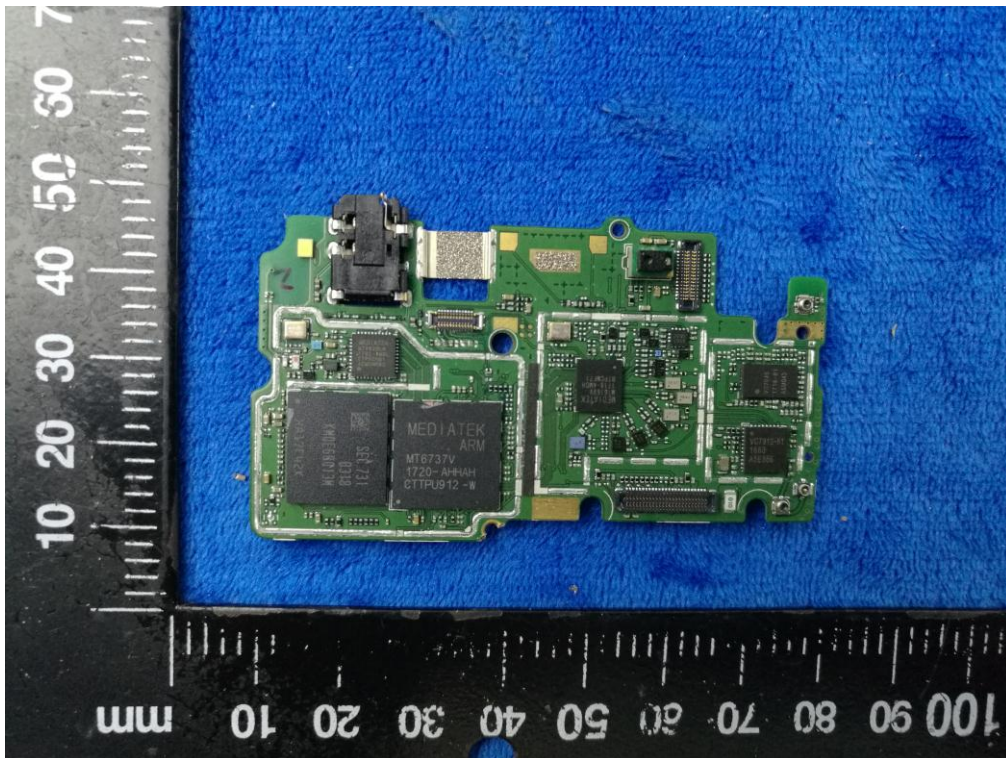

LCD – Front View



LCD – Rear View





GSM/PCS/UMTS-FDD/LTE Antenna View



WIFI/BT/BLE/GPS - Antenna View

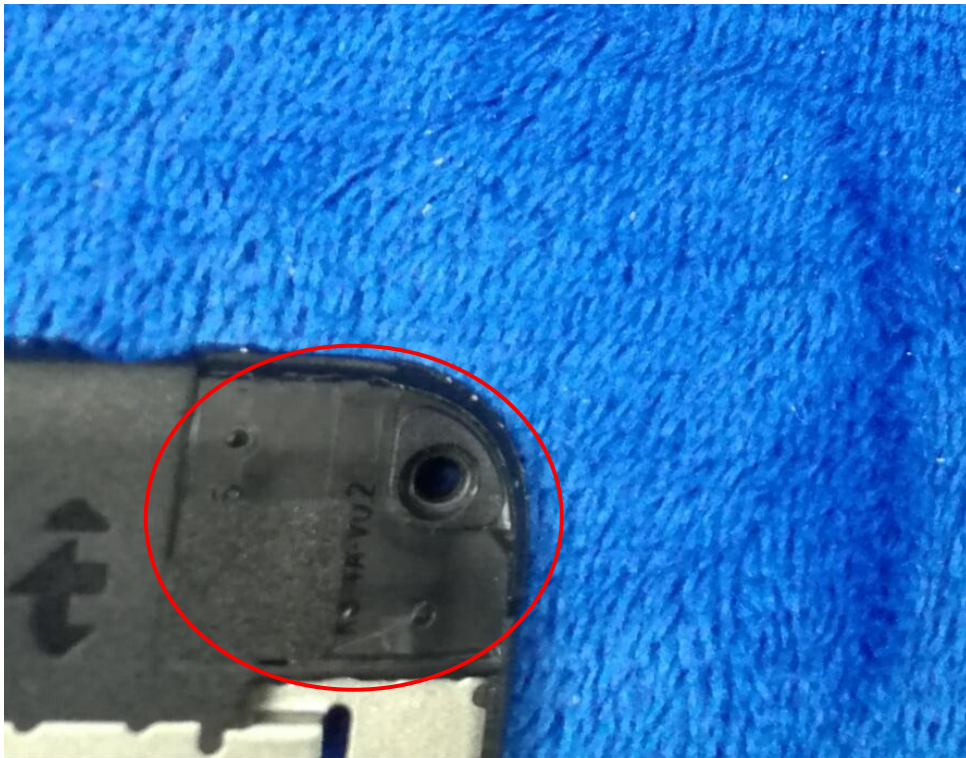

RXD- Antenna View



**Annex B.iii. Photograph: Test Setup Photo**

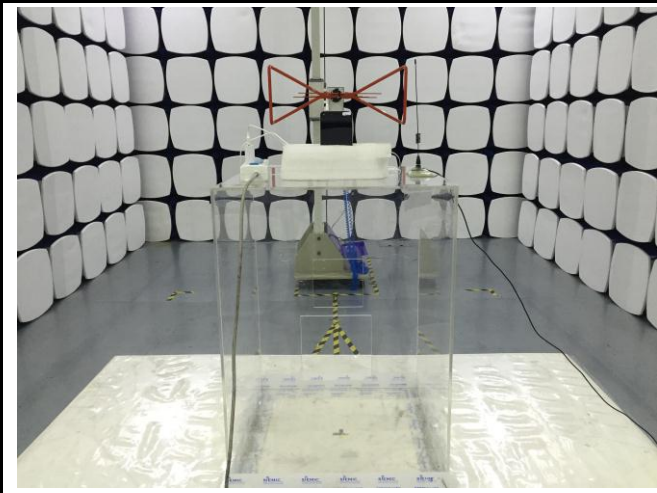

Radiated Spurious Emissions Test Setup Below 1GHz

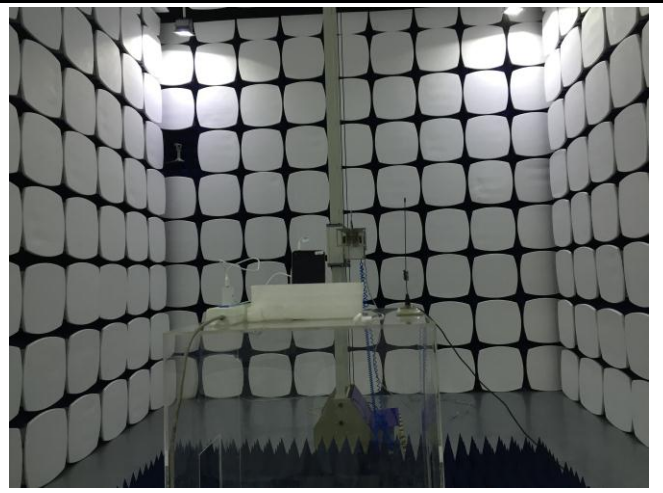

Radiated Spurious Emissions Test Setup Above  
1GHz

## Annex C. TEST SETUP AND SUPPORTING EQUIPMENT

### Annex C.ii. TEST SET UP BLOCK

#### Block Configuration Diagram for Radiated Emissions

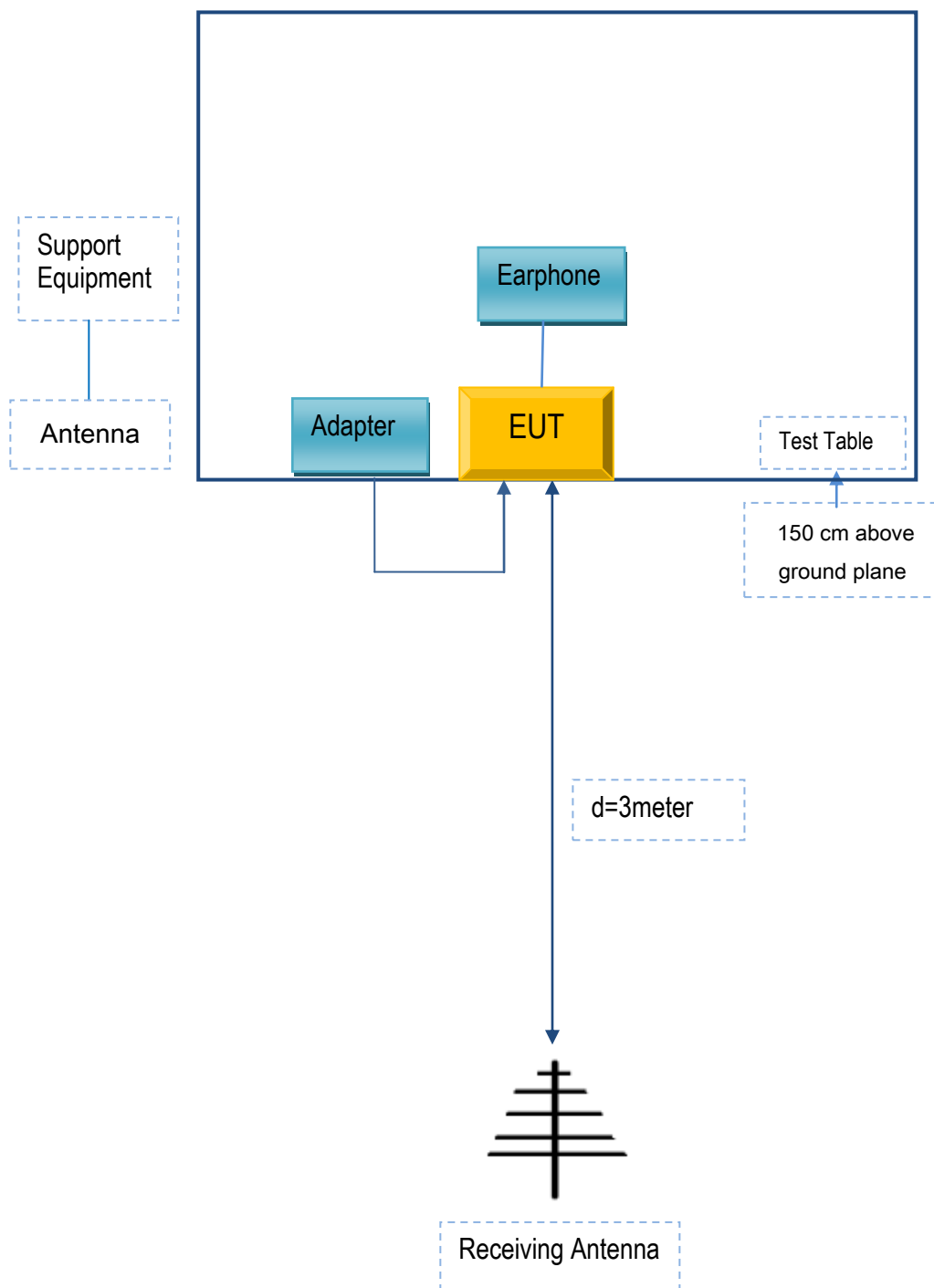

## **Annex C. ii. SUPPORTING EQUIPMENT DESCRIPTION**

The following is a description of supporting equipment and details of cables used with the EUT.

### **Supporting Equipment:**

Manufacturer	Equipment Description	Model	Serial No
TECNO MOBILE LIMITED	Adapter	CU-52JT	N/A
TECNO MOBILE LIMITED	Earphone	K8	N/A

### **Supporting Cable:**

Cable type	Shield Type	Ferrite Core	Length	Serial No
USB Cable	Un-shielding	No	0.8m	N/A

## Annex C.ii. EUT OPERATING CONKITIONS

N/A



Test Report	17071091-FCC-R1
Page	105 of 106

## Annex D. User Manual / Block Diagram / Schematics / Partlist

Please see the attachment

## Annex E. DECLARATION OF SIMILARITY

N/A