

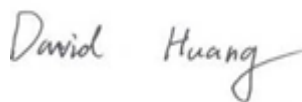

RF TEST REPORT



Report No.: 17071091-FCC-R4

Supersede Report No.: N/A

Applicant	TECNO MOBILE LIMITED	
Product Name	Mobile phone	
Model No.	K8	
Serial No.	N/A	
Test Standard	FCC Part 15.247: 2016, ANSI C63.10: 2013	
Test Date	October 17 to November 07, 2017	
Issue Date	November 08, 2017	
Test Result	<input checked="" type="checkbox"/> Pass <input type="checkbox"/> Fail	
Equipment complied with the specification	<input checked="" type="checkbox"/>	
Equipment did not comply with the specification	<input type="checkbox"/>	
		
Loren Luo Test Engineer	David Huang Checked By	
This test report may be reproduced in full only Test result presented in this test report is applicable to the tested sample only		

Issued by:

SIEMIC (SHENZHEN-CHINA) LABORATORIES

Zone A, Floor 1, Building 2 Wan Ye Long Technology Park

South Side of Zhoushi Road, Bao' an District, Shenzhen, Guangdong China 518108

Phone: +86 0755 2601 4629801 Email: China@siemic.com.cn

Laboratories Introduction

SIEMIC, headquartered in the heart of Silicon Valley, with superior facilities in US and Asia, is one of the leading independent testing and certification facilities providing customers with one-stop shop services for Compliance Testing and Global Certifications.



In addition to testing and certification, SIEMIC provides initial design reviews and compliance management throughout a project. Our extensive experience with China, Asia Pacific, North America, European, and International compliance requirements, assures the fastest, most cost effective way to attain regulatory compliance for the global markets.

Accreditations for Conformity Assessment

Country/Region	Scope
USA	EMC, RF/Wireless, SAR, Telecom
Canada	EMC, RF/Wireless, SAR, Telecom
Taiwan	EMC, RF, Telecom, SAR, Safety
Hong Kong	RF/Wireless, SAR, Telecom
Australia	EMC, RF, Telecom, SAR, Safety
Korea	EMI, EMS, RF, SAR, Telecom, Safety
Japan	EMI, RF/Wireless, SAR, Telecom
Singapore	EMC, RF, SAR, Telecom
Europe	EMC, RF, SAR, Telecom, Safety

Test Report No.	17071091-FCC-R4
Page	3 of 51

This page has been left blank intentionally.

CONTENTS

1. REPORT REVISION HISTORY	5
2. CUSTOMER INFORMATION	5
3. TEST SITE INFORMATION	6
4. EQUIPMENT UNDER TEST (EUT) INFORMATION	7
5. TEST SUMMARY	10
6. MEASUREMENTS, EXAMINATION AND DERIVED RESULTS	11
6.1 ANTENNA REQUIREMENT	11
6.2 DTS (6 DB) CHANNEL BANDWIDTH	12
6.3 MAXIMUM OUTPUT POWER	14
6.4 POWER SPECTRAL DENSITY	16
6.5 BAND-EDGE & UNWANTED EMISSIONS INTO RESTRICTED FREQUENCY BANDS	18
6.6 AC POWER LINE CONDUCTED EMISSIONS	21
6.7 RADIATED EMISSIONS & RESTRICTED BAND	27
ANNEX A. TEST INSTRUMENT	34
ANNEX B. EUT AND TEST SETUP PHOTOGRAPHS	35
ANNEX C. TEST SETUP AND SUPPORTING EQUIPMENT	46
ANNEX D. USER MANUAL / BLOCK DIAGRAM / SCHEMATICS / PARTLIST	50
ANNEX E. DECLARATION OF SIMILARITY	51

1. Report Revision History

Report No.	Report Version	Description	Issue Date
17071091-FCC-R4	NONE	Original	November 08, 2017

2. Customer information

Applicant Name	TECNO MOBILE LIMITED
Applicant Add	ROOMS 05-15, 13A/F., SOUTH TOWER, WORLD FINANCE CENTRE, HARBOUR CITY, 17 CANTON ROAD, TSIM SHA TSUI, KOWLOON, HONG KONG
Manufacturer	SHENZHEN TECNO TECHNOLOGY CO.,LTD.
Manufacturer Add	1-4th Floor,3rd Building,Pacific Industrial Park,No.2088,Shenyan Road,Yantian District,Shenzhen,Guangdong,China

3. Test site information

Test Lab A:

Lab performing tests	SIEMIC (Shenzhen-China) LABORATORIES
Lab Address	Zone A, Floor 1, Building 2 Wan Ye Long Technology Park South Side of Zhoushi Road, Bao' an District, Shenzhen, Guangdong China 518108
FCC Test Site No.	535293
IC Test Site No.	4842E-1
Test Software	Radiated Emission Program-To Shenzhen v2.0

Test Lab B:

Lab performing tests	SIEMIC (Nanjing-China) Laboratories
Lab Address	2-1 Longcang Avenue Yuhua Economic and Technology Development Park, Nanjing, China
FCC Test Site No.	694825
IC Test Site No.	4842B-1
Test Software	EZ_EMG(ver.lcp-03A1)

Note: We just perform Radiated Spurious Emission above 18GHz in the test Lab. B.

4. Equipment under Test (EUT) Information

Description of EUT:	Mobile phone
Main Model:	K8
Serial Model:	N/A
Date EUT received:	October 17, 2017
Test Date(s):	October 17 to November 07, 2017
Equipment Category :	DTS
Antenna Gain:	GSM850: -0.2dBi PCS1900: 1.7dBi UMTS-FDD Band V: -0.2dBi UMTS-FDD Band IV: 1.7dBi UMTS-FDD Band II: 1.7dBi LTE Band II:1.7dBi LTE Band IV: 1.7dBi LTE Band VII:2.5dBi Bluetooth/BLE: 2.0dBi WIFI: 2.0dBi GPS:1.7dBi
Antenna Type:	PIFA antenna
Type of Modulation:	GSM / GPRS: GMSK EGPRS: GMSK,8PSK UMTS-FDD: QPSK LTE Band: QPSK, 16QAM 802.11b/g/n: DSSS, OFDM Bluetooth: GFSK, π /4DQPSK, 8DPSK BLE: GFSK GPS:BPSK

Test Report No.	17071091-FCC-R4
Page	9 of 51

Input Power: Adapter:
Model: CU-52JT
Input: AC100-240V~50/60Hz,200mA
Output: DC 5.0V~1.2A
Battery:
Model: BL-30RT
Rating: 3.85V, 3000mAh, 11.55Wh
Limited charge voltage: 4.4V

FCC ID: 2ADYY-K8

5. Test Summary

The product was tested in accordance with the following specifications.

All testing has been performed according to below product classification:

FCC Rules	Description of Test	Result
§15.203	Antenna Requirement	Compliance
§15.247 (a)(2)	DTS (6 dB) CHANNEL BANDWIDTH	Compliance
§15.247(b)(3)	Conducted Maximum Output Power	Compliance
§15.247(e)	Power Spectral Density	Compliance
§15.247(d)	Band-Edge & Unwanted Emissions into Restricted Frequency Bands	Compliance
§15.207 (a),	AC Power Line Conducted Emissions	Compliance
§15.205, §15.209, §15.247(d)	Radiated Emissions & Unwanted Emissions into Restricted Frequency Bands	Compliance

Measurement Uncertainty

Emissions		
Test Item	Description	Uncertainty
Band-Edge & Unwanted Emissions into Restricted Frequency Bands and Radiated Emissions & Unwanted Emissions into Restricted Frequency Bands	Confidence level of approximately 95% (in the case where distributions are normal), with a coverage factor of 2 (for EUTs < 0.5m X 0.5m X 0.5m)	+5.6dB/-4.5dB
-	-	-

6. Measurements, Examination And Derived Results

6.1 Antenna Requirement

Applicable Standard

According to § 15.203, an intentional radiator shall be designed to ensure that no antenna other than that furnished by the responsible party shall be used with the device. The use of a permanently attached antenna or of an antenna that uses a unique coupling to the intentional radiator shall be considered sufficient to comply with the provisions of this section. The manufacturer may design the unit so that a broken antenna can be replaced by the user, but the user of a standard antenna jack or electrical connector is prohibited. The structure and application of the EUT were analyzed to determine compliance with section §15.203 of the rules. §15.203 state that the subject device must meet the following criteria:

- a. Antenna must be permanently attached to the unit.
- b. Antenna must use a unique type of connector to attach to the EUT.

Unit must be professionally installed, and installer shall be responsible for verifying that the correct antenna is employed with the unit.

And according to FCC 47 CFR section 15.247 (b), if the transmitting antennas of directional gain greater than 6dBi are used, the power shall be reduced by the amount in dB that the directional gain of the antenna exceeds 6 dBi.

Antenna Connector Construction

The EUT has 2 antennas:

A permanently attached PIFA antenna for Bluetooth/BLE/WIF/GPS, the gain is 2.0dBi for Bluetooth/BLE, the gain is 2.0dBi for WIFI, the gain is 1.7dBi for GPS.

A permanently attached PIFA antenna for GSM/PCS/UMTS/ LTE Band II/IV/VII, the gain is -0.2dBi for GSM850, 1.7dBi for PCS1900, -0.2dBi for UMTS-FDD Band V, 1.7dBi for UMTS-FDD Band II, 1.7dBi for UMTS-FDD Band IV, the gain is 1.7dBi for LTE Band II, 1.7dBi for LTE Band IV, 2.5dBi for LTE Band VII.

The antenna meets up with the ANTENNA REQUIREMENT.

Result: Compliance.

6.2 DTS (6 dB) Channel Bandwidth

Temperature	25°C
Relative Humidity	57%
Atmospheric Pressure	1014mbar
Test date :	October 20, 2017
Tested By :	Loren Luo

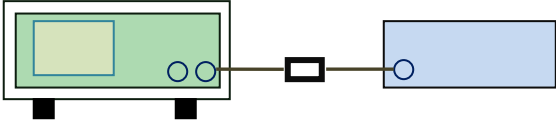
Spec	Item	Requirement	Applicable
§ 15.247(a)(2)	a)	6dB BW ≥ 500kHz;	<input checked="" type="checkbox"/>
RSS Gen(4.6.1)	b)	99% BW: For FCC reference only; required by IC.	<input checked="" type="checkbox"/>
Test Setup	 <p style="text-align: center;">Spectrum Analyzer EUT</p>		
Test Procedure	<p>558074 D01 DTS MEAS Guidance v03r03, 8.1 DTS bandwidth <u>6dB Emission bandwidth measurement procedure</u></p> <ul style="list-style-type: none"> - Set RBW = 100 kHz. - Set the video bandwidth (VBW) ≥ 3 RBW. - Detector = Peak. - Trace mode = max hold. - Sweep = auto couple. - Allow the trace to stabilize. <p>Measure the maximum width of the emission that is constrained by the frequencies associated with the two outermost amplitude points (upper and lower frequencies) that are attenuated by 6 dB relative to the maximum level measured in the fundamental emission.</p>		
Remark			
Result	<input checked="" type="checkbox"/> Pass <input type="checkbox"/> Fail		

Test Data Yes N/A

Test Plot Yes (See below) N/A

6dB Bandwidth measurement result

Test Data

CH	Frequency (MHz)	6dB Bandwidth (kHz)	99% Occupied Bandwidth (MHz)
Low	2402	734.599	1.0670
Mid	2440	741.692	1.0633
High	2480	739.482	1.0617

Test Plots

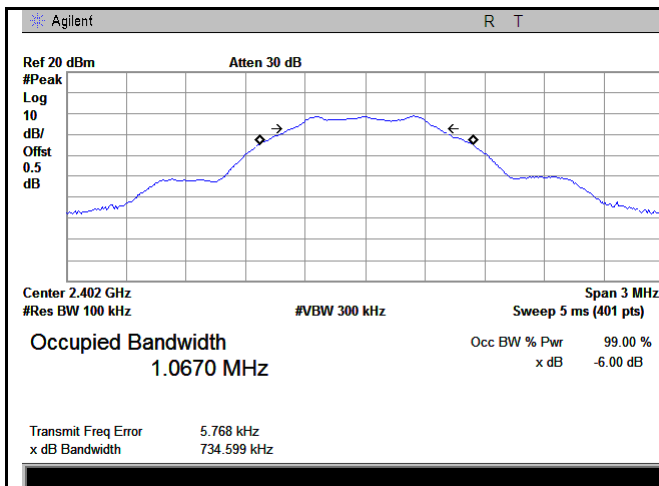

6dB Bandwidth - Low CH 2402

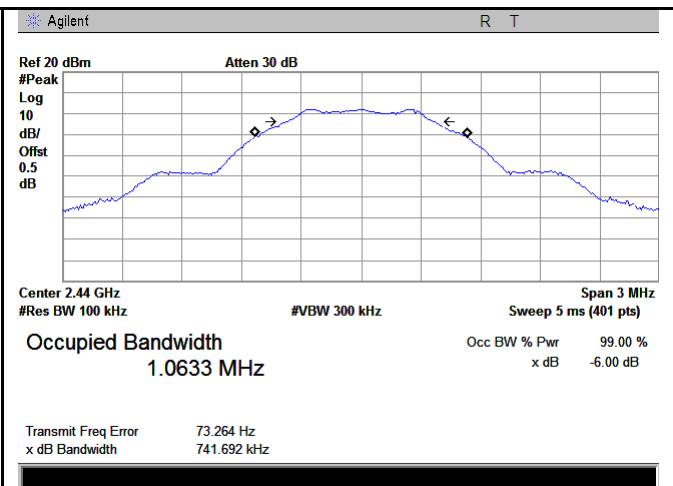

6dB Bandwidth - Mid CH 2440

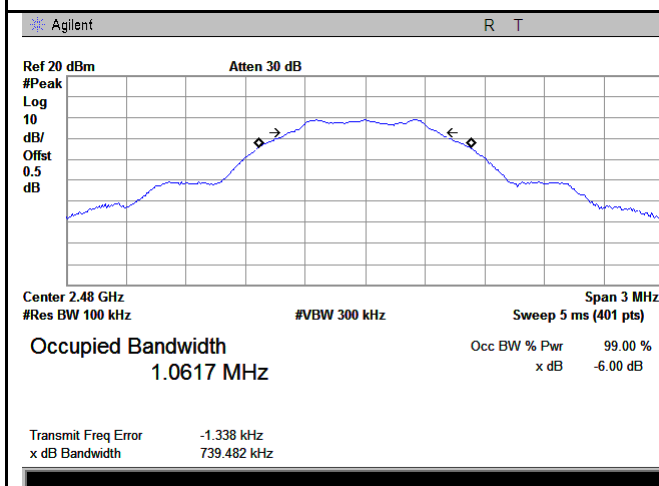

6dB Bandwidth - High CH 2480

6.3 Maximum Output Power

Temperature	25°C
Relative Humidity	57%
Atmospheric Pressure	1014mbar
Test date :	October 20, 2017
Tested By :	Loren Luo

Requirement(s):

Spec	Item	Requirement	Applicable
§15.247(b) (3),RSS210 (A8.4)	a)	FHSS in 2400-2483.5MHz with ≥ 75 channels: ≤ 1 Watt	<input type="checkbox"/>
	b)	FHSS in 5725-5850MHz: ≤ 1 Watt	<input type="checkbox"/>
	c)	For all other FHSS in the 2400-2483.5MHz band: ≤ 0.125 Watt.	<input type="checkbox"/>
	d)	FHSS in 902-928MHz with ≥ 50 channels: ≤ 1 Watt	<input type="checkbox"/>
	e)	FHSS in 902-928MHz with ≥ 25 & <50 channels: ≤ 0.25 Watt	<input type="checkbox"/>
	f)	DTS in 902-928MHz, 2400-2483.5MHz: ≤ 1 Watt	<input checked="" type="checkbox"/>

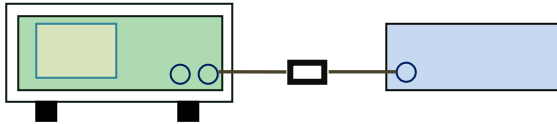
Test Setup	 <p style="text-align: center;">Spectrum Analyzer EUT</p>
------------	--

Test Procedure	<p>558074 D01 DTS MEAS Guidance v03r03, 9.1.2 Integrated band power method Maximum output power measurement procedure</p> <p>a) Set the RBW \geq DTS bandwidth. b) Set VBW $\geq 3 \times$ RBW. c) Set span $\geq 3 \times$ RBW d) Sweep time = auto couple. e) Detector = peak. f) Trace mode = max hold. g) Allow trace to fully stabilize. h) Use peak marker function to determine the peak amplitude level.</p>
----------------	---

Remark	
Result	<input checked="" type="checkbox"/> Pass <input type="checkbox"/> Fail

Test Data Yes N/A
 Test Plot Yes (See below) N/A

Output Power measurement result

Test Data

Type	CH	Frequency (MHz)	Conducted Power (dBm)	Limit (dBm)	Result
Output power	Low	2402	-0.089	30	Pass
	Mid	2440	-0.283	30	Pass
	High	2480	-0.376	30	Pass

Test Plots

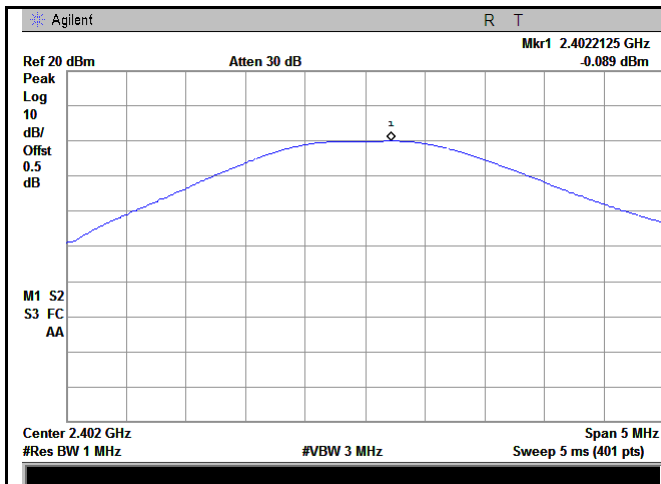

PK Output power - Low CH 2402

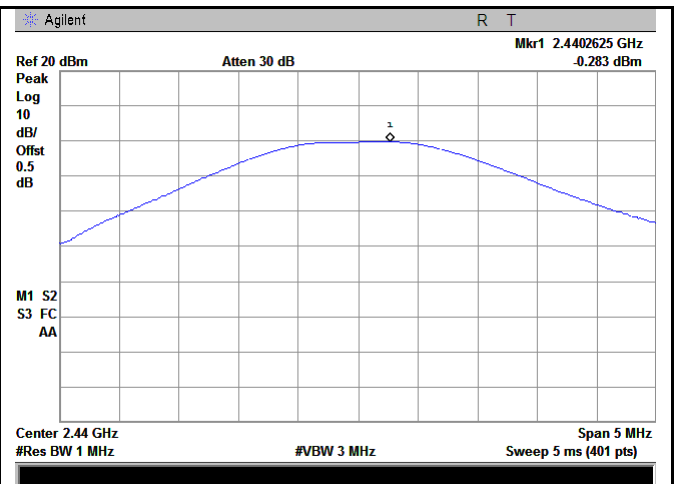

PK Output power - Mid CH 2440

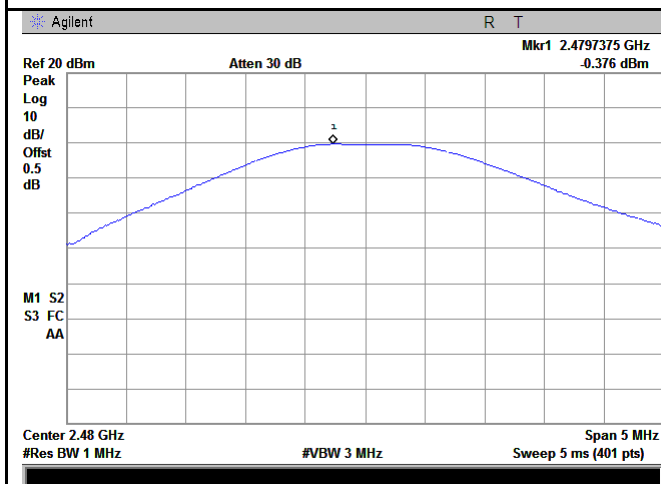

PK Output power - High CH 2480

6.4 Power Spectral Density

Temperature	25°C
Relative Humidity	57%
Atmospheric Pressure	1014mbar
Test date :	October 20, 2017
Tested By :	Loren Luo

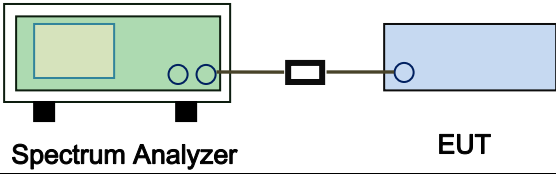
Spec	Item	Requirement	Applicable
§15.247(e)	a)	The power spectral density conducted from the intentional radiator to the antenna shall not be greater than 8 dBm in any 3 kHz band during any time interval of continuous transmission.	<input checked="" type="checkbox"/>
Test Setup	 <p style="text-align: center;">Spectrum Analyzer EUT</p>		
Test Procedure	<p>558074 D01 DTS MEAS Guidance v03r03, 10.2 power spectral density method power spectral density measurement procedure</p> <ul style="list-style-type: none"> - a) Set analyzer center frequency to DTS channel center frequency. - b) Set the span to 1.5 times the DTS bandwidth. - c) Set the RBW to: $3 \text{ kHz} \leq \text{RBW} \leq 100 \text{ kHz}$. - d) Set the VBW $\geq 3 \times \text{RBW}$. - e) Detector = peak. - f) Sweep time = auto couple. - g) Trace mode = max hold. - h) Allow trace to fully stabilize. - i) Use the peak marker function to determine the maximum amplitude level within the RBW. - j) If measured value exceeds limit, reduce RBW (no less than 3 kHz) and repeat. 		
Remark			
Result	<input checked="" type="checkbox"/> Pass <input type="checkbox"/> Fail		

Test Data Yes N/A
 Test Plot Yes (See below) N/A

Power Spectral Density measurement result

Test Data

Type	CH	Freq (MHz)	Reading (dBm)	Factor (dB)	Result (dBm)	Limit (dBm)	Result
PSD	Low	2402	-9.701	-5.23	-14.931	8	Pass
	Mid	2440	-6.376	-5.23	-11.606	8	Pass
	High	2480	-9.499	-5.23	-14.729	8	Pass

Note: factor=10log(3/10)=-5.23

Test Plots

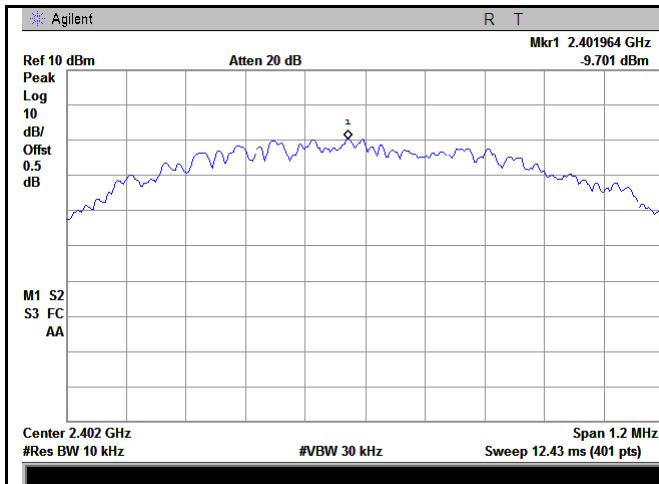

PSD - Low CH 2402

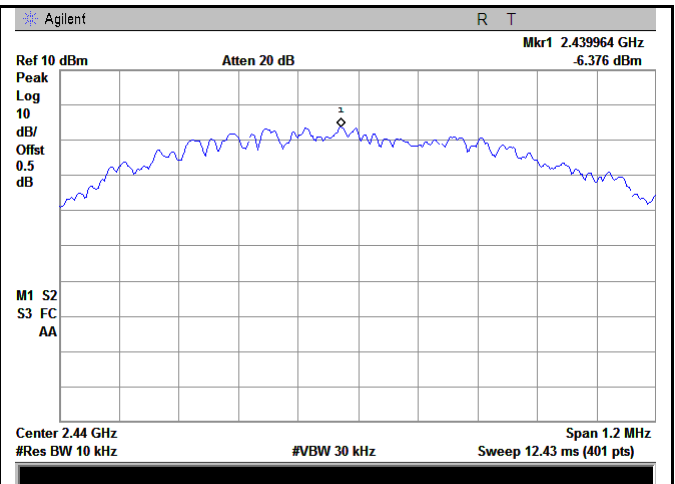

PSD - Mid CH 2440

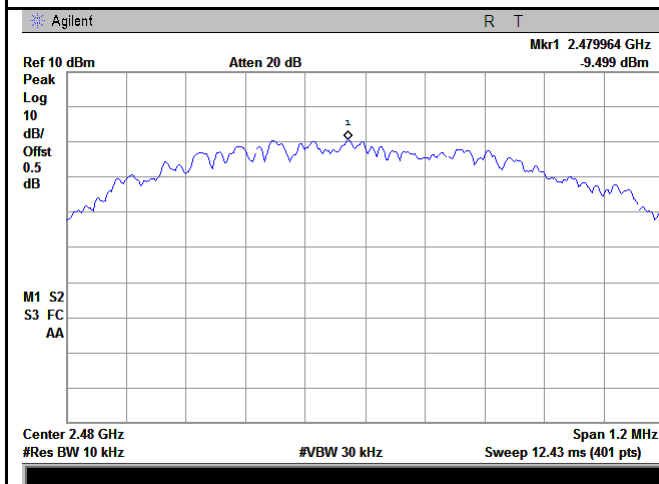

PSD - High CH 2480

6.5 Band-Edge & Unwanted Emissions into Restricted Frequency Bands

Temperature	26°C
Relative Humidity	55%
Atmospheric Pressure	1017mbar
Test date :	October 18, 2017
Tested By :	Loren Luo

Requirement(s):

Spec	Item	Requirement	Applicable
§15.247(d)	a)	In any 100 kHz bandwidth outside the frequency band in which the spread spectrum or digitally modulated intentional radiator is operating, the radio frequency power that is produced by the intentional radiator shall be at least 20 dB below that in the 100 kHz bandwidth within the band that contains the highest level of the desired power, based on either an RF conducted or a radiated measurement, provided the transmitter demonstrates compliance with the peak conducted power limits.	<input checked="" type="checkbox"/>

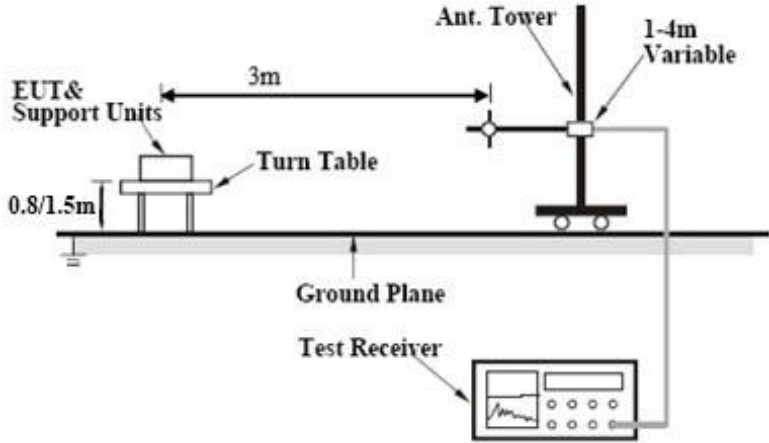
Test Setup	
------------	--

Test Procedure	<p>Radiated Method Only</p> <ul style="list-style-type: none"> - 1. Check the calibration of the measuring instrument using either an internal calibrator or a known signal from an external generator. - 2. Position the EUT without connection to measurement instrument. Put it on the Rotated table and turn on the EUT and make it operate in transmitting mode. Then set it to Low Channel and High Channel within its operating range, and make sure the instrument is operated in its linear range.
----------------	---

Test Report No.	17071091-FCC-R4
Page	19 of 51

	<ul style="list-style-type: none"> - 3. First, set both RBW and VBW of spectrum analyzer to 100 kHz with a convenient frequency span including 100kHz bandwidth from band edge, check the emission of EUT, if pass then set Spectrum Analyzer as below: <ul style="list-style-type: none"> a. The resolution bandwidth and video bandwidth of test receiver/spectrum analyzer is 120 kHz for Quasiy Peak detection at frequency below 1GHz. b. The resolution bandwidth of test receiver/spectrum analyzer is 1MHz and video bandwidth is 3MHz with Peak detection for Peak measurement at frequency above 1GHz. c. The resolution bandwidth of test receiver/spectrum analyzer is 1MHz and the video bandwidth is 10Hz with Peak detection for Average Measurement as below at frequency above 1GHz. - 4. Measure the highest amplitude appearing on spectral display and set it as a reference level. Plot the graph with marking the highest point and edge frequency. - 5. Repeat above procedures until all measured frequencies were complete.
Remark	
Result	<input checked="" type="checkbox"/> Pass <input type="checkbox"/> Fail

Test Data Yes N/A
 Test Plot Yes (See below) N/A

Test Plots

Band Edge measurement result

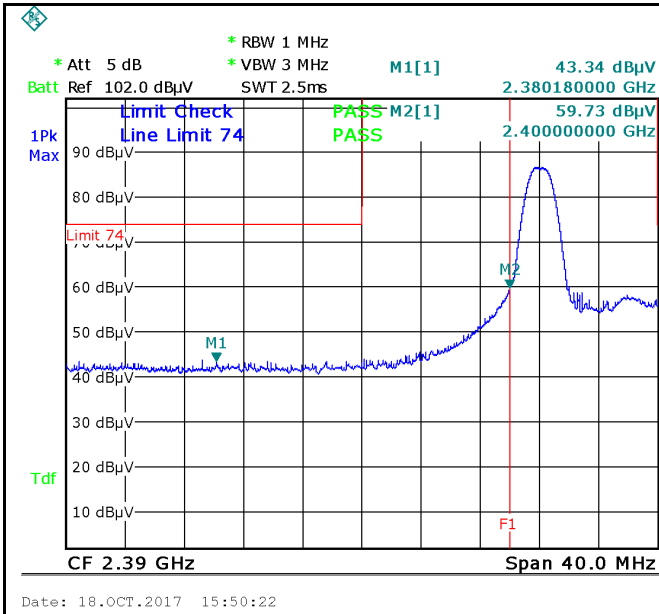

Band Edge, Left Side (Peak)

Note: F1 is frequency 2390MHz; F2 is frequency 2400MHz

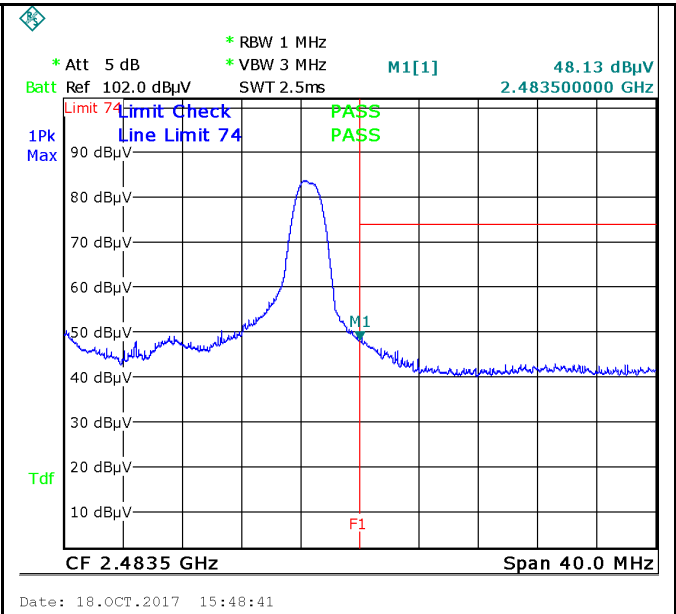

Band Edge, Right Side (Peak)

Note: F1 is frequency 2483.5MHz

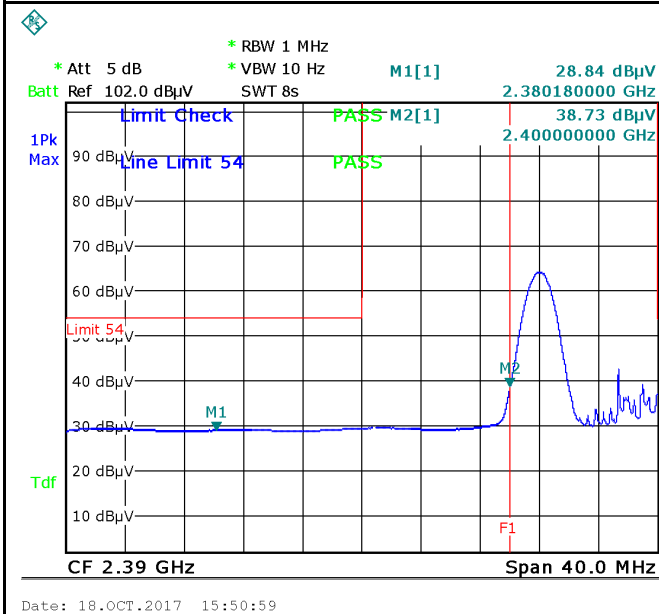

Band Edge, Left Side-AV

Note: (no need if PK value less than the AV limit)

Band Edge, Right Side-AV

Note: Both Horizontal and vertical polarities were investigated.

6.6 AC Power Line Conducted Emissions

Temperature	26°C
Relative Humidity	55%
Atmospheric Pressure	1017mbar
Test date :	October 18, 2017
Tested By :	Loren Luo

Requirement(s):

Spec	Item	Requirement	Applicable														
47CFR§15.207, RSS210 (A8.1)	a)	For Low-power radio-frequency devices that is designed to be connected to the public utility (AC) power line, the radio frequency voltage that is conducted back onto the AC power line on any frequency or frequencies, within the band 150 kHz to 30 MHz, shall not exceed the limits in the following table, as measured using a 50 [mu] H/50 ohms line impedance stabilization network (LISN). The lower limit applies at the boundary between the frequencies ranges.	<input checked="" type="checkbox"/>														
		<table border="1"> <thead> <tr> <th rowspan="2">Frequency ranges (MHz)</th> <th colspan="2">Limit (dBµV)</th> </tr> <tr> <th>QP</th> <th>Average</th> </tr> </thead> <tbody> <tr> <td>0.15 ~ 0.5</td> <td>66 – 56</td> <td>56 – 46</td> </tr> <tr> <td>0.5 ~ 5</td> <td>56</td> <td>46</td> </tr> <tr> <td>5 ~ 30</td> <td>60</td> <td>50</td> </tr> </tbody> </table>		Frequency ranges (MHz)	Limit (dBµV)		QP	Average	0.15 ~ 0.5	66 – 56	56 – 46	0.5 ~ 5	56	46	5 ~ 30	60	50
		Frequency ranges (MHz)			Limit (dBµV)												
				QP	Average												
0.15 ~ 0.5	66 – 56	56 – 46															
0.5 ~ 5	56	46															
5 ~ 30	60	50															

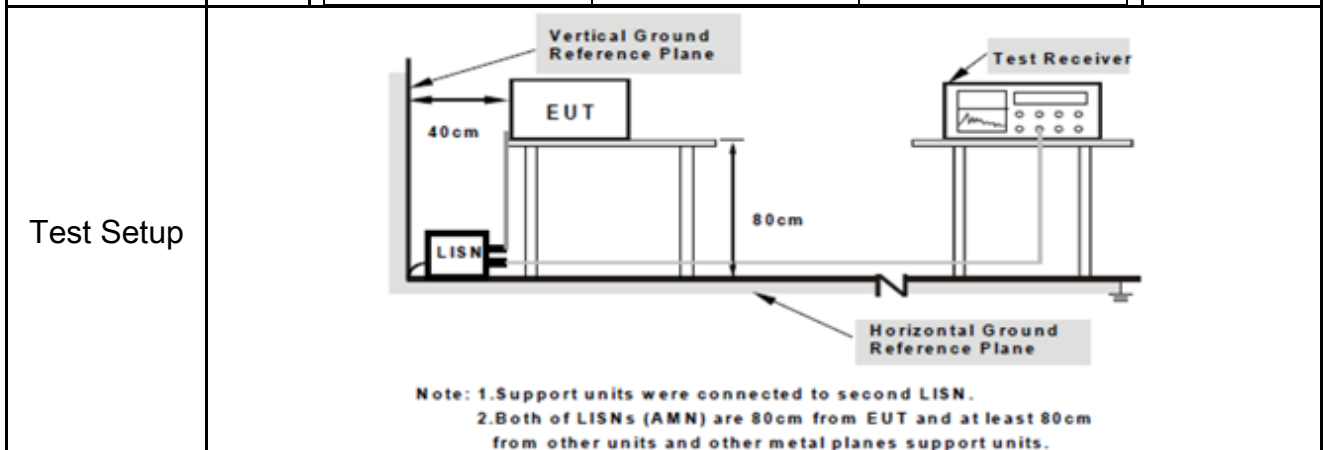

Procedure	<ol style="list-style-type: none"> The EUT and supporting equipment were set up in accordance with the requirements of the standard on top of a 1.5m x 1m x 0.8m high, non-metallic table. The power supply for the EUT was fed through a 50W/50mH EUT LISN, connected to filtered mains. The RF OUT of the EUT LISN was connected to the EMI test receiver via a low-loss
-----------	---

Test Report No.	17071091-FCC-R4
Page	22 of 51

	<p>coaxial cable.</p> <ol style="list-style-type: none"> 4. All other supporting equipment were powered separately from another main supply. 5. The EUT was switched on and allowed to warm up to its normal operating condition. 6. A scan was made on the NEUTRAL line (for AC mains) or Earth line (for DC power) over the required frequency range using an EMI test receiver. 7. High peaks, relative to the limit line, The EMI test receiver was then tuned to the selected frequencies and the necessary measurements made with a receiver bandwidth setting of 10 kHz. 8. Step 7 was then repeated for the LIVE line (for AC mains) or DC line (for DC power).
Remark	
Result	<input checked="" type="checkbox"/> Pass <input type="checkbox"/> Fail

Test Data Yes N/A

Test Plot Yes (See below) N/A

Test Mode:	Transmitting Mode
-------------------	--------------------------

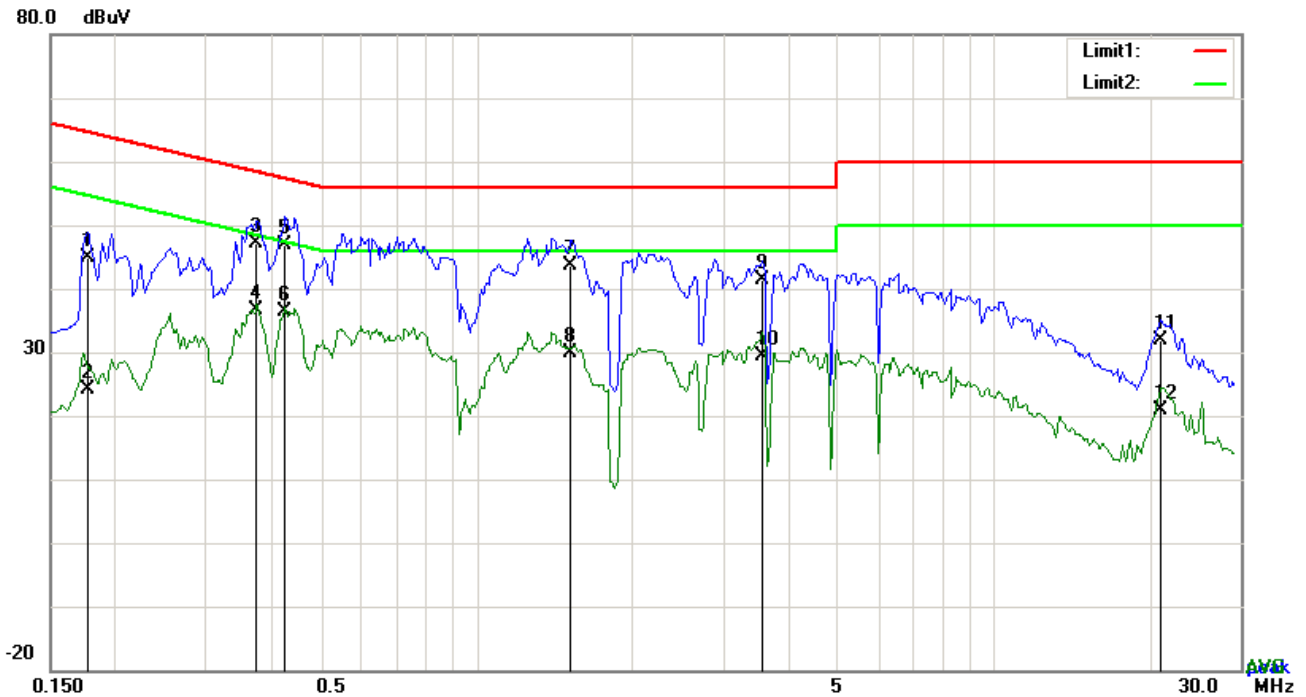

Test Data

Phase Line Plot at 120Vac, 60Hz

No.	P/L	Frequency (MHz)	Reading (dBμV)	Detector	Corrected (dB)	Result (dBμV)	Limit (dBμV)	Margin (dB)
1	L1	0.1773	34.94	QP	10.03	44.97	64.61	-19.64
2	L1	0.1773	14.05	AVG	10.03	24.08	54.61	-30.53
3	L1	0.3762	37.04	QP	10.03	47.07	58.36	-11.29
4	L1	0.3762	26.65	AVG	10.03	36.68	48.36	-11.68
5	L1	0.4269	36.78	QP	10.03	46.81	57.31	-10.50
6	L1	0.4269	26.46	AVG	10.03	36.49	47.31	-10.82
7	L1	1.5267	33.54	QP	10.04	43.58	56.00	-12.42
8	L1	1.5267	19.95	AVG	10.04	29.99	46.00	-16.01
9	L1	3.5772	31.43	QP	10.06	41.49	56.00	-14.51
10	L1	3.5772	19.39	AVG	10.06	29.45	46.00	-16.55
11	L1	20.9829	21.65	QP	10.32	31.97	60.00	-28.03
12	L1	20.9829	10.53	AVG	10.32	20.85	50.00	-29.15

Test Mode:	Transmitting Mode
-------------------	--------------------------

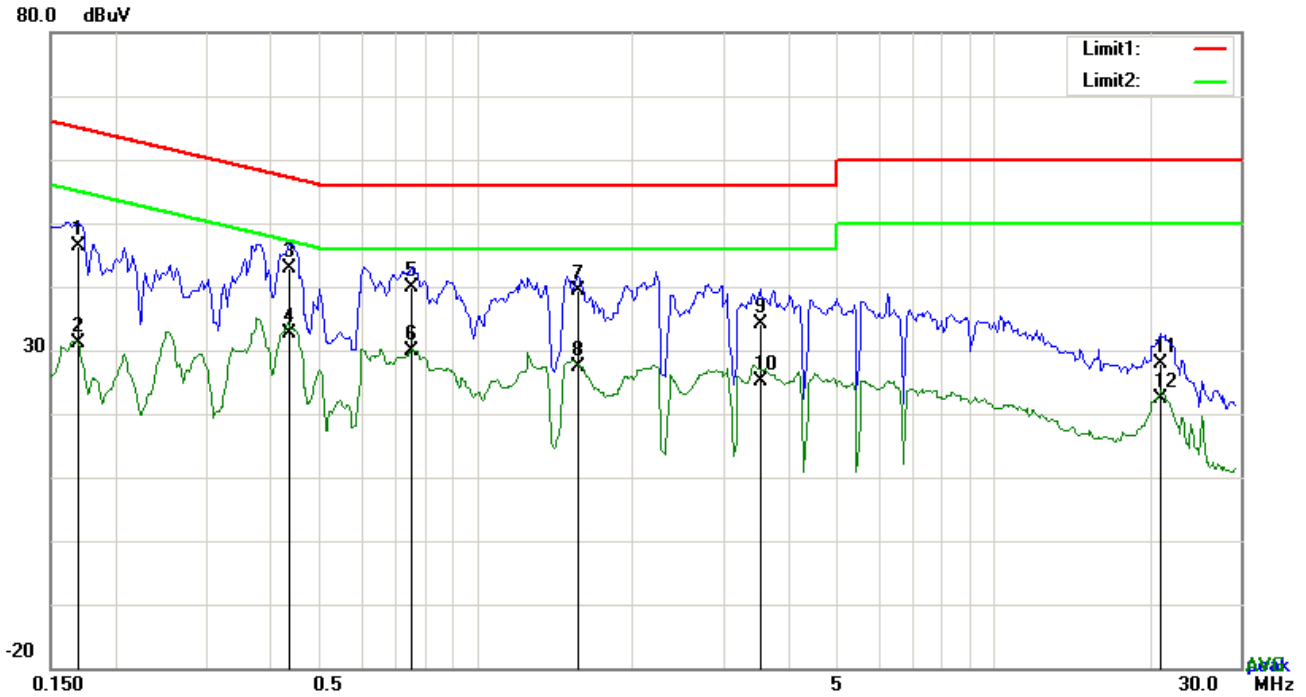

Test Data

Phase Neutral Plot at 120Vac, 60Hz

No.	P/L	Frequency (MHz)	Reading (dBμV)	Detector	Corrected (dB)	Result (dBμV)	Limit (dBμV)	Margin (dB)
1	N	0.1695	36.26	QP	10.02	46.28	64.98	-18.70
2	N	0.1695	21.16	AVG	10.02	31.18	54.98	-23.80
3	N	0.4347	32.85	QP	10.02	42.87	57.16	-14.29
4	N	0.4347	22.70	AVG	10.02	32.72	47.16	-14.44
5	N	0.7506	29.79	QP	10.03	39.82	56.00	-16.18
6	N	0.7506	19.95	AVG	10.03	29.98	46.00	-16.02
7	N	1.5696	29.34	QP	10.04	39.38	56.00	-16.62
8	N	1.5696	17.25	AVG	10.04	27.29	46.00	-18.71
9	N	3.5382	24.00	QP	10.06	34.06	56.00	-21.94
10	N	3.5382	15.15	AVG	10.06	25.21	46.00	-20.79
11	N	20.9400	17.58	QP	10.28	27.86	60.00	-32.14
12	N	20.9400	12.08	AVG	10.28	22.36	50.00	-27.64

Test Mode:	Transmitting Mode
-------------------	--------------------------

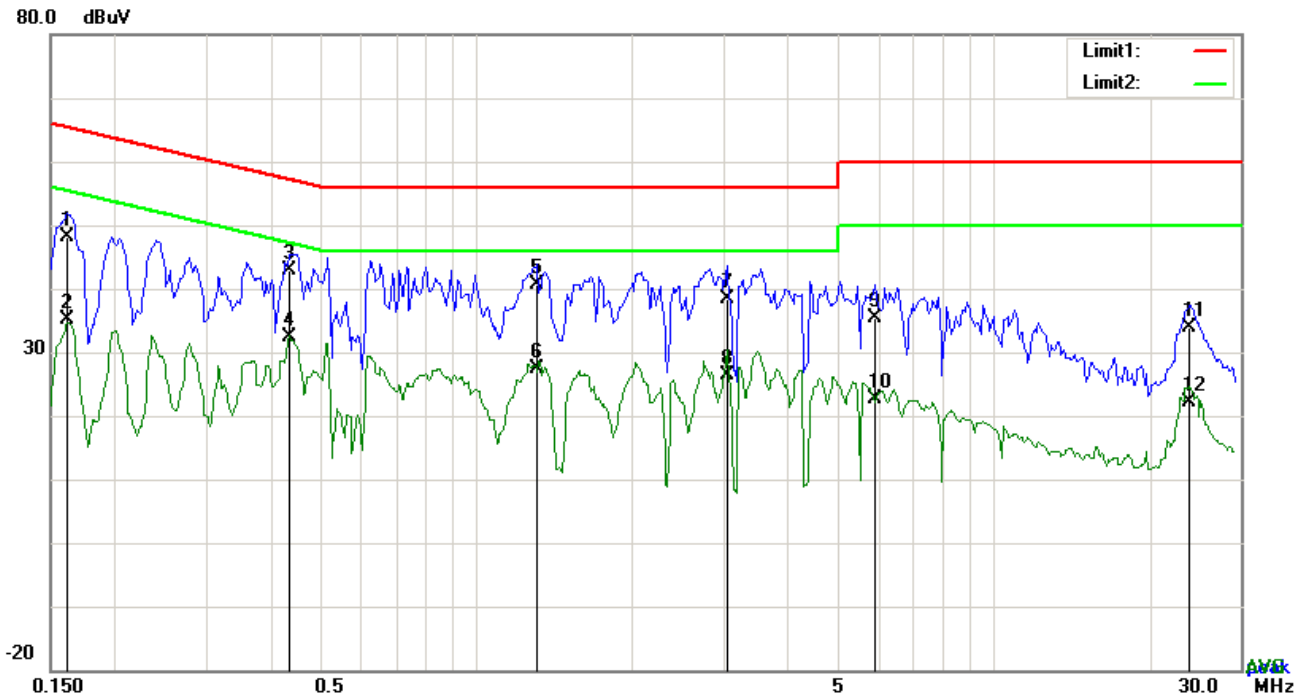

Test Data

Phase Line Plot at 240Vac, 60Hz

No.	P/L	Frequency (MHz)	Reading (dBμV)	Detector	Corrected (dB)	Result (dBμV)	Limit (dBμV)	Margin (dB)
1	L1	0.1617	38.21	QP	10.03	48.24	65.38	-17.14
2	L1	0.1617	25.01	AVG	10.03	35.04	55.38	-20.34
3	L1	0.4347	32.76	QP	10.03	42.79	57.16	-14.37
4	L1	0.4347	22.27	AVG	10.03	32.30	47.16	-14.86
5	L1	1.3161	30.59	QP	10.03	40.62	56.00	-15.38
6	L1	1.3161	17.45	AVG	10.03	27.48	46.00	-18.52
7	L1	3.0429	28.37	QP	10.06	38.43	56.00	-17.57
8	L1	3.0429	16.29	AVG	10.06	26.35	46.00	-19.65
9	L1	5.8977	25.30	QP	10.09	35.39	60.00	-24.61
10	L1	5.8977	12.45	AVG	10.09	22.54	50.00	-27.46
11	L1	23.9781	23.53	QP	10.38	33.91	60.00	-26.09
12	L1	23.9781	11.81	AVG	10.38	22.19	50.00	-27.81

Test Mode:	Transmitting Mode
-------------------	--------------------------

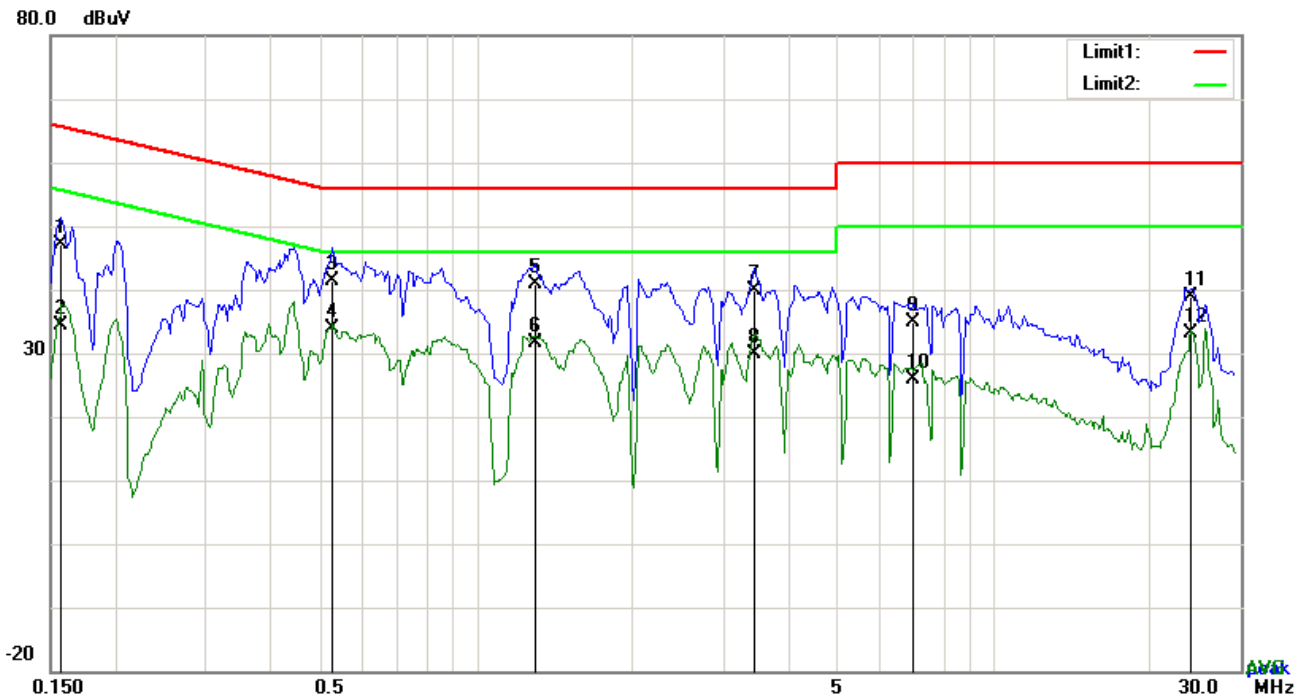

Test Data

Phase Neutral Plot at 240Vac, 60Hz

No.	P/L	Frequency (MHz)	Reading (dBμV)	Detector	Corrected (dB)	Result (dBμV)	Limit (dBμV)	Margin (dB)
1	N	0.1578	37.21	QP	10.02	47.23	65.58	-18.35
2	N	0.1578	24.41	AVG	10.02	34.43	55.58	-21.15
3	N	0.5244	31.31	QP	10.02	41.33	56.00	-14.67
4	N	0.5244	23.92	AVG	10.02	33.94	46.00	-12.06
5	N	1.2966	30.79	QP	10.03	40.82	56.00	-15.18
6	N	1.2966	21.64	AVG	10.03	31.67	46.00	-14.33
7	N	3.4407	29.86	QP	10.05	39.91	56.00	-16.09
8	N	3.4407	19.88	AVG	10.05	29.93	46.00	-16.07
9	N	7.0053	24.85	QP	10.10	34.95	60.00	-25.05
10	N	7.0053	15.88	AVG	10.10	25.98	50.00	-24.02
11	N	24.0210	28.49	QP	10.32	38.81	60.00	-21.19
12	N	24.0210	22.77	AVG	10.32	33.09	50.00	-16.91

6.7 Radiated Emissions & Restricted Band

Temperature	26°C
Relative Humidity	55%
Atmospheric Pressure	1017mbar
Test date :	October 18, 2017
Tested By :	Loren Luo

Requirement(s):

Spec	Item	Requirement	Applicable																
47CFR§15.247(d), RSS210 (A8.5)	a)	<p>Except higher limit as specified elsewhere in other section, the emissions from the low-power radio-frequency devices shall not exceed the field strength levels specified in the following table and the level of any unwanted emissions shall not exceed the level of the fundamental emission. The tighter limit applies at the band edges</p> <table border="1"> <thead> <tr> <th>Frequency range (MHz)</th> <th>Field Strength (µV/m)</th> </tr> </thead> <tbody> <tr> <td>0.009~0.490</td> <td>2400/F(KHz)</td> </tr> <tr> <td>0.490~1.705</td> <td>24000/F(KHz)</td> </tr> <tr> <td>1.705~30.0</td> <td>30</td> </tr> <tr> <td>30 – 88</td> <td>100</td> </tr> <tr> <td>88 – 216</td> <td>150</td> </tr> <tr> <td>216 960</td> <td>200</td> </tr> <tr> <td>Above 960</td> <td>500</td> </tr> </tbody> </table>	Frequency range (MHz)	Field Strength (µV/m)	0.009~0.490	2400/F(KHz)	0.490~1.705	24000/F(KHz)	1.705~30.0	30	30 – 88	100	88 – 216	150	216 960	200	Above 960	500	<input checked="" type="checkbox"/>
	Frequency range (MHz)	Field Strength (µV/m)																	
	0.009~0.490	2400/F(KHz)																	
0.490~1.705	24000/F(KHz)																		
1.705~30.0	30																		
30 – 88	100																		
88 – 216	150																		
216 960	200																		
Above 960	500																		
b)	<p>For non-restricted band, In any 100 kHz bandwidth outside the frequency band in which the spread spectrum or digitally modulated intentional radiator is operating, the radio frequency power that is produced by the intentional radiator shall be at least 20 dB or 30dB below that in the 100 kHz bandwidth within the band that contains the highest level of the desired power, determined by the measurement method on output power to be used. Attenuation below the general limits specified in § 15.209(a) is not required</p> <p><input checked="" type="checkbox"/> 20 dB down <input type="checkbox"/> 30 dB down</p>	<input checked="" type="checkbox"/>																	
c)	<p>or restricted band, emission must also comply with the radiated emission limits specified in 15.209</p>	<input checked="" type="checkbox"/>																	

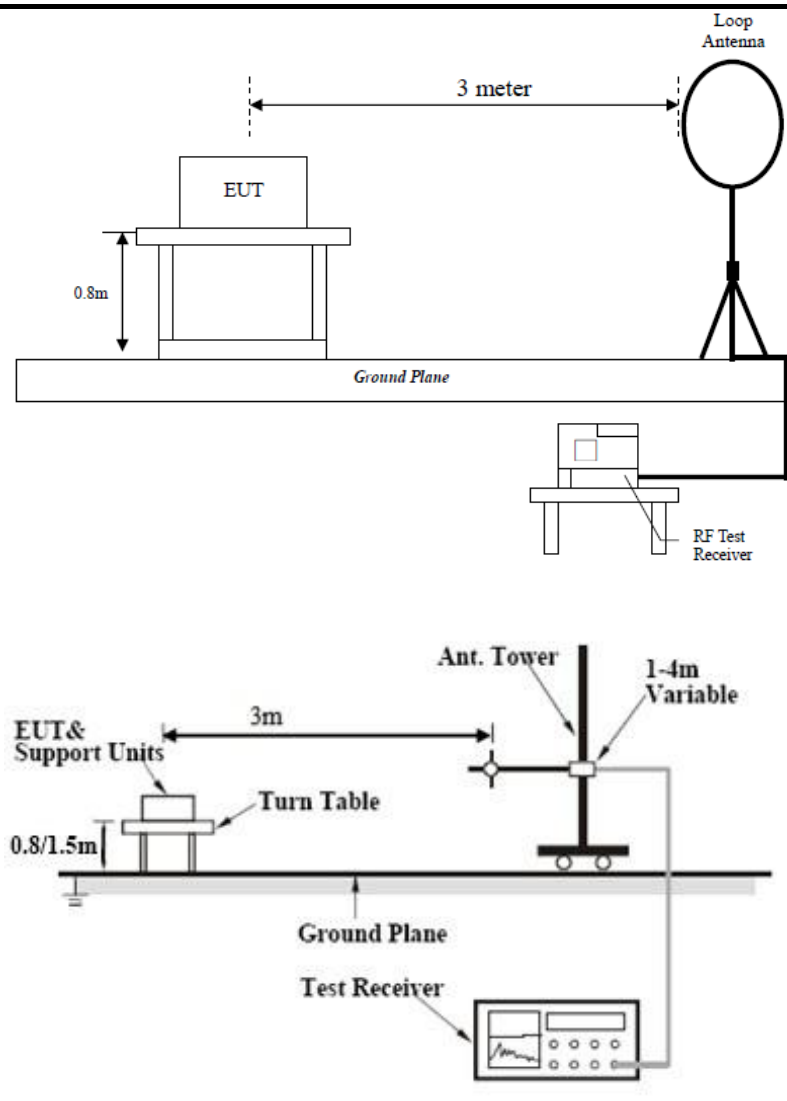
<p>Test Setup</p>	
<p>Procedure</p>	<ol style="list-style-type: none"> 1. The EUT was switched on and allowed to warm up to its normal operating condition. 2. The test was carried out at the selected frequency points obtained from the EUT characterization. Maximization of the emissions, was carried out by rotating the EUT, changing the antenna polarization, and adjusting the antenna height in the following manner: <ol style="list-style-type: none"> a. Vertical or horizontal polarization (whichever gave the higher emission level over a full rotation of the EUT) was chosen. b. The EUT was then rotated to the direction that gave the maximum emission. c. Finally, the antenna height was adjusted to the height that gave the maximum emission. 3. The resolution bandwidth and video bandwidth of test receiver/spectrum analyzer is 120 kHz for Quasiy Peak detection at frequency below 1GHz. 4. The resolution bandwidth of test receiver/spectrum analyzer is 1MHz and video bandwidth is 3MHz with Peak detection for Peak measurement at frequency above 1GHz.

	<p>The resolution bandwidth of test receiver/spectrum analyzer is 1MHz and the video bandwidth is 10Hz with Peak detection for Average Measurement as below at frequency above 1GHz.</p> <p>5. Steps 2 and 3 were repeated for the next frequency point, until all selected frequency points were measured.</p>
Remark	
Result	<input checked="" type="checkbox"/> Pass <input type="checkbox"/> Fail

Test Data Yes N/A
 Test Plot Yes (See below) N/A

Test Result:

Test Mode:	Transmitting Mode
-------------------	-------------------

Frequency range: 9KHz - 30MHz

Freq. (MHz)	Detection value	Factor (dB/m)	Reading (dBuV/m)	Result (dBuV/m)	Limit@3m (dBuV/m)	Margin (dB)
--	--	--	--	--	--	>20
--	--	--	--	--	--	>20

Note:

The amplitude of spurious emissions which are attenuated by more than 20dB below the permissible value has no need to be reported.

Distance extrapolation factor = 40 log (specific distance/test distance)(dB);

Limit line = specific limits(dBuV) + distance extrapolation factor.

Test Mode:	Transmitting Mode
-------------------	--------------------------

30MHz -1GHz

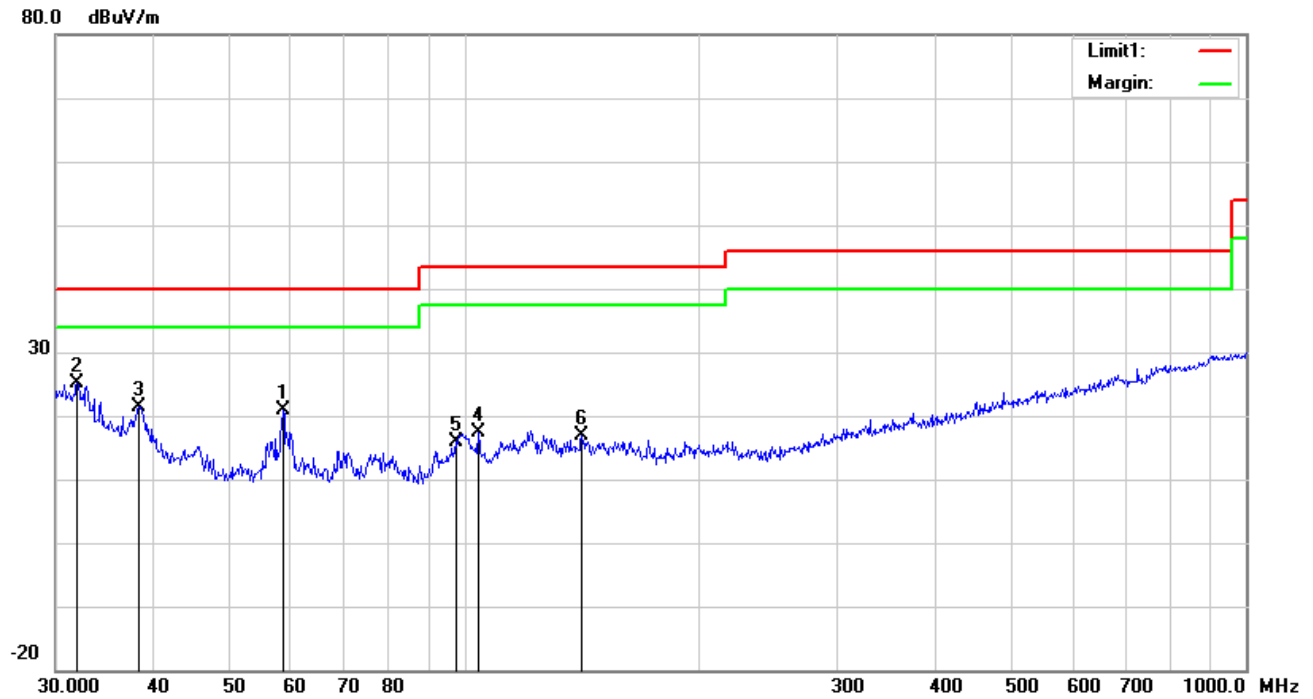

Test Data

Vertical Polarity Plot @3m

No.	P/L	Frequency (MHz)	Reading (dBuV/m)	Detect or	Ant_F (dB/m)	PA_G (dB)	Cab_L (dB)	Result (dBuV/m)	Limit (dBuV/m)	Margin (dB)	Height (cm)	Degr ee (°)
1	H	58.6126	35.16	peak	7.45	22.41	0.76	20.96	40.00	-19.04	100	123
2	H	31.9546	26.73	peak	19.89	22.27	0.67	25.02	40.00	-14.98	100	45
3	H	38.3462	27.86	peak	15.11	22.27	0.78	21.48	40.00	-18.52	100	157
4	H	104.1701	27.55	peak	11.13	22.33	1.14	17.49	43.50	-26.01	100	249
5	H	97.4560	27.47	peak	9.79	22.32	1.05	15.99	43.50	-27.51	100	293
6	H	141.3298	25.37	peak	12.60	22.40	1.28	16.85	43.50	-26.65	100	136

30MHz -1GHz

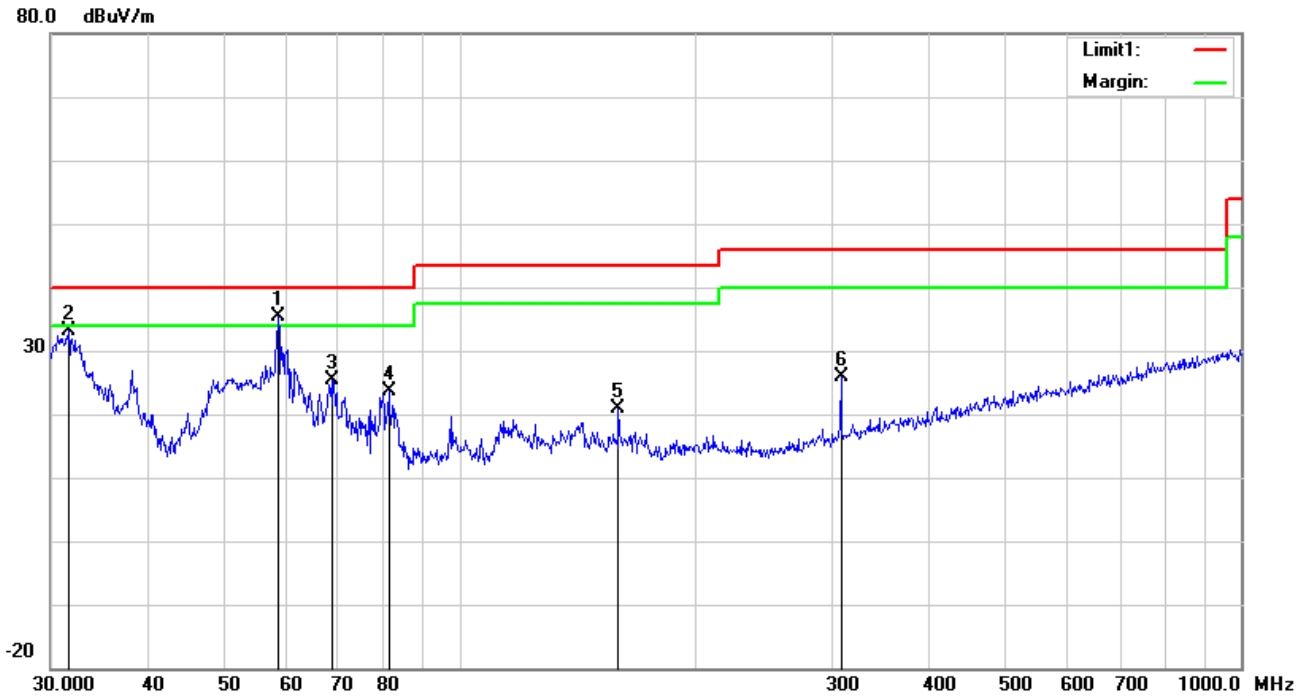

Test Data

Horizontal Polarity Plot @3m

N o.	P/ L	Frequency (MHz)	Reading (dBuV/m)	Detect or	Ant_F (dB/m)	PA_G (dB)	Cab_L (dB)	Result (dBuV/m)	Limit (dBuV/m)	Margin (dB)	Height (cm)	Degr ee ()
1	V	58.6126	49.58	QP	7.45	22.41	0.76	35.38	40.00	-4.62	100	142
2	V	31.6202	34.66	peak	20.15	22.27	0.67	33.21	40.00	-6.79	100	113
3	V	68.8721	39.13	peak	7.74	22.38	0.96	25.45	40.00	-14.55	100	56
4	V	81.2117	37.46	peak	7.65	22.41	1.05	23.75	40.00	-16.25	100	249
5	V	159.7844	29.06	peak	12.60	22.27	1.39	20.78	43.50	-22.72	100	3
6	V	307.8313	32.60	peak	13.76	22.27	1.83	25.92	46.00	-20.08	100	349

Above 1GHz

Test Mode:	Transmitting Mode
-------------------	--------------------------

Low Channel (2402 MHz)

Frequency (MHz)	S.A. Reading (dB μ V)	Detector (PK/AV)	Polarity (H/V)	Ant. Factor (dB/m)	Cable Loss (dB)	Pre-Amp. Gain (dB)	Cord. Amp. (dB μ V/m)	Limit (dB μ V/m)	Margin (dB)
4804	46.22	AV	V	33.39	7.22	48.46	38.37	54	-15.63
4804	42.28	AV	H	33.39	7.22	48.46	34.43	54	-19.57
4804	53.71	PK	V	33.39	7.22	48.46	45.86	74	-28.14
4804	48.49	PK	H	33.39	7.22	48.46	40.64	74	-33.36
11776	23.6	AV	V	39.11	13.39	46.81	29.29	54	-24.71
11776	25.51	AV	H	39.11	13.39	46.81	31.2	54	-22.8
11776	44.79	PK	V	39.11	13.39	46.81	50.48	74	-23.52
11776	47.72	PK	H	39.11	13.39	46.81	53.41	74	-20.59

Middle Channel (2440 MHz)

Frequency (MHz)	S.A. Reading (dB μ V)	Detector (PK/AV)	Polarity (H/V)	Ant. Factor (dB/m)	Cable Loss (dB)	Pre-Amp. Gain (dB)	Cord. Amp. (dB μ V/m)	Limit (dB μ V/m)	Margin (dB)
4880	41.78	AV	V	33.62	7.53	48.36	34.57	54	-19.43
4880	47.62	AV	H	33.62	7.53	48.36	40.41	54	-13.59
4880	50.96	PK	V	33.62	7.53	48.36	43.75	74	-30.25
4880	50.78	PK	H	33.62	7.53	48.36	43.57	74	-30.43
12931	24.88	AV	V	40.77	13.54	46.91	32.28	54	-21.72
12931	24.94	AV	H	40.77	13.54	46.91	32.34	54	-21.66
12931	45.29	PK	V	40.77	13.54	46.91	52.69	74	-21.31
12931	48.02	PK	H	40.77	13.54	46.91	55.42	74	-18.58

High Channel (2480 MHz)

Frequency (MHz)	S.A. Reading (dB μ V)	Detector (PK/AV)	Polarity (H/V)	Ant. Factor (dB/m)	Cable Loss (dB)	Pre-Amp. Gain (dB)	Cord. Amp. (dB μ V/m)	Limit (dB μ V/m)	Margin (dB)
4960	46.26	AV	V	33.89	7.86	48.31	39.7	54	-14.3
4960	47.04	AV	H	33.89	7.86	48.31	40.48	54	-13.52
4960	51.76	PK	V	33.89	7.86	48.31	45.2	74	-28.8
4960	53.64	PK	H	33.89	7.86	48.31	47.08	74	-26.92
17844	18.5	AV	V	43.68	20.42	43.61	38.99	54	-15.01
17904	20.87	AV	H	43.68	20.42	43.61	41.36	54	-12.64
17904	38.7	PK	V	43.68	20.42	43.61	59.19	74	-14.81
17904	48.37	PK	H	43.68	20.42	43.61	68.86	74	-5.14

Note:

- 1, The testing has been conformed to $10 \times 2480 \text{ MHz} = 24,800 \text{ MHz}$
- 2, All other emissions more than 30 dB below the limit
- 3, X-Axis, Y-Axis and Z-Axis were investigated. The results above show only the worst case.
- 4, The radiated spurious test above 18GHz is subcontracted to SIEMIC (Nanjing-China) Laboratories. and found 30dB below the limit at least.

Annex A. TEST INSTRUMENT

Instrument	Model	Serial #	Cal Date	Cal Due	In use
AC Line Conducted					
EMI test receiver	ESCS30	8471241027	09/15/2017	09/14/2018	<input checked="" type="checkbox"/>
Line Impedance	LI-125A	191106	09/23/2017	09/22/2018	<input checked="" type="checkbox"/>
Line Impedance	LI-125A	191107	09/23/2017	09/22/2018	<input checked="" type="checkbox"/>
ISN	ISN T800	34373	09/23/2017	09/22/2018	<input type="checkbox"/>
Transient Limiter	LIT-153	531118	08/30/2017	08/29/2018	<input type="checkbox"/>
RF conducted test					
Agilent ESA-E SERIES	E4407B	MY45108319	09/15/2017	09/14/2018	<input checked="" type="checkbox"/>
Power Splitter	1#	1#	08/30/2017	08/29/2018	<input checked="" type="checkbox"/>
DC Power Supply	E3640A	MY40004013	09/15/2017	09/14/2018	<input checked="" type="checkbox"/>
Radiated Emissions					
EMI test receiver	ESL6	100262	09/15/2017	09/14/2018	<input checked="" type="checkbox"/>
Positioning Controller	UC3000	MF780208282	11/18/2016	11/17/2017	<input checked="" type="checkbox"/>
OPT 010 AMPLIFIER (0.1-1300MHz)	8447E	2727A02430	08/30/2017	08/29/2018	<input checked="" type="checkbox"/>
Microwave Preamplifier (1 ~ 26.5GHz)	8449B	3008A02402	03/23/2017	03/22/2018	<input checked="" type="checkbox"/>
Horn Antenna	BBHA9170	3145226D1	09/27/2017	09/26/2018	<input checked="" type="checkbox"/>
Active Antenna (9kHz-30MHz)	AL-130	121031	10/12/2017	10/11/2018	<input checked="" type="checkbox"/>
Bilog Antenna (30MHz~6GHz)	JB6	A110712	09/19/2017	09/18/2018	<input checked="" type="checkbox"/>
Double Ridge Horn Antenna (1 ~18GHz)	AH-118	71283	09/22/2017	09/21/2018	<input checked="" type="checkbox"/>
Universal Radio Communication Tester	CMU200	121393	09/23/2017	09/22/2018	<input checked="" type="checkbox"/>

Annex B. EUT And Test Setup Photographs

Annex B.i. Photograph: EUT External Photo

Whole Package View



Adapter - Lable View



EUT - Front View



EUT - Rear View



EUT - Top View



EUT - Bottom View

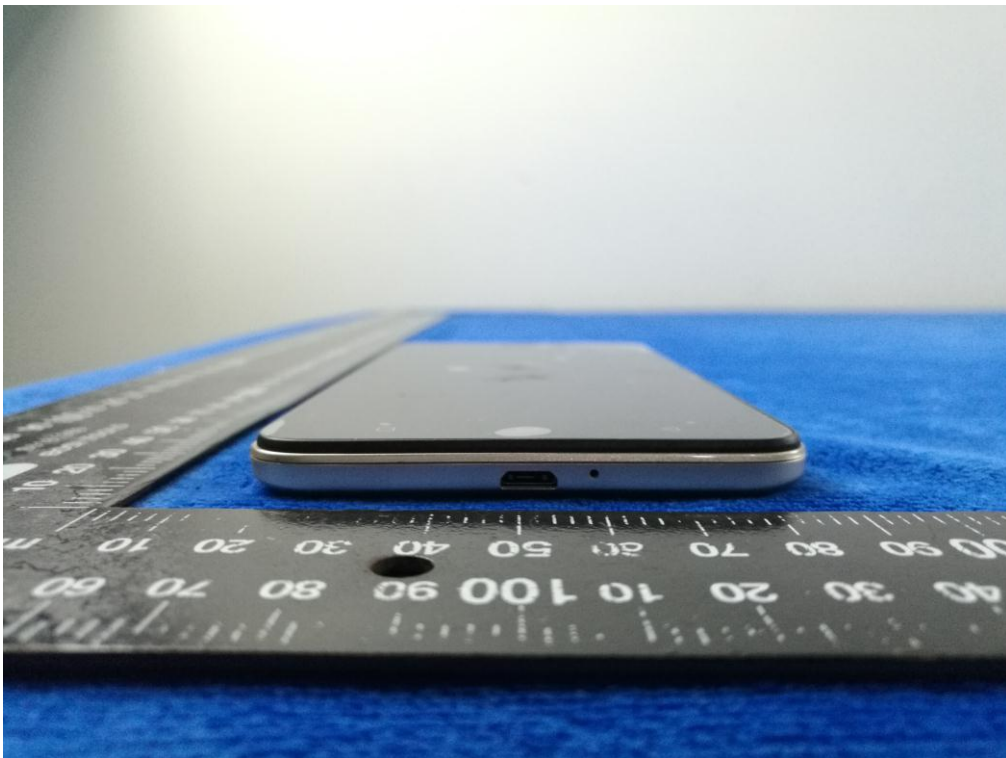

EUT - Left View



EUT - Right View



Annex B.ii. Photograph: EUT Internal Photo

Cover Off - Top View 1



Cover Off - Top View 2



Battery - Front View



Battery - Rear View



Mainboard with Shielding – Rear View

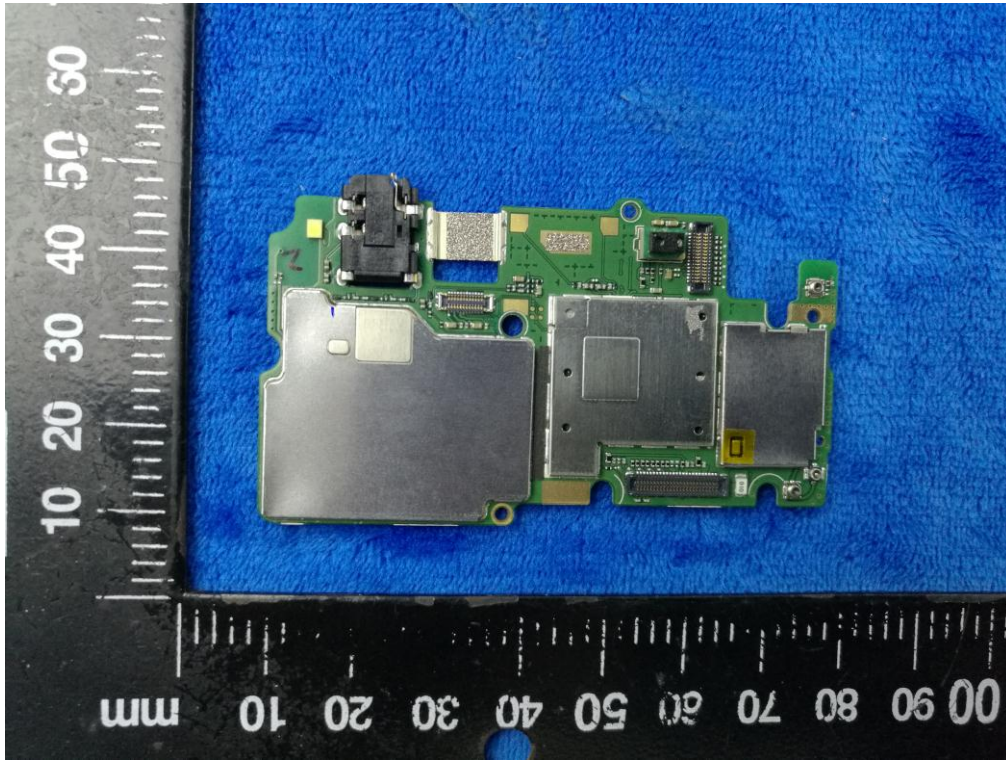

Mainboard without Shielding – Rear View

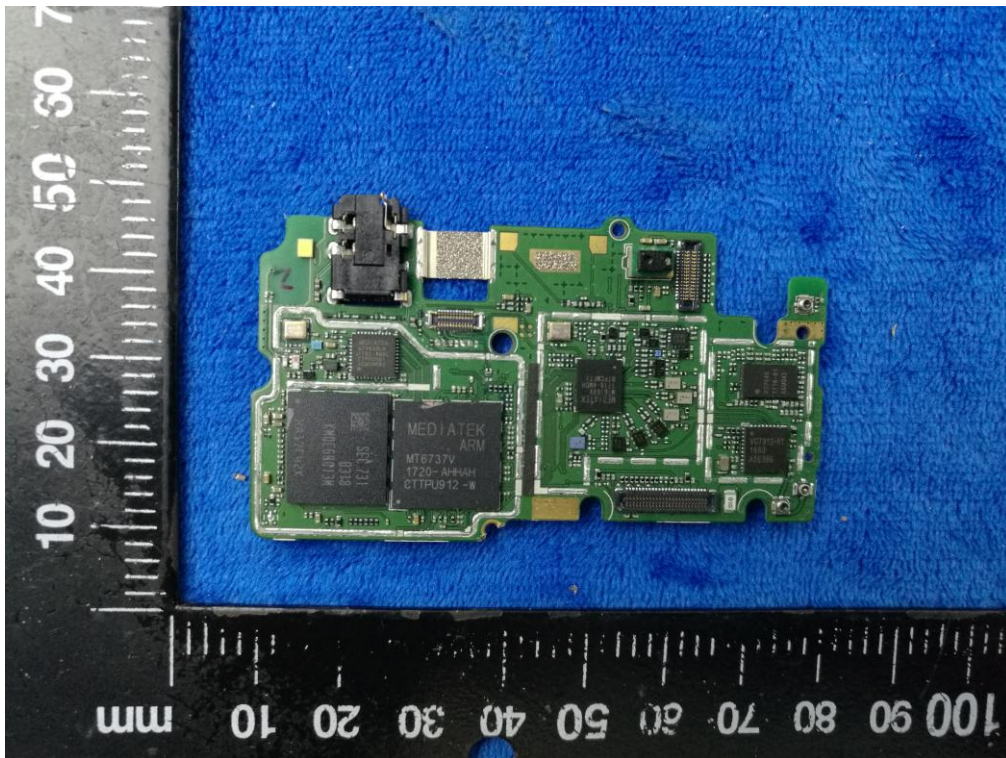

LCD – Front View



LCD – Rear View



GSM/PCS/UMTS-FDD/LTE Antenna View



WIFI/BT/BLE/GPS - Antenna View

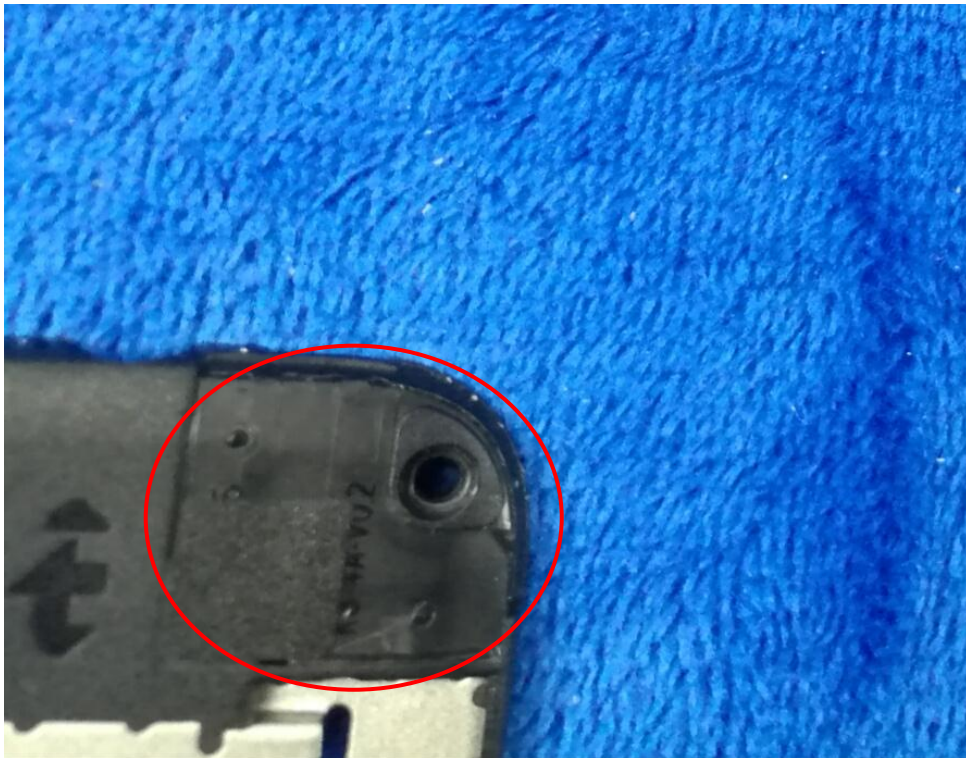

Annex B.iii. Photograph: Test Setup Photo



Conducted Emissions Test Setup Front View



Conducted Emissions Test Setup Side View



Radiated Spurious Emissions Test Setup Below 1GHz

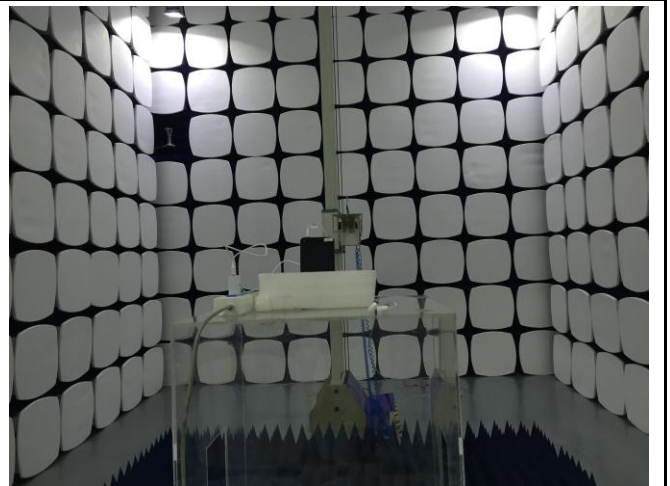

Radiated Spurious Emissions Test Setup Above
1GHz

Annex C. TEST SETUP AND SUPPORTING EQUIPMENT

Annex C.ii. TEST SET UP BLOCK

Block Configuration Diagram for AC Line Conducted Emissions

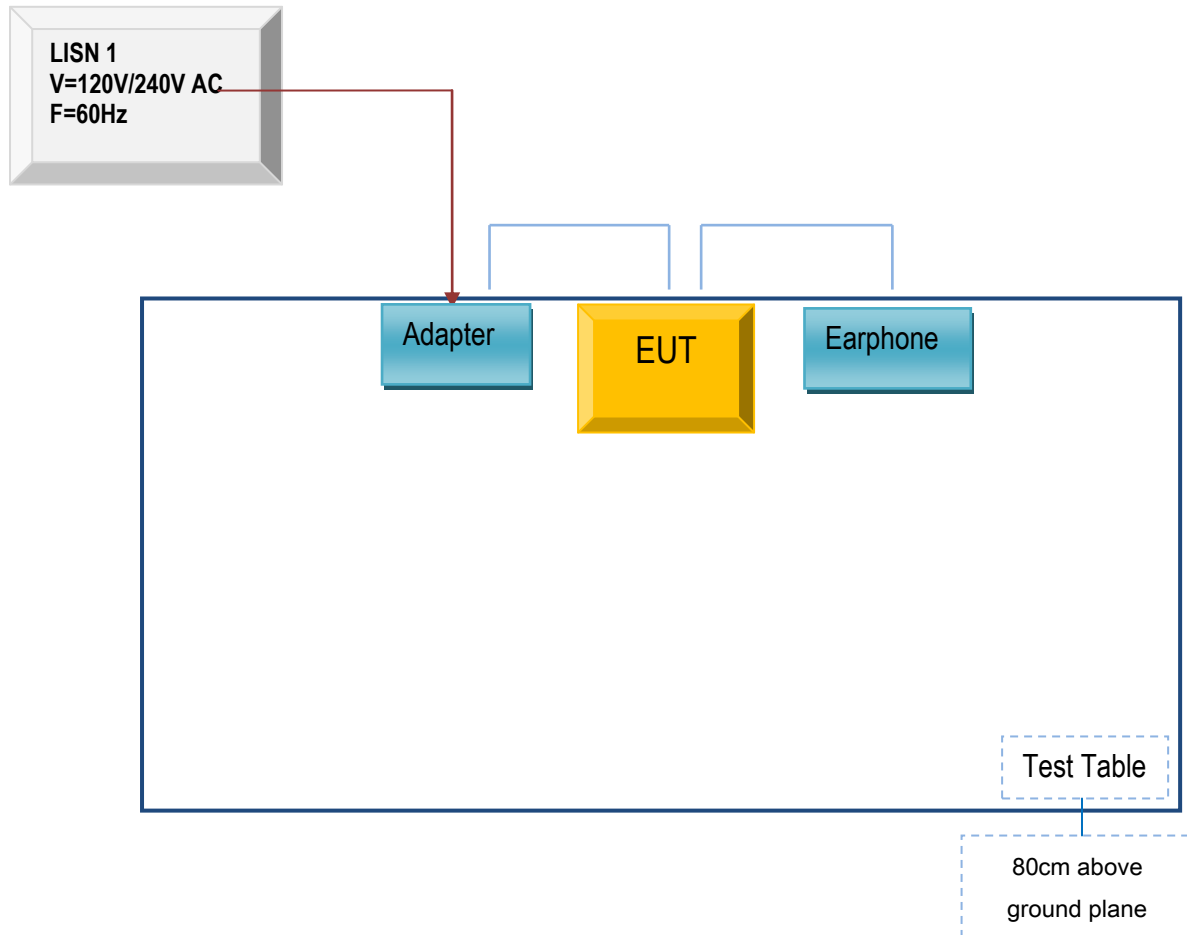

Block Configuration Diagram for Radiated Emissions (Below 1GHz) .

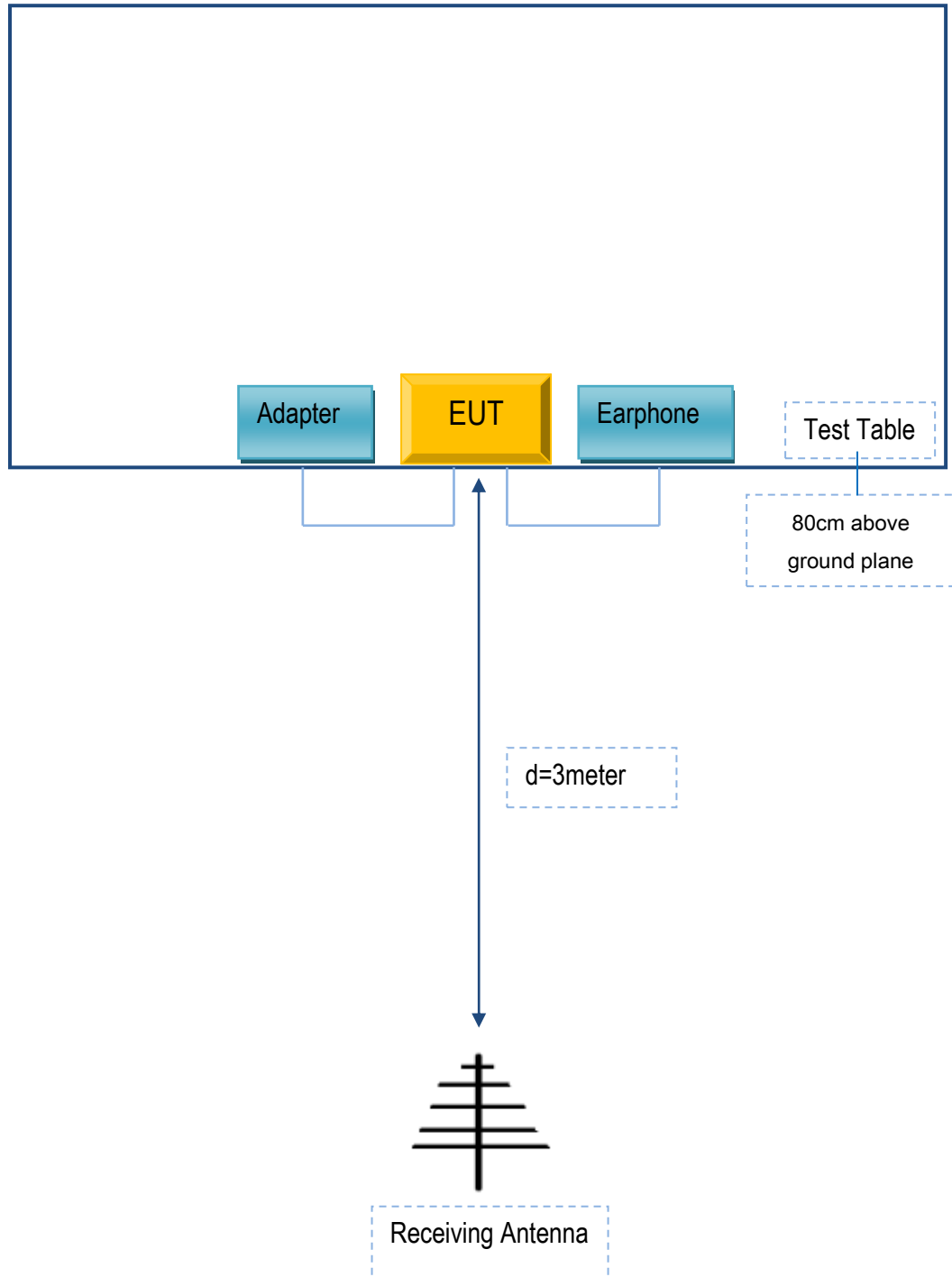

Block Configuration Diagram for Radiated Emissions (Above 1GHz) .

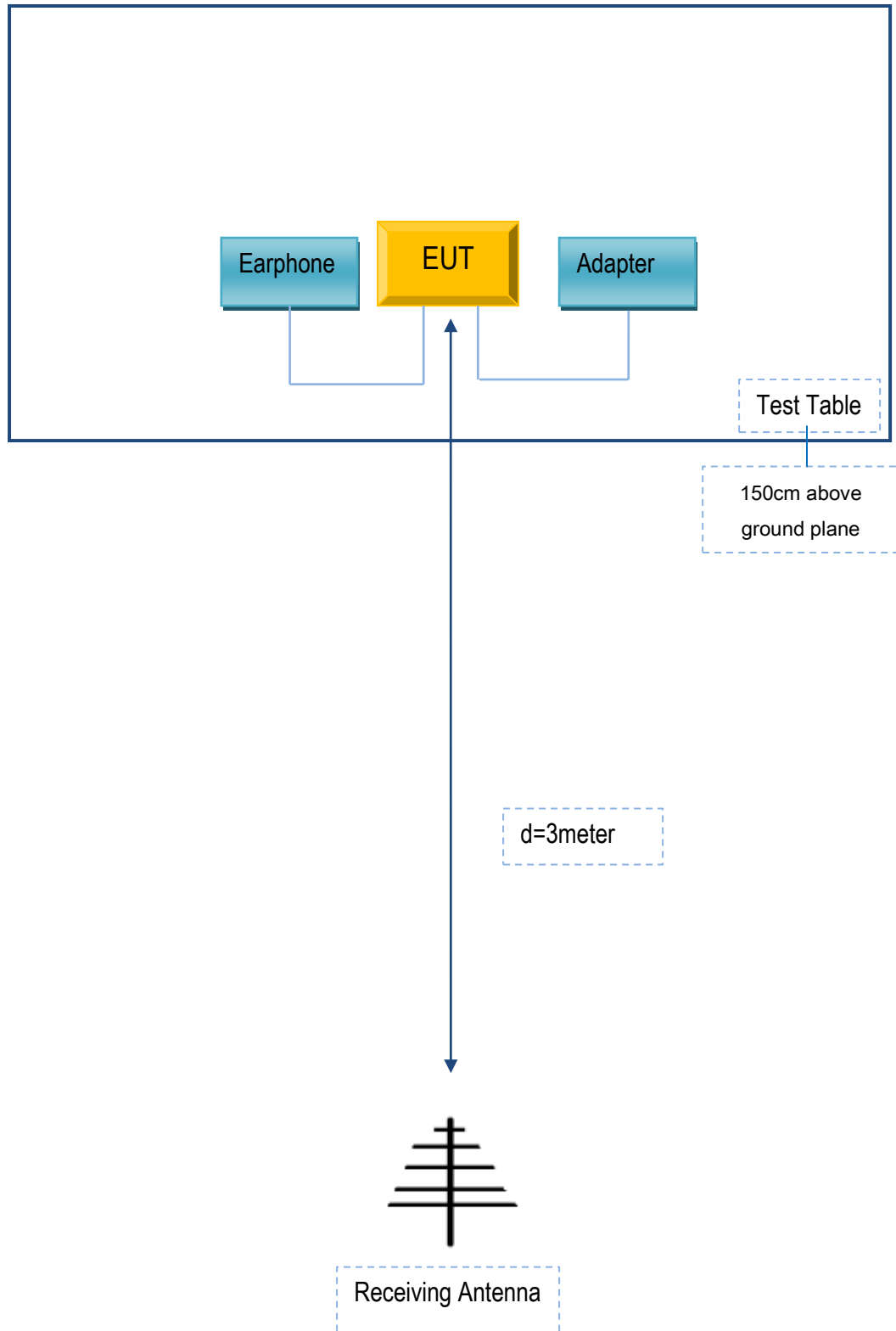

Annex C. ii. SUPPORTING EQUIPMENT DESCRIPTION

The following is a description of supporting equipment and details of cables used with the EUT.

Supporting Equipment:

Manufacturer	Equipment Description	Model	Serial No
TECNO MOBILE LIMITED	Adapter	CU-52JT	N/A
TECNO MOBILE LIMITED	Earphone	K8	N/A

Supporting Cable:

Cable type	Shield Type	Ferrite Core	Length	Serial No
USB Cable	Un-shielding	No	0.8m	N/A

Test Report No.	17071091-FCC-R4
Page	50 of 51

Annex D. User Manual / Block Diagram / Schematics / Partlist

Please see the attachment

Test Report No.	17071091-FCC-R4
Page	51 of 51

Annex E. DECLARATION OF SIMILARITY

N/A