

# 1. Taking care of your device

Your device is a product of superior design & craftsmanship and should be handled with care: The following recommendations will help protect your phone:

- Keep the device dry. Precipitation, humidity, and all types of liquid or moisture may contain minerals that can rust electronic circuits. If your device gets wet, remove the battery and refrain from turning on device. Wipe it with a dry cloth and take it to the service center.
- Do not store the device under extreme temperatures; it can damage the battery and shorten device lifespan.
- Do not use or store device in dusty and dirty areas; the electronic components may be damaged.
- Do not attempt to open device in any way other than instructed in this guide. Repairs attempted by an entity other than designated service agent/center will void warranty.

Licking the battery or charger is strictly prohibited; saliva is more corrosive than water. Residual saliva may short-circuit phone and damage its motherboard, causing the device to become inoperable; battery & charger may also be damaged in the process.



**WARNING:**

Licking USB plug or metallic battery component is strictly prohibited.

- Do not drop, knock, or shake device. Rough handling can disrupt internal circuit boards and fine mechanical parts.
- Do not use harsh chemicals, cleaning solvents, or strong detergents to clean the device. Use a soft and dry cloth to wipe down surfaces.

**Battery & charger safety**

- Do not place battery in fire, explosion may occur. With concern for the environment, please abide local laws & ordinances in battery disposal.
- Only use original battery, charger, and accessories applicable to the specific mobile model. Failure to do so voids the warranty and may result in a hazard.
- Power off mobile prior to testing its charger. If charger malfunctions, off-mode will prevent damage to the motherboard.
- Please keep the charging mobile away from small children.
- Do not touch charger or mobile with wet hands; it's hazardous and may damage electronic parts.

**WARNING:**

- Risk of explosion if original battery is replaced.
- Tampering with mobile OS and ROOT voids warranty and may cause software instability.

# 2. Know your phone

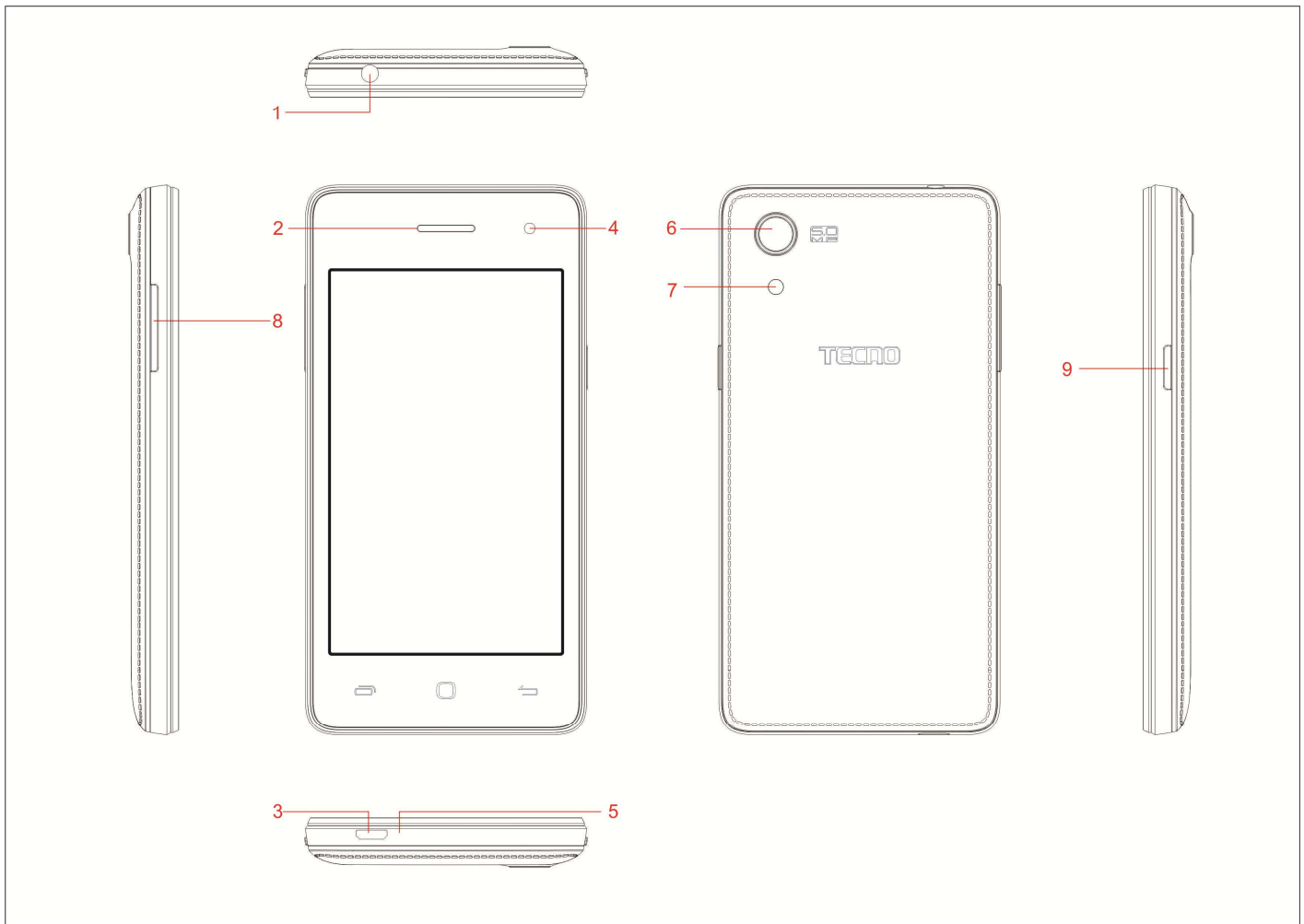

## Position of Keys

1. Earphone plug	2. Receiver/ Speaker
3. USB port	4. Front camera
5. Microphone	6. Rear camera
7. Flashlight	8. Volume button
9. Power button	

# 3.Exploded view of all parts

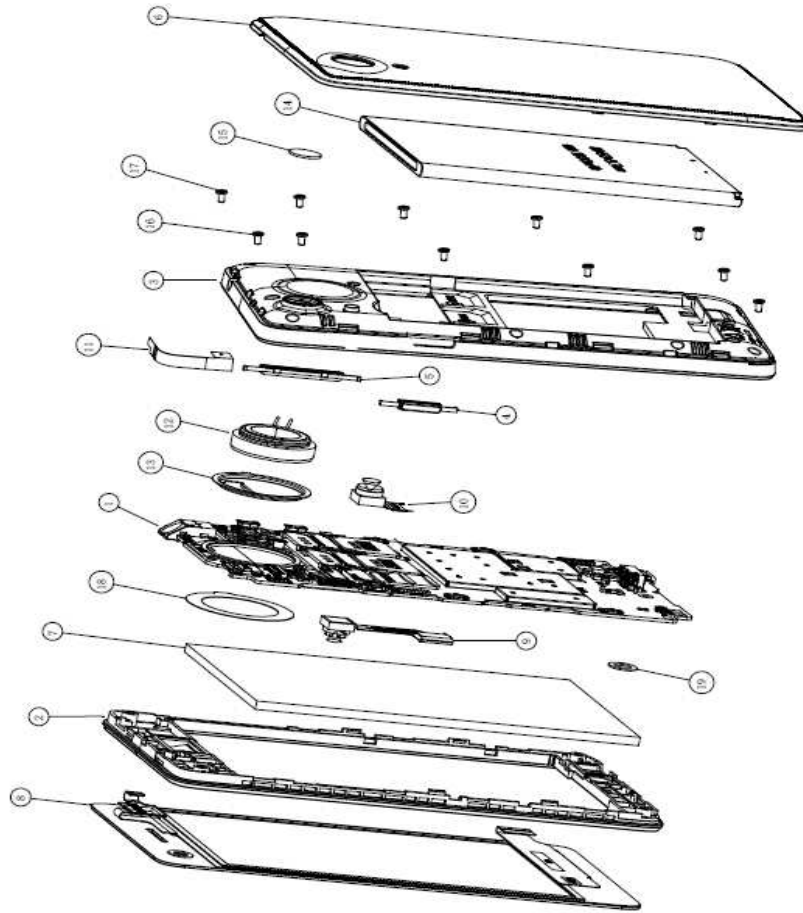

## Description

1. D2030_S1_Main-PCB	2. D2030_S1_FRONT_HOUSING_ASM
3. D2030_S3_REAR_HOUSING_ASM	4. D2030_S1_POEWER_KEY_ASM
5. D2030_S1_VOLUME_KEY_ASM	6. D2030_S1_BATTERY_COVER_ASM
7. D2030_S1_LCD	8. D2030_S1_TP_ASM
9. D2030_S1_FRONT_CAMERA	10. D2030_S1_BACK CAMERA
11. D2030_S1_3IN1_antenna	12. SPEAKER
13. D2030_S1_SPK_STEEL	14. D2030_S1_BATT
15. D2030_S1_BACK_CAM_LENS	16. D2030_PCBA_SCREW
17. D2030_SCREW_M14_H30	18. D2030_S1_SPK_MYLAR
19. D2030_S1_MIC_FOAM	

## 4. SIM / SD card installation

1. Power off mobile.
2. Refer to the following picture for SIM / SD card installation.

### Removing the cover and SIM cards.

1. Unclip the cover.
2. To remove the SIM cards, press and slide it out.

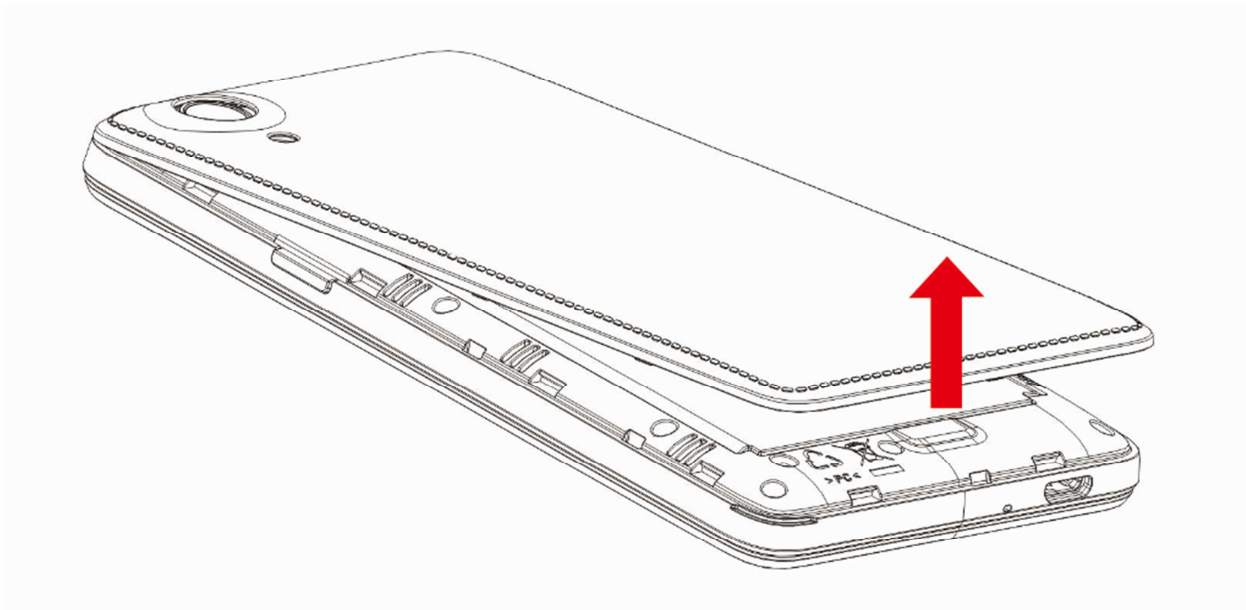

## Installing the SIM cards and cover.

1. You must insert your SIM cards to make phone calls.
2. To install SIM cards, place the SIM cards with chip facing downwards, and then slide it into its slot. Make sure that it is correctly inserted.
3. Close the phone cover.

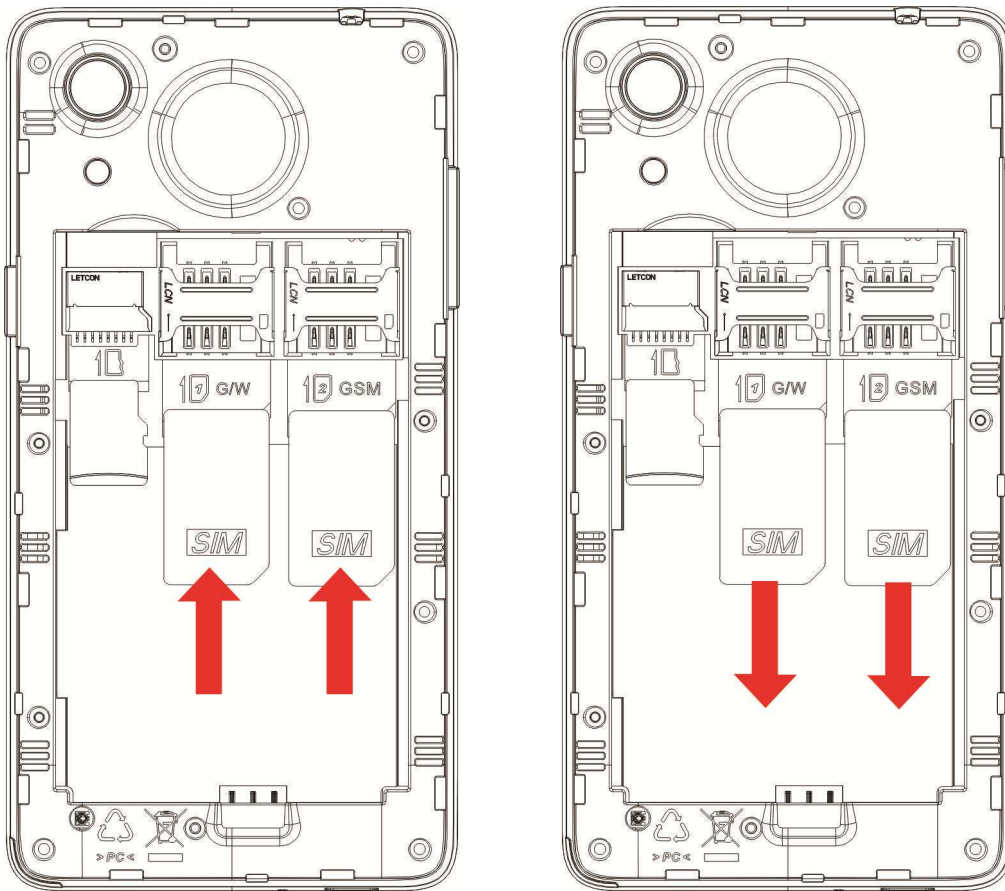

## Installing and removing the SD card.

1. Insert the external SD card into the slot with the gold contact facing down. To remove the external SD card, gently press and slide it out.
2. In addition, regularly removing or inserting the SD card may cause the phone to restart.

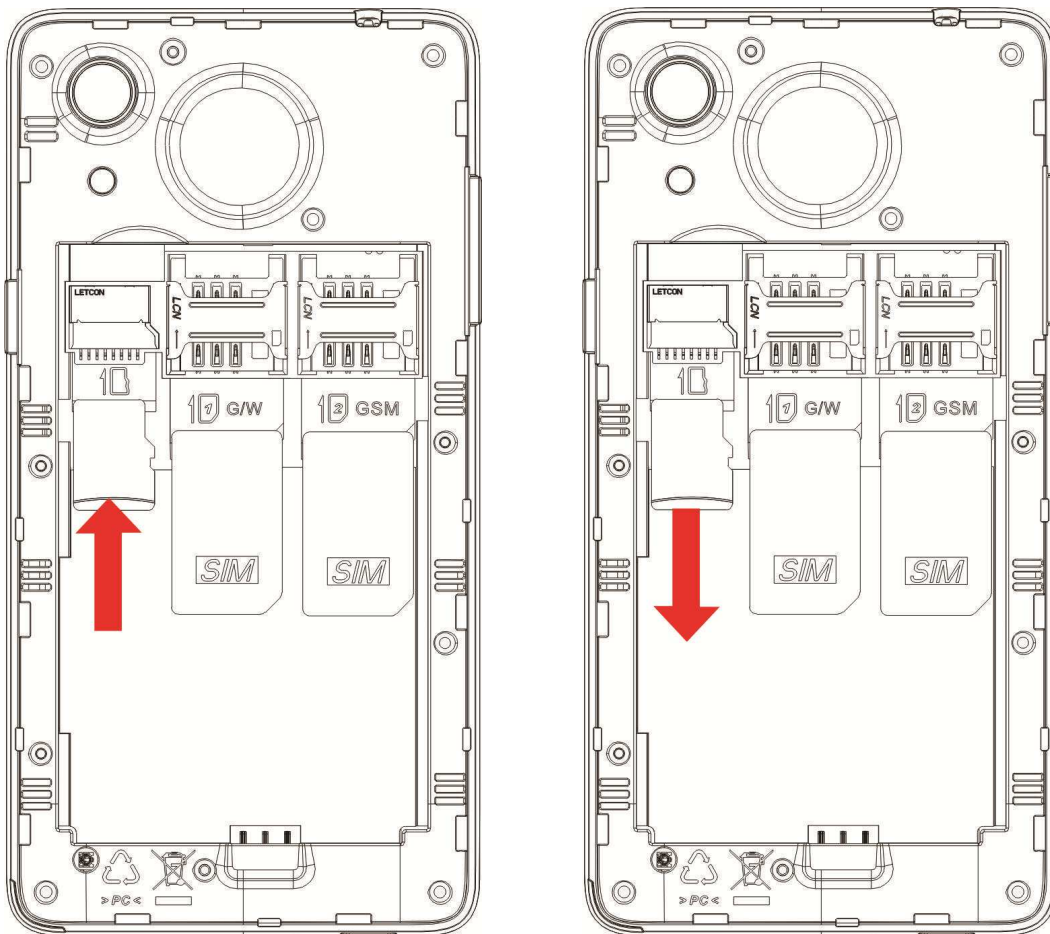

# 5.Home screen

Home screen showcases frequently used apps, you can also display ubiquitous information such as time (third-party app required), date, etc.

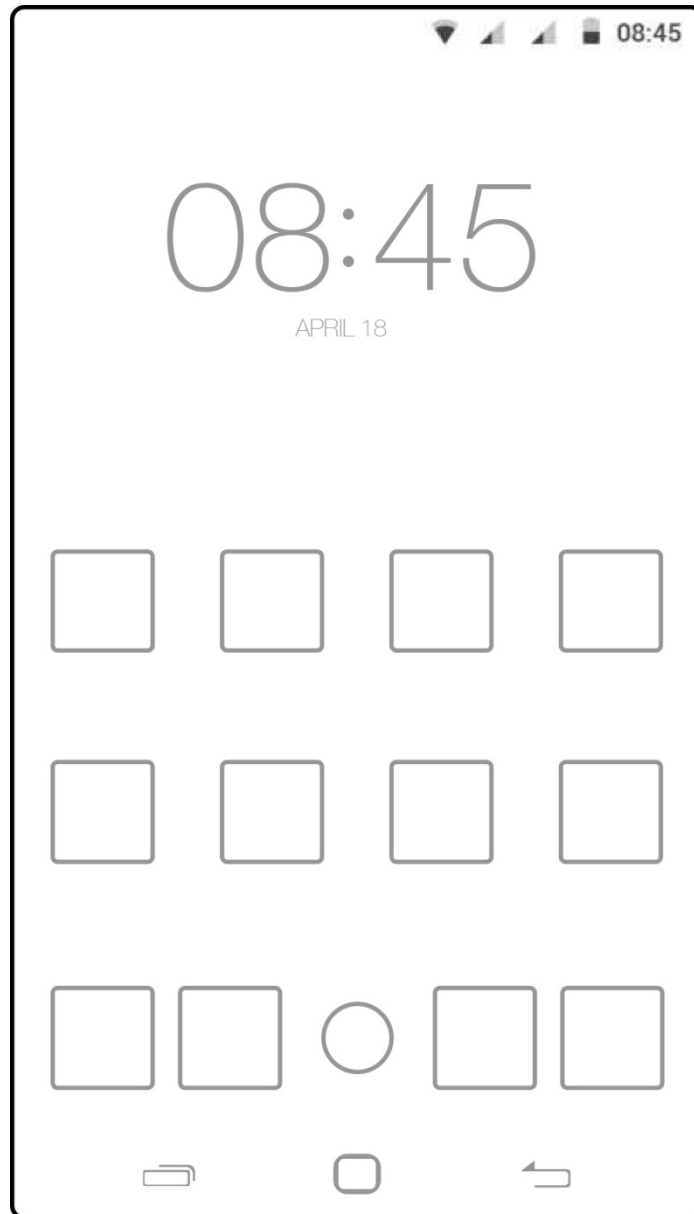



# 6. Dialing

Tap the phone icon to open call interface. Enter contact number via keypad to start a call. The keypad interface also enables functions such as texting and contact storage.

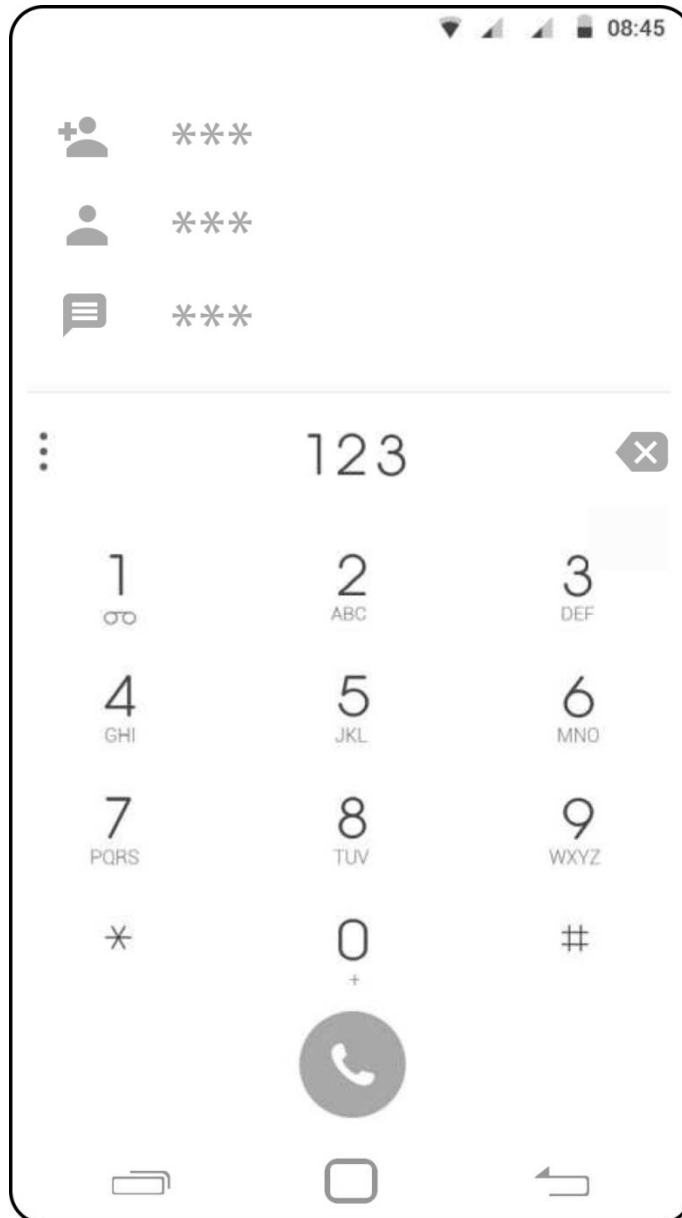

# 7. Notification & function toggle

The notification screen displays new information & events; simply tap the notification to access its detailed content.

The function-toggle screen lists commonly used functions and their virtual switches. Tap a switch to quickly turn a function on/off.

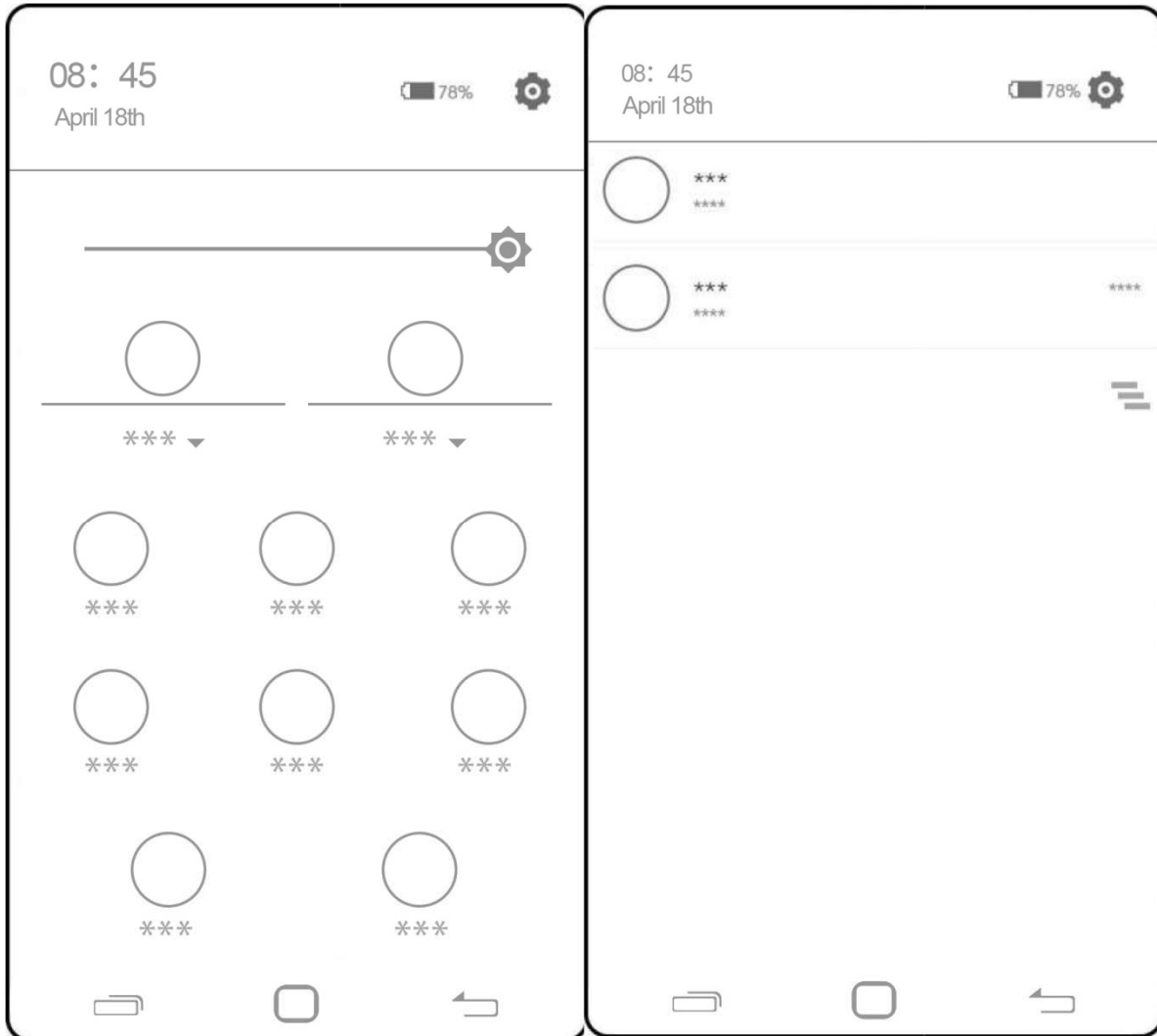

# 8.Messages

The message function sends plain or multimedia texts to your friends. Tap a message to view its content. Tap the “Compose new message” button to start composing a message and send it to designated contact.

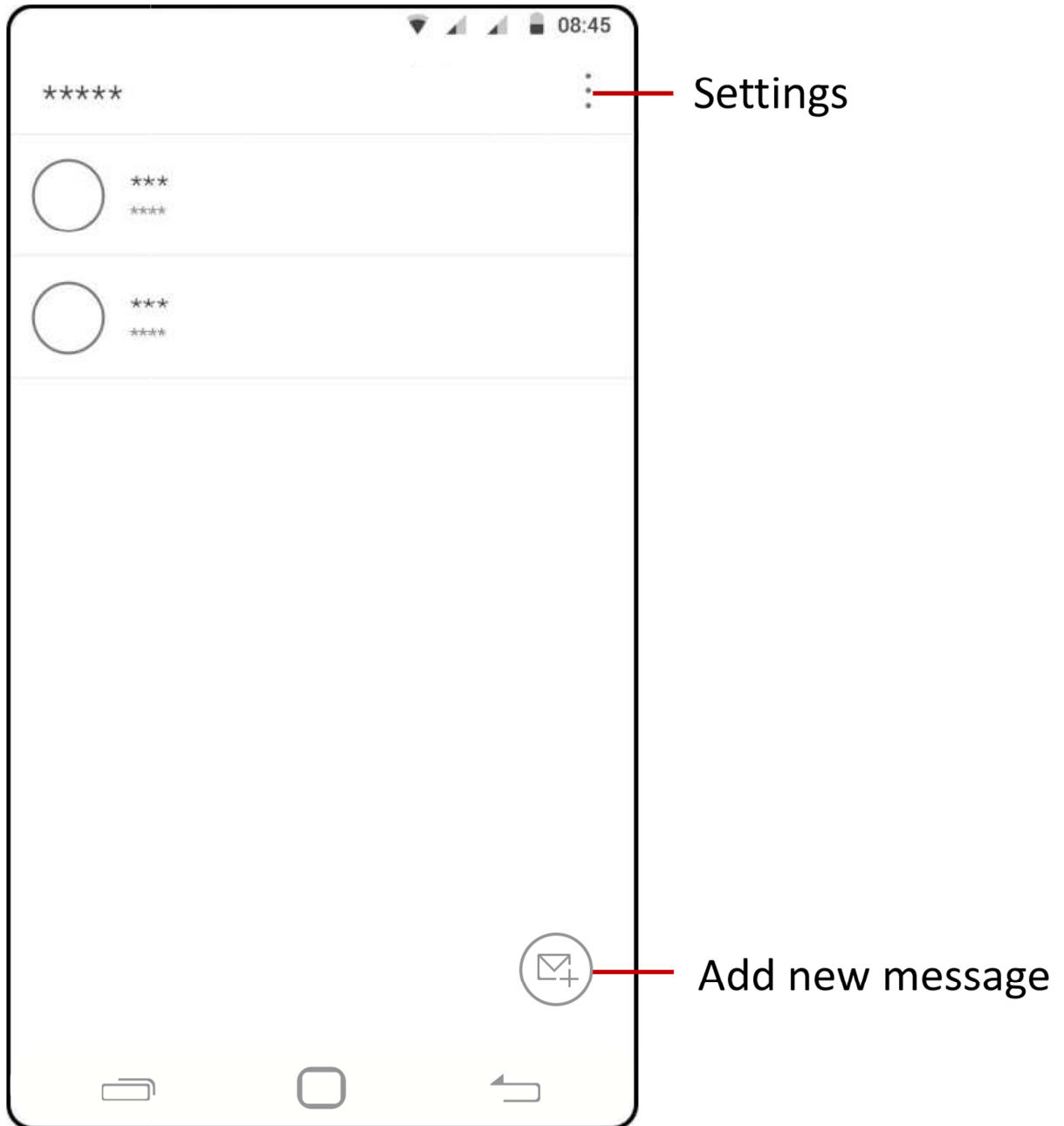

# 9.Camera

The camera function captures your surroundings via the front or rear camera.

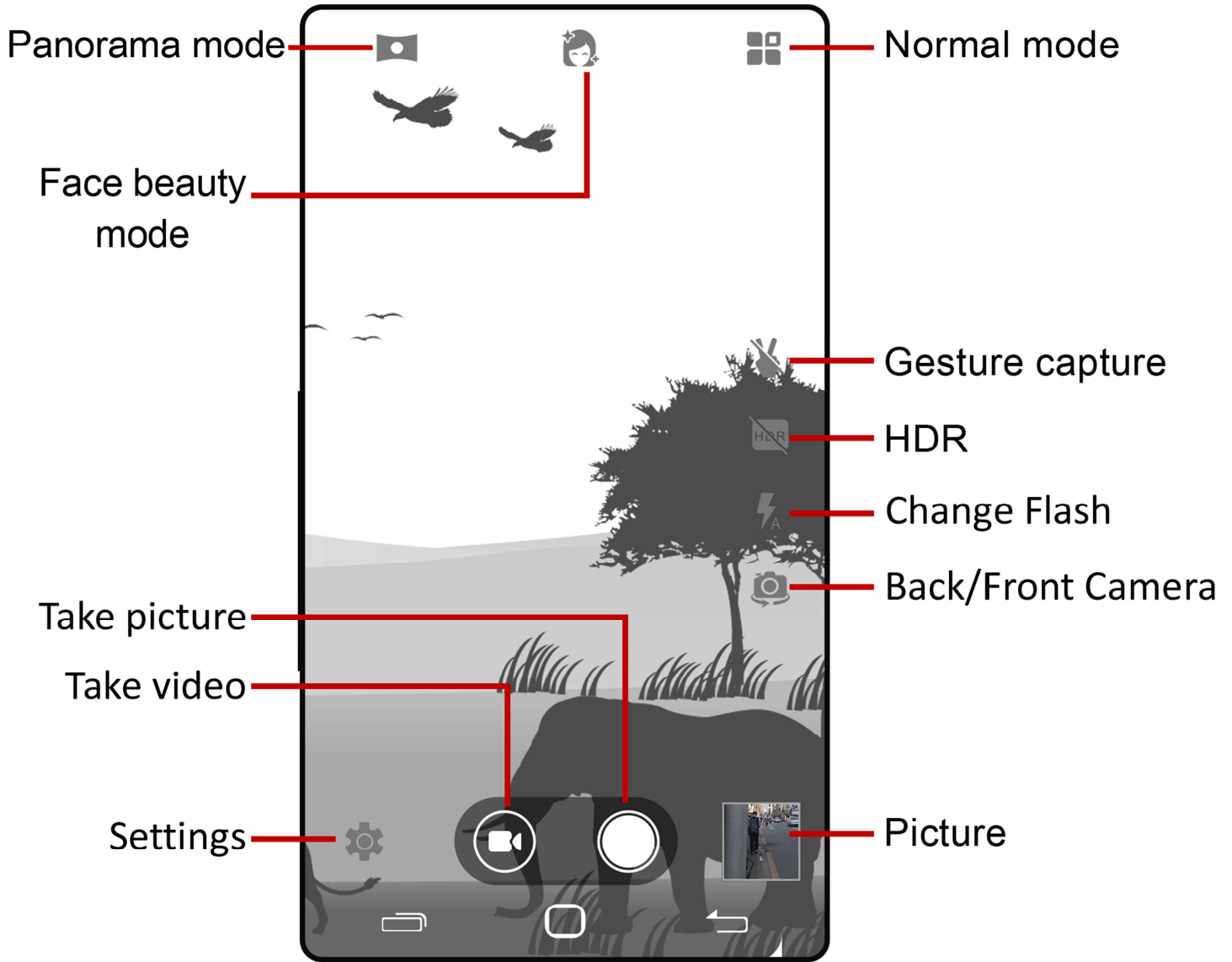

# 10. Gallery

The gallery can be used to browse images and photos from mobile or SD card storage; editing function can be performed. Images can be designated as wallpaper or contact avatar. The sharing function allows images to be shared with friends via Bluetooth and MMS, etc.

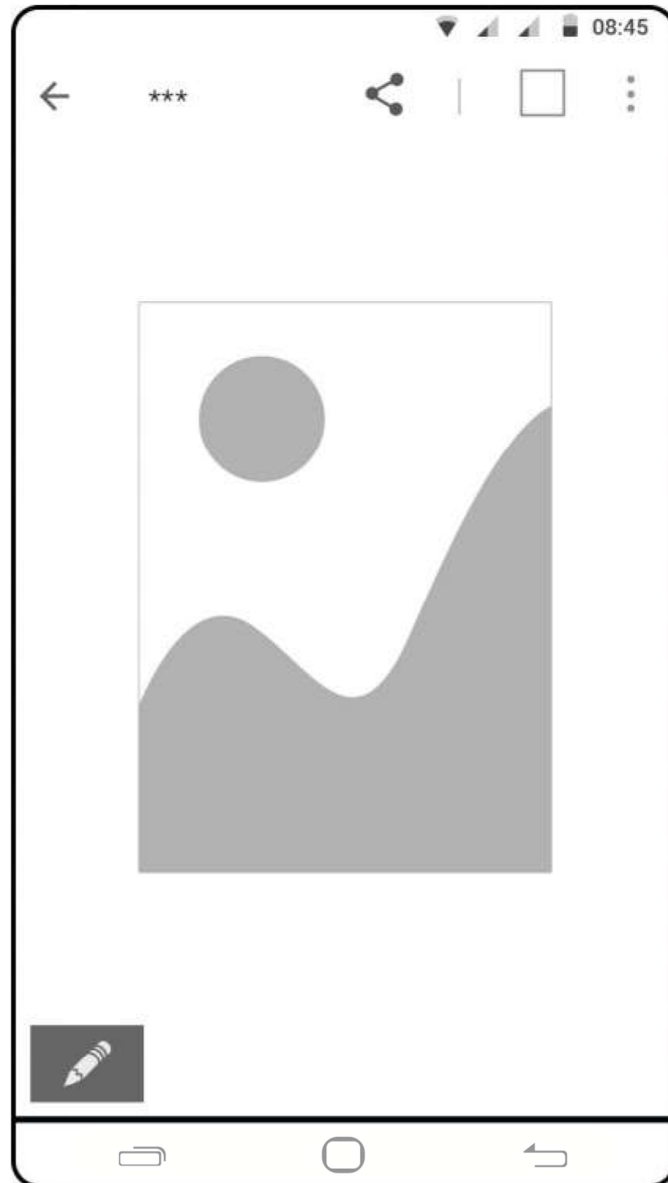

# 11.Wi-Fi

Enabling Wi-Fi grants access to local hotspots and allows you to browse Internet. Private networks will require a password.

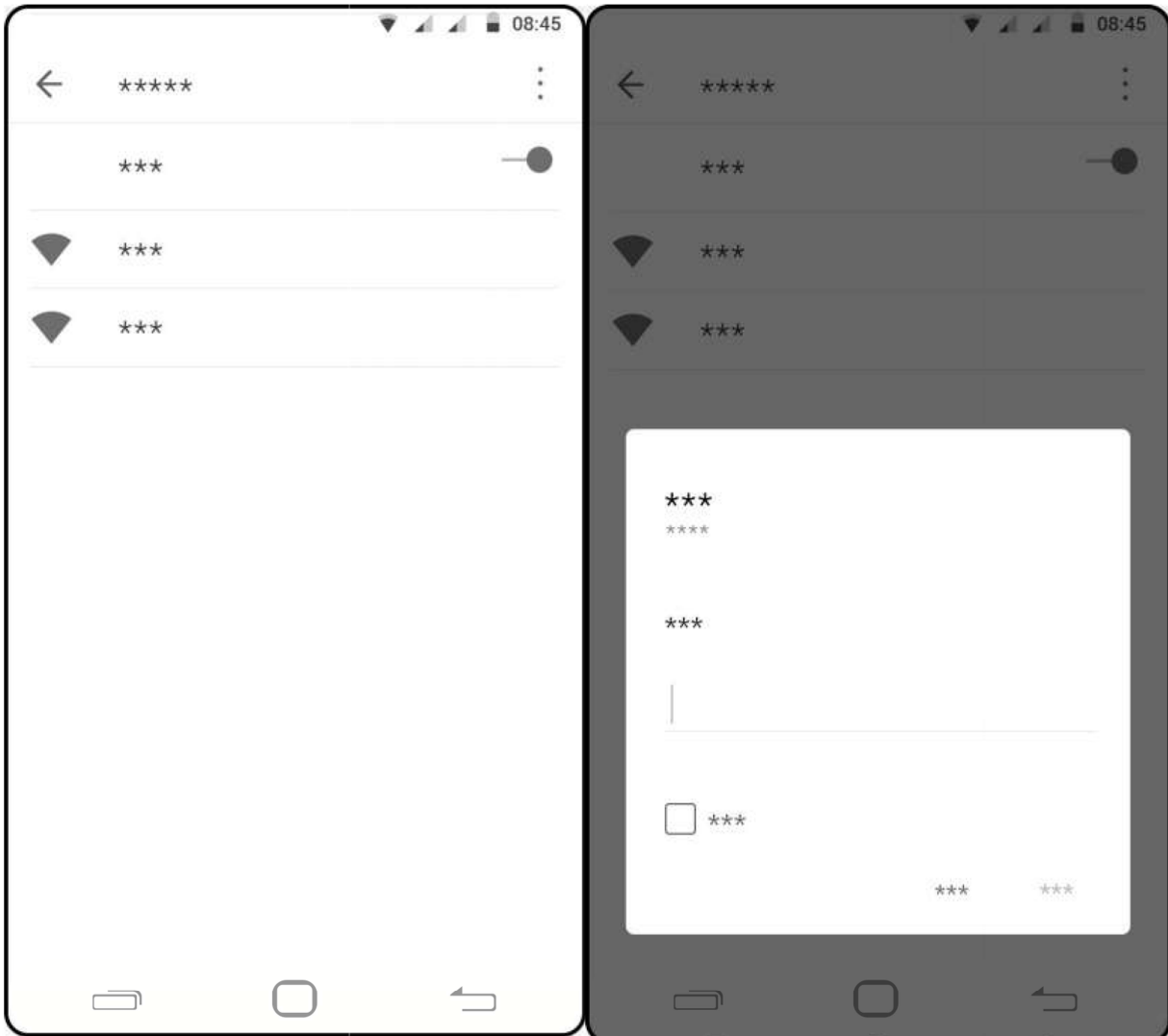

# 12.Map

“Google Maps” provides users with complete GPS & navigation services. It can display maps in terrain or terrain contour modes.



# 13. Music

Music playlist displays all relevant files saved on the mobile or SD card storage. You can play, pause, and switch between tracks through the music control panel. Volume control is accessed via side buttons.

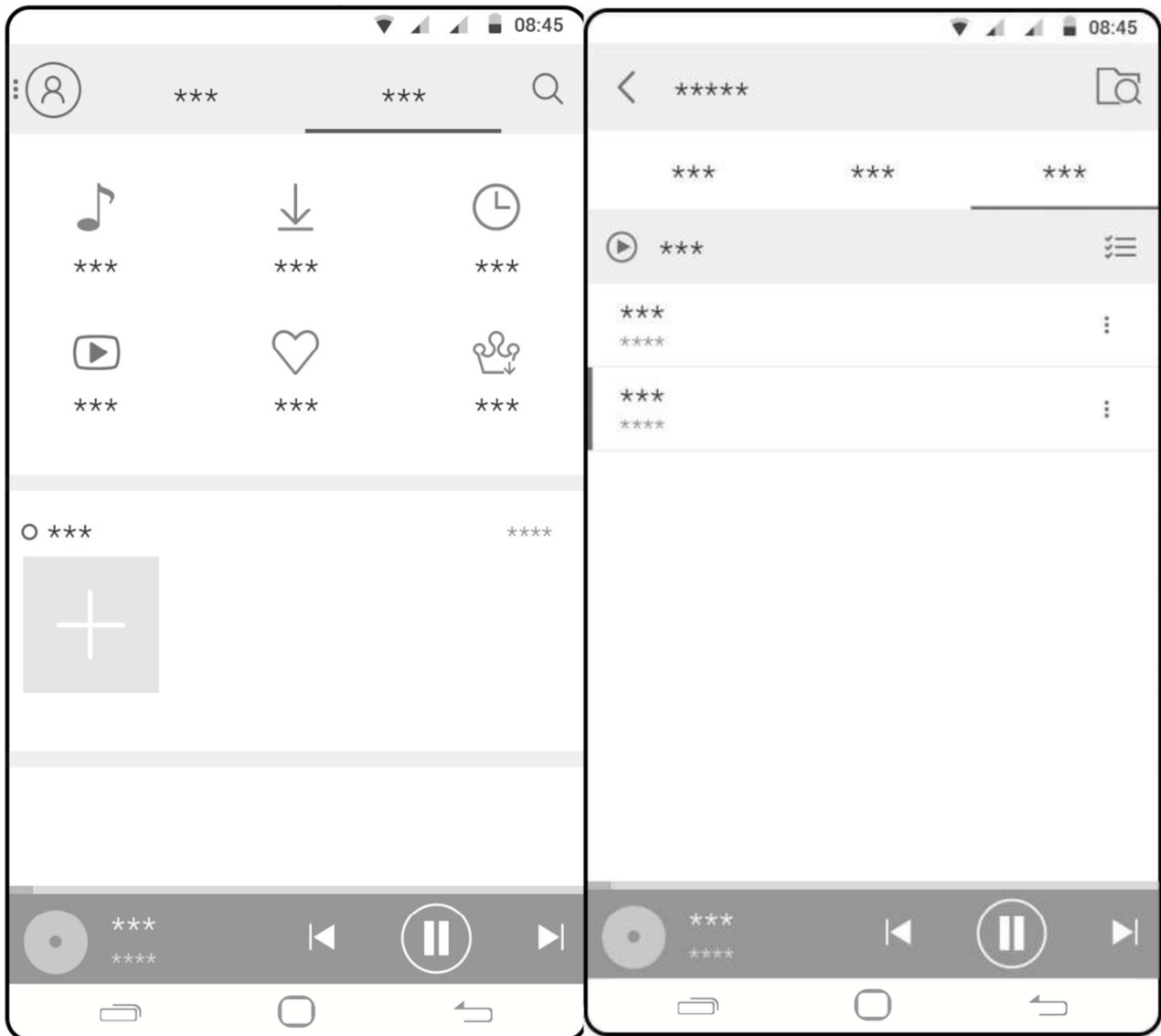



# 14.Palmplay

Palmplay is a virtual software store that offers commonly used apps. Simply tap an app to start downloading.

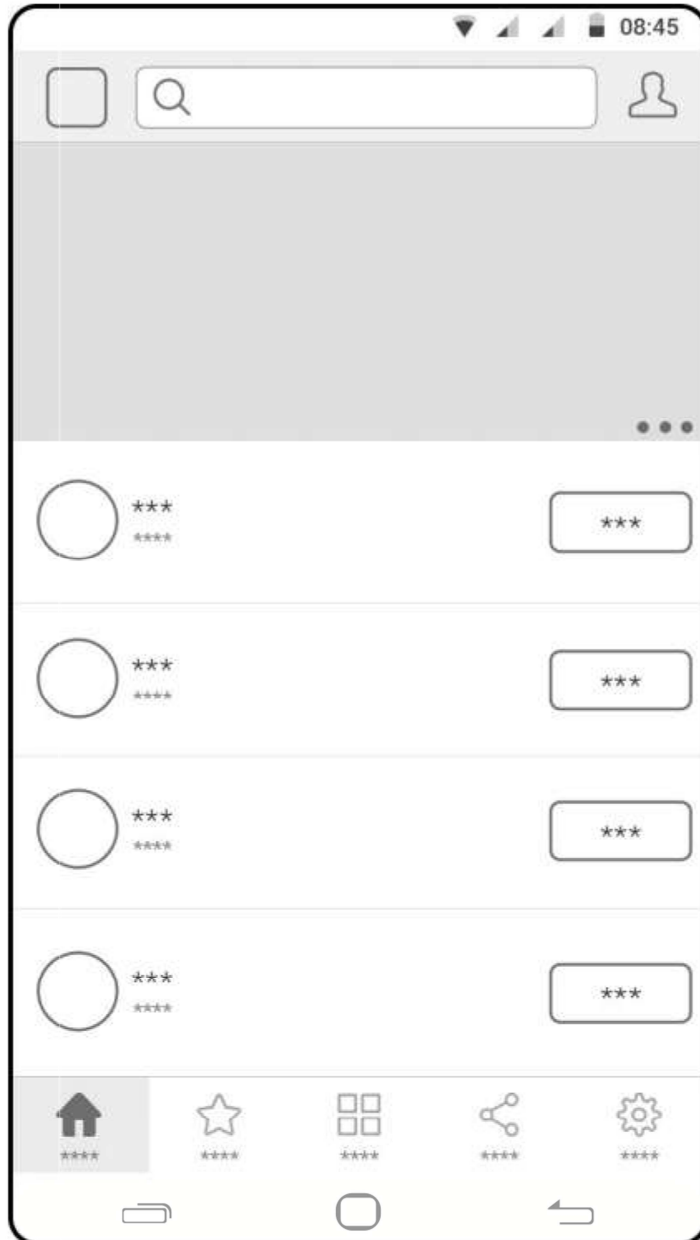

# 15. Factory data reset

“Factory data reset” resets all configurations to their default state. Internal mobile storage is cleared of all data including apps, photos, music, videos, mail, contacts, etc. This procedure may take a long time. Please wait patiently for mobile to restart and do not power off.

**WARNING:**

Reset factory settings as a last resort. Once activated all user data & configurations are deleted and cannot be restored.

# 16.SAR declaration

The highest SAR value for this mobile phone is  $< 1.6$  W/Kg, in accordance with the requirements of the ICNIRP, which recommended the limit for exposure to radio waves to be 1.6 watts/kilogram(W/kg) averaged over 1 gram of human tissue. The highest SAR values under the ICNIRP guidelines for this device model are:

Maximum SAR for this model and conditions under which it was recorded	
Head	1.29 W/Kg
Body	0.51 W/Kg

## Safety precautions:

- a) Use a wireless hands-free system( headphone, headset) with a low power Bluetooth emitter.
- b) Make sure the cell phone has a low SAR.
- c) Keep your calls short or send a text message (SMS) instead. This advice applies especially to children, adolescents and pregnant women.
- d) Use cell phone when the signal quality is good.
- e) People having active medical implants should preferably keep the cell phone at least 10 cm away from the implant.

## FCC Caution

### Labelling requirements.

This device complies with part 15 of the FCC Rules. Operation is subject to the condition that this device does not cause harmful interference.

### Information to user.

Any Changes or modifications not expressly approved by the party responsible for compliance could void the user's authority to operate the equipment.

### Information to the user.

**Note:** This equipment has been tested and found to comply with the limits for a Class B digital device, pursuant to part 15 of the FCC Rules. These limits are designed to provide reasonable protection against harmful interference in a residential installation. This equipment generates uses and can radiate radio frequency energy and, if not installed and used in accordance with the instructions, may cause harmful interference to radio communications. However, there is no guarantee that interference will not occur in a particular installation. If this equipment does cause harmful interference to radio or television reception, which can be determined by turning the equipment off and on, the user is encouraged to try to correct the interference by one or more of the following measures:

- Reorient or relocate the receiving antenna.
- Increase the separation between the equipment and receiver.
- Connect the equipment into an outlet on a circuit different from that to which the receiver is connected.

-Consult the dealer or an experienced radio/TV technician for help.

### **Specific Absorption Rate (SAR) information:**

This Mobile Phone meets the government's requirements for exposure to radio waves. The guidelines are based on standards that were developed by independent scientific organizations through periodic and thorough evaluation of scientific studies. The standards include a substantial safety margin designed to assure the safety of all persons regardless of age or health.

FCC RF Exposure Information and Statement The SAR limit of USA (FCC) is 1.6 W/kg averaged over one gram of tissue. Device types: F4(FCC ID: 2ADYY-F4) has also been tested against this SAR limit. The highest SAR value reported under this standard during product certification for use at the ear is 1.29 W/kg and when properly worn on the body is 0.51W/kg. This device was tested for typical body-worn operations with the back of the handset kept 10mm from the body. To maintain compliance with FCC RF exposure requirements, use accessories that maintain a 10mm separation distance between the user's body and the back of the handset. The use of belt clips, holsters and similar accessories should not contain metallic components in its assembly. The use of accessories that do not satisfy these requirements may not comply with FCC RF exposure requirements, and should be avoided.

### **Body-worn Operation**

This device was tested for typical body-worn operations. To comply with RF exposure requirements, a minimum separation distance of 1.0cm must be maintained between the user's body and the handset, including the antenna. Third-party belt-clips, holsters, and similar

accessories used by this device should not contain any metallic components. Body-worn accessories that do not meet these requirements may not comply with RF exposure requirements and should be avoided. Use only the supplied or an approved antenna.