



FCC PART 27
FCC PART 22H, PART 24E
TEST REPORT

For

TECNO MOBILE LIMITED

FLAT 39 8/F BLOCK D WAH LOK INDUSTRIAL CENTRE 31-35 SHAN MEI STREET
FOTAN NT Hong Kong

FCC ID: 2ADYY-CG8

Report Type: Original Report	Product Type: Mobile phone
Report Number: SZ1210303-05350E-00E	
Report Date: 2021-04-12	
Reviewed By: RF Engineer	<i>Jimmy Xiao</i>
Prepared By: Bay Area Compliance Laboratories Corp. (Shenzhen) 5F(B-West) ,6F,7F,the 3rd Phase of Wan Li Industrial Building D,Shihua Rd, FuTian Free Trade Zone, Shenzhen, China Tel: +86-755-33320018 Fax: +86-755-33320008 www.baclcorp.com.cn	

Note: This report may contain data that are not covered by the A2LA accreditation and are marked with an asterisk “★”.

BACL is not responsible for the authenticity of any test data provided by the applicant. Data included from the applicant that may affect test results are marked with an asterisk “*”. Customer model name, addresses, names, trademarks etc. are not considered data.

This report cannot be reproduced except in full, without prior written approval of the Company. Unless otherwise stated the results shown in this test report refer only to the sample(s) tested. This report is valid only with a valid digital signature. The digital signature may be available only under the Adobe software above version 7.0.

TABLE OF CONTENTS

GENERAL INFORMATION.....	3
PRODUCT DESCRIPTION FOR EQUIPMENT UNDER TEST (EUT).....	3
OBJECTIVE.....	3
TEST METHODOLOGY.....	4
MEASUREMENT UNCERTAINTY.....	4
TEST FACILITY.....	4
SYSTEM TEST CONFIGURATION.....	5
DESCRIPTION OF TEST CONFIGURATION.....	5
EQUIPMENT MODIFICATIONS.....	6
SUPPORT EQUIPMENT LIST AND DETAILS.....	6
SUPPORT CABLE DESCRIPTION.....	6
BLOCK DIAGRAM OF TEST SETUP.....	7
SUMMARY OF TEST RESULTS.....	8
TEST EQUIPMENT LIST.....	9
FCC §1.1307(B) & §2.1093 - RF EXPOSURE INFORMATION.....	11
APPLICABLE STANDARD.....	11
TEST RESULT.....	11
FCC §2.1047 - MODULATION CHARACTERISTIC.....	12
FCC § 2.1046, § 22.913 (A) & § 24.232 (C); §27.50 (C) (D) (H) - RF OUTPUT POWER.....	13
APPLICABLE STANDARD.....	13
TEST PROCEDURE.....	13
TEST DATA.....	13
FCC §2.1049, §22.917, §22.905 & §24.238 & §27.53 - OCCUPIED BANDWIDTH.....	45
APPLICABLE STANDARD.....	45
TEST PROCEDURE.....	45
TEST DATA.....	45
FCC §2.1051, §22.917(A) & §24.238(A); §27.53 - SPURIOUS EMISSIONS AT ANTENNA TERMINALS.....	76
APPLICABLE STANDARD.....	76
TEST PROCEDURE.....	76
TEST DATA.....	76
FCC § 2.1053; § 22.917 (A);§ 24.238 (A); §27.53 SPURIOUS RADIATED EMISSIONS.....	90
APPLICABLE STANDARD.....	90
TEST PROCEDURE.....	90
TEST DATA.....	90
FCC § 22.917 (A);§ 24.238 (A); §27.53(C) (H)(M) - BAND EDGES.....	100
APPLICABLE STANDARD.....	100
TEST PROCEDURE.....	100
TEST DATA.....	100
FCC § 2.1055; § 22.355; § 24.235; §27.54 - FREQUENCY STABILITY.....	114
APPLICABLE STANDARD.....	114
TEST PROCEDURE.....	114
TEST DATA.....	115

GENERAL INFORMATION

Product Description for Equipment under Test (EUT)

Product	Mobile phone
Tested Model	CG8
Frequency Range	EGSM 850: 824-849MHz(TX); 869-894MHz(RX) PCS 1900: 1850-1910MHz(TX); 1930-1990MHz(RX) WCDMA Band 2: 1850-1910MHz(TX); 1930-1990MHz(RX) WCDMA Band 4: 1710-1755MHz(TX); 2110-2155MHz(RX) WCDMA Band 5: 824-849MHz(TX); 869-894MHz(RX) LTE Band 2: 1850-1910MHz(TX); 1930-1990MHz(RX) LTE Band 4: 1710-1755MHz(TX); 2110-2155MHz(RX) LTE Band 5: 824-849MHz(TX); 869-894MHz(RX) LTE Band 7: 2500-2570MHz(TX); 2620-2690MHz(RX) LTE Band 17: 704-716MHz(TX); 734-746MHz(RX) LTE Band 38: 2570-2620MHz(TX/RX) LTE Band 41: 2535-2655MHz(TX/RX) LTE Band 66: 1710-1780MHz(TX); 2110-2180MHz(RX)
Modulation Technique	2G: GMSK, 8PSK 3G: BPSK, QPSK, 16QAM 4G: QPSK, 16QAM
Antenna Specification*	EGSM850/WCDMA Band 5/LTE Band 5: -2.1dBi PCS1900/WCDMA Band 2/ LTE Band 2: 0.2dBi WCDMA Band 4/ LTE Band 4/ LTE Band 66: 0.2dBi LTE Band 7/LTE Band 38/LTE Band 41: 0.5dBi LTE Band 17: -2.1dBi (provided by the applicant)
Voltage Range	DC 3.87V from battery or DC 5.0V or 10.0V from adapter
Date of Test	2021-03-07 to 2021-04-02
Sample serial number	SZ1210303-05350E-RF-S1(RSE Test) , SZ1210303-05350E-RF-S2(RF Conducted Test) (Assigned by BAACL, Shenzhen)
Received date	2021-03-03
Sample/EUT Status	Good condition
Adapter information	Model: U330TSA Input: AC 100-240V, 50/60Hz, 1.5A Output: DC 5.0V, 3.0A 15.0W or 10.0V, 3.3A 33.0W MAX

Objective

This test report is in accordance with Part 2-Subpart J, Part 22-Subpart H and Part 24-Subpart E and Subpart 27 of the Federal Communication Commissions rules.

The objective is to determine the compliance of the EUT with FCC rules for output power, modulation characteristic, occupied bandwidth, and spurious emission at antenna terminal, spurious radiated emission, frequency stability and band edge.

Test Methodology

All tests and measurements indicated in this document were performed in accordance with the Code of Federal Regulations Title 47 Part 2-Subpart J as well as the following parts:

Part 22 Subpart H - Public Mobile Services
 Part 24 Subpart E - Personal Communication Services
 Part 27 – Miscellaneous wireless communications services

ANSI C63.26-2015: American National Standard for Compliance Testing of Transmitters Used in Licensed Radio Services

All emissions measurement was performed at Bay Area Compliance Laboratories Corp. (Shenzhen). The radiated testing was performed at an antenna-to-EUT distance of 3 meters.

Measurement Uncertainty

Parameter		Uncertainty
Occupied Channel Bandwidth		±5%
RF output power, conducted		±0.73dB
Unwanted Emission, conducted		±1.6dB
Emissions, Radiated	Below 1GHz	±4.75dB
	Above 1GHz	±4.88dB
Temperature		±1°C
Humidity		±6%
Supply voltages		±0.4%

Note: The extended uncertainty given in this report is obtained by combining the standard uncertainty times the coverage factor K with the 95% confidence interval. Otherwise required by the applicant or Product Regulations, Decision Rule in this report did not consider the uncertainty.

Test Facility

The Test site used by Bay Area Compliance Laboratories Corp. (Shenzhen) to collect test data is located on the 5F(B-West), 6F, 7F, the 3rd Phase of Wan Li Industrial Building D, Shihua Rd, FuTian Free Trade Zone, Shenzhen, China.

The test site has been approved by the FCC under the KDB 974614 D01 and is listed in the FCC Public Access Link (PAL) database, FCC Registration No.: 342867, the FCC Designation No.: CN1221.

The test site has been registered with ISED Canada under ISED Canada Registration Number 3062B.

SYSTEM TEST CONFIGURATION

Description of Test Configuration

The final qualification test was performed with the EUT operating at normal mode.

Test was performed as below table:

Frequency band	Bandwidth (MHz)	Test Frequency(MHz)		
		Low	Middle	High
EGSM850	0.25	824.2	836.6	848.8
DCS1900	0.25	1850.2	1880	1909.8
WCDMA B2	4.2	1852.4	1880	1907.6
WCDMA B4	4.2	1712.4	1732.6	1752.6
WCDMA B5	4.2	826.4	836.6	846.6
LTE B2	1.4	1850.7	1880	1909.3
	3	1851.5	1880	1908.5
	5	1852.5	1880	1907.5
	10	1855	1880	1905
	15	1857.5	1880	1902.5
	20	1860	1880	1900
LTE B4	1.4	1710.7	1732.5	1754.3
	3	1711.5	1732.5	1753.5
	5	1712.5	1732.5	1752.5
	10	1715	1732.5	1750
	15	1717.5	1732.5	1747.5
	20	1720	1732.5	1745
LTE B5	1.4	824.7	836.5	848.3
	3	825.5	836.5	847.5
	5	826.5	836.5	846.5
	10	829	836.5	844
LTE B7	5	2502.5	2535	2567.5
	10	2505	2535	2565
	15	2507.5	2535	2562.5
	20	2510	2535	2560
LTE B17	5	706.5	710	713.5
	10	709	710	711
LTE B38	5	2572.5	2595	2617.5
	10	2575	2595	2615
	15	2577.5	2595	2612.5
	20	2580	2595	2610

Frequency band	Bandwidth (MHz)	Test Frequency(MHz)		
		Low	Middle	High
LTE B41	5	2537.5	2593	2652.5
	10	2540	2593	2650
	15	2542.5	2593	2647.5
	20	2545	2593	2645
LTE B66	1.4	1710.7	1745	1779.3
	3	1711.5	1745	1778.5
	5	1712.5	1745	1777.5
	10	1715	1745	1775
	15	1717.5	1745	1772.5
	20	1720	1745	1770

Equipment Modifications

No modification was made to the EUT.

Support Equipment List and Details

Manufacturer	Description	Model	Serial Number
Rohde & Schwarz	Wideband Radio Communication Tester	CMW500	1201.002K50-116218-U
Rohde & Schwarz	Universal Radio Communication Tester	CMU200	115500

Support Cable Description

Cable Description	Length (m)	From / Port	To
Un-shielded Detachable AC cable	1.2	AC Power Source	CMW500/ CMU200

Block Diagram of Test Setup

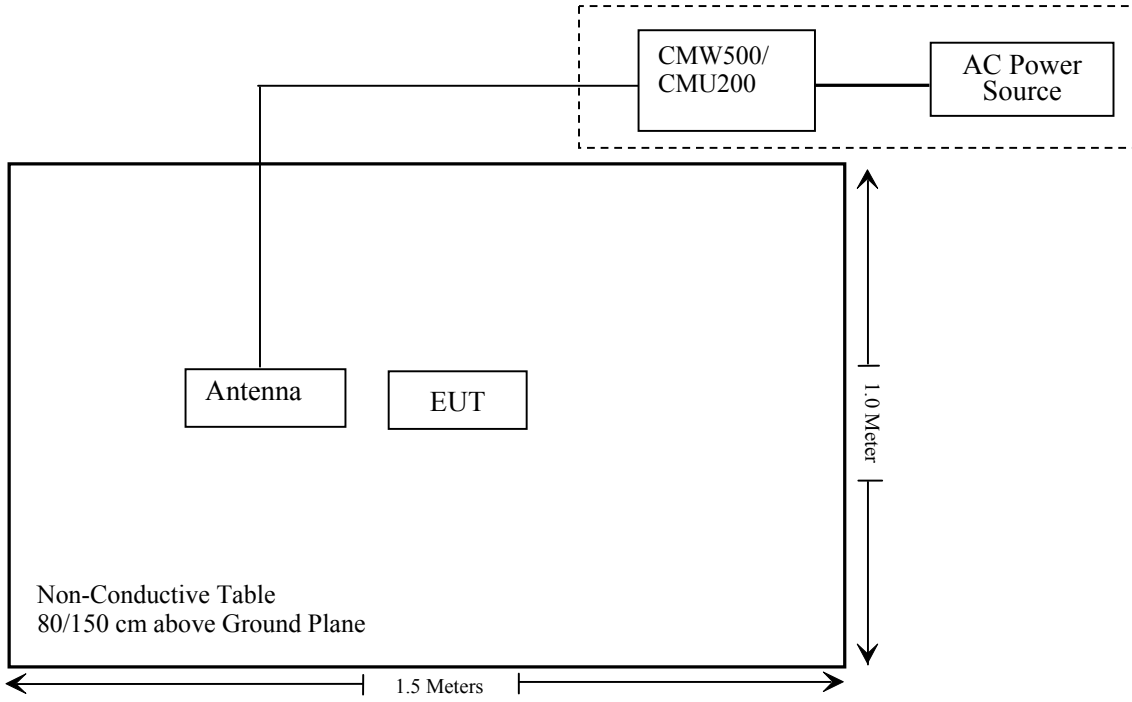

SUMMARY OF TEST RESULTS

FCC Rules	Description of Test	Result
§ 1.1307 , §2.1093	RF Exposure (SAR)	Compliance*
§2.1046; § 22.913 (a); § 24.232 (c); §27.50 (c) (d) (h)	RF Output Power	Compliance
§ 2.1047	Modulation Characteristics	Not Applicable
§ 2.1049; § 22.905; § 22.917; § 24.238; §27.53	Occupied Bandwidth	Compliance
§ 2.1051; § 22.917 (a); § 24.238 (a); §27.53	Spurious Emissions at Antenna Terminal	Compliance
§ 2.1053; § 22.917 (a); § 24.238 (a); §27.53	Field Strength of Spurious Radiation	Compliance
§ 22.917 (a); § 24.238 (a); §27.53(c)(h) (m)	Band Edge	Compliance
§ 2.1055; § 22.355; § 24.235; §27.54;	Frequency stability	Compliance

Note: * Please refer to SAR report released by BACL, report number: SZ1210303-05350E-20.

TEST EQUIPMENT LIST

Manufacturer	Description	Model	Serial Number	Calibration Date	Calibration Due Date
Radiated Emission Test					
R&S	EMI Test Receiver	ESR3	102455	2020/08/04	2021/08/03
Sonoma instrument	Pre-amplifier	310 N	186238	2020/08/04	2021/08/03
Sunol Sciences	Broadband Antenna	JB1	A040904-2	2020/12/22	2023/12/21
COM-POWER	Dipole Antenna	AD-100	721027	NCR	NCR
Unknown	Cable 2	RF Cable 2	F-03-EM197	2020/11/29	2021/11/28
Unknown	Cable	Chamber Cable 1	F-03-EM236	2020/11/29	2021/11/28
Rohde & Schwarz	Spectrum Analyzer	FSV40-N	102259	2020/08/04	2021/08/03
COM-POWER	Pre-amplifier	PA-122	181919	2020/11/29	2021/11/28
Quinstar	Amplifier	QLW-18405536-J0	15964001002	2020/11/29	2021/11/28
Sunol Sciences	Horn Antenna	3115	9107-3694	2021/01/15	2024/01/14
A.H.System	Horn Antenna	SAS-200/571	135	2018/09/01	2021/08/31
Insulted Wire Inc.	RF Cable	SPS-2503-3150	02222010	2020/11/29	2021/11/28
Unknown	RF Cable	W1101-EQ1 OUT	F-19-EM005	2020/11/29	2021/11/28
MICRO-TRONICS	Passband filter	HPM50111	F-19-EM006	2020/04/20	2021/04/19
Unknown	High Pass filter	1.3GHz	101120	2020/04/20	2021/04/19
Ducommun Technologies	Horn antenna	ARH-4223-02	1007726-01 1304	2020/12/06	2023/12/05
Ducommun Technologies	Horn antenna	ARH-4223-02	1007726-02 1304	2020/12/06	2023/12/05
Agilent	Signal Generator	N5183A	MY51040755	2020/12/29	2021/12/28
Rohde & Schwarz	Wideband Radio Communication Tester	CMW500	1201.002K50-146520-wh	2020/08/04	2021/08/03
Rohde & Schwarz	Universal Radio Communication Tester	CMU200	115500	2020/07/31	2021/07/30

Manufacturer	Description	Model	Serial Number	Calibration Date	Calibration Due Date
RF Conducted Test					
Rohde & Schwarz	Signal and Spectrum Analyzer	FSV40	101473	2020/08/04	2021/08/03
Rohde & Schwarz	Wideband Radio Communication Tester	CMW500	1201.002K50-146520-wh	2020/08/04	2021/08/03
Unknown	RF Cable	Unknown	2301 276	2020/11/29	2021/11/28
Unknown	RF Cable	Unknown	DLO J5/W6102	2020/11/29	2021/11/28
Weinschel	Power divider	1515	MY628	2020/11/29	2021/11/28
Rohde & Schwarz	Universal Radio Communication Tester	CMU200	115500	2020/07/31	2021/07/30
instek	DC Power Supply	GPS-3030DD	EM832096	NCR	NCR
ESPEC	Temperature & Humidity Chamber	EL-10KA	9107726	2021/01/05	2022/01/05
Fluke	Digital Multimeter	287	19000011	2020/07/23	2021/07/22

* Statement of Traceability: Bay Area Compliance Laboratories Corp. (Shenzhen) attests that all calibrations have been performed in accordance to requirements that traceable to National Primary Standards and International System of Units (SI).

FCC §1.1307(b) & §2.1093 - RF EXPOSURE INFORMATION

Applicable Standard

FCC§1.1310 and §2.1093.

Test Result

Compliance, please refer to the SAR report: SZ1210303-05350E-20.

FCC §2.1047 - MODULATION CHARACTERISTIC

According to FCC § 2.1047(d), Part 22H & 24E & 27 there is no specific requirement for digital modulation, therefore modulation characteristic is not presented.

FCC § 2.1046, § 22.913 (a) & § 24.232 (c); §27.50 (c) (d) (h) - RF OUTPUT POWER

Applicable Standard

According to FCC §2.1046 and §22.913 (a), the ERP of mobile transmitters and auxiliary test transmitters must not exceed 7 watts.

According to FCC §2.1046 and §24.232 (C), mobile and portable stations are limited to 2 watts EIRP and the equipment must employ a means for limiting power to the minimum necessary for successful communications.

The peak-to-average power ratio (PAPR) of the transmitter output power must not exceed 13 dB.

According to §27.50(c), Portable stations (hand-held devices) in the 600 MHz uplink band and the 698-746 MHz band, and fixed and mobile stations in the 600 MHz uplink band are limited to 3 watts ERP.

According to §27.50(d), the maximum EIRP must not exceed 1Watts (30dBm) for 1710-1780MHz.

According to §27.50(h), the maximum EIRP must not exceed 2Watts (33dBm) for 2500-2570MHz & 2496-2690MHz.

Test Procedure

Conducted method:

The RF output of the transmitter was connected to the CMW500/CMU200 through sufficient attenuation.

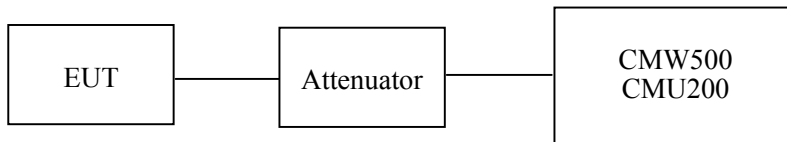

Test Data

Environmental Conditions

Temperature:	24~26.5 °C
Relative Humidity:	54~56 %
ATM Pressure:	100.0~101.0 kPa

The testing was performed by Black Chen from 2021-03-07 to 2021-03-10.

Conducted Power

Cellular Band (Part 22H)

Mode	Channel	Frequency (MHz)	Average Output Power (dBm)	ERP (dBm)	Limit (dBm)
GSM	128	824.2	33.25	29.00	38.45
	190	836.6	33.21	28.96	38.45
	251	848.8	33.05	28.80	38.45

Mode	Channel	Frequency (MHz)	Average Output Power (dBm)				ERP(dBm)				Limit (dBm)
			1 slot	2 slots	3 slots	4 slots	1 slot	2 slots	3 slots	4 slots	
GPRS	128	824.2	33.28	32.32	30.30	29.32	29.03	28.07	26.05	25.07	38.45
	190	836.6	33.33	32.31	30.29	29.33	29.08	28.06	26.04	25.08	38.45
	251	848.8	33.07	32.05	29.99	29.02	28.82	27.8	25.74	24.77	38.45

Mode	Channel	Frequency (MHz)	Average Output Power (dBm)				ERP(dBm)				Limit (dBm)
			1 slot	2 slots	3 slots	4 slots	1 slot	2 slots	3 slots	4 slots	
EGPRS	128	824.2	27.97	26.67	24.44	23.24	23.72	22.42	20.19	18.99	38.45
	190	836.6	27.95	26.63	24.45	23.22	23.70	22.38	20.2	18.97	38.45
	251	848.8	27.86	26.59	24.34	23.11	23.61	22.34	20.09	18.86	38.45

Mode	Test Mode	3GPP Sub Test	Average Output Power (dBm)			ERP(dBm)		
			Low	Mid	High	Low	Mid	High
WCDMA (Band 5)	RMC12.2k		23.42	23.49	23.47	19.17	19.24	19.22
	HSDPA	1	22.40	22.42	22.41	18.15	18.17	18.16
		2	22.27	22.31	22.33	18.02	18.06	18.08
		3	22.47	22.52	22.52	18.22	18.27	18.27
		4	22.32	22.31	22.34	18.07	18.06	18.09
	HSUPA	1	22.05	22.08	22.09	17.8	17.83	17.84
		2	21.97	22.02	22.06	17.72	17.77	17.81
		3	22.11	22.17	22.20	17.86	17.92	17.95
		4	22.00	21.99	22.04	17.75	17.74	17.79
		5	22.08	22.12	22.18	17.83	17.87	17.93
HSPA+	/	21.98	22.16	22.24	17.73	17.91	17.99	

Note: ERP(dBm) = Conducted Power(dBm) + Antenna Gain(dBd)
 For GSM850/WCDMA Band 5: Antenna Gain = -2.1dBi = -4.25dBd (0dBd=2.15dBi)
 The limit: ERP ≤ 38.45dBm

PCS Band (Part 24E)

Mode	Channel	Frequency (MHz)	Average Output Power (dBm)	EIRP(dBm)	Limit (dBm)
GSM	512	1850.2	29.16	29.36	33
	661	1880.0	29.24	29.44	33
	810	1909.8	29.44	29.64	33

Mode	Channel	Frequency (MHz)	Average Output Power (dBm)				EIRP(dBm)				Limit (dBm)
			1 slot	2 slots	3 slots	4 slots	1 slot	2 slots	3 slots	4 slots	
GPRS	512	1850.2	29.05	28.08	26.04	25.03	29.25	28.28	26.24	25.23	33
	661	1880.0	29.13	28.19	26.12	25.07	29.33	28.39	26.32	25.27	33
	810	1909.8	29.39	28.41	26.42	25.41	29.59	28.61	26.62	25.61	33

Mode	Channel	Frequency (MHz)	Average Output Power (dBm)				EIRP(dBm)				Limit (dBm)
			1 slot	2 slots	3 slots	4 slots	1 slot	2 slots	3 slots	4 slots	
EGPRS	512	1850.2	27.36	26.15	24.04	22.73	27.56	26.35	24.24	22.93	33
	661	1880.0	27.22	26.02	23.75	22.54	27.42	26.22	23.95	22.74	33
	810	1909.8	26.30	25.17	22.94	21.77	26.5	25.37	23.14	21.97	33

Mode	Test Mode	3GPP Sub Test	Average Output Power (dBm)			EIRP(dBm)		
			Low	Mid	High	Low	Mid	High
WCDMA (Band 2)	RMC12.2k		23.51	23.12	22.97	23.71	23.32	23.17
	HSDPA	1	22.53	22.16	21.83	22.73	22.36	22.03
		2	21.87	21.99	21.89	22.07	22.19	22.09
		3	22.04	22.14	22.04	22.24	22.34	22.24
		4	21.88	21.92	21.84	22.08	22.12	22.04
	HSUPA	1	21.54	21.60	21.50	21.74	21.80	21.70
		2	21.45	21.55	21.40	21.65	21.75	21.60
		3	21.61	21.64	21.56	21.81	21.84	21.76
		4	21.50	21.50	21.44	21.7	21.7	21.64
		5	21.64	21.71	21.58	21.84	21.91	21.78
HSPA+	\	21.84	21.94	21.75	22.04	22.14	21.95	

Note: EIRP(dBm) = Conducted Power(dBm) + Antenna Gain(dBi)
 For PCS1900/WCDMA Band 2: Antenna Gain = 0.2dBi
 The limit: EIRP ≤ 33dBm

AWS Band (Part 27)

Mode	Test Mode	3GPP Sub Test	Average Output Power (dBm)			EIRP(dBm)		
			Low	Mid	High	Low	Mid	High
WCDMA (Band 4)	RMC12.2k		21.91	22.34	22.30	22.11	22.54	22.50
	HSDPA	1	20.96	21.02	21.01	21.16	21.22	21.21
		2	20.87	20.90	20.88	21.07	21.10	21.08
		3	21.02	21.07	21.14	21.22	21.27	21.34
		4	20.88	20.92	20.90	21.08	21.12	21.10
	HSUPA	1	21.23	21.45	21.64	21.43	21.65	21.84
		2	21.34	21.52	21.51	21.54	21.72	21.71
		3	21.29	21.61	21.75	21.49	21.81	21.95
		4	21.18	21.54	21.56	21.38	21.74	21.76
		5	21.35	21.60	21.69	21.55	21.80	21.89
	HSPA+	\	21.56	21.61	21.68	21.76	21.81	21.88

Note: EIRP(dBm) = Conducted Power(dBm) + Antenna Gain(dBi)
 For WCDMA Band 4: Antenna Gain = 0.2dBi
 The limit: EIRP ≤ 30dBm

Peak-to-average ratio (PAR)

Cellular Band

Mode	Channel	PAR (dB)	Limit (dB)
GSM	Low	3.41	13
	Middle	3.35	13
	High	3.33	13

Mode	Channel	PAR (dB)	Limit (dB)
EGPRS	Low	3.45	13
	Middle	3.25	13
	High	3.41	13

Mode	Channel	PAR (dB)	Limit (dB)
RMC (BPSK)	Low	3.26	13
	Middle	3.57	13
	High	3.65	13
HSDPA (16QAM)	Low	3.55	13
	Middle	4.57	13
	High	4.35	13
HSUPA (BPSK)	Low	4.47	13
	Middle	4.18	13
	High	5.05	13
HSPA+	Low	4.25	13
	Middle	4.81	13
	High	4.76	13

PCS Band

Mode	Channel	PAR (dB)	Limit (dB)
GSM	Low	3.44	13
	Middle	3.28	13
	High	3.19	13

Mode	Channel	PAR (dB)	Limit (dB)
EGPRS	Low	3.40	13
	Middle	3.48	13
	High	3.35	13

Mode	Channel	PAR (dB)	Limit (dB)
RMC (BPSK)	Low	3.24	13
	Middle	3.44	13
	High	3.65	13
HSDPA (16QAM)	Low	3.57	13
	Middle	4.55	13
	High	4.24	13
HSUPA (BPSK)	Low	4.41	13
	Middle	4.35	13
	High	5.02	13
HSPA+	Low	4.12	13
	Middle	4.35	13
	High	4.61	13

AWS Band

Mode	Channel	PAR (dB)	Limit (dB)
RMC (BPSK)	Low	3.23	13
	Middle	3.44	13
	High	3.21	13
HSDPA (16QAM)	Low	4.58	13
	Middle	4.07	13
	High	4.35	13
HSUPA (BPSK)	Low	3.78	13
	Middle	3.46	13
	High	3.52	13
HSPA+	Low	3.98	13
	Middle	3.75	13
	High	3.46	13

LTE Band 2:

Maximum Output Power

Bandwidth (MHz)	Modulation	RB size/ RB Offset	Conducted Average Output Power (dBm)			EIRP(dBm)		
			Low	Mid	High	Low	Mid	High
1.4	QPSK	RB1#0	23.01	23.09	23.09	23.21	23.29	23.29
		RB1#2	23.03	23.14	23.13	23.23	23.34	23.33
		RB1#5	23.04	23.08	23.06	23.24	23.28	23.26
		RB3#0	23.06	23.16	23.09	23.26	23.36	23.29
		RB3#1	23.05	23.10	23.14	23.25	23.3	23.34
		RB3#2	22.14	22.18	22.17	22.34	22.38	22.37
		RB6#0	21.95	22.15	22.00	22.15	22.35	22.2
	16QAM	RB1#0	21.98	22.22	22.10	22.18	22.42	22.3
		RB1#2	21.98	22.17	22.08	22.18	22.37	22.28
		RB1#5	22.23	22.10	22.18	22.43	22.3	22.38
		RB3#0	22.25	22.10	22.18	22.45	22.3	22.38
		RB3#1	21.13	21.25	21.15	21.33	21.45	21.35
		RB3#2	21.21	21.29	21.29	21.41	21.49	21.49
		RB6#0	21.23	21.34	21.33	21.43	21.54	21.53
3.0	QPSK	RB1#0	22.84	22.96	22.97	23.04	23.16	23.17
		RB1#7	22.89	23.00	23.00	23.09	23.2	23.2
		RB1#14	22.84	22.95	22.93	23.04	23.15	23.13
		RB8#0	21.97	22.04	22.04	22.17	22.24	22.24
		RB8#4	22.03	22.06	22.07	22.23	22.26	22.27
		RB8#7	22.00	22.08	22.09	22.2	22.28	22.29
		RB15#0	22.34	22.03	21.89	22.54	22.23	22.09
	16QAM	RB1#0	22.38	22.10	21.99	22.58	22.3	22.19
		RB1#7	22.27	22.05	21.93	22.47	22.25	22.13
		RB1#14	21.10	21.10	21.03	21.3	21.3	21.23
		RB8#0	21.08	21.13	21.04	21.28	21.33	21.24
		RB8#4	21.08	21.04	21.13	21.28	21.24	21.33
		RB8#7	21.04	21.16	21.17	21.24	21.36	21.37
		RB15#0	21.09	21.20	21.20	21.29	21.4	21.40

Bandwidth (MHz)	Modulation	RB size/ RB Offset	Conducted Average Output Power (dBm)			EIRP(dBm)		
			Low	Mid	High	Low	Mid	High
5.0	QPSK	RB1#0	23.14	23.26	23.22	23.34	23.46	23.42
		RB1#12	23.18	23.27	23.24	23.38	23.47	23.44
		RB1#24	23.11	23.23	23.17	23.31	23.43	23.37
		RB12#0	22.04	22.15	22.23	22.24	22.35	22.43
		RB12#6	22.12	22.20	22.23	22.32	22.4	22.43
		RB12#11	22.14	22.17	22.21	22.34	22.37	22.41
		RB25#0	21.98	22.46	22.26	22.18	22.66	22.46
	16QAM	RB1#0	22.02	22.51	22.32	22.22	22.71	22.52
		RB1#12	22.02	22.48	22.26	22.22	22.68	22.46
		RB1#24	21.12	21.13	21.25	21.32	21.33	21.45
		RB12#0	21.18	21.19	21.22	21.38	21.39	21.42
		RB12#6	21.17	21.22	21.25	21.37	21.42	21.45
		RB12#11	21.34	21.46	21.42	21.54	21.66	21.62
		RB25#0	21.38	21.47	21.44	21.58	21.67	21.64
10.0	QPSK	RB1#0	23.10	23.17	23.19	23.3	23.37	23.39
		RB1#24	23.16	23.27	23.30	23.36	23.47	23.5
		RB1#49	23.11	23.24	23.19	23.31	23.44	23.39
		RB25#0	22.03	22.09	22.19	22.23	22.29	22.39
		RB25#12	22.10	22.18	22.15	22.3	22.38	22.35
		RB25#24	22.10	22.18	22.22	22.3	22.38	22.42
		RB50#0	22.58	22.31	22.16	22.78	22.51	22.36
	16QAM	RB1#0	22.65	22.35	22.25	22.85	22.55	22.45
		RB1#24	22.61	22.33	22.18	22.81	22.53	22.38
		RB1#49	21.07	21.15	21.30	21.27	21.35	21.5
		RB25#0	21.19	21.25	21.29	21.39	21.45	21.49
		RB25#12	21.10	21.17	21.25	21.3	21.37	21.45
		RB25#24	21.30	21.37	21.39	21.5	21.57	21.59
		RB50#0	21.36	21.47	21.5	21.56	21.67	21.7

Bandwidth (MHz)	Modulation	RB size/ RB Offset	Conducted Average Output Power (dBm)			EIRP(dBm)		
			Low	Mid	High	Low	Mid	High
15.0	QPSK	RB1#0	23.10	23.23	23.22	23.3	23.43	23.42
		RB1#37	23.17	23.29	23.30	23.37	23.49	23.5
		RB1#74	23.15	23.18	23.21	23.35	23.38	23.41
		RB36#0	22.04	22.17	22.19	22.24	22.37	22.39
		RB36#18	22.10	22.21	22.18	22.3	22.41	22.38
		RB36#37	22.08	22.22	22.23	22.28	22.42	22.43
		RB75#0	22.59	22.34	22.55	22.79	22.54	22.75
	16QAM	RB1#0	22.67	22.36	22.65	22.87	22.56	22.85
		RB1#37	22.65	22.28	22.56	22.85	22.48	22.76
		RB1#74	21.09	21.22	21.20	21.29	21.42	21.4
		RB36#0	21.15	21.20	21.19	21.35	21.4	21.39
		RB36#18	21.08	21.21	21.20	21.28	21.41	21.4
		RB36#37	21.30	21.43	21.42	21.5	21.63	21.62
		RB75#0	21.37	21.49	21.50	21.57	21.69	21.7
20.0	QPSK	RB1#0	23.06	23.21	23.11	23.26	23.41	23.31
		RB1#49	23.22	23.34	23.25	23.42	23.54	23.45
		RB1#99	23.18	23.23	23.16	23.38	23.43	23.36
		RB50#0	22.10	22.22	22.21	22.3	22.42	22.41
		RB50#24	22.10	22.27	22.22	22.3	22.47	22.42
		RB50#49	22.07	22.24	22.17	22.27	22.44	22.37
		RB100#0	22.29	22.34	22.60	22.49	22.54	22.8
	16QAM	RB1#0	22.45	22.49	22.80	22.65	22.69	23
		RB1#49	22.47	22.35	22.68	22.67	22.55	22.88
		RB1#99	21.05	21.21	21.16	21.25	21.41	21.36
		RB50#0	21.12	21.26	21.22	21.32	21.46	21.42
		RB50#24	21.13	21.25	21.18	21.33	21.45	21.38
		RB50#49	21.26	21.41	21.31	21.46	21.61	21.51
		RB100#0	21.42	21.54	21.45	21.62	21.74	21.65

Note: EIRP(dBm) = Conducted Power(dBm) + Antenna Gain(dBi)
 For LTE Band2: Antenna Gain = 0.2dBi
 The Limit: EIRP ≤ 33dBm

Peak-to-average ratio (PAR)**20MHz Bandwidth**

Modulation	Low channel (dB)	Middle channel (dB)	High channel (dB)	PAR Limit (dB)	Result
QPSK (1RB Size)	4.33	4.65	4.68	13	Pass
QPSK (100RB Size)	5.54	5.64	5.71	13	Pass
16QAM (1RB Size)	5.13	5.67	5.80	13	Pass
16QAM (100RB Size)	6.41	6.51	6.57	13	Pass

LTE Band 4

Bandwidth (MHz)	Modulation	RB size/ RB Offset	Conducted Average Output Power (dBm)			EIRP(dBm)		
			Low	Mid	High	Low	Mid	High
1.4	QPSK	RB1#0	11.57	11.83	11.61	11.77	12.03	11.81
		RB1#2	11.63	11.81	11.99	11.83	12.01	12.19
		RB1#5	12.27	12.10	11.55	12.47	12.3	11.75
		RB3#0	11.93	12.06	11.91	12.13	12.26	12.11
		RB3#1	11.95	11.96	11.73	12.15	12.16	11.93
		RB3#2	11.66	11.77	11.90	11.86	11.97	12.1
		RB6#0	11.99	11.76	12.11	12.19	11.96	12.31
	16QAM	RB1#0	11.57	11.73	11.71	11.77	11.93	11.91
		RB1#2	11.70	12.29	12.04	11.9	12.49	12.24
		RB1#5	11.78	11.73	12.20	11.98	11.93	12.4
		RB3#0	11.77	11.68	12.17	11.97	11.88	12.37
		RB3#1	12.20	11.84	11.85	12.4	12.04	12.05
		RB3#2	12.04	11.59	11.78	12.24	11.79	11.98
		RB6#0	11.62	11.63	12.14	11.82	11.83	12.34
3.0	QPSK	RB1#0	11.60	12.08	12.19	11.8	12.28	12.39
		RB1#7	12.06	11.72	11.79	12.26	11.92	11.99
		RB1#14	11.58	12.21	11.82	11.78	12.41	12.02
		RB8#0	12.26	12.11	11.56	12.46	12.31	11.76
		RB8#4	11.51	11.78	12.07	11.71	11.98	12.27
		RB8#7	12.02	11.74	11.78	12.22	11.94	11.98
		RB15#0	12.02	12.29	11.58	12.22	12.49	11.78
	16QAM	RB1#0	11.84	11.93	11.61	12.04	12.13	11.81
		RB1#7	11.74	12.03	11.64	11.94	12.23	11.84
		RB1#14	11.76	11.50	11.63	11.96	11.7	11.83
		RB8#0	11.65	11.59	11.57	11.85	11.79	11.77
		RB8#4	11.93	12.24	11.67	12.13	12.44	11.87
		RB8#7	11.62	12.03	12.21	11.82	12.23	12.41
		RB15#0	12.18	11.56	11.50	12.38	11.76	11.7

Bandwidth (MHz)	Modulation	RB size/ RB Offset	Conducted Average Output Power (dBm)			EIRP(dBm)		
			Low	Mid	High	Low	Mid	High
5.0	QPSK	RB1#0	12.05	12.24	11.60	12.25	12.44	11.8
		RB1#12	11.90	11.61	12.02	12.1	11.81	12.22
		RB1#24	11.67	11.68	12.18	11.87	11.88	12.38
		RB12#0	12.09	12.15	12.25	12.29	12.35	12.45
		RB12#6	12.00	11.54	11.92	12.2	11.74	12.12
		RB12#11	12.06	11.96	11.83	12.26	12.16	12.03
		RB25#0	11.98	11.76	12.17	12.18	11.96	12.37
	16QAM	RB1#0	11.57	11.88	12.09	11.77	12.08	12.29
		RB1#12	11.50	11.61	11.89	11.7	11.81	12.09
		RB1#24	11.69	11.74	12.02	11.89	11.94	12.22
		RB12#0	12.20	11.67	11.93	12.4	11.87	12.13
		RB12#6	11.85	12.05	11.86	12.05	12.25	12.06
		RB12#11	11.59	11.80	11.51	11.79	12	11.71
		RB25#0	11.60	11.59	12.14	11.8	11.79	12.34
10.0	QPSK	RB1#0	12.11	11.62	12.16	12.31	11.82	12.36
		RB1#24	12.07	11.54	11.78	12.27	11.74	11.98
		RB1#49	11.88	11.59	11.99	12.08	11.79	12.19
		RB25#0	11.56	11.72	11.96	11.76	11.92	12.16
		RB25#12	11.89	12.05	12.02	12.09	12.25	12.22
		RB25#24	12.06	11.80	11.80	12.26	12	12
		RB50#0	11.64	12.26	11.65	11.84	12.46	11.85
	16QAM	RB1#0	12.25	11.51	12.29	12.45	11.71	12.49
		RB1#24	12.20	11.64	12.30	12.4	11.84	12.5
		RB1#49	11.96	12.17	11.55	12.16	12.37	11.75
		RB25#0	12.07	11.66	12.23	12.27	11.86	12.43
		RB25#12	12.15	11.67	11.80	12.35	11.87	12
		RB25#24	12.04	12.25	12.21	12.24	12.45	12.41
		RB50#0	11.79	11.94	11.58	11.99	12.14	11.78

Bandwidth (MHz)	Modulation	RB size/ RB Offset	Conducted Average Output Power (dBm)			EIRP(dBm)		
			Low	Mid	High	Low	Mid	High
15.0	QPSK	RB1#0	11.97	11.75	11.62	12.17	11.95	11.82
		RB1#37	11.90	12.06	12.04	12.1	12.26	12.24
		RB1#74	11.89	11.63	11.71	12.09	11.83	11.91
		RB36#0	12.27	11.57	12.18	12.47	11.77	12.38
		RB36#18	11.84	11.90	11.91	12.04	12.1	12.11
		RB36#37	12.27	11.50	11.70	12.47	11.7	11.9
		RB75#0	11.93	11.77	11.79	12.13	11.97	11.99
	16QAM	RB1#0	11.92	11.91	11.53	12.12	12.11	11.73
		RB1#37	11.82	11.70	11.84	12.02	11.9	12.04
		RB1#74	12.05	11.70	12.29	12.25	11.9	12.49
		RB36#0	11.99	11.98	11.61	12.19	12.18	11.81
		RB36#18	12.17	12.14	11.52	12.37	12.34	11.72
		RB36#37	12.29	11.91	11.50	12.49	12.11	11.7
		RB75#0	11.67	11.86	11.58	11.87	12.06	11.78
20.0	QPSK	RB1#0	12.07	12.01	11.70	12.27	12.21	11.9
		RB1#49	11.57	11.56	12.06	11.77	11.76	12.26
		RB1#99	11.56	12.08	11.83	11.76	12.28	12.03
		RB50#0	11.78	11.85	11.52	11.98	12.05	11.72
		RB50#24	11.73	11.77	12.11	11.93	11.97	12.31
		RB50#49	11.57	12.23	11.58	11.77	12.43	11.78
		RB100#0	12.02	11.61	12.26	12.22	11.81	12.46
	16QAM	RB1#0	11.71	11.66	11.60	11.91	11.86	11.8
		RB1#49	11.97	11.70	12.27	12.17	11.9	12.47
		RB1#99	11.95	11.55	11.63	12.15	11.75	11.83
		RB50#0	11.70	12.18	11.66	11.9	12.38	11.86
		RB50#24	11.84	11.99	11.96	12.04	12.19	12.16
		RB50#49	11.76	11.65	11.61	11.96	11.85	11.81
		RB100#0	11.50	12.21	12.06	11.7	12.41	12.26

Note: EIRP(dBm) = Conducted Power(dBm) + Antenna Gain(dBi)
 For LTE Band 4: Antenna Gain = 0.2dBi
 The Limit: EIRP≤30dBm

Peak-to-average ratio (PAR)**20MHz Bandwidth**

Modulation	Low channel (dB)	Middle channel (dB)	High channel (dB)	PAR Limit (dB)	Result
QPSK (1RB Size)	3.91	4.17	4.33	13	Pass
QPSK (100RB Size)	5.64	5.61	5.54	13	Pass
16QAM (1RB Size)	4.62	5.03	5.13	13	Pass
16QAM (100RB Size)	6.41	6.47	6.41	13	Pass

LTE Band 5:

Maximum Output Power

Bandwidth (MHz)	Modulation	RB size/ RB Offset	Conducted Average Output Power (dBm)			ERP(dBm)		
			Low	Mid	High	Low	Mid	High
1.4	QPSK	RB1#0	23.78	23.87	23.80	19.53	19.62	19.55
		RB1#2	23.81	23.91	23.88	19.56	19.66	19.63
		RB1#5	23.77	23.88	23.80	19.52	19.63	19.55
		RB3#0	23.88	23.92	23.87	19.63	19.67	19.62
		RB3#1	23.86	23.92	23.91	19.61	19.67	19.66
		RB3#2	22.92	22.92	22.94	18.67	18.67	18.69
		RB6#0	22.76	22.90	22.81	18.51	18.65	18.56
	16QAM	RB1#0	23.06	23.05	23.24	18.81	18.8	18.99
		RB1#2	22.80	22.95	22.81	18.55	18.7	18.56
		RB1#5	22.78	22.89	22.81	18.53	18.64	18.56
		RB3#0	23.05	22.82	22.96	18.8	18.57	18.71
		RB3#1	23.05	22.85	22.94	18.8	18.6	18.69
		RB3#2	21.97	21.97	21.92	17.72	17.72	17.67
		RB6#0	21.52	21.42	21.61	17.27	17.17	17.36
3.0	QPSK	RB1#0	23.64	23.71	23.70	19.39	19.46	19.45
		RB1#7	23.71	23.83	23.78	19.46	19.58	19.53
		RB1#14	23.65	23.76	23.71	19.4	19.51	19.46
		RB8#0	22.81	22.78	22.86	18.56	18.53	18.61
		RB8#4	22.85	22.83	22.85	18.6	18.58	18.6
		RB8#7	22.85	22.87	22.86	18.6	18.62	18.61
		RB15#0	22.17	22.14	22.23	17.92	17.89	17.98
	16QAM	RB1#0	23.21	22.72	22.67	18.96	18.47	18.42
		RB1#7	23.23	22.87	22.76	18.98	18.62	18.51
		RB1#14	23.17	22.77	22.68	18.92	18.52	18.43
		RB8#0	21.92	21.85	21.85	17.67	17.6	17.6
		RB8#4	21.88	21.91	21.85	17.63	17.66	17.6
		RB8#7	21.91	21.84	21.93	17.66	17.59	17.68
		RB15#0	21.31	21.27	21.34	17.06	17.02	17.09

Bandwidth (MHz)	Modulation	RB size/ RB Offset	Conducted Average Output Power (dBm)			ERP(dBm)		
			Low	Mid	High	Low	Mid	High
5.0	QPSK	RB1#0	23.97	23.93	23.94	19.72	19.68	19.69
		RB1#12	24.02	24.09	24.06	19.77	19.84	19.81
		RB1#24	23.90	24.03	23.93	19.65	19.78	19.68
		RB12#0	22.90	22.94	22.98	18.65	18.69	18.73
		RB12#6	22.95	22.95	22.97	18.7	18.7	18.72
		RB12#11	22.93	22.95	22.97	18.68	18.7	18.72
		RB25#0	23.08	23.16	23.04	18.83	18.91	18.79
	16QAM	RB1#0	22.82	23.16	23.00	18.57	18.91	18.75
		RB1#12	22.92	23.25	23.13	18.67	19	18.88
		RB1#24	22.81	23.18	22.98	18.56	18.93	18.73
		RB12#0	21.95	21.93	21.98	17.7	17.68	17.73
		RB12#6	21.99	21.93	22.03	17.74	17.68	17.78
		RB12#11	22.02	21.99	22.03	17.77	17.74	17.78
		RB25#0	22.61	22.56	22.57	18.36	18.31	18.32
10.0	QPSK	RB1#0	23.94	23.91	24.03	19.69	19.66	19.78
		RB1#24	23.93	24.05	24.02	19.68	19.8	19.77
		RB1#49	23.93	24.00	23.99	19.68	19.75	19.74
		RB25#0	22.85	22.95	22.93	18.6	18.7	18.68
		RB25#12	22.93	22.90	22.98	18.68	18.65	18.73
		RB25#24	22.95	22.96	22.98	18.7	18.71	18.73
		RB50#0	22.22	22.18	22.31	17.97	17.93	18.06
	16QAM	RB1#0	23.47	23.04	23.37	19.22	18.79	19.12
		RB1#24	23.56	23.08	23.46	19.31	18.83	19.21
		RB1#49	23.39	23.09	23.29	19.14	18.84	19.04
		RB25#0	21.93	22.04	21.83	17.68	17.79	17.58
		RB25#12	22.02	21.99	21.92	17.77	17.74	17.67
		RB25#24	21.91	22.01	21.81	17.66	17.76	17.56
		RB50#0	21.5	21.89	21.40	17.25	17.64	17.15

Note: ERP(dBm) = Conducted Power(dBm) + Antenna Gain(dBd)
 For LTE Band 5: Antenna Gain = -2.1dBi = -4.25dBd (0dBd=2.15dBi)
 Limit: ERP ≤ 38.45dBm

Peak-to-average ratio (PAR)**10MHz bandwidth**

Modulation	Low channel (dB)	Middle channel (dB)	High channel (dB)	PAR Limit (dB)	Result
QPSK (1RB Size)	4.10	4.10	3.43	13	Pass
QPSK (50RB Size)	5.58	5.58	5.61	13	Pass
16QAM (1RB Size)	5.03	4.87	4.46	13	Pass
16QAM (50RB Size)	6.41	6.31	6.47	13	Pass

LTE Band 7:

Maximum Output Power

Bandwidth (MHz)	Modulation	RB size/ RB Offset	Conducted Average Output Power (dBm)			EIRP(dBm)		
			Low	Mid	High	Low	Mid	High
5.0	QPSK	RB1#0	13.93	14.45	14.15	14.43	14.95	14.65
		RB1#12	14.22	14.30	14.61	14.72	14.8	15.11
		RB1#24	13.97	14.16	14.32	14.47	14.66	14.82
		RB12#0	14.43	14.03	14.26	14.93	14.53	14.76
		RB12#6	13.98	13.91	14.25	14.48	14.41	14.75
		RB12#11	14.13	14.06	14.11	14.63	14.56	14.61
		RB25#0	14.20	14.48	14.13	14.7	14.98	14.63
	16QAM	RB1#0	14.22	14.64	14.48	14.72	15.14	14.98
		RB1#12	14.60	14.45	14.06	15.1	14.95	14.56
		RB1#24	14.32	14.45	14.16	14.82	14.95	14.66
		RB12#0	13.86	14.27	13.88	14.36	14.77	14.38
		RB12#6	14.00	14.09	14.02	14.5	14.59	14.52
		RB12#11	14.27	13.98	14.38	14.77	14.48	14.88
		RB25#0	14.56	14.26	13.94	15.06	14.76	14.44
10.0	QPSK	RB1#0	14.01	14.55	14.65	14.51	15.05	15.15
		RB1#24	14.63	13.87	14.18	15.13	14.37	14.68
		RB1#49	14.31	14.31	14.16	14.81	14.81	14.66
		RB25#0	14.61	14.38	14.03	15.11	14.88	14.53
		RB25#12	13.87	13.89	14.57	14.37	14.39	15.07
		RB25#24	14.53	13.92	14.52	15.03	14.42	15.02
		RB50#0	13.94	14.18	14.44	14.44	14.68	14.94
	16QAM	RB1#0	13.94	13.99	14.60	14.44	14.49	15.1
		RB1#24	14.00	14.10	14.54	14.5	14.6	15.04
		RB1#49	14.62	14.06	14.24	15.12	14.56	14.74
		RB25#0	13.85	14.20	13.91	14.35	14.7	14.41
		RB25#12	14.31	14.21	14.48	14.81	14.71	14.98
		RB25#24	14.05	14.18	14.30	14.55	14.68	14.8
		RB50#0	14.02	14.01	13.86	14.52	14.51	14.36

Bandwidth (MHz)	Modulation	RB size/ RB Offset	Conducted Average Output Power (dBm)			EIRP(dBm)		
			Low	Mid	High	Low	Mid	High
15.0	QPSK	RB1#0	14.64	14.08	14.45	15.14	14.58	14.95
		RB1#37	14.39	14.07	14.43	14.89	14.57	14.93
		RB1#74	14.29	14.18	14.03	14.79	14.68	14.53
		RB36#0	14.28	14.17	14.00	14.78	14.67	14.5
		RB36#18	14.23	14.05	14.41	14.73	14.55	14.91
		RB36#37	14.05	14.28	14.04	14.55	14.78	14.54
		RB75#0	14.24	14.41	14.40	14.74	14.91	14.9
	16QAM	RB1#0	14.59	14.36	14.06	15.09	14.86	14.56
		RB1#37	14.02	13.99	14.51	14.52	14.49	15.01
		RB1#74	14.11	14.53	14.04	14.61	15.03	14.54
		RB36#0	14.17	14.36	13.90	14.67	14.86	14.4
		RB36#18	14.05	13.98	14.57	14.55	14.48	15.07
		RB36#37	14.32	13.95	14.00	14.82	14.45	14.5
		RB75#0	14.36	14.06	14.23	14.86	14.56	14.73
20.0	QPSK	RB1#0	14.61	13.93	14.59	15.11	14.43	15.09
		RB1#49	14.19	14.54	14.09	14.69	15.04	14.59
		RB1#99	14.11	14.55	14.49	14.61	15.05	14.99
		RB50#0	14.03	14.50	14.25	14.53	15	14.75
		RB50#24	13.98	14.27	14.23	14.48	14.77	14.73
		RB50#49	14.45	13.87	14.08	14.95	14.37	14.58
		RB100#0	14.17	14.42	14.46	14.67	14.92	14.96
	16QAM	RB1#0	14.58	14.46	14.37	15.08	14.96	14.87
		RB1#49	14.36	14.60	13.86	14.86	15.1	14.36
		RB1#99	14.36	14.04	14.58	14.86	14.54	15.08
		RB50#0	14.43	14.26	14.56	14.93	14.76	15.06
		RB50#24	14.37	13.95	13.89	14.87	14.45	14.39
		RB50#49	14.44	14.51	14.65	14.94	15.01	15.15
		RB100#0	14.30	14.28	14.19	14.8	14.78	14.69

Note: ERP(dBm) = Conducted Power(dBm) + Antenna Gain(dBi)
 For LTE Band7: Antenna Gain = 0.5dBi
 Limit: EIRP ≤ 33dBm

Peak-to-average ratio (PAR)**20MHz bandwidth**

Modulation	Low channel (dB)	Middle channel (dB)	High channel (dB)	PAR Limit (dB)	Result
QPSK (1RB Size)	3.65	3.40	3.30	13	Pass
QPSK (100RB Size)	5.58	5.51	5.54	13	Pass
16QAM (1RB Size)	4.78	4.39	4.10	13	Pass
16QAM (100RB Size)	6.51	6.31	6.38	13	Pass

LTE Band 17:

Maximum Output Power

Bandwidth (MHz)	Modulation	RB size/ RB Offset	Conducted Average Output Power (dBm)			EIRP(dBm)		
			Low	Mid	High	Low	Mid	High
5.0	QPSK	RB1#0	23.33	23.35	23.36	19.08	19.10	19.11
		RB1#12	23.42	23.44	23.43	19.17	19.19	19.18
		RB1#24	23.37	23.36	23.31	19.12	19.11	19.06
		RB12#0	22.23	22.34	22.42	17.98	18.09	18.17
		RB12#6	22.37	22.28	22.37	18.12	18.03	18.12
		RB12#11	22.35	22.31	22.37	18.1	18.06	18.12
		RB25#0	22.69	22.73	22.77	18.44	18.48	18.52
	16QAM	RB1#0	22.26	22.63	22.39	18.01	18.38	18.14
		RB1#12	22.30	22.70	22.48	18.05	18.45	18.23
		RB1#24	22.26	22.61	22.36	18.01	18.36	18.11
		RB12#0	21.28	21.29	21.49	17.03	17.04	17.24
		RB12#6	21.43	21.26	21.38	17.18	17.01	17.13
		RB12#11	21.40	21.32	21.42	17.15	17.07	17.17
		RB25#0	21.36	21.13	21.37	17.11	16.88	17.12
10.0	QPSK	RB1#0	23.31	23.32	23.32	19.06	19.07	19.07
		RB1#24	23.40	23.44	23.42	19.15	19.19	19.17
		RB1#49	23.34	23.35	23.36	19.09	19.10	19.11
		RB25#0	22.18	22.21	22.29	17.93	17.96	18.04
		RB25#12	22.23	22.26	22.24	17.98	18.01	17.99
		RB25#24	22.25	22.21	22.36	18.00	17.96	18.11
		RB50#0	22.38	22.36	22.46	18.13	18.11	18.21
	16QAM	RB1#0	22.91	22.46	22.32	18.66	18.21	18.07
		RB1#24	22.96	22.55	22.42	18.71	18.3	18.17
		RB1#49	22.88	22.48	22.34	18.63	18.23	18.09
		RB25#0	21.23	21.24	21.38	16.98	16.99	17.13
		RB25#12	21.29	21.27	21.36	17.04	17.02	17.11
		RB25#24	21.27	21.26	21.33	17.02	17.01	17.08
		RB50#0	21.08	21.06	21.16	16.83	16.81	16.91

Note: ERP(dBm) = Conducted Power(dBm) + Antenna Gain(dBd)
 For LTE Band17: Antenna Gain = -2.1dBi = -4.25dBd (0dBd=2.15dBi)
 Limit: ERP ≤ 34.77dBm

Peak-to-average ratio (PAR)**10MHz bandwidth**

Modulation	Low channel (dB)	Middle channel (dB)	High channel (dB)	PAR Limit (dB)	Result
QPSK (1RB Size)	5.32	5.45	4.84	13	Pass
QPSK (50RB Size)	5.64	5.54	5.61	13	Pass
16QAM (1RB Size)	6.54	6.51	5.90	13	Pass
16QAM (50RB Size)	6.35	6.41	6.44	13	Pass

LTE Band 38

Maximum Output Power

Bandwidth (MHz)	Modulation	RB size/ RB Offset	Conducted Average Output Power (dBm)			EIRP (dBm)		
			Low	Mid	High	Low	Mid	High
5.0	QPSK	RB1#0	22.99	23.06	23.17	23.49	23.56	23.67
		RB1#12	23.09	23.16	23.28	23.59	23.66	23.78
		RB1#24	23.06	23.09	23.18	23.56	23.59	23.68
		RB12#0	21.96	22.04	22.16	22.46	22.54	22.66
		RB12#6	22.01	22.09	22.20	22.51	22.59	22.7
		RB12#11	21.95	22.08	22.14	22.45	22.58	22.64
		RB25#0	21.91	22.06	22.17	22.41	22.56	22.67
	16QAM	RB1#0	22.17	22.02	22.15	22.67	22.52	22.65
		RB1#12	22.29	22.14	22.24	22.79	22.64	22.74
		RB1#24	22.25	22.08	22.14	22.75	22.58	22.64
		RB12#0	20.98	21.00	21.15	21.48	21.5	21.65
		RB12#6	21.02	20.99	21.17	21.52	21.49	21.67
		RB12#11	20.96	21.11	21.21	21.46	21.61	21.71
		RB25#0	20.89	21.16	21.28	21.39	21.66	21.78
10.0	QPSK	RB1#0	22.94	23.11	23.22	23.44	23.61	23.72
		RB1#24	23.08	23.19	23.26	23.58	23.69	23.76
		RB1#49	23.02	23.16	23.24	23.52	23.66	23.74
		RB25#0	21.96	22.10	22.16	22.46	22.6	22.66
		RB25#12	22.01	22.12	22.15	22.51	22.62	22.65
		RB25#24	21.98	22.13	22.16	22.48	22.63	22.66
		RB50#0	21.82	22.06	22.12	22.32	22.56	22.62
	16QAM	RB1#0	22.12	21.96	22.22	22.62	22.46	22.72
		RB1#24	22.23	22.07	22.29	22.73	22.57	22.79
		RB1#49	22.19	22.07	22.22	22.69	22.57	22.72
		RB25#0	20.93	21.14	21.16	21.43	21.64	21.66
		RB25#12	20.99	21.12	21.18	21.49	21.62	21.68
		RB25#24	20.97	21.11	21.21	21.47	21.61	21.71
		RB50#0	20.88	21.19	21.26	21.38	21.69	21.76

Bandwidth (MHz)	Modulation	RB size/ RB Offset	Conducted Average Output Power (dBm)			EIRP(dBm)		
			Low	Mid	High	Low	Mid	High
15.0	QPSK	RB1#0	22.96	23.07	23.19	23.46	23.57	23.69
		RB1#37	23.08	23.20	23.30	23.58	23.70	23.8
		RB1#74	23.04	23.16	23.19	23.54	23.66	23.69
		RB36#0	21.91	22.06	22.12	22.41	22.56	22.62
		RB36#18	21.97	22.10	22.12	22.47	22.6	22.62
		RB36#37	21.97	22.10	22.15	22.47	22.6	22.65
		RB75#0	21.61	21.85	21.92	22.11	22.35	22.42
	16QAM	RB1#0	22.15	21.97	22.32	22.65	22.47	22.82
		RB1#37	22.21	22.08	22.39	22.71	22.58	22.89
		RB1#74	22.21	22.05	22.31	22.71	22.55	22.81
		RB36#0	20.92	21.03	21.19	21.42	21.53	21.69
		RB36#18	20.96	21.06	21.18	21.46	21.56	21.68
		RB36#37	20.90	21.06	21.13	21.4	21.56	21.63
		RB75#0	20.63	21.10	21.18	21.13	21.6	21.68
20.0	QPSK	RB1#0	22.90	22.98	23.15	23.4	23.48	23.65
		RB1#49	23.09	23.20	23.35	23.59	23.7	23.85
		RB1#99	23.09	23.10	23.22	23.59	23.6	23.72
		RB50#0	21.93	22.15	22.17	22.43	22.65	22.67
		RB50#24	21.99	22.12	22.18	22.49	22.62	22.68
		RB50#49	21.95	22.10	22.13	22.45	22.6	22.63
		RB100#0	21.87	22.01	22.21	22.37	22.51	22.71
	16QAM	RB1#0	21.92	21.90	22.30	22.42	22.4	22.8
		RB1#49	22.12	22.16	22.49	22.62	22.66	22.99
		RB1#99	22.12	22.08	22.37	22.62	22.58	22.87
		RB50#0	20.90	21.20	21.17	21.4	21.7	21.67
		RB50#24	20.96	21.14	21.20	21.46	21.64	21.7
		RB50#49	20.94	21.11	21.12	21.44	21.61	21.62
		RB100#0	20.89	21.08	21.12	21.39	21.58	21.62

Note: EIRP(dBm) = Conducted Power(dBm) + Antenna Gain(dBi)
 For LTE Band38: Antenna Gain = 0.5dBi
 Limit: EIRP ≤ 33dBm

Peak-to-average ratio (PAR)**20MHz bandwidth**

Modulation	Low channel (dB)	Middle channel (dB)	High channel (dB)	PAR Limit (dB)	Result
QPSK (1RB Size)	4.07	4.23	3.72	13	Pass
QPSK (100RB Size)	5.35	5.51	5.32	13	Pass
16QAM (1RB Size)	5.00	5.00	4.71	13	Pass
16QAM (100RB Size)	6.19	6.31	6.22	13	Pass

LTE Band 41:

Maximum Output Power

Bandwidth (MHz)	Modulation	RB size/ RB Offset	Conducted Average Output Power (dBm)			EIRP(dBm)		
			Low	Mid	High	Low	Mid	High
5.0	QPSK	RB1#0	22.79	22.41	22.55	23.29	22.91	23.05
		RB1#12	22.87	22.43	22.74	23.37	22.93	23.24
		RB1#24	22.73	22.34	22.70	23.23	22.84	23.2
		RB12#0	21.70	21.30	21.50	22.2	21.8	22.00
		RB12#6	21.79	21.35	21.57	22.29	21.85	22.07
		RB12#11	21.74	21.32	21.56	22.24	21.82	22.06
		RB25#0	21.28	21.16	21.24	21.78	21.66	21.74
	16QAM	RB1#0	21.75	21.38	21.62	22.25	21.88	22.12
		RB1#12	21.84	21.43	21.76	22.34	21.93	22.26
		RB1#24	21.74	21.34	21.70	22.24	21.84	22.2
		RB12#0	20.60	20.27	20.52	21.1	20.77	21.02
		RB12#6	20.72	20.33	20.60	21.22	20.83	21.1
		RB12#11	20.77	20.36	20.55	21.27	20.86	21.05
		RB25#0	20.61	20.56	20.57	21.11	21.06	21.07
10.0	QPSK	RB1#0	22.80	22.39	22.49	23.3	22.89	22.99
		RB1#24	22.81	22.47	22.61	23.31	22.97	23.11
		RB1#49	22.72	22.39	22.70	23.22	22.89	23.2
		RB25#0	21.63	21.28	21.46	22.13	21.78	21.96
		RB25#12	21.85	21.35	21.56	22.35	21.85	22.06
		RB25#24	21.75	21.34	21.54	22.25	21.84	22.04
		RB50#0	21.22	21.18	21.31	21.72	21.68	21.81
	16QAM	RB1#0	21.97	21.23	21.47	22.47	21.73	21.97
		RB1#24	21.94	21.30	21.56	22.44	21.8	22.06
		RB1#49	21.85	21.20	21.55	22.35	21.7	22.05
		RB25#0	20.64	20.33	20.48	21.14	20.83	20.98
		RB25#12	20.82	20.35	20.60	21.32	20.85	21.1
		RB25#24	20.73	20.33	20.52	21.23	20.83	21.02
		RB50#0	20.50	20.49	20.43	21	20.99	20.93

Bandwidth (MHz)	Modulation	RB size/ RB Offset	Conducted Average Output Power (dBm)			EIRP(dBm)		
			Low	Mid	High	Low	Mid	High
15.0	QPSK	RB1#0	22.77	22.36	22.41	23.27	22.86	22.91
		RB1#37	22.77	22.43	22.61	23.27	22.93	23.11
		RB1#74	22.69	22.35	22.74	23.19	22.85	23.24
		RB36#0	21.61	21.26	21.44	22.11	21.76	21.94
		RB36#18	21.75	21.32	21.57	22.25	21.82	22.07
		RB36#37	21.73	21.32	21.54	22.23	21.82	22.04
		RB75#0	21.21	21.25	21.30	21.71	21.75	21.8
	16QAM	RB1#0	21.89	21.25	21.52	22.39	21.75	22.02
		RB1#37	21.91	21.30	21.70	22.41	21.8	22.2
		RB1#74	21.82	21.21	21.69	22.32	21.71	22.19
		RB36#0	20.59	20.21	20.47	21.09	20.71	20.97
		RB36#18	20.74	20.27	20.56	21.24	20.77	21.06
		RB36#37	20.66	20.26	20.44	21.16	20.76	20.94
		RB75#0	20.13	20.10	20.18	20.63	20.6	20.68
20.0	QPSK	RB1#0	22.45	22.23	22.49	22.95	22.73	22.99
		RB1#49	22.59	22.44	22.82	23.09	22.94	23.32
		RB1#99	22.37	22.31	22.88	22.87	22.81	23.38
		RB50#0	21.31	21.27	21.71	21.81	21.77	22.21
		RB50#24	21.65	21.45	21.77	22.15	21.95	22.27
		RB50#49	21.51	21.37	21.70	22.01	21.87	22.2
		RB100#0	21.27	21.31	21.21	21.77	21.81	21.71
	16QAM	RB1#0	21.56	21.23	21.62	22.06	21.73	22.12
		RB1#49	21.65	21.40	21.94	22.15	21.9	22.44
		RB1#99	21.43	21.30	21.90	21.93	21.8	22.4
		RB50#0	20.27	20.35	20.66	20.77	20.85	21.16
		RB50#24	20.66	20.49	20.69	21.16	20.99	21.19
		RB50#49	20.49	20.36	20.65	20.99	20.86	21.15
		RB100#0	20.39	20.38	20.42	20.89	20.88	20.92

Note: ERP(dBm) = Conducted Power(dBm) + Antenna Gain(dBi)
 For LTE Band 41: Antenna Gain = 0.5dBi
 Limit: EIRP ≤ 33dBm

Peak-to-average ratio (PAR)**20MHz bandwidth**

Modulation	Low channel (dB)	Middle channel (dB)	High channel (dB)	PAR Limit (dB)	Result
QPSK (1RB Size)	4.41	5.08	4.59	13	Pass
QPSK (100RB Size)	4.85	5.11	6.82	13	Pass
16QAM (1RB Size)	6.85	6.78	6.35	13	Pass
16QAM (100RB Size)	5.33	5.46	5.98	13	Pass

LTE Band 66:

Maximum Output Power

Bandwidth (MHz)	Modulation	RB size/ RB Offset	Conducted Average Output Power (dBm)			EIRP(dBm)		
			Low	Mid	High	Low	Mid	High
1.4	QPSK	RB1#0	17.49	17.08	17.47	17.69	17.28	17.67
		RB1#2	17.17	17.65	17.00	17.37	17.85	17.2
		RB1#5	17.06	17.55	17.54	17.26	17.75	17.74
		RB3#0	17.01	17.45	17.12	17.21	17.65	17.32
		RB3#1	17.36	17.12	17.17	17.56	17.32	17.37
		RB3#2	17.66	17.41	17.13	17.86	17.61	17.33
		RB6#0	17.30	17.10	17.78	17.5	17.3	17.98
	16QAM	RB1#0	17.59	17.01	17.26	17.79	17.21	17.46
		RB1#2	17.72	17.18	17.26	17.92	17.38	17.46
		RB1#5	17.22	17.14	17.63	17.42	17.34	17.83
		RB3#0	17.27	17.58	17.71	17.47	17.78	17.91
		RB3#1	17.66	17.21	17.19	17.86	17.41	17.39
		RB3#2	17.66	17.25	17.17	17.86	17.45	17.37
		RB6#0	17.79	17.27	17.29	17.99	17.47	17.49
3.0	QPSK	RB1#0	17.55	17.33	17.29	17.75	17.53	17.49
		RB1#7	17.29	17.29	17.48	17.49	17.49	17.68
		RB1#14	17.70	17.68	17.66	17.9	17.88	17.86
		RB8#0	17.35	17.46	17.61	17.55	17.66	17.81
		RB8#4	17.26	17.27	17.26	17.46	17.47	17.46
		RB8#7	17.71	17.21	17.69	17.91	17.41	17.89
		RB15#0	17.50	17.00	17.53	17.7	17.2	17.73
	16QAM	RB1#0	17.25	17.17	17.50	17.45	17.37	17.7
		RB1#7	17.04	17.65	17.16	17.24	17.85	17.36
		RB1#14	17.69	17.72	17.58	17.89	17.92	17.78
		RB8#0	17.64	17.34	17.10	17.84	17.54	17.3
		RB8#4	17.09	17.10	17.30	17.29	17.3	17.5
		RB8#7	17.47	17.37	17.74	17.67	17.57	17.94
		RB15#0	17.56	17.15	17.01	17.76	17.35	17.21

Bandwidth (MHz)	Modulation	RB size/ RB Offset	Conducted Average Output Power (dBm)			EIRP(dBm)		
			Low	Mid	High	Low	Mid	High
5.0	QP SK	RB1#0	17.39	17.56	17.24	17.59	17.76	17.44
		RB1#12	17.67	17.33	17.53	17.87	17.53	17.73
		RB1#24	17.46	17.41	17.58	17.66	17.61	17.78
		RB12#0	17.58	17.65	17.14	17.78	17.85	17.34
		RB12#6	17.53	17.49	17.02	17.73	17.69	17.22
		RB12#11	17.67	17.52	17.26	17.87	17.72	17.46
		RB25#0	17.28	17.39	17.57	17.48	17.59	17.77
	16QAM	RB1#0	17.07	17.53	17.22	17.27	17.73	17.42
		RB1#12	17.01	17.68	17.16	17.21	17.88	17.36
		RB1#24	17.20	17.29	17.08	17.4	17.49	17.28
		RB12#0	17.24	17.05	17.66	17.44	17.25	17.86
		RB12#6	17.01	17.46	17.34	17.21	17.66	17.54
		RB12#11	17.16	17.35	17.28	17.36	17.55	17.48
		RB25#0	17.43	17.61	17.65	17.63	17.81	17.85
10.0	QPSK	RB1#0	17.18	17.64	17.57	17.38	17.84	17.77
		RB1#24	17.24	17.63	17.19	17.44	17.83	17.39
		RB1#49	17.14	17.32	17.50	17.34	17.52	17.7
		RB25#0	17.46	17.37	17.25	17.66	17.57	17.45
		RB25#12	17.55	17.06	17.63	17.75	17.26	17.83
		RB25#24	17.35	17.35	17.48	17.55	17.55	17.68
		RB50#0	17.36	17.05	17.30	17.56	17.25	17.5
	16QAM	RB1#0	17.12	17.42	17.48	17.32	17.62	17.68
		RB1#24	17.10	17.46	17.65	17.3	17.66	17.85
		RB1#49	17.07	17.24	17.36	17.27	17.44	17.56
		RB25#0	17.65	17.51	17.29	17.85	17.71	17.49
		RB25#12	17.03	17.47	17.50	17.23	17.67	17.7
		RB25#24	17.20	17.59	17.35	17.4	17.79	17.55
		RB50#0	17.34	17.14	17.31	17.54	17.34	17.51

Bandwidth (MHz)	Modulation	RB size/ RB Offset	Conducted Average Output Power (dBm)			EIRP(dBm)		
			Low	Mid	High	Low	Mid	High
15.0	QPSK	RB1#0	17.36	17.32	17.16	17.56	17.52	17.36
		RB1#37	17.17	17.52	17.51	17.37	17.72	17.71
		RB1#74	17.48	17.12	17.15	17.68	17.32	17.35
		RB36#0	17.37	17.32	17.40	17.57	17.52	17.6
		RB36#18	17.28	17.01	17.51	17.48	17.21	17.71
		RB36#37	17.41	17.15	17.13	17.61	17.35	17.33
		RB75#0	17.58	17.65	17.16	17.78	17.85	17.36
	16QAM	RB1#0	17.30	17.45	17.51	17.5	17.65	17.71
		RB1#37	17.05	17.70	17.00	17.25	17.9	17.2
		RB1#74	17.35	17.55	17.24	17.55	17.75	17.44
		RB36#0	17.39	17.55	17.61	17.59	17.75	17.81
		RB36#18	17.32	17.13	17.13	17.52	17.33	17.33
		RB36#37	17.18	17.60	17.67	17.38	17.8	17.87
		RB75#0	17.30	17.13	17.69	17.5	17.33	17.89
20.0	QPSK	RB1#0	17.21	17.43	17.06	17.41	17.63	17.26
		RB1#49	17.56	17.60	17.70	17.76	17.8	17.9
		RB1#99	17.14	17.67	17.05	17.34	17.87	17.25
		RB50#0	17.07	17.02	17.23	17.27	17.22	17.43
		RB50#24	17.64	17.01	17.35	17.84	17.21	17.55
		RB50#49	17.19	17.24	17.07	17.39	17.44	17.27
		RB100#0	17.39	17.51	17.15	17.59	17.71	17.35
	16QAM	RB1#0	17.68	17.63	17.49	17.88	17.83	17.69
		RB1#49	17.65	17.41	17.21	17.85	17.61	17.41
		RB1#99	17.37	17.04	17.40	17.57	17.24	17.6
		RB50#0	17.15	17.12	17.31	17.35	17.32	17.51
		RB50#24	17.59	17.55	17.32	17.79	17.75	17.52
		RB50#49	17.58	17.65	17.41	17.78	17.85	17.61
		RB100#0	17.55	17.33	17.33	17.75	17.53	17.53

Note: EIRP(dBm) = Conducted Power(dBm) + Antenna Gain(dBi)
 For LTE Band 66: Antenna Gain = 0.2dBi
 The Limit: EIRP ≤ 30dBm

Peak-to-average ratio (PAR)**20MHz bandwidth**

Modulation	Low channel (dB)	Middle channel (dB)	High channel (dB)	PAR Limit (dB)	Result
QPSK (1RB Size)	3.69	4.26	4.29	13	Pass
QPSK (100RB Size)	5.58	5.38	5.38	13	Pass
16QAM (1RB Size)	6.67	5.61	4.75	13	Pass
16QAM (100RB Size)	6.38	6.28	6.45	13	Pass

FCC §2.1049, §22.917, §22.905 & §24.238 & §27.53 - OCCUPIED BANDWIDTH

Applicable Standard

FCC 47 §2.1049, §22.917, §22.905, §24.238 and §27.53.

Test Procedure

The RF output of the transmitter was connected to the simulator and the spectrum analyzer through sufficient attenuation.

The resolution bandwidth of the spectrum analyzer was set at 1% to 5% of the anticipated emission bandwidth and the 26 dB & 99% bandwidth was recorded.

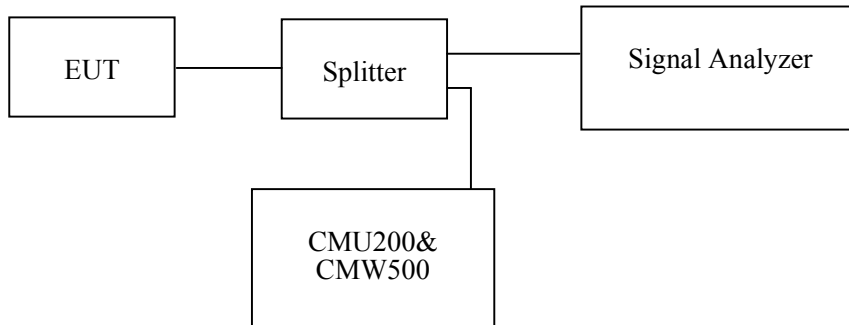

Test Data

Environmental Conditions

Temperature:	24~26.5 °C
Relative Humidity:	54~56 %
ATM Pressure:	100.0~101.0 kPa

The testing was performed by Black Chen from 2021-03-07 to 2021-03-11.

EUT operation mode: Transmitting

Test Result: Pass

Please refer to the following tables and plots.

Cellular Band (Part 22H)

Mode	Channel	Frequency (MHz)	99% Occupied Bandwidth (kHz)	26 dB Emission Bandwidth (kHz)
GSM(GMSK)	128	824.2	244	316.94
	190	836.6	244	318.40
	251	848.8	248	320.04
EGPRS(8PSK)	128	824.2	244	307.47
	190	836.6	246	308.55
	251	848.8	242	311.65

	Frequency (MHz)	Occupied Bandwidth (MHz)	26dB Bandwidth (MHz)
RMC	826.4	4.16	4.72
	836.6	4.18	4.73
	846.6	4.18	4.71
HSDPA	826.4	4.16	4.71
	836.6	4.16	4.73
	846.6	4.16	4.73
HSUPA	826.4	4.16	4.72
	836.6	4.18	4.71
	846.6	4.18	4.71

PCS Band (Part 24E)

Mode	Channel	Frequency (MHz)	99% Occupied Bandwidth (kHz)	26 dB Emission Bandwidth (kHz)
GSM(GMSK)	512	1850.2	242	314.42
	661	1880.0	244	315.33
	810	1909.8	246	314.37
EGPRS(8PSK)	512	1850.2	248	312.05
	661	1880.0	244	303.90
	810	1909.8	246	310.13

Frequency (MHz)		Occupied Bandwidth (MHz)	26dB Bandwidth (MHz)
RMC	1852.4	4.18	4.75
	1880.0	4.18	4.73
	1907.6	4.18	4.71
HSDPA	1852.4	4.18	4.74
	1880.0	4.18	4.77
	1907.6	4.18	4.75
HSUPA	1852.4	4.18	4.72
	1880.0	4.18	4.74
	1907.6	4.18	4.73

AWS Band (Part 27)

Frequency (MHz)		Occupied Bandwidth (MHz)	26dB Bandwidth (MHz)
RMC	1712.4	4.16	4.73
	1732.6	4.16	4.72
	1752.6	4.18	4.7
HSDPA	1712.4	4.18	4.73
	1732.6	4.18	4.71
	1752.6	4.16	4.71
HSUPA	1712.4	4.16	4.72
	1732.6	4.16	4.72
	1752.6	4.16	4.71

Cellular Band (Part 22H)

26 dB Emissions & 99% Occupied Bandwidth for GSM (GMSK) Mode, Low channel

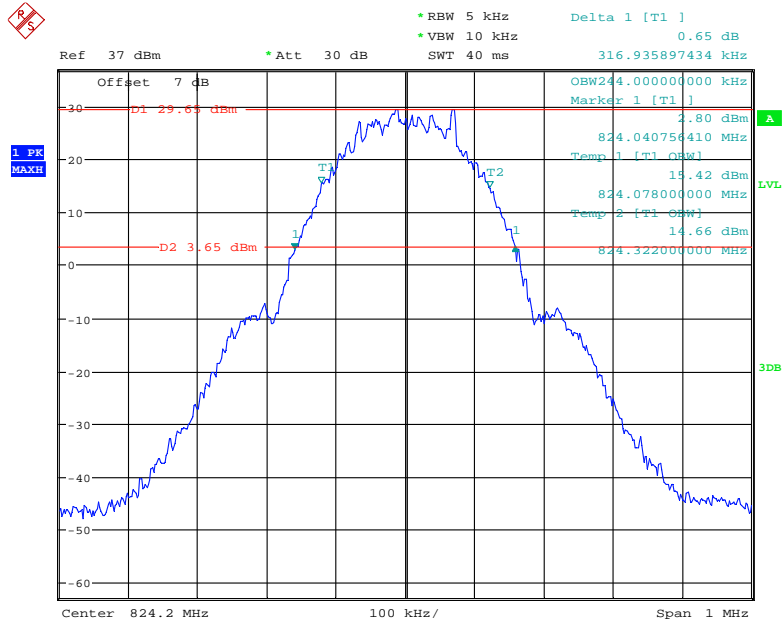

Date: 11.MAR.2021 09:48:24

26 dB Emissions & 99% Occupied Bandwidth for GSM (GMSK) Mode, Middle channel

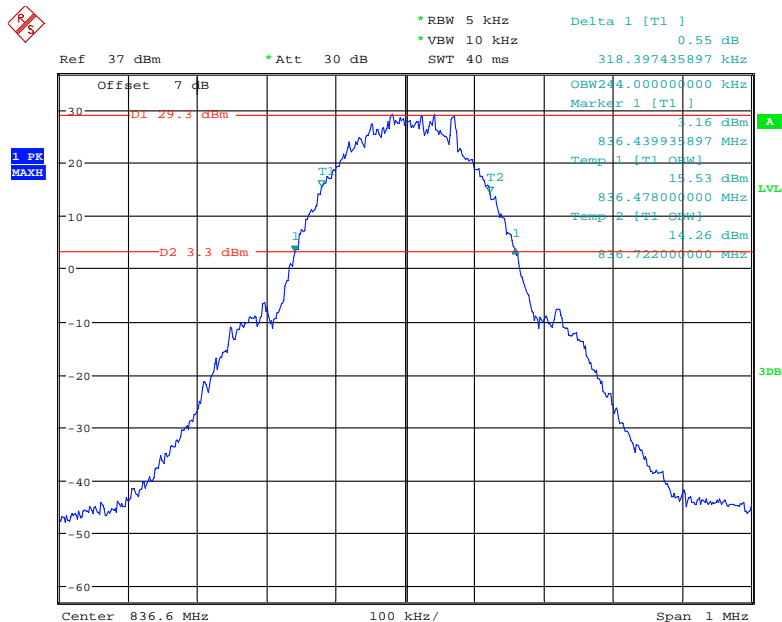

Date: 11.MAR.2021 09:47:02

26 dB Emissions & 99% Occupied Bandwidth for GSM (GMSK) Mode, High channel

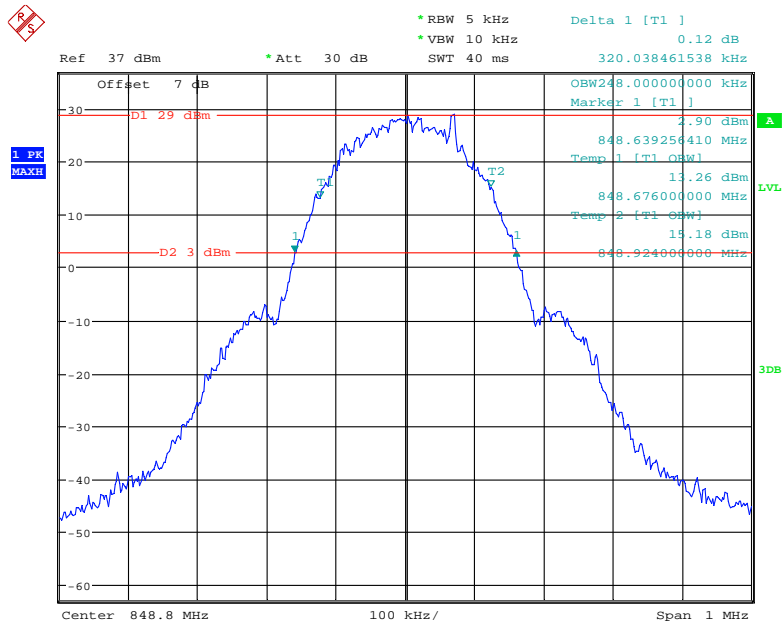

Date: 11.MAR.2021 09:45:07

26 dB Emissions & 99% Occupied Bandwidth for EGPRS (8PSK) Mode, Low channel

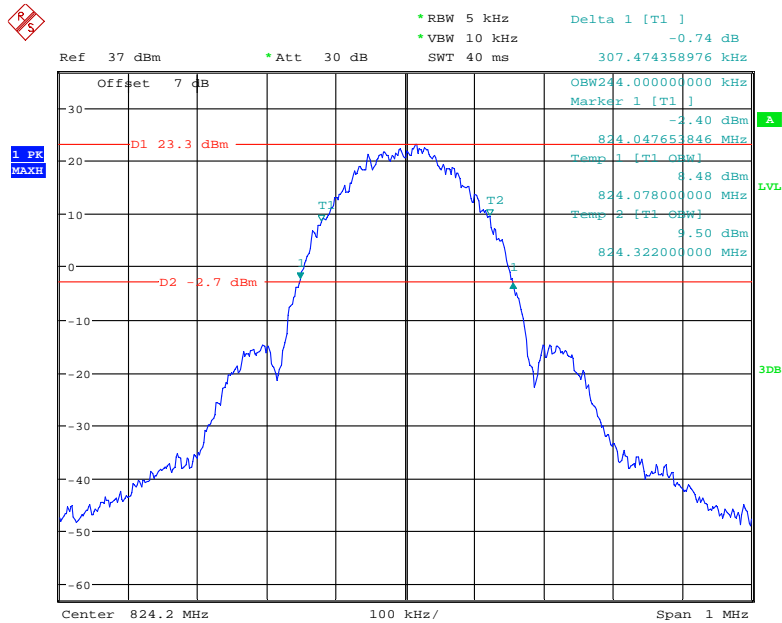

Date: 11.MAR.2021 09:39:06

26 dB Emissions & 99% Occupied Bandwidth for EGPRS (8PSK) Mode, Middle channel

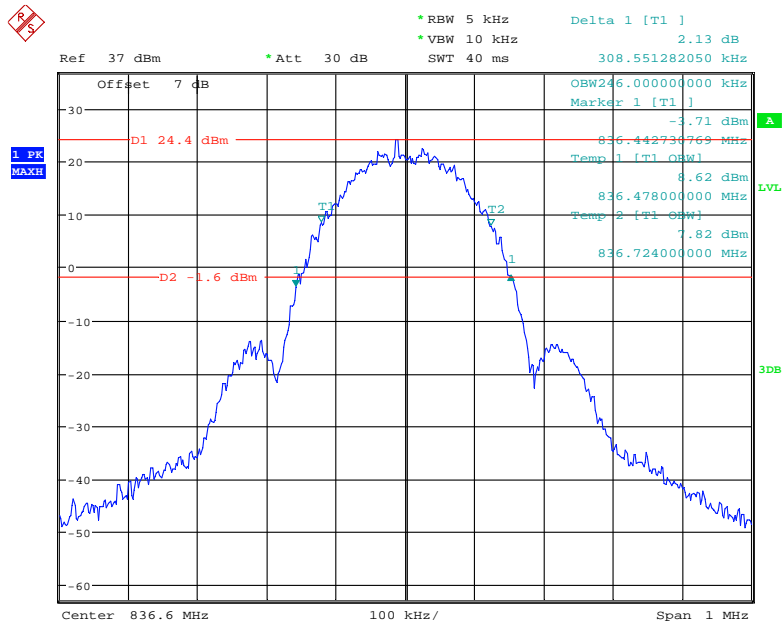

Date: 11.MAR.2021 09:41:01

26 dB Emissions & 99% Occupied Bandwidth for EGPRS (8PSK) Mode, High channel

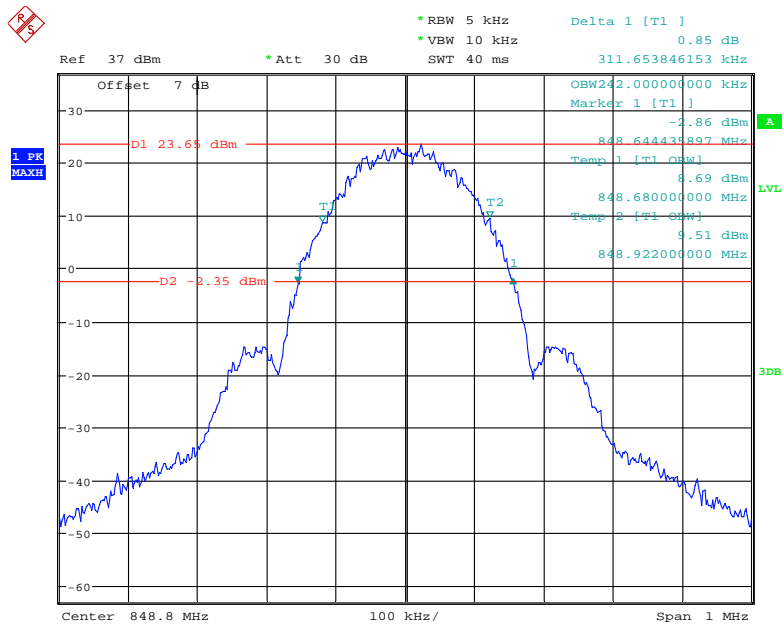

Date: 11.MAR.2021 09:42:51

26 dB Emissions & 99% Occupied Bandwidth for RMC (BPSK) Mode, Low channel

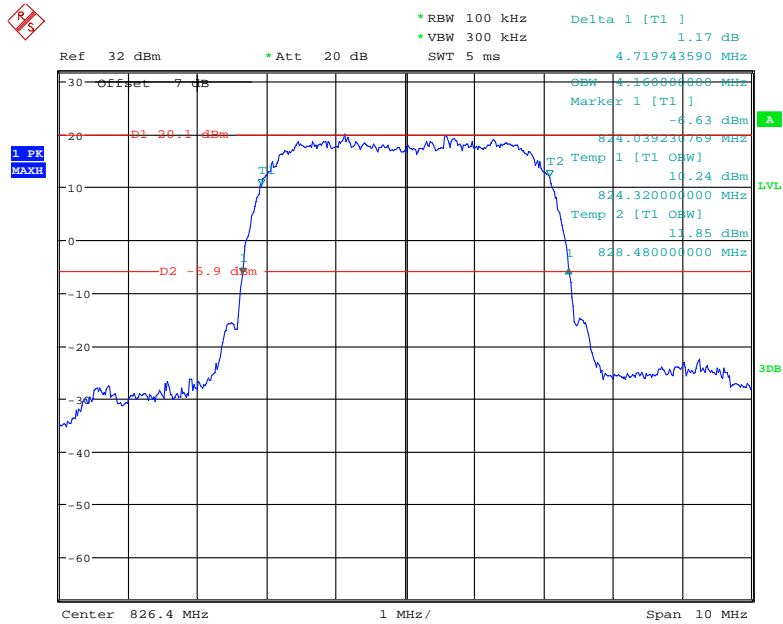

Date: 10.MAR.2021 17:10:43

26 dB Emissions & 99% Occupied Bandwidth for RMC (BPSK) Mode, Middle channel

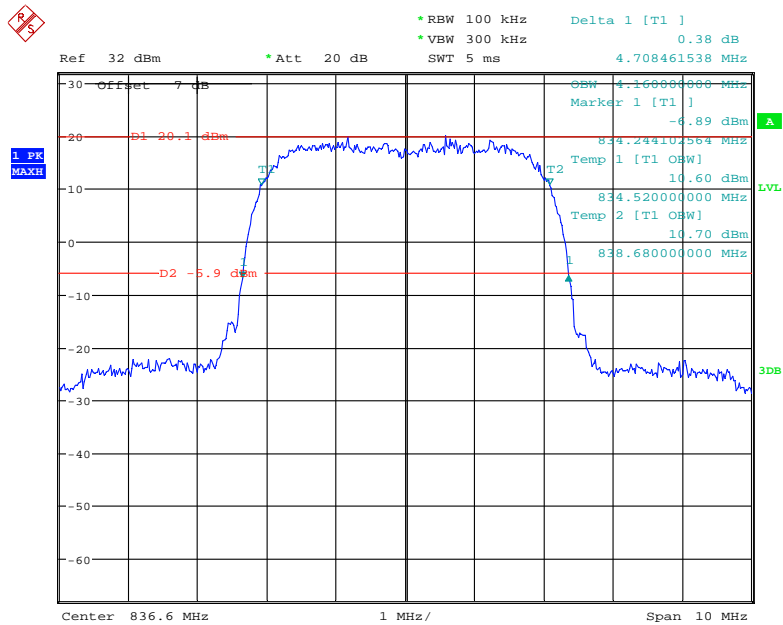

Date: 10.MAR.2021 17:11:30

26 dB Emissions & 99% Occupied Bandwidth for RMC (BPSK) Mode, High channel

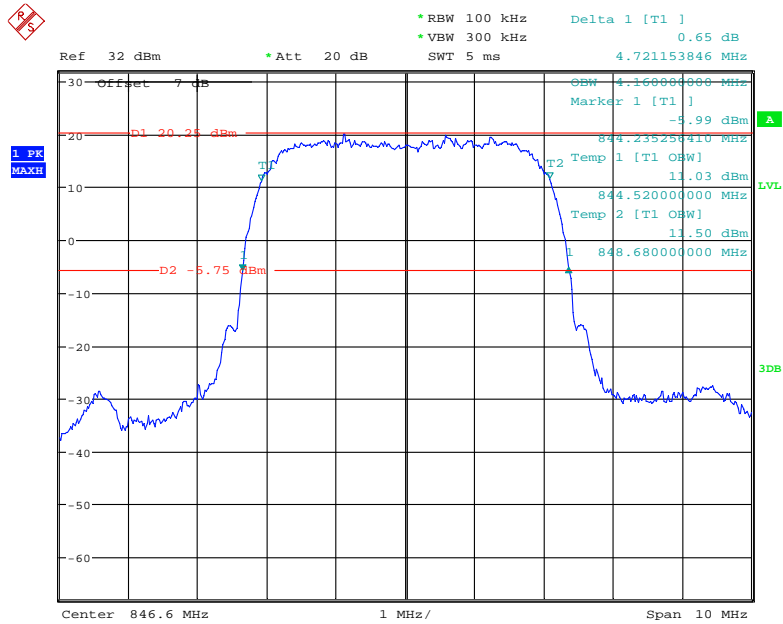

Date: 10.MAR.2021 17:09:09

26 dB Emissions & 99% Occupied Bandwidth for HSUPA (BPSK) Mode, Low channel

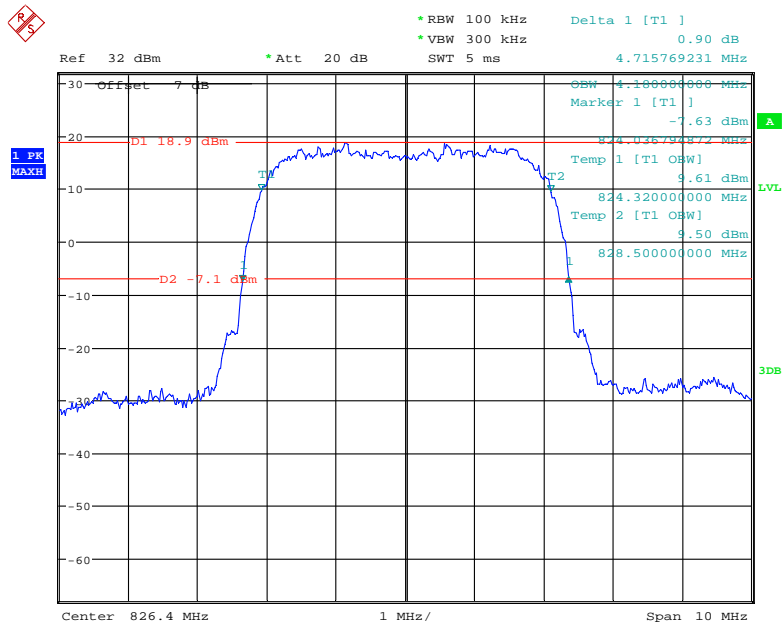

Date: 10.MAR.2021 17:15:19

26 dB Emissions & 99% Occupied Bandwidth for HSUPA (BPSK) Mode, Middle channel

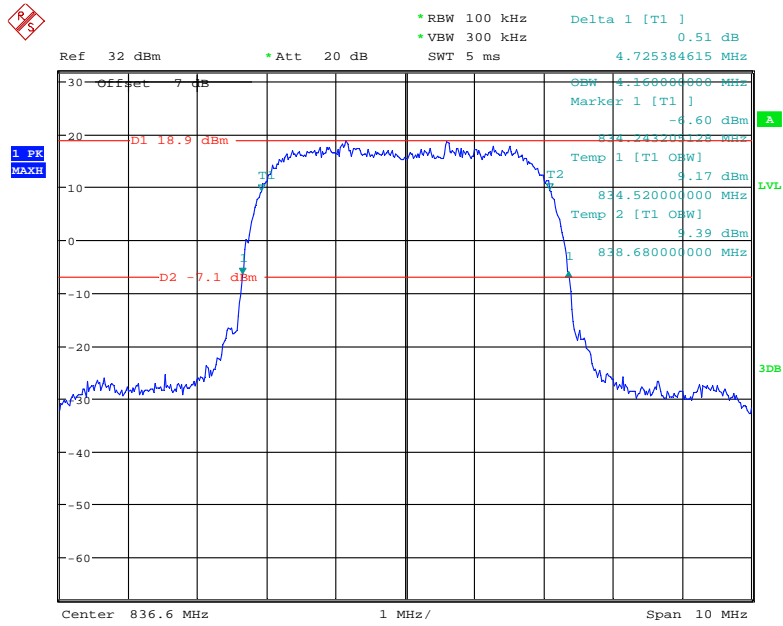

Date: 10.MAR.2021 17:13:23

26 dB Emissions & 99% Occupied Bandwidth for HSUPA (BPSK) Mode, High channel

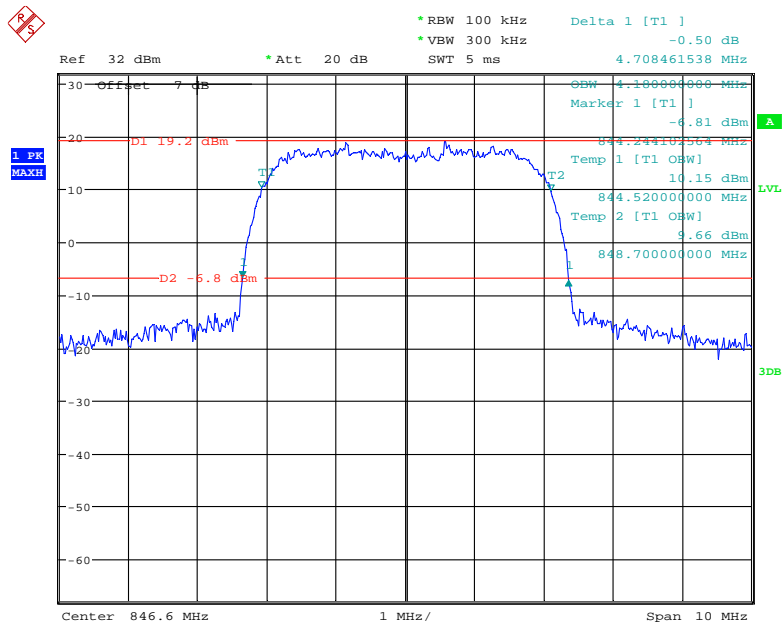

Date: 10.MAR.2021 17:16:42

26 dB Emissions & 99% Occupied Bandwidth for HSDPA (16QAM) Mode, Low channel

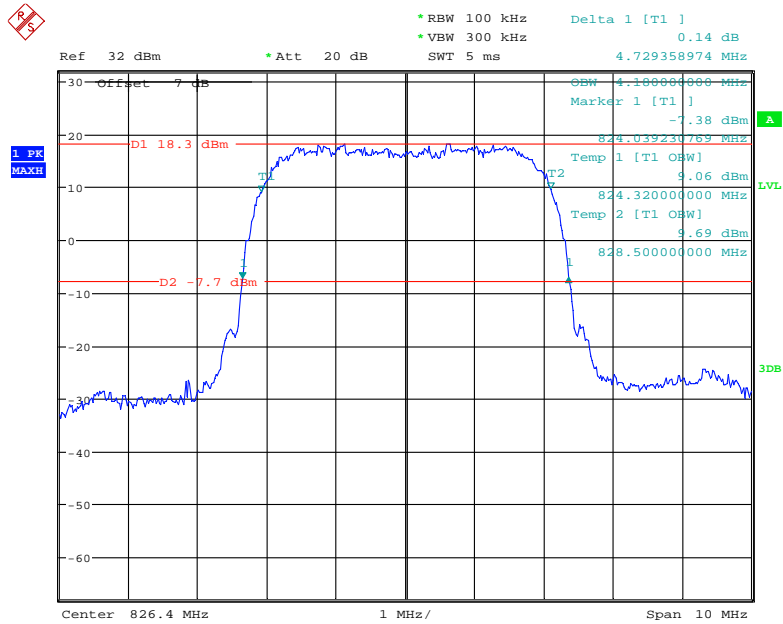

Date: 10.MAR.2021 17:21:24

26 dB Emissions & 99% Occupied Bandwidth for HSDPA (16QAM) Mode, Middle channel

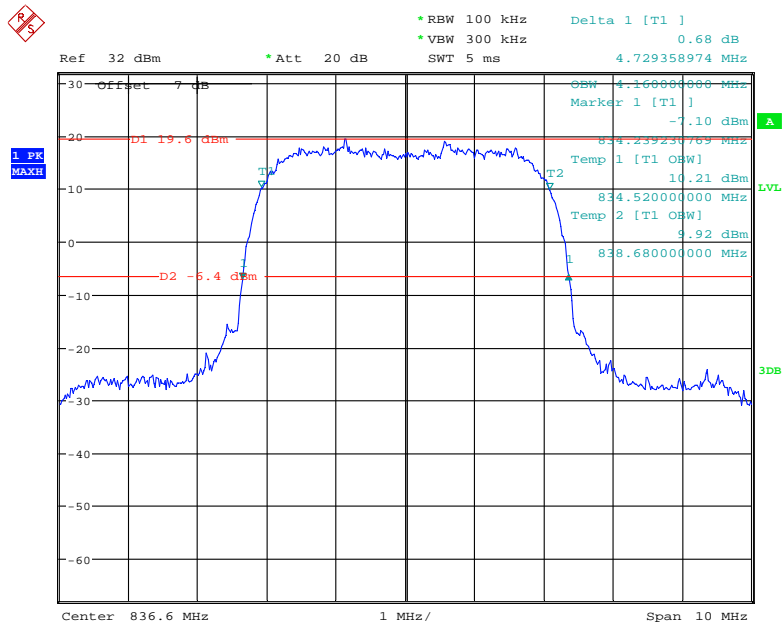

Date: 10.MAR.2021 17:20:17

26 dB Emissions & 99% Occupied Bandwidth for HSDPA (16QAM) Mode, High channel

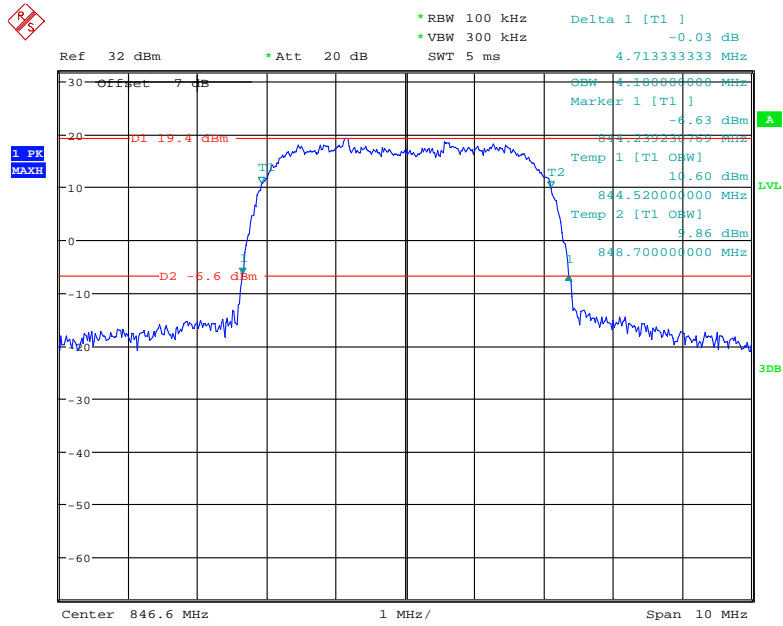

Date: 10.MAR.2021 17:18:22

PCS Band (Part 24E)

26 dB Emissions & 99% Occupied Bandwidth for GSM (GMSK) Mode, Low channel

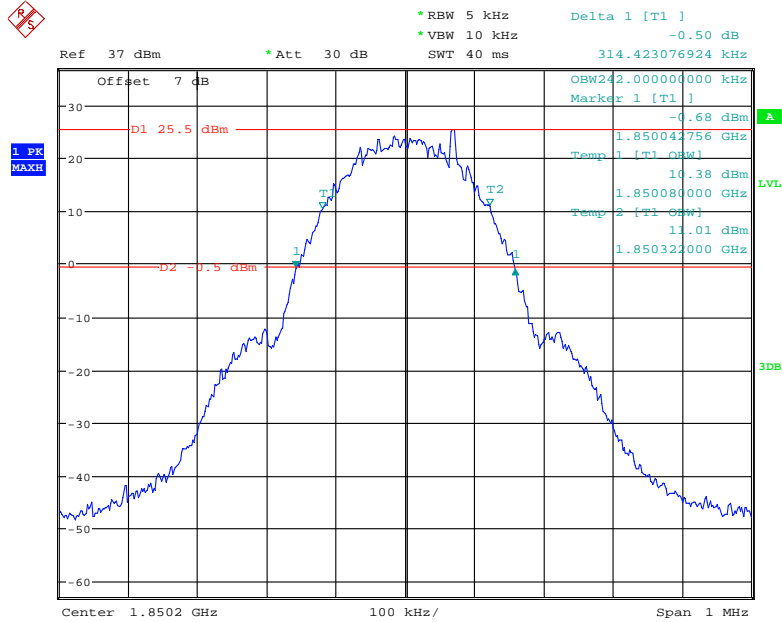

Date: 11.MAR.2021 09:23:05

26 dB Emissions & 99% Occupied Bandwidth for GSM (GMSK) Mode, Middle channel

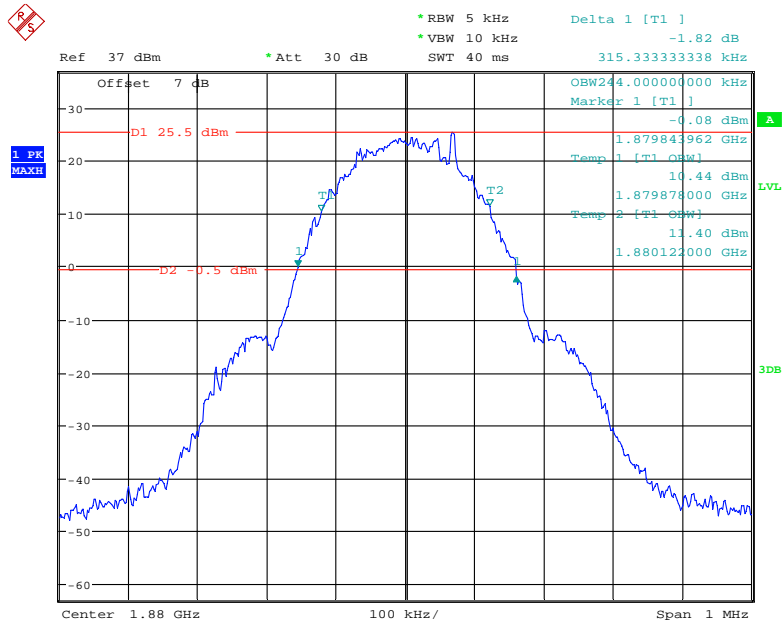

Date: 11.MAR.2021 09:25:24

26 dB Emissions & 99% Occupied Bandwidth for GSM (GMSK) Mode, High channel

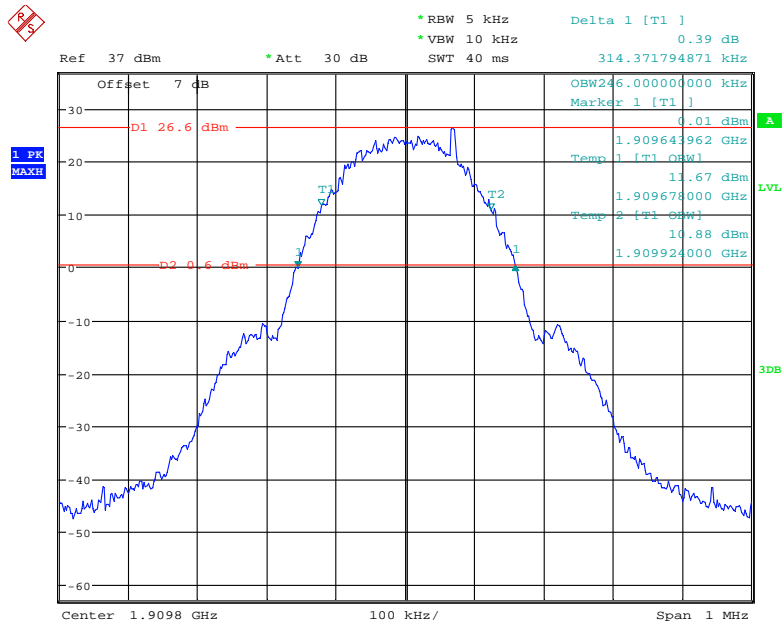

Date: 11.MAR.2021 09:28:39

26 dB Emissions & 99% Occupied Bandwidth for EGPRS (8PSK) Mode, Low channel

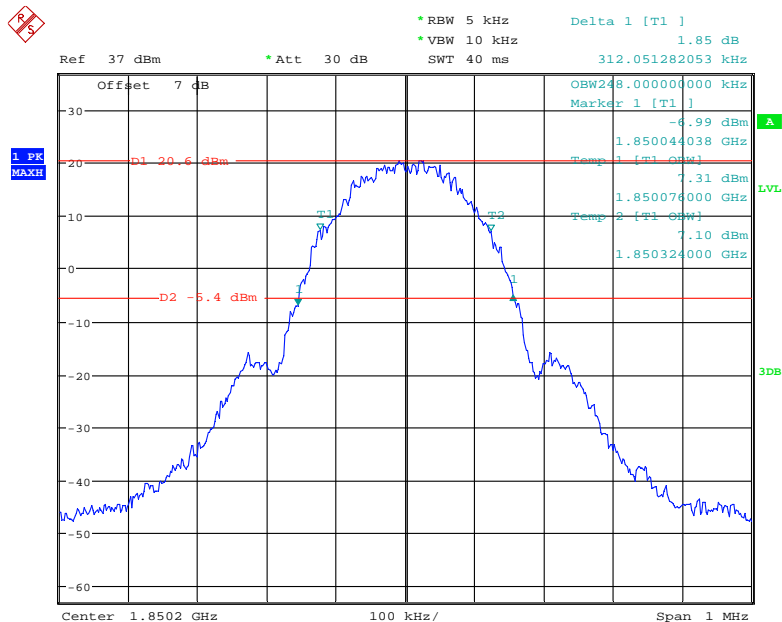

Date: 11.MAR.2021 09:36:15

26 dB Emissions & 99% Occupied Bandwidth for EGPRS (8PSK) Mode, Middle channel

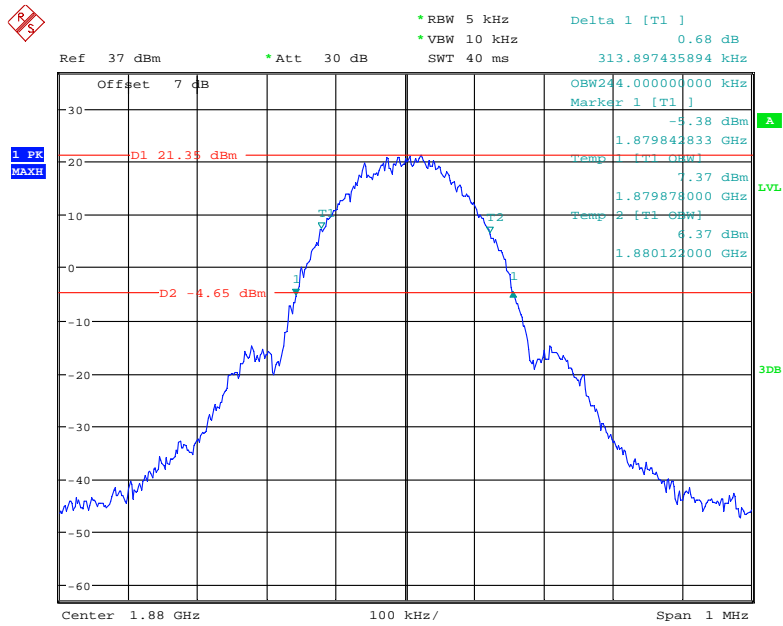

Date: 11.MAR.2021 09:33:52

26 dB Emissions & 99% Occupied Bandwidth for EGPRS (8PSK) Mode, High channel

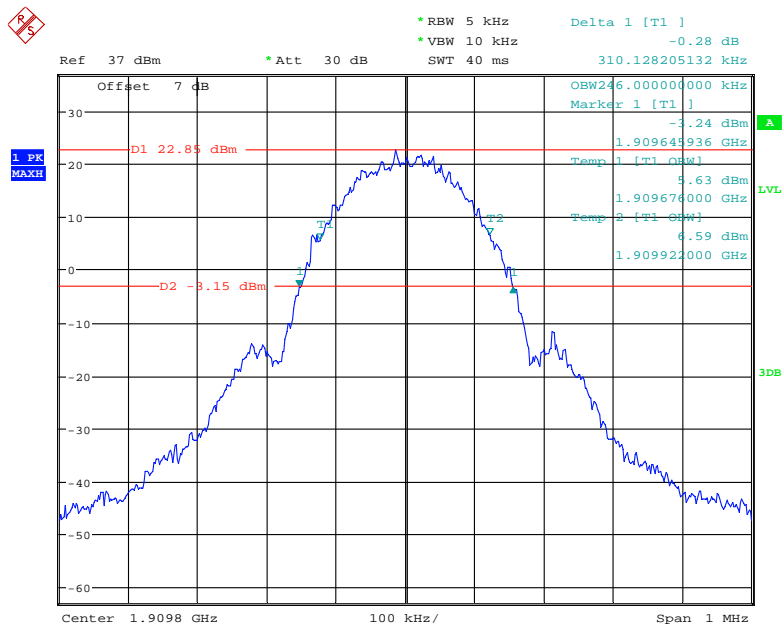

Date: 11.MAR.2021 09:31:44

26 dB Emissions & 99% Occupied Bandwidth for RMC (BPSK) Mode, Low channel

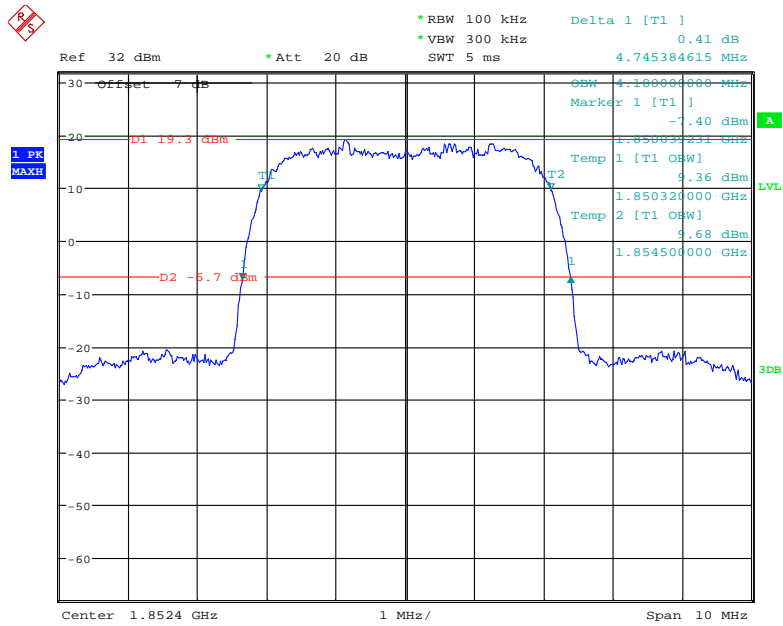

Date: 10.MAR.2021 18:21:02

26 dB Emissions & 99% Occupied Bandwidth for RMC (BPSK) Mode, Middle channel

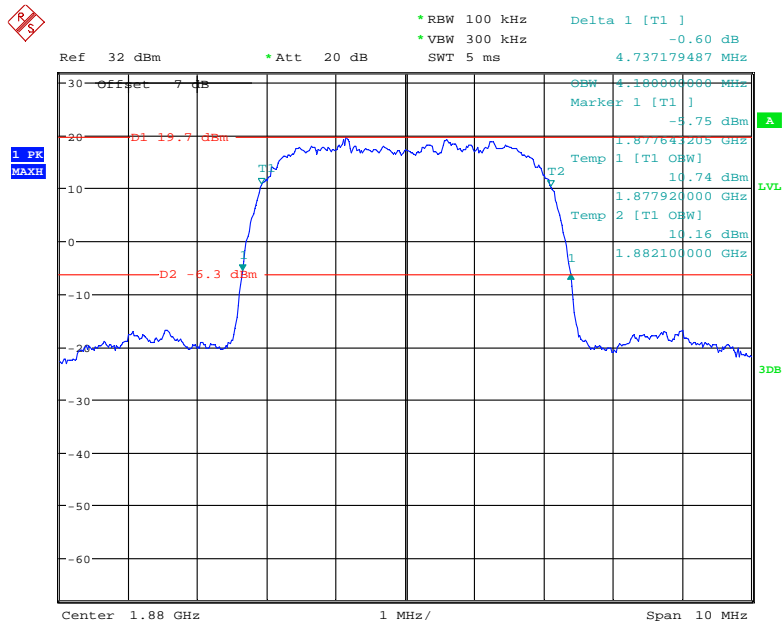

Date: 10.MAR.2021 18:20:01

26 dB Emissions & 99% Occupied Bandwidth for RMC (BPSK) Mode, High channel

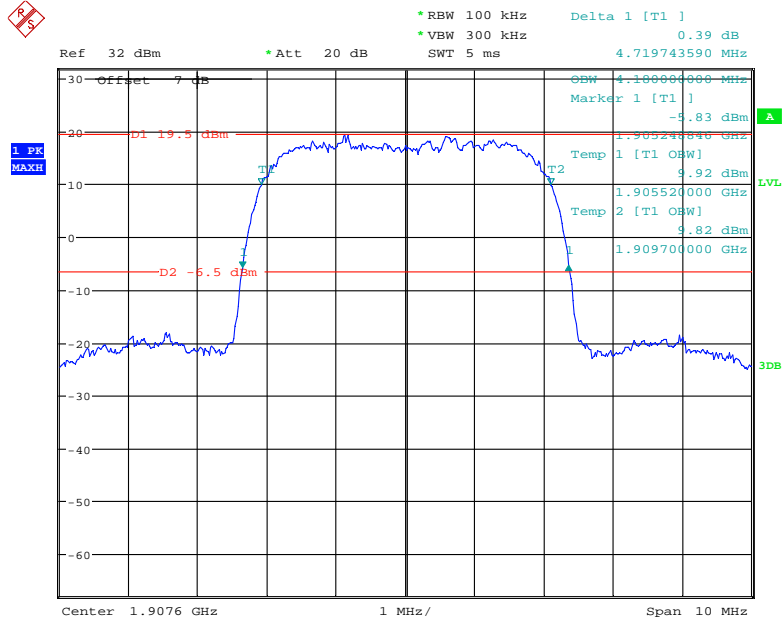

Date: 10.MAR.2021 18:18:02

26 dB Emissions & 99% Occupied Bandwidth for HSUPA (BPSK) Mode, Low channel

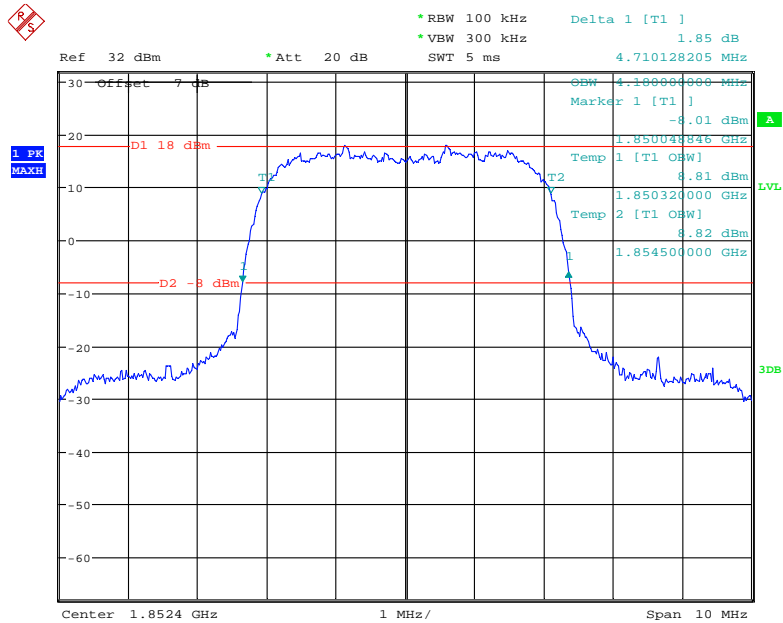

Date: 10.MAR.2021 18:10:58

26 dB Emissions & 99% Occupied Bandwidth for HSUPA (BPSK) Mode, Middle channel

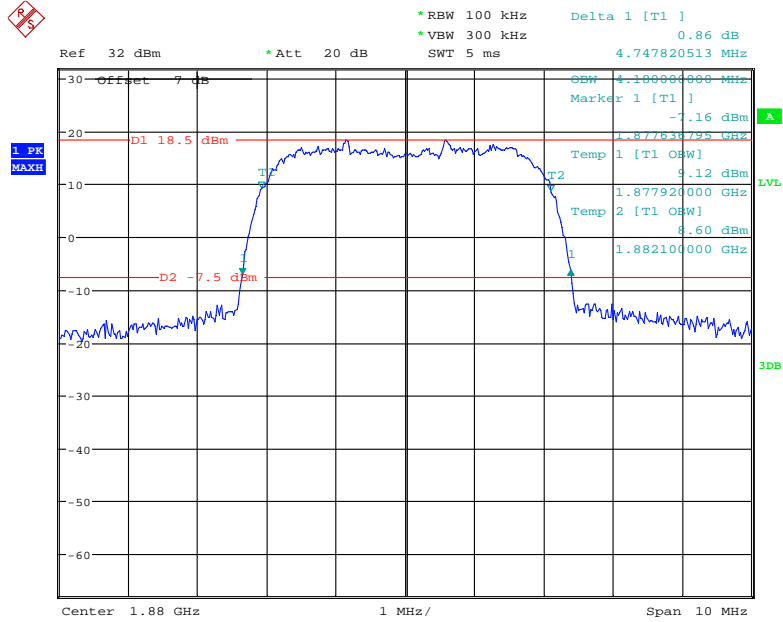

Date: 10.MAR.2021 18:08:53

26 dB Emissions & 99% Occupied Bandwidth for HSUPA (BPSK) Mode, High channel

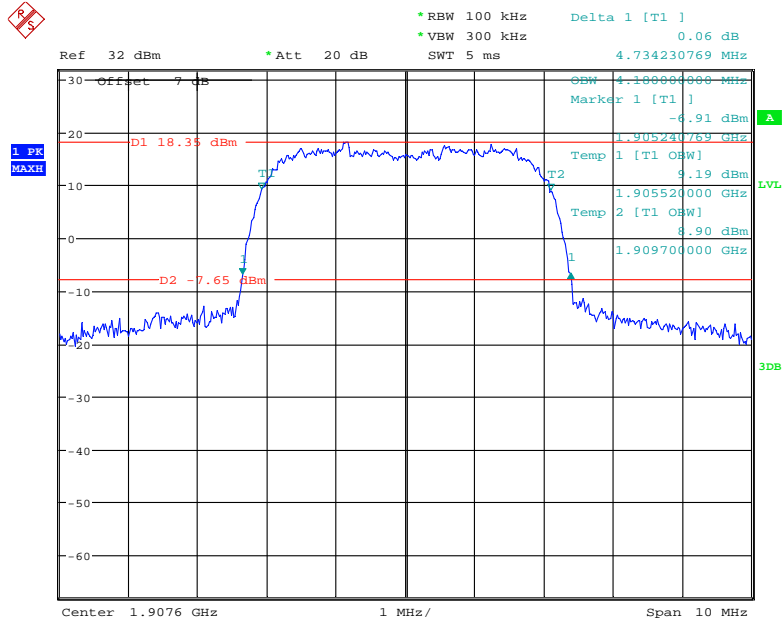

Date: 10.MAR.2021 18:06:20

26 dB Emissions & 99% Occupied Bandwidth for HSDPA (16QAM) Mode, Low channel

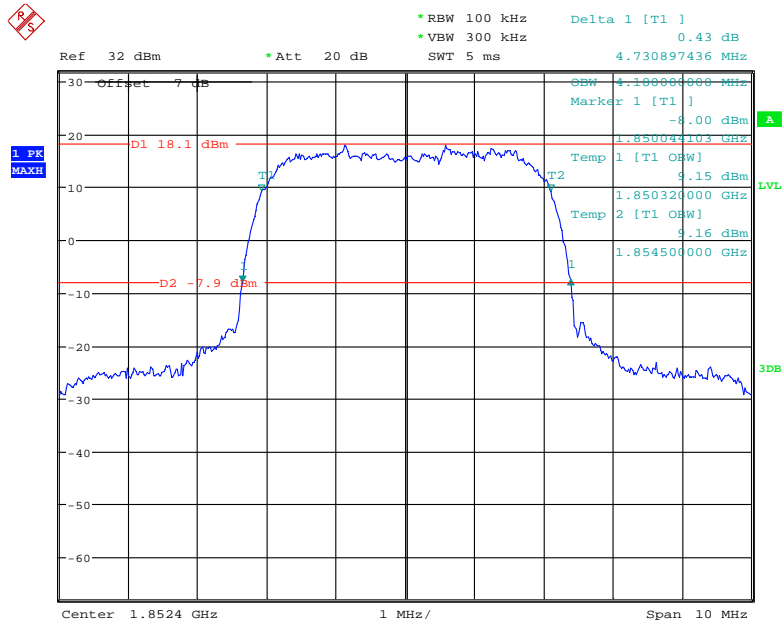

Date: 10.MAR.2021 18:12:53

26 dB Emissions & 99% Occupied Bandwidth for HSDPA (16QAM) Mode, Middle channel

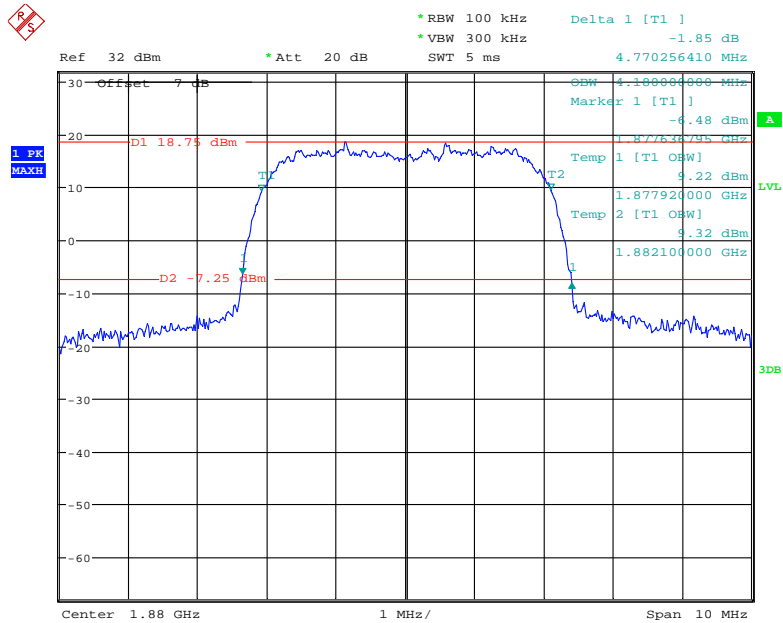

Date: 10.MAR.2021 18:14:27

26 dB Emissions & 99% Occupied Bandwidth for HSDPA (16QAM) Mode, High channel

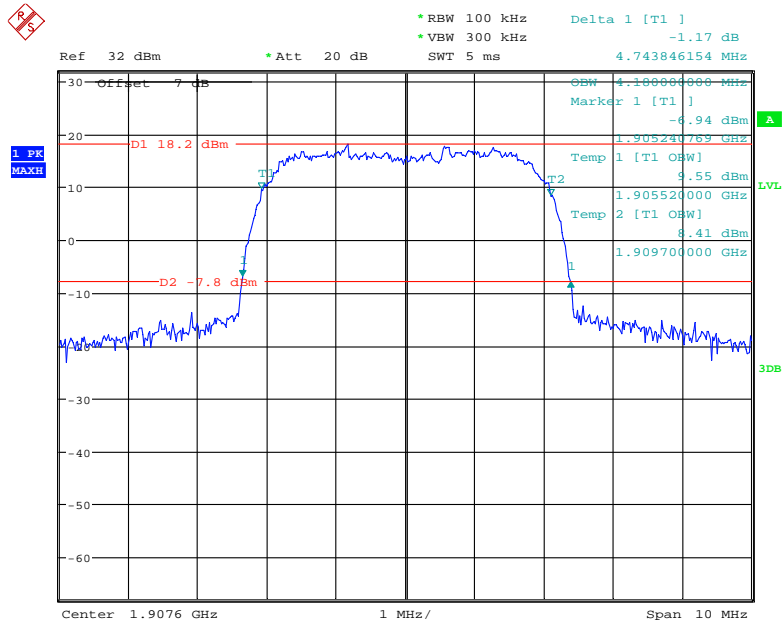

Date: 10.MAR.2021 18:15:54

AWS Band (Part 27)

26 dB Emissions & 99% Occupied Bandwidth for RMC (BPSK) Mode, Low channel

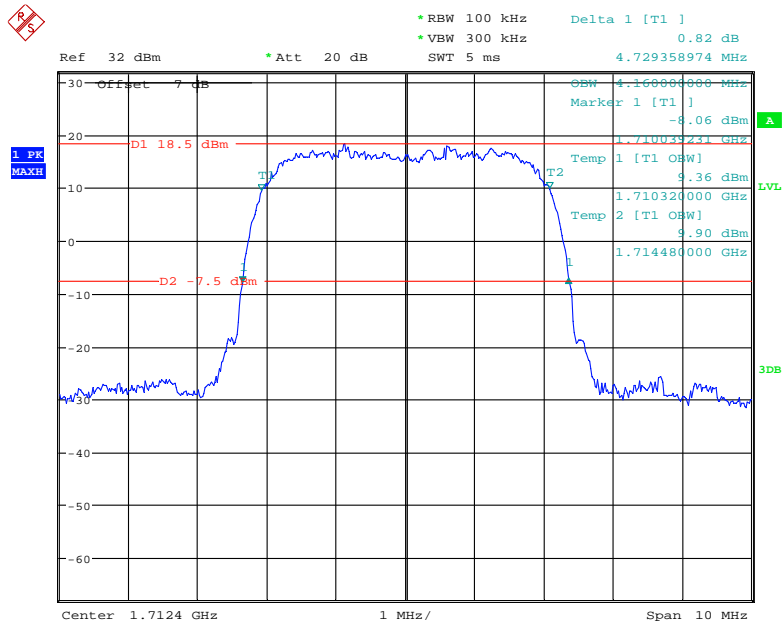

Date: 10.MAR.2021 17:53:11

26 dB Emissions & 99% Occupied Bandwidth for RMC (BPSK) Mode, Middle channel

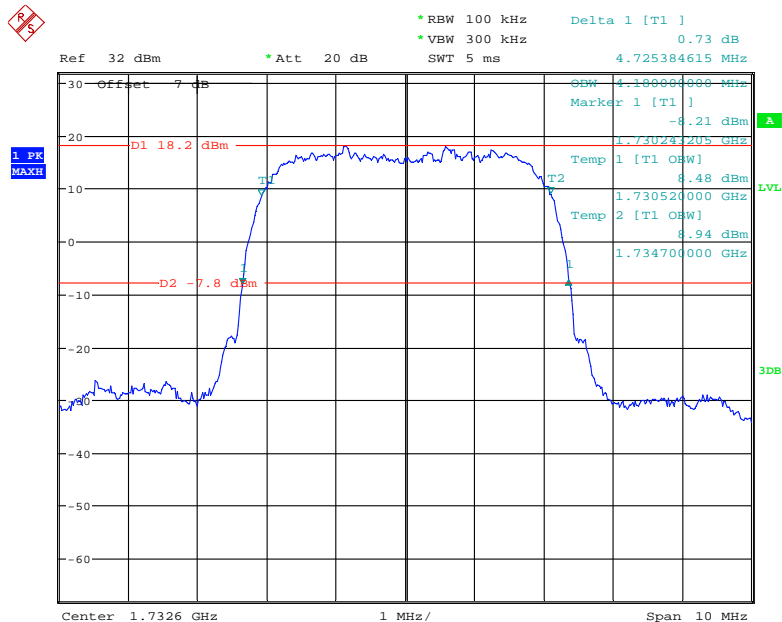

Date: 10.MAR.2021 17:51:32

26 dB Emissions & 99% Occupied Bandwidth for RMC (BPSK) Mode, High channel

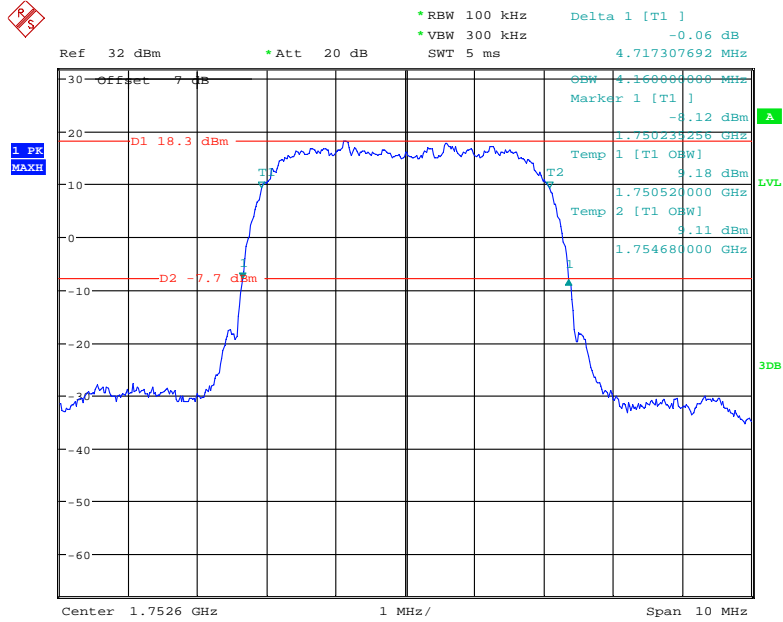

Date: 10.MAR.2021 17:50:19

26 dB Emissions & 99% Occupied Bandwidth for HSUPA (BPSK) Mode, Low channel

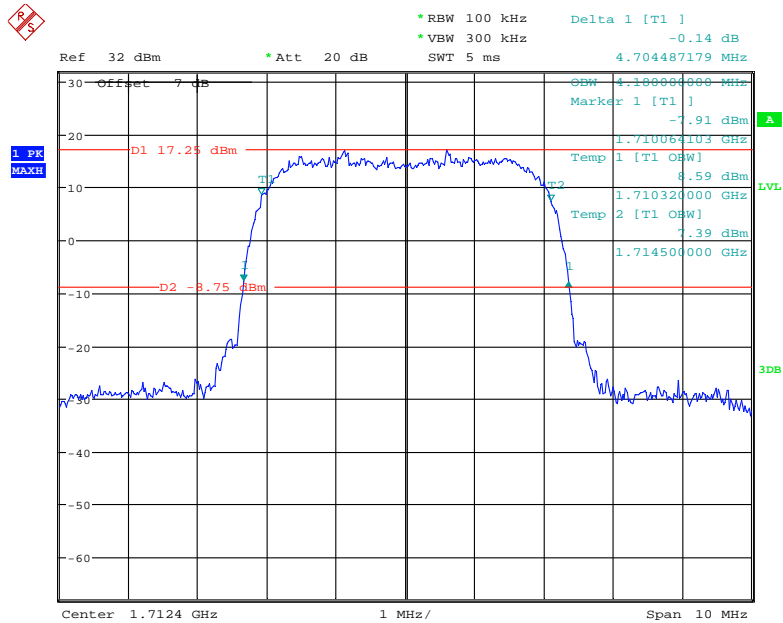

Date: 10.MAR.2021 18:01:23

26 dB Emissions & 99% Occupied Bandwidth for HSUPA (BPSK) Mode, Middle channel

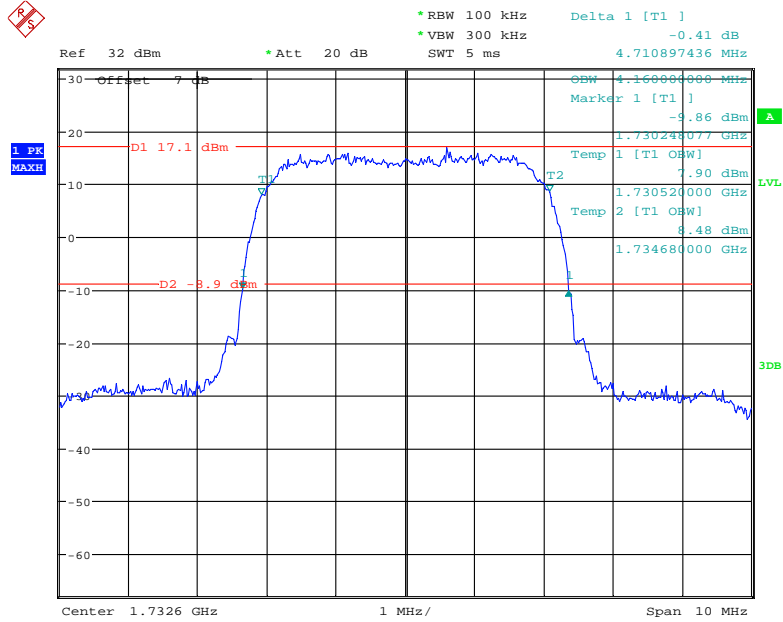

Date: 10.MAR.2021 18:00:18

26 dB Emissions & 99% Occupied Bandwidth for HSUPA (BPSK) Mode, High channel

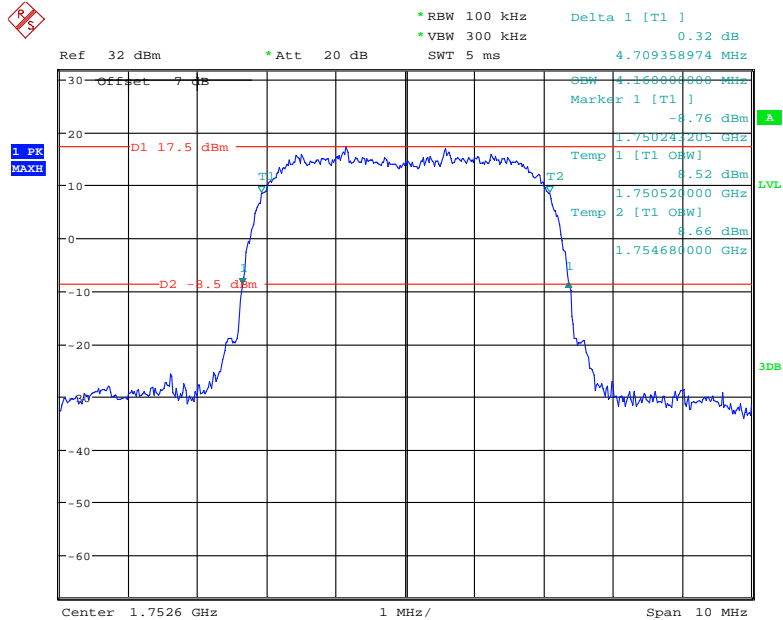

Date: 10.MAR.2021 17:59:32

26 dB Emissions & 99% Occupied Bandwidth for HSDPA (16QAM) Mode, Low channel

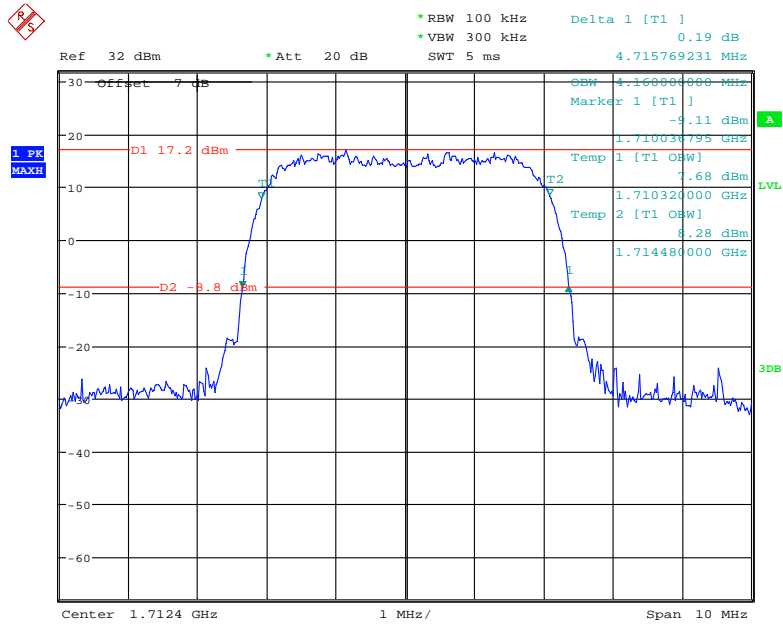

Date: 10.MAR.2021 17:54:57

26 dB Emissions & 99% Occupied Bandwidth for HSDPA (16QAM) Mode, Middle channel

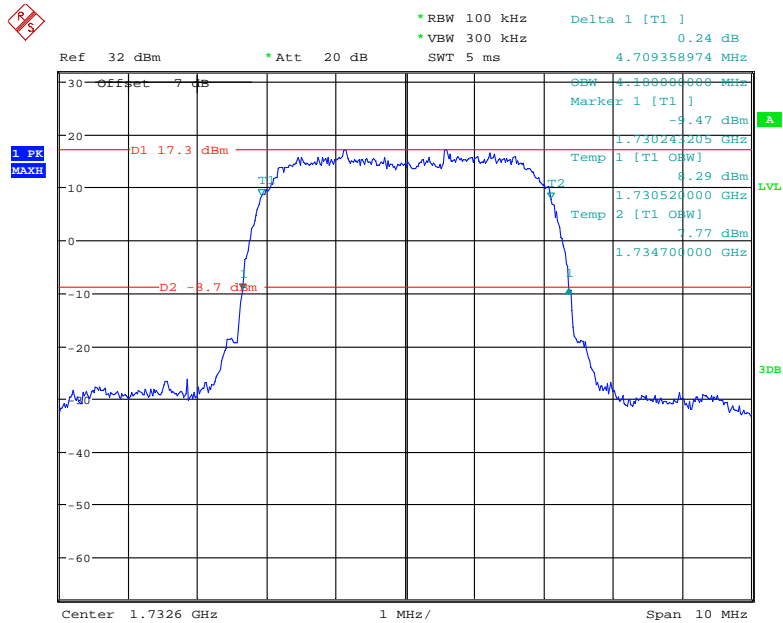

Date: 10.MAR.2021 17:56:09

26 dB Emissions & 99% Occupied Bandwidth for HSDPA (16QAM) Mode, High channel

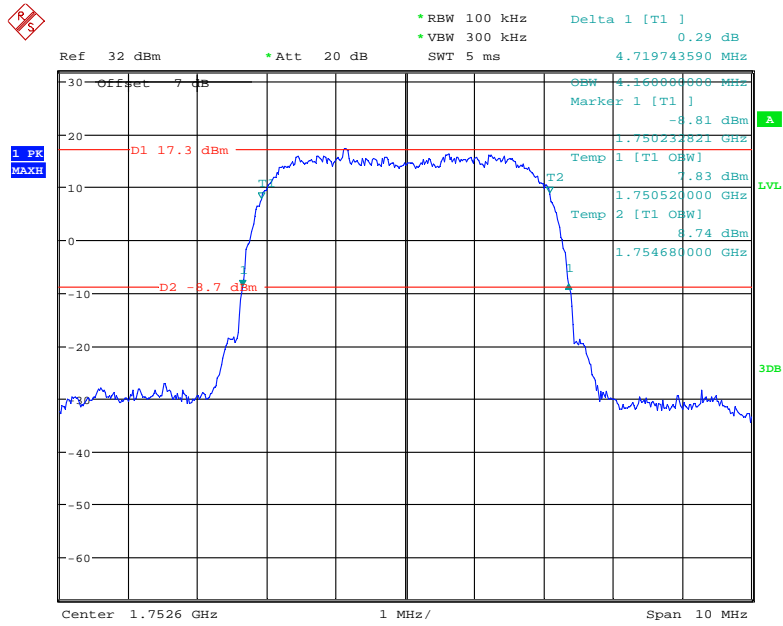

Date: 10.MAR.2021 17:57:23

LTE Band 2:

Bandwidth (MHz)	Modulation	Channel	99% Occupied Bandwidth (MHz)	26 dB Emission Bandwidth (MHz)
1.4	QPSK	Low	1.110	1.284
		Middle	1.104	1.290
		High	1.104	1.296
	16QAM	Low	1.104	1.290
		Middle	1.110	1.302
		High	1.104	1.278
3	QPSK	Low	2.688	2.916
		Middle	2.688	2.940
		High	2.688	2.940
	16QAM	Low	2.688	2.928
		Middle	2.688	2.940
		High	2.688	2.928
5	QPSK	Low	4.520	4.960
		Middle	4.520	4.940
		High	4.520	4.900
	16QAM	Low	4.520	4.900
		Middle	4.540	4.940
		High	4.520	4.940
10	QPSK	Low	8.960	9.600
		Middle	8.960	9.600
		High	8.960	9.680
	16QAM	Low	8.960	9.600
		Middle	8.960	9.600
		High	8.960	9.600
15	QPSK	Low	13.560	14.700
		Middle	13.500	14.820
		High	13.560	14.760
	16QAM	Low	13.500	14.760
		Middle	13.560	14.700
		High	13.500	14.760
20	QPSK	Low	17.920	19.200
		Middle	18.000	19.360
		High	18.000	19.360
	16QAM	Low	18.000	19.360
		Middle	18.000	19.360
		High	18.000	19.440

Band 4:

Bandwidth (MHz)	Modulation	Channel	99% Occupied Bandwidth (MHz)	26 dB Emission Bandwidth (MHz)
1.4	QPSK	Low	1.104	1.290
		Middle	1.104	1.308
		High	1.110	1.284
	16QAM	Low	1.110	1.302
		Middle	1.098	1.278
		High	1.104	1.284
3	QPSK	Low	2.676	2.916
		Middle	2.688	2.940
		High	2.688	2.940
	16QAM	Low	2.688	2.952
		Middle	2.688	2.952
		High	2.688	2.928
5	QPSK	Low	4.520	4.940
		Middle	4.520	4.920
		High	4.500	4.920
	16QAM	Low	4.520	5.160
		Middle	4.520	4.940
		High	4.520	4.960
10	QPSK	Low	8.960	9.640
		Middle	8.960	9.560
		High	8.960	9.560
	16QAM	Low	8.960	9.520
		Middle	8.960	9.680
		High	8.960	9.560
15	QPSK	Low	13.560	14.760
		Middle	13.500	14.820
		High	13.500	14.820
	16QAM	Low	13.500	14.760
		Middle	13.500	14.760
		High	13.500	14.820
20	QPSK	Low	17.920	19.280
		Middle	18.000	19.280
		High	18.000	19.440
	16QAM	Low	18.000	19.360
		Middle	17.920	19.360
		High	18.000	19.440

Band 5:

Bandwidth (MHz)	Modulation	Channel	99% Occupied Bandwidth (MHz)	26 dB Emission Bandwidth (MHz)
1.4	QPSK	Low	1.104	1.290
		Middle	1.104	1.290
		High	1.110	1.278
	16QAM	Low	1.110	1.302
		Middle	1.098	1.284
		High	1.104	1.290
3	QPSK	Low	2.688	2.904
		Middle	2.688	2.928
		High	2.688	2.940
	16QAM	Low	2.688	2.440
		Middle	2.688	2.452
		High	2.688	2.940
5	QPSK	Low	4.500	4.940
		Middle	4.520	4.920
		High	4.540	4.920
	16QAM	Low	4.500	4.900
		Middle	4.520	4.920
		High	4.540	4.960
10	QPSK	Low	8.960	9.600
		Middle	8.960	9.560
		High	8.960	9.600
	16QAM	Low	8.960	9.600
		Middle	8.960	9.560
		High	8.960	9.520

Band 7

Bandwidth (MHz)	Modulation	Channel	99% Occupied Bandwidth (MHz)	26 dB Emission Bandwidth (MHz)
5	QPSK	Low	4.540	4.960
		Middle	4.520	4.920
		High	4.520	4.920
	16QAM	Low	4.520	5.120
		Middle	4.520	4.940
		High	4.520	4.960
10	QPSK	Low	9.000	9.600
		Middle	8.960	9.600
		High	8.960	9.680
	16QAM	Low	9.000	9.560
		Middle	9.000	9.640
		High	8.960	9.640
15	QPSK	Low	13.620	14.760
		Middle	13.560	14.820
		High	13.560	14.820
	16QAM	Low	13.500	14.700
		Middle	13.560	14.880
		High	13.560	14.820
20	QPSK	Low	17.920	19.280
		Middle	18.000	19.360
		High	18.000	19.440
	16QAM	Low	17.920	19.280
		Middle	18.080	19.440
		High	17.920	19.360

Band 17

Bandwidth (MHz)	Modulation	Channel	99% Occupied Bandwidth (MHz)	26 dB Emission Bandwidth (MHz)
5	QPSK	Low	4.500	4.900
		Middle	4.500	4.940
		High	4.520	4.920
	16QAM	Low	4.500	4.900
		Middle	4.520	4.920
		High	4.520	4.960
10	QPSK	Low	8.960	9.600
		Middle	8.960	9.600
		High	8.960	9.560
	16QAM	Low	8.960	9.600
		Middle	8.960	9.560
		High	8.960	9.600

LTE Band 38:

Bandwidth (MHz)	Modulation	Channel	99% Occupied Bandwidth (MHz)	26 dB Emission Bandwidth (MHz)
5	QPSK	Low	4.520	4.940
		Middle	4.520	4.940
		High	4.500	5.100
	16QAM	Low	4.500	4.960
		Middle	4.500	4.960
		High	4.500	4.940
10	QPSK	Low	8.960	9.640
		Middle	8.960	9.600
		High	8.960	9.600
	16QAM	Low	8.960	9.560
		Middle	8.960	9.600
		High	8.960	9.920
15	QPSK	Low	13.560	14.940
		Middle	13.500	14.880
		High	13.500	14.940
	16QAM	Low	13.500	15.360
		Middle	13.500	14.880
		High	13.560	14.940
20	QPSK	Low	18.000	19.200
		Middle	17.920	19.200
		High	18.000	19.360
	16QAM	Low	18.000	19.200
		Middle	18.000	19.280
		High	18.000	19.280

LTE Band 41:

Bandwidth (MHz)	Modulation	Channel	99% Occupied Bandwidth (MHz)	26 dB Emission Bandwidth (MHz)
5	QPSK	Low	4.500	5.100
		Middle	4.500	4.960
		High	4.520	5.000
	16QAM	Low	4.500	4.880
		Middle	4.520	4.940
		High	4.520	4.920
10	QPSK	Low	8.960	9.640
		Middle	8.960	9.680
		High	8.960	9.560
	16QAM	Low	8.960	9.480
		Middle	8.960	9.520
		High	8.960	9.800
15	QPSK	Low	13.560	14.820
		Middle	13.500	14.700
		High	13.440	14.820
	16QAM	Low	13.500	15.480
		Middle	13.500	14.880
		High	13.500	14.820
20	QPSK	Low	18.000	19.200
		Middle	17.920	19.120
		High	17.920	19.280
	16QAM	Low	18.000	19.360
		Middle	18.000	19.280
		High	17.920	19.200

LTE Band 66

Bandwidth (MHz)	Modulation	Channel	99% Occupied Bandwidth (MHz)	26 dB Emission Bandwidth (MHz)
1.4	QPSK	Low	1.110	1.278
		Middle	1.104	1.284
		High	1.110	1.284
	16QAM	Low	1.098	1.278
		Middle	1.098	1.284
		High	1.110	1.302
3	QPSK	Low	2.688	2.940
		Middle	2.688	2.940
		High	2.688	2.940
	16QAM	Low	2.688	2.952
		Middle	2.688	2.928
		High	2.688	2.952
5	QPSK	Low	4.520	4.940
		Middle	4.520	4.940
		High	4.500	4.880
	16QAM	Low	4.520	4.940
		Middle	4.520	4.940
		High	4.540	4.920
10	QPSK	Low	8.920	9.560
		Middle	8.960	9.600
		High	8.960	9.640
	16QAM	Low	8.920	9.560
		Middle	8.960	9.600
		High	8.960	9.560
15	QPSK	Low	13.500	14.760
		Middle	13.500	14.760
		High	13.500	14.760
	16QAM	Low	13.560	14.820
		Middle	13.560	14.820
		High	13.500	14.700
20	QPSK	Low	18.000	19.360
		Middle	17.920	19.360
		High	18.000	19.520
	16QAM	Low	18.000	19.360
		Middle	18.000	19.360
		High	18.000	19.520

The test plots of LTE band please refer to the Appendix A.

FCC §2.1051, §22.917(a) & §24.238(a); §27.53 - SPURIOUS EMISSIONS AT ANTENNA TERMINALS

Applicable Standard

FCC §2.1051, §22.917(a) and §24.238(a) and §27.53.

The spectrum was to be investigated to the tenth harmonics of the highest fundamental frequency as specified in § 2.1051.

Test Procedure

The RF output of the transceiver was connected to a spectrum analyzer and simulator through appropriate attenuation. The resolution bandwidth of the spectrum analyzer was set at 1MHz. Sufficient scans were taken to show any out of band emissions up to 10th harmonic.

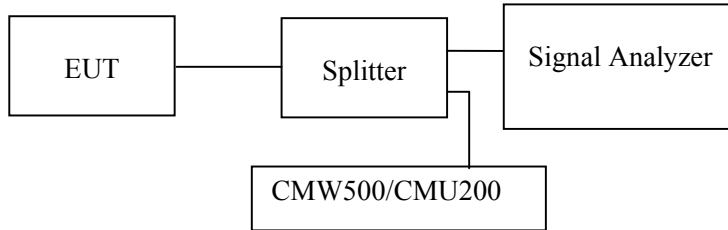

Test Data

Environmental Conditions

Temperature:	24~26.5 °C
Relative Humidity:	54~56 %
ATM Pressure:	100.0~101.0 kPa

The testing was performed by Black Chen from 2021-03-07 to 2021-03-11.

EUT operation mode: Transmitting

Test result: Pass

Please refer to the following plots.

**Cellular Band (Part 22H)
Low Channel:**

30 MHz – 1 GHz (GSM Mode)

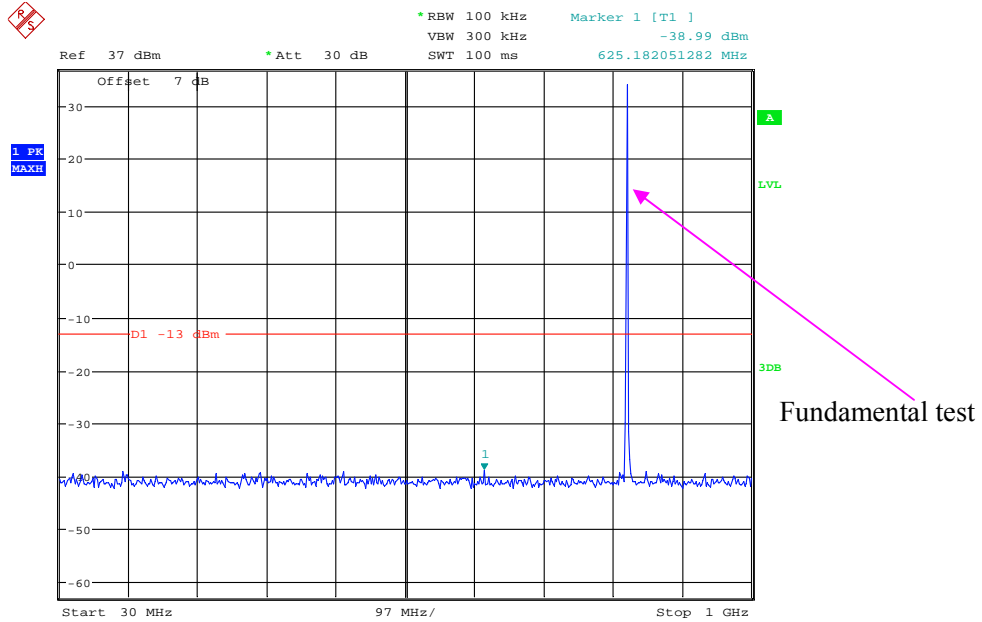

Date: 11.MAR.2021 09:55:04

1 GHz – 10 GHz (GSM Mode)

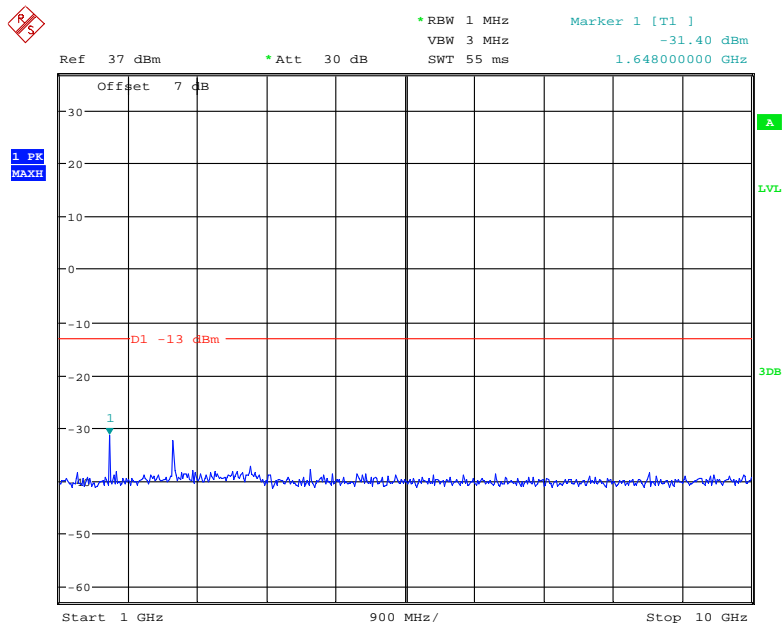

Date: 11.MAR.2021 09:57:11

30 MHz – 1 GHz (WCDMA Mode)

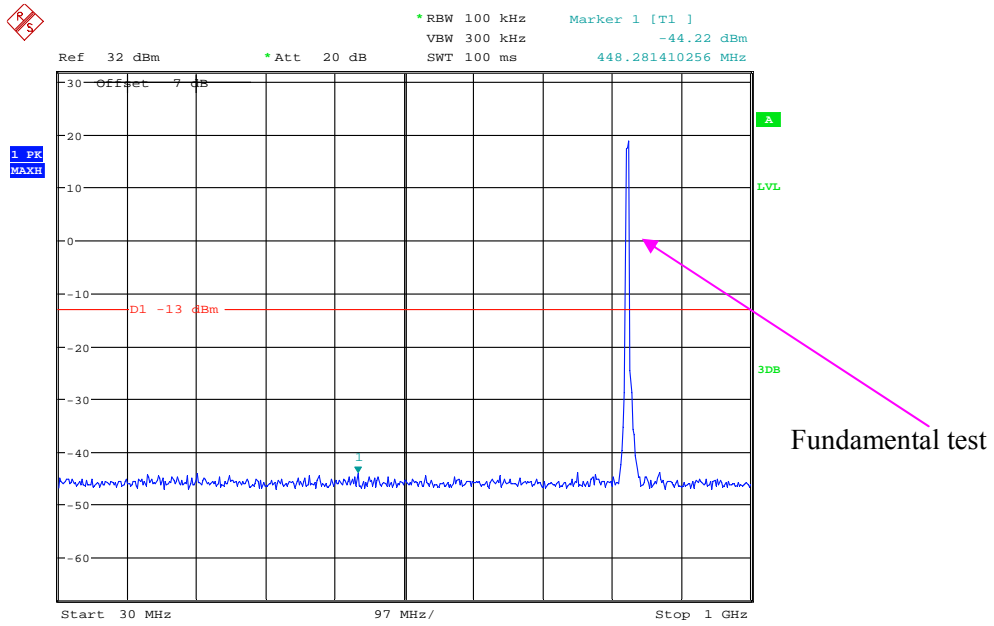

Date: 10.MAR.2021 18:30:20

1 GHz – 10 GHz (WCDMA Mode)

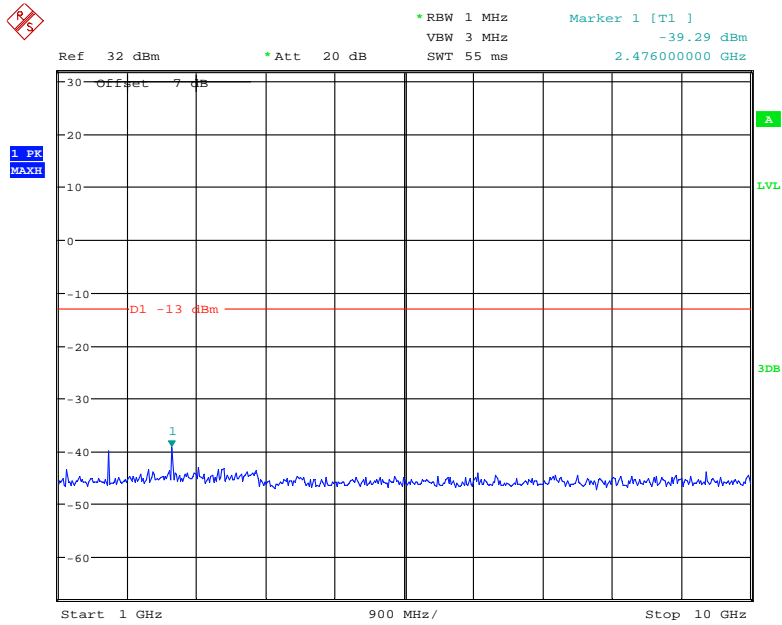

Date: 10.MAR.2021 18:32:31

Middle Channel:

30 MHz – 1 GHz (GSM Mode)

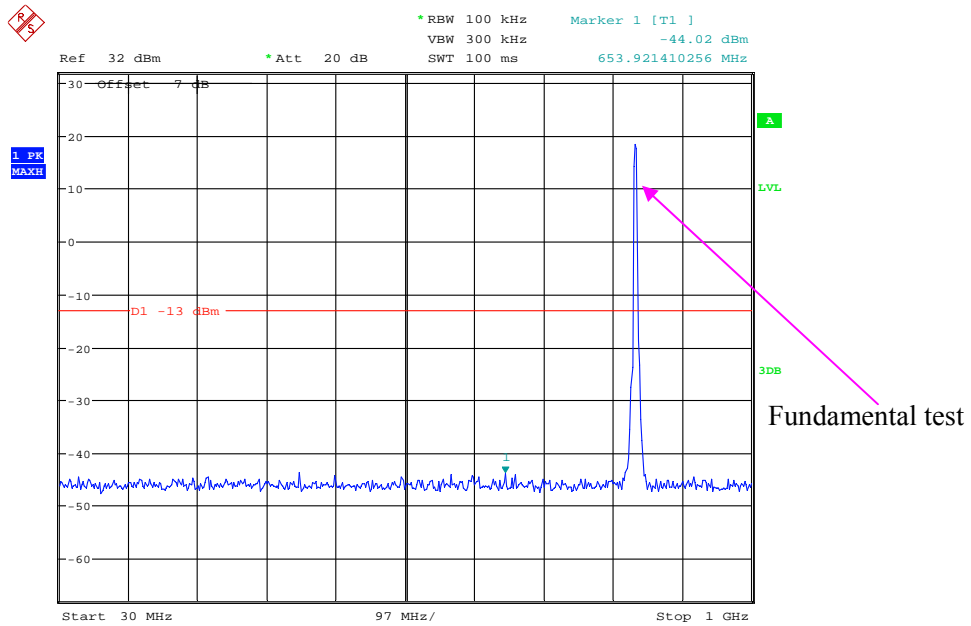

Date: 10.MAR.2021 18:30:53

1 GHz – 10 GHz (GSM Mode)

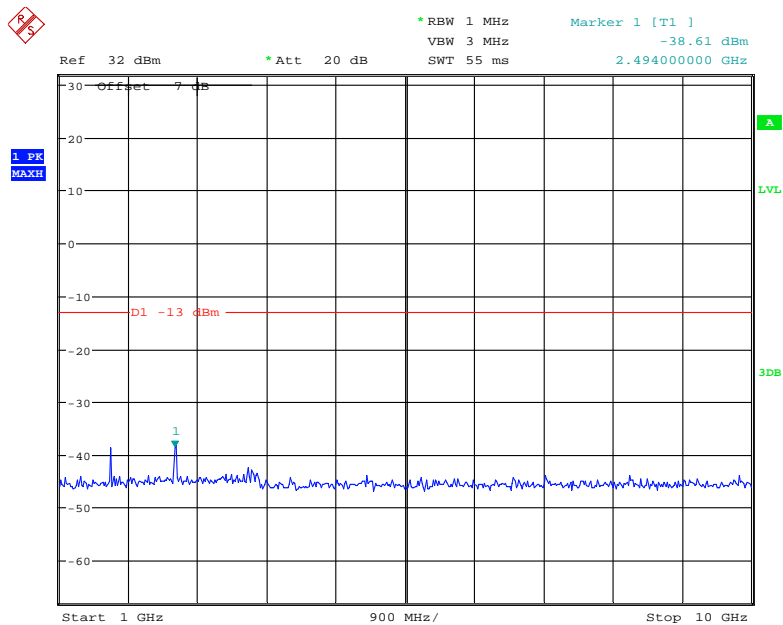

Date: 10.MAR.2021 18:32:12

High Channel:

30 MHz – 1 GHz (WCDMA Mode)

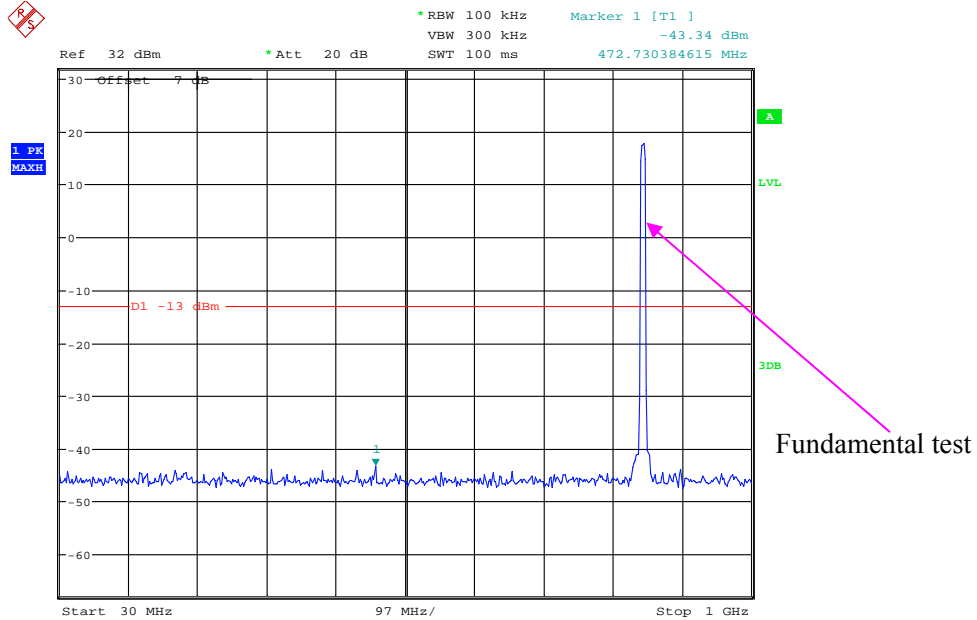

Date: 10.MAR.2021 18:31:20

1 GHz – 10 GHz (WCDMA Mode)

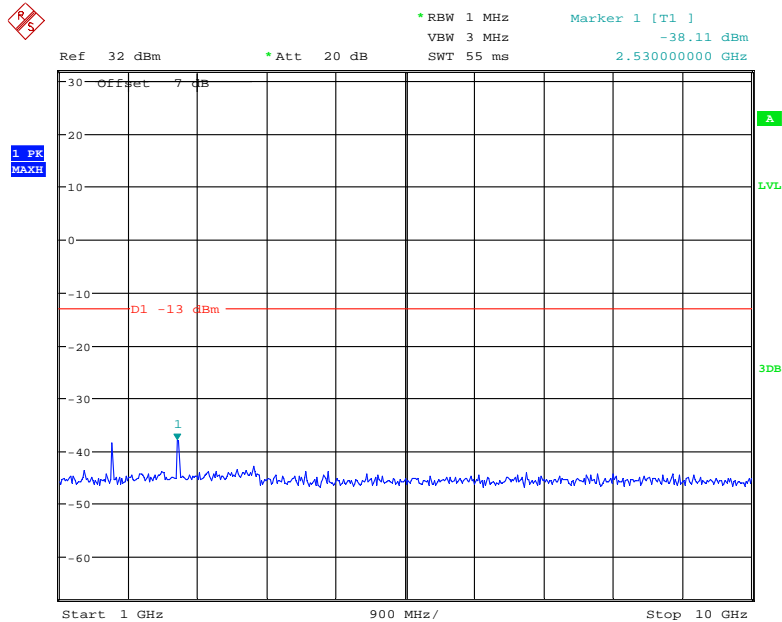

Date: 10.MAR.2021 18:31:46

PCS Band (Part 24E) Low Channel:

30 MHz – 1 GHz (GSM Mode)

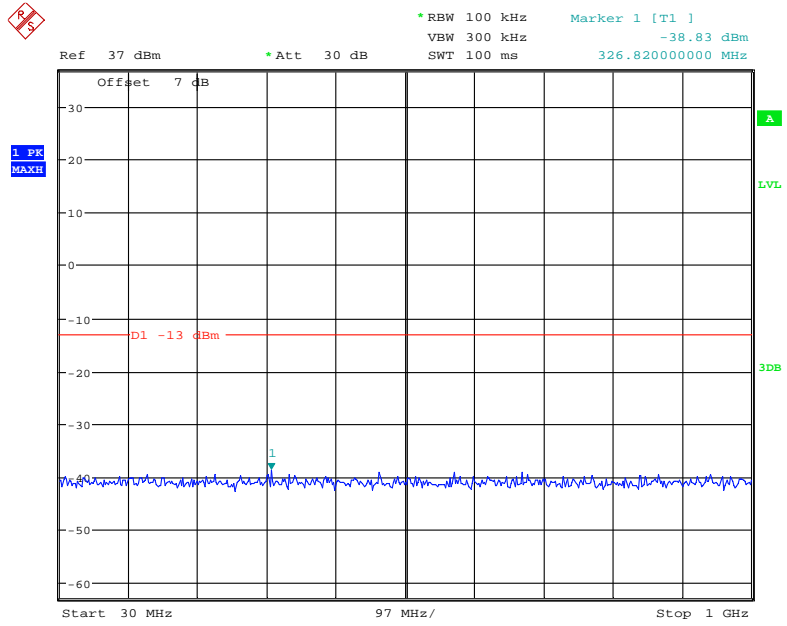

Date: 11.MAR.2021 10:00:42

1 GHz – 2 GHz (GSM Mode)

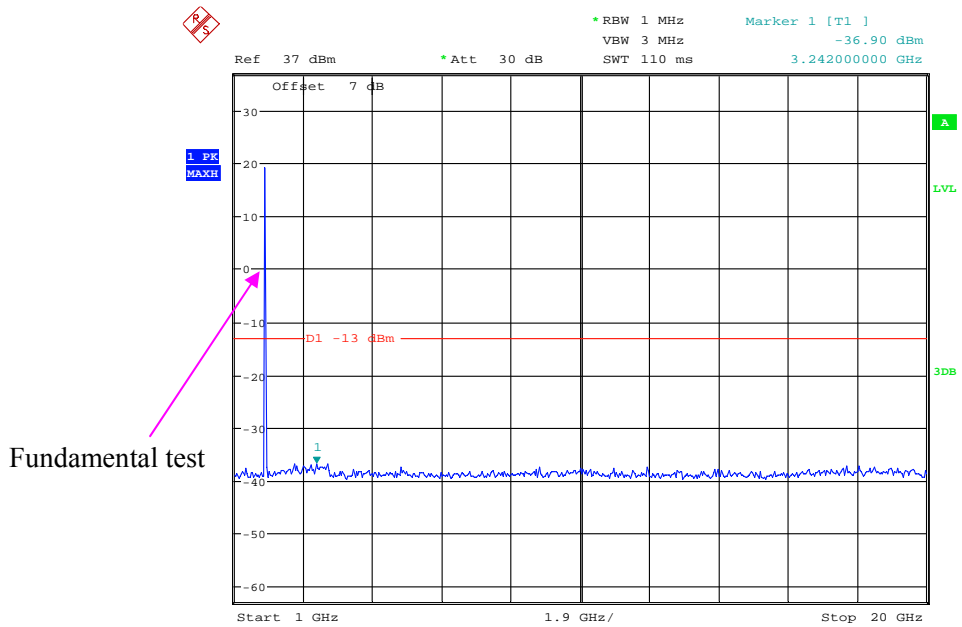

Date: 11.MAR.2021 09:59:18

30 MHz – 1 GHz (WCDMA Mode)

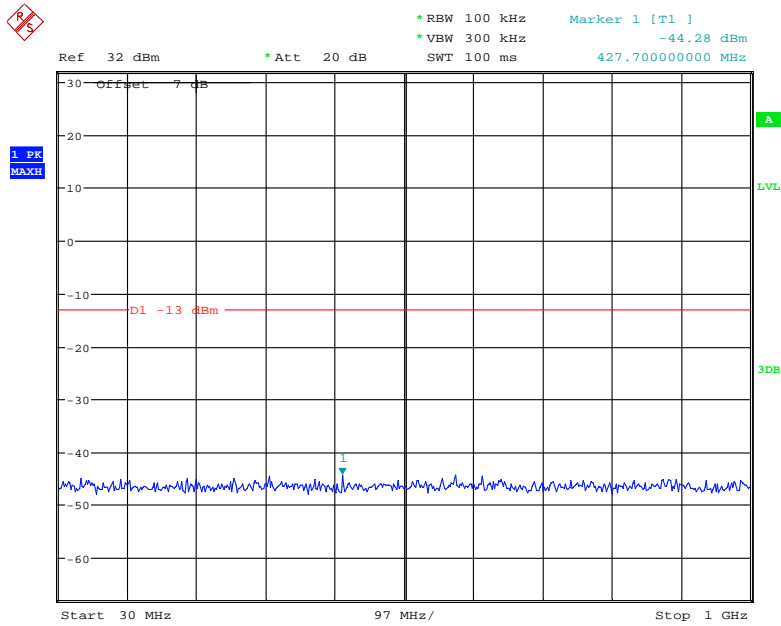

Date: 10.MAR.2021 18:22:24

1 GHz – 20 GHz (WCDMA Mode)

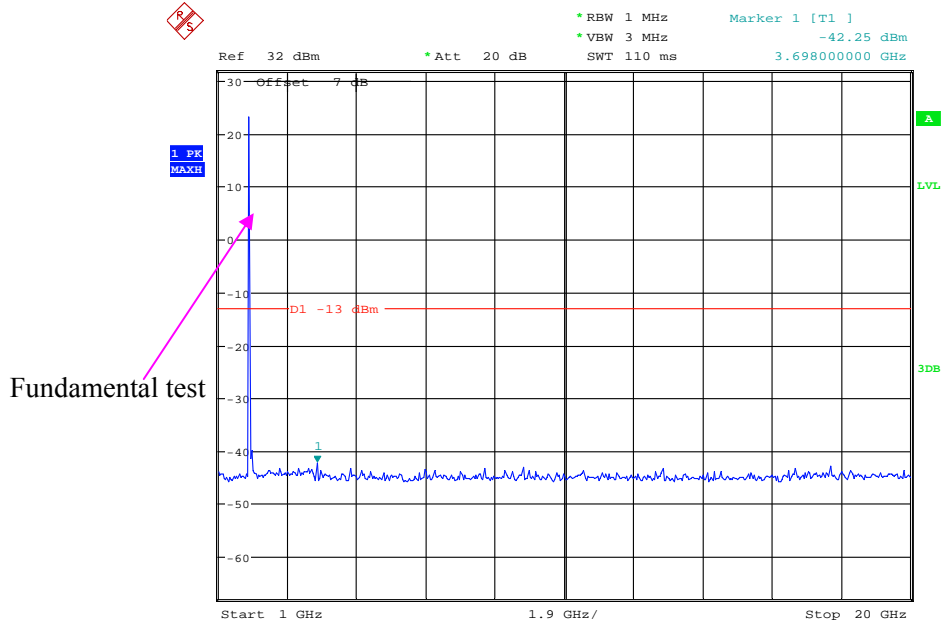

Date: 10.MAR.2021 18:23:34

Middle Channel:

30 MHz – 1 GHz (GSM Mode)

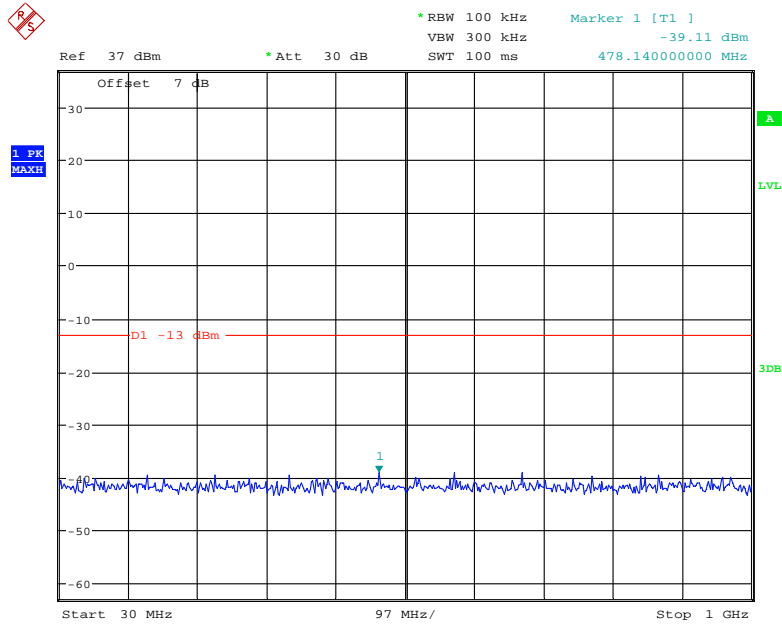

Date: 11.MAR.2021 10:00:36

1 GHz – 2 GHz (GSM Mode)

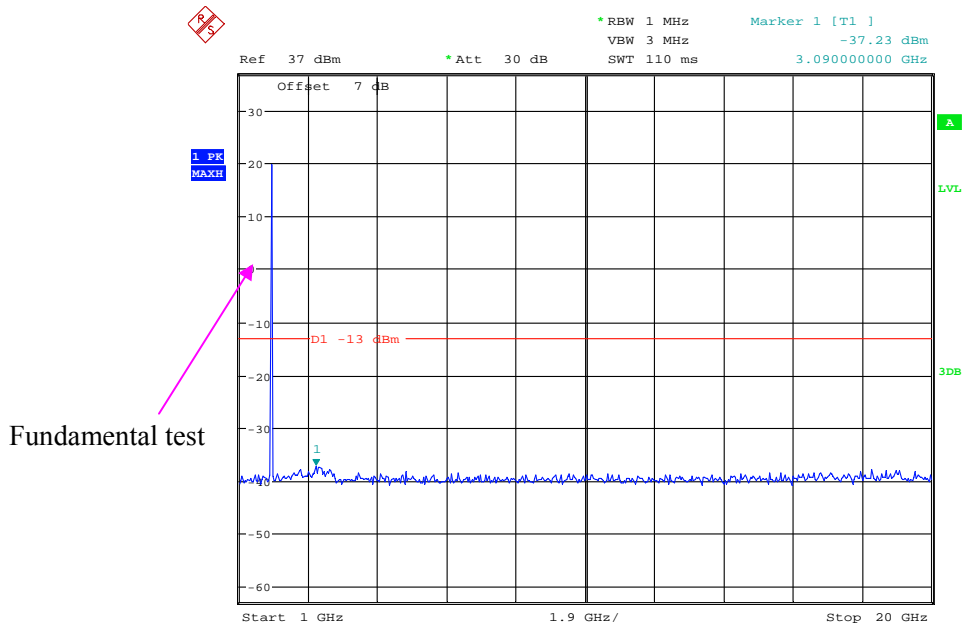

Date: 11.MAR.2021 09:59:49

30 MHz – 1 GHz (WCDMA Mode)

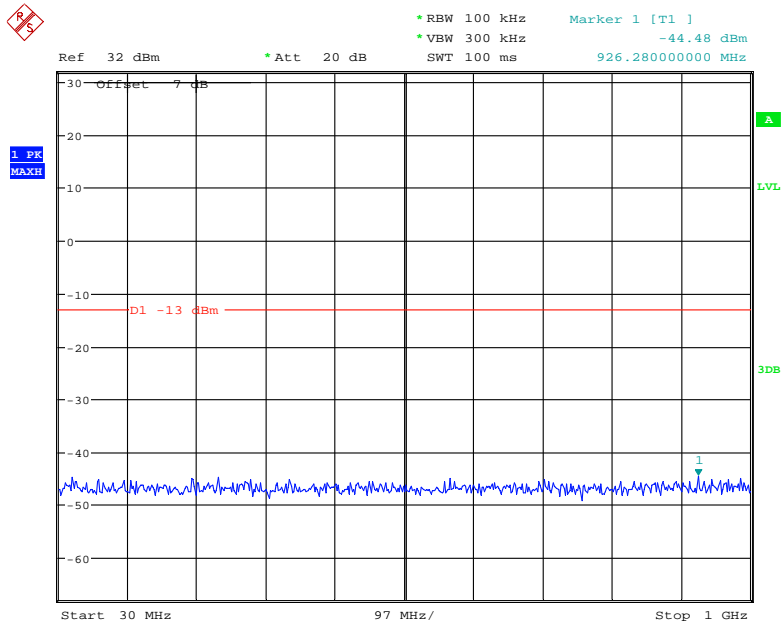

Date: 10.MAR.2021 18:22:47

1 GHz – 20 GHz (WCDMA Mode)

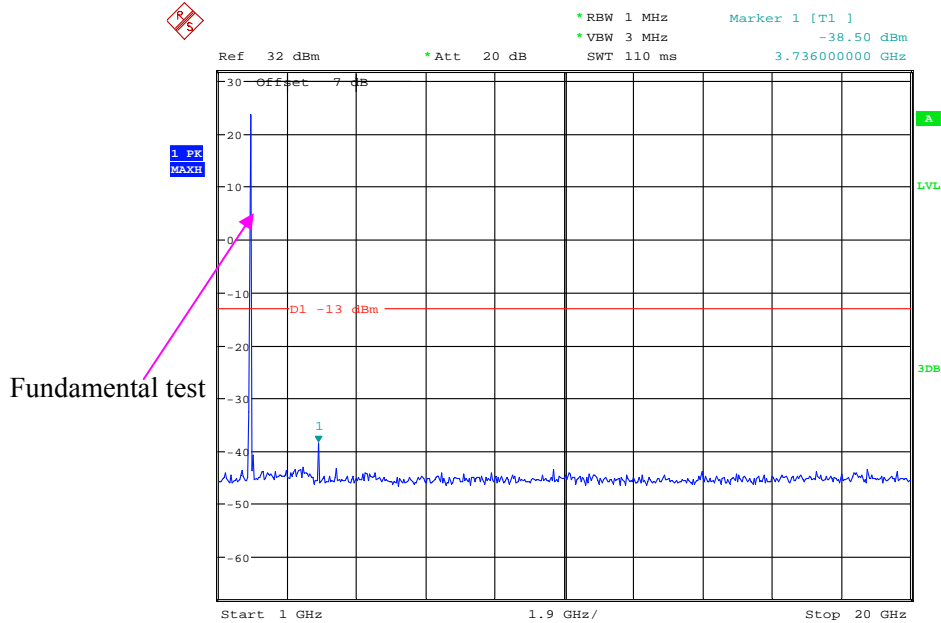

Date: 10.MAR.2021 18:24:00

High Channel:

30 MHz – 1 GHz (GSM Mode)

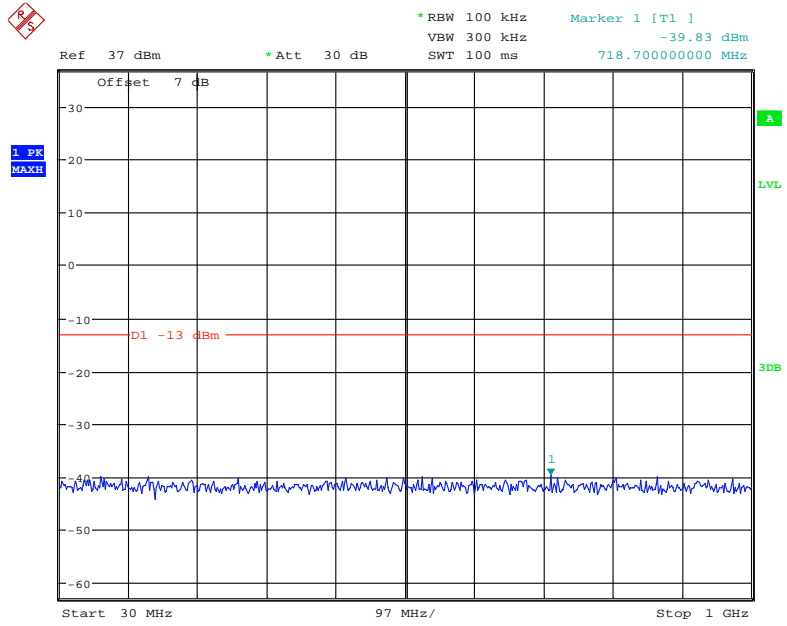

Date: 11.MAR.2021 10:00:23

1 GHz – 2 GHz (GSM Mode)

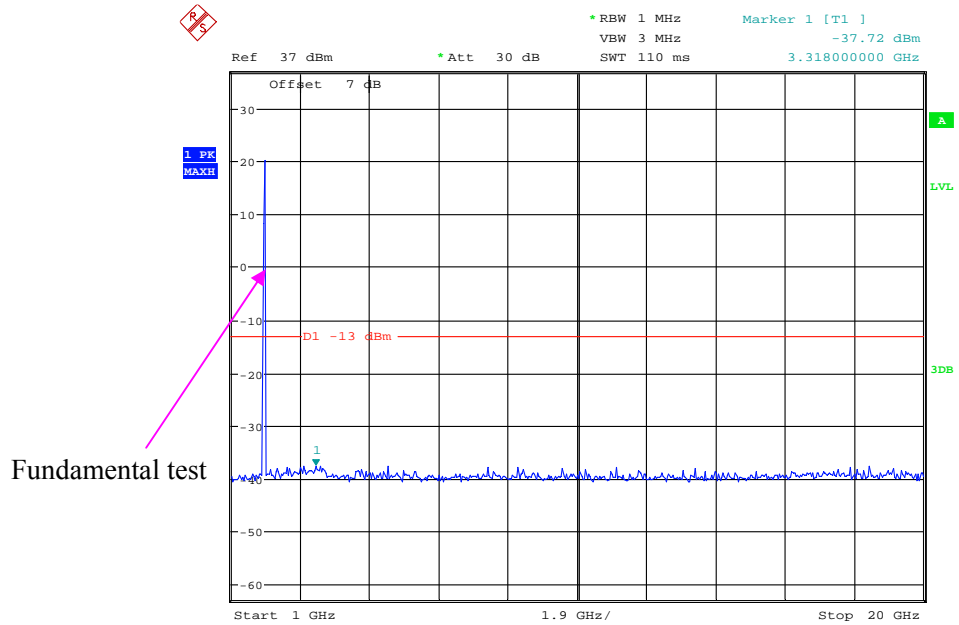

Date: 11.MAR.2021 10:00:10

30 MHz – 1 GHz (WCDMA Mode)

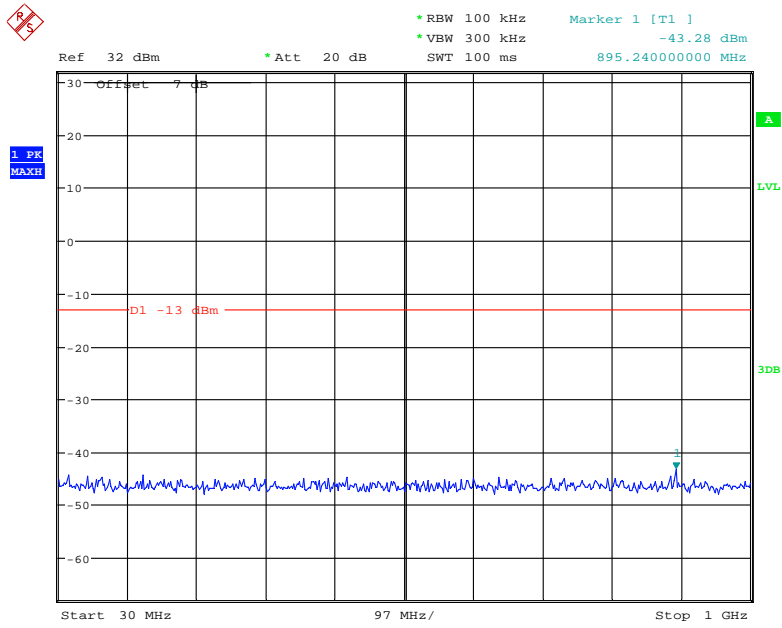

Date: 10.MAR.2021 18:22:57

1 GHz – 20 GHz (WCDMA Mode)

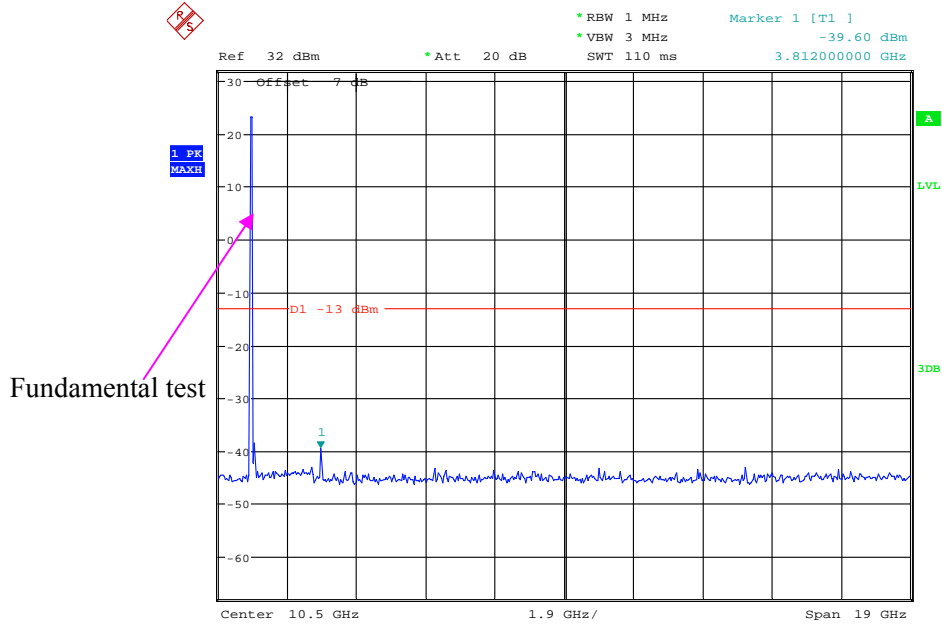

Date: 10.MAR.2021 18:24:24

**AWS Band (Part 27)
Low Channel:**

30 MHz – 1 GHz (WCDMA Mode)

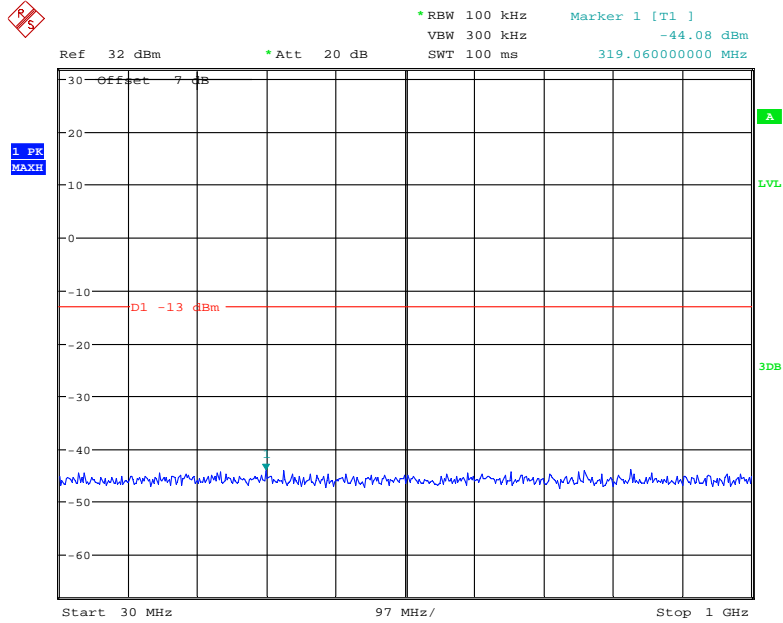

Date: 10.MAR.2021 18:29:46

1 GHz – 20 GHz (WCDMA Mode)

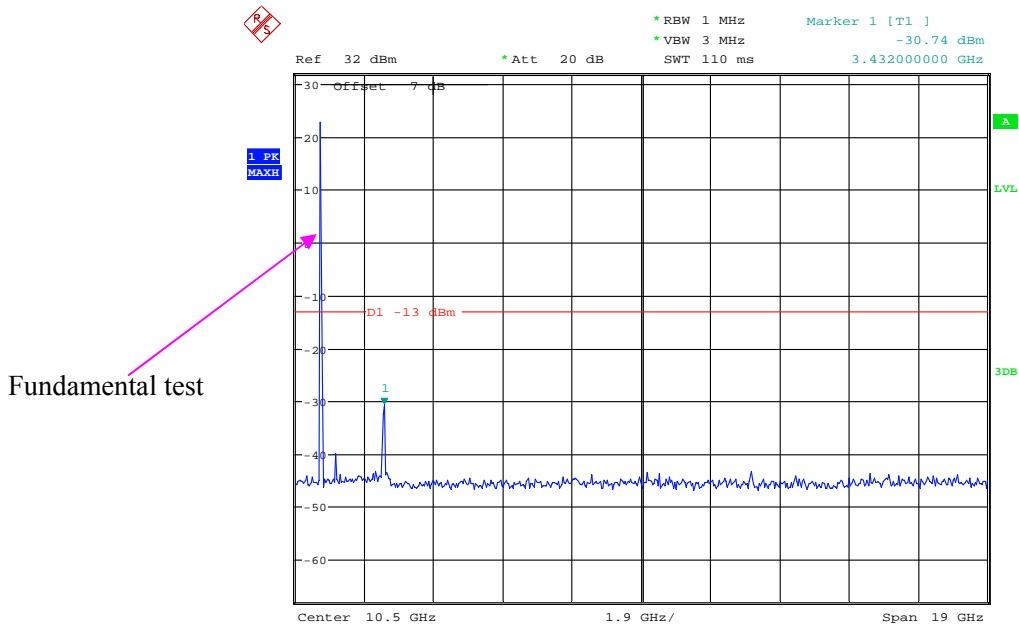

Date: 10.MAR.2021 18:24:52

Middle Channel

30 MHz – 1 GHz (WCDMA Mode)

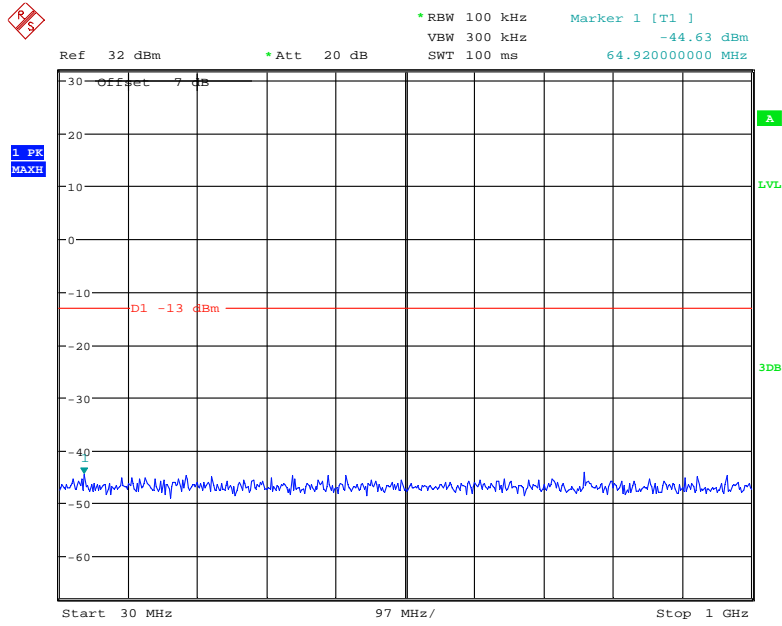

Date: 10.MAR.2021 18:29:35

1 GHz – 20 GHz (WCDMA Mode)

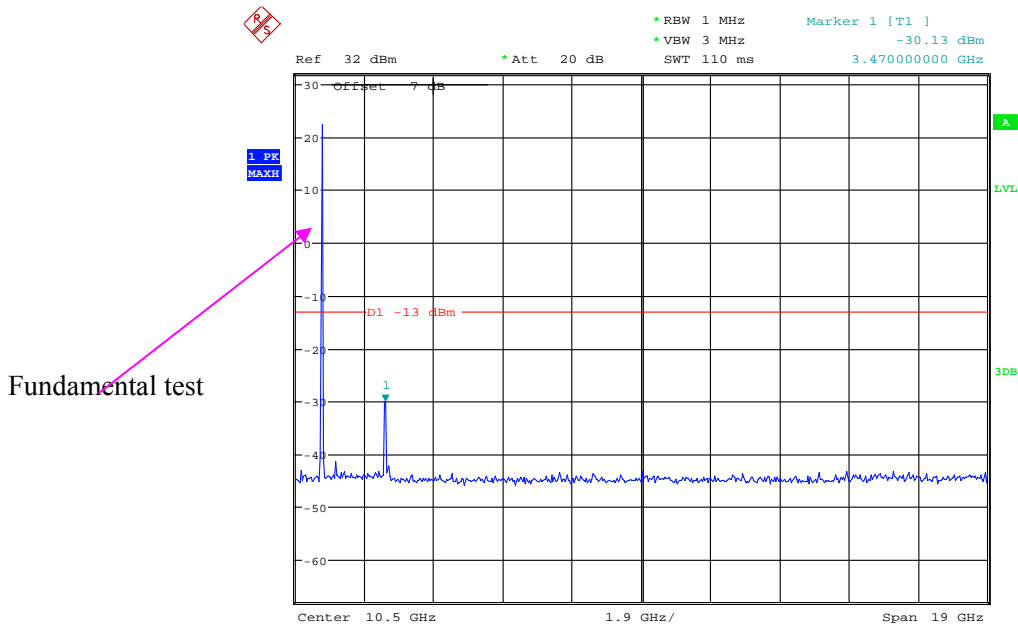

Date: 10.MAR.2021 18:28:06

High Channel:

30 MHz – 1 GHz (WCDMA Mode)

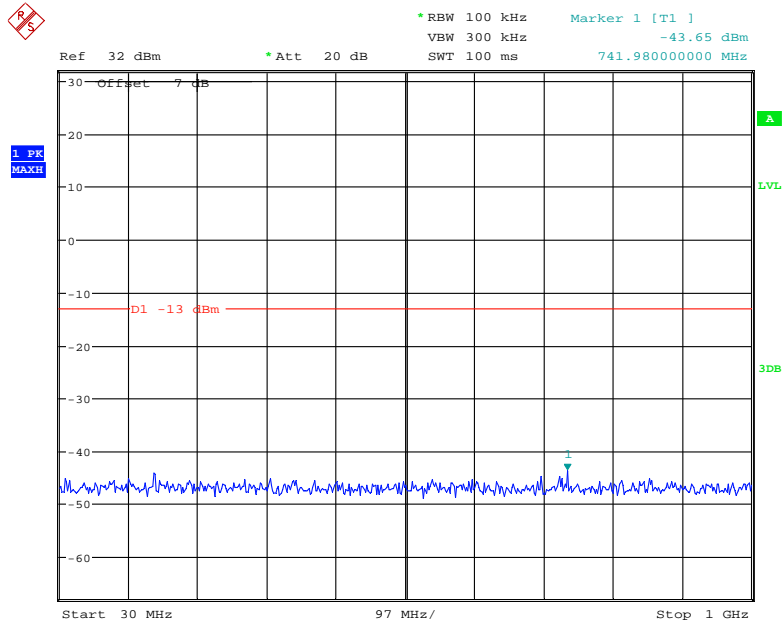

Date: 10.MAR.2021 18:29:09

1 GHz – 20 GHz (WCDMA Mode)

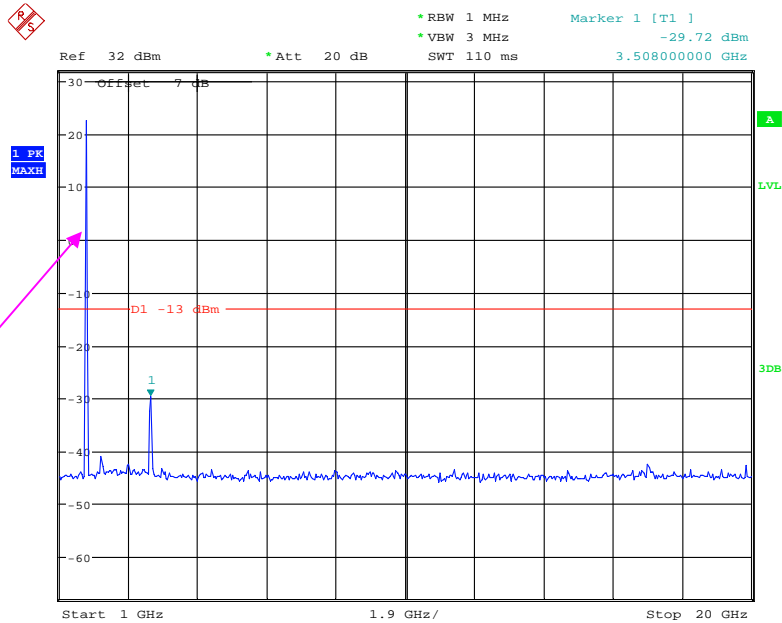

Fundamental test

Date: 10.MAR.2021 18:28:50

The test plots of LTE band please refer to the Appendix B.

FCC § 2.1053; § 22.917 (a); § 24.238 (a); §27.53 SPURIOUS RADIATED EMISSIONS**Applicable Standard**

FCC § 2.1053, §22.917(a) and § 24.238(a) and § 27.53

Test Procedure

The transmitter was placed on a wooden turntable, and it was transmitting into a non-radiating load which was also placed on the turntable.

The measurement antenna was placed at a distance of 3 meters from the EUT. During the tests, the receiving antenna height and polarization as well as EUT azimuth were varied in order to identify the maximum level of emissions from the EUT. The test was performed by placing the EUT on 3-orthogonal axis.

The frequency range up to tenth harmonic of the fundamental frequency was investigated.

Test Data**Environmental Conditions**

Temperature:	24~26.3 °C
Relative Humidity:	46~52 %
ATM Pressure:	101.0~101.1 kPa

The testing was performed by Kilroy Deng from 2021-03-19 to 2021-03-24 for below 1GHz, Troy Wang from 2021-03-27 to 2021-04-02 for above 1GHz.

EUT operation mode: Transmitting

30 MHz ~ 10 GHz:

Cellular Band (Part 22H)

Frequency (MHz)	Receiver Reading (dBµV)	Turntable Angle Degree	Rx Antenna		Substituted			Absolute Level (dBm)	FCC Part 22H	
			Height (m)	Polar (H/V)	Level (dBm)	Cable Loss (dB)	Antenna Gain (dBd/dBi)		Limit (dBm)	Margin (dB)
GSM Mode										
Low channel										
955.3	30.95	94	1.7	H	-65.6	1.36	0.0	-66.96	-13	53.96
955.3	31.25	338	1.3	V	-62.8	1.36	0.0	-64.16	-13	51.16
1648.40	55.96	147	1.2	H	-52.1	1.40	8.70	-44.80	-13	31.80
1648.40	54.62	283	1.4	V	-53.2	1.40	8.70	-45.90	-13	32.90
2472.60	61.66	348	2.1	H	-41.7	2.60	10.20	-34.10	-13	21.10
2472.60	59.78	220	1.9	V	-43.0	2.60	10.20	-35.40	-13	22.40
Middle channel										
957.0	31.95	136	2.5	H	-64.6	1.36	0.0	-65.96	-13	52.96
957.0	32.64	327	2.5	V	-61.4	1.36	0.0	-62.76	-13	49.76
1673.20	55.54	27	1.6	H	-50.8	1.30	8.90	-43.20	-13	30.20
1673.20	54.32	212	2.3	V	-51.4	1.30	8.90	-43.80	-13	30.80
2509.80	61.52	4	2.2	H	-41.8	2.60	10.20	-34.20	-13	21.20
2509.80	59.68	288	1.4	V	-43.1	2.60	10.20	-35.50	-13	22.50
High channel										
954.7	30.95	232	2.0	H	-65.6	1.36	0.0	-66.96	-13	53.96
954.7	32.94	113	1.1	V	-61.1	1.36	0.0	-62.46	-13	49.46
1697.60	55.84	205	1.2	H	-50.5	1.30	8.90	-42.90	-13	29.90
1697.60	54.62	130	1.8	V	-51.1	1.30	8.90	-43.50	-13	30.50
2546.40	61.48	112	1.1	H	-41.9	2.60	10.20	-34.30	-13	21.30
2546.40	59.37	221	1.6	V	-43.4	2.60	10.20	-35.80	-13	22.80

Frequency (MHz)	Receiver Reading (dBμV)	Turntable Angle Degree	Rx Antenna		Substituted			Absolute Level (dBm)	FCC Part 22H	
			Height (m)	Polar (H/V)	Level (dBm)	Cable Loss (dB)	Antenna Gain (dBd/dBi)		Limit (dBm)	Margin (dB)
WCDMA Mode										
Low channel										
949.9	31.59	25	2.3	H	-64.9	1.36	0.0	-66.26	-13	53.26
949.9	30.46	83	1.6	V	-63.6	1.36	0.0	-64.96	-13	51.96
1652.80	45.12	220	1.5	H	-61.2	1.30	8.90	-53.60	-13	40.60
1652.80	46.96	27	1.7	V	-58.8	1.30	8.90	-51.20	-13	38.20
2479.20	47.45	226	1.8	H	-55.9	2.60	10.20	-48.30	-13	35.30
2479.20	49.35	128	1.7	V	-53.4	2.60	10.20	-45.80	-13	32.80
Middle channel										
957.6	30.59	242	1.7	H	-65.9	1.36	0.0	-67.26	-13	54.26
957.6	32.78	148	1.1	V	-61.3	1.36	0.0	-62.66	-13	49.66
1673.20	45.65	319	1.3	H	-60.7	1.30	8.90	-53.10	-13	40.10
1673.20	46.23	178	1.2	V	-59.5	1.30	8.90	-51.90	-13	38.90
2509.80	47.74	42	1.8	H	-55.6	2.60	10.20	-48.00	-13	35.00
2509.80	49.65	14	1.3	V	-53.1	2.60	10.20	-45.50	-13	32.50
High channel										
951.7	31.28	45	1.8	H	-65.2	1.36	0.0	-66.56	-13	53.56
951.7	33.09	59	1.2	V	-61.0	1.36	0.0	-62.36	-13	49.36
1693.20	45.26	237	2.4	H	-61.1	1.30	8.90	-53.50	-13	40.50
1693.20	46.58	187	1.5	V	-59.2	1.30	8.90	-51.60	-13	38.60
2539.80	47.77	315	2.1	H	-55.6	2.60	10.20	-48.00	-13	35.00
2539.80	49.31	148	1.1	V	-53.4	2.60	10.20	-45.80	-13	32.80

30 MHz ~ 20 GHz:

PCS Band (Part 24E)

Frequency (MHz)	Receiver Reading (dBµV)	Turntable Angle Degree	Rx Antenna		Substituted			Absolute Level (dBm)	FCC Part 24E	
			Height (m)	Polar (H/V)	Level (dBm)	Cable Loss (dB)	Antenna Gain (dBd/dBi)		Limit (dBm)	Margin (dB)
GSM Mode										
Low channel										
956.2	32.94	219	2.0	H	-63.6	1.36	0.0	-64.96	-13	51.96
956.2	31.84	342	2.2	V	-62.2	1.36	0.0	-63.56	-13	50.56
3700.40	53.95	350	1.7	H	-48.1	1.60	11.90	-37.80	-13	24.80
3700.40	53.54	280	1.8	V	-48.0	1.60	11.90	-37.70	-13	24.70
5550.60	52.63	177	1.6	H	-43.1	1.70	12.40	-32.40	-13	19.40
5550.60	48.48	175	1.6	V	-46.9	1.70	12.40	-36.20	-13	23.20
Middle channel										
955.6	31.82	220	2.3	H	-64.7	1.36	0.0	-66.06	-13	53.06
955.6	30.93	285	2.5	V	-63.1	1.36	0.0	-64.46	-13	51.46
3760.00	53.98	207	2.0	H	-48.4	1.50	11.80	-38.10	-13	25.10
3760.00	53.68	302	2.2	V	-48.2	1.50	11.80	-37.90	-13	24.90
5640.00	52.84	339	1.5	H	-42.9	1.70	12.40	-32.20	-13	19.20
5640.00	48.24	322	1.2	V	-47.2	1.70	12.40	-36.50	-13	23.50
High channel										
958.6	31.12	12	1.0	H	-65.4	1.36	0.0	-66.76	-13	53.76
958.6	31.97	43	1.5	V	-62.1	1.36	0.0	-63.46	-13	50.46
3819.60	53.84	11	1.0	H	-48.6	1.50	11.80	-38.30	-13	25.30
3819.60	53.54	20	1.8	V	-48.4	1.50	11.80	-38.10	-13	25.10
5729.40	52.81	281	1.8	H	-43.3	1.60	12.10	-32.80	-13	19.80
5729.40	48.36	341	2.2	V	-47.2	1.60	12.10	-36.70	-13	23.70
WCDMA Mode										
Low channel										
952.4	30.94	330	1.2	H	-65.6	1.36	0.0	-66.96	-13	53.96
952.4	32.59	254	2.2	V	-61.5	1.36	0.0	-62.86	-13	49.86
3704.80	47.56	60	1.1	H	-54.2	1.60	11.90	-43.90	-13	30.90
3704.80	48.84	154	1.2	V	-52.4	1.60	11.90	-42.10	-13	29.10
Middle channel										
954.0	31.97	74	1.8	H	-64.5	1.36	0.0	-65.86	-13	52.86
954.0	30.45	351	1.2	V	-63.6	1.36	0.0	-64.96	-13	51.96
3760.00	47.77	87	2.1	H	-54.3	1.50	11.80	-44.00	-13	31.00
3760.00	48.41	240	1.3	V	-53.2	1.50	11.80	-42.90	-13	29.90
High channel										
957.9	33.16	309	1.5	H	-63.3	1.36	0.0	-64.66	-13	51.66
957.9	32.18	205	1.1	V	-61.9	1.36	0.0	-63.26	-13	50.26
3815.20	47.78	296	1.3	H	-54.3	1.50	11.80	-44.00	-13	31.00
3815.20	48.87	153	1.6	V	-52.7	1.50	11.80	-42.40	-13	29.40

30 MHz ~ 20 GHz:

AWS Band

Frequency (MHz)	Receiver Reading (dBµV)	Turntable Angle Degree	Rx Antenna		Substituted			Absolute Level (dBm)	FCC Part 27	
			Height (m)	Polar (H/V)	Level (dBm)	Cable Loss (dB)	Antenna Gain (dBd/dBi)		Limit (dBm)	Margin (dB)
WCDMA Mode										
Low channel										
952.3	31.56	124	1.3	H	-64.9	1.36	0.0	-66.26	-13	53.26
952.3	30.59	272	1.4	V	-63.5	1.36	0.0	-64.86	-13	51.86
3424.80	48.15	63	1.7	H	-52.6	1.40	11.80	-42.20	-13	29.20
3424.80	46.45	276	1.0	V	-54.2	1.40	11.80	-43.80	-13	30.80
Middle channel										
951.8	32.16	174	2.2	H	-64.3	1.36	0.0	-65.66	-13	52.66
951.8	31.95	352	1.8	V	-62.1	1.36	0.0	-63.46	-13	50.46
3465.20	48.61	272	1.0	H	-52.1	1.50	12.00	-41.60	-13	28.60
3465.20	46.54	131	1.4	V	-55.0	1.50	12.00	-44.50	-13	31.50
High channel										
950.2	29.89	96	1.5	H	-66.6	1.36	0.0	-67.96	-13	54.96
950.2	31.52	243	1.8	V	-62.5	1.36	0.0	-63.86	-13	50.86
3505.20	48.65	259	2.3	H	-52.1	1.50	12.00	-41.60	-13	28.60
3505.20	46.91	218	2.0	V	-54.6	1.50	12.00	-44.10	-13	31.10

LTE Band: (Pre-scan with all the bandwidth, and worst case as below)

Frequency (MHz)	Receiver Reading (dBμV)	Turntable Angle Degree	Rx Antenna		Substituted			Absolute Level (dBm)	Limit (dBm)	Margin (dB)
			Height (m)	Polar (H/V)	Level (dBm)	Cable Loss (dB)	Antenna Gain (dBd/dBi)			
Band 2										
Test frequency range: 30 MHz ~ 20 GHz										
1.4MHz, Low channel										
959.5	33.49	44	1.1	H	-63.0	1.36	0.0	-64.36	-13	51.36
959.5	31.28	120	1.2	V	-62.8	1.36	0.0	-64.16	-13	51.16
3701.40	56.47	112	1.7	H	-45.3	1.60	11.90	-35.00	-13	22.00
3701.40	52.62	235	1.5	V	-48.6	1.60	11.90	-38.30	-13	25.30
5552.10	55.41	305	1.3	H	-44.3	1.70	12.40	-33.60	-13	20.60
5552.10	49.51	33	1.6	V	-49.8	1.70	12.40	-39.10	-13	26.10
7402.80	53.53	66	1.7	H	-43.0	2.10	10.60	-34.50	-13	21.50
7402.80	49.81	49	2.3	V	-47.2	2.10	10.60	-38.70	-13	25.70
9253.50	51.42	141	2.1	H	-46.3	2.20	11.80	-36.70	-13	23.70
9253.50	48.28	83	2.3	V	-49.9	2.20	11.80	-40.30	-13	27.30
1.4MHz, Middle channel										
954.7	32.15	2	1.6	H	-64.4	1.36	0.0	-65.76	-13	52.76
954.7	30.58	50	1.2	V	-63.5	1.36	0.0	-64.86	-13	51.86
3760.00	56.34	249	2.2	H	-45.7	1.50	11.80	-35.40	-13	22.40
3760.00	52.67	350	1.7	V	-48.9	1.50	11.80	-38.60	-13	25.60
5640.00	55.38	88	1.7	H	-44.3	1.70	12.40	-33.60	-13	20.60
5640.00	49.55	351	1.6	V	-49.8	1.70	12.40	-39.10	-13	26.10
7520.00	53.31	299	1.2	H	-42.6	1.90	10.70	-33.80	-13	20.80
7520.00	49.93	52	2.2	V	-45.6	1.90	10.70	-36.80	-13	23.80
9400.00	51.59	202	2.3	H	-45.2	2.20	11.50	-35.90	-13	22.90
9400.00	48.25	254	2.5	V	-48.8	2.20	11.50	-39.50	-13	26.50
1.4MHz, High channel										
951.4	30.69	229	2.1	H	-65.8	1.36	0.0	-67.16	-13	54.16
951.4	31.98	225	1.8	V	-62.1	1.36	0.0	-63.46	-13	50.46
3818.60	56.57	160	1.9	H	-45.5	1.50	11.80	-35.20	-13	22.20
3818.60	52.58	357	2.4	V	-49.0	1.50	11.80	-38.70	-13	25.70
5727.90	55.87	231	2.4	H	-44.0	1.60	12.10	-33.50	-13	20.50
5727.90	49.28	221	2.3	V	-50.0	1.60	12.10	-39.50	-13	26.50
7637.20	53.61	107	1.4	H	-43.9	2.10	10.50	-35.50	-13	22.50
7637.20	50.14	277	2.1	V	-47.1	2.10	10.50	-38.70	-13	25.70
9546.50	51.48	43	2.2	H	-45.4	2.20	11.50	-36.10	-13	23.10
9546.50	48.37	237	1.1	V	-48.7	2.20	11.50	-39.40	-13	26.40

Frequency (MHz)	Receiver Reading (dBμV)	Turntable Angle Degree	Rx Antenna		Substituted			Absolute Level (dBm)	Limit (dBm)	Margin (dB)
			Height (m)	Polar (H/V)	Level (dBm)	Cable Loss (dB)	Antenna Gain (dBd/dBi)			
Band 4										
Test frequency range:30 MHz ~ 20 GHz										
1.4MHz, Low channel										
955.3	32.84	243	1.6	H	-63.7	1.36	0.0	-65.06	-13	52.06
955.3	30.51	324	2.2	V	-63.5	1.36	0.0	-64.86	-13	51.86
3421.40	56.37	23	2.2	H	-44.4	1.40	11.80	-34.00	-13	21.00
3421.40	53.18	56	2.2	V	-47.4	1.40	11.80	-37.00	-13	24.00
5132.10	54.65	249	1.4	H	-45.4	1.60	12.10	-34.90	-13	21.90
5132.10	47.38	218	2.3	V	-52.6	1.60	12.10	-42.10	-13	29.10
6842.80	53.38	3	1.1	H	-45.3	1.80	11.20	-35.90	-13	22.90
6842.80	52.15	321	2.1	V	-47.0	1.80	11.20	-37.60	-13	24.60
8553.50	60.25	248	2.3	H	-37.8	2.10	11.40	-28.50	-13	15.50
8553.50	57.37	282	1.9	V	-40.7	2.10	11.40	-31.40	-13	18.40
1.4MHz, Middle channel										
948.7	32.42	40	1.9	H	-64.1	1.36	0.0	-65.46	-13	52.46
948.7	30.69	218	1.4	V	-63.4	1.36	0.0	-64.76	-13	51.76
3465.00	55.92	243	2.4	H	-44.8	1.50	12.00	-34.30	-13	21.30
3465.00	53.26	186	2.0	V	-48.2	1.50	12.00	-37.70	-13	24.70
5197.50	54.45	238	1.9	H	-45.6	1.60	12.10	-35.10	-13	22.10
5197.50	47.50	349	1.6	V	-52.1	1.60	12.10	-41.60	-13	28.60
6930.00	53.22	98	1.8	H	-45.1	1.80	11.30	-35.60	-13	22.60
6930.00	52.26	147	1.2	V	-46.2	1.80	11.30	-36.70	-13	23.70
8662.50	60.82	213	1.3	H	-37.2	2.10	11.40	-27.90	-13	14.90
8662.50	57.23	85	1.3	V	-40.9	2.10	11.40	-31.60	-13	18.60
1.4MHz, High channel										
950.4	33.16	220	1.9	H	-63.3	1.36	0.0	-64.66	-13	51.66
950.4	29.89	140	1.0	V	-64.2	1.36	0.0	-65.56	-13	52.56
3508.60	56.17	114	2.2	H	-44.6	1.50	12.00	-34.10	-13	21.10
3508.60	53.32	68	2.0	V	-48.2	1.50	12.00	-37.70	-13	24.70
5262.90	54.47	172	1.1	H	-45.3	1.60	12.20	-34.70	-13	21.70
5262.90	47.53	98	1.3	V	-51.6	1.60	12.20	-41.00	-13	28.00
7017.20	53.29	223	1.6	H	-45.5	1.90	11.20	-36.20	-13	23.20
7017.20	52.08	344	1.7	V	-46.9	1.90	11.20	-37.60	-13	24.60
8771.50	60.92	213	2.5	H	-36.5	2.10	11.60	-27.00	-13	14.00
8771.50	57.07	154	1.2	V	-39.8	2.10	11.60	-30.30	-13	17.30

Frequency (MHz)	Receiver	Turntable Angle Degree	Rx Antenna		Substituted			Absolute Level (dBm)	Limit (dBm)	Margin (dB)
	Reading (dBμV)		Height (m)	Polar (H/V)	Level (dBm)	Cable Loss (dB)	Antenna Gain (dBd/dBi)			
Band 5										
Test frequency range:30 MHz ~ 10 GHz										
1.4MHz, Low channel										
959.6	31.59	218	1.9	H	-64.9	1.36	0.0	-66.26	-13	53.26
959.6	33.47	10	2.2	V	-60.6	1.36	0.0	-61.96	-13	48.96
1649.40	49.46	270	2.3	H	-58.6	1.40	8.70	-51.30	-13	38.30
1649.40	51.65	134	1.2	V	-56.2	1.40	8.70	-48.90	-13	35.90
2474.10	52.46	82	2.1	H	-50.9	2.60	10.20	-43.30	-13	30.30
2474.10	53.14	250	2.1	V	-49.6	2.60	10.20	-42.00	-13	29.00
1.4MHz, Middle channel										
957.6	31.06	52	1.0	H	-65.4	1.36	0.0	-66.76	-13	53.76
957.6	32.59	353	2.3	V	-61.5	1.36	0.0	-62.86	-13	49.86
1673.00	49.84	1	2.2	H	-56.5	1.30	8.90	-48.90	-13	35.90
1673.00	51.31	223	2.5	V	-54.4	1.30	8.90	-46.80	-13	33.80
2509.50	52.89	188	1.7	H	-50.5	2.60	10.20	-42.90	-13	29.90
2509.50	53.51	228	2.1	V	-49.2	2.60	10.20	-41.60	-13	28.60
1.4MHz, High channel										
960.3	30.59	318	1.8	H	-65.9	1.36	0.0	-67.26	-13	54.26
960.3	32.71	134	1.4	V	-61.3	1.36	0.0	-62.66	-13	49.66
1696.60	49.78	62	2.2	H	-56.6	1.30	8.90	-49.00	-13	36.00
1696.60	51.96	262	1.4	V	-53.8	1.30	8.90	-46.20	-13	33.20
2544.90	52.54	142	2.3	H	-50.8	2.60	10.20	-43.20	-13	30.20
2544.90	53.18	311	2.1	V	-49.6	2.60	10.20	-42.00	-13	29.00
Band 7										
Test frequency range: 30 MHz ~ 26.5 GHz										
5MHz, Low channel										
954.4	31.11	155	2.0	H	-65.4	1.36	0.0	-66.76	-25	41.76
954.4	33.75	272	1.1	V	-60.3	1.36	0.0	-61.66	-25	36.66
5005.00	57.46	236	1.8	H	-43.1	1.70	12.00	-32.80	-25	7.80
5005.00	52.81	9	2.0	V	-47.2	1.70	12.00	-36.90	-25	11.90
7507.50	53.18	143	2.0	H	-42.7	1.90	10.70	-33.90	-25	8.90
7507.50	50.04	226	1.9	V	-45.5	1.90	10.70	-36.70	-25	11.70
5MHz, Middle channel										
959.6	31.55	64	1.1	H	-65.0	1.36	0.0	-66.36	-25	41.36
959.6	30.19	292	1.0	V	-63.9	1.36	0.0	-65.26	-25	40.26
5070.00	58.82	88	2.1	H	-41.2	1.60	12.10	-30.70	-25	5.70
5070.00	52.82	239	1.5	V	-47.2	1.60	12.10	-36.70	-25	11.70
7605.00	53.49	4	2.3	H	-44.0	2.10	10.50	-35.60	-25	10.60
7605.00	50.12	1	1.5	V	-47.2	2.10	10.50	-38.80	-25	13.80
5MHz, High channel										
951.7	30.69	96	1.7	H	-65.8	1.36	0.0	-67.16	-25	42.16
951.7	32.81	323	1.0	V	-61.2	1.36	0.0	-62.56	-25	37.56
5135.00	57.57	171	1.4	H	-42.4	1.60	12.10	-31.90	-25	6.90
5135.00	52.25	16	1.9	V	-47.8	1.60	12.10	-37.30	-25	12.30
7702.50	53.94	343	1.9	H	-43.6	2.10	10.50	-35.20	-25	10.20
7702.50	51.52	55	2.2	V	-45.8	2.10	10.50	-37.40	-25	12.40

Frequency (MHz)	Receiver Reading (dBµV)	Turntable Angle Degree	Rx Antenna		Substituted			Absolute Level (dBm)	Limit (dBm)	Margin (dB)
			Height (m)	Polar (H/V)	Level (dBm)	Cable Loss (dB)	Antenna Gain (dBd/dBi)			
Band 17										
Test frequency range: 30 MHz ~ 10 GHz										
5MHz, Low channel										
956.6	33.28	151	1.1	H	-63.2	1.36	0.0	-64.56	-13	51.56
956.6	31.57	54	1.6	V	-62.5	1.36	0.0	-63.86	-13	50.86
1413.00	54.71	164	1.3	H	-53.5	1.60	7.90	-47.20	-13	34.20
1413.00	47.53	43	1.2	V	-60.9	1.60	7.90	-54.60	-13	41.60
2119.50	59.11	280	2.3	H	-42.0	1.30	9.70	-33.60	-13	20.60
2119.50	53.24	27	2.0	V	-48.7	1.30	9.70	-40.30	-13	27.30
5MHz, Middle channel										
952.4	30.56	38	2.1	H	-65.9	1.36	0.0	-67.26	-13	54.26
952.4	33.45	330	1.8	V	-60.6	1.36	0.0	-61.96	-13	48.96
1420.00	50.41	194	1.3	H	-57.8	1.60	7.90	-51.50	-13	38.50
1420.00	46.55	243	1.7	V	-61.9	1.60	7.90	-55.60	-13	42.60
2130.00	56.25	181	1.2	H	-44.9	1.30	9.70	-36.50	-13	23.50
2130.00	53.46	255	1.3	V	-48.5	1.30	9.70	-40.10	-13	27.10
5MHz, High channel										
959.2	31.69	12	2.3	H	-64.8	1.36	0.0	-66.16	-13	53.16
959.2	33.74	84	1.6	V	-60.3	1.36	0.0	-61.66	-13	48.66
1427.00	55.64	229	2.3	H	-52.5	1.60	7.90	-46.20	-13	33.20
1427.00	51.54	20	2.3	V	-56.9	1.60	7.90	-50.60	-13	37.60
2140.50	53.49	234	1.7	H	-47.6	1.30	9.70	-39.20	-13	26.20
2140.50	50.57	129	2.2	V	-51.4	1.30	9.70	-43.00	-13	30.00
Band 38										
Test frequency range: 30 MHz ~26.5GHz										
5MHz, Low channel										
956.2	31.29	34	1.5	H	-65.2	1.36	0.0	-66.56	-25	41.56
956.2	31.61	304	1.7	V	-62.4	1.36	0.0	-63.76	-25	38.76
5145.00	54.47	284	1.6	H	-45.5	1.60	12.10	-35.00	-25	10.00
5145.00	51.24	192	2.4	V	-48.8	1.60	12.10	-38.30	-25	13.30
7717.50	56.15	210	1.5	H	-41.4	2.10	10.50	-33.00	-25	8.00
7717.50	51.14	155	2.4	V	-46.1	2.10	10.50	-37.70	-25	12.70
5MHz, Middle channel										
951.4	30.62	116	1.2	H	-65.9	1.36	0.0	-67.26	-25	42.26
951.4	33.46	211	1.0	V	-60.6	1.36	0.0	-61.96	-25	36.96
5190.00	54.30	8	2.0	H	-45.8	1.60	12.10	-35.30	-25	10.30
5190.00	50.85	30	1.1	V	-48.8	1.60	12.10	-38.30	-25	13.30
7785.00	55.92	19	2.4	H	-40.3	2.00	10.50	-31.80	-25	6.80
7785.00	51.21	165	1.2	V	-45.0	2.00	10.50	-36.50	-25	11.50
5MHz, High channel										
949.6	31.26	359	1.4	H	-65.2	1.36	0.0	-66.56	-25	41.56
949.6	30.82	40	1.7	V	-63.2	1.36	0.0	-64.56	-25	39.56
5235.00	54.67	42	1.2	H	-45.4	1.60	12.10	-34.90	-25	9.90
5235.00	51.31	309	2.1	V	-48.3	1.60	12.10	-37.80	-25	12.80
7852.50	56.19	201	2.3	H	-40.1	2.00	10.50	-31.60	-25	6.60
7852.50	51.21	254	1.0	V	-45.0	2.00	10.50	-36.50	-25	11.50

Frequency (MHz)	Receiver Reading (dBµV)	Turntable Angle Degree	Rx Antenna		Substituted			Absolute Level (dBm)	Limit (dBm)	Margin (dB)
			Height (m)	Polar (H/V)	Level (dBm)	Cable Loss (dB)	Antenna Gain (dBd/dBi)			
Band 41										
Test frequency range: 30 MHz ~26.5GHz										
5MHz, Low channel										
958.5	31.46	302	1.4	H	-65.0	1.36	0.0	-66.36	-25	41.36
958.5	32.50	140	1.4	V	-61.6	1.36	0.0	-62.96	-25	37.96
5075.00	53.21	113	2.2	H	-46.8	1.60	12.10	-36.30	-25	11.30
5075.00	50.61	58	2.3	V	-49.4	1.60	12.10	-38.90	-25	13.90
7612.50	55.72	310	2.4	H	-41.8	2.10	10.50	-33.40	-25	8.40
7612.50	51.42	124	2.4	V	-45.9	2.10	10.50	-37.50	-25	12.50
5MHz, Middle channel										
952.3	32.64	22	1.9	H	-63.9	1.36	0.0	-65.26	-25	40.26
952.3	31.28	108	2.0	V	-62.8	1.36	0.0	-64.16	-25	39.16
5190.00	52.92	342	1.5	H	-47.2	1.60	12.10	-36.70	-25	11.70
5190.00	50.62	258	2.0	V	-49.0	1.60	12.10	-38.50	-25	13.50
7785.00	55.86	227	1.8	H	-40.4	2.00	10.50	-31.90	-25	6.90
7785.00	51.38	54	2.0	V	-44.8	2.00	10.50	-36.30	-25	11.30
5 MHz, High channel										
956.5	31.09	168	1.9	H	-65.4	1.36	0.0	-66.76	-25	41.76
956.5	30.24	97	1.4	V	-63.8	1.36	0.0	-65.16	-25	40.16
5305.00	53.13	319	1.6	H	-46.6	1.60	12.20	-36.00	-25	11.00
5305.00	50.65	207	1.0	V	-48.5	1.60	12.20	-37.90	-25	12.90
7957.50	56.92	61	1.8	H	-41.1	2.10	10.70	-32.50	-25	7.50
7957.50	50.02	108	1.4	V	-48.0	2.10	10.70	-39.40	-25	14.40
Band 66										
Test frequency range: 30 MHz ~ 20GHz										
1.4MHz, Low channel										
955.2	32.82	281	1.6	H	-63.7	1.36	0.0	-65.06	-13	52.06
955.2	31.44	126	2.0	V	-62.6	1.36	0.0	-63.96	-13	50.96
3421.40	60.68	211	1.6	H	-40.1	1.40	11.80	-29.70	-13	16.70
3421.40	61.34	242	1.7	V	-39.3	1.40	11.80	-28.90	-13	15.90
1.4MHz, Middle channel										
959.6	31.92	84	1.8	H	-64.6	1.36	0.0	-65.96	-13	52.96
959.6	30.67	218	1.3	V	-63.4	1.36	0.0	-64.76	-13	51.76
3510.00	60.26	317	1.9	H	-40.5	1.50	12.00	-30.00	-13	17.00
3510.00	61.32	88	1.5	V	-40.2	1.50	12.00	-29.70	-13	16.70
1.4MHz, High channel										
960.4	32.51	230	1.5	H	-64.0	1.36	0.0	-65.36	-13	52.36
960.4	31.76	99	2.4	V	-62.3	1.36	0.0	-63.66	-13	50.66
3558.60	60.83	171	1.3	H	-40.7	1.50	12.10	-30.10	-13	17.10
3558.60	61.65	322	1.1	V	-39.4	1.50	12.10	-28.80	-13	15.80

Note:

Absolute Level = Substituted Level - Cable loss + Antenna Gain

Margin = Limit- Absolute Level

dBd is for the ERP, dBi is for EIRP.

FCC § 22.917 (a); § 24.238 (a); §27.53(c) (h)(m) - BAND EDGES

Applicable Standard

According to § 22.917(a), the power of any emissions outside of the authorized operating frequency ranges must be attenuated below the transmitting power (P) by a factor of at least 43 + 10 log(P) dB.

According to §24.238(a), the power of any emissions outside of the authorized operating frequency ranges must be attenuated below the transmitting power (P) by a factor of at least 43 + 10 log(P) dB.

According to FCC §27.53 (c)(h)(m), the power of any emission outside of the authorized operating frequency ranges must be attenuated below the transmitting power (P) by a factor of at least 43 + 10 log(P) dB.

Test Procedure

The RF output of the transmitter was connected to the input of the spectrum analyzer through sufficient attenuation.

The center of the spectrum analyzer was set to block edge frequency

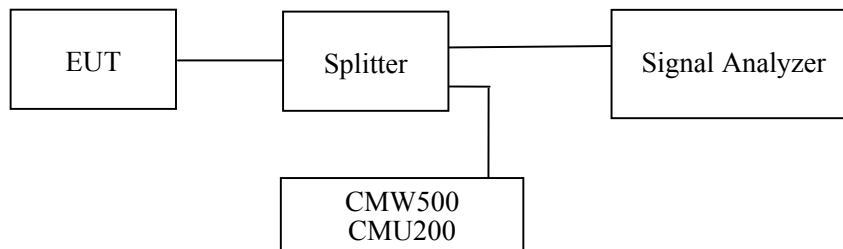

Test Data

Environmental Conditions

Temperature:	24~26.5 °C
Relative Humidity:	54~56 %
ATM Pressure:	100.0~101.0 kPa

The testing was performed by Black Chen from 2021-03-09 to 2021-03-11.

EUT operation mode: Transmitting (Worst case)

Test Result: Pass

Please refer to the following plots.

Cellular Band, Left Band Edge for GSM (GMSK) Mode

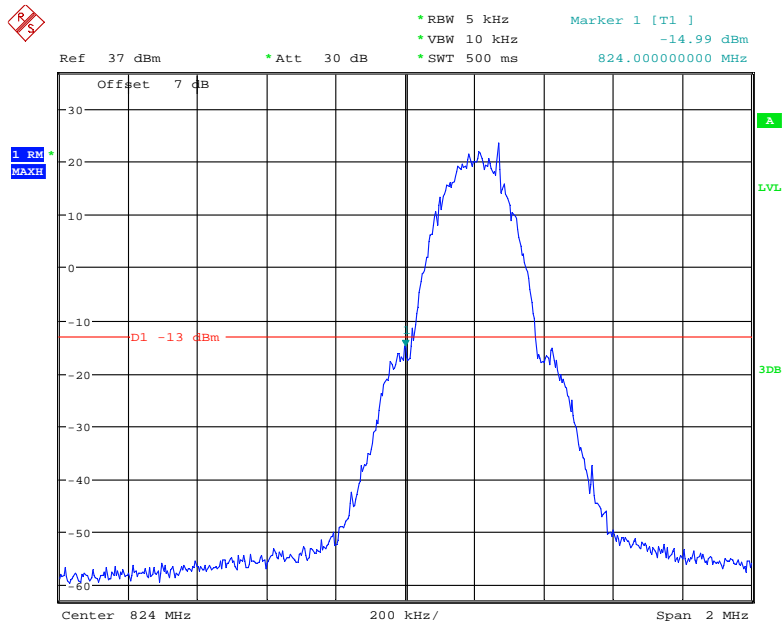

Date: 11.MAR.2021 08:59:02

Cellular Band, Right Band Edge for GSM (GMSK) Mode

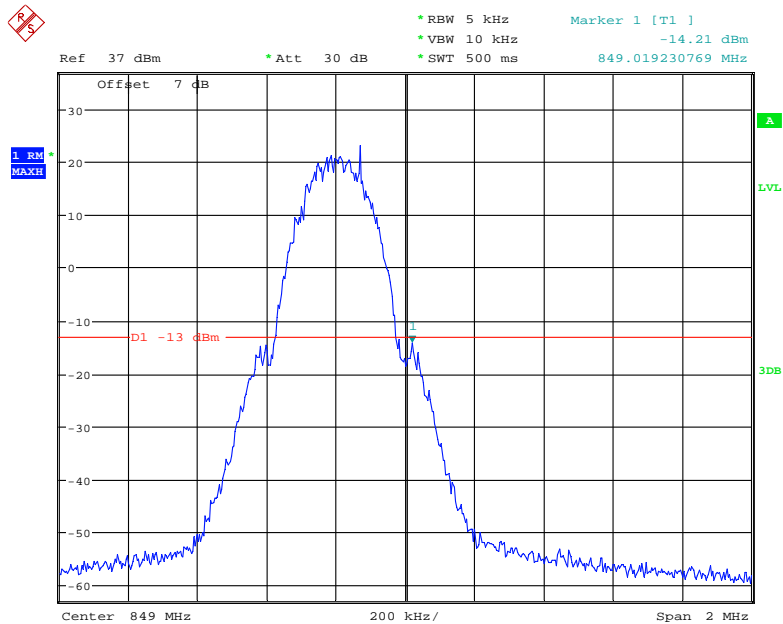

Date: 11.MAR.2021 09:00:28

Cellular Band, Left Band Edge for EGPRS (GMSK) Mode

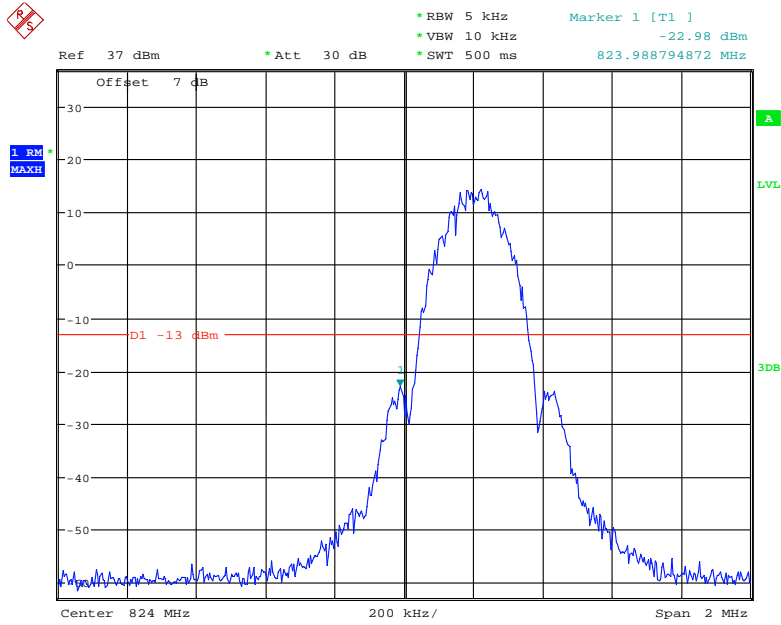

Date: 11.MAR.2021 09:04:25

Cellular Band, Right Band Edge for EGPRS (GMSK) Mode

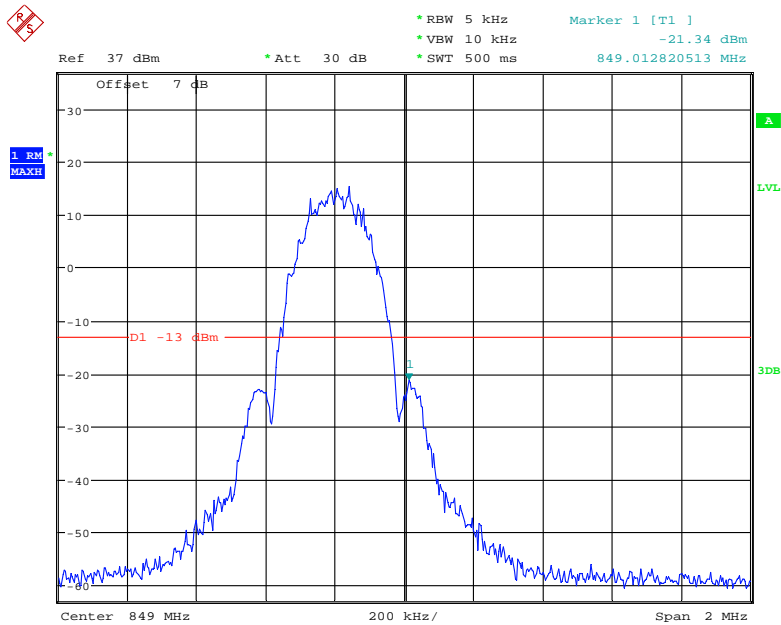

Date: 11.MAR.2021 09:03:45

Cellular Band, Left Band Edge for WCDMA (BPSK) Mode

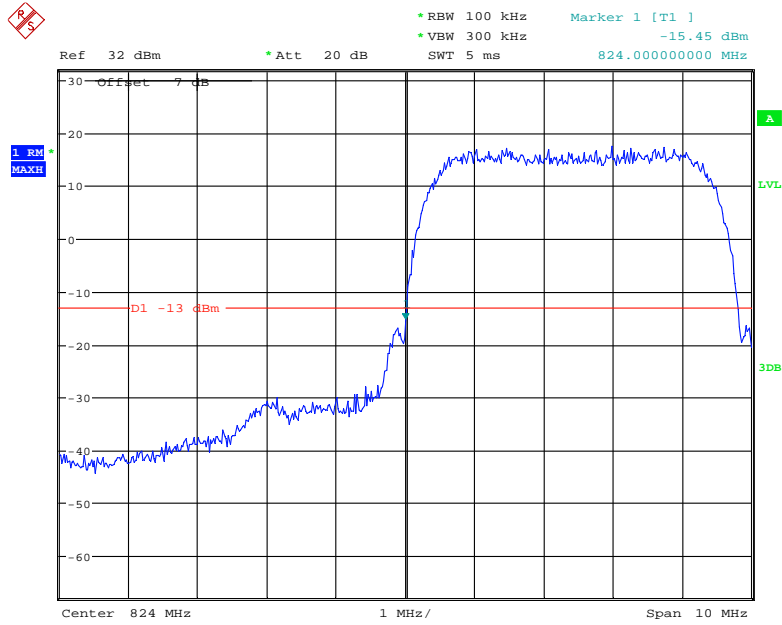

Date: 10.MAR.2021 17:03:57

Cellular Band, Right Band Edge for WCDMA (BPSK) Mode

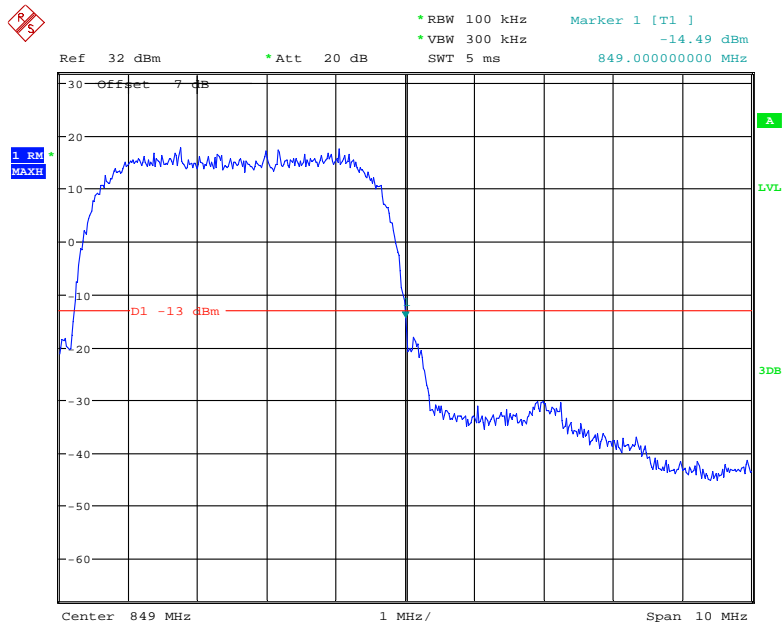

Date: 10.MAR.2021 17:04:20

Cellular Band, Left Band Edge for HSDPA (16QAM) Mode

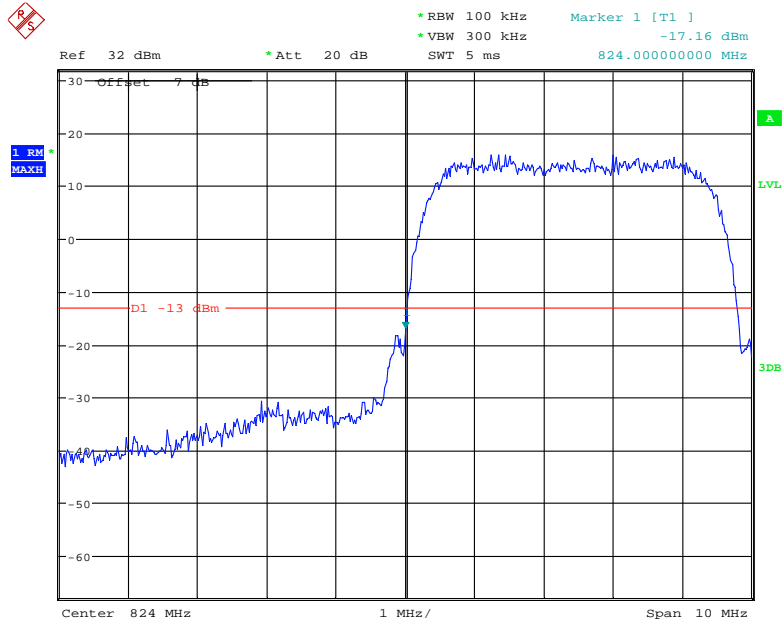

Date: 10.MAR.2021 17:05:26

Cellular Band, Right Band Edge for HSDPA (16QAM) Mode

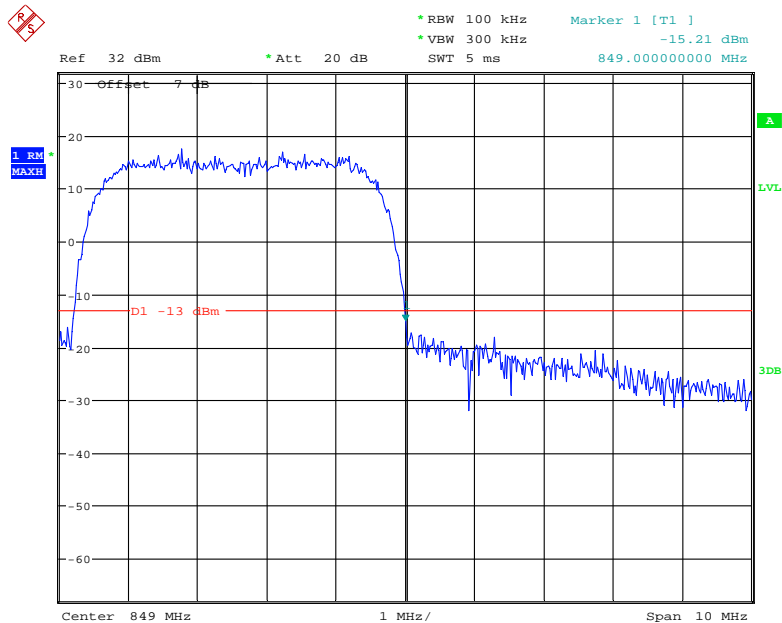

Date: 10.MAR.2021 17:05:07

Cellular Band, Left Band Edge for HSUPA (BPSK) Mode

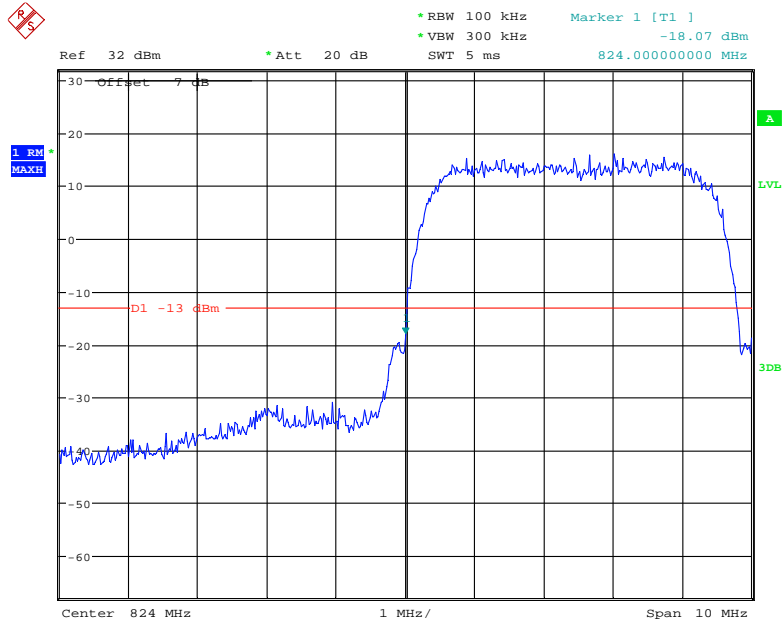

Date: 10.MAR.2021 17:05:59

Cellular Band, Right Band Edge for HSUPA (BPSK) Mode

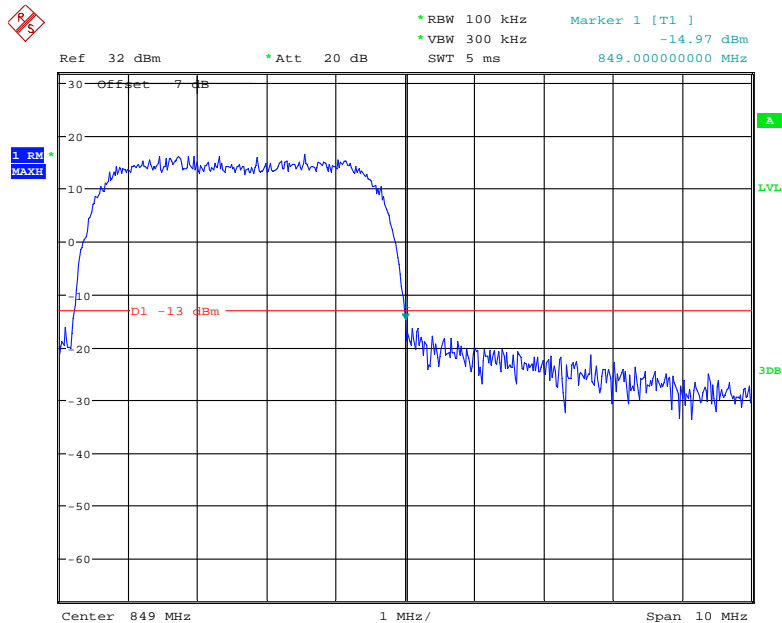

Date: 10.MAR.2021 17:06:37

PCS Band, Left Band Edge for GSM (GMSK) Mode

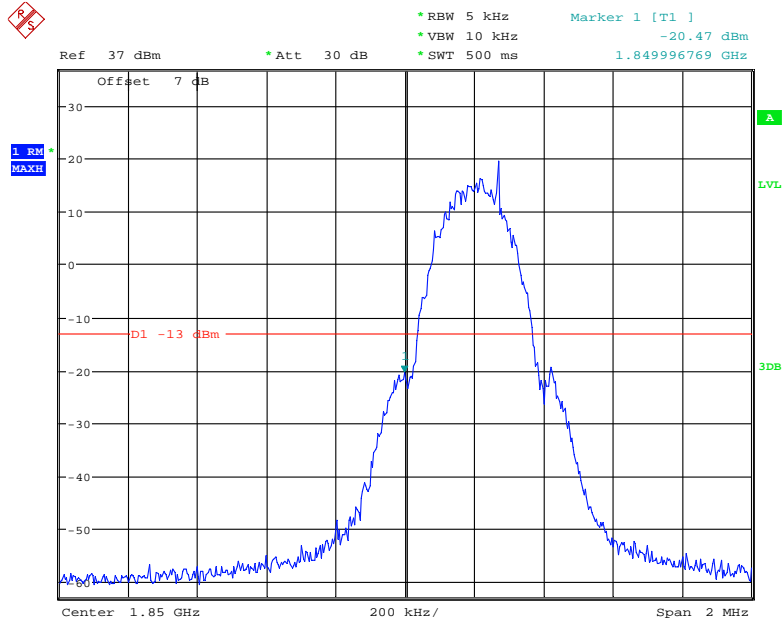

Date: 11.MAR.2021 09:16:53

PCS Band, Right Band Edge for GSM (GMSK) Mode

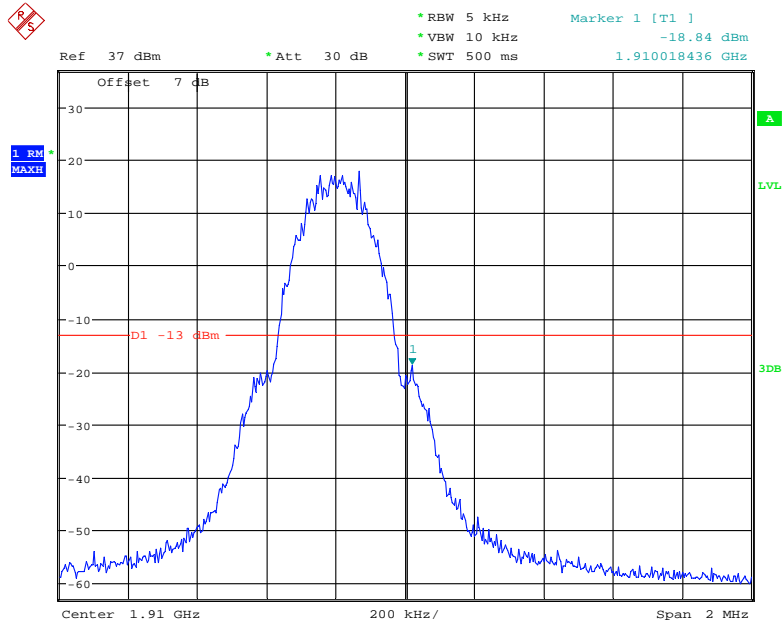

Date: 11.MAR.2021 09:16:07

PCS Band, Left Band Edge for EGPRS (GMSK) Mode

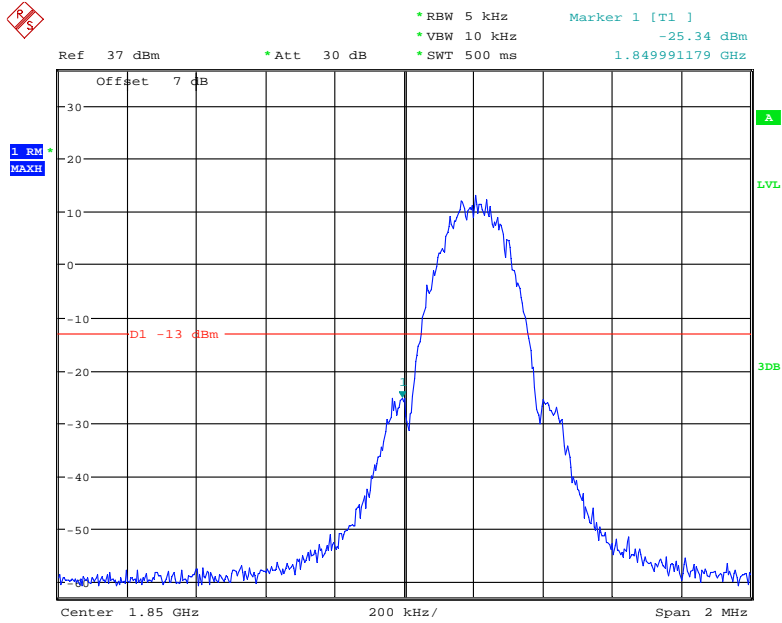

Date: 11.MAR.2021 09:13:53

PCS Band, Right Band Edge for EGPRS (GMSK) Mode

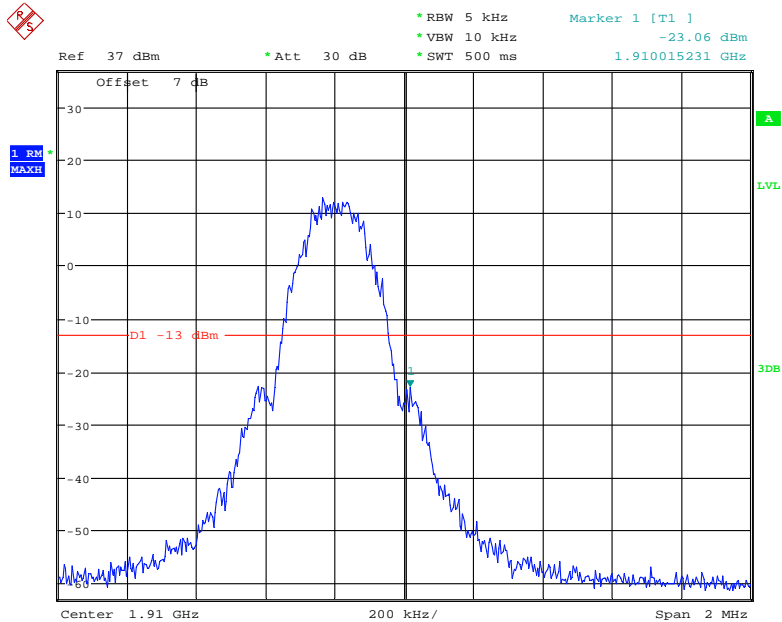

Date: 11.MAR.2021 09:14:29

PCS Band, Left Band Edge for WCDMA (BPSK) Mode

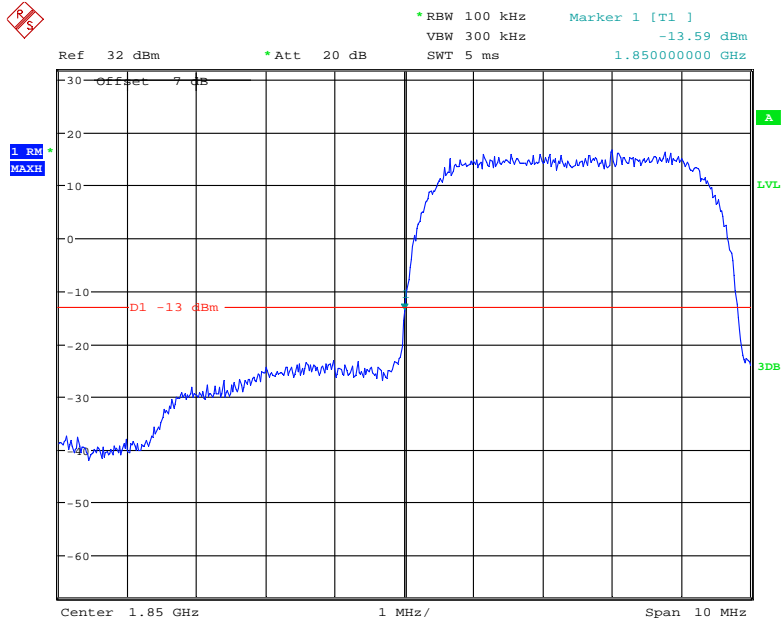

Date: 10.MAR.2021 16:52:46

PCS Band, Right Band Edge for WCDMA (BPSK) Mode

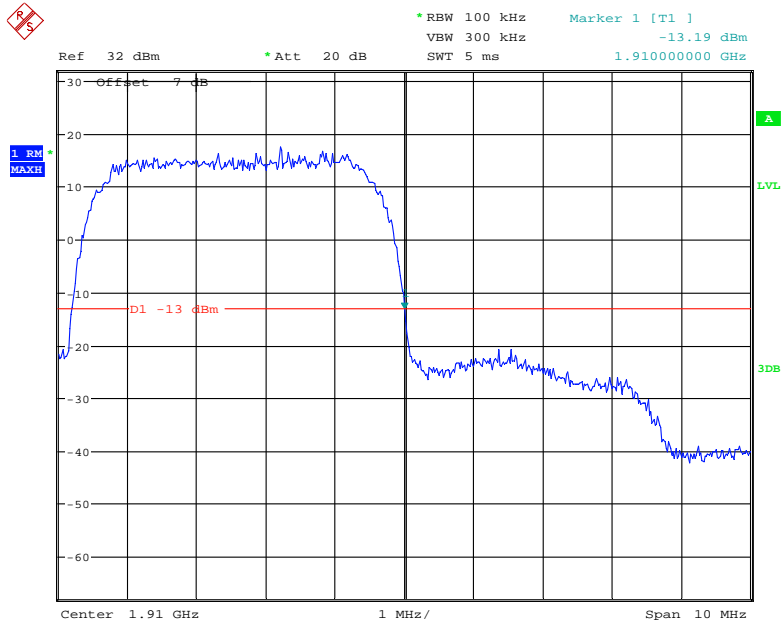

Date: 10.MAR.2021 16:53:46

PCS Band, Left Band Edge for HSDPA (16QAM) Mode

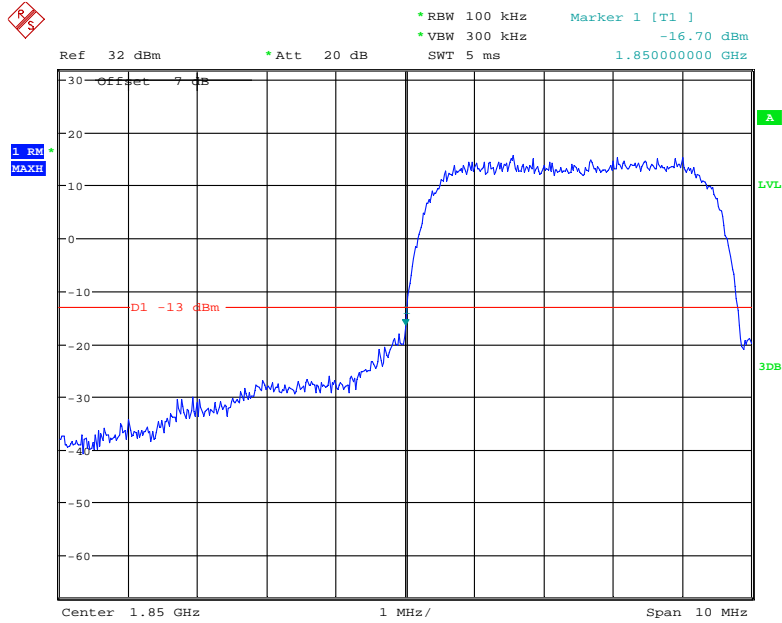

Date: 10.MAR.2021 16:57:44

PCS Band, Right Band Edge for HSDPA (16QAM) Mode

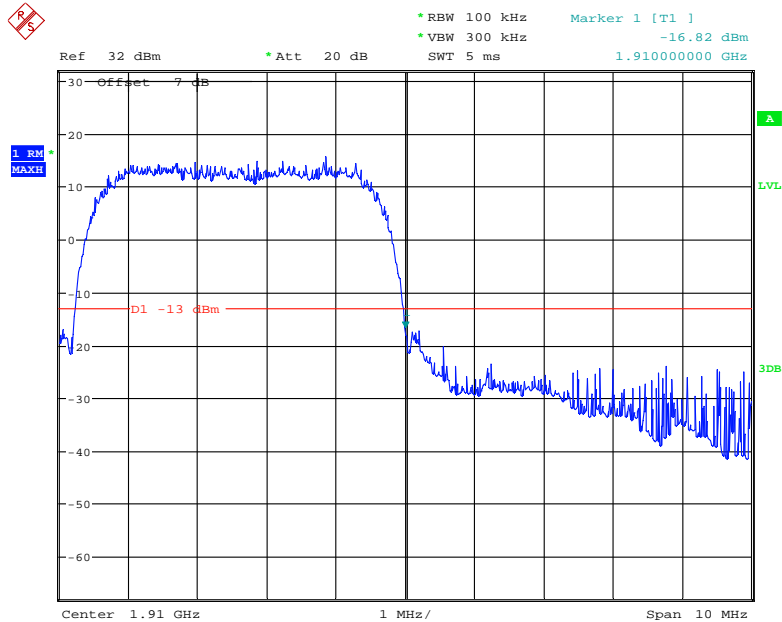

Date: 14.APR.2021 20:04:58

PCS Band, Left Band Edge for HSUPA (BPSK) Mode

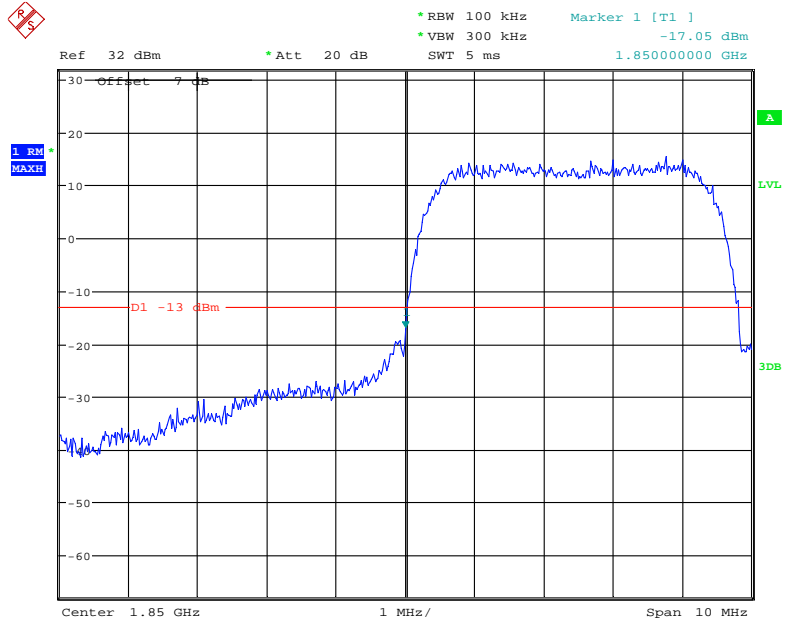

Date: 10.MAR.2021 16:58:16

PCS Band, Right Band Edge for HSUPA (BPSK) Mode

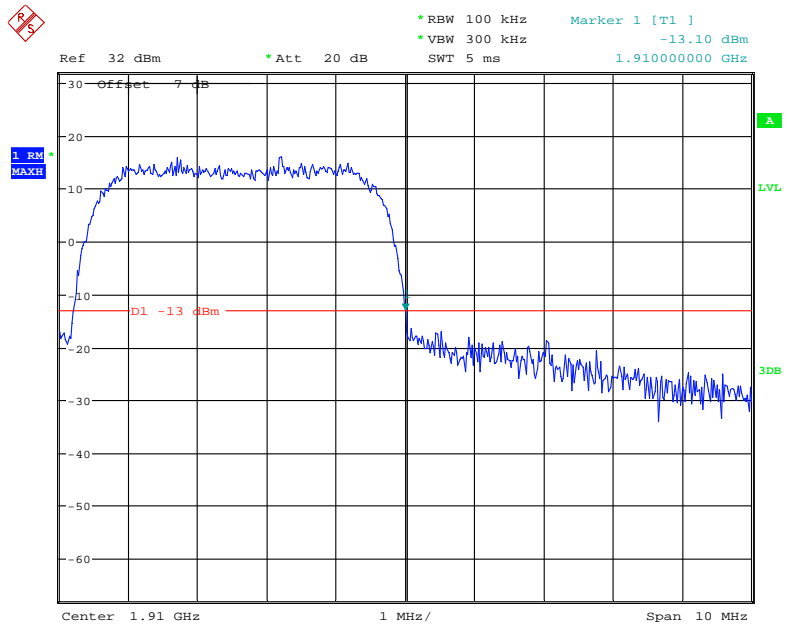

Date: 10.MAR.2021 16:59:03

AWS Band, Left Band Edge for WCDMA (BPSK) Mode

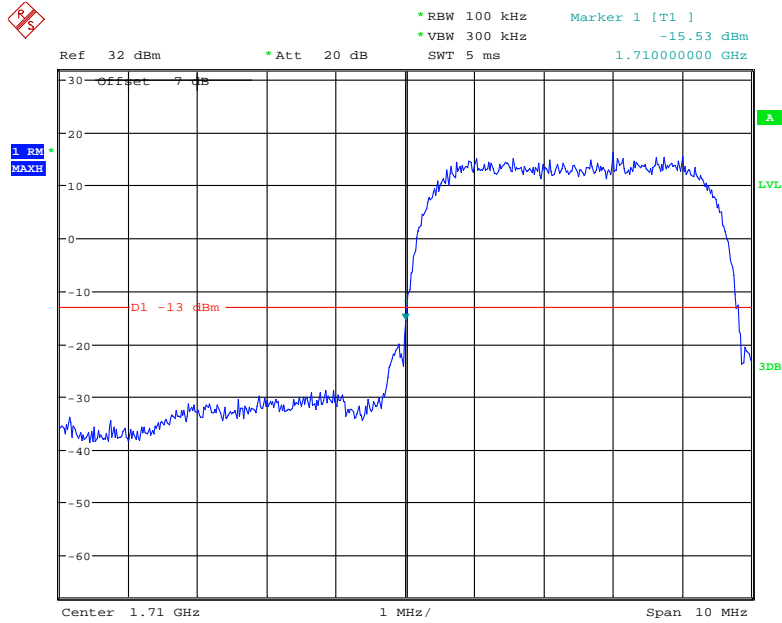

Date: 10.MAR.2021 17:02:22

AWS Band, Right Band Edge for WCDMA (BPSK) Mode

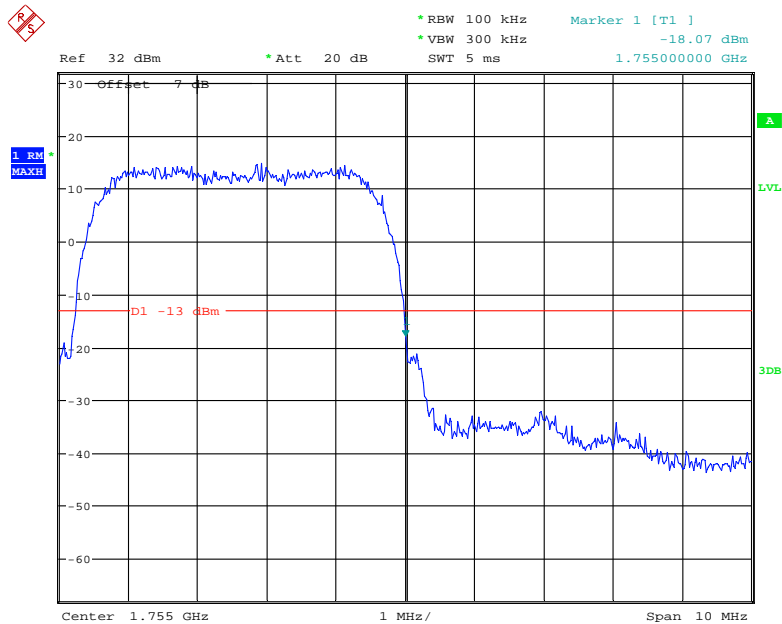

Date: 10.MAR.2021 17:03:19

AWS Band, Left Band Edge for HSDPA (16QAM) Mode

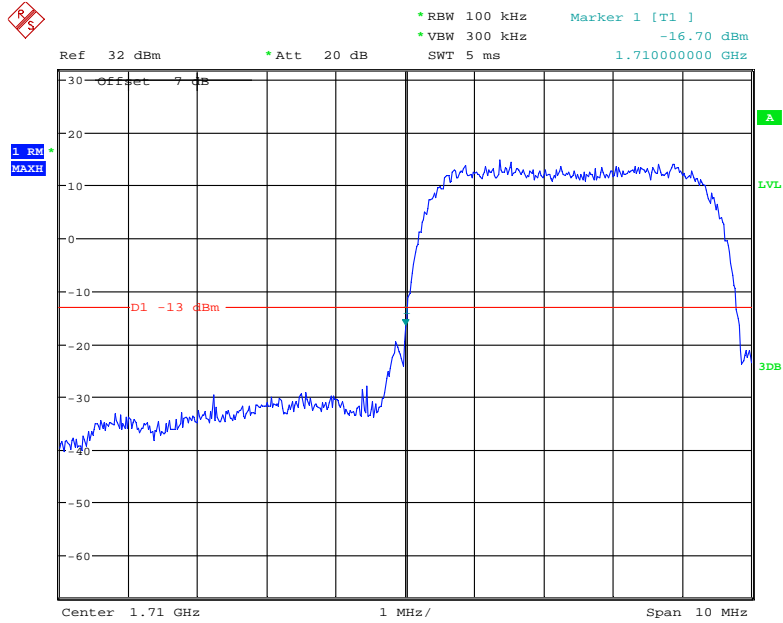

Date: 10.MAR.2021 17:01:48

AWS Band, Right Band Edge for HSDPA (16QAM) Mode

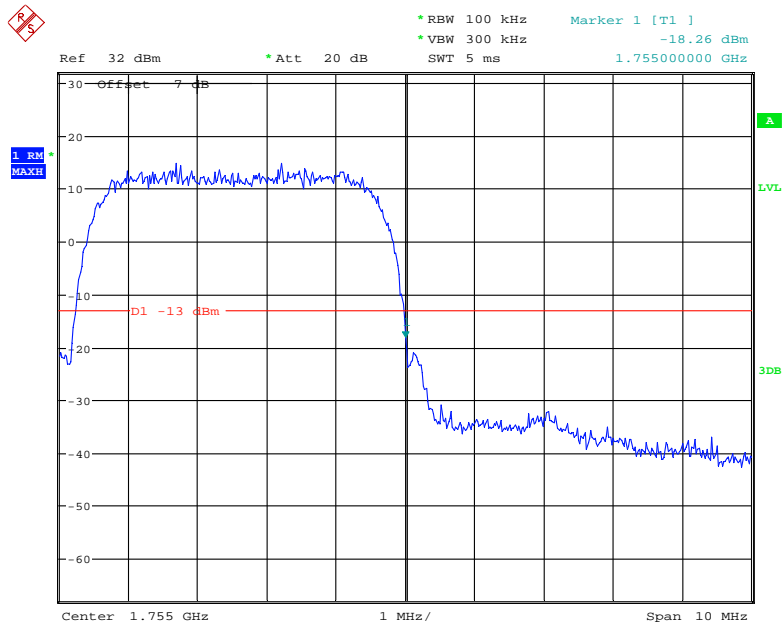

Date: 10.MAR.2021 17:01:15

AWS Band, Left Band Edge for HSUPA (BPSK) Mode

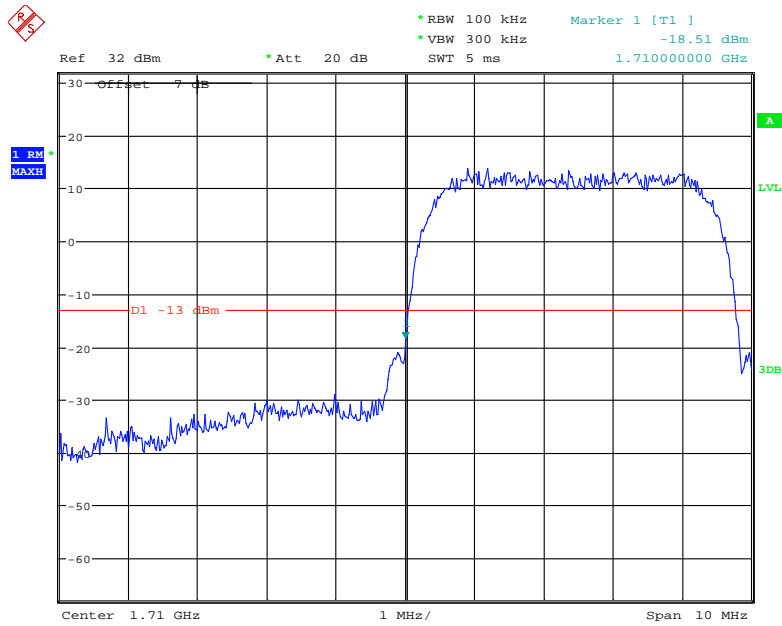

Date: 10.MAR.2021 16:59:58

AWS Band, Right Band Edge for HSUPA (BPSK) Mode

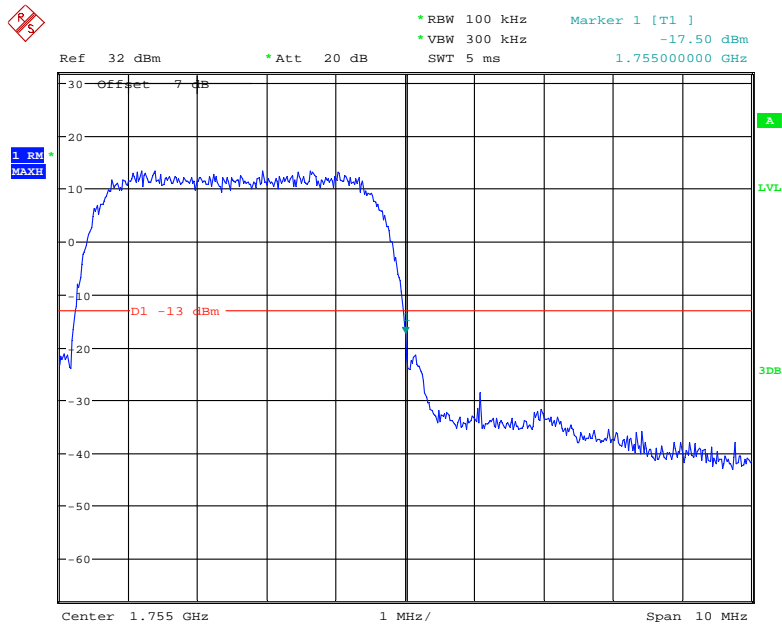

Date: 10.MAR.2021 17:00:23

The test plots of LTE bands please refer to the Appendix C.

FCC § 2.1055; § 22.355; § 24.235; §27.54 - FREQUENCY STABILITY

Applicable Standard

FCC § 2.1055, §22.355, §24.235 and & §27.54.

According to FCC §2.1055, the frequency stability shall be sufficient to ensure that the fundamental emissions stay within the authorized bands of operation.

According to §22.355, the carrier frequency of each transmitter in the Public Mobile Services must be maintained within the tolerances given in Table below:

Frequency Tolerance for Transmitters in the Public Mobile Services

Frequency Range (MHz)	Base, fixed (ppm)	Mobile ≤ 3 watts (ppm)	Mobile > 3 watts (ppm)
25 to 50	20.0	20.0	50.0
50 to 450	5.0	5.0	50.0
450 to 512	2.5	5.0	5.0
821 to 896	1.5	2.5	2.5
928 to 929.	5.0	N/A	N/A
929 to 960.	1.5	N/A	N/A
2110 to 2220	10.0	N/A	N/A

According to §24.235, the frequency stability shall be sufficient to ensure that the fundamental emissions stays within the authorized frequency block.

Test Procedure

Frequency Stability vs. Temperature: The equipment under test was connected to an external DC power supply and the RF output was connected to communication test set via feed-through attenuators. The EUT was placed inside the temperature chamber. The DC leads and RF output cable exited the chamber through an opening made for the purpose.

After the temperature stabilized for approximately 20 minutes, the frequency output was recorded from the communication test set.

Frequency Stability vs. Voltage: For hand carried, battery powered equipment; reduce primary supply voltage to the battery operating end point which shall be specified by the manufacturer.

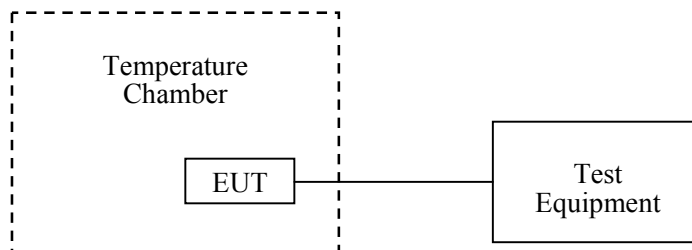

Test Data**Environmental Conditions**

Temperature:	24~26.5 °C
Relative Humidity:	54~56 %
ATM Pressure:	100.0~101.0 kPa

The testing was performed by Black Chen from 2021-03-07 to 2021-03-11.

EUT operation mode: Transmitting

Test Result: Pass

Please refer to the following tables.

Cellular Band (Part 22H)**GSM Mode**

Middle Channel, $f_0=836.6\text{MHz}$				
Temperature (°C)	Voltage Supplied (V_{DC})	Frequency Error (Hz)	Frequency Error (ppm)	Limit (ppm)
-30	3.87	-3	-0.003586	2.5
-20		-5	-0.005977	2.5
-10		-4	-0.004781	2.5
0		-3	-0.003586	2.5
10		-1	-0.001195	2.5
20		-3	-0.003586	2.5
30		-4	-0.004781	2.5
40		-3	-0.003586	2.5
50		-4	-0.004781	2.5
20		3.45	-6	-0.007172
	4.45	-8	-0.009563	2.5

EDGE Mode

Middle Channel, $f_0 = 836.6\text{MHz}$				
Temperature (°C)	Voltage Supplied (V _{DC})	Frequency Error (Hz)	Frequency Error (ppm)	Limit (ppm)
-30	3.87	-5	-0.005977	2.5
-20		-5	-0.005977	2.5
-10		-8	-0.009563	2.5
0		-3	-0.003586	2.5
10		-4	-0.004781	2.5
20		-4	-0.004781	2.5
30		-6	-0.007172	2.5
40		-3	-0.003586	2.5
50		-7	-0.008367	2.5
20	3.45	-8	-0.009563	2.5
	4.45	-8	-0.009563	2.5

WCDMA Mode

Middle Channel, $f_0 = 836.6\text{MHz}$				
Temperature (°C)	Voltage Supplied (V _{DC})	Frequency Error (Hz)	Frequency Error (ppm)	Limit (ppm)
-30	3.87	-11	-0.0131	2.5
-20		-9	-0.0108	2.5
-10		-8	-0.0096	2.5
0		-5	-0.0060	2.5
10		-7	-0.0084	2.5
20		-5	-0.0060	2.5
30		-4	-0.0048	2.5
40		-7	-0.0084	2.5
50		-10	-0.0120	2.5
20		3.45	15	0.0179
	4.45	-12	-0.0143	2.5

PCS Band (Part 24E)

GSM Mode

Middle Channel, $f_0 = 1880.0$ MHz				
Temperature (°C)	Voltage Supplied (V _{DC})	Frequency Error (Hz)	Frequency Error (ppm)	Result
-30	3.87	-18	-0.009574	pass
-20		-16	-0.008511	pass
-10		-15	-0.007979	pass
0		-16	-0.008511	pass
10		-9	-0.004787	pass
20		-12	-0.006383	pass
30		-8	-0.004255	pass
40		-2	-0.001064	pass
50		-16	-0.008511	pass
20		3.45	-12	-0.006383
	4.45	-17	-0.009043	pass

EDGE Mode

Middle Channel, $f_0 = 1880.0$ MHz				
Temperature (°C)	Voltage Supplied (V _{DC})	Frequency Error (Hz)	Frequency Error (ppm)	Result
-30	3.87	-15	-0.007979	pass
-20		-19	-0.010106	pass
-10		-17	-0.009043	pass
0		-13	-0.006915	pass
10		-10	-0.005319	pass
20		-10	-0.005319	pass
30		-12	-0.006383	pass
40		-22	-0.011702	pass
50		-17	-0.009043	pass
20		3.45	-18	-0.009574
	4.45	-19	-0.010106	pass

WCDMA Mode

Middle Channel, $f_0 = 1880.0$ MHz				
Temperature (°C)	Voltage Supplied (V _{DC})	Frequency Error (Hz)	Frequency Error (ppm)	Result
-30	3.87	-11	-0.0059	pass
-20		-8	-0.0043	pass
-10		-9	-0.0048	pass
0		-6	-0.0032	pass
10		-7	-0.0037	pass
20		-4	-0.0021	pass
30		-7	-0.0037	pass
40		-8	-0.0043	pass
50		-8	-0.0043	pass
20		3.45	-9	-0.0048
	4.45	-10	-0.0053	pass

AWS Band (Part 27)

Temperature (°C)	Power Supplied (V _{DC})	F _L (MHz)	F _H (MHz)	F _L Limit (MHz)	F _H Limit (MHz)
-30	3.87	1710.0689	1754.9364	1710	1755
-20		1710.0711	1754.9336	1710	1755
-10		1710.0678	1754.9311	1710	1755
0		1710.0693	1754.9374	1710	1755
10		1710.0616	1754.9329	1710	1755
20		1710.0657	1754.9374	1710	1755
30		1710.0639	1754.9375	1710	1755
40		1710.0681	1754.9345	1710	1755
50		1710.0596	1754.9323	1710	1755
20		3.45	1710.0686	1754.9374	1710
	4.45	1710.0697	1754.9384	1710	1755

LTE:
QPSK:

Band 2:

10.0 MHz Middle Channel, f ₀ =1880MHz				
Temperature (°C)	Voltage Supplied (V _{DC})	Frequency Error (Hz)	Frequency Error (ppm)	Result
-30	3.87	-2	-0.00106	pass
-20		-7	-0.00372	pass
-10		-6	-0.00319	pass
0		6	0.003191	pass
10		10	0.005319	pass
20		5	0.00266	pass
30		-7	-0.00372	pass
40		-9	-0.00479	pass
50		-7	-0.00372	pass
20	3.45	9	0.004787	pass
	4.45	-7	-0.00372	pass

Band 4:

10 MHz Bandwidth					
Temperature (°C)	Power Supplied (V _{DC})	F _L (MHz)	F _H (MHz)	F _L Limit (MHz)	F _H Limit (MHz)
-30	3.87	1710.5477	1754.5266	1710	1755
-20		1710.5481	1754.5202	1710	1755
-10		1710.5498	1754.5210	1710	1755
0		1710.5464	1754.5266	1710	1755
10		1710.5454	1754.5231	1710	1755
20		1710.5474	1754.5256	1710	1755
30		1710.5451	1754.5266	1710	1755
40		1710.5441	1754.5241	1710	1755
50		1710.5460	1754.5239	1710	1755
20		3.45	1710.5477	1754.5216	1710
	4.45	1710.5495	1754.5253	1710	1755

Band 5:

10.0 MHz Middle Channel, $f_0=836.5\text{MHz}$				
Temperature (°C)	Voltage Supplied (V _{DC})	Frequency Error (Hz)	Frequency Error (ppm)	Limit (ppm)
-30	3.87	-3	-0.00359	2.5
-20		-7	-0.00837	2.5
-10		7	0.008367	2.5
0		7	0.008367	2.5
10		7	0.008367	2.5
20		-10	-0.01195	2.5
30		-7	-0.00837	2.5
40		-6	-0.00717	2.5
50		-9	-0.01076	2.5
20	3.45	-7	-0.00837	2.5
	4.45	6	0.007172	2.5

Band 7:

10 MHz Bandwidth					
Temperature (°C)	Power Supplied (V _{DC})	F _L (MHz)	F _H (MHz)	F _L Limit (MHz)	F _H Limit (MHz)
-30	3.87	2500.5627	2569.5370	2500	2570
-20		2500.5631	2569.5347	2500	2570
-10		2500.5662	2569.5368	2500	2570
0		2500.5612	2569.5328	2500	2570
10		2500.5625	2569.5346	2500	2570
20		2500.5662	2569.5389	2500	2570
30		2500.5619	2569.5332	2500	2570
40		2500.5667	2569.5333	2500	2570
50		2500.5616	2569.5332	2500	2570
20	3.45	2500.5623	2569.5343	2500	2570
	4.45	2500.5636	2569.5325	2500	2570

Band 17:

10 MHz Bandwidth					
Temperature (°C)	Power Supplied (V _{DC})	F _L (MHz)	F _H (MHz)	F _L Limit (MHz)	F _H Limit (MHz)
-30	3.87	704.4733	715.7227	704	716
-20		704.4708	715.7158	704	716
-10		704.4716	715.7189	704	716
0		704.4711	715.7195	704	716
10		704.4726	715.7183	704	716
20		704.4705	715.7225	704	716
30		704.4738	715.7188	704	716
40		704.4729	715.7165	704	716
50		704.4741	715.7173	704	716
20	3.45	704.4752	715.7187	704	716
	4.45	704.4756	715.7198	704	716

Band 38:

10 MHz Bandwidth					
Temperature (°C)	Power Supplied (V _{DC})	F _L (MHz)	F _H (MHz)	F _L Limit (MHz)	F _H Limit (MHz)
-30	3.87	2570.4719	2619.6257	2570	2620
-20		2570.4711	2619.6283	2570	2620
-10		2570.4747	2619.6257	2570	2620
0		2570.4752	2619.6270	2570	2620
10		2570.472	2619.6263	2570	2620
20		2570.4751	2619.6271	2570	2620
30		2570.4735	2619.6271	2570	2620
40		2570.4727	2619.6249	2570	2620
50		2570.4736	2619.6301	2570	2620
20	3.45	2570.4720	2619.6250	2570	2620
	4.45	2570.4749	2619.6233	2570	2620

Band 41:

10 MHz Bandwidth					
Temperature (°C)	Power Supplied (V _{DC})	F _L (MHz)	F _H (MHz)	F _L Limit (MHz)	F _H Limit (MHz)
-30	3.87	2535.5634	2654.5872	2535	2655
-20		2535.5637	2654.5802	2535	2655
-10		2535.5644	2654.5846	2535	2655
0		2535.5646	2654.5848	2535	2655
10		2535.5636	2654.5826	2535	2655
20		2535.5680	2654.5849	2535	2655
30		2535.5681	2654.5861	2535	2655
40		2535.5662	2654.5843	2535	2655
50		2535.5667	2654.5813	2535	2655
20	3.45	2535.5636	2654.5823	2535	2655
	4.45	2535.5630	2654.5844	2535	2655

Note: The applicant declared the operating frequency range is 2535-2655MHz.

Band 66:

10 MHz Bandwidth					
Temperature (°C)	Power Supplied (V _{DC})	F _L (MHz)	F _H (MHz)	F _L Limit (MHz)	F _H Limit (MHz)
-30	3.87	1710.8654	1779.6834	1710	1780
-20		1710.8699	1779.6898	1710	1780
-10		1710.8638	1779.6887	1710	1780
0		1710.8630	1779.6875	1710	1780
10		1710.8654	1779.6849	1710	1780
20		1710.8669	1779.6836	1710	1780
30		1710.8638	1779.6893	1710	1780
40		1710.8655	1779.6864	1710	1780
50		1710.8632	1779.6886	1710	1780
20		3.45	1710.8660	1779.6897	1710
	4.45	1710.8670	1779.6852	1710	1780

16QAM:

Band 2:

10.0 MHz Middle Channel, $f_o = 1880\text{MHz}$				
Temperature (°C)	Voltage Supplied (V _{DC})	Frequency Error (Hz)	Frequency Error (ppm)	Result
-30	3.87	-1	-0.0005	pass
-20		8	0.0043	pass
-10		-9	-0.0046	pass
0		9	0.0050	pass
10		-7	-0.0037	pass
20		8	0.0040	pass
30		6	0.0034	pass
40		-6	-0.0033	pass
50		-6	-0.0034	pass
20		3.45	6	0.0034
	4.45	-7	-0.0037	pass

Band 4:

10 MHz Bandwidth					
Temperature (°C)	Power Supplied (V _{DC})	F _L (MHz)	F _H (MHz)	F _L Limit (MHz)	F _H Limit (MHz)
-30	3.87	1710.5531	1754.6673	1710	1755
-20		1710.5481	1754.6622	1710	1755
-10		1710.5538	1754.6639	1710	1755
0		1710.5506	1754.6674	1710	1755
10		1710.5498	1754.6645	1710	1755
20		1710.5486	1754.6694	1710	1755
30		1710.5538	1754.6646	1710	1755
40		1710.5472	1754.6654	1710	1755
50		1710.5522	1754.6671	1710	1755
20		3.45	1710.5478	1754.6661	1710
	4.45	1710.5477	1754.6640	1710	1755

Band 5:

10.0 MHz Middle Channel, $f_0=836.5\text{MHz}$				
Temperature (°C)	Voltage Supplied (V _{DC})	Frequency Error (Hz)	Frequency Error (ppm)	Limit (ppm)
-30	3.87	-5	-0.00598	2.5
-20		6	0.007172	2.5
-10		6	0.007172	2.5
0		8	0.009563	2.5
10		-7	-0.00837	2.5
20		-7	-0.00837	2.5
30		7	0.008367	2.5
40		-9	-0.01076	2.5
50		-5	-0.00598	2.5
20	3.45	-8	-0.00956	2.5
	4.45	6	0.007172	2.5

Band 7:

10 MHz Bandwidth					
Temperature (°C)	Power Supplied (V _{DC})	F _L (MHz)	F _H (MHz)	F _L Limit (MHz)	F _H Limit (MHz)
-30	3.87	2500.5205	2569.5625	2500	2570
-20		2500.5247	2569.5595	2500	2570
-10		2500.5209	2569.5605	2500	2570
0		2500.5200	2569.5620	2500	2570
10		2500.5209	2569.5646	2500	2570
20		2500.4653	2569.5276	2500	2570
30		2500.5176	2569.5612	2500	2570
40		2500.5183	2569.5615	2500	2570
50		2500.5176	2569.5647	2500	2570
20		3.45	2500.5254	2569.5620	2500
	4.45	2500.5199	2569.5636	2500	2570

Band 17:

10 MHz Bandwidth					
Temperature (°C)	Power Supplied (V _{DC})	F _L (MHz)	F _H (MHz)	F _L Limit (MHz)	F _H Limit (MHz)
-30	3.87	704.4722	715.6197	704	716
-20		704.4726	715.6169	704	716
-10		704.4729	715.6204	704	716
0		704.4725	715.6188	704	716
10		704.4721	715.6167	704	716
20		704.4711	715.6170	704	716
30		704.4747	715.6149	704	716
40		704.4722	715.6157	704	716
50		704.4695	715.6185	704	716
20	3.45	704.4725	715.6211	704	716
	4.45	704.4745	715.6143	704	716

Band 38:

10 MHz Bandwidth					
Temperature (°C)	Power Supplied (V _{DC})	F _L (MHz)	F _H (MHz)	F _L Limit (MHz)	F _H Limit (MHz)
-30	3.87	2570.4705	2619.6351	2570	2620
-20		2570.4758	2619.6348	2570	2620
-10		2570.4744	2619.6356	2570	2620
0		2570.4704	2619.6366	2570	2620
10		2570.4721	2619.6353	2570	2620
20		2570.4752	2619.6403	2570	2620
30		2570.4731	2619.6343	2570	2620
40		2570.4762	2619.6336	2570	2620
50		2570.4707	2619.6338	2570	2620
20	3.45	2570.4711	2619.6284	2570	2620
	4.45	2570.4685	2619.6291	2570	2620

Band 41:

10 MHz Bandwidth					
Temperature (°C)	Power Supplied (V _{DC})	F _L (MHz)	F _H (MHz)	F _L Limit (MHz)	F _H Limit (MHz)
-30	3.87	2535.5636	2654.5826	2535	2655
-20		2535.5614	2654.5846	2535	2655
-10		2535.5673	2654.5863	2535	2655
0		2535.5620	2654.5856	2535	2655
10		2535.5662	2654.5826	2535	2655
20		2535.5612	2654.5842	2535	2655
30		2535.5643	2654.5871	2535	2655
40		2535.5656	2654.5818	2535	2655
50		2535.5650	2654.5809	2535	2655
20	3.45	2535.5615	2654.5832	2535	2655
	4.45	2535.5658	2654.5815	2535	2655

Note: The applicant declared the operating frequency range is 2535-2655MHz.

Band 66:

10 MHz Bandwidth					
Temperature (°C)	Power Supplied (V _{DC})	F _L (MHz)	F _H (MHz)	F _L Limit (MHz)	F _H Limit (MHz)
-30	3.87	1710.8679	1779.6882	1710	1780
-20		1710.8652	1779.6842	1710	1780
-10		1710.8679	1779.6853	1710	1780
0		1710.8670	1779.6825	1710	1780
10		1710.8669	1779.6859	1710	1780
20		1710.8642	1779.6823	1710	1780
30		1710.8654	1779.6885	1710	1780
40		1710.8693	1779.6862	1710	1780
50		1710.8638	1779.6825	1710	1780
20	3.45	1710.8657	1779.6878	1710	1780
	4.45	1710.8629	1779.6870	1710	1780

***** END OF REPORT *****