



For Question,  
Please Contact with WSCT  
www.wsct-cert.com

# TEST REPORT

FCC ID: 2ADYY-BD02

Product: Wireless Earphone

Model No.: BD02

Additional Model No.: N/A

Trade Mark: TECNO

Report No.: WSCT-A2LA-R&E210400003A-BT

Issued Date: 29 April 2021

Issued for:

TECNO MOBILE LIMITED

FLAT 39 8/F BLOCK D WAH LOK INDUSTRIAL CENTRE 31-35 SHAN MEI STREET  
FOTAN NT

Issued By:

WORLD STANDARDIZATION CERTIFICATION & TESTING GROUP  
(SHENZHEN) CO., LTD.

Building A-B, Baoshi Road, Baoshi Science & Technology Park, Bao'an District,  
Shenzhen, Guangdong, People's Republic of China

TEL: + (86) 13924678855

FAX: +86-755-86376605

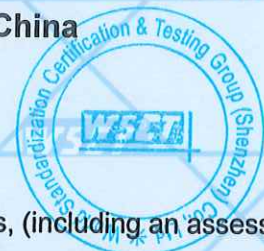

**Note:** In recognition of the successful completion of the A2LA evaluation process, (including an assessment of the laboratory's compliance with A2LA's ENERGY STAR® Accreditation Program requirements 1) accreditation is granted to this laboratory to perform the following tests: EMC, electromagnetic compatibility, telecommunications and Energy Star.







For Question,  
Please Contact with WSCT  
[www.wsct-cert.com](http://www.wsct-cert.com)

Report No.:WSCT-A2LA-R&E210400003A-BLE

## Table of Contents

<b>1. GENERAL INFORMATION</b>	<b>3</b>
1.1 GENERAL DESCRIPTION OF EUT	4
1.2 FACILITIES AND ACCREDITATIONS	5
1.3 DESCRIPTION OF TEST MODES	6
1.4 TABLE OF PARAMETERS OF TEXT SOFTWARE SETTING	7
1.5 DESCRIPTION OF SUPPORT UNITS(CONDUCTED MODE)	8
<b>2. SUMMARY OF TEST RESULTS</b>	<b>9</b>
<b>3. MEASUREMENT INSTRUMENTS</b>	<b>10</b>
<b>4. EMC EMISSION TEST</b>	<b>11</b>
4.1 CONDUCTED EMISSION MEASUREMENT	11
4.2 RADIATED EMISSION MEASUREMENT	15
<b>5. NUMBER OF HOPPING CHANNEL</b>	<b>29</b>
5.1 APPLIED PROCEDURES / LIMIT	29
5.2 TEST RESULTS	30
<b>6. AVERAGE TIME OF OCCUPANCY</b>	<b>32</b>
6.1 APPLIED PROCEDURES / LIMIT	32
6.2 TEST RESULTS	34
<b>7. HOPPING CHANNEL SEPARATION MEASUREMENT</b>	<b>40</b>
7.1 APPLIED PROCEDURES / LIMIT	40
7.2 TEST RESULTS	41
<b>8. BANDWIDTH TEST</b>	<b>50</b>
8.1 APPLIED PROCEDURES / LIMIT	50
8.2 TEST RESULTS	51
<b>9. PEAK OUTPUT POWER TEST</b>	<b>60</b>
9.1 APPLIED PROCEDURES / LIMIT	60
9.2 TEST RESULTS	61
<b>10. 100KHZ BAND EDGES MEASUREMENT</b>	<b>67</b>
10.1 APPLIED PROCEDURES / LIMIT	67
<b>11. ANTENNA APPLICATION</b>	<b>77</b>
11.1 ANTENNA REQUIREMENT	77
<b>12. TEST SETUP PHOTOGRAPHS</b>	<b>78</b>







For Question,  
Please Contact with WSCT  
www.wsct-cert.com

Report No.: WSCT-A2LA-R&E210400003A-BT

### 1. GENERAL INFORMATION

**Product:** Wireless Earphone  
**Model No.:** BD02  
**Additional Model:** N/A  
**Trade Mark:** TECNO  
**Applicant:** TECNO MOBILE LIMITED  
**Address:** FLAT 39 8/F BLOCK D WAH LOK INDUSTRIAL CENTRE 31-35 SHAN MEI STREET FOTAN NT  
**Manufacturer:** TECNO MOBILE LIMITED  
**Address:** FLAT 39 8/F BLOCK D WAH LOK INDUSTRIAL CENTRE 31-35 SHAN MEI STREET FOTAN NT  
**Data of receipt:** Apr. 13, 2021  
**Date of Test:** Apr. 13, 2021 to Apr. 28, 2021  
**Applicable Standards:** FCC CFR Title 47 Part 15 Subpart C Section 15.247, 558074 D01 15.247 Meas Guidance v05r02

Deviation from Applicable Standard
None

The above equipment has been tested by World Standardization Certification & Testing Group (Shenzhen) Co., Ltd. And found compliance with the requirements set forth in the technical standards mentioned above. The results of testing in this report apply only to the product/system, which was tested. Other similar equipment will not necessarily produce the same results due to production tolerance and measurement uncertainties.

**Tested By:** Jim Han  
(Jim Han)

**Check By:** Sol Qin  
(Sol Qin)



**Approved By:** Wang Fengbing  
(Wang Fengbing)

**Date:** 29 April 2021







For Question,  
Please Contact with WSCT  
www.wsct-cert.com

Report No.:WSCT-A2LA-R&E210400003A-BLE

### 1.1 GENERAL DESCRIPTION OF EUT

Equipment Type:	Wireless Earphone
Model No.:	BD02
Additional Model:	N/A
Trade Mark	TECNO
Software version:	V1.1
Hardware version:	V1.5
Extreme Temp. Tolerance:	0°C to + 45°C
Battery information:	N/A
Adapter Information:	Charge box Battery: Li-ion Battery : 602030 Rated Voltage: 3.7V Rated Capacity: 300mAh Earphone Battery: Li-ion Battery :501012 Rated Voltage: 3.7V Rated Capacity: 40mAh
Operating Frequency	2402-2480MHz(TX/RX)
Channels	79
Channel Spacing	1MHz
Modulation Type	GFSK, π /4-DQPSK, 8-DPSK for BR+EDR
Version	3.0
Antenna Type:	Portable Equipment
Antenna gain:	2.17dBi

Note: N/A stands for no applicable.

#### Models difference

N/A







For Question,  
Please Contact with WSCT  
www.wsct-cert.com

Report No.:WSCT-A2LA-R&E210400003A-BLE

## 1.2 FACILITIES AND ACCREDITATIONS

All measurement facilities used to collect the measurement data are located at **Building A-B, Baoshi Science & Technology Park, Baoshi Road, Bao'an District, Shenzhen, Guangdong, China of the WORLD STANDARDIZATION CERTIFICATION & TESTING GROUP (SHENZHEN) CO., LTD.**

The sites are constructed in conformance with the requirements of ANSI C63.4 and CISPR Publication 22. All receiving equipment conforms to CISPR Publication 16-1, "Radio Interference Measuring Apparatus and Measurement Methods."

### 1.2.1 ACCREDITATIONS

**China National Accreditation Service for Conformity Assessment (CNAS)**  
Registration number NO: L3732

**American Association for Laboratory Accreditation(A2LA)**

Registration NO : 5768.01

Copies of granted accreditation certificates are available for downloading from our web site,  
<http://www.wsct-cert.com>

### 1.2.2 TEST DESCRIPTION

#### 1.2.2.1 MEASUREMENT UNCERTAINTY

The reported uncertainty of measurement  $y \pm U$ , where expanded uncertainty  $U$  is based on a standard uncertainty multiplied by a coverage factor of  $k=2$ , providing a level of confidence of approximately 95 %.

No.	Item	Uncertainty
1	Conducted Emission Test	$\pm 3.2$ dB
2	RF power,conducted	$\pm 0.16$ dB
3	Spurious emissions,conducted	$\pm 0.21$ dB
4	All emissions,radiated(<1G)	$\pm 4.7$ dB
5	All emissions,radiated(>1G)	$\pm 4.7$ dB
6	Temperature	$\pm 0.5$ °C
7	Humidity	$\pm 2$ %







### 1.3 DESCRIPTION OF TEST MODES

To investigate the maximum EMI emission characteristics generates from EUT, the test system was pre-scanning tested base on the consideration of following EUT operation mode or test configuration mode which possible have effect on EMI emission level. Each of these EUT operation mode(s) or test configuration mode(s) mentioned above was evaluated respectively.

Modulation type	Mode
1Mbps	Mode 1 、 Mode 2 、 Mode 3 、 Mode 4
2Mbps	
3Mbps	

Pretest Mode	Description
Mode 1	CH00
Mode 2	CH39
Mode 3	CH78
Mode 4	Normal Hopping

For Conducted Emission	
Final Test Mode	Description
Mode 4	Normal Hopping

For Radiated Emission	
Final Test Mode	Description
Mode 1	CH00
Mode 2	CH39
Mode 3	CH78
Mode 4	Normal Hopping

Note:

- (1) The measurements are performed at the highest, middle, lowest available channels.
- (2) The data rate was set in 1Mbps,2 Mbps,3 Mbps for radiated emission due to the highest RF output power.
- (3) Record the worst case of each test item in this report.





For Question,  
Please Contact with WSCT  
www.wsct-cert.com

Report No.:WSCT-A2LA-R&E210400003A-BLE

### 1.4 TABLE OF PARAMETERS OF TEXT SOFTWARE SETTING

During testing channel & power controlling software provided by the customer was used to control the operating channel as well as the output power level. The RF output power selection is for the setting of RF output power expected by the customer and is going to be fixed on the firmware of the final end product power parameters of FHSS

Test software Version	N/A		
Frequency	2402 MHz	2441 MHz	2480 MHz
Parameters(1Mbps)	DEF	DEF	DEF
Parameters(2Mbps)	DEF	DEF	DEF
Parameters(3Mbps)	DEF	DEF	DEF

#### 1.4.1 CONFIGURATION OF SYSTEM UNDER TEST

Mode 1:



Mode 2:



(EUT: Wireless Earphone)







For Question,  
Please Contact with WSCT  
www.wsct-cert.com

Report No.:WSCT-A2LA-R&E210400003A-BLE

### 1.5 DESCRIPTION OF SUPPORT UNITS(CONDUCTED MODE)

The EUT has been tested as an independent unit together with other necessary accessories or support units. The following support units or accessories were used to form a representative test configuration during the tests.

Item	Equipment	Mfr/Brand	Model/Type No.	Series No.	Note
1	PC	/	DELL	MS111-1	/

**Note:**

- (1) The support equipment was authorized by Declaration of Confirmation.
- (2) For detachable type I/O cable should be specified the length in cm in 『Length』 column.
- (3) “YES” is means “shielded” “with core”; “NO” is means “unshielded” “without core”.







For Question,  
Please Contact with WSCT  
www.wsct-cert.com

Report No.:WSCT-A2LA-R&E210400003A-BLE

## 2. SUMMARY OF TEST RESULTS

Test procedures according to the technical standards:

FCC Part15 (15.247) , Subpart C			
Standard Section	Test Item	Judgment	Remark
15.207	Conducted Emission	PASS	
15.247(a)(1)	Hopping Channel Separation	PASS	
15.247(b)(1)	Peak Output Power	PASS	
15.247(c)	Radiated Spurious Emission	PASS	
15.247(a)(iii)	Number of Hopping Frequency	PASS	
15.247(a)(iii)	Dwell Time	PASS	
15.247(a)(1)	Bandwidth	PASS	
15.247(d)	100kHz Band Edges	PASS	
15.205	Band Edge Emission	PASS	
15.203	Antenna Requirement	PASS	

### NOTE:

(1) "N/A" denotes test is not applicable in this test report.

(2) The manufacture declare the equipment comply with the all the technical requirements in 15.247(g). 15.247(h).

The equipment are not required to employ all available hopping channels during each trans mission. it can be presented with a continuous data (or information) stream. the equipment can recognize other users within the spectrum band so that it individually and independently chooses and adapts its hop sets to avoid hopping on occupied channels.







For Question,  
Please Contact with WSCT  
www.wsct-cert.com

Report No.: WSCT-A2LA-R&E210400003A-BLE

### 3. MEASUREMENT INSTRUMENTS

NAME OF EQUIPMENT	MANUFACTURER	MODEL	SERIAL NUMBER	Calibration Date	Calibration Due.
EMI Test Receiver	R&S	ESCI	100005	11/05/2021	11/04/2021
LISN	AFJ	LS16	16010222119	11/05/2021	11/04/2021
LISN(EUT)	Mestec	AN3016	04/10040	11/05/2021	11/04/2021
Universal Radio Communication Tester	R&S	CMU 200	1100.0008.02	11/05/2021	11/04/2021
Coaxial cable	Megalon	LMR400	N/A	11/05/2021	11/04/2021
GPIB cable	Megalon	GPIB	N/A	11/05/2021	11/04/2021
Spectrum Analyzer	R&S	FSU	100114	11/05/2021	11/04/2021
Pre Amplifier	H.P.	HP8447E	2945A02715	11/05/2021	11/04/2021
Pre-Amplifier	CDSI	PAP-1G18-38	--	11/05/2021	11/04/2021
Bi-log Antenna	SUNOL Sciences	JB3	A021907	11/05/2021	11/04/2021
9*6*6 Anechoic	--	--	--	11/05/2021	11/04/2021
Horn Antenna	COMPLIANCE ENGINEERING	CE18000	--	11/05/2021	11/04/2021
Horn Antenna	SCHWARZBECK	BBHA9120D	9120D-631	11/05/2021	11/04/2021
Cable	TIME MICROWAVE	LMR-400	N-TYPE04	11/05/2021	11/04/2021
System-Controller	CCS	N/A	N/A	N.C.R	N.C.R
Turn Table	CCS	N/A	N/A	N.C.R	N.C.R
Antenna Tower	CCS	N/A	N/A	N.C.R	N.C.R
RF cable	Murata	MXHQ87WA3000	-	11/05/2021	11/04/2021
Loop Antenna	EMCO	6502	00042960	11/05/2021	11/04/2021
Horn Antenna	SCHWARZBECK	BBHA 9170	1123	11/05/2021	11/04/2021
Power meter	Anritsu	ML2487A	6K00003613	11/05/2021	11/04/2021
Power sensor	Anritsu	MX248XD	--	11/05/2021	11/04/2021







For Question,  
Please Contact with WSCT  
www.wsct-cert.com

Report No.:WSCT-A2LA-R&E210400003A-BLE

## 4. EMC EMISSION TEST

### 4.1 CONDUCTED EMISSION MEASUREMENT

#### 4.1.1 POWER LINE CONDUCTED EMISSION Limits (Frequency Range 150KHz-30MHz)

FREQUENCY (MHz)	Conducted limit (dB $\mu$ V)		Conducted limit (dB $\mu$ V)
	Quasi-peak	Quasi-peak	
0.15 -0.5	66 - 56 *	56 - 46 *	FCC
0.50 -5.0	56.00	46.00	FCC
5.0 -30.0	60.00	50.00	FCC

Note:

- (1) The tighter limit applies at the band edges.
- (2) The limit of " \* " marked band means the limitation decreases linearly with the logarithm of the frequency in the range.

The following table is the setting of the receiver

Receiver Parameters	Setting
Attenuation	10 dB
Start Frequency	0.15 MHz
Stop Frequency	30 MHz
IF Bandwidth	9 kHz







For Question,  
Please Contact with WSCT  
www.wsct-cert.com

Report No.: WSCT-A2LA-R&E210400003A-BLE

#### 4.1.2 TEST PROCEDURE

- The EUT was placed 0.4 meters from the horizontal ground plane with EUT being connected to the power mains through a line impedance stabilization network (LISN). All other support equipments powered from additional LISN(s). The LISN provide 50 Ohm/ 50uH of coupling impedance for the measuring instrument.
- Interconnecting cables that hang closer than 40 cm to the ground plane shall be folded back and forth in the center forming a bundle 30 to 40 cm long.
- I/O cables that are not connected to a peripheral shall be bundled in the center. The end of the cable may be terminated, if required, using the correct terminating impedance. The overall length shall not exceed 1 m.
- LISN at least 80 cm from nearest part of EUT chassis.
- For the actual test configuration, please refer to the related Item –EUT Test Photos.

#### 4.1.3 DEVIATION FROM TEST STANDARD

No deviation

#### 4.1.4 TEST SETUP

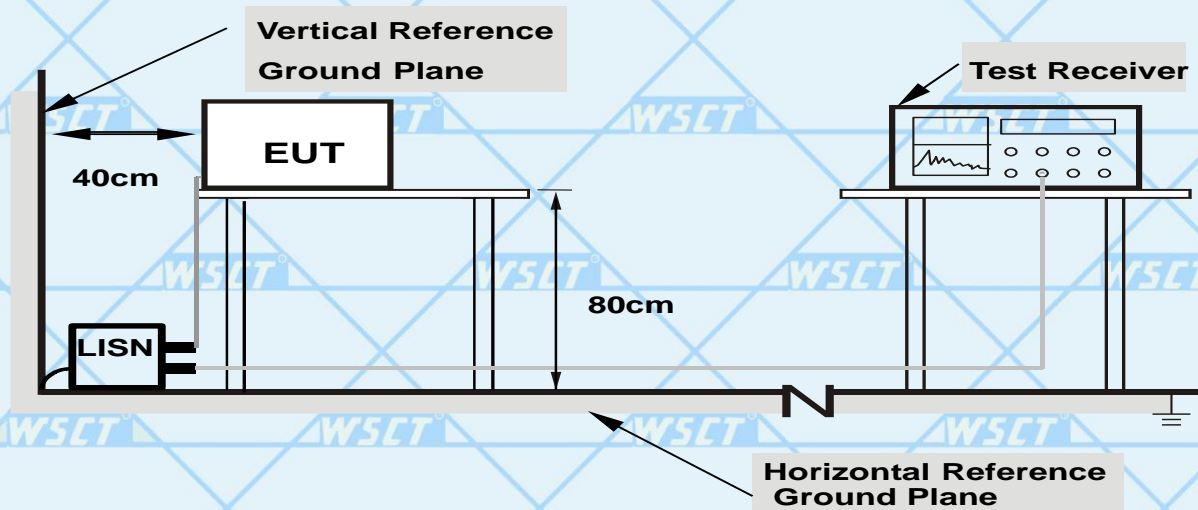

- Note:**
- Support units were connected to second LISN.
  - Both of LISNs (AMN) are 80 cm from EUT and at least 80 from other units and other metal planes

#### 4.1.5 EUT OPERATING CONDITIONS

The EUT was configured for testing in a typical fashion (as a customer would normally use it). The EUT has been programmed to continuously transmit during test. This operating condition was tested and used to collect the included data.







For Question,  
Please Contact with WSCT  
www.wsct-cert.com

Report No.: WSCT-A2LA-R&E210400003A-BLE

### 4.1.6 TEST RESULTS

Temperature	26 °C	Relative Humidity	54%
Pressure	1010hPa	Voltage	120V/60Hz
Test Mode	Mode 2		

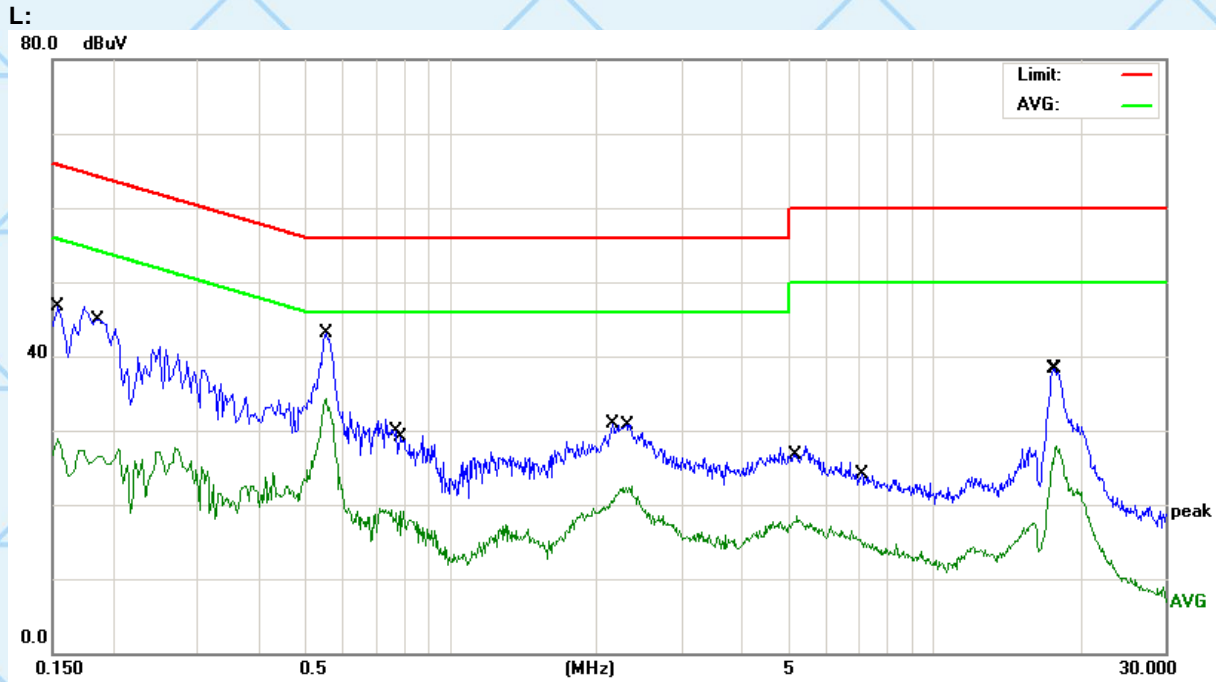

No.	Mk.	Freq. MHz	Reading Level dBuV	Correct Factor dB	Measure- ment dBuV	Limit dBuV	Over dB	Detector
1		0.1539	18.53	10.45	28.98	55.78	-26.80	AVG
2		0.1860	34.50	10.45	44.95	64.21	-19.26	QP
3		0.5540	32.60	10.52	43.12	56.00	-12.88	QP
4	*	0.5540	23.72	10.52	34.24	46.00	-11.76	AVG
5		0.7740	19.34	10.54	29.88	56.00	-26.12	QP
6		0.7980	8.60	10.54	19.14	46.00	-26.86	AVG
7		2.1619	20.19	10.71	30.90	56.00	-25.10	QP
8		2.2980	11.63	10.71	22.34	46.00	-23.66	AVG
9		5.2020	7.75	10.74	18.49	50.00	-31.51	AVG
10		7.0980	13.24	10.78	24.02	60.00	-35.98	QP
11		17.7820	27.16	11.12	38.28	60.00	-21.72	QP
12		17.8660	16.87	11.11	27.98	50.00	-22.02	AVG







For Question,  
Please Contact with WSCT  
www.wsct-cert.com

Report No.: WSCT-A2LA-R&E210400003A-BLE

N:

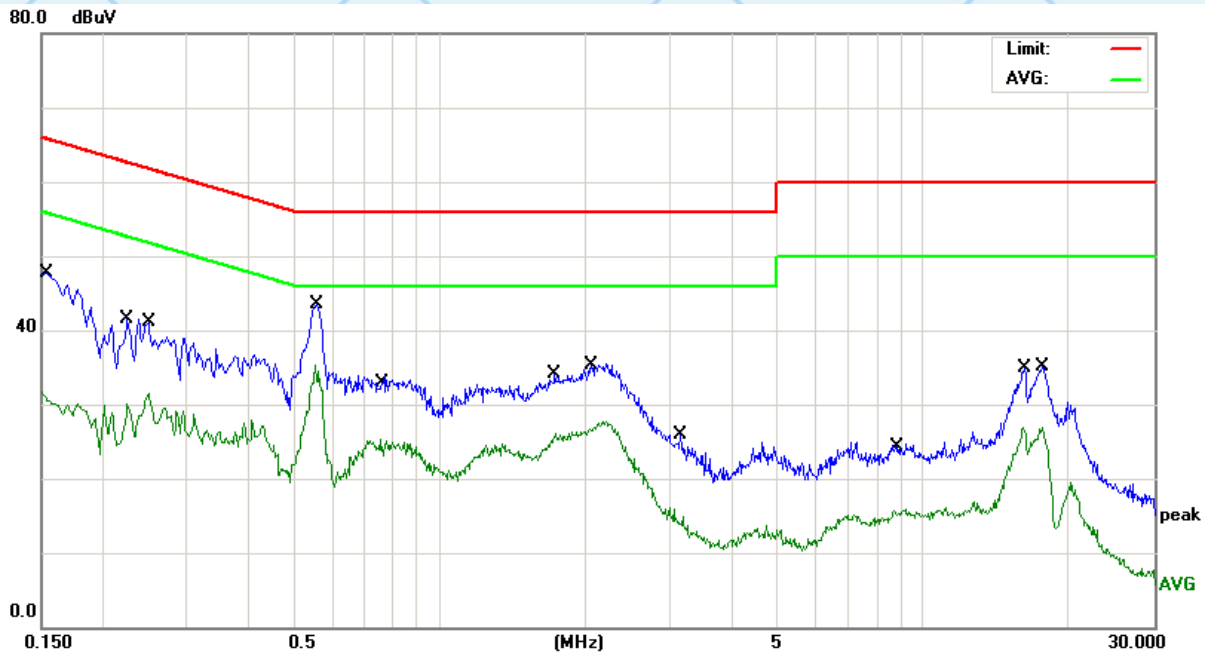

No.	Mk.	Freq. MHz	Reading Level dBuV	Correct Factor dB	Measure- ment dBuV	Limit dBuV	Over dB	Detector
1		0.1539	37.25	10.45	47.70	65.78	-18.08	QP
2		0.2260	31.08	10.46	41.54	62.59	-21.05	QP
3		0.2500	21.07	10.46	31.53	51.75	-20.22	AVG
4	*	0.5540	24.73	10.52	35.25	46.00	-10.75	AVG
5		0.5580	32.89	10.52	43.41	56.00	-12.59	QP
6		0.7539	14.72	10.54	25.26	46.00	-20.74	AVG
7		1.7340	23.33	10.67	34.00	56.00	-22.00	QP
8		2.0380	16.00	10.71	26.71	46.00	-19.29	AVG
9		3.1460	15.27	10.72	25.99	56.00	-30.01	QP
10		8.7140	4.82	10.81	15.63	50.00	-34.37	AVG
11		16.1100	15.82	11.17	26.99	50.00	-23.01	AVG
12		17.6140	23.92	11.12	35.04	60.00	-24.96	QP

Note: 1. All the modes have been investigated, and only worst mode is presented in this report.  
2. Over = Reading Level + Correct Factor - Limit.







For Question,  
Please Contact with WSCT  
www.wsct-cert.com

Report No.: WSCT-A2LA-R&E210400003A-BLE

## 4.2 RADIATED EMISSION MEASUREMENT

### 4.2.1 Radiated Emission Limits (Frequency Range 9kHz-1000MHz)

20dBc in any 100 kHz bandwidth outside the operating frequency band. In case the emission fall within the restricted band specified on 15.205(a), then the 15.209(a) limit in the table below has to be followed.

Frequencies (MHz)	Field Strength (micorvolts/meter)	Measurement Distance (meters)
0.009~0.490	2400/F(KHz)	300
0.490~1.705	24000/F(KHz)	30
1.705~30.0	30	30
30~88	100	3
88~216	150	3
216~960	200	3
Above 960	500	3

### LIMITS OF RADIATED EMISSION MEASUREMENT (Above 1000MHz)

FREQUENCY (MHz)	Limit (dBuV/m) (at 3M)	
	PEAK	AVERAGE
Above 1000	74	54

Notes:

- (1) The limit for radiated test was performed according to FCC PART 15C.
- (2) The tighter limit applies at the band edges.
- (3) Emission level (dBuV/m)=20log Emission level (uV/m).

Spectrum Parameter	Setting
Attenuation	Auto
Start Frequency	1000 MHz
Stop Frequency	10th carrier harmonic
RB / VB (emission in restricted band)	1MHz / 1MHz for Peak, 1 MHz / 1Hz for Average

Receiver Parameter	Setting
Attenuation	Auto
Start ~ Stop Frequency	9kHz~150kHz / RB 200Hz for QP
Start ~ Stop Frequency	150kHz~30MHz / RB 9kHz for QP
Start ~ Stop Frequency	30MHz~1000MHz / RB 120kHz for QP







Report No.: WSCT-A2LA-R&E210400003A-BLE

#### 4.2.2 TEST PROCEDURE

- a. The measuring distance of at 3 m shall be used for measurements at frequency up to 1GHz.  
For frequencies above 1GHz, any suitable measuring distance may be used.
- b. The EUT was placed on the top of a rotating table 0.8 meters above the ground at a 3 meter open area test site. The table was rotated 360 degrees to determine the position of the highest radiation.
- c. The height of the equipment or of the substitution antenna shall be 0.8 m; the height of the test antenna shall vary between 1 m to 4 m. Both horizontal and vertical polarizations of the antenna are set to make the measurement.
- d. The initial step in collecting conducted emission data is a spectrum analyzer peak detector mode pre-scanning the measurement frequency range. Significant peaks are then marked and then Quasi Peak detector mode re-measured.
- e. If the Peak Mode measured value compliance with and lower than Quasi Peak Mode Limit, the EUT shall be deemed to meet QP Limits and then no additional QP Mode measurement performed.
- f. For the actual test configuration, please refer to the related Item –EUT Test Photos.

Note:

**Both horizontal and vertical antenna polarities were tested and performed pretest to three orthogonal axis. The worst case emissions were reported**

#### 4.2.3 DEVIATION FROM TEST STANDARD

No deviation

#### 4.2.4 TEST SETUP

(A) Radiated Emission Test-Up Frequency Below 30MHz

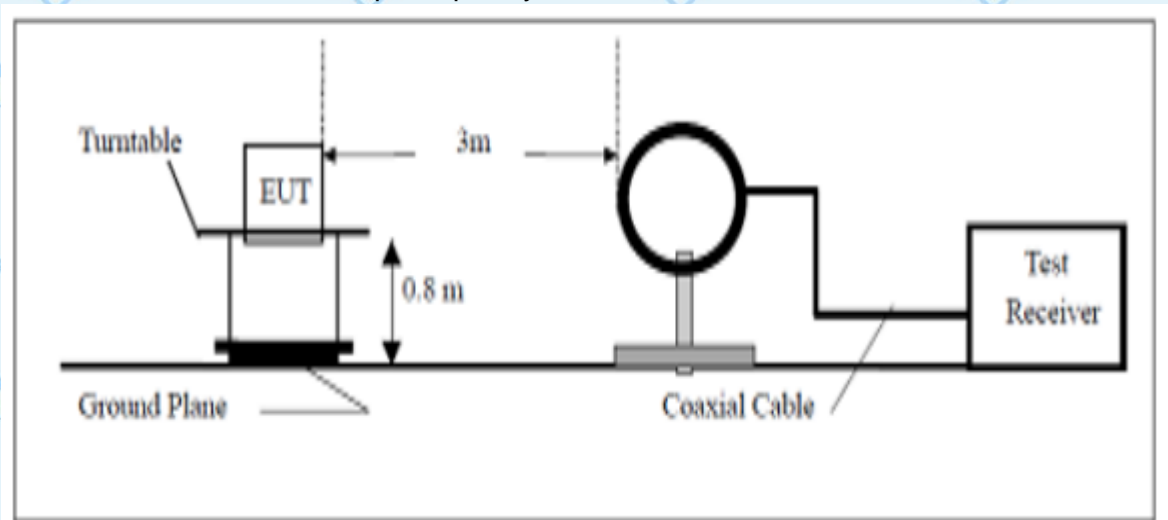





For Question, e Contact with WSCT  
www.wsct-cert.com

Report No.: WSCT-A2LA-R&E210400003A-BLE

(B) Radiated Emission Test-Up Frequency 30MHz~1GHz

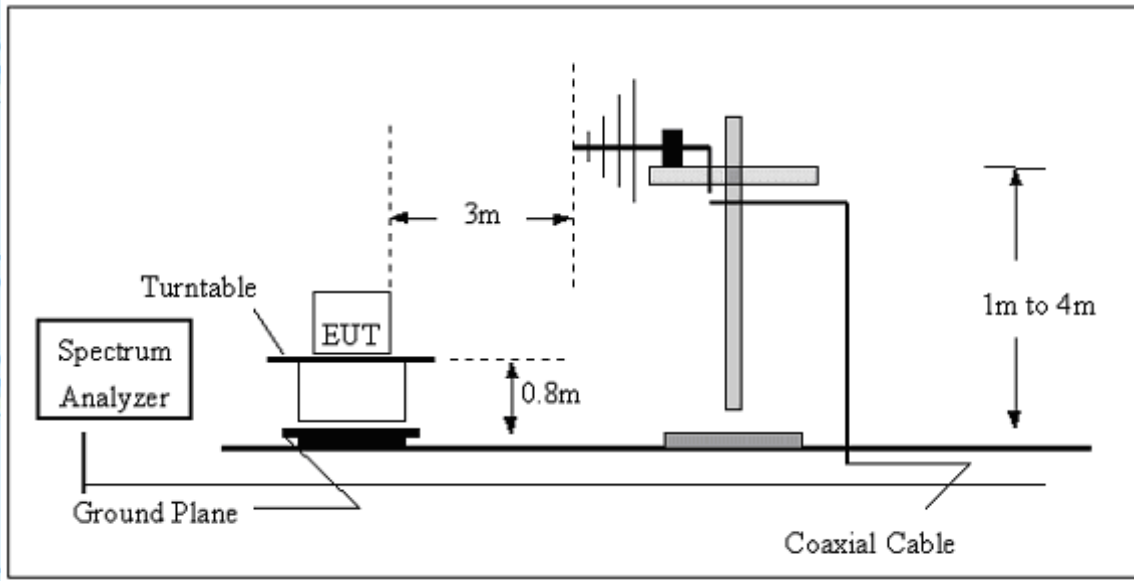

(C) Radiated Emission Test-Up Frequency Above 1GHz

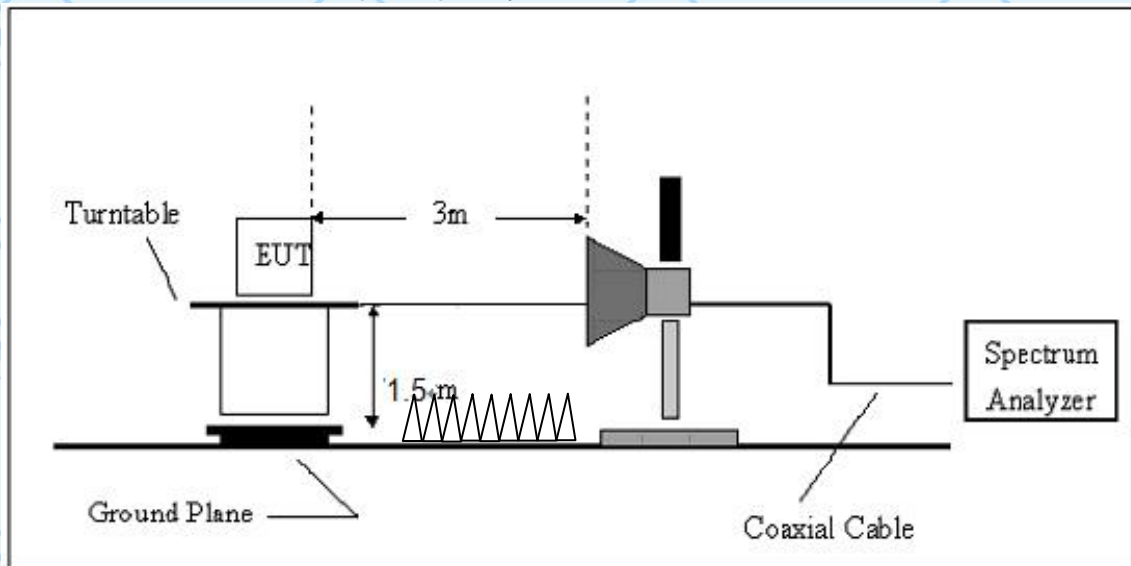

**4.2.5 EUT OPERATING CONDITIONS**

The EUT tested system was configured as the statements of 2.4 Unless otherwise a special operating condition is specified in the follows during the testing.







For Question,  
Please Contact with WSCT  
www.wsct-cert.com

Report No.:WSCT-A2LA-R&E210400003A-BLE

#### 4.2.5.1 RESULTS (Below 30 MHz)

Test Mode	Mode 1/ Mode 2/ Mode 3	Polarization	Horizontal / Vertical
Temperature	20 °C	Relative Humidity	48%
Pressure	1010 hPa		

Freq. (MHz)	Reading (dBuV/m)	Limit (dBuV/m)	Margin (dB)	State P/F
--	--	--	--	P
--	--	--	--	P

**NOTE:**

No result in this part for margin above 20dB.

Distance extrapolation factor =40 log (specific distance/test distance)(dB);

Limit line = specific limits (dBuV) + distance extrapolation factor.

All the x/y/z orientation has been investigated, and only worst case is presented in this report.







For Question,  
Please Contact with WSCT  
www.wsct-cert.com

Report No.:WSCT-A2LA-R&E21040003A-BLE

### 4.2.5.2 TEST RESULTS (Between 30M – 1000 MHz)

Test Mode	Mode 1 with GFSK modulation	Pressure	1010 hPa
Temperature	20 °C	Relative Humidity	48%

H:

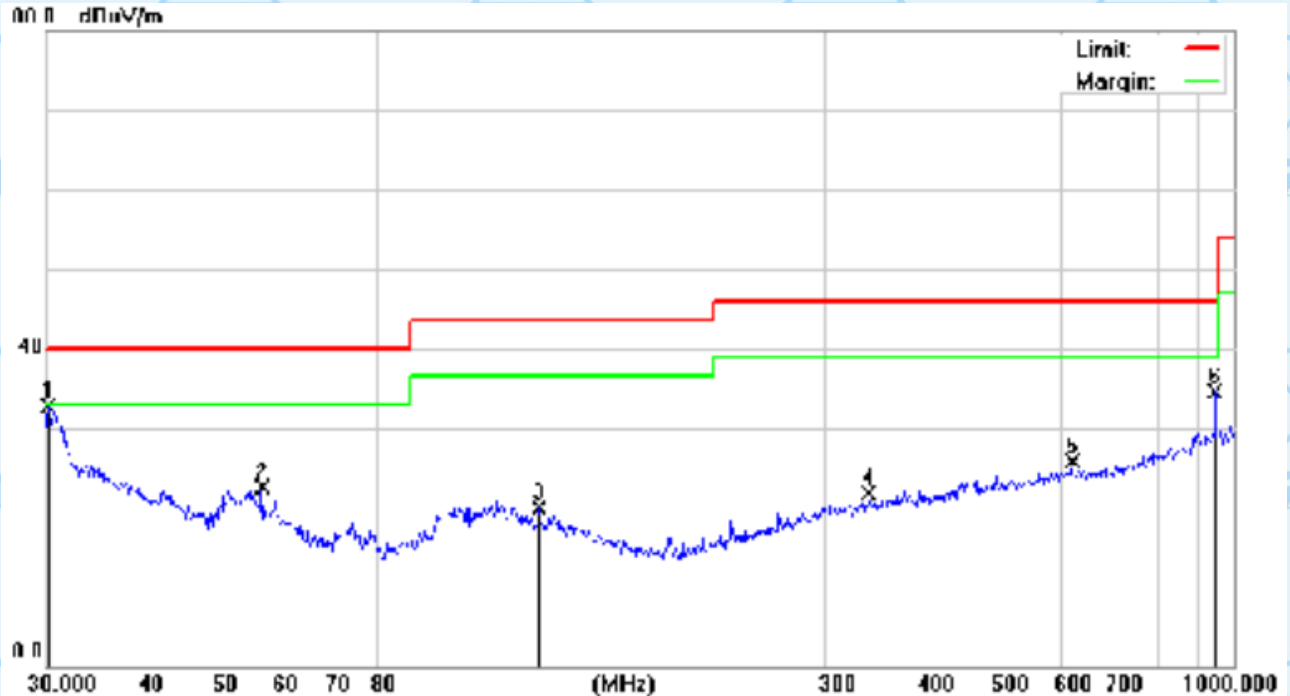

No.	Mk.	Freq. MHz	Reading Level dBuV	Correct Factor dB	Measure- ment dBuV/m	Limit dBuV/m	Over dB	Detector
1	*	30.2111	27.91	4.71	32.62	40.00	-7.38	QP
2		56.7917	28.31	-5.83	22.48	40.00	-17.52	QP
3		128.5630	23.42	-3.46	19.96	43.50	-23.54	QP
4		340.7817	23.44	-1.72	21.72	46.00	-24.28	QP
5		620.7096	24.14	1.59	25.73	46.00	-20.27	QP
6		948.7610	28.09	6.39	34.48	46.00	-11.52	QP







For Question,  
Please Contact with WSCT  
www.wsct-cert.com

Report No.:WSCT-A2LA-R&E210400003A-BLE

V:



No.	Mk.	Freq. MHz	Reading Level dBuV	Correct Factor dB	Measure- ment dBuV/m	Limit dBuV/m	Over dB	Detector
1	*	31.5095	28.26	4.22	32.48	40.00	-7.52	QP
2		56.7917	28.49	-5.83	22.66	40.00	-17.34	QP
3		118.1862	22.92	-2.65	20.27	43.50	-23.23	QP
4		189.7385	25.02	-7.19	17.83	43.50	-25.67	QP
5		449.5558	24.07	0.03	24.10	46.00	-21.90	QP
6		948.7610	27.17	6.39	33.56	46.00	-12.44	QP

Note: 1.All the modes have been investigated, and only worst mode is presented in this report.  
2.Over=Reading Level+ Correct Factor - Limit.







For Question,  
Please Contact with WSCT  
www.wsct-cert.com

Report No.:WSCT-A2LA-R&E210400003A-BLE

### 4.2.5.3 TEST RESULTS(1GHz to 25GHz)

Pressure	1010 hPa	Test Mode	Mode 1 TX(1Mbps)
Temperature	20 °C	Relative Humidity	48%

Freq. (MHz)	Ant.Pol.	Emission Level(dBuV)		Limit 3m(dBuV/m)		Over(dB)	
		PK	AV	PK	AV	PK	AV
4804	V	60.76	40.56	74	54	-13.24	-13.44
7206	V	58.02	39.02	74	54	-15.98	-14.98
4804	H	58.21	39.35	74	54	-15.79	-14.65
7206	H	58.97	39.97	74	54	-15.03	-14.03

Remark: All emissions not reported were more than 20dB below the specified limit or in the noise floor.

Pressure	1010 hPa	Test Mode	Mode 2 TX(2Mbps)
Temperature	20 °C	Relative Humidity	48%

Freq. (MHz)	Ant.Pol.	Emission Level(dBuV)		Limit 3m(dBuV/m)		Over(dB)	
		PK	AV	PK	AV	PK	AV
4882	V	59.71	40.48	74	54	-14.29	-13.52
7323	V	58.20	39.90	74	54	-15.80	-14.10
4882	H	58.21	40.31	74	54	-15.79	-13.69
7323	H	58.90	39.90	74	54	-15.10	-14.10

Remark: All emissions not reported were more than 20dB below the specified limit or in the noise floor.

Pressure	1010 hPa	Test Mode	Mode 3 TX(3Mbps)
Temperature	20 °C	Relative Humidity	48%

Freq. (MHz)	Ant.Pol.	Emission Level(dBuV)		Limit 3m(dBuV/m)		Over(dB)	
		PK	AV	PK	AV	PK	AV
4960	V	58.41	39.61	74	54	-15.59	-14.39
7440	V	58.19	39.03	74	54	-15.81	-14.97
4960	H	58.77	40.94	74	54	-15.23	-13.06
7440	H	58.27	39.27	74	54	-15.73	-14.73

Remark: All emissions not reported were more than 20dB below the specified limit or in the noise floor.







For Question,  
Please Contact with WSCT  
www.wsct-cert.com

Report No.:WSCT-A2LA-R&E210400003A-BLE

**4.2.5.4 TEST RESULTS (Restricted Bands Requirements)**

**Test result for 1Mbps Mode:**

Polarization	Vertical	Test Mode	TX /Mode1-1Mbps(CH0)
Temperature	20 °C	Relative Humidity	48%
Pressure	1010 hPa		

Frequency (MHz)	Meter Reading (dBμV)	Factor (dB)	Emission Level (dBμV/m)	Limits (dBμV/m)	Margin (dB)	Detector Type
2387	60.02	-8.76	51.26	74	22.74	peak
2387	56.19	-8.76	47.43	54	6.57	AVG
2390	63.19	-8.73	54.46	74	19.54	peak
2390	55.24	-8.73	46.51	54	7.49	AVG

Remark:  
Factor = Antenna Factor + Cable Loss – Pre-amplifier.  
All the x/y/z orientation has been investigated, and only worst case is presented in this report.

Polarization	Horizontal	Test Mode	TX /Mode1-1Mbps(CH0)
Temperature	20 °C	Relative Humidity	48%
Pressure	1010 hPa		

Frequency (MHz)	Meter Reading (dBμV)	Factor (dB)	Emission Level (dBμV/m)	Limits (dBμV/m)	Margin (dB)	Detector Type
2384	63.88	-8.76	55.12	74	18.88	peak
2384	54.51	-8.76	45.75	54	8.25	AVG
2390	62.95	-8.73	54.22	74	19.78	peak
2390	54.53	-8.73	45.80	54	8.20	AVG

Remark:  
Factor = Antenna Factor + Cable Loss – Pre-amplifier.  
All the x/y/z orientation has been investigated, and only worst case is presented in this report.







For Question,  
Please Contact with WSCT  
www.wsct-cert.com

Report No.: WSCT-A2LA-R&E210400003A-BLE

Polarization	Vertical	Test Mode	TX /Mode 3-1Mbps(CH78)
Temperature	20 °C	Relative Humidity	48%
Pressure	1010 hPa		

Frequency (MHz)	Meter Reading (dBμV)	Factor (dB)	Emission Level (dBμV/m)	Limits (dBμV/m)	Margin (dB)	Detector Type
2483.5	64.35	-8.17	56.18	74	17.82	peak
2483.5	54.19	-8.17	46.02	54	7.98	AVG

Remark:  
Factor = Antenna Factor + Cable Loss – Pre-amplifier.  
All the x/y/z orientation has been investigated, and only worst case is presented in this report.

Polarization	Horizontal	Test Mode	TX /Mode 3-1Mbps(CH78)
Temperature	20 °C	Relative Humidity	48%
Pressure	1010 hPa		

Frequency (MHz)	Meter Reading (dBμV)	Factor (dB)	Emission Level (dBμV/m)	Limits (dBμV/m)	Margin (dB)	Detector Type
2483.5	61.03	-8.17	52.86	74	21.14	peak
2483.5	53.10	-8.17	44.93	54	9.07	AVG

Remark:  
Factor = Antenna Factor + Cable Loss – Pre-amplifier.  
All the x/y/z orientation has been investigated, and only worst case is presented in this report.

**Test result for 2Mbps Mode:**

Polarization	Vertical	Test Mode	TX /Mode1-2Mbps(CH0)
Temperature	20 °C	Relative Humidity	48%
Pressure	1010 hPa		

Frequency (MHz)	Meter Reading (dBμV)	Factor (dB)	Emission Level (dBμV/m)	Limits (dBμV/m)	Margin (dB)	Detector Type
2387	60.26	-8.76	51.50	74	22.50	peak
2387	56.70	-8.76	47.94	54	6.06	AVG
2390	60.81	-8.73	52.08	74	21.92	peak
2390	55.80	-8.73	47.07	54	6.93	AVG

Remark:  
Factor = Antenna Factor + Cable Loss – Pre-amplifier.  
All the x/y/z orientation has been investigated, and only worst case is presented in this report.







For Question,  
Please Contact with WSCT  
www.wsct-cert.com

Report No.:WSCT-A2LA-R&E210400003A-BLE

Polarization	Horizontal	Test Mode	TX /Mode1-2Mbps(CH0)
Temperature	20 °C	Relative Humidity	48%
Pressure	1010 hPa		

Frequency (MHz)	Meter Reading (dBμV)	Factor (dB)	Emission Level (dBμV/m)	Limits (dBμV/m)	Margin (dB)	Detector Type
2384	62.19	-8.76	53.43	74	20.57	peak
2384	56.13	-8.76	47.37	54	6.63	AVG
2390	61.24	-8.73	52.51	74	21.49	peak
2390	57.55	-8.73	48.82	54	5.18	AVG

Remark:  
Factor = Antenna Factor + Cable Loss – Pre-amplifier.  
All the x/y/z orientation has been investigated, and only worst case is presented in this report.

Polarization	Vertical	Test Mode	TX /Mode3-2Mbps(CH78)
Temperature	20 °C	Relative Humidity	48%
Pressure	1010 hPa		

Frequency (MHz)	Meter Reading (dBμV)	Factor (dB)	Emission Level (dBμV/m)	Limits (dBμV/m)	Margin (dB)	Detector Type
2483.5	60.28	-8.17	52.11	74	21.89	peak
2483.5	53.11	-8.17	44.94	54	9.06	AVG

Remark:  
Factor = Antenna Factor + Cable Loss – Pre-amplifier.  
All the x/y/z orientation has been investigated, and only worst case is presented in this report.

Polarization	Horizontal	Test Mode	TX /Mode3-2Mbps(CH78)
Temperature	20 °C	Relative Humidity	48%
Pressure	1010 hPa		

Frequency (MHz)	Meter Reading (dBμV)	Factor (dB)	Emission Level (dBμV/m)	Limits (dBμV/m)	Margin (dB)	Detector Type
2483.5	62.90	-8.17	54.73	74	19.27	peak
2483.5	54.02	-8.17	45.85	54	8.15	AVG

Remark:  
Factor = Antenna Factor + Cable Loss – Pre-amplifier.  
All the x/y/z orientation has been investigated, and only worst case is presented in this report.







For Question,  
Please Contact with WSCT  
www.wsct-cert.com

Report No.: WSCT-A2LA-R&E210400003A-BLE

**Test result for 3Mbps Mode:**

Polarization	Vertical	Test Mode	TX /Model 1-3Mbps(CH0)
Temperature	20 °C	Relative Humidity	48%
Pressure	1010 hPa		

Frequency (MHz)	Meter Reading (dBμV)	Factor (dB)	Emission Level (dBμV/m)	Limits (dBμV/m)	Margin (dB)	Detector Type
2387	63.52	-8.76	54.76	74	19.24	peak
2387	56.28	-8.76	47.52	54	6.48	AVG
2390	59.93	-8.73	51.20	74	22.80	peak
2390	54.28	-8.73	45.55	54	8.45	AVG

Remark:

Factor = Antenna Factor + Cable Loss – Pre-amplifier.

All the x/y/z orientation has been investigated, and only worst case is presented in this report.

Polarization	Horizontal	Test Mode	TX /Mode 1-3Mbps(CH0)
Temperature	20 °C	Relative Humidity	48%
Pressure	1010 hPa		

Frequency (MHz)	Meter Reading (dBμV)	Factor (dB)	Emission Level (dBμV/m)	Limits (dBμV/m)	Margin (dB)	Detector Type
2384	64.06	-8.76	55.30	74	18.70	peak
2384	54.13	-8.76	45.37	54	8.63	AVG
2390	62.74	-8.73	54.01	74	19.99	peak
2390	57.51	-8.73	48.78	54	5.22	AVG

Remark:

Factor = Antenna Factor + Cable Loss – Pre-amplifier.

All the x/y/z orientation has been investigated, and only worst case is presented in this report.







For Question,  
Please Contact with WSCT  
www.wsct-cert.com

Report No.: WSCT-A2LA-R&E210400003A-BLE

Polarization	Vertical	Test Mode	TX /Model 3-3Mbps(CH78)
Temperature	20 °C	Relative Humidity	48%
Pressure	1010 hPa		

Frequency (MHz)	Meter Reading (dBμV)	Factor (dB)	Emission Level (dBμV/m)	Limits (dBμV/m)	Margin (dB)	Detector Type
2483.5	63.60	-8.17	55.43	74	18.57	peak
2483.5	54.01	-8.17	45.84	54	8.16	AVG

Remark:

Factor = Antenna Factor + Cable Loss – Pre-amplifier.

All the x/y/z orientation has been investigated, and only worst case is presented in this report.

Polarization	Horizontal	Test Mode	TX /Model 3-3Mbps(CH78)
Temperature	20 °C	Relative Humidity	48%
Pressure	1010 hPa		

Frequency (MHz)	Meter Reading (dBμV)	Factor (dB)	Emission Level (dBμV/m)	Limits (dBμV/m)	Margin (dB)	Detector Type
2483.5	64.06	-8.17	55.89	74	18.11	peak
2483.5	53.59	-8.17	45.42	54	8.58	AVG

Remark:

Factor = Antenna Factor + Cable Loss – Pre-amplifier.

All the x/y/z orientation has been investigated, and only worst case is presented in this report.







For Question,  
Please Contact with WSCT  
www.wsct-cert.com

Report No.:WSCT-A2LA-R&E210400003A-BLE

**Test result for hopping mode:**

Polarization	Vertical	Test Mode	hopping mode-1Mbps
Temperature	20 °C	Relative Humidity	48%
Pressure	1010 hPa		

Frequency (MHz)	Meter Reading (dBμV)	Factor (dB)	Emission Level (dBμV/m)	Limits (dBμV/m)	Margin (dB)	Detector Type
2387	62.89	-8.76	54.13	74	19.87	peak
2387	56.65	-8.76	47.89	54	6.11	AVG
2390	63.52	-8.73	54.79	74	19.21	peak
2390	57.96	-8.73	49.23	54	4.77	AVG

Remark:  
Factor = Antenna Factor + Cable Loss – Pre-amplifier.  
All the x/y/z orientation has been investigated, and only worst case is presented in this report.

Polarization	Horizontal	Test Mode	Hopping mode-1Mbps
Temperature	20 °C	Relative Humidity	48%
Pressure	1010 hPa		

Frequency (MHz)	Meter Reading (dBμV)	Factor (dB)	Emission Level (dBμV/m)	Limits (dBμV/m)	Margin (dB)	Detector Type
2387	61.02	-8.76	52.26	74	21.74	peak
2387	53.85	-8.76	45.09	54	8.91	AVG
2390	63.20	-8.73	54.47	74	19.53	peak
2390	56.45	-8.73	47.72	54	6.28	AVG

Remark:  
Factor = Antenna Factor + Cable Loss – Pre-amplifier.  
All the x/y/z orientation has been investigated, and only worst case is presented in this report.

Polarization	Vertical	Test Mode	Hopping mode-1Mbps
Temperature	20 °C	Relative Humidity	48%
Pressure	1010 hPa		

Frequency (MHz)	Meter Reading (dBμV)	Factor (dB)	Emission Level (dBμV/m)	Limits (dBμV/m)	Margin (dB)	Detector Type
2483.5	63.82	-8.17	55.65	74	18.35	peak
2483.5	53.87	-8.17	45.70	54	8.30	AVG

Remark:  
Factor = Antenna Factor + Cable Loss – Pre-amplifier.  
All the x/y/z orientation has been investigated, and only worst case is presented in this report.

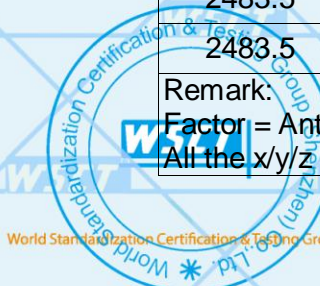





Report No.:WSCT-A2LA-R&E210400003A-BLE

For Question, Please Contact with WSCT  
www.wsct-cert.com

Polarization	Horizontal	Test Mode	Hopping mode-1Mbps
Temperature	20 °C	Relative Humidity	48%
Pressure	1010 hPa		

Frequency (MHz)	Meter Reading (dBμV)	Factor (dB)	Emission Level (dBμV/m)	Limits (dBμV/m)	Margin (dB)	Detector Type
2483.5	64.36	-8.17	56.19	74	17.81	peak
2483.5	54.76	-8.17	46.59	54	7.41	AVG

Remark:

Factor = Antenna Factor + Cable Loss – Pre-amplifier.

All the x/y/z orientation has been investigated, and only worst case is presented in this report.







For Question,  
Please Contact with WSCT  
www.wsct-cert.com

Report No.:WSCT-A2LA-R&E210400003A-BLE

## 5. NUMBER OF HOPPING CHANNEL

### 5.1 APPLIED PROCEDURES / LIMIT

FCC Part15 (15.247) , Subpart C				
Section	Test Item	Limit	Frequency Range (MHz)	Result
15.247 (a)(1)(iii)	Number of Hopping Channel	≥15	2400-2483.5	PASS

Spectrum Parameters	Setting
Attenuation	Auto
Span Frequency	> Operating Frequency Range
RB	1MHz
VB	3MHz
Detector	Peak
Trace	Max Hold
Sweep Time	Auto

#### 5.1.1 TEST PROCEDURE

- The EUT was directly connected to the spectrum analyzer and antenna output port as show in the block diagram below,
- Spectrum Setting: RBW= 1MHz, VBW=3MHz, Sweep time = Auto.

#### 5.1.2 DEVIATION FROM STANDARD

No deviation.

#### 5.1.3 TEST SETUP



#### 5.1.4 EUT OPERATION CONDITIONS

The EUT tested system was configured as the statements of 2.4 Unless otherwise a special operating condition is specified in the follows during the testing.







For Question,  
Please Contact with WSCT  
www.wsct-cert.com

Report No.:WSCT-A2LA-R&E210400003A-BLE

### 5.2 TEST RESULTS

Mode	Hopping channel numbers	Limit	Result
GFSK, P/4-DQPSK, 8DPSK	79	15	PASS

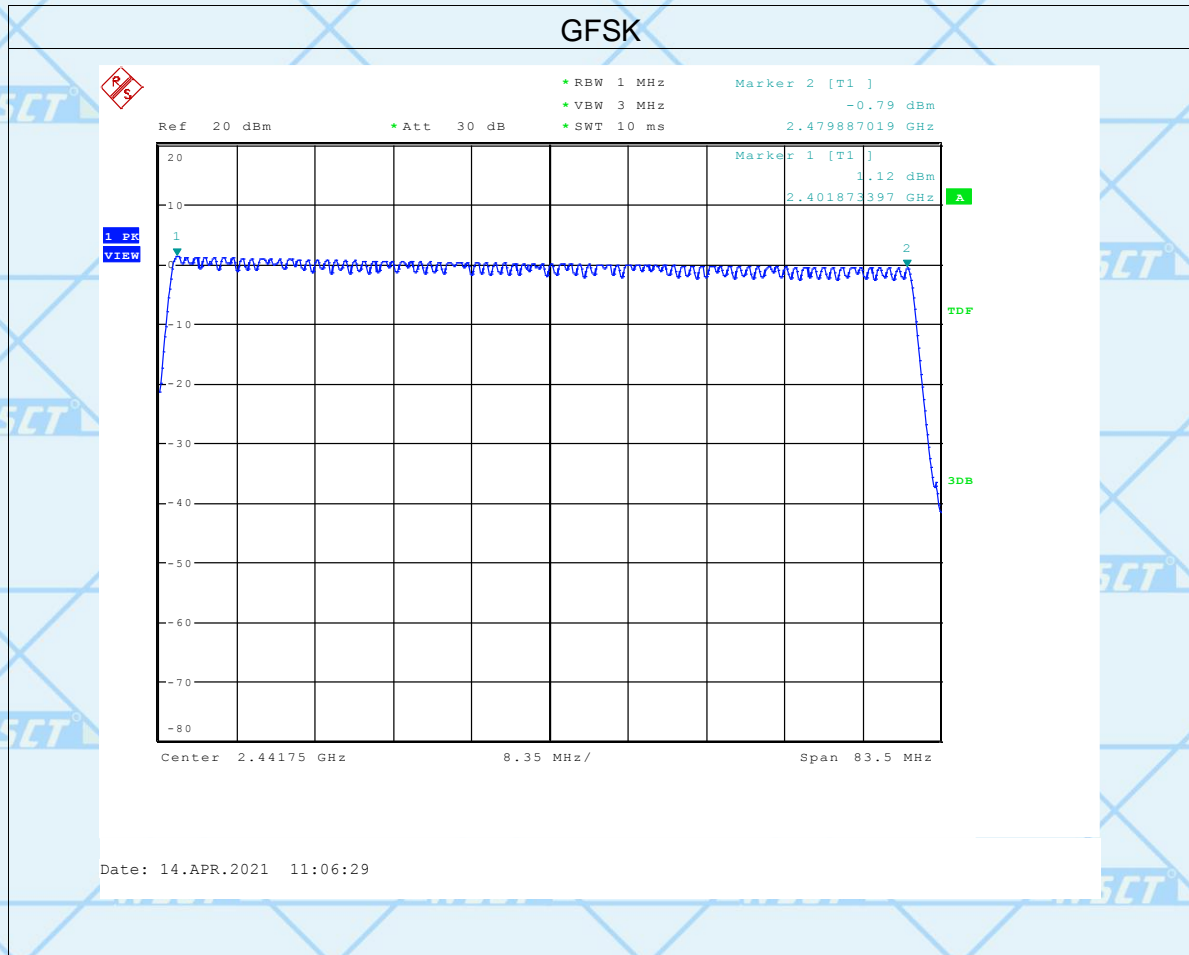



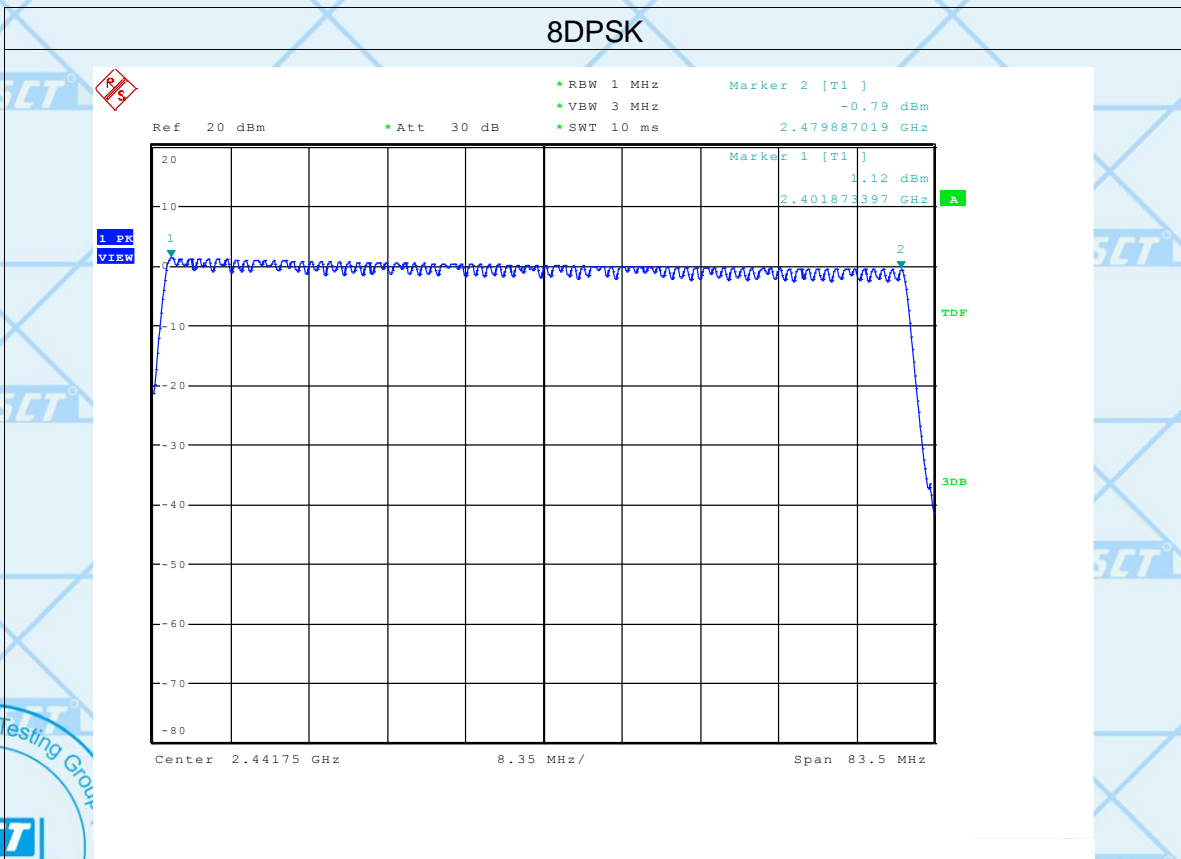
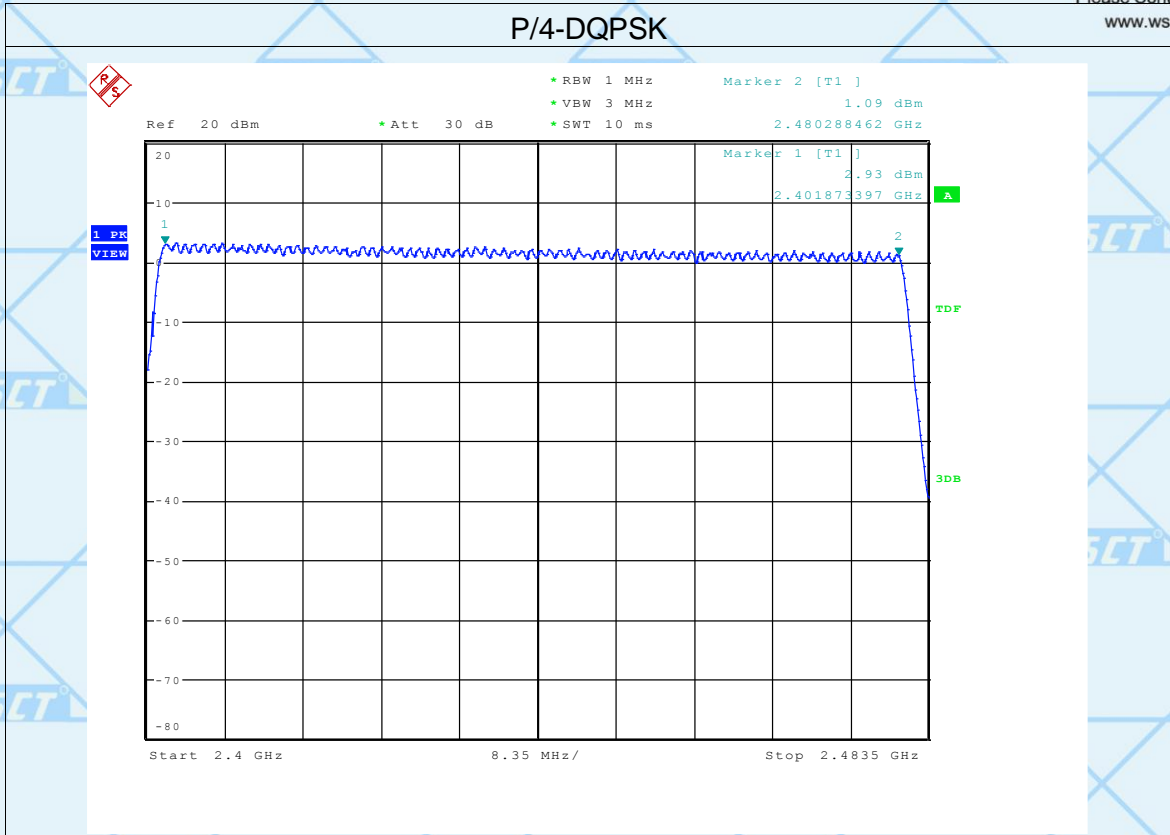



For Question,  
Please Contact with WSCT  
www.wsct-cert.com

Report No.:WSCT-A2LA-R&E210400003A-BLE

## 6. AVERAGE TIME OF OCCUPANCY

### 6.1 APPLIED PROCEDURES / LIMIT

FCC Part15 (15.247) , Subpart C				
Section	Test Item	Limit	Frequency Range (MHz)	Result
15.247 (a)(1)(iii)	Average Time of Occupancy	0.4sec	2400-2483.5	PASS

#### 6.1.2 TEST PROCEDURE

- a. The EUT test port was connected to the spectrum analyzer with RF cable and antenna connector.
- b. Set RBW of spectrum analyzer to 1MHz and VBW to 3MHz.
- c. Use a video trigger with the trigger level set to enable triggering only on full pulses.
- d. Sweep Time is more than once pulse time.
- e. Set the center frequency on any frequency would be measure and set the frequency span to zero span.
- f. Measure the maximum time duration of one single pulse.
- g. Set the EUT for 1DH5, 2DH5 and 3DH5 packet transmitting.
- h. Measure the maximum time duration of one single pulse.
- i. Dwell time = Pulse time\*(1600/6/79)\*31.6S

#### 6.1.3 DEVIATION FROM STANDARD

No deviation.







For Question,  
Please Contact with WSCT  
[www.wsct-cert.com](http://www.wsct-cert.com)

Report No.:WSCT-A2LA-R&E210400003A-BLE

### 6.1.4 TEST SETUP

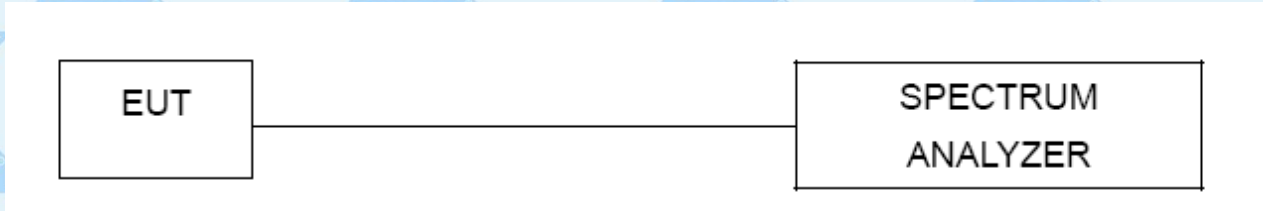

### 6.1.5 EUT OPERATION CONDITIONS

The EUT tested system was configured as the statements of 2.4 Unless otherwise a special operating condition is specified in the follows during the testing.







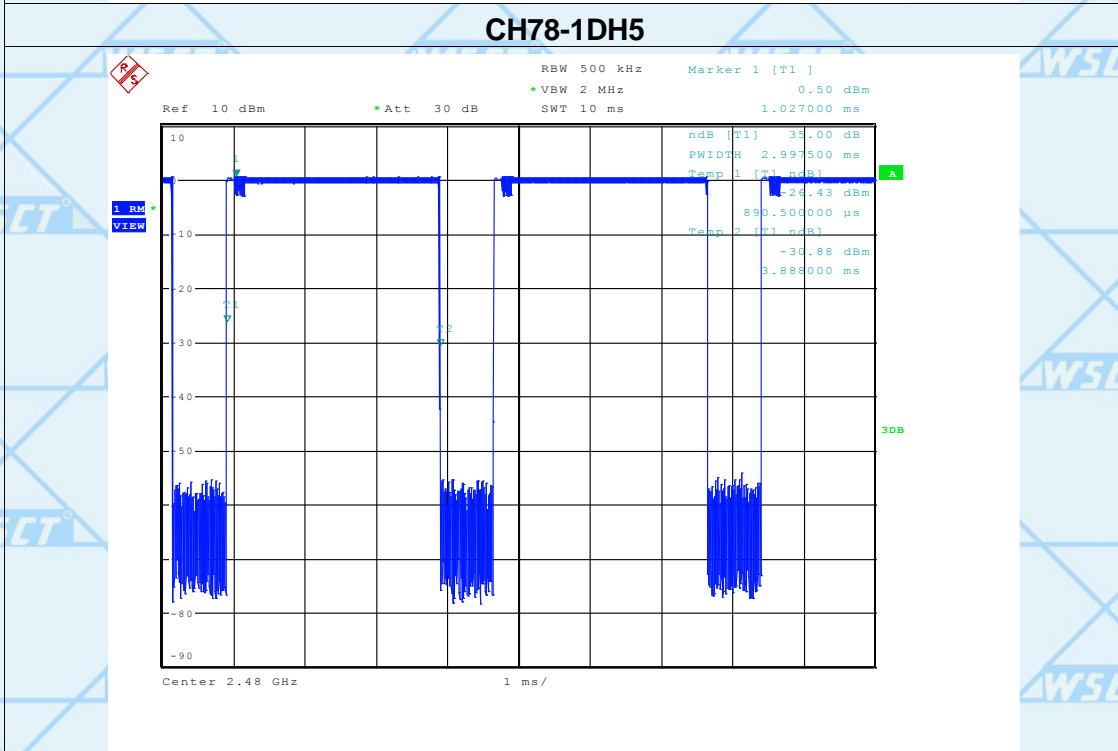
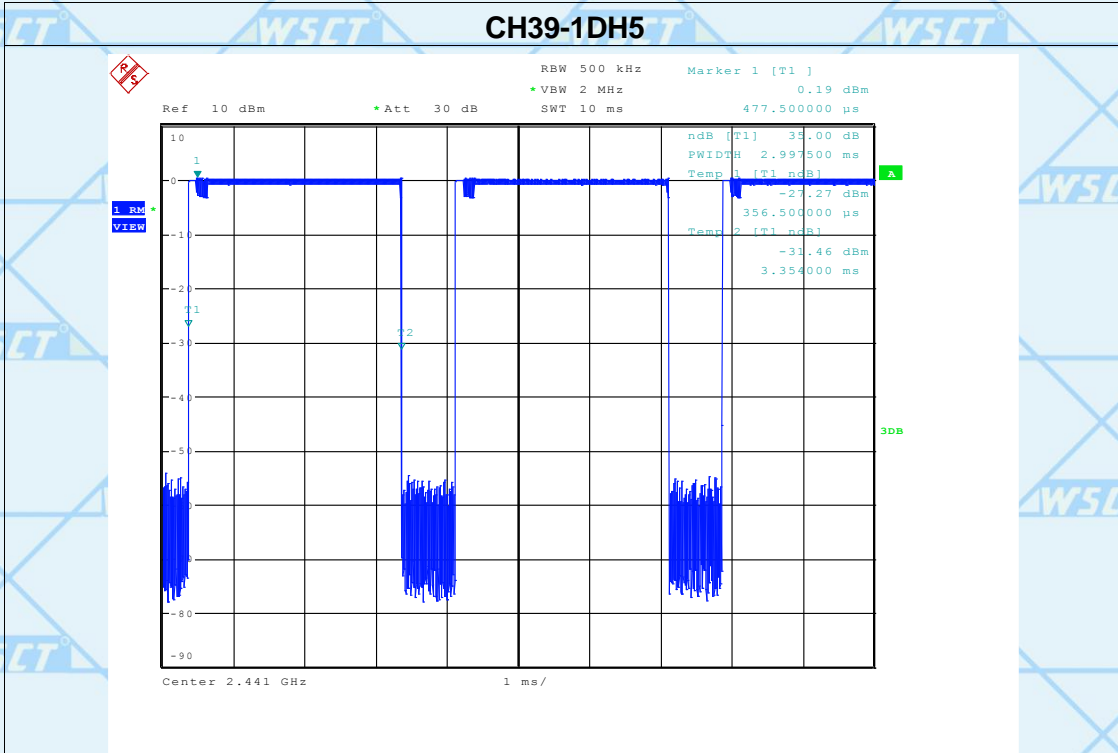





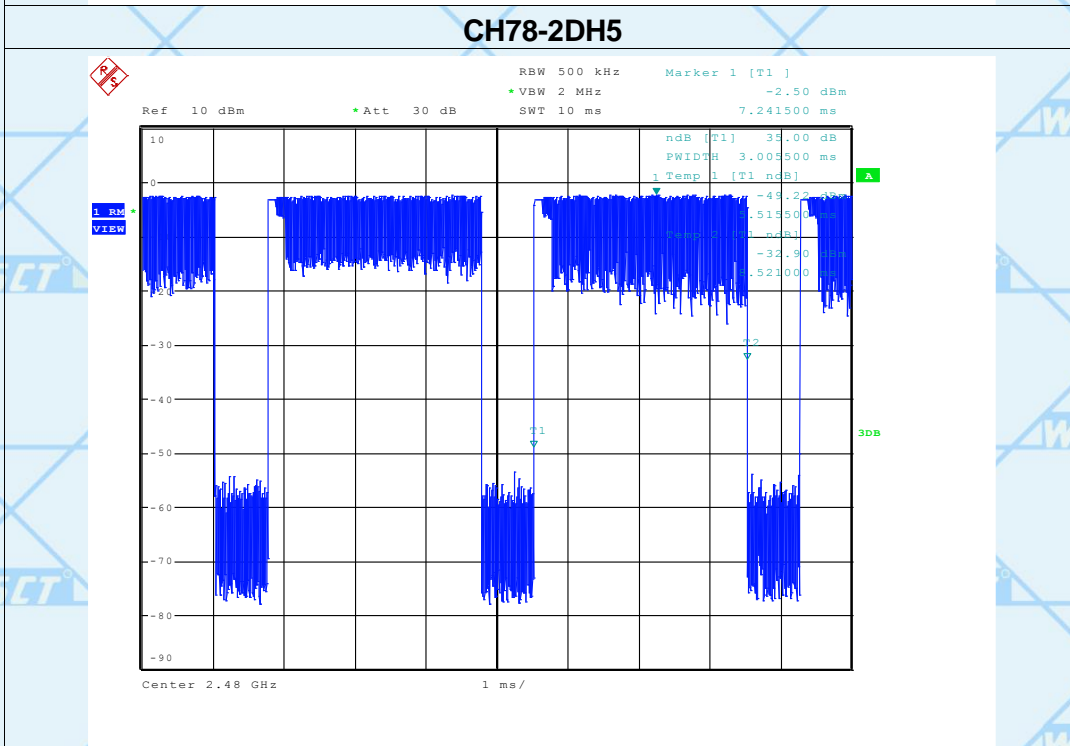
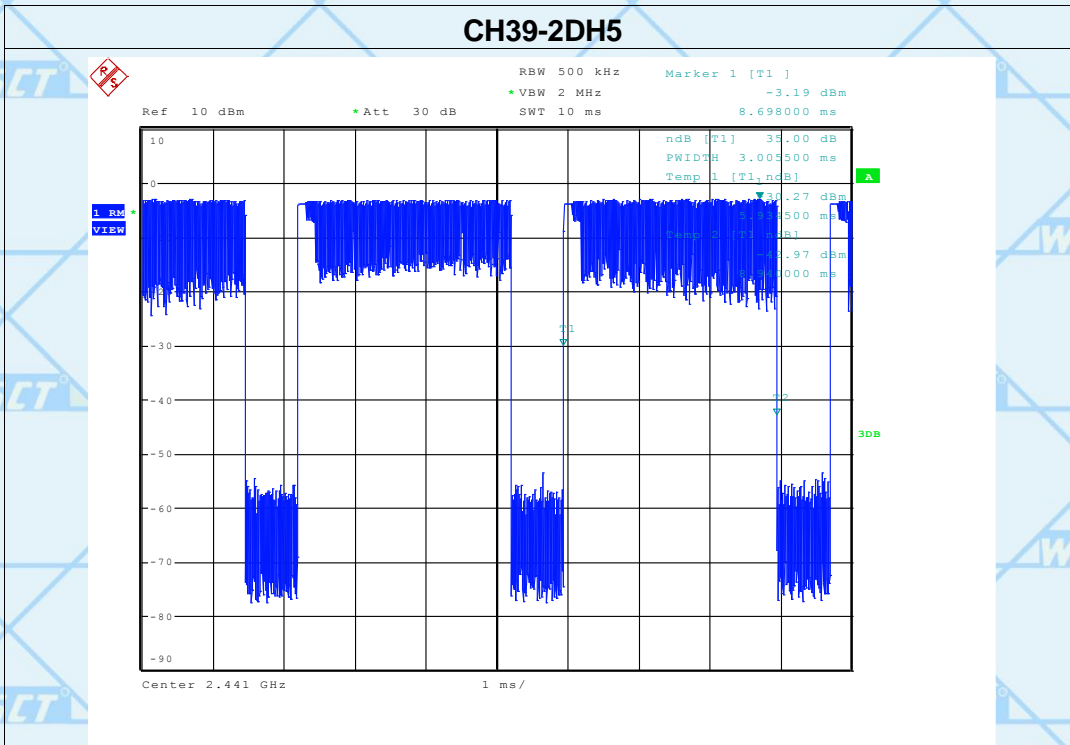



For Question,  
Please Contact with WSCT  
www.wsct-cert.com

Report No.:WSCT-A2LA-R&E210400003A-BLE

Pressure	1012 hPa	Test Mode	DH5-1Mbps
Temperature	25°C	Relative Humidity	60%

Data Packet	Frequency	Pulse time(ms)	Dwell Time(S)	Limits (S)
3DH5	2402MHz	3.006	0.321	0.4
3DH5	2441MHz	3.006	0.321	0.4
3DH5	2480MHz	3.006	0.321	0.4

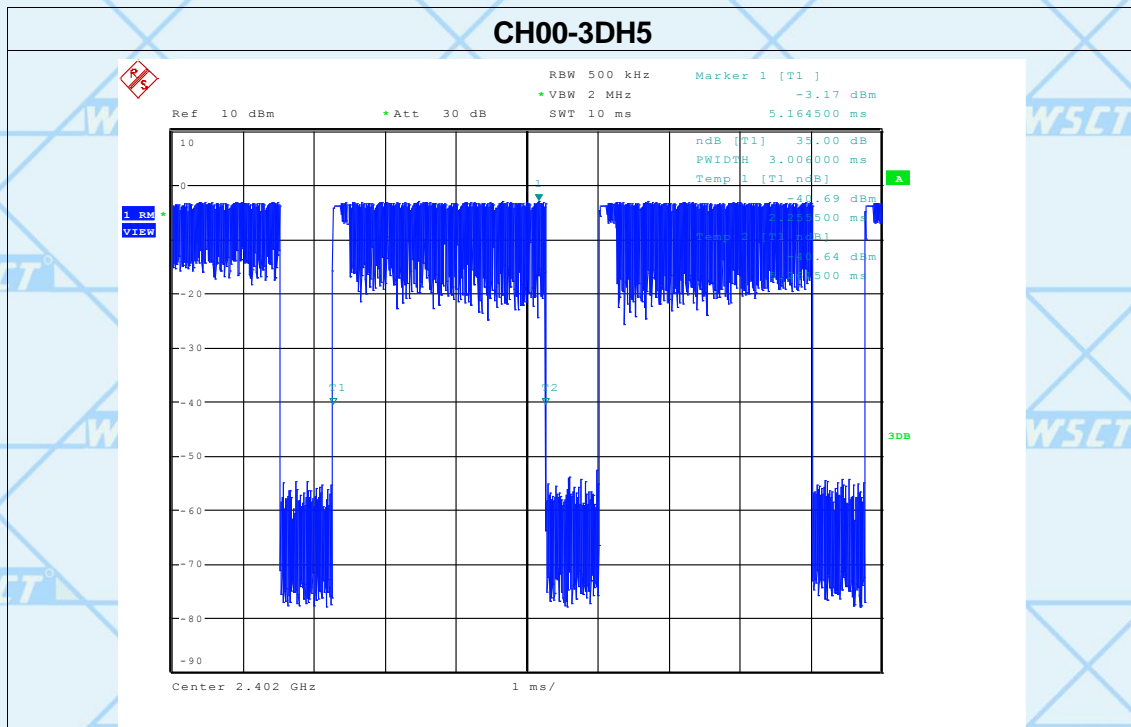

世标检测认证股份

World Standardization Certification & Testing Group (Shenzhen) Co., Ltd.

ADD: Building A-B Baoshi Science & Technology Park, Baoshi Road, Bao'an District, Shenzhen, Guangdong, China  
 TEL: 86-755-26996192 26992306    FAX: 86-755-86376605    E-mail: Fengbing.Wang@wsct-cert.com    Http: www.wsct-cert.com

Member of the WSCT INC.





For Question,  
Please Contact with WSCT  
www.wsct-cert.com

Report No.: WSCT-A2LA-R&E210400003A-BLE

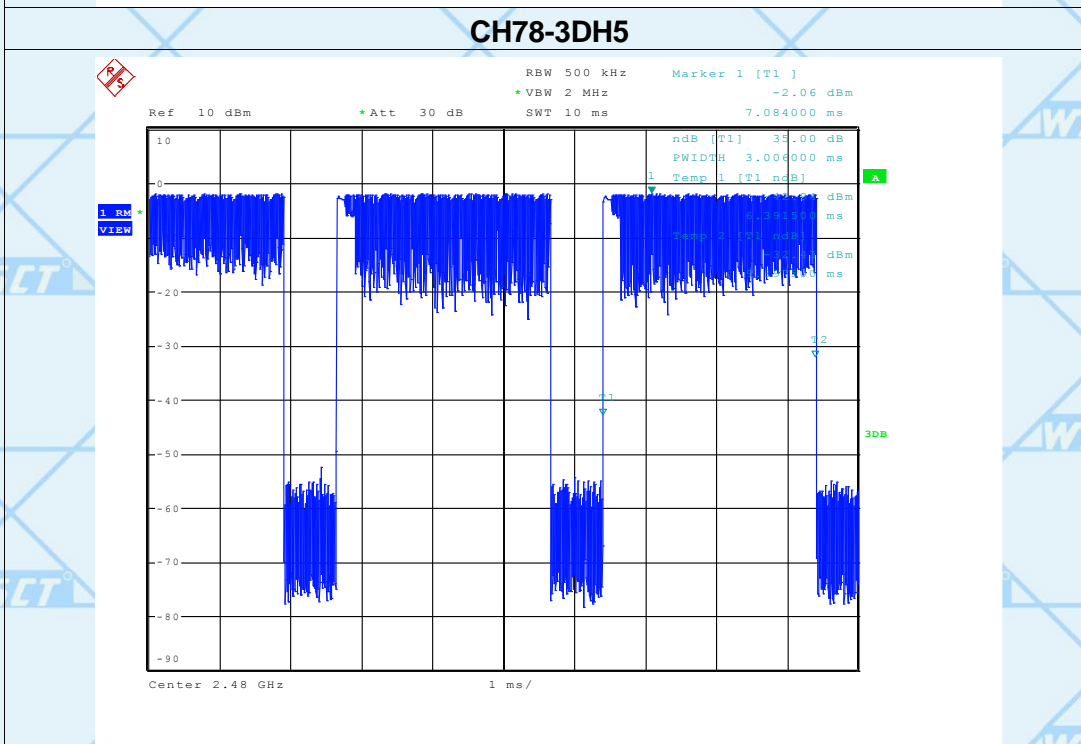
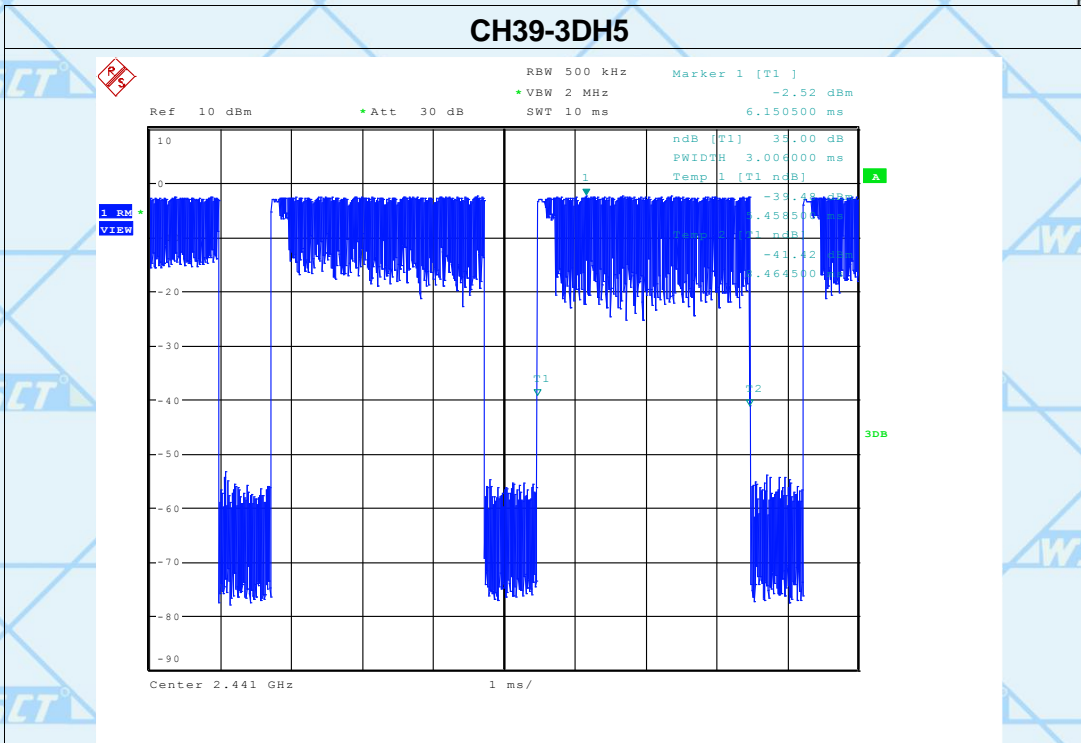



For Question,  
Please Contact with WSCT  
www.wsct-cert.com

Report No.: WSCT-A2LA-R&E210400003A-BLE

## 7. HOPPING CHANNEL SEPARATION MEASUREMENT

### 7.1 APPLIED PROCEDURES / LIMIT

Frequency hopping systems operating in the 2400-2483.5 MHz band may have hopping channel carrier frequencies that are separated by 25 kHz or two-thirds of the 20 dB bandwidth of the hopping channel, whichever is greater.

Spectrum Parameter	Setting
Attenuation	Auto
Span Frequency	> Measurement Bandwidth or Channel Separation
RB	Resolution (or IF) Bandwidth (RBW) $\geq$ 1% of the span
VB	Video (or Average) Bandwidth (VBW) $\geq$ RBW
Detector	Peak
Trace	Max hold
Sweep Time	Auto

#### 7.1.2 TEST PROCEDURE

1. Check the calibration of the measuring instrument using either an internal calibrator or a known signal from an external generator.
2. Set the spectrum analyzer as follows: Span = wide enough to capture the peaks of two adjacent channels; Resolution (or IF) Bandwidth (RBW)  $\geq$  1% of the span; Video (or Average) Bandwidth (VBW)  $\geq$  RBW; Sweep = auto; Detector function = peak; Trace = max hold
3. Measure the separation between the peaks of the adjacent channels using the marker-delta function.
4. Repeat above procedures until all frequencies measured were complete.

#### 7.1.3 DEVIATION FROM STANDARD

No deviation.

#### 7.1.4 TEST SETUP

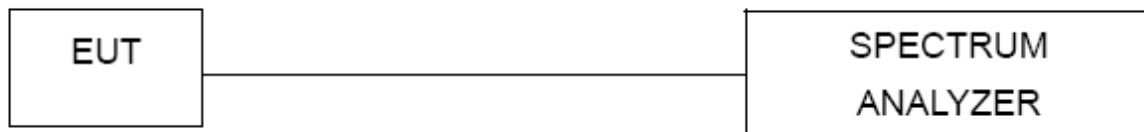

#### 7.1.5 EUT OPERATION CONDITIONS

The EUT was programmed to be in continuously transmitting mode.







For Question,  
Please Contact with WSCT  
www.wsct-cert.com

Report No.:WSCT-A2LA-R&E210400003A-BLE

### 7.2 TEST RESULTS

Pressure	1012 hPa	Test Mode	CH00 / CH39 /CH78 (1Mbps Mode)
Temperature	25°C	Relative Humidity	60%
Test Result	Pass		

Channel number	Channel frequency (MHz)	Separation Read value (KHz)	Separation limit (KHz)
00	2402	1000	20dB BW
39	2441	1000	20dB BW
78	2480	1000	20dB BW

Note: 20db bandwidth refer to section9.6

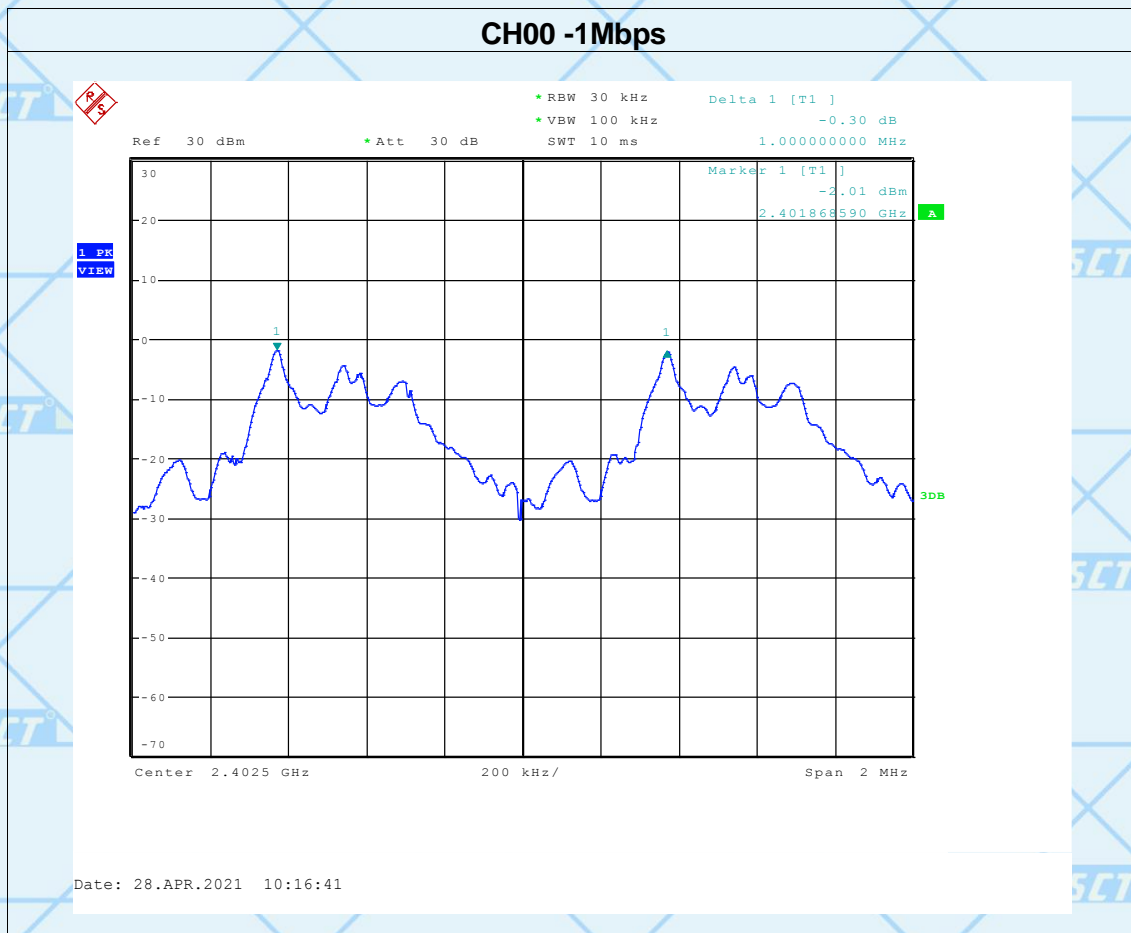



For Question,  
Please Contact with WSCT  
www.wsct-cert.com

Report No.:WSCT-A2LA-R&E210400003A-BLE

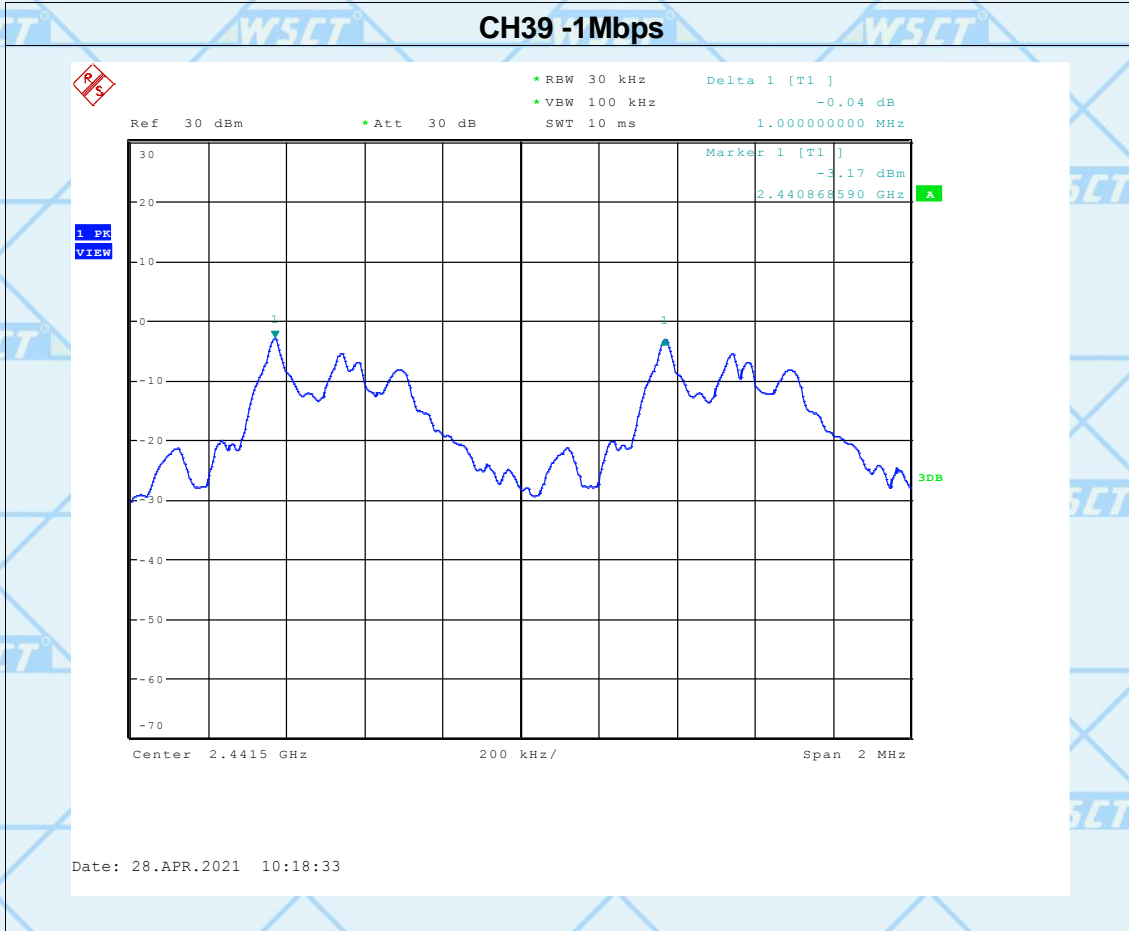





For Question,  
Please Contact with WSCT  
www.wsct-cert.com

Report No.: WSCT-A2LA-R&E210400003A-BLE

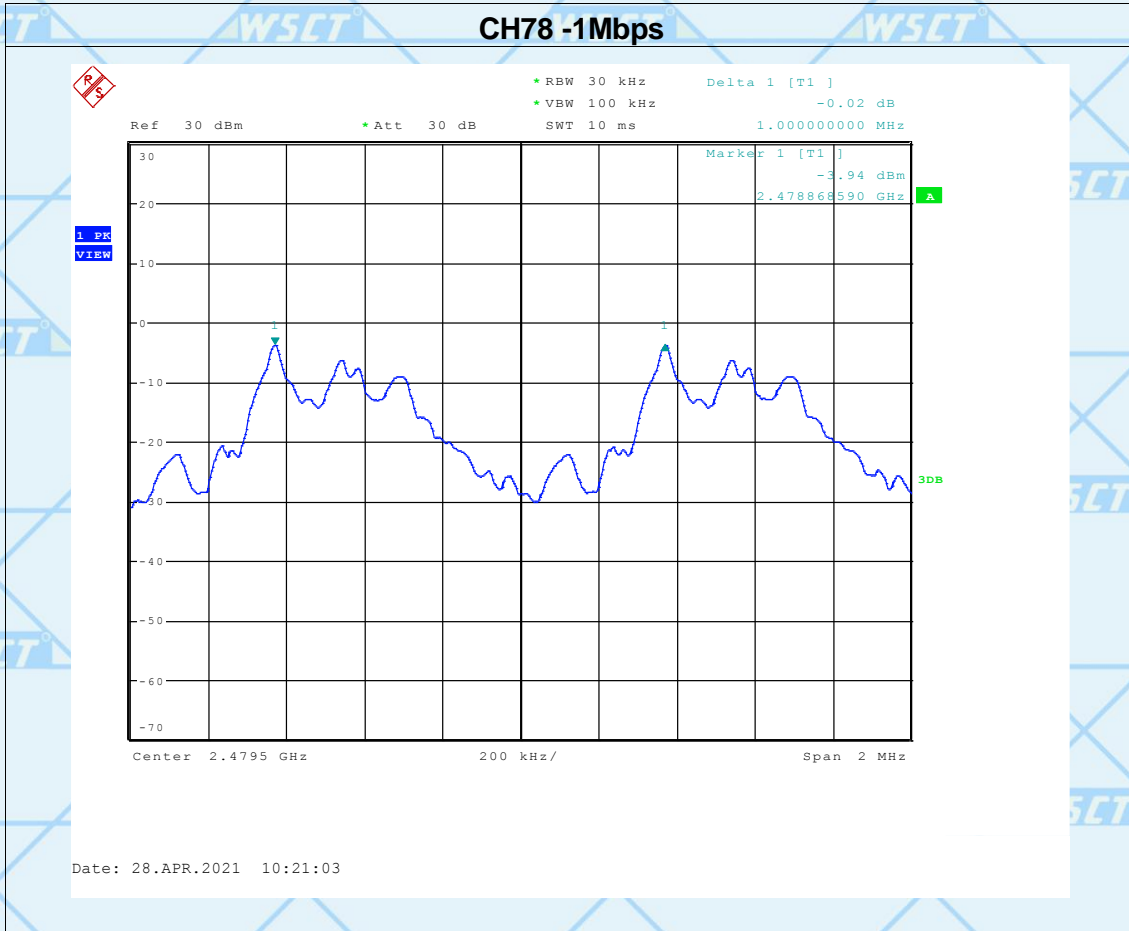



For Question,  
Please Contact with WSCT  
www.wsct-cert.com

Report No.:WSCT-A2LA-R&E210400003A-BLE

Pressure	1012 hPa	Test Mode	CH00 / CH39 /CH78 (2Mbps Mode)
Temperature	25°C	Relative Humidity	60%
Test Result	Pass		

Channel number	Channel frequency (MHz)	Separation Read value (KHz)	Separation limit (KHz)
00	2402	1000	2/3 *20dB BW
39	2441	1003	2/3 *20dB BW
78	2480	1000	2/3 *20dB BW

Note: 20db bandwidth refer to section 9.6

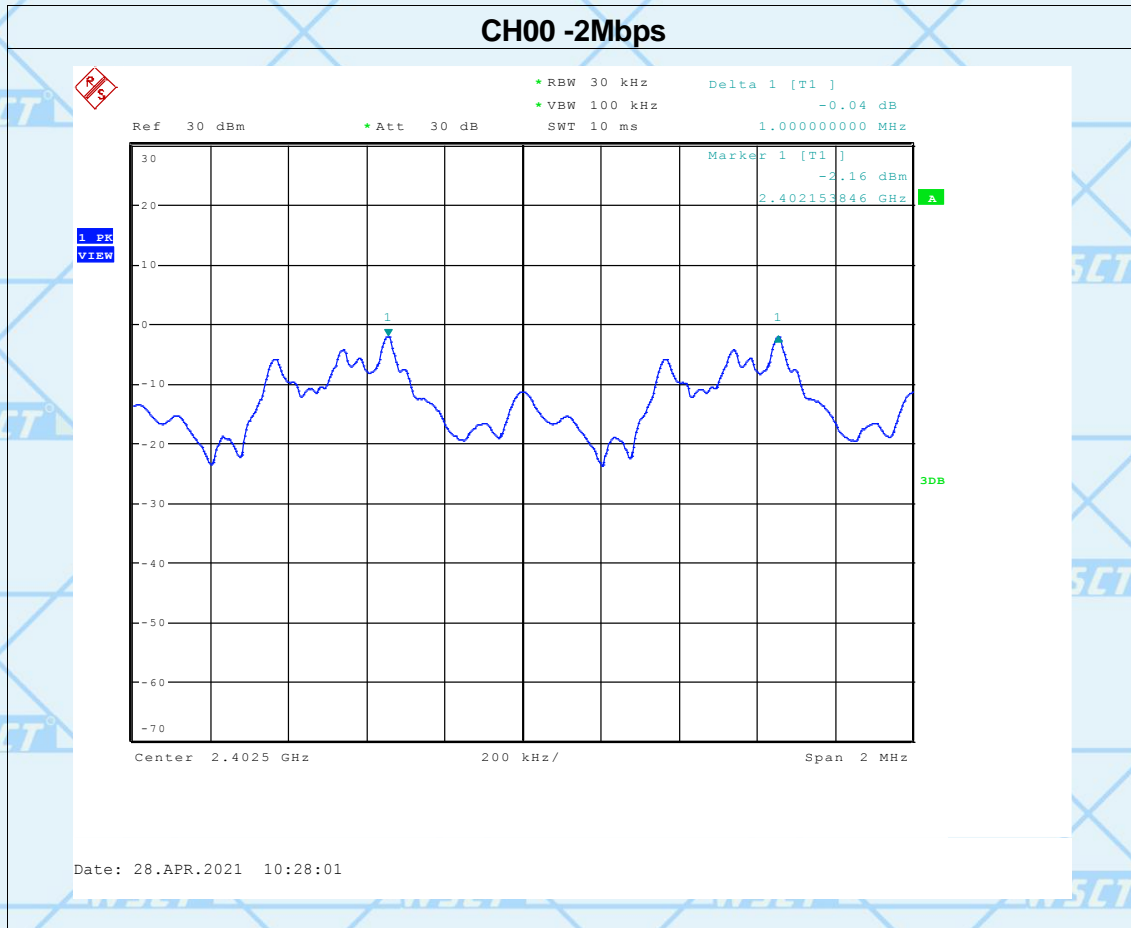





For Question,  
Please Contact with WSCT  
www.wsct-cert.com

Report No.: WSCT-A2LA-R&E210400003A-BLE

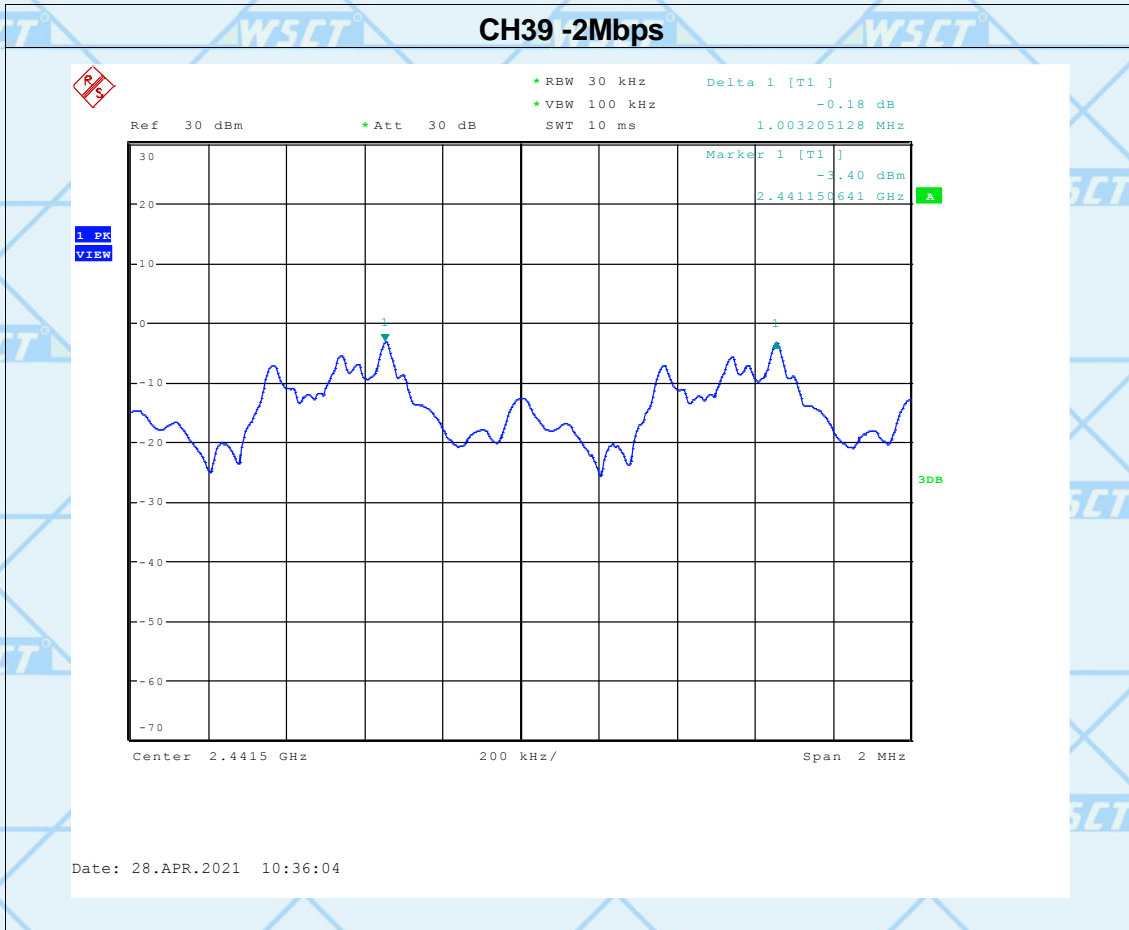



For Question,  
Please Contact with WSCT  
www.wsct-cert.com

Report No.: WSCT-A2LA-R&E210400003A-BLE

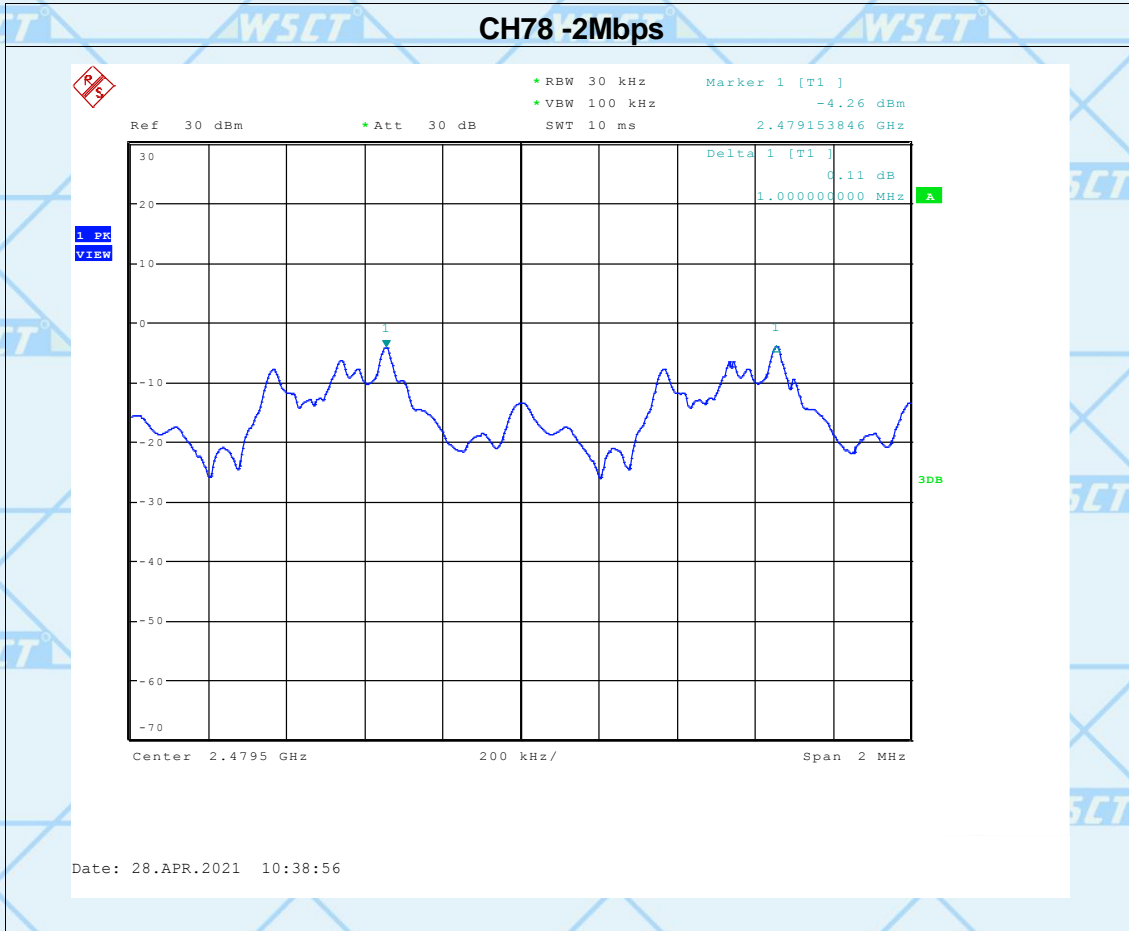





For Question,  
Please Contact with WSCT  
www.wsct-cert.com

Report No.:WSCT-A2LA-R&E210400003A-BLE

Pressure	1012 hPa	Test Mode	CH00 / CH39 /CH78 (3Mbps Mode)
Temperature	25°C	Relative Humidity	60%
Test Result	Pass		

Channel number	Channel frequency (MHz)	Separation Read value (KHz)	Separation limit (KHz)
00	2402	1003	2/3 *20dB BW
39	2441	1000	2/3 *20dB BW
78	2480	1003	2/3 *20dB BW

Note: 20db bandwidth refer to section 9.6

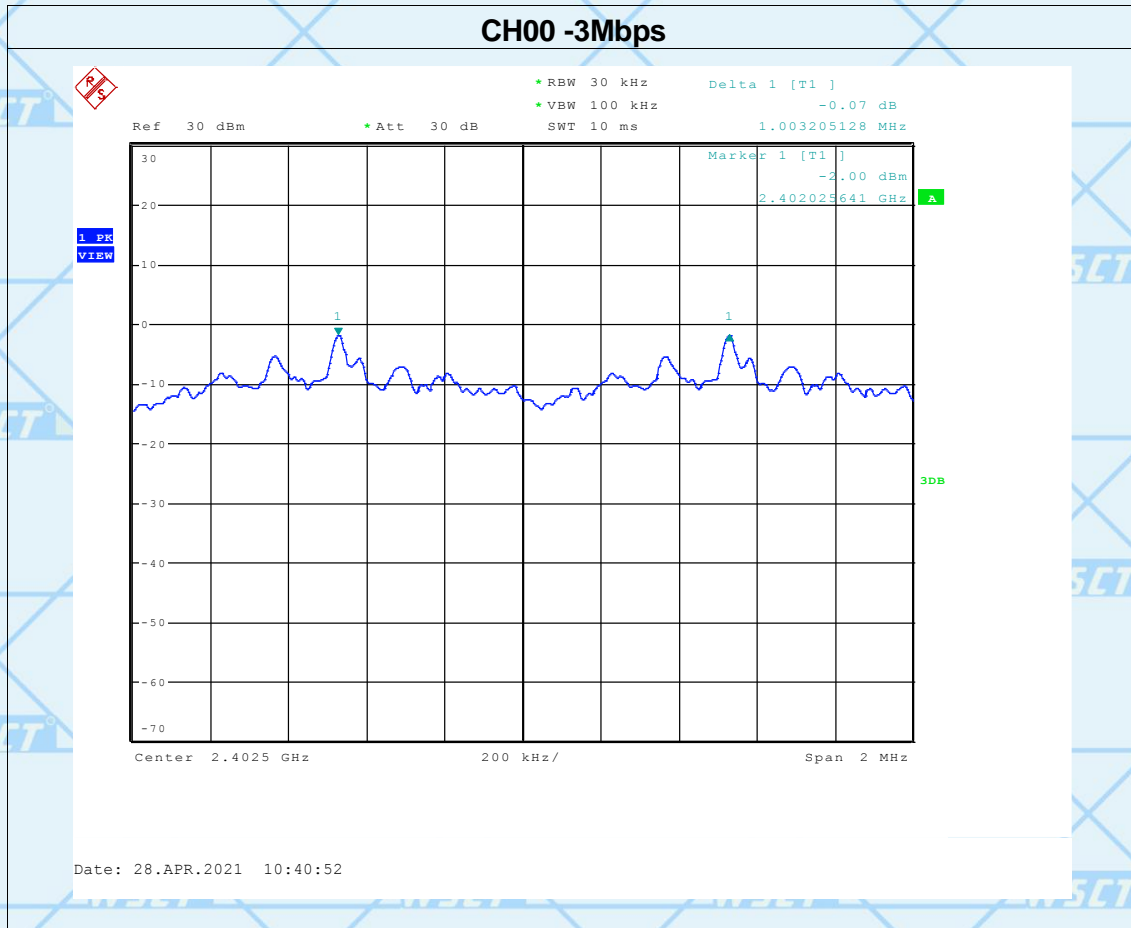



For Question,  
Please Contact with WSCT  
www.wsct-cert.com

Report No.:WSCT-A2LA-R&E210400003A-BLE

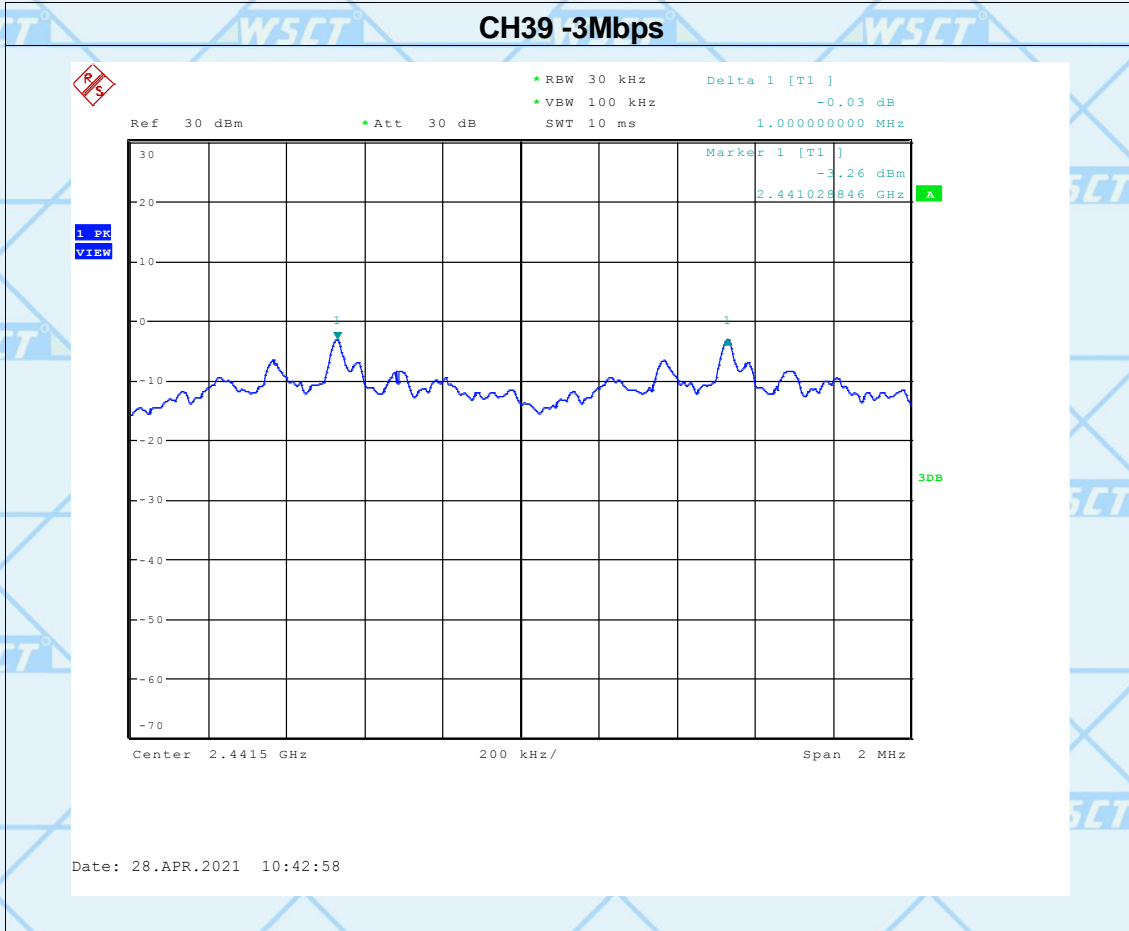

世标检测认证股份

World Standardization Certification & Testing Group (Shenzhen) Co., Ltd.

ADD: Building A-B Baoshi Science & Technology Park, Baoshi Road, Bao'an District, Shenzhen, Guangdong, China  
TEL: 86-755-26996192 26992306 FAX: 86-755-86376605 E-mail: Fengbing.Wang@wsct-cert.com Http: www.wsct-cert.com

Member of the WSCT INC.





For Question,  
Please Contact with WSCT  
www.wsct-cert.com

Report No.:WSCT-A2LA-R&E210400003A-BLE

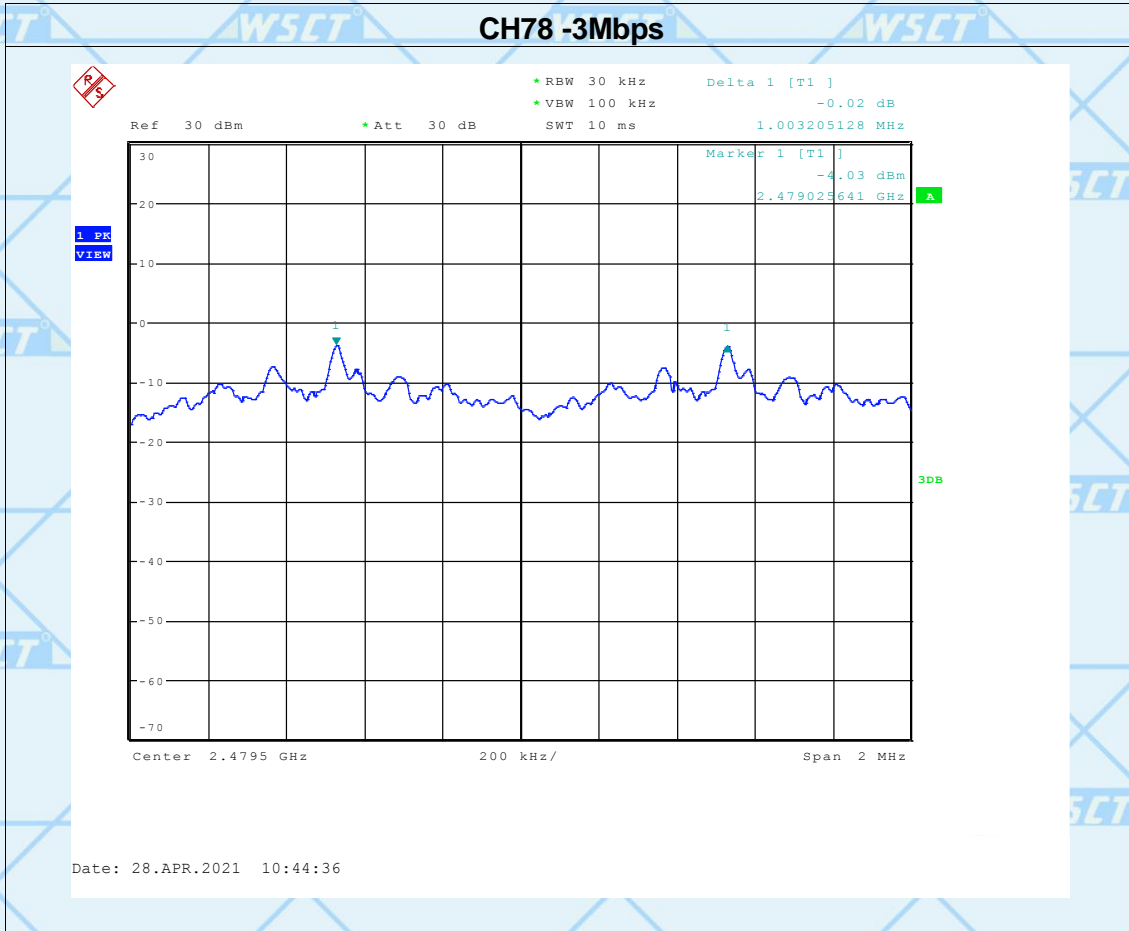



For Question,  
Please Contact with WSCT  
www.wsct-cert.com

Report No.:WSCT-A2LA-R&E210400003A-BLE

## 8. BANDWIDTH TEST

### 8.1 APPLIED PROCEDURES / LIMIT

FCC Part15 (15.247) , Subpart C				
Section	Test Item	Limit	Frequency Range (MHz)	Result
15.247 (a)(1)	Bandwidth	(20dB bandwidth)	2400-2483.5	PASS

Spectrum Parameter	Setting
Attenuation	Auto
Span Frequency	> Measurement Bandwidth or Channel Separation
RB	30kHz
VB	100 kHz
Detector	Peak
Trace	Max hold
Sweep Time	Auto

#### 8.1.2 TEST PROCEDURE

1. Check the calibration of the measuring instrument (spectrum analyzer) using either an internal calibrator or a known signal from an external generator.
2. Set the spectrum analyzer as follows: VBW =30kHz, RBW=100kHz, Sweep = auto Detector function = peak ,Trace = max hold
3. Measure the highest amplitude appearing on spectral display and record the level to calculate results.
4. Repeat above procedures until all frequencies measured were complete.

#### 8.1.3 DEVIATION FROM STANDARD

No deviation.

#### 8.1.4 TEST SETUP



#### 8.1.5 EUT OPERATION CONDITIONS

The EUT tested system was configured as the statements of 2.4 Unless otherwise a special operating condition is specified in the follows during the testing.







For Question,  
Please Contact with WSCT  
www.wsct-cert.com

Report No.: WSCT-A2LA-R&E210400003A-BLE

### 8.2 TEST RESULTS

Note: *the worst case is DH5 as result in this part.*

Pressure	1012 hPa	Test Mode	CH00/CH39/C78(1Mbps)
Temperature	25°C	Relative Humidity	60%

Frequency	20dB Bandwidth (kHz)	Result
2402 MHz	788	PASS
2441 MHz	798	PASS
2480 MHz	798	PASS

#### CH00 -1Mbps

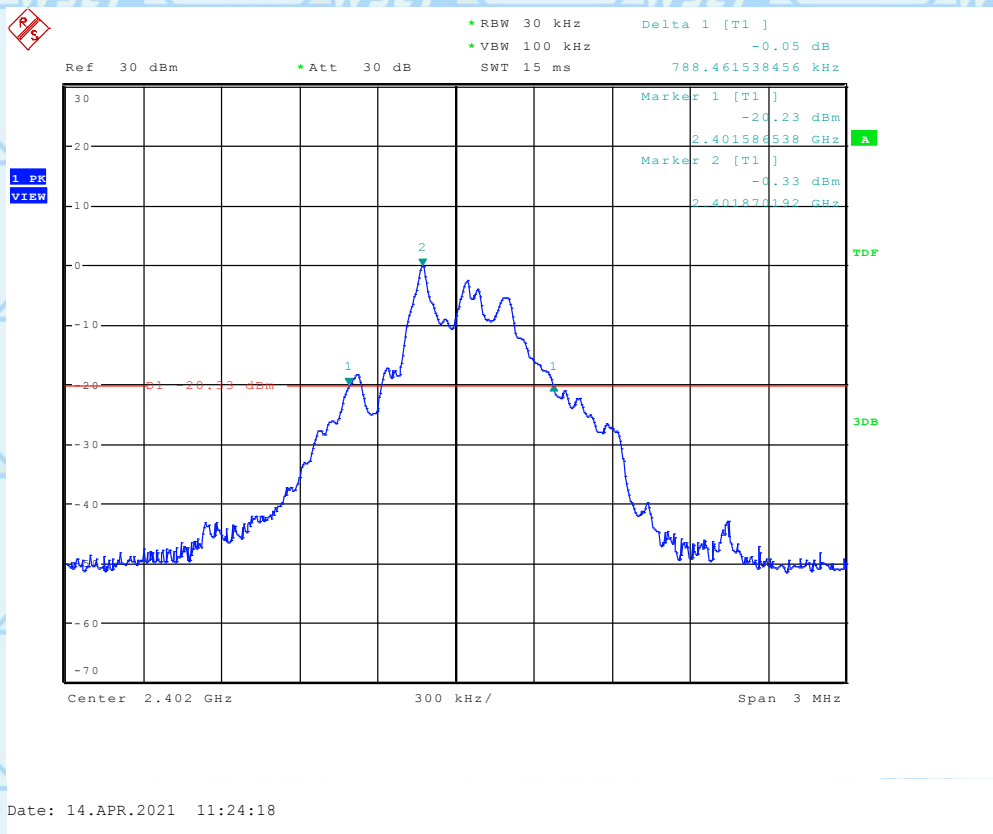



For Question, Please Contact with WSCT www.wsct-cert.com

Report No.:WSCT-A2LA-R&E210400003A-BLE

### CH39 -1Mbps







For Question, Please Contact with WSCT www.wsct-cert.com

Report No.: WSCT-A2LA-R&E210400003A-BLE

### CH78 -1Mbps

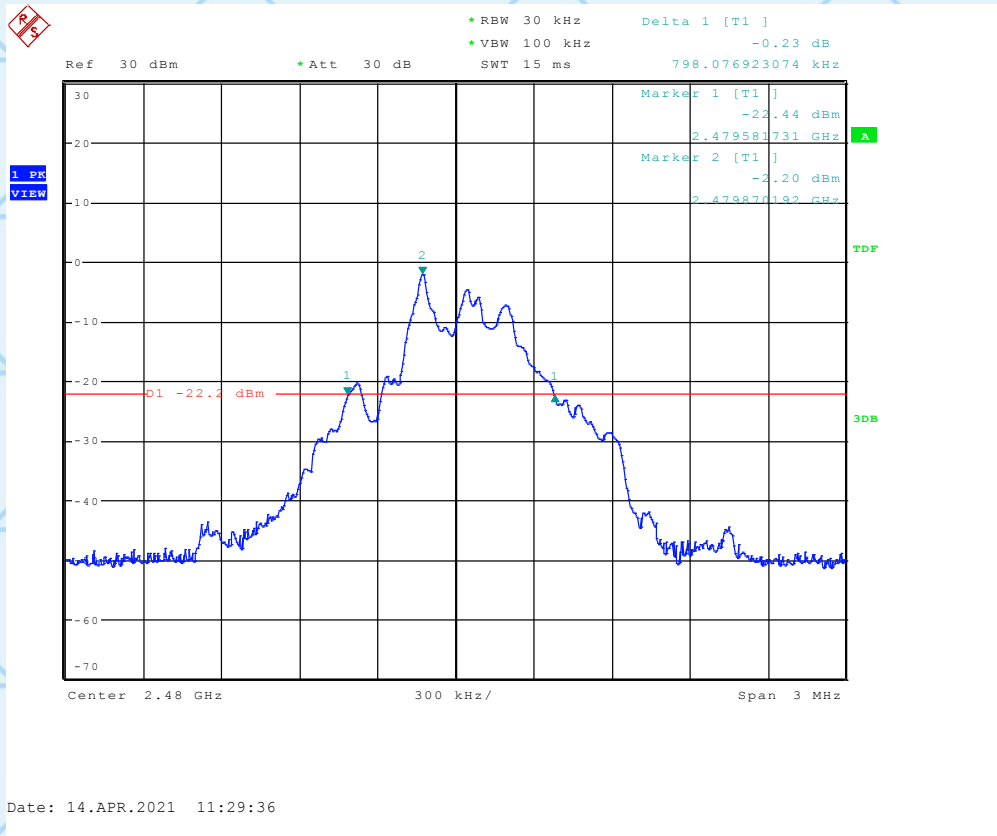



For Question,  
Please Contact with WSCT  
www.wsct-cert.com

Report No.:WSCT-A2LA-R&E210400003A-BLE

Note: **the worst case is DH5as result in this part.**

Pressure	1012 hPa	Test Mode	CH00/CH39/C78(2Mbps)
Temperature	25°C	Relative Humidity	60%

Frequency	20dB Bandwidth (kHz)	Result
2402 MHz	1163	PASS
2441 MHz	1154	PASS
2480 MHz	1154	PASS

**CH00 -2Mbps**

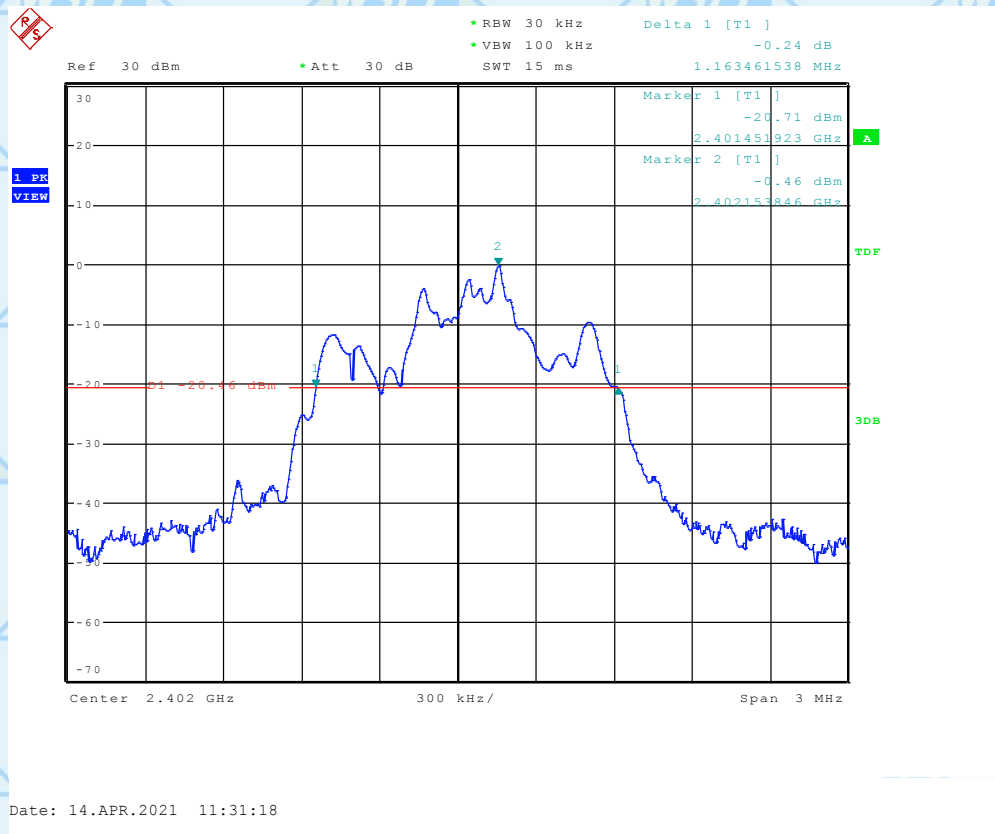

世标检测认证股份

World Standardization Certification & Testing Group (Shenzhen) Co., Ltd.

ADD: Building A-B Baoshi Science & Technology Park, Baoshi Road, Bao'an District, Shenzhen, Guangdong, China  
 TEL: 86-755-26996192 26992306    FAX: 86-755-86376605    E-mail: Fengbing.Wang@wsct-cert.com    Http: www.wsct-cert.com

Member of the WSCT INC.





For Question,  
Please Contact with WSCT  
www.wsct-cert.com

Report No.: WSCT-A2LA-R&E210400003A-BLE

### CH39 -2Mbps





For Question,  
Please Contact with WSCT  
www.wsct-cert.com

Report No.: WSCT-A2LA-R&E210400003A-BLE

### CH78 -2Mbps

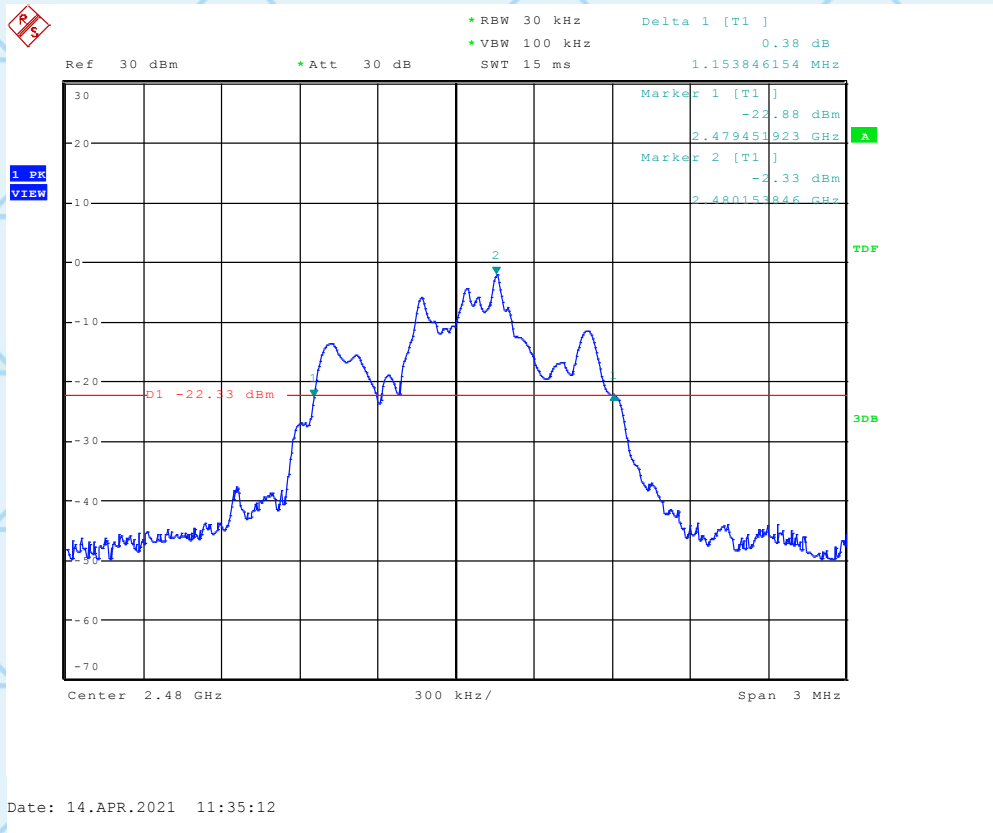

世标检测认证股份

World Standardization Certification & Testing Group (Shenzhen) Co., Ltd.

ADD: Building A-B Baoshi Science & Technology Park, Baoshi Road, Bao'an District, Shenzhen, Guangdong, China  
TEL: 86-755-26996192 26992306    FAX: 86-755-86376605    E-mail: Fengbing.Wang@wsct-cert.com    Http: www.wsct-cert.com

Member of the WSCT INC.





For Question,  
Please Contact with WSCT  
www.wsct-cert.com

Report No.: WSCT-A2LA-R&E210400003A-BLE

Note: **the worst case is DH5as result in this part.**

Pressure	1012 hPa	Test Mode	CH00/CH39/C78(3Mbps)
Temperature	25°C	Relative Humidity	60%

Frequency	20dB Bandwidth (kHz)	Result
2402 MHz	1255	PASS
2441 MHz	1250	PASS
2480 MHz	1250	PASS

**CH00 -3Mbps**

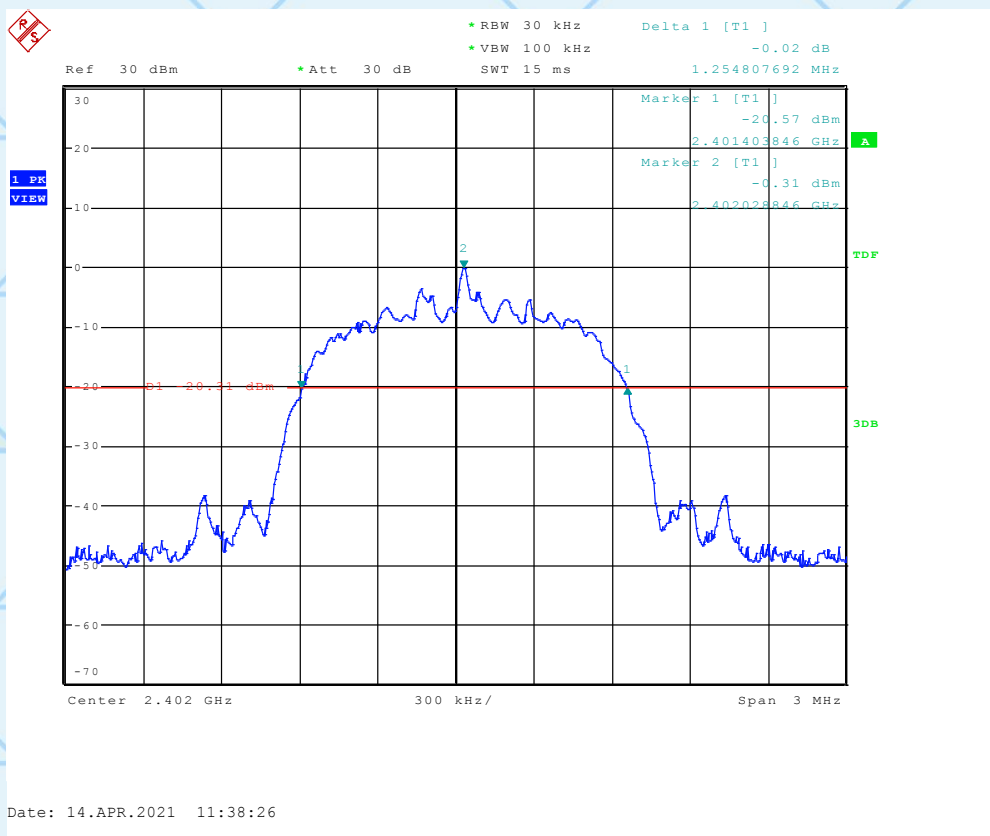



For Question, Please Contact with WSCT www.wsct-cert.com

Report No.:WSCT-A2LA-R&E210400003A-BLE

### CH39 -3Mbps

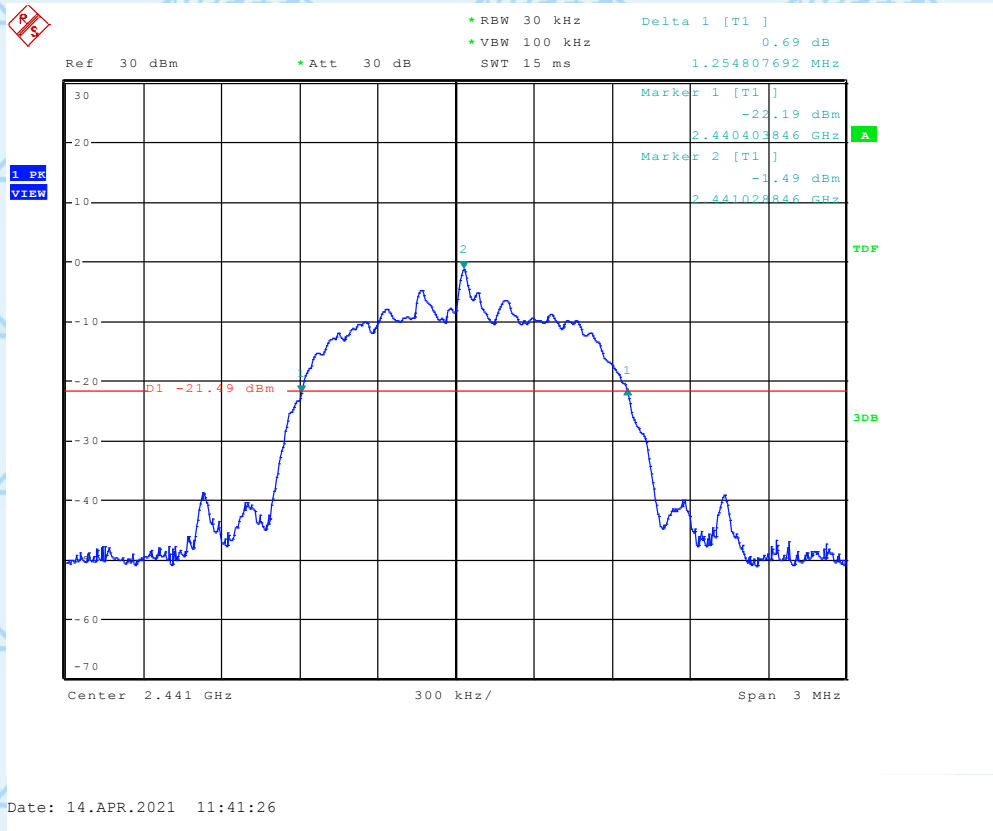





For Question, Please Contact with WSCT www.wsct-cert.com

Report No.: WSCT-A2LA-R&E210400003A-BLE

### CH78 -3Mbps

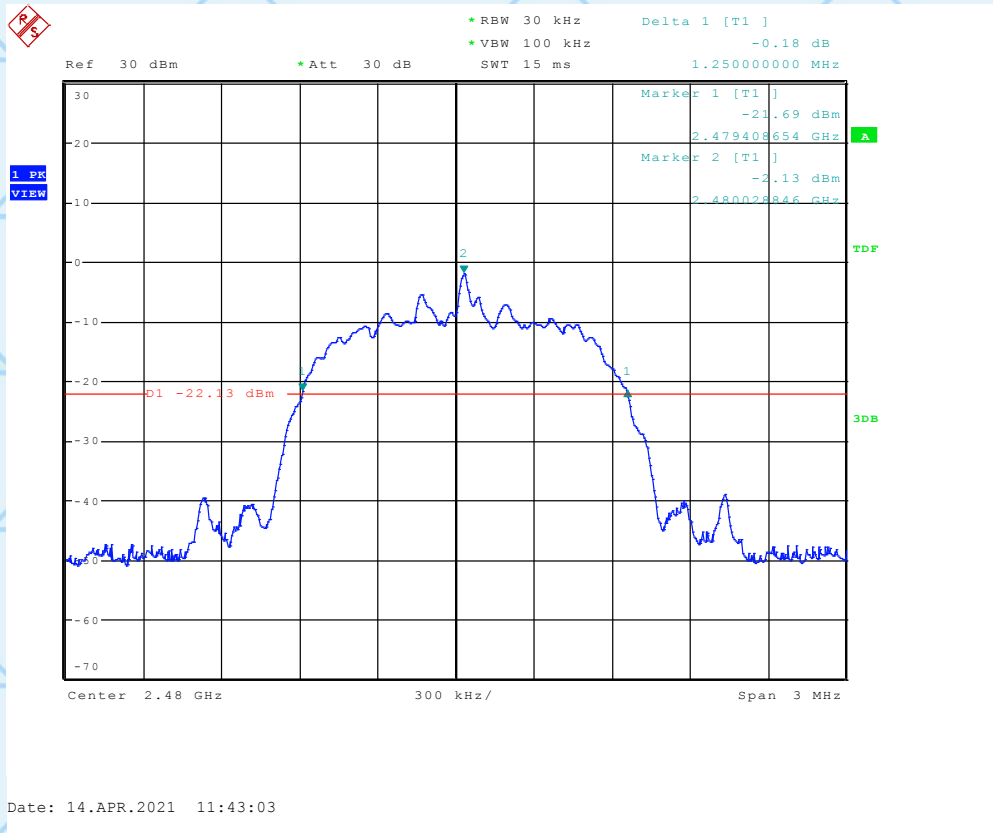



For Question,  
Please Contact with WSCT  
www.wsct-cert.com

Report No.:WSCT-A2LA-R&E210400003A-BLE

## 9. PEAK OUTPUT POWER TEST

### 9.1 APPLIED PROCEDURES / LIMIT

FCC Part15 (15.247) , Subpart C				
Section	Test Item	Limit	Frequency Range (MHz)	Result
15.247 (b)(i)	Peak Output Power	1W for 1Mbps 0.125W for 2/3Mbps	2400-2483.5	PASS

#### 9.1.2 TEST PROCEDURE

- a. The EUT was directly connected to the spectrum analyzer and antenna output port as show in the block diagram below,
- b. Setting : RBW  $\geq$  the 20 dB bandwidth of the emission being measured  
Span  $\geq$  approximately 3 times the 20 dB bandwidth, centered on a hop ping channel  
VBW  $\geq$  RBW  
Sweep = auto  
Detector function = peak  
Trace = max hold

#### 9.1.3 DEVIATION FROM STANDARD

No deviation.

#### 9.1.4 TEST SETUP



#### 9.1.5 EUT OPERATION CONDITIONS

The EUT tested system was configured as the statements of 2.4 Unless otherwise a special operating condition is specified in the follows during the testing.







For Question,  
Please Contact with WSCT  
www.wsct-cert.com

Report No.:WSCT-A2LA-R&E210400003A-BLE

## 9.2 TEST RESULTS

Pressure	1012 hPa	Test Mode	CH00/ CH39 /CH78 (1M/2M/3Mbps Mode)
Temperature	25°C	Relative Humidity	60%

Test Channel	Frequency (MHz)	Peak Output Power (dBm)	LIMIT(dBm)	Result
<b>1Mbps</b>				
CH00	2402	<b>1.09</b>	30	Pass
CH39	2441	-0.05	30	Pass
CH78	2480	-0.80	30	Pass
<b>2Mbps</b>				
CH00	2402	0.91	20.97	Pass
CH39	2441	-0.21	20.97	Pass
CH78	2480	-0.89	20.97	Pass
<b>3Mbps</b>				
CH00	2402	0.94	20.97	Pass
CH39	2441	-0.13	20.97	Pass
CH78	2480	-0.82	20.97	Pass





For Question,  
Please Contact with WSCT  
www.wsct-cert.com

Report No.: WSCT-A2LA-R&E210400003A-BLE

### 1Mbps Channel: Low

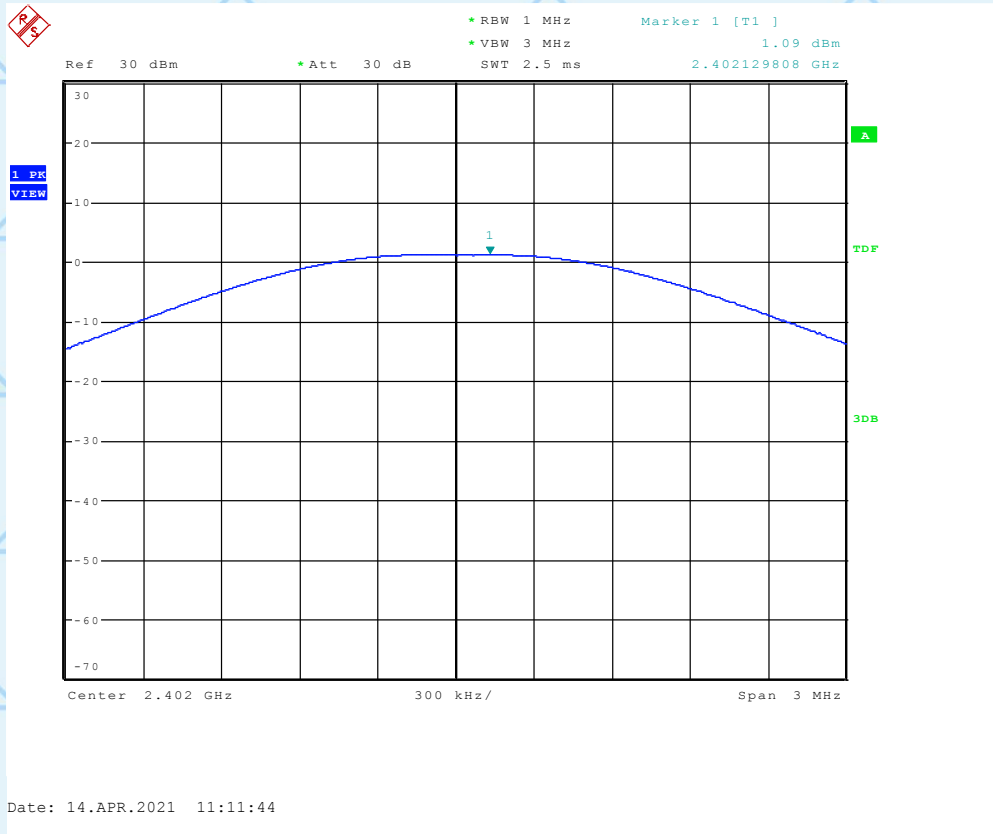

### Channel: Middle

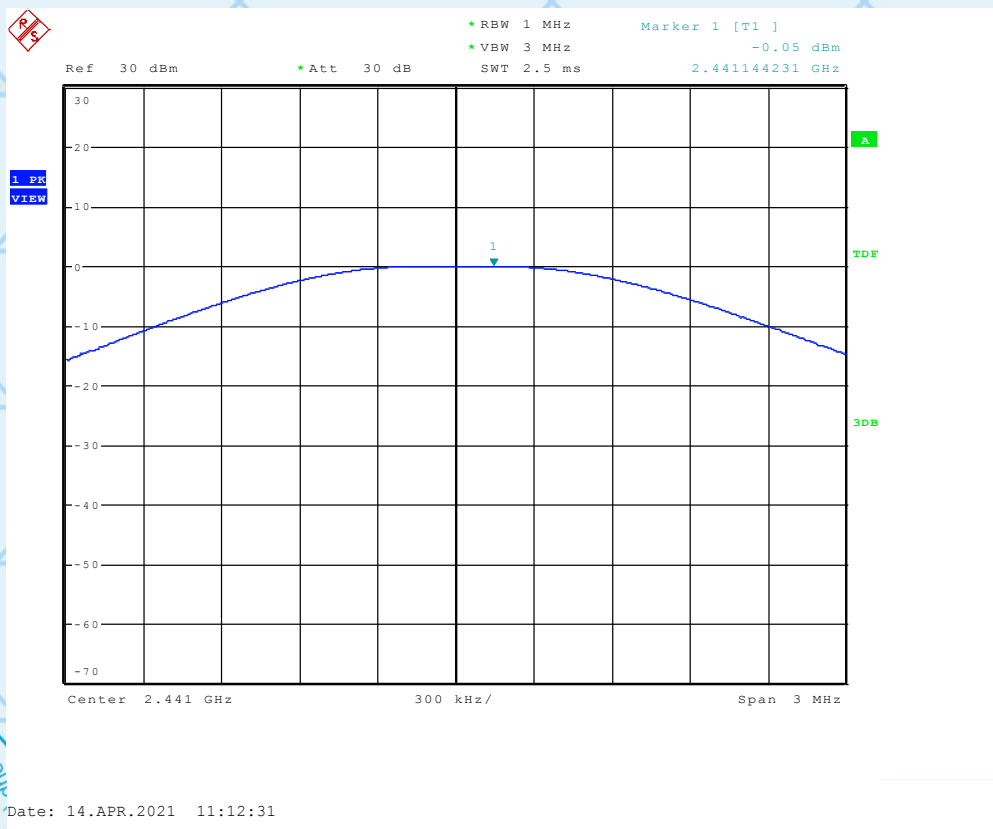





For Question,  
Please Contact with WSCT  
www.wsct-cert.com

Report No.: WSCT-A2LA-R&E210400003A-BLE

Channel: High

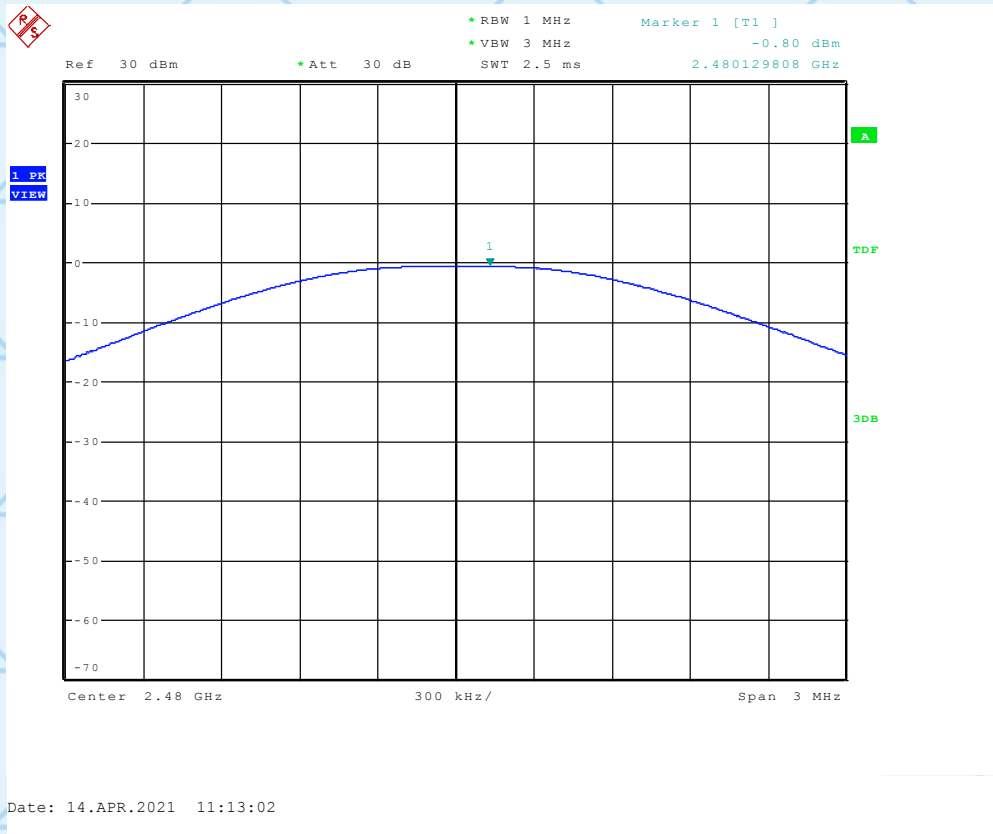

世标检测认证股份

ADD: Building A-B Baoshi Science & Technology Park, Baoshi Road, Bao'an District, Shenzhen, Guangdong, China  
TEL: 86-755-26996192 26992306 FAX: 86-755-86376605 E-mail: Fengbing.Wang@wsct-cert.com Http: www.wsct-cert.com

Member of the WSCT INC.



For Question,  
Please Contact with WSCT  
www.wsct-cert.com

Report No.: WSCT-A2LA-R&E210400003A-BLE

### 2Mbps Channel: Low

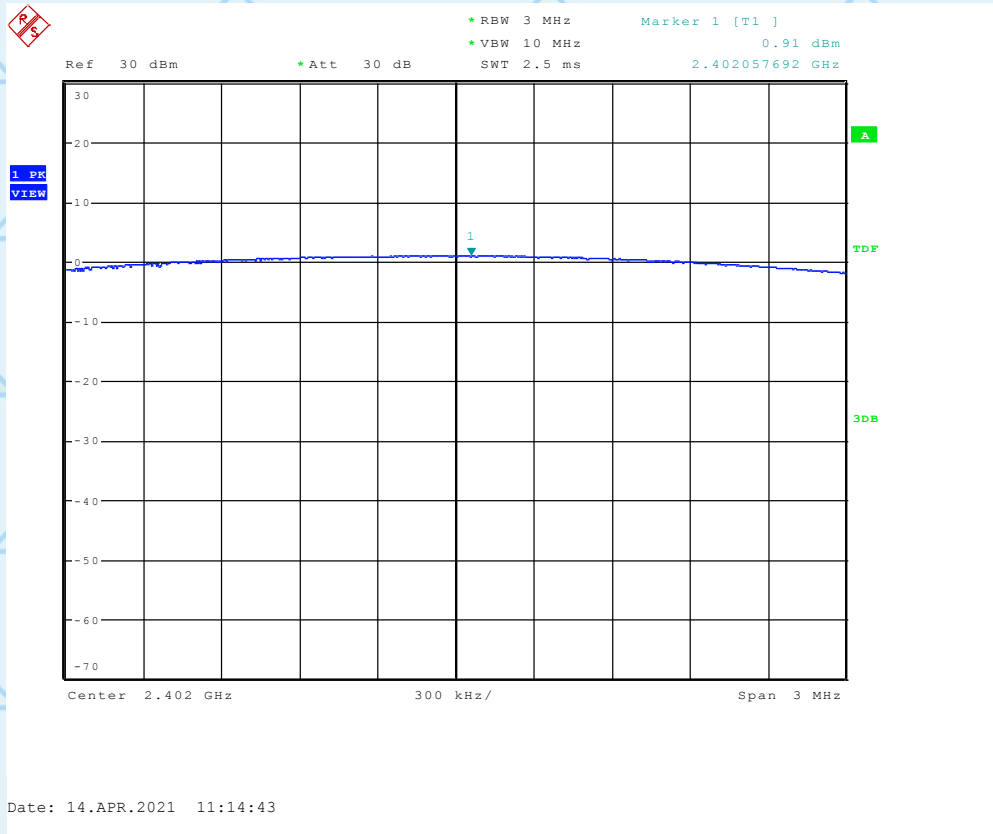

### Channel: Middle

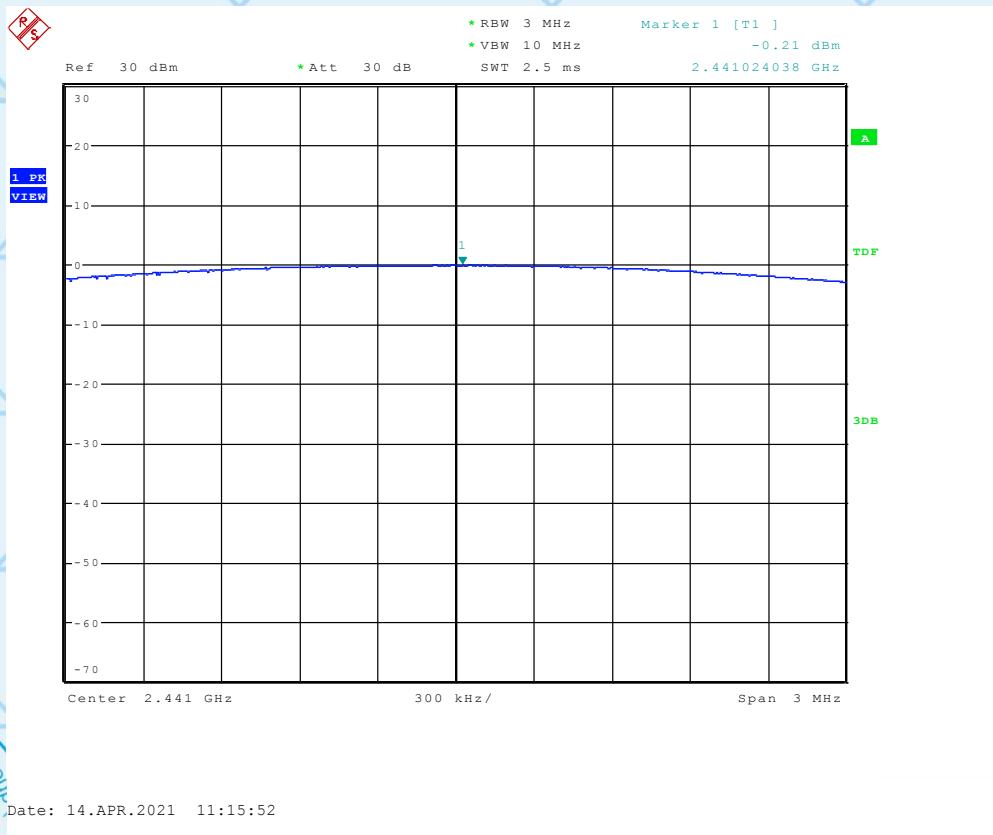





For Question,  
Please Contact with WSCT  
www.wsct-cert.com

Report No.: WSCT-A2LA-R&E210400003A-BLE

Channel: High

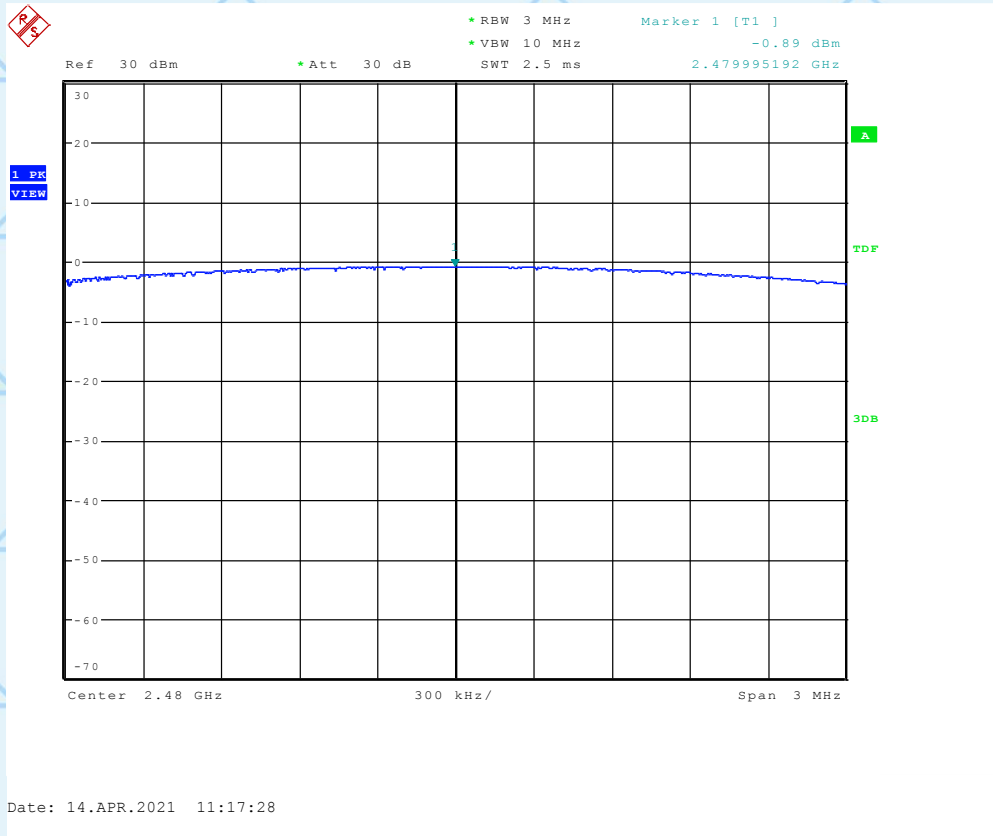

3Mbps  
Channel: Low

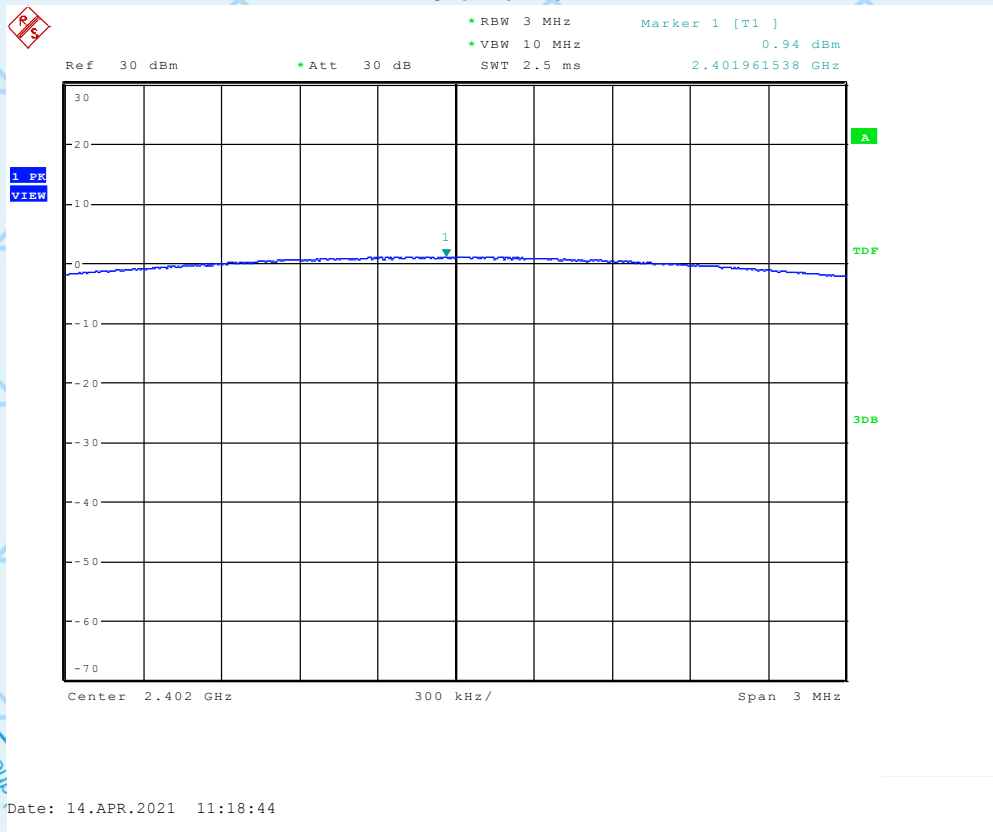



For Question,  
Please Contact with WSCT  
www.wsct-cert.com

Report No.: WSCT-A2LA-R&E210400003A-BLE

Channel: Middle

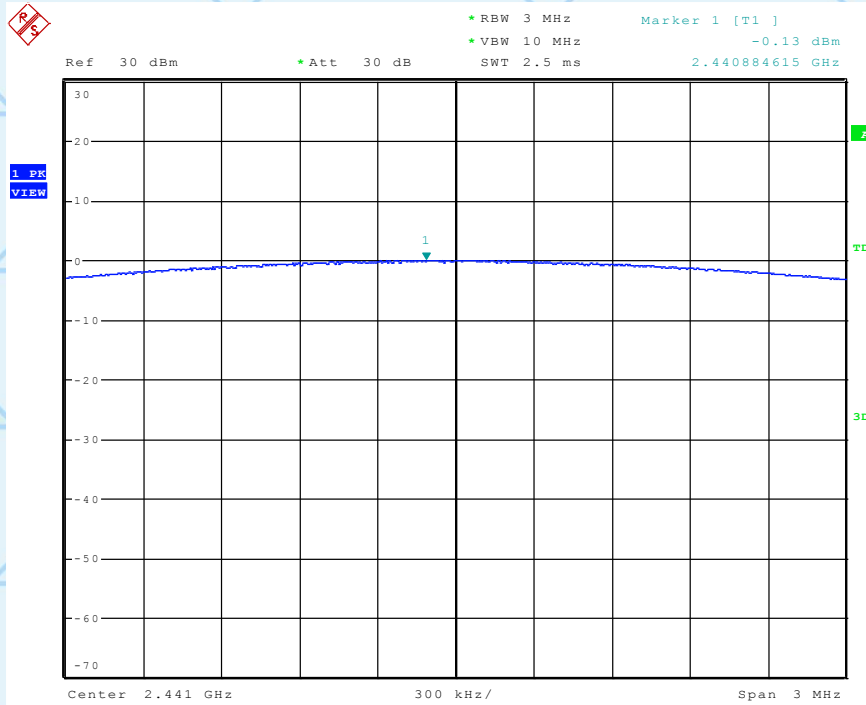

Date: 14.APR.2021 11:19:26

Channel: High

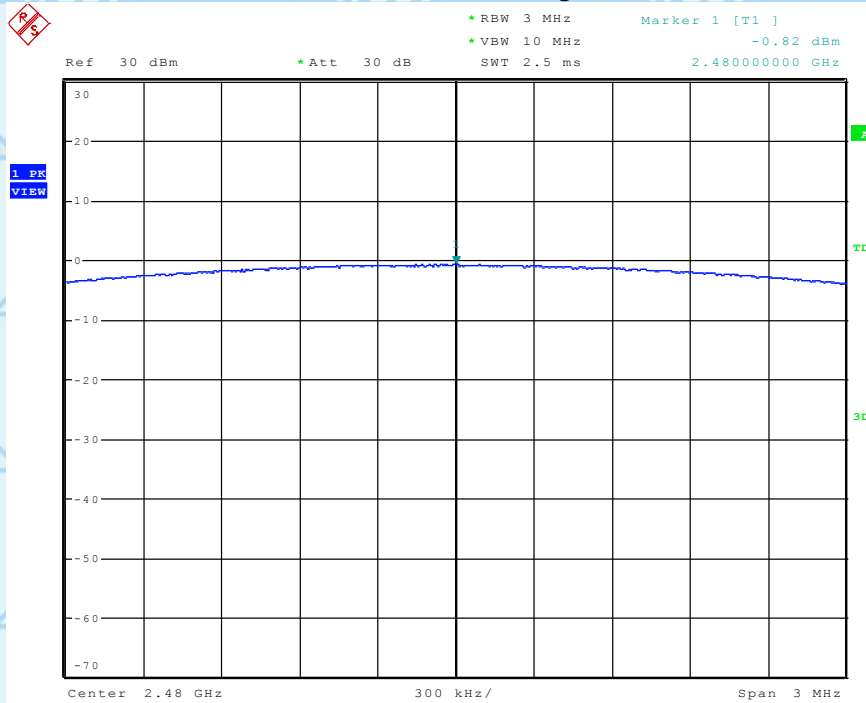

Date: 14.APR.2021 11:20:25







For Question,  
Please Contact with WSCT  
www.wsct-cert.com

Report No.: WSCT-A2LA-R&E210400003A-BLE

# 10. 100KHZ BAND EDGES MEASUREMENT

## 10.1 APPLIED PROCEDURES / LIMIT

FCC Part15 (15.247) , Subpart C				
Section	Test Item	Limit	Frequency Range (MHz)	Result
15.247(d)	Band Edges Measurement	(20dB bandwidth)	2400-2483.5	PASS

1Mbps  
Channel: Low

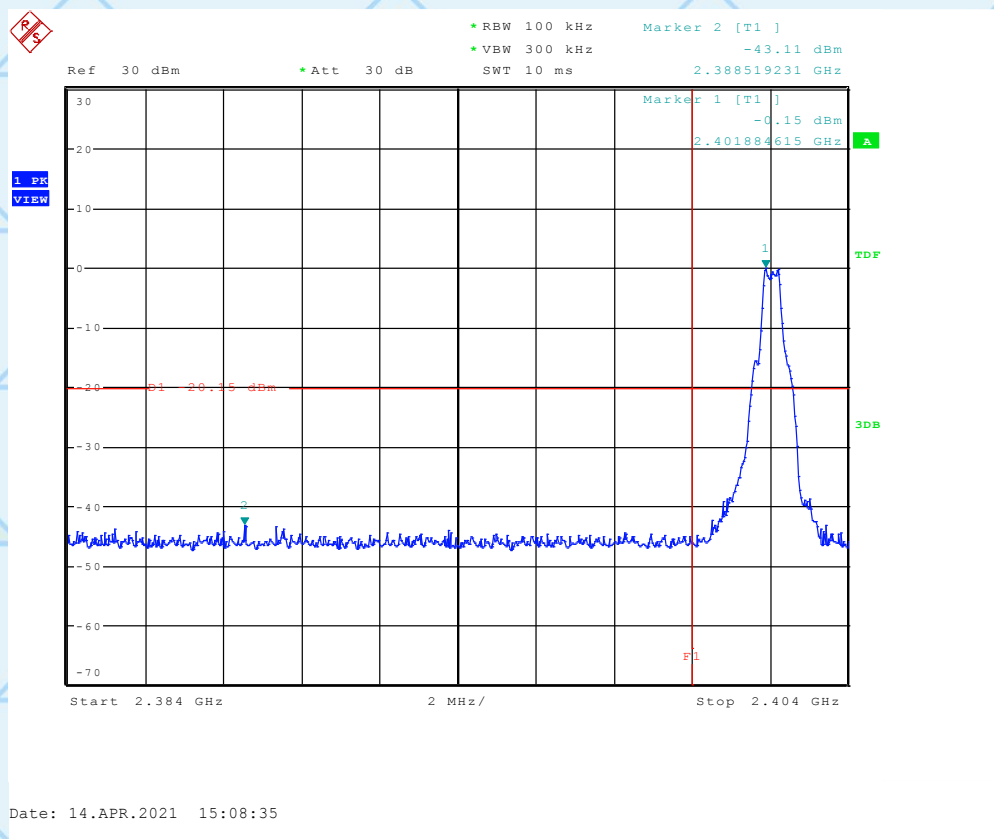

世标检测认证股份

World Standardization Certification & Testing Group (Shenzhen) Co., Ltd.

ADD: Building A-B Baoshi Science & Technology Park, Baoshi Road, Bao'an District, Shenzhen, Guangdong, China  
TEL: 86-755-26996192 26992306 FAX: 86-755-86376605 E-mail: Fengbing.Wang@wsct-cert.com Http: www.wsct-cert.com

Member of the WSCT INC.



For Question, Please Contact with WSCT www.wsct-cert.com

Report No.: WSCT-A2LA-R&E210400003A-BLE

Channel: High

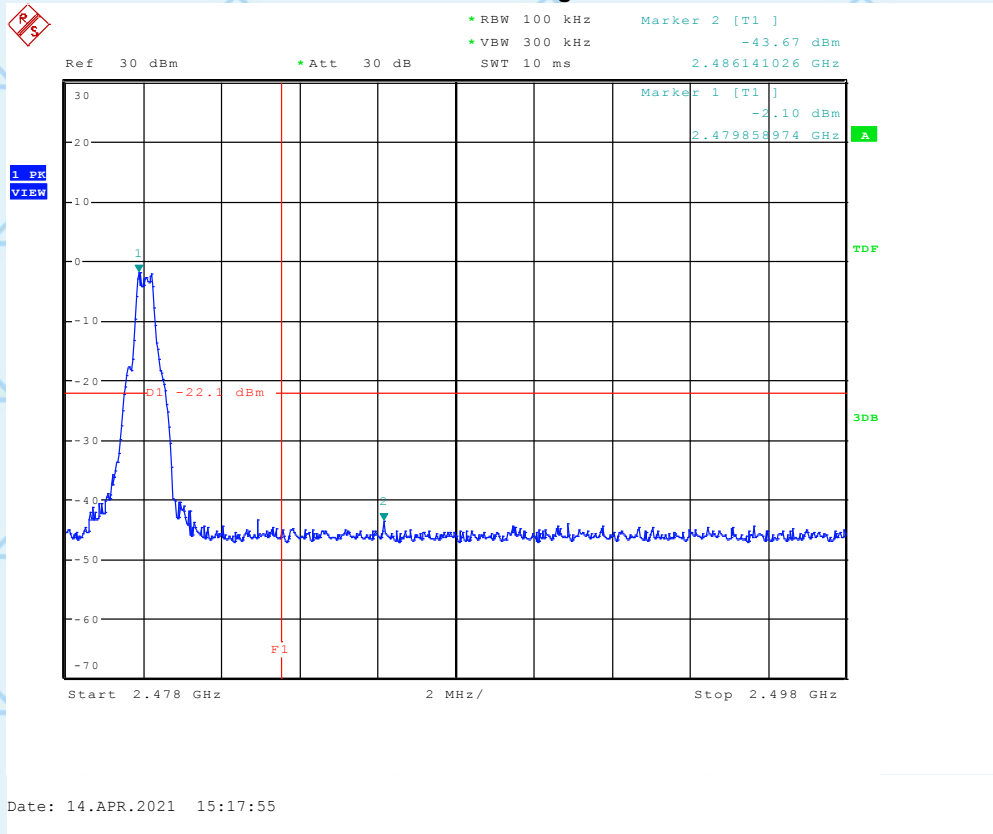

2Mbps Channel: Low

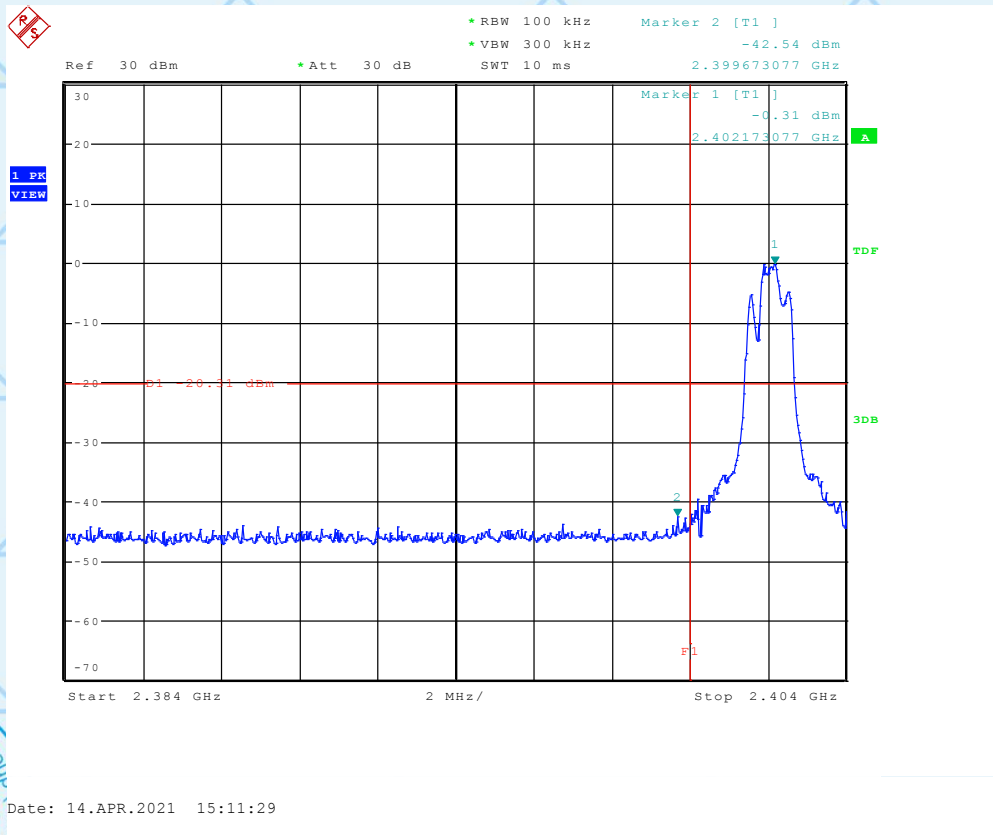





For Question,  
Please Contact with WSCT  
www.wsct-cert.com

Report No.: WSCT-A2LA-R&E210400003A-BLE

Channel: High

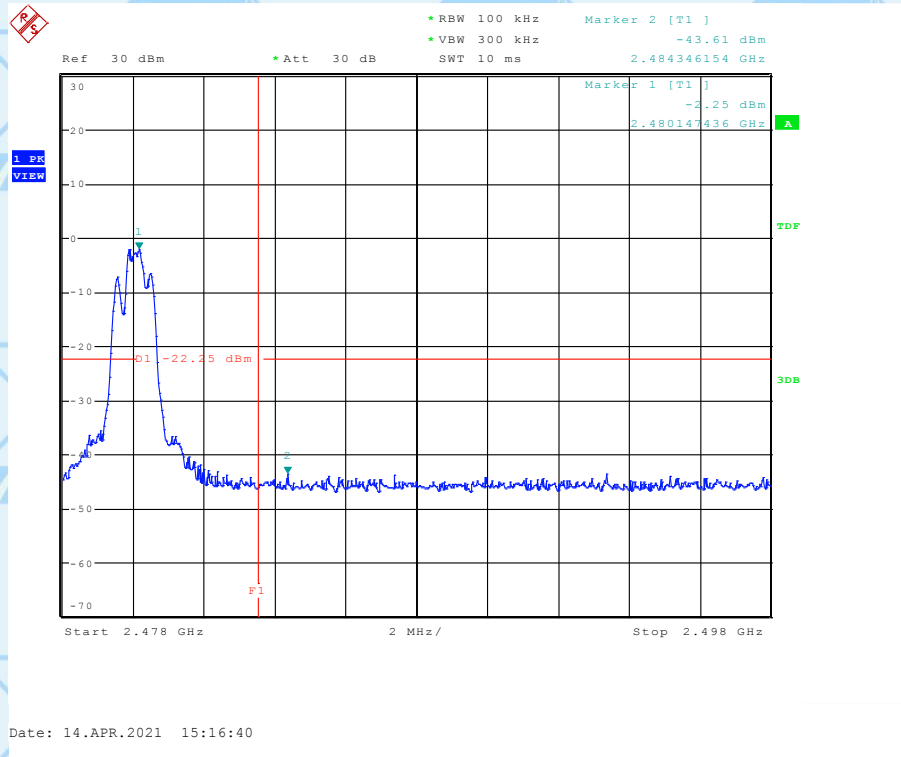

3Mbps  
Channel: Low

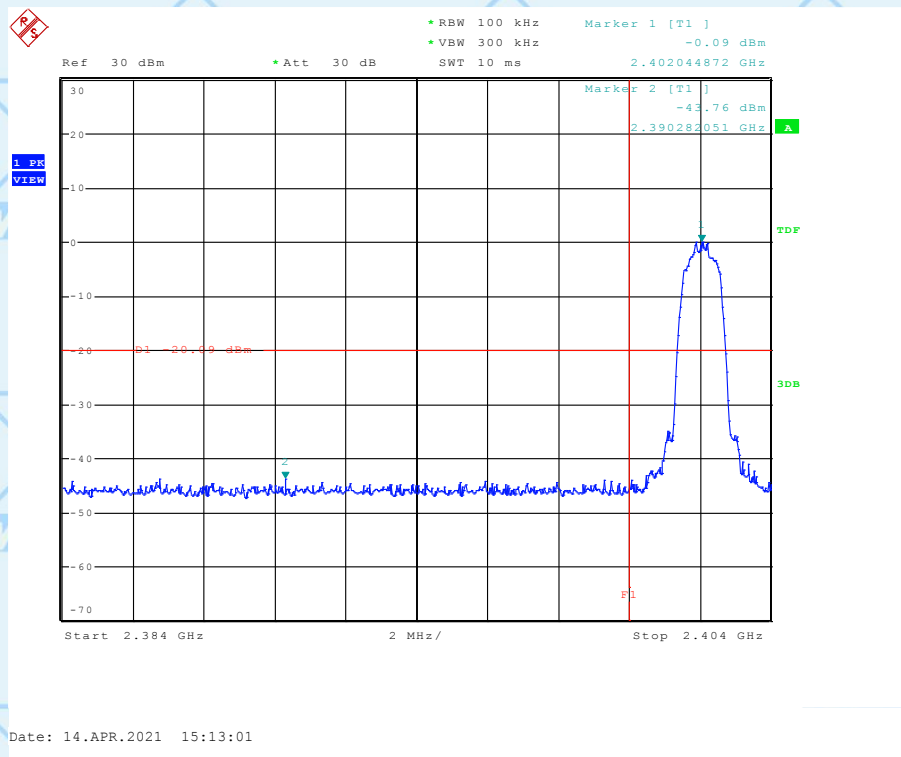



For Question,  
Please Contact with WSCT  
www.wsct-cert.com

Report No.:WSCT-A2LA-R&E210400003A-BLE

Channel: High

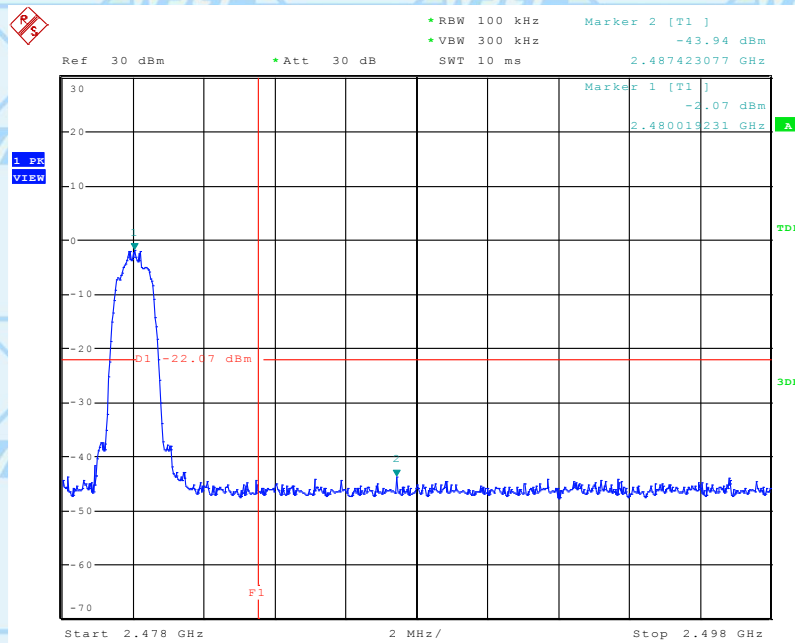

Date: 14.APR.2021 15:14:27



世标检测认证股份

World Standardization Certification & Testing Group (Shenzhen) Co., Ltd.

ADD: Building A-B Baoshi Science & Technology Park, Baoshi Road, Bao'an District, Shenzhen, Guangdong, China  
TEL: 86-755-26996192 26992306 FAX: 86-755-86376605 E-mail: Fengbing.Wang@wsct-cert.com Http: www.wsct-cert.com

Member of the WSCT INC.





For Question,  
Please Contact with WSCT  
www.wsct-cert.com

Report No.: WSCT-A2LA-R&E210400003A-BLE

# Hopping

## Channel: Low

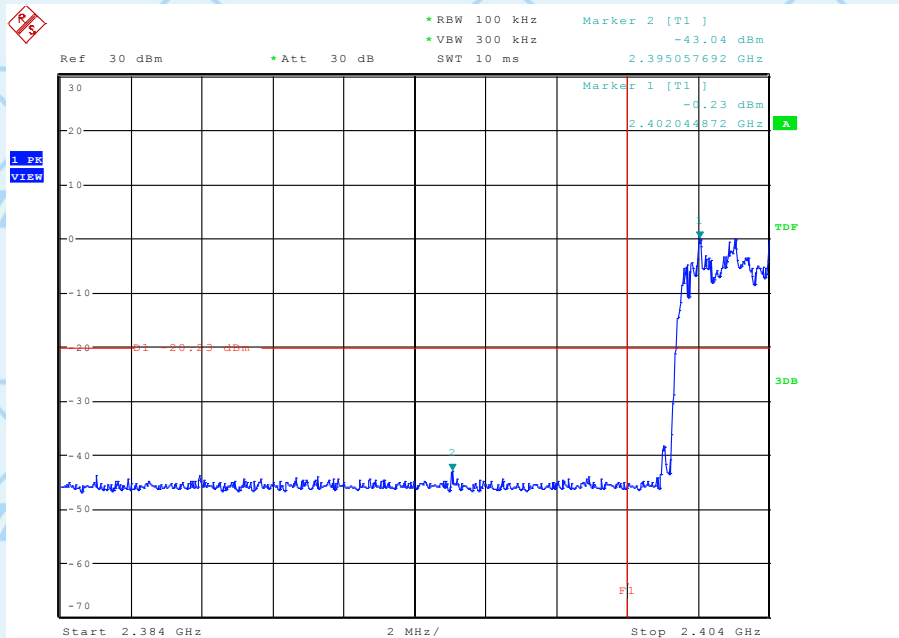

Date: 14.APR.2021 15:33:36

## Channel: High

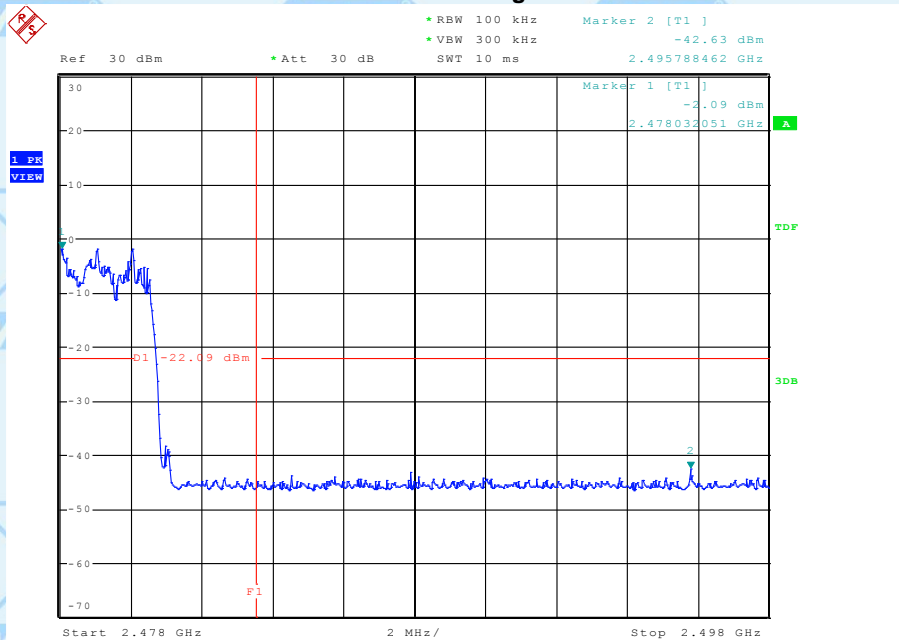

Date: 14.APR.2021 15:27:09



世标检测认证股份

World Standardization Certification & Testing Group (Shenzhen) Co., Ltd.

ADD: Building A-B Baoshi Science & Technology Park, Baoshi Road, Bao'an District, Shenzhen, Guangdong, China  
TEL: 86-755-26996192 26992306 FAX: 86-755-86376605 E-mail: Fengbing.Wang@wsct-cert.com Http: www.wsct-cert.com

Member of the WSCT INC.



For Question,  
Please Contact with WSCT  
www.wsct-cert.com

Report No.: WSCT-A2LA-R&E21040003A-BLE

1Mbps

Channel: Low

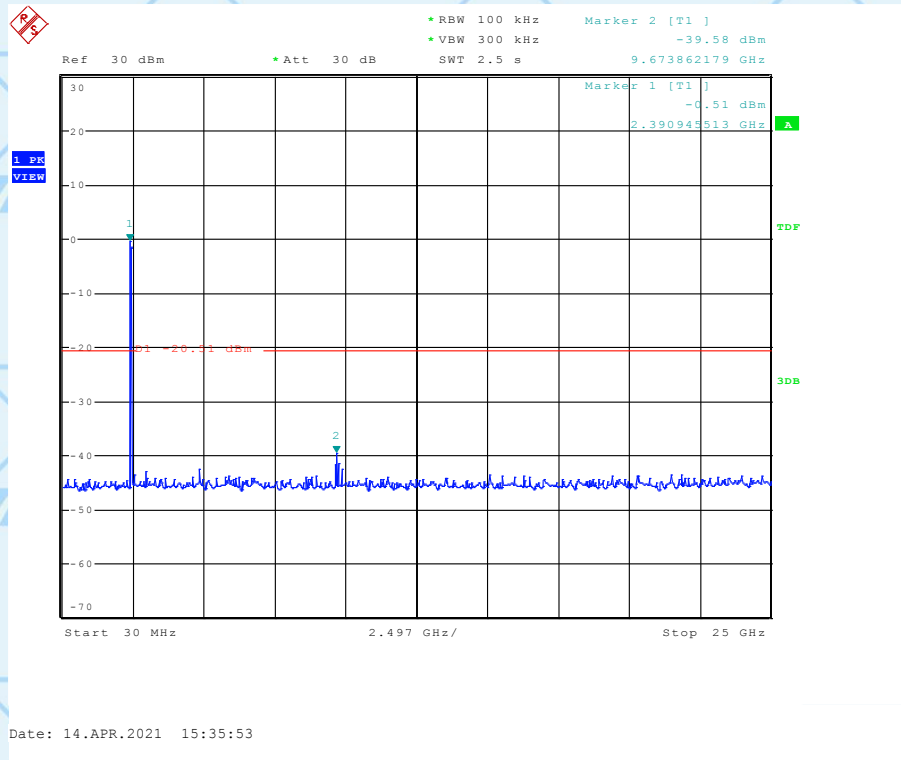

Channel: Middle

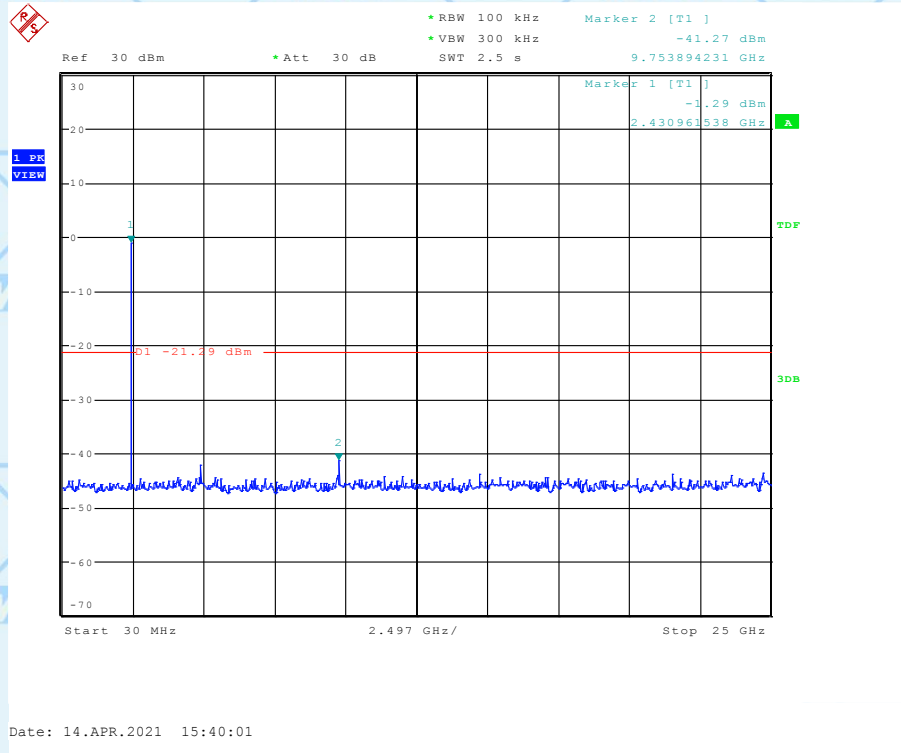





For Question,  
Please Contact with WSCT  
www.wsct-cert.com

Report No.: WSCT-A2LA-R&E210400003A-BLE

Channel: High

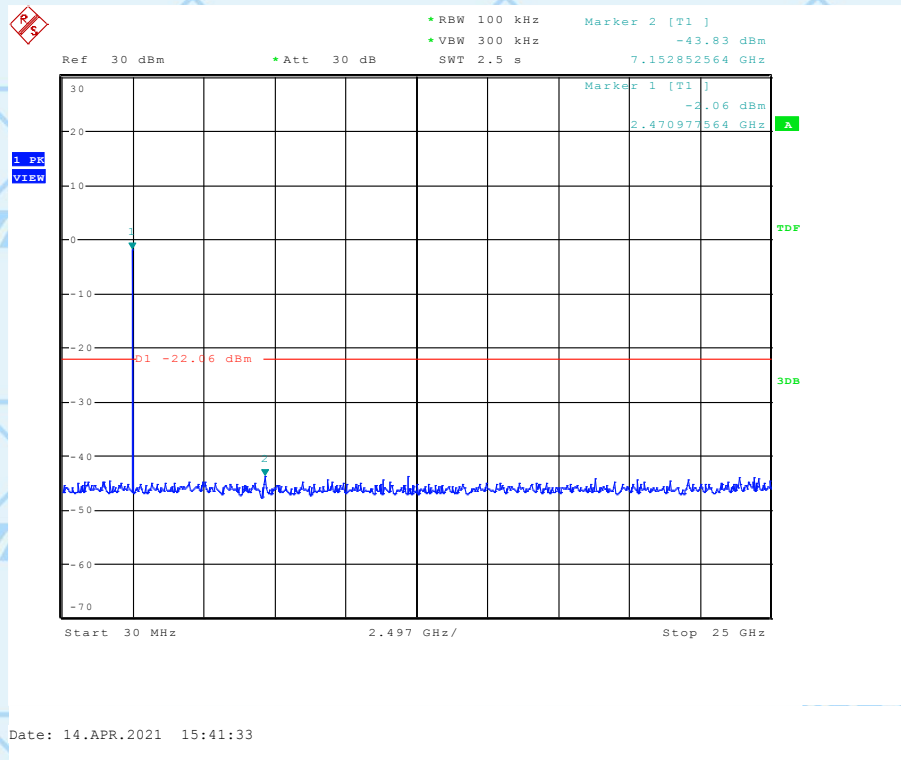

2Mbps  
Channel: Low

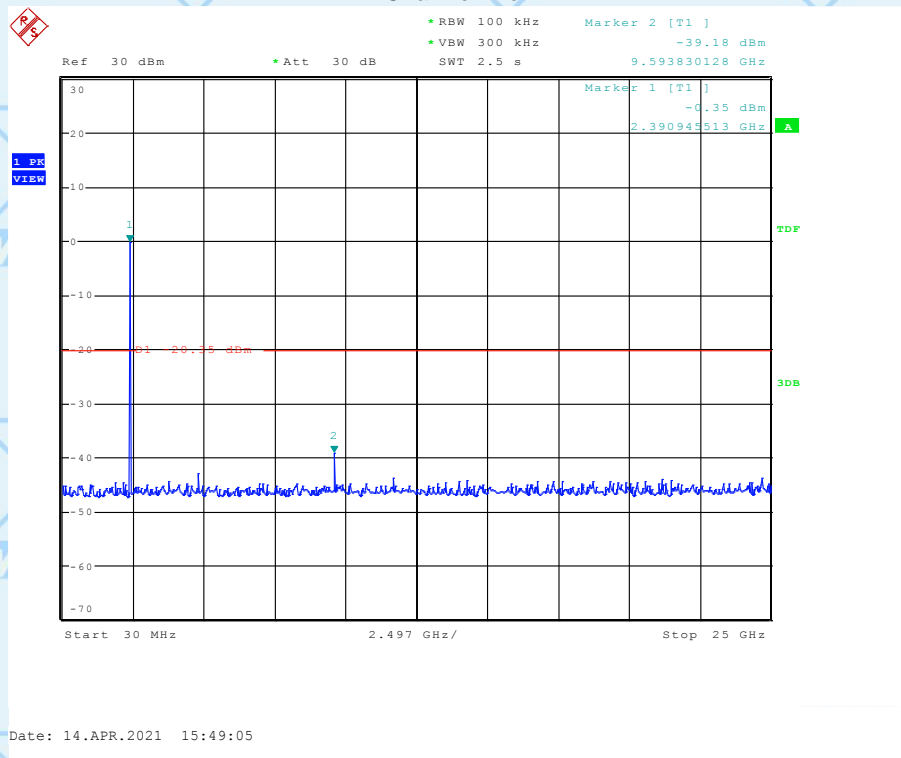



For Question,  
Please Contact with WSCT  
www.wsct-cert.com

Report No.: WSCT-A2LA-R&E210400003A-BLE

### Channel: Middle

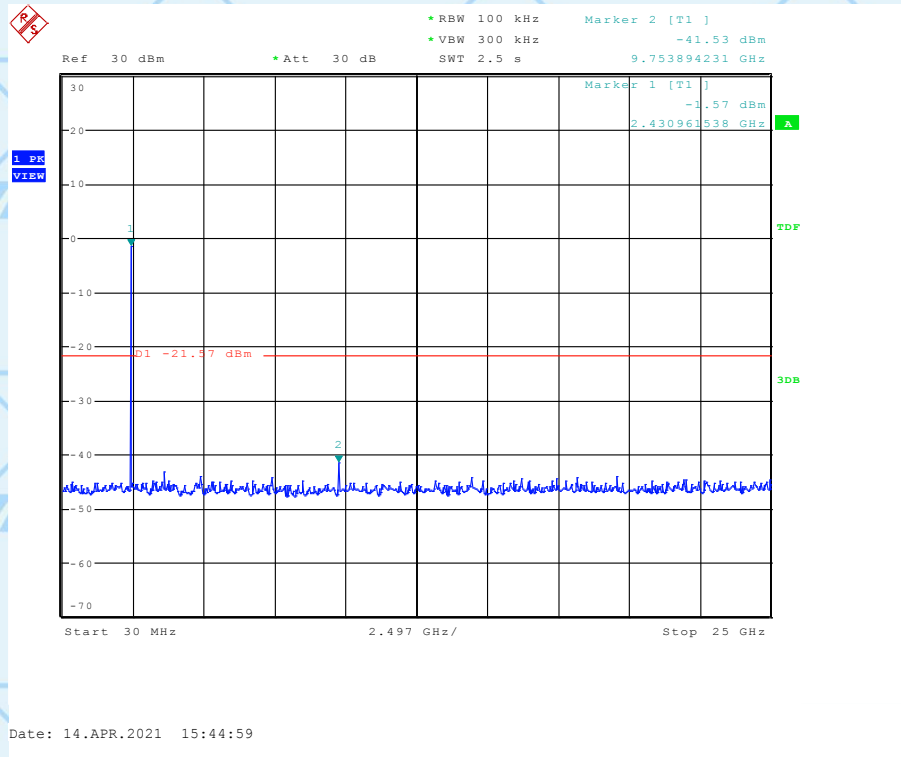

### Channel: High

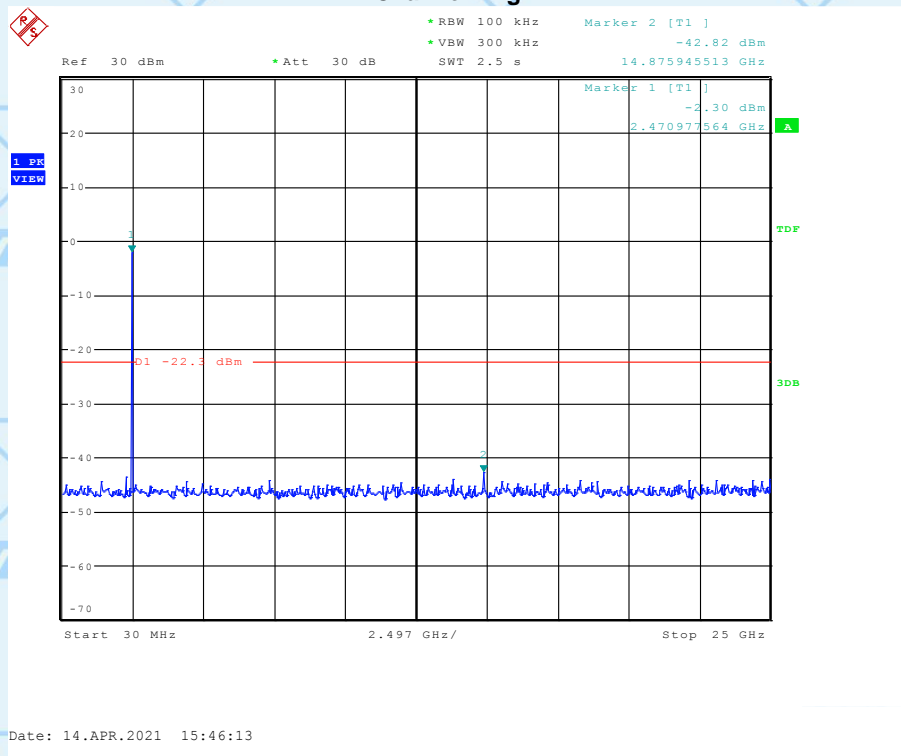





For Question,  
Please Contact with WSCT  
www.wsct-cert.com

Report No.: WSCT-A2LA-R&E21040003A-BLE

### 3Mbps Channel: Low

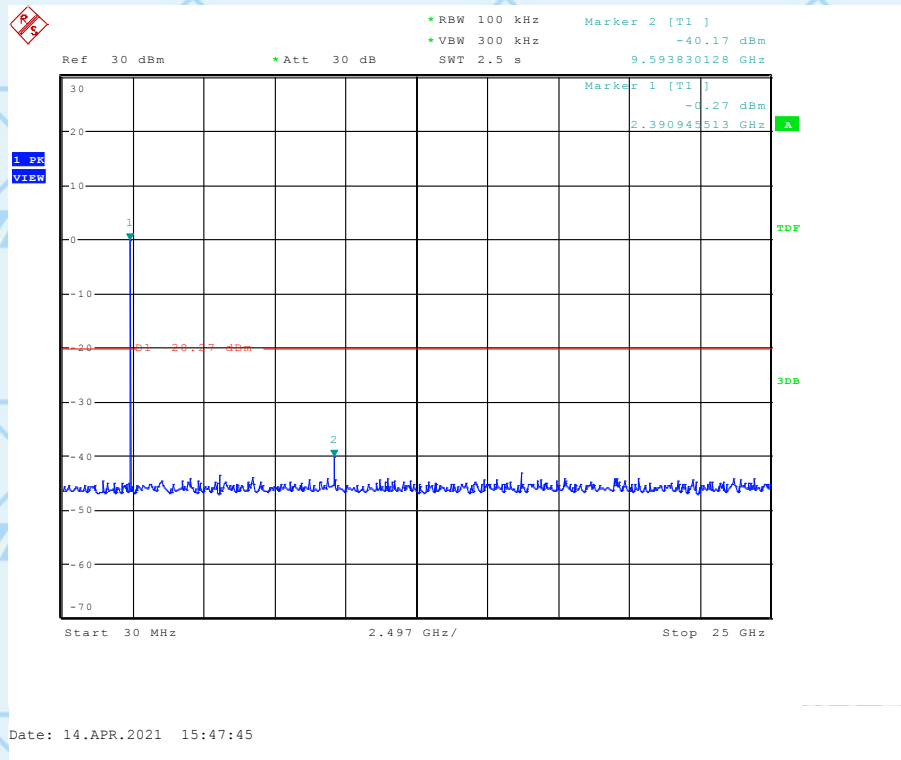

### Channel: Middle

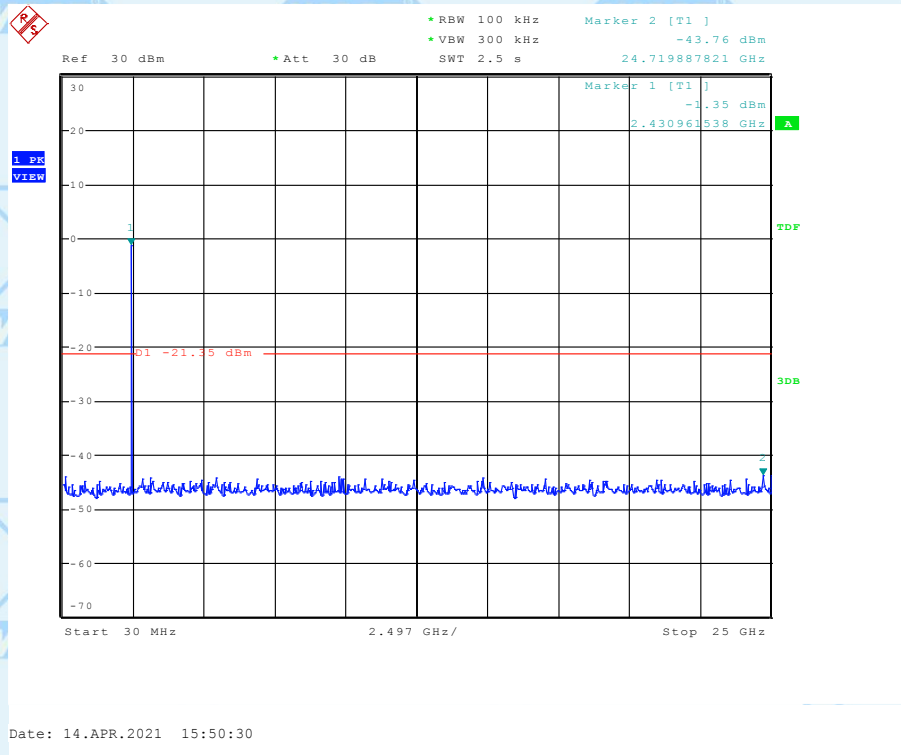



For Question,  
Please Contact with WSCT  
[www.wsct-cert.com](http://www.wsct-cert.com)

Report No.: WSCT-A2LA-R&E21040003A-BLE

Channel: High

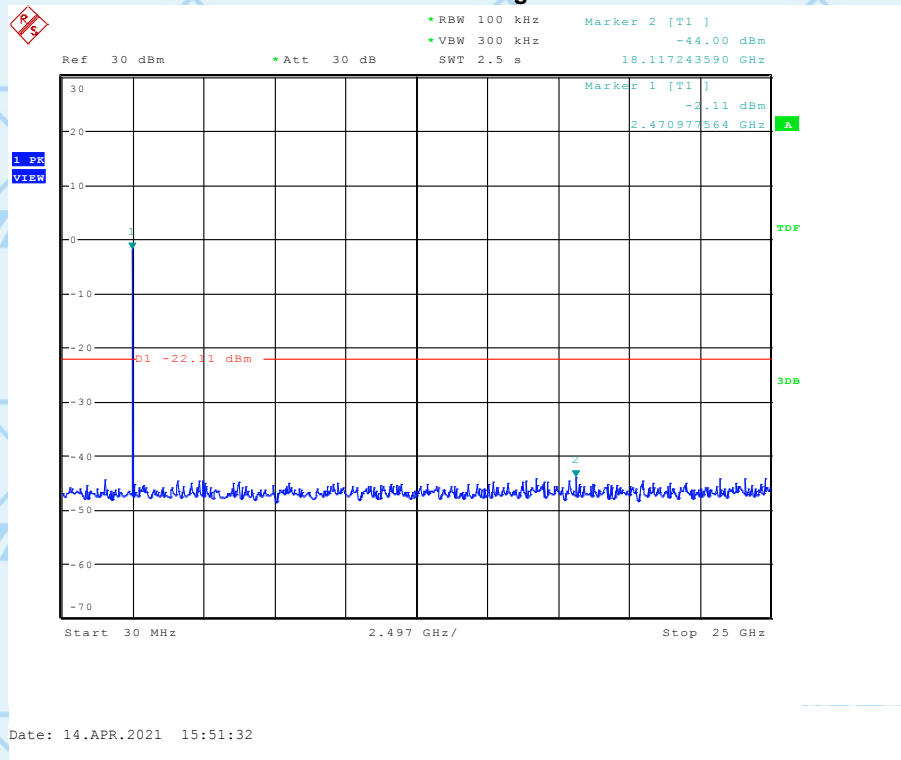

世标检测认证股份

World Standardization Certification & Testing Group (Shenzhen) Co., Ltd.

ADD: Building A-B Baoshi Science & Technology Park, Baoshi Road, Bao'an District, Shenzhen, Guangdong, China  
TEL: 86-755-26996192 26992306 FAX: 86-755-86376605 E-mail: Fengbing.Wang@wsct-cert.com Http: www.wsct-cert.com

Member of the WSCT INC.





Report No.:WSCT-A2LA-R&amp;E210400003A-BLE

## 11. ANTENNA APPLICATION

### 11.1 ANTENNA REQUIREMENT

The EUT'S antenna is met the requirement of FCC part 15C section 15.203 and 15.247

FCC part 15C section 15.247 requirements: Systems operating in the 2402-2480MHz band that are used exclusively for fixed.

#### 11.1.2 Result

The EUT's antenna Integral Antenna, The antenna's gain is 2.17dBi and meets the requirement.

Internal photograph of EUT



ANT





For Question,  
Please Contact with WSCT  
[www.wsct-cert.com](http://www.wsct-cert.com)

Report No.: WSCT-A2LA-R&E210400003A-BLE

## 12. TEST SETUP PHOTOGRAPHS

### CONDUCTED EMISSION TEST



### RADIATED EMISSION TEST (Frequency from 30MHz to 1GHz)

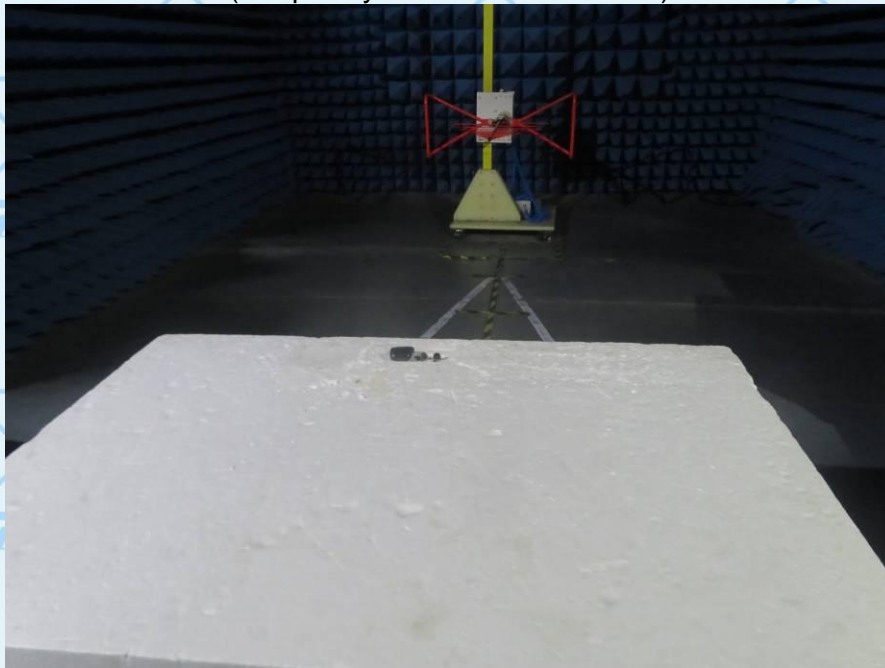





For Question,  
Please Contact with WSCT  
[www.wsct-cert.com](http://www.wsct-cert.com)

Report No.:WSCT-A2LA-R&E210400003A-BLE

**RADIATED EMISSION TEST**  
(Frequency above 1GHz)

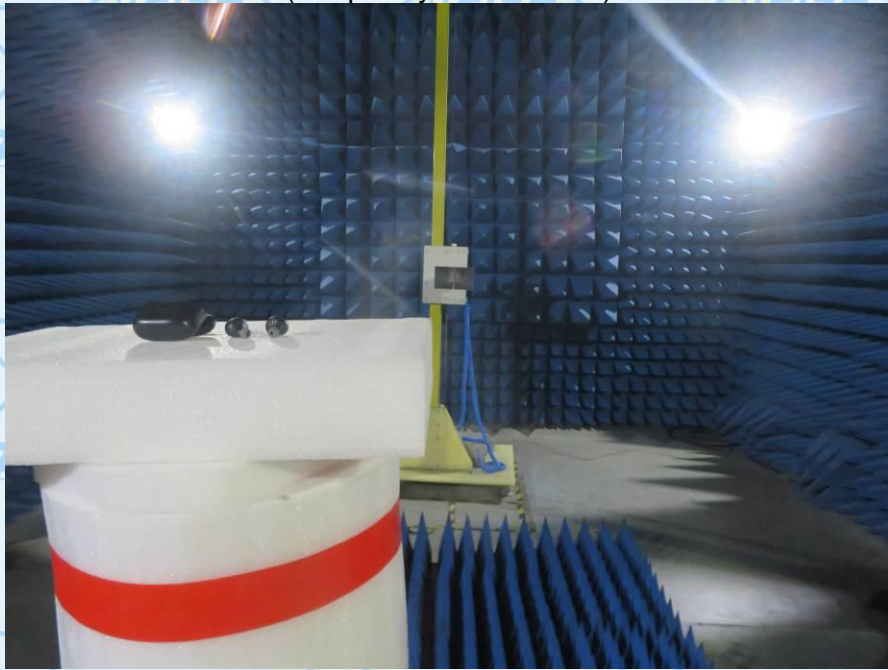

**---END OF REPORT---**

