

# 天线描述与增益

## Antenna Description and Gain

Manufacturer: DONG GUAN SHI LONG CHEN ELECTRONICS Co.,LTD.

Address: Shangbian Industrial Zone, Puxin Village, Shipai Town, Dongguan City

天线型号 (Type of antenna): 右喇叭线做天线 (Right horn line for the antenna)

天线尺寸: Size of antenna:

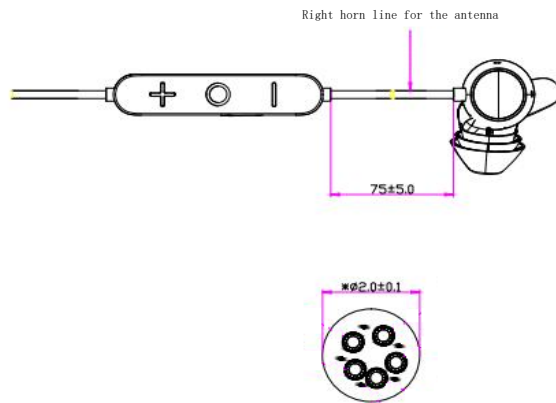

|              |                 |
|--------------|-----------------|
| <b>LGHSE</b> |                 |
| Model        | BEND1332BK39000 |
| Unit: mm     |                 |

# 天线效率 Efficiency

| 频点(Frequency)MHz | 增益 (gain) (dBi) | 效率(Efficiency)(dB) | 效率(Efficiency)% |
|------------------|-----------------|--------------------|-----------------|
| 2400             | -0.72           | -6.07              | 24.71           |
| 2410             | -0.76           | -6.02              | 25.02           |
| 2420             | -0.92           | -6.01              | 25.05           |
| 2430             | -1.23           | -6.18              | 24.09           |
| 2440             | -1.59           | -6.38              | 22.99           |
| 2450             | -1.73           | -6.37              | 23.09           |
| 2460             | -2.01           | -6.55              | 22.13           |
| 2470             | -1.93           | -6.35              | 23.17           |
| 2480             | -1.97           | -6.23              | 23.80           |
| Average value    | -1.43           | -6.24              | 23.78           |

## Return loos

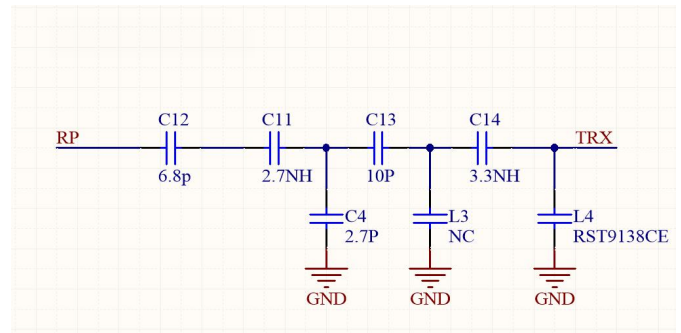
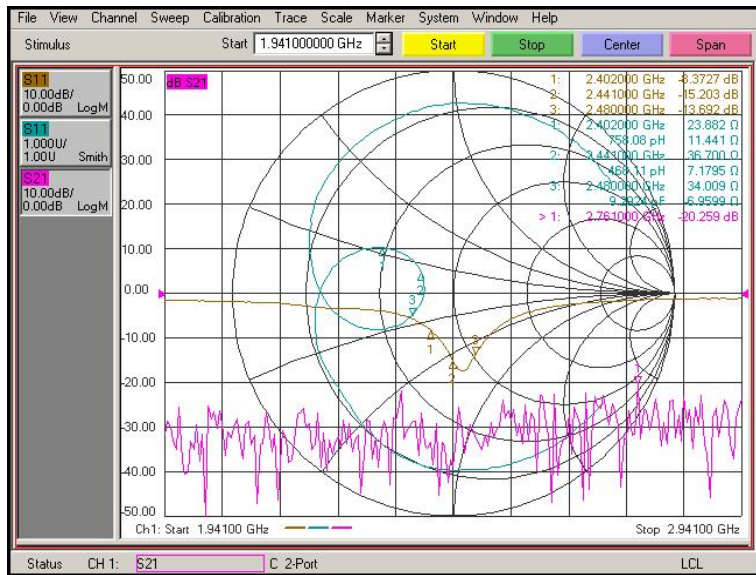

### 3D辐射图 (3D radiation chart)

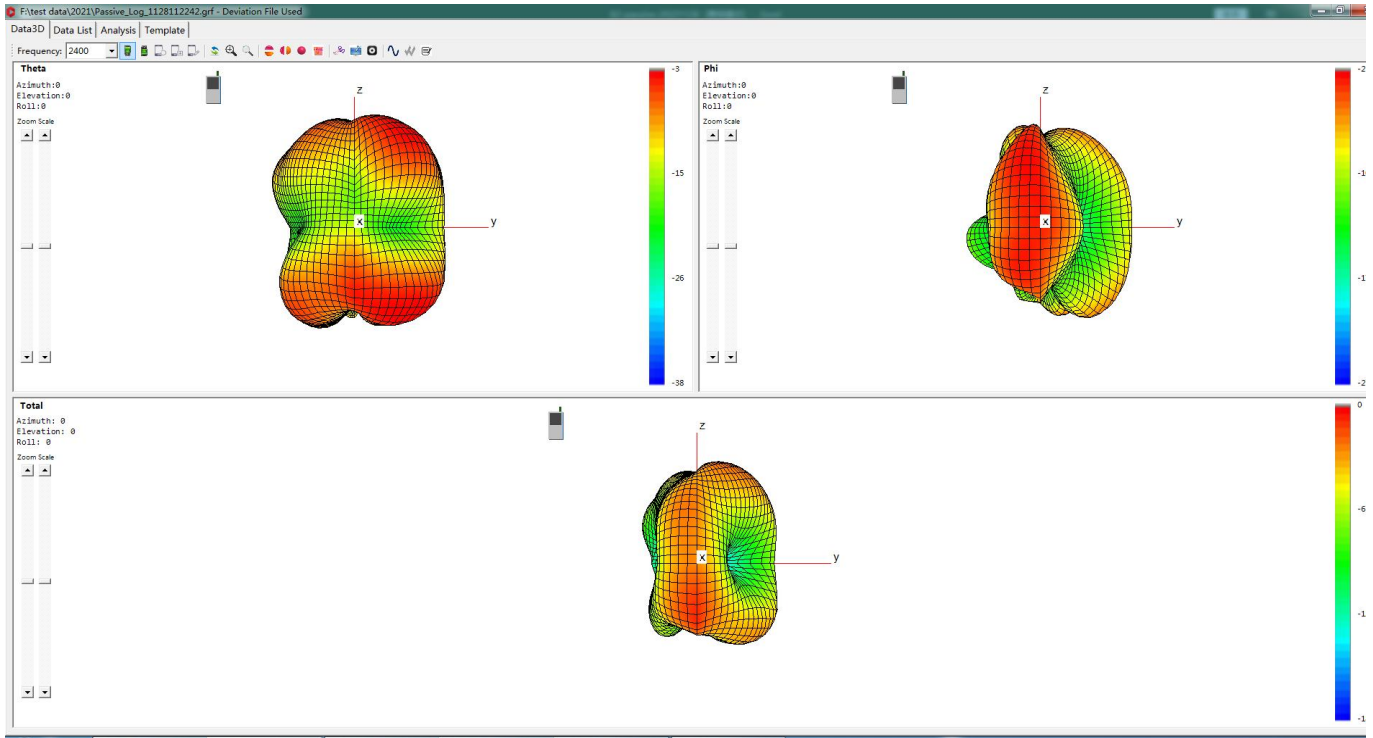

### 2D辐射图(2D radiation chart) Theta 90°

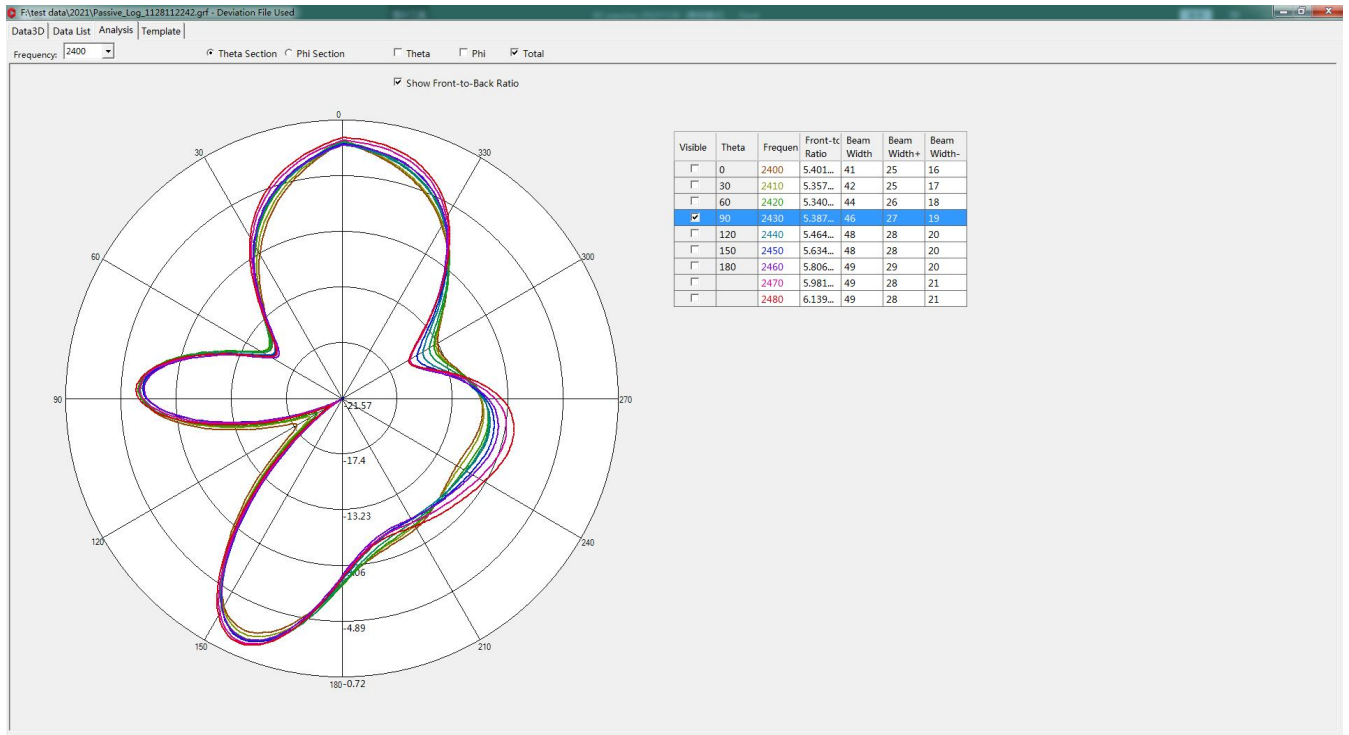

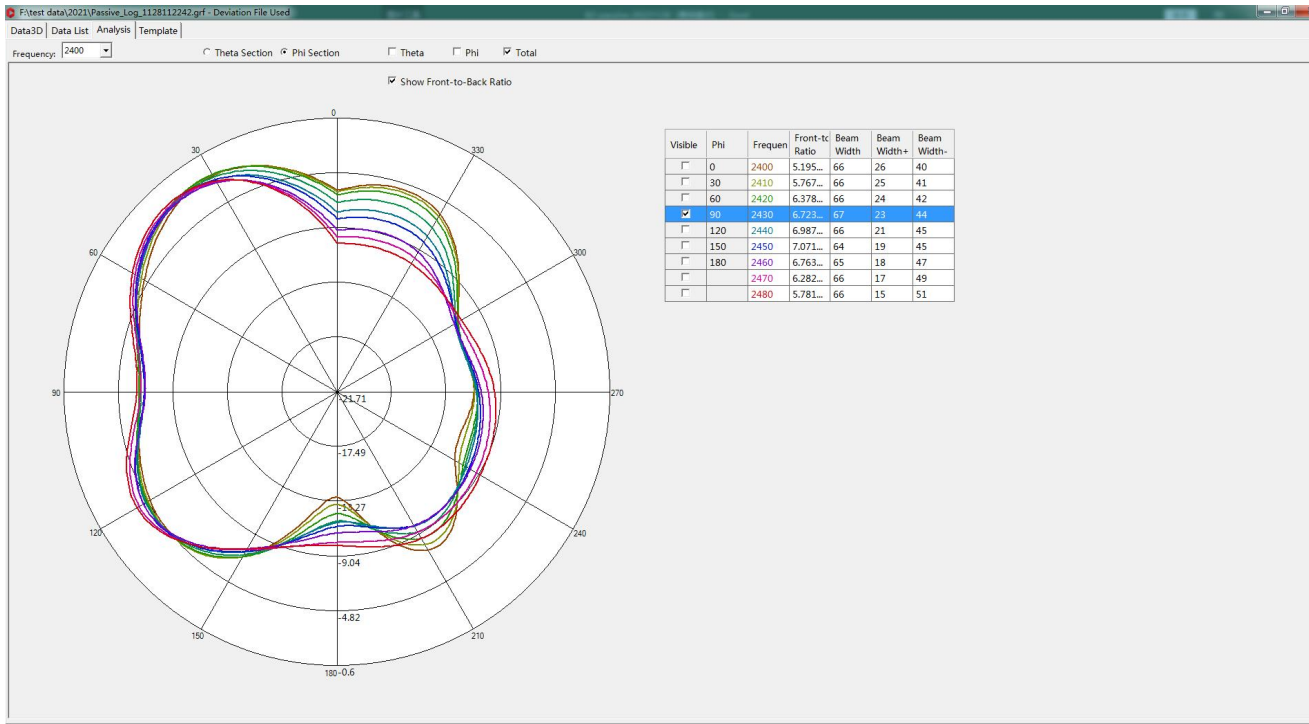

3D辐射图 (3D radiation chart)

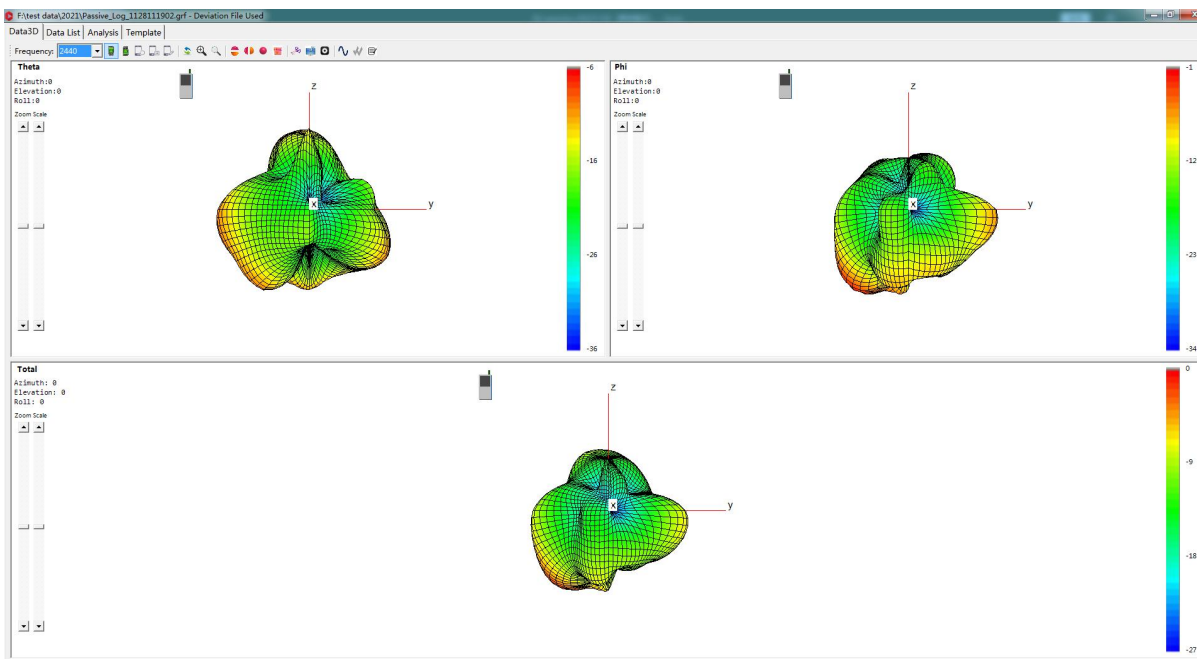

## 2D辐射图(2D radiation chart) Phi 90°

