



For Question,  
Please Contact with WSCT  
[www.wsct-cert.com](http://www.wsct-cert.com)

# TEST REPORT

FCC ID: 2ADYY-B2

Product: Mobile Phone

Model No.: B2

Additional Model No.: N/A

Trade Mark: TECNO

Report No.: FCC18110006A-Wi-Fi

Issued Date: Nov. 17, 2018

Issued for:

TECNO MOBILE LIMITED

ROOMS 05-15, 13A/F., SOUTH TOWER, WORLD FINANCE CENTRE, HARBOUR CITY, 17 CANTON ROAD, TSIM SHA TSUI, KOWLOON, HONG KONG

Issued By:

World Standardization Certification & Testing Group Co., Ltd.

Building A-B, Baoshi Science & Technology Park, Baoshi Road,  
Bao'an District, Shenzhen, Guangdong, China

TEL: +86-755-26996192

FAX: +86-755-86376605



**Note:** The results contained in this report pertain only to the tested sample. This report shall not be reproduced, except in full, without written approval of World Standardization Certification & Testing Group Co.,Ltd. This report must not be used by the client to claim product certification, approval, or endorsement by NVLAP, NIST, or any agency of the U.S. Government.





Table of Contents

<b>1. GENERAL INFORMATION</b>	<b>3</b>
1.1.GENERAL DESCRIPTION OF EUT	4
1.2. FACILITIES AND ACCREDITATIONS	5
<b>2. TEST DESCRIPTION</b>	<b>6</b>
2.1 MEASUREMENT UNCERTAINTY	6
2.2 DESCRIPTION OF TEST MODES	7
2.3 TABLE OF PARAMETERS OF TEXT SOFTWARE SETTING	8
2.4 CONFIGURATION OF SYSTEM UNDER TEST	8
2.5 DESCRIPTION OF SUPPORT UNITS (CONDUCTED MODE)	8
<b>3. SUMMARY OF TEST RESULTS</b>	<b>9</b>
<b>4. MEASUREMENT INSTRUMENTS</b>	<b>10</b>
<b>5. EMC EMISSION TEST</b>	<b>11</b>
5.1 CONDUCTED EMISSION MEASUREMENT	11
5.2 RADIATED EMISSION MEASUREMENT	15
<b>6. ANTENNA APPLICATION</b>	<b>27</b>
<b>7. 6DB BANDWIDTH MEASUREMENT</b>	<b>28</b>
7.1 TEST SETUP	28
7.2 LIMITS OF 6DB BANDWIDTH MEASUREMENT	28
7.3 TEST PROCEDURE	28
7.4 TEST RESULT	28
<b>8. MAXIMUM CONDUCTED OUTPUT POWER</b>	<b>35</b>
<b>9. POWER SPECTRAL DENSITY MEASUREMENT</b>	<b>37</b>
9.1 TEST SETUP	37
9.2 LIMITS OF POWER SPECTRAL DENSITY MEASUREMENT	37
9.3 TEST PROCEDURE	37
9.4 TEST RESULT	38
<b>10. OUT OF BAND MEASUREMENT</b>	<b>44</b>
10.1 TEST SETUP FOR BAND EDGE	44
10.2 LIMITS OF OUT OF BAND EMISSIONS MEASUREMENT	44
10.3 TEST PROCEDURE	44
10.4 TEST RESULT	44





# 1. GENERAL INFORMATION

<b>Product:</b>	Mobile Phone
<b>Model No.:</b>	B2
<b>Additional Model:</b>	N/A
<b>Applicant:</b>	TECNO MOBILE LIMITED
<b>Address:</b>	ROOMS 05-15, 13A/F., SOUTH TOWER, WORLD FINANCE CENTRE, HARBOUR CITY, 17 CANTON ROAD, TSIM SHA TSUI, KOWLOON, HONG KONG
<b>Manufacturer:</b>	SHENZHEN TECNO TECHNOLOGY CO.,LTD.
<b>Address:</b>	1/F-4/F,7/F, BUILDING 3, TAIPINGYANG INDUSTRIAL ZONE, NO.2088, SHENYAN ROAD, YANTIAN DISTRICT, SHENZHEN CITY, GUANGDONG PROVINCE, P.R.C
<b>Data of receipt</b>	Nov. 02, 2018
<b>Date of Test:</b>	Nov. 02, 2018 to Nov. 15, 2018
<b>Applicable Standards:</b>	FCC Rules Part15 Subpart C.

The above equipment has been tested by World Standardization Certification & Testing Group Co., Ltd. and found compliance with the requirements set forth in the technical standards mentioned above. The results of testing in this report apply only to the product/system, which was tested. Other similar equipment will not necessarily produce the same results due to production tolerance and measurement uncertainties.

**Tested By:** Pu Shixi  
 ( Pu Shixi)

**Date:** Nov. 19, 2018

**Check By:** Qin Shuiquan  
 ( Qin Shuiquan)

**Date:** Nov. 19, 2018

**Approved By:** Wang Fengbing  
 (Wang Fengbing)

**Date:** Nov. 19, 2018



**1.1.GENERAL DESCRIPTION OF EUT**

Equipment Type:	Mobile Phone
Test Model:	B2
Additional Model:	N/A
Trade Mark	TECNO
Applicant:	TECNO MOBILE LIMITED
Address:	ROOMS 05-15, 13A/F., SOUTH TOWER, WORLD FINANCE CENTRE, HARBOUR CITY, 17 CANTON ROAD, TSIM SHA TSUI, KOWLOON, HONG KONG
Manufacturer:	SHENZHEN TECNO TECHNOLOGY CO.,LTD.
Address:	1/F-4/F,7/F, BUILDING 3, TAIPINGYANG INDUSTRIAL ZONE, NO.2088, SHENYAN ROAD, YANTIAN DISTRICT, SHENZHEN CITY, GUANGDONG PROVINCE, P.R.C
Hardware version:	V1.1
Software version:	B2-F8017F-GO-180919V48
Extreme Temp. Tolerance:	-10°C to +55°C
Battery information:	Li-Polymer Battery : BL-30VT Voltage: 3.85V Rated Capacity: 3000mAh/11.55Wh Typical Capacity: 3050mAh/11.74Wh Limited Charge Voltage: 4.4V
Adapter Information:	Adapter: A8-501000 Input: AC 100-240V 50/60Hz 200mA Output: DC 5V---1.0A
Operating Frequency	2412-2462MHz
Channels	11
Channel Spacing	5MHz
Modulation Type	CCK for IEEE 802.11b OFDM for IEEE 802.11g/n HT-20
Antenna Type:	Integral Antenna
Antenna gain:	-1.3dBi
Deviation	None
Condition of Test Sample	Normal





## 1.2. FACILITIES AND ACCREDITATIONS

All measurement facilities used to collect the measurement data are located at **Building A-B, Baoshi Science & Technology Park, Baoshi Road, Bao'an District, Shenzhen, Guangdong, China of the World Standardization Certification & Testing Group Co., Ltd.**

The sites are constructed in conformance with the requirements of ANSI C63.4 and CISPR Publication 22. All receiving equipment conforms to CISPR Publication 16-1, "Radio Interference Measuring Apparatus and Measurement Methods."

**Registration Number: 366353**

### 1.2.1. ACCREDITATIONS

Our laboratories are accredited and approved by the following approval agencies according to ISO/IEC 17025.

- USA**                    **NVLAP** (The certificate registration number is NVLAP LAB CODE:600142-0)
- Japan**                **VCCI**    (The certificate registration number is C-4790, R-3684, G-837)
- Canada**             **INDUSTRY CANADA**  
(The certificated registration number is 7700A-1)
- China**                **CNAS** (The certificated registration number is L3732)

Copies of granted accreditation certificates are available for downloading from our web site, <http://www.wsct-cert.com>





## 2. TEST DESCRIPTION

### 2.1 MEASUREMENT UNCERTAINTY

The reported uncertainty of measurement  $y \pm U$ , where expanded uncertainty  $U$  is based on a standard uncertainty multiplied by a coverage factor of  $k=2$ , providing a level of confidence of approximately 95 %.

No.	Item	Uncertainty
1	Conducted Emission Test	$\pm 3.2\text{dB}$
2	RF power, conducted	$\pm 0.16\text{dB}$
3	Spurious emissions, conducted	$\pm 0.21\text{dB}$
4	All emissions, radiated(<1G)	$\pm 4.7\text{dB}$
5	All emissions, radiated(>1G)	$\pm 4.7\text{dB}$
6	Temperature	$\pm 0.5^\circ\text{C}$
7	Humidity	$\pm 2\%$





## 2.2 DESCRIPTION OF TEST MODES

To investigate the maximum EMI emission characteristics generates from EUT, the test system was pre-scanning tested base on the consideration of following EUT operation mode or test configuration mode which possible have effect on EMI emission level. Each of these EUT operation mode(s) or test configuration mode(s) mentioned above was evaluated respectively.

Pretest Mode	Description
Mode 1	802.11b
Mode 2	802.11g
Mode 3	802.11n20

For Conducted Emission	
Final Test Mode	Description
Mode 1	802.11b

For Radiated Emission	
Final Test Mode	Description
Mode 1	802.11b
Mode 2	802.11g
Mode 3	802.11n20

Note:

- (1) The measurements are performed at the highest, middle, lowest available channels.
- (2) The EUT use new battery.
- (3) The data rate was set in 1Mbps, 6 Mbps, 6.5 Mbps and 13.5M for radiated emission due to the highest RF output power.
- (4) Record the worst case of each test item in this report.
- (5) When we test it, the duty cycle  $\geq 98\%$





For Question,  
Please Contact with WSCT  
Certification  
www.wsct-cert.com

### 2.3 TABLE OF PARAMETERS OF TEXT SOFTWARE SETTING

During testing channel & power controlling software provided by the customer was used to control the operating channel as well as the output power level. The RF output power selection is for the setting of RF output power expected by the customer and is going to be fixed on the firmware of the final end product power parameters of FHSS

Test software Version	N/A
Test program	*##2008##*

Frequency(802.11b/g/n20)	2412 MHz	2437 MHz	2462 MHz
Frequency(802.11n40)	2422 MHz	2437 MHz	2452 MHz

### 2.4 CONFIGURATION OF SYSTEM UNDER TEST

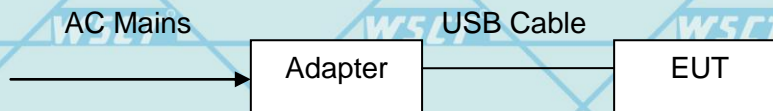

(EUT: Mobile Phone)

I/O Port of EUT			
I/O Port Type	Q'TY	Cable	Tested with
USB port	1	1m USB cable, unshielded	1
Power	1	1m	1

### 2.5 DESCRIPTION OF SUPPORT UNITS (CONDUCTED MODE)

The EUT has been tested as an independent unit together with other necessary accessories or support units. The following support units or accessories were used to form a representative test configuration during the tests.

Item	Equipment	Mfr/Brand	Model/Type No.	Series No.	Note
1	Adapter	/	BL-30VT	/	/
2	/	/	N/A	/	/

Note:

- (1) The support equipment was authorized by Declaration of Confirmation.
- (2) For detachable type I/O cable should be specified the length in cm in 『Length』 column.
- (3) “YES” is means “shielded” “with core”, “NO” is means “unshielded” “without core”.
- (4) The adapter supply by the applicant.







### 3. SUMMARY OF TEST RESULTS

Test procedures according to the technical standards:

FCC Part15 (15.247) , Subpart C			
Standard Section	Test Item	Judgment	Remark
15.207	Conducted Emission Test	PASS	Complies
15.247(a)(2) Limit	Spectrum bandwidth of a Orthogonal Frequency Division Multiplex System Limit: 6dB bandwidth>500kHz	PASS	Complies
15.247(b)	Maximum peak outputpower Limit: max. 30dBm	PASS	Complies
15.109,15.205 & 15.209	Transmitter Radiated Emission Limit: Table 15.209	PASS	Complies
15.247(e)	Power Spectral Density Limit: max. 8dBm	PASS	Complies
15.247(d)	Band edge Limit: 30dB less than Reference level Restricted band limit: Table 15.209	PASS	Complies

NOTE:

(1) "N/A" denotes test is not applicable in this test report.





## 4. MEASUREMENT INSTRUMENTS

NAME OF EQUIPMENT	MANUFACTURER	MODEL	SERIAL NUMBER	Calibration Date	Calibration Due.
EMI Test Receiver	R&S	ESCI	100005	08/19/2018	08/18/2019
LISN	AFJ	LS16	16010222119	08/19/2018	08/18/2019
LISN(EUT)	Mestec	AN3016	04/10040	08/19/2018	08/18/2019
Universal Radio Communication Tester	R&S	CMU 200	1100.0008.02	08/19/2018	08/18/2019
Coaxial cable	Megalon	LMR400	N/A	08/19/2018	08/18/2019
GPIO cable	Megalon	GPIO	N/A	08/19/2018	08/18/2019
Spectrum Analyzer	R&S	FSU	100114	08/19/2018	08/18/2019
Pre Amplifier	H.P.	HP8447E	2945A02715	10/13/2018	10/12/2019
Pre-Amplifier	CDSI	PAP-1G18-38	--	10/13/2018	10/12/2019
Bi-log Antenna	SUNOL Sciences	JB3	A021907	09/13/2018	09/12/2019
9*6*6 Anechoic	--	--	--	08/21/2018	08/20/2019
Horn Antenna	COMPLIANCE ENGINEERING	CE18000	--	09/13/2018	09/12/2019
Horn Antenna	SCHWARZBECK	BBHA9120D	9120D-631	08/23/2018	08/22/2019
Cable	TIME MICROWAVE	LMR-400	N-TYPE04	04/25/2018	04/24/2019
System-Controller	CCS	N/A	N/A	N.C.R	N.C.R
Turn Table	CCS	N/A	N/A	N.C.R	N.C.R
Antenna Tower	CCS	N/A	N/A	N.C.R	N.C.R
RF cable	Murata	MXHQ87WA3000	-	08/21/2018	08/20/2019
Loop Antenna	EMCO	6502	00042960	08/22/2018	08/21/2019
Horn Antenna	SCHWARZBECK	BBHA 9170	1123	08/19/2018	08/18/2019
Power meter	Anritsu	ML2487A	6K00003613	08/23/2018	08/22/2019
Power sensor	Anritsu	MX248XD	--	08/19/2018	08/18/2019





## 5. EMC EMISSION TEST

### 5.1 CONDUCTED EMISSION MEASUREMENT

#### 5.1.1 POWER LINE CONDUCTED EMISSION Limits (Frequency Range 150KHz-30MHz)

Frequency of emission (MHz)	Conducted limit (dB $\mu$ V)	
	Quasi-peak	Average
0.15-0.5	66 to 56*	56 to 46*
0.5-5	56	46
5-30	60	50

Note:

- (1) The tighter limit applies at the band edges.
- (2) The limit of " \* " marked band means the limitation decreases linearly with the logarithm of the frequency in the range.

The following table is the setting of the receiver

Receiver Parameters	Setting
Attenuation	10 dB
Start Frequency	0.15 MHz
Stop Frequency	30 MHz
IF Bandwidth	9 kHz





**5.1.2 TEST PROCEDURE**

- The EUT was placed 0.4 meters from the horizontal ground plane with EUT being connected to the power mains through a line impedance stabilization network (LISN). All other support equipments powered from additional LISN(s). The LISN provide 50 Ohm/ 50uH of coupling impedance for the measuring instrument.
- Interconnecting cables that hang closer than 40 cm to the ground plane shall be folded back and forth in the center forming a bundle 30 to 40 cm long.
- I/O cables that are not connected to a peripheral shall be bundled in the center. The end of the cable may be terminated, if required, using the correct terminating impedance. The overall length shall not exceed 1 m.
- LISN at least 80 cm from nearest part of EUT chassis.
- For the actual test configuration, please refer to the related Item –EUT Test Photos.

**5.1.3 DEVIATION FROM TEST STANDARD**

No deviation

**5.1.4 TEST SETUP**

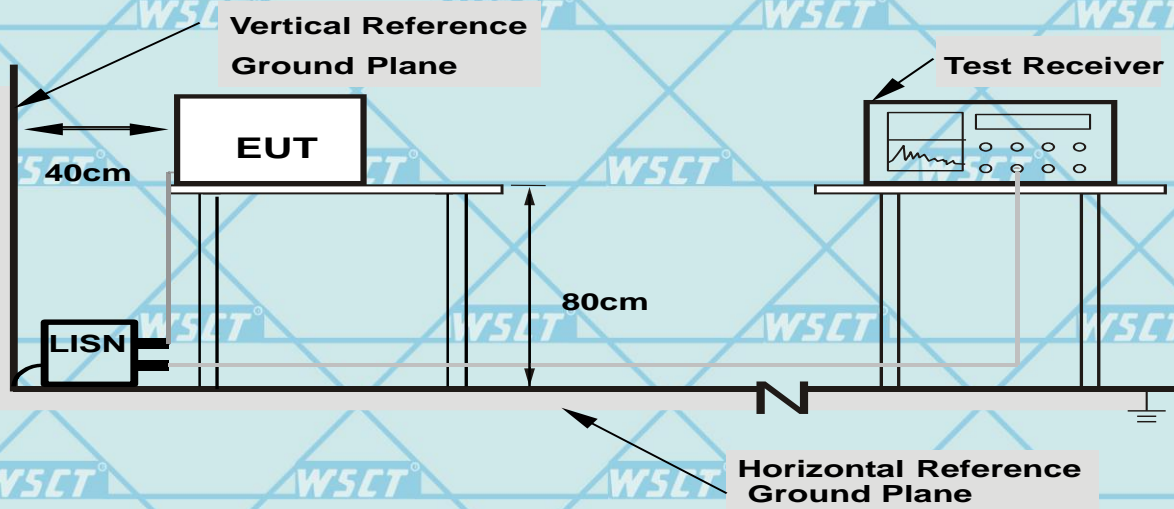

- Note:**
- Support units were connected to second LISN.
  - Both of LISNs (AMN) are 80 cm from EUT and at least 80 from other units and other metal planes

**5.1.5 EUT OPERATING CONDITIONS**

The EUT was configured for testing in a typical fashion (as a customer would normally use it). The EUT has been programmed to continuously transmit during test. This operating condition was tested and used to collect the included data.





For Question,  
Please Contact with WSCT  
www.wsct-cert.com

**5.1.6 TEST RESULTS**

Temperature	26 °C	Relative Humidity	54%
Pressure	1010hPa	Test Mode	Mode 1

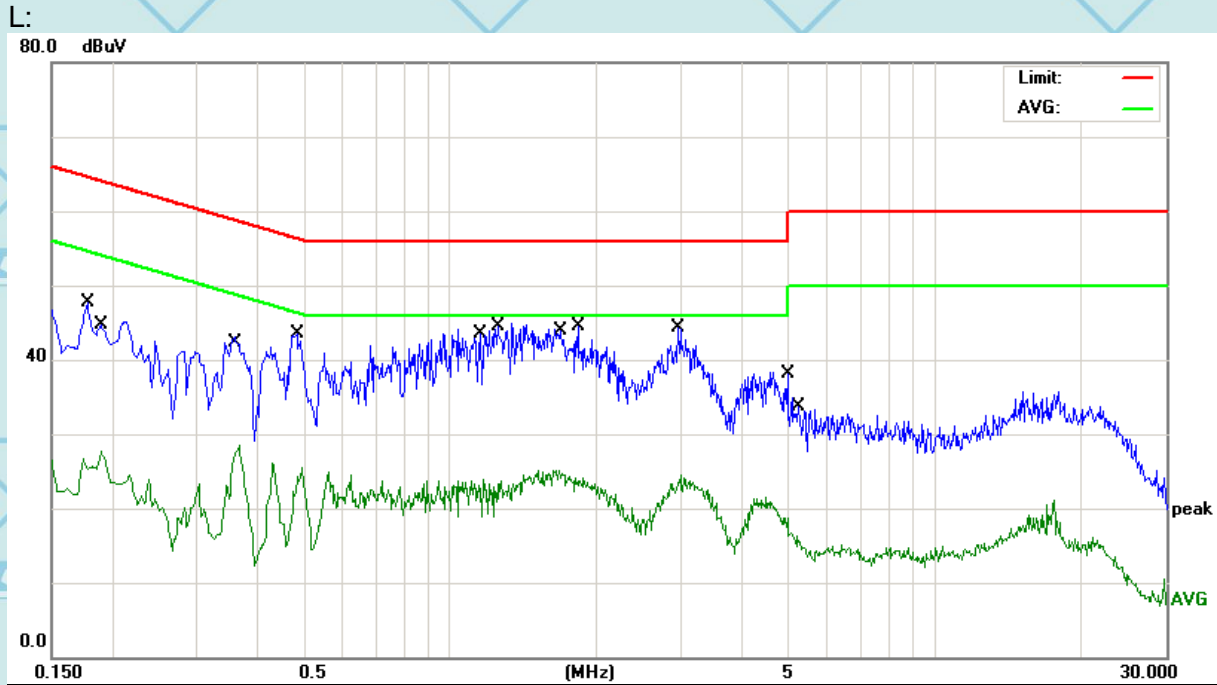

No.	Mk.	Freq. MHz	Reading Level dBuV	Correct Factor dB	Measure- ment dBuV	Limit dBuV	Over dB	Detector
1		0.1780	37.27	10.45	47.72	64.57	-16.85	QP
2		0.1900	17.18	10.45	27.63	54.03	-26.40	AVG
3		0.3660	18.08	10.49	28.57	48.59	-20.02	AVG
4		0.4820	32.97	10.52	43.49	56.30	-12.81	QP
5		1.1700	13.32	10.58	23.90	46.00	-22.10	AVG
6	*	1.2540	33.97	10.59	44.56	56.00	-11.44	QP
7		1.6740	14.37	10.66	25.03	46.00	-20.97	AVG
8		1.8300	33.87	10.68	44.55	56.00	-11.45	QP
9		2.9580	33.61	10.72	44.33	56.00	-11.67	QP
10		2.9820	13.86	10.72	24.58	46.00	-21.42	AVG
11		4.9660	27.35	10.74	38.09	56.00	-17.91	QP
12		5.2540	4.67	10.74	15.41	50.00	-34.59	AVG





For Question,  
Please Contact with WSCT  
www.wsct-cert.com

N:

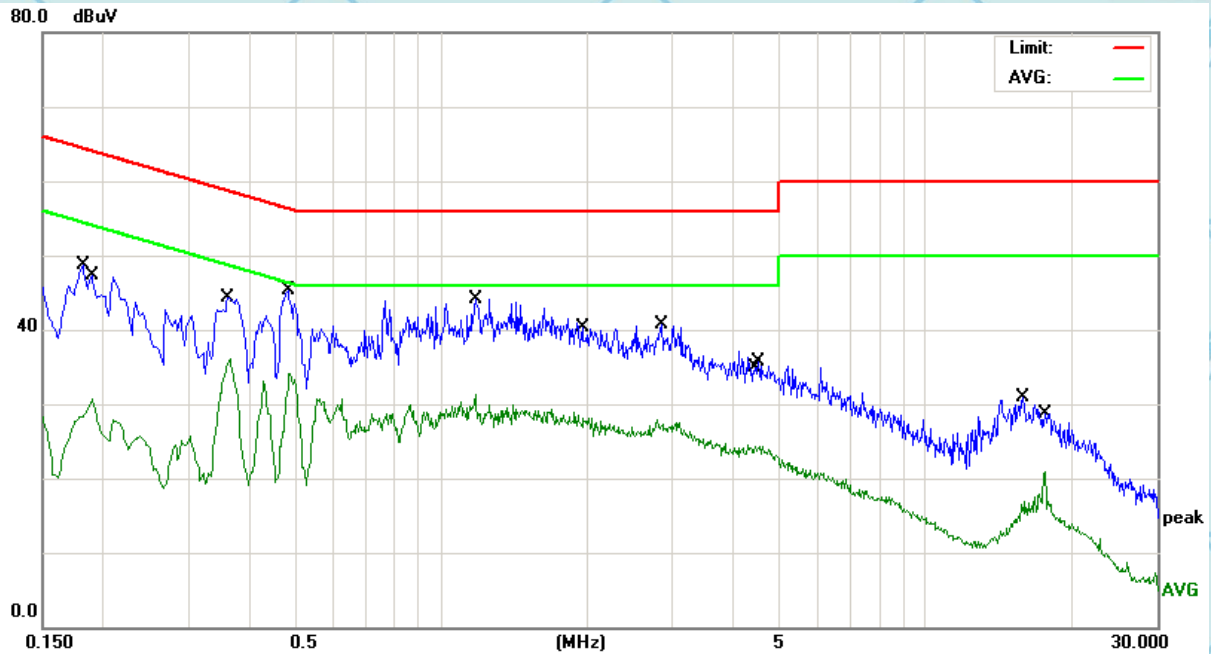

No.	Mk.	Freq. MHz	Reading Level dBuV	Correct Factor dB	Measure- ment dBuV	Limit dBuV	Over dB	Detector
1		0.1819	38.23	10.45	48.68	64.39	-15.71	QP
2		0.1900	20.27	10.45	30.72	54.03	-23.31	AVG
3		0.3660	25.59	10.49	36.08	48.59	-12.51	AVG
4	*	0.4820	34.70	10.52	45.22	56.30	-11.08	QP
5		1.1740	33.45	10.58	44.03	56.00	-11.97	QP
6		1.1740	20.77	10.58	31.35	46.00	-14.65	AVG
7		1.9620	17.47	10.70	28.17	46.00	-17.83	AVG
8		2.8540	29.93	10.72	40.65	56.00	-15.35	QP
9		4.4500	13.63	10.73	24.36	46.00	-21.64	AVG
10		4.5220	25.03	10.74	35.77	56.00	-20.23	QP
11		15.8180	19.74	11.18	30.92	60.00	-29.08	QP
12		17.5419	9.61	11.12	20.73	50.00	-29.27	AVG

Note: 1.All the modes have been investigated, and only worst mode is presented in this report.  
2.Over=Reading Level+ Correct Factor - Limit.





## 5.2 RADIATED EMISSION MEASUREMENT

### 5.2.1 Radiated Emission Limits (Frequency Range 9kHz-1000MHz)

20dBc in any 100 kHz bandwidth outside the operating frequency band. In case the emission fall within the restricted band specified on 15.205(a), then the 15.209(a) limit in the table below has to be followed.

Frequencies (MHz)	Field Strength (microrvolts/meter)	Measurement Distance (meters)
0.009~0.490	2400/F(KHz)	300
0.490~1.705	24000/F(KHz)	30
1.705~30.0	30	30
30~88	100	3
88~216	150	3
216~960	200	3
Above 960	500	3

### LIMITS OF RADIATED EMISSION MEASUREMENT (Above 1000MHz)

FREQUENCY (MHz)	Limit (dBuV/m) (at 3M)	
	PEAK	AVERAGE
Above 1000	74	54

Notes:

- (1) The limit for radiated test was performed according to FCC PART 15C.
- (2) The tighter limit applies at the band edges.
- (3) Emission level (dBuV/m)=20log Emission level (uV/m).

Spectrum Parameter	Setting
Attenuation	Auto
Start Frequency	1000 MHz
Stop Frequency	10th carrier harmonic
RB / VB (emission in restricted band)	1 MHz / 1 MHz for Peak, 1 MHz / 1Hz for Average

Receiver Parameter	Setting
Attenuation	Auto
Start ~ Stop Frequency	9kHz~150kHz / RB 200Hz for QP
Start ~ Stop Frequency	150kHz~30MHz / RB 9kHz for QP
Start ~ Stop Frequency	30MHz~1000MHz / RB 120kHz for QP





For Question,  
Please Contact with WSCT  
www.wsct-cert.com

### 5.2.2 TEST PROCEDURE

- a. The measuring distance of at 3 m shall be used for measurements at frequency up to 1GHz. For frequencies above 1GHz, any suitable measuring distance may be used.
- b. The EUT was placed on the top of a rotating table 0.8 meters above the ground at a 3 meter open area test site. The table was rotated 360 degrees to determine the position of the highest radiation.
- c. The height of the equipment or of the substitution antenna shall be 0.8 m; the height of the test antenna shall vary between 1 m to 4 m. Both horizontal and vertical polarizations of the antenna are set to make the measurement.
- d. The initial step in collecting conducted emission data is a spectrum analyzer peak detector mode pre-scanning the measurement frequency range. Significant peaks are then marked and then Quasi Peak detector mode re-measured.
- e. If the Peak Mode measured value compliance with and lower than Quasi Peak Mode Limit, the EUT shall be deemed to meet QP Limits and then no additional QP Mode measurement performed.
- f. For the actual test configuration, please refer to the related Item –EUT Test Photos.

Note:

***Both horizontal and vertical antenna polarities were tested and performed pretest to three orthogonal axis. The worst case emissions were reported***

### 5.2.3 DEVIATION FROM TEST STANDARD

No deviation







For Question,  
Please Contact with WSCT  
www.wsct-cert.com

### 5.2.4 TEST SETUP

#### (A) Radiated Emission Test-Up Frequency Below 30MHz

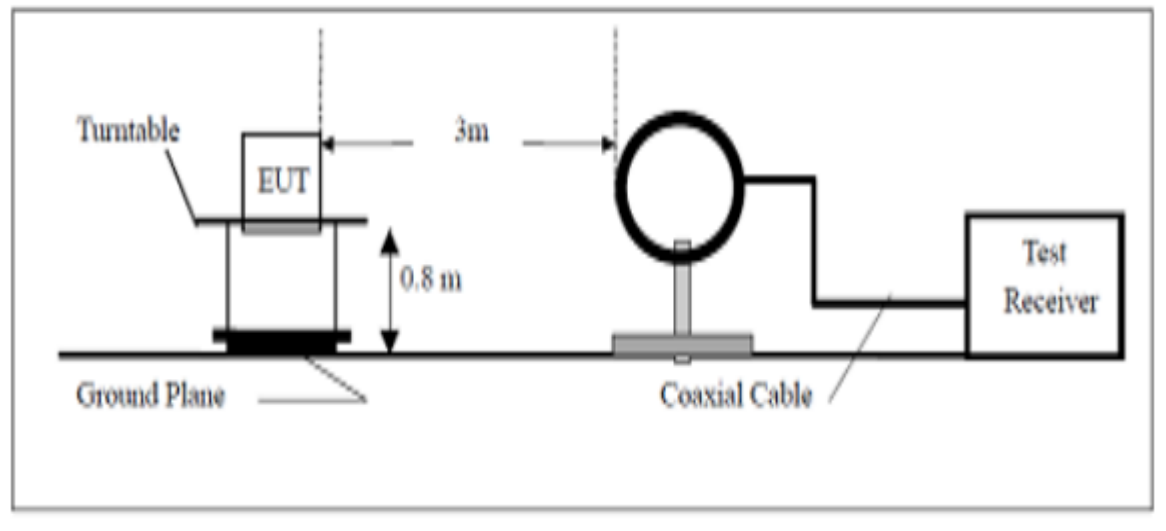

#### (B) Radiated Emission Test-Up Frequency 30MHz~1GHz

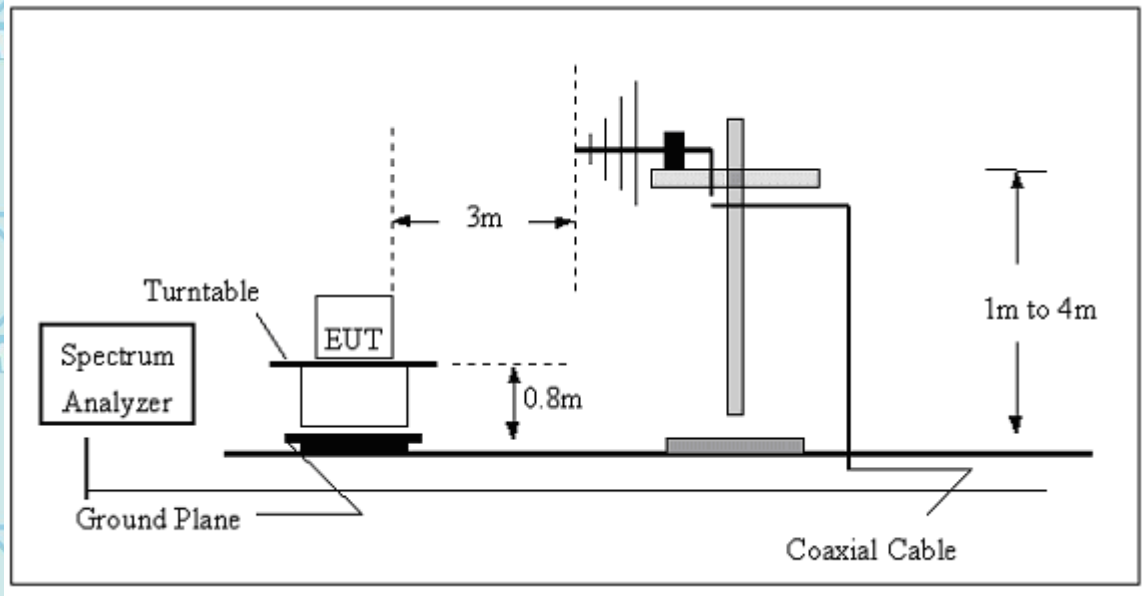



(C) Radiated Emission Test-Up Frequency Above 1GHz

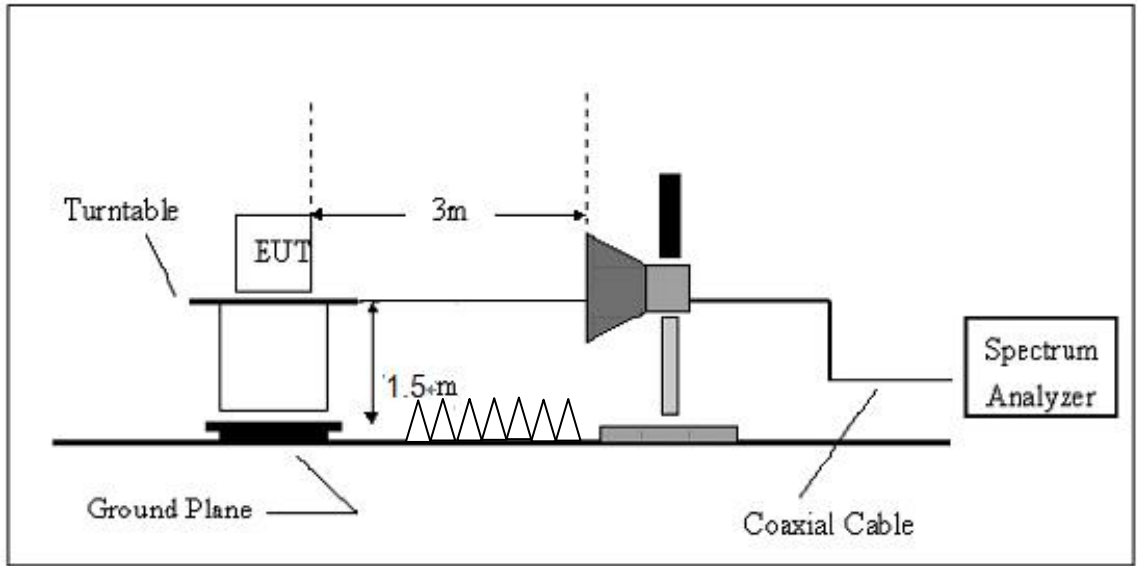

5.2.5 EUT OPERATING CONDITIONS

The EUT tested system was configured as the statements of 2.4 Unless otherwise a special operating condition is specified in the follows during the testing.





For Question,  
Please Contact with WSCT  
www.wsct-cert.com

### 5.2.5.1 RESULTS (Below 30 MHz)

Temperature	20 °C	Relative Humidity	48%
Pressure	1010 hPa	Test Mode	Mode 1

Freq. (MHz)	Reading (dBuV/m)	Limit (dBuV/m)	Margin (dB)	State P/F
--	--	--	--	P
--	--	--	--	P

**NOTE:**

No result in this part for margin above 20dB.

Distance extrapolation factor = 40 log (specific distance/test distance)(dB);

Limit line = specific limits(dBuV) + distance extrapolation factor.

All the x/y/z orientation has been investigated, and only worst case is presented in this report.





For Question,  
Please Contact with WSCT  
www.wsct-cert.com

5.2.5.2 TEST RESULTS (Between 30M – 1000 MHz)

Temperature	20 °C	Relative Humidity	48%
Pressure	1010 hPa	Test Mode	Mode 1

H:

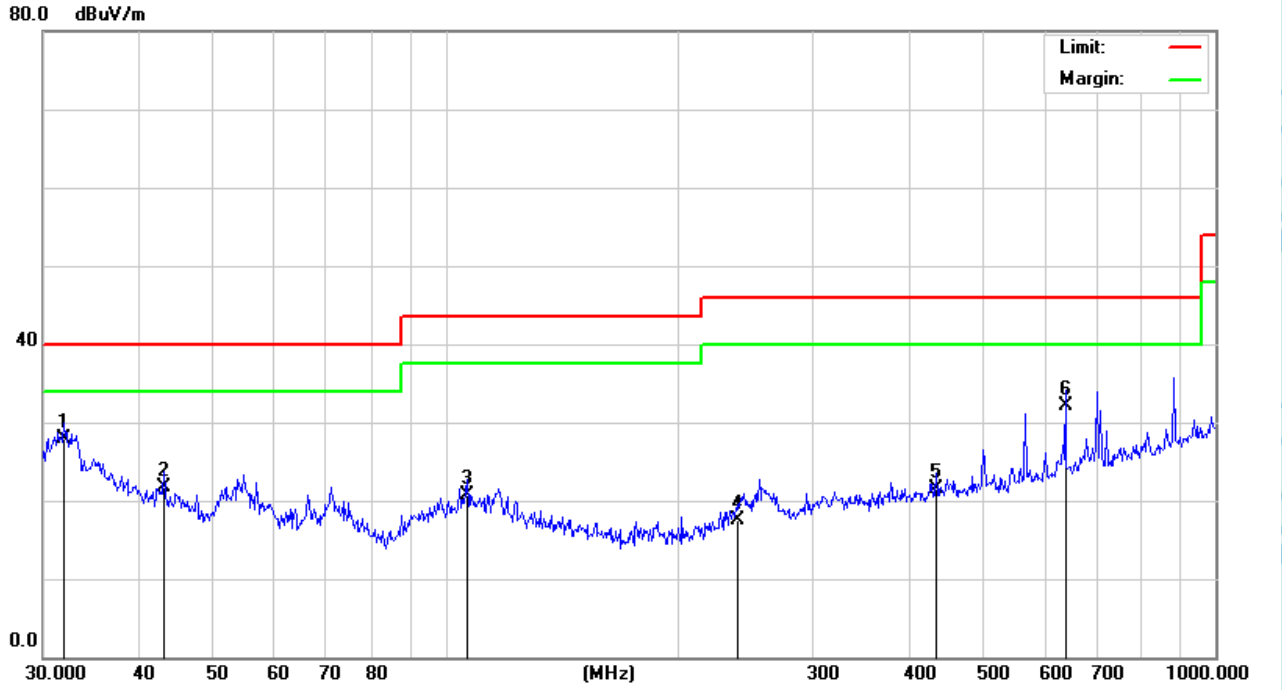

No.	Mk.	Freq. MHz	Reading Level dBuV	Correct Factor dB	Measure- ment dBuV/m	Limit dBuV/m	Over dB	Detector
1	*	31.9546	23.83	4.05	27.88	40.00	-12.12	QP
2		43.0505	22.88	-1.27	21.61	40.00	-18.39	QP
3		106.7587	23.17	-2.50	20.67	43.50	-22.83	QP
4		239.9874	22.69	-5.18	17.51	46.00	-28.49	QP
5		434.0651	21.93	-0.43	21.50	46.00	-24.50	QP
6		638.3686	30.32	1.71	32.03	46.00	-13.97	QP





V:

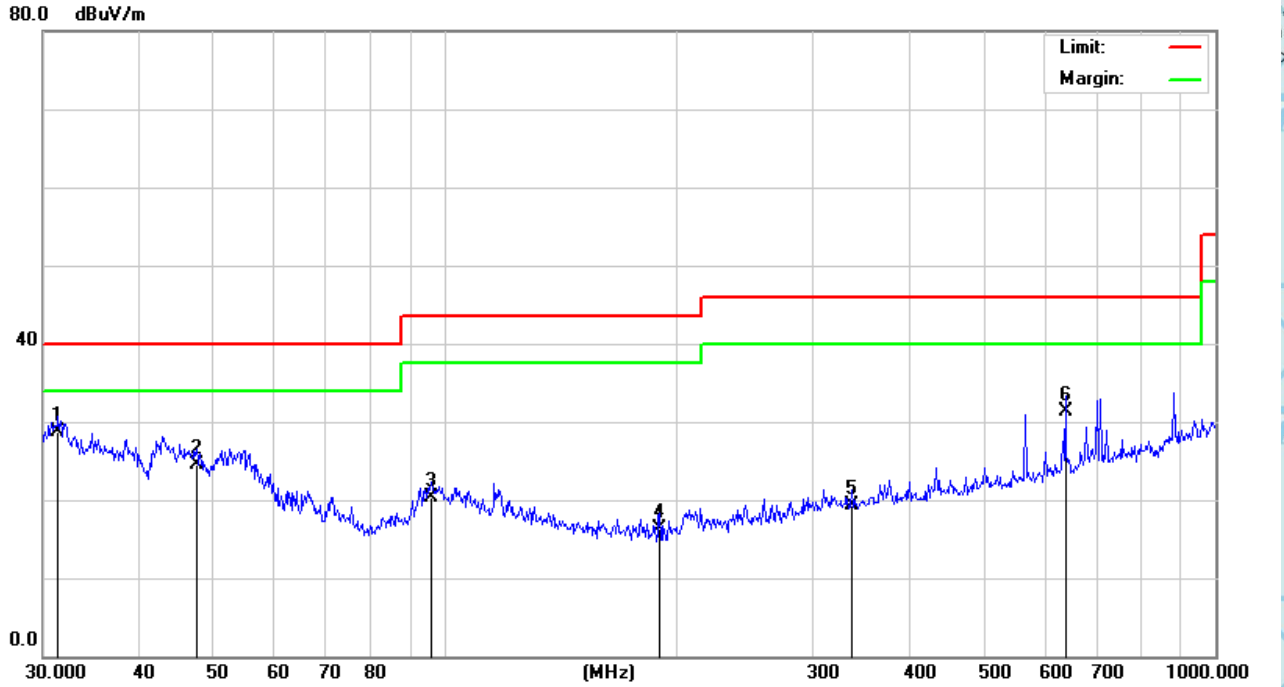

No.	Mk.	Freq. MHz	Reading Level dBuV	Correct Factor dB	Measure- ment dBuV/m	Limit dBuV/m	Over dB	Detector
1	*	31.3992	24.50	4.26	28.76	40.00	-11.24	QP
2		47.4918	28.07	-3.53	24.54	40.00	-15.46	QP
3		95.7622	24.96	-4.71	20.25	43.50	-23.25	QP
4		189.7385	23.40	-7.19	16.21	43.50	-27.29	QP
5		337.2155	21.25	-1.96	19.29	46.00	-26.71	QP
6		638.3686	29.85	1.40	31.25	46.00	-14.75	QP

Note: 1.All the modes have been investigated, and only worst mode is presented in this report.  
2.Over=Reading Level+ Correct Factor - Limit.





### 5.2.5.3 TEST RESULTS (1GHz to 25GHz)

Temperature	20 °C	Relative Humidity	48%
Pressure	1010 hPa	Test Mode	Mode 1 TX
Frequency	2412MHz		

Freq. (MHz)	Ant. Pol.	Emission Level(dBuV)		Limit 3m(dBuV/m)		Over(dB)	
		PK	AV	PK	AV	PK	AV
4824	V	60.36	39.12	74	54	-13.64	-14.88
7236	V	58.25	40.48	74	54	-15.75	-13.52
4824	H	58.45	40.02	74	54	-15.55	-13.98
7236	H	59.21	40.21	74	54	-14.79	-13.79

**Remark:**

All emissions not reported were more than 20dB below the specified limit or in the noise floor.

Factor = Antenna Factor + Cable Loss – Pre-amplifier.

All the x/y/z orientation has been investigated, and only worst case is presented in this report.

Temperature	20 °C	Relative Humidity	48%
Pressure	1010 hPa	Test Mode	Mode 1 TX
Frequency	2437MHz		

Freq. (MHz)	Ant. Pol.	Emission Level(dBuV)		Limit 3m(dBuV/m)		Over(dB)	
		PK	AV	PK	AV	PK	AV
4874	V	60.20	41.27	74	54	-13.80	-12.73
7311	V	59.34	40.97	74	54	-14.66	-13.03
4874	H	58.20	39.50	74	54	-15.80	-14.50
7311	H	59.30	40.30	74	54	-14.70	-13.70

**Remark:**

All emissions not reported were more than 20dB below the specified limit or in the noise floor.

Factor = Antenna Factor + Cable Loss – Pre-amplifier.

All the x/y/z orientation has been investigated, and only worst case is presented in this report.





Temperature	20 °C	Relative Humidity	48%	For Question, Please Contact with WSCT www.wsct-cert.com
Pressure	1010 hPa	Test Mode	Mode 1 TX	
Frequency	2462MHz			

Freq. (MHz)	Ant. Pol.	Emission Level(dBuV)		Limit 3m(dBuV/m)		Over(dB)	
		PK	AV	PK	AV	PK	AV
4924	V	60.96	41.56	74	54	-13.04	-12.44
7386	V	59.20	40.68	74	54	-14.80	-13.32
4924	H	58.55	40.32	74	54	-15.45	-13.68
7386	H	59.11	40.11	74	54	-14.89	-13.89

**Remark:**

All emissions not reported were more than 20dB below the specified limit or in the noise floor.

Factor = Antenna Factor + Cable Loss – Pre-amplifier.

All the x/y/z orientation has been investigated, and only worst case is presented in this report.

Temperature	20 °C	Relative Humidity	48%
Pressure	1010 hPa	Test Mode	Mode2 TX
Frequency	2412MHz		

Freq. (MHz)	Ant. Pol.	Emission Level(dBuV)		Limit 3m(dBuV/m)		Over(dB)	
		PK	AV	PK	AV	PK	AV
4824	V	58.30	40.66	74	54	-15.70	-13.34
7236	V	58.52	40.33	74	54	-15.48	-13.67
4824	H	59.81	39.69	74	54	-14.19	-14.31
7236	H	59.05	40.05	74	54	-14.95	-13.95

**Remark:**

All emissions not reported were more than 20dB below the specified limit or in the noise floor.

Factor = Antenna Factor + Cable Loss – Pre-amplifier.

All the x/y/z orientation has been investigated, and only worst case is presented in this report.





Temperature	20 °C	Relative Humidity	48%
Pressure	1010 hPa	Test Mode	Mode 2 TX
Frequency	2437MHz		

Freq. (MHz)	Ant.Pol.	Emission Level(dBuV)		Limit 3m(dBuV/m)		Over(dB)	
		PK	AV	PK	AV	PK	AV
4874	V	59.14	40.29	74	54	-14.86	-13.71
7311	V	58.65	40.55	74	54	-15.35	-13.45
4874	H	58.36	39.33	74	54	-15.64	-14.67
7311	H	59.78	40.78	74	54	-14.22	-13.22

**Remark:**

All emissions not reported were more than 20dB below the specified limit or in the noise floor.

Factor = Antenna Factor + Cable Loss – Pre-amplifier.

All the x/y/z orientation has been investigated, and only worst case is presented in this report.

Temperature	20 °C	Relative Humidity	48%
Pressure	1010 hPa	Test Mode	Mode 2 TX
Frequency	2462MHz		

Freq. (MHz)	Ant.Pol.	Emission Level(dBuV)		Limit 3m(dBuV/m)		Over(dB)	
		PK	AV	PK	AV	PK	AV
4924	V	59.82	41.89	74	54	-14.18	-12.11
7386	V	59.11	39.13	74	54	-14.89	-14.87
4924	H	58.54	39.36	74	54	-15.46	-14.64
7386	H	59.44	40.44	74	54	-14.56	-13.56

**Remark:**

All emissions not reported were more than 20dB below the specified limit or in the noise floor.

Factor = Antenna Factor + Cable Loss – Pre-amplifier.

All the x/y/z orientation has been investigated, and only worst case is presented in this report.







Temperature	20 °C	Relative Humidity	48%
Pressure	1010 hPa	Test Mode	Mode3 TX
Frequency	2412MHz		

Freq. (MHz)	Ant. Pol.	Emission Level(dBuV)		Limit 3m(dBuV/m)		Over(dB)	
		PK	AV	PK	AV	PK	AV
4824	V	59.49	40.94	74	54	-14.51	-13.06
7236	V	58.58	40.82	74	54	-15.42	-13.18
4824	H	59.94	40.76	74	54	-14.06	-13.24
7236	H	59.91	40.91	74	54	-14.09	-13.09

Remark:

All emissions not reported were more than 20dB below the specified limit or in the noise floor.  
Factor = Antenna Factor + Cable Loss – Pre-amplifier.  
All the x/y/z orientation has been investigated, and only worst case is presented in this report.

Temperature	20 °C	Relative Humidity	48%
Pressure	1010 hPa	Test Mode	Mode 3 TX
Frequency	2437MHz		

Freq. (MHz)	Ant.Pol.	Emission Level(dBuV)		Limit 3m(dBuV/m)		Over(dB)	
		PK	AV	PK	AV	PK	AV
4874	V	60.93	39.58	74	54	-13.07	-14.42
7311	V	58.27	39.47	74	54	-15.73	-14.53
4874	H	59.93	39.38	74	54	-14.07	-14.62
7311	H	59.84	40.84	74	54	-14.16	-13.16

Remark:

All emissions not reported were more than 20dB below the specified limit or in the noise floor.  
Factor = Antenna Factor + Cable Loss – Pre-amplifier.  
All the x/y/z orientation has been investigated, and only worst case is presented in this report.





For Question, Please Contact with WSCT  
www.wsct-cert.com

Temperature	20 °C	Relative Humidity	48%
Pressure	1010 hPa	Test Mode	Mode 3 TX
Frequency	2462MHz		

Freq. (MHz)	Ant.Pol.	Emission Level(dBuV)		Limit 3m(dBuV/m)		Over(dB)	
		PK	AV	PK	AV	PK	AV
4924	V	60.36	40.83	74	54	-13.64	-13.17
7386	V	59.02	39.53	74	54	-14.98	-14.47
4924	H	58.98	40.02	74	54	-15.02	-13.98
7386	H	58.20	39.20	74	54	-15.80	-14.80

**Remark:**

All emissions not reported were more than 20dB below the specified limit or in the noise floor.  
 Factor = Antenna Factor + Cable Loss – Pre-amplifier.  
 All the x/y/z orientation has been investigated, and only worst case is presented in this report.





## 6. ANTENNA APPLICATION

### 6.1 Antenna requirement

The EUT'S antenna is met the requirement of FCC part 15C section 15.203 and 15.247

FCC part 15C section 15.247 requirements: Systems operating in the 2402-2480MHz band that are used exclusively for fixed, point-to-point operations may employ transmitting antennas with directional gain greater than 6dBi provided the maximum peak output power of the intentional radiator is reduced by 1dB for every 3dB that the directional gain of the antenna exceeds 6dBi.

### 6.2 Result

The EUT's antenna Integral Antenna, The antenna's gain is -1.3dBi and meets the requirement.





## 7. 6DB BANDWIDTH MEASUREMENT

### 7.1 TEST SETUP

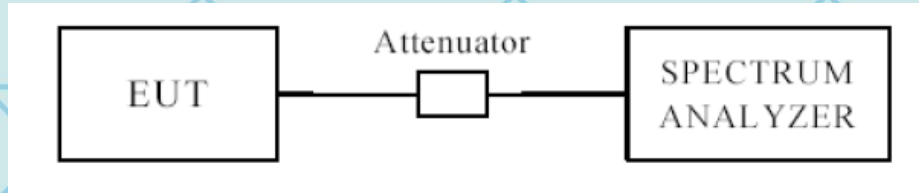

### 7.2 LIMITS OF 6DB BANDWIDTH MEASUREMENT

The minimum of 6dB Bandwidth Measurement is >500 kHz

### 7.3 TEST PROCEDURE

1. Set resolution bandwidth (RBW) = 100 kHz
2. Set the video bandwidth (VBW) ≥ 3 x RBW.
3. Detector = Peak.
4. Trace mode = max hold.
5. Sweep = auto couple.
6. Allow the trace to stabilize.
7. Measure the maximum width of the emission that is constrained by the frequencies associated with the two outermost amplitude points (upper and lower) that are attenuated by 6 dB relative to the maximum level measured in the fundamental emission.

### 7.4 TEST RESULT

6dB Occupied Bandwidth

Mode		802.11b	Humidity		56% RH
Temperature		24 deg. C,			
Channel	Channel Frequency (MHz)	Data Transfer Rate (Mbps)	6 dB Bandwidth (kHz)	Minimum Limit (MHz)	Pass/ Fail
1	2412	1	8589.7	0.5	Pass
6	2437	1	9615.4	0.5	Pass
11	2462	1	9679.5	0.5	Pass

Mode		802.11g	Humidity		56% RH
Temperature		24 deg. C,			
Channel	Channel Frequency (MHz)	Data Transfer Rate (Mbps)	6 dB Bandwidth (kHz)	Minimum Limit (MHz)	Pass/ Fail
1	2412	6	11282.1	0.5	Pass
6	2437	6	16089.7	0.5	Pass
11	2462	6	12756.4	0.5	Pass





Mode		802.11n20		Humidity		56% RH	
Temperature		24 deg. C,				For Question, Please Contact with WSCT www.wsct-cert.com	
Channel	Channel Frequency (MHz)	Data Transfer Rate (Mbps)	6 dB Bandwidth (kHz)	Minimum Limit (MHz)	Pass/ Fail		
1	2412	6.5	11410.3	0.5	Pass		
6	2437	6.5	17307.7	0.5	Pass		
11	2462	6.5	12500.0	0.5	Pass		





For Question,  
Please Contact with WSCT  
www.wsct-cert.com

### 802.11b at 1Mbps of CH1

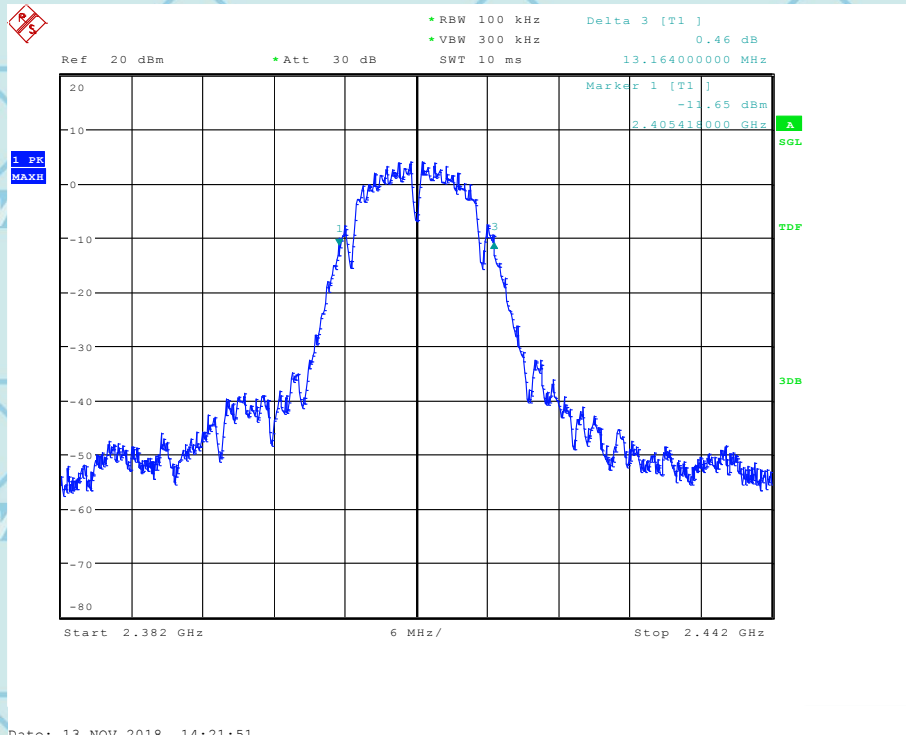

Date: 13.NOV.2018 14:21:51

### 802.11b at 1Mbps of CH6

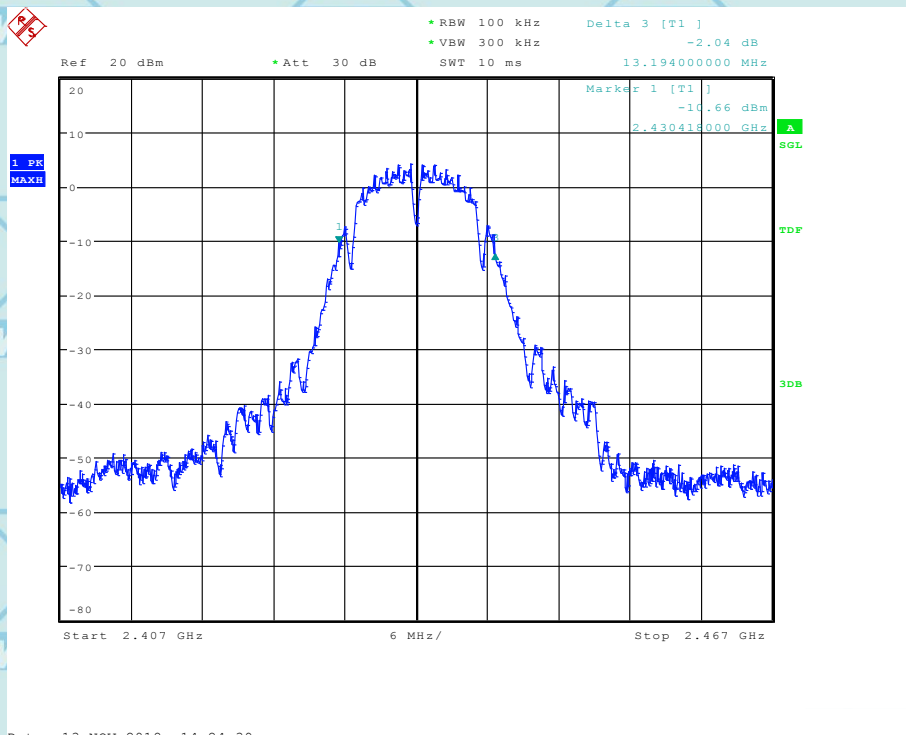

Date: 13.NOV.2018 14:24:39







For Question, Please Contact with WSCT www.wsct-cert.com

802.11g at 6Mbps of CH6

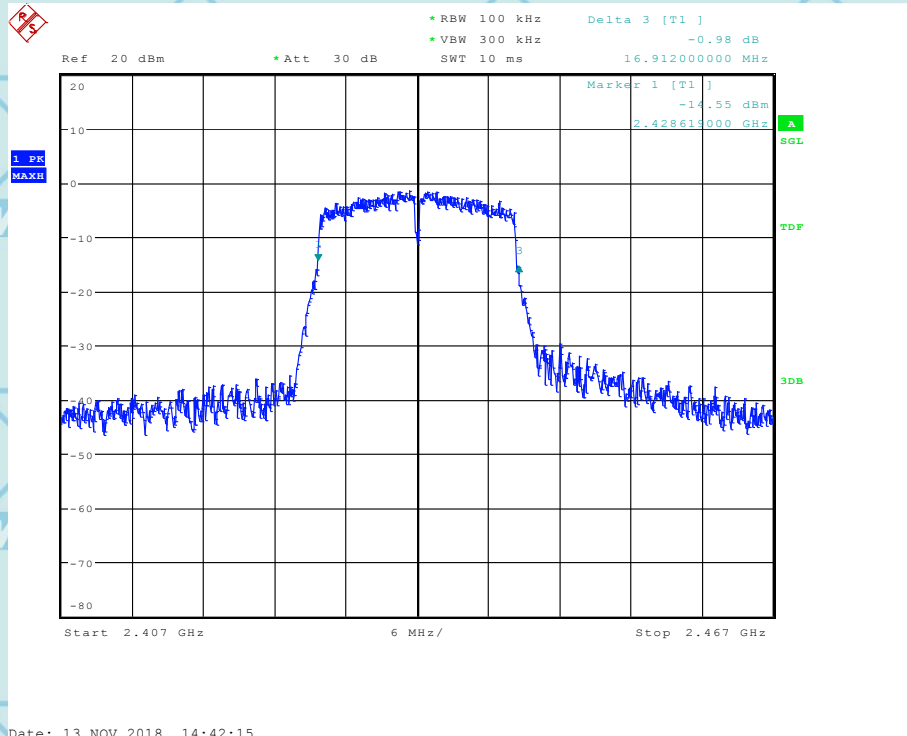

802.11g at 6Mbps of CH11

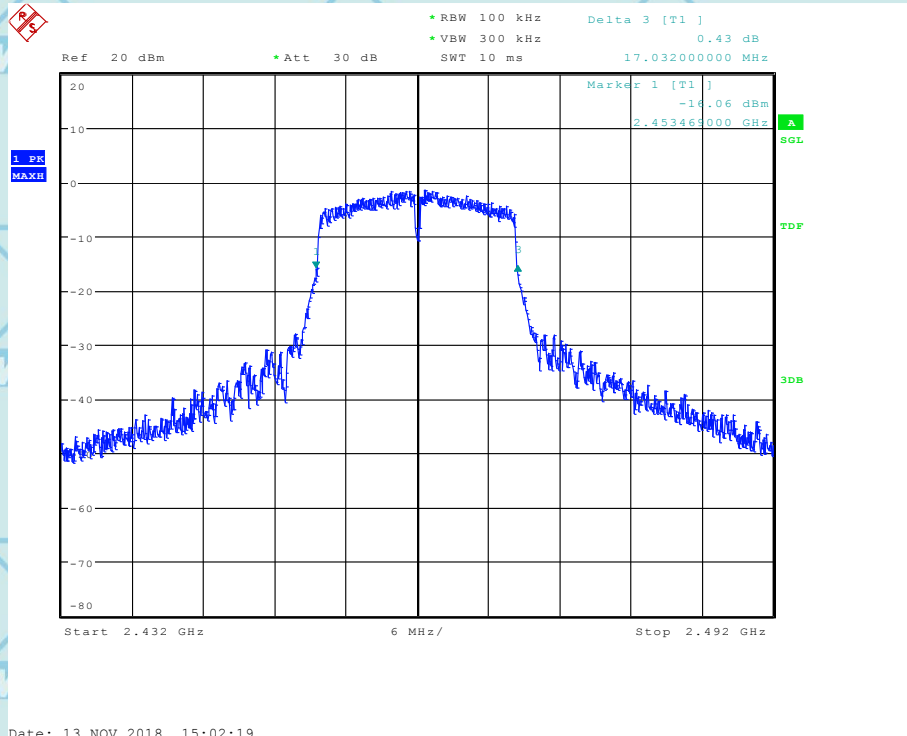

Date: 13.NOV.2018 15:02:19







For Question, Please Contact with WSCT www.wsct-cert.com

802.11n at HT20 of CH1

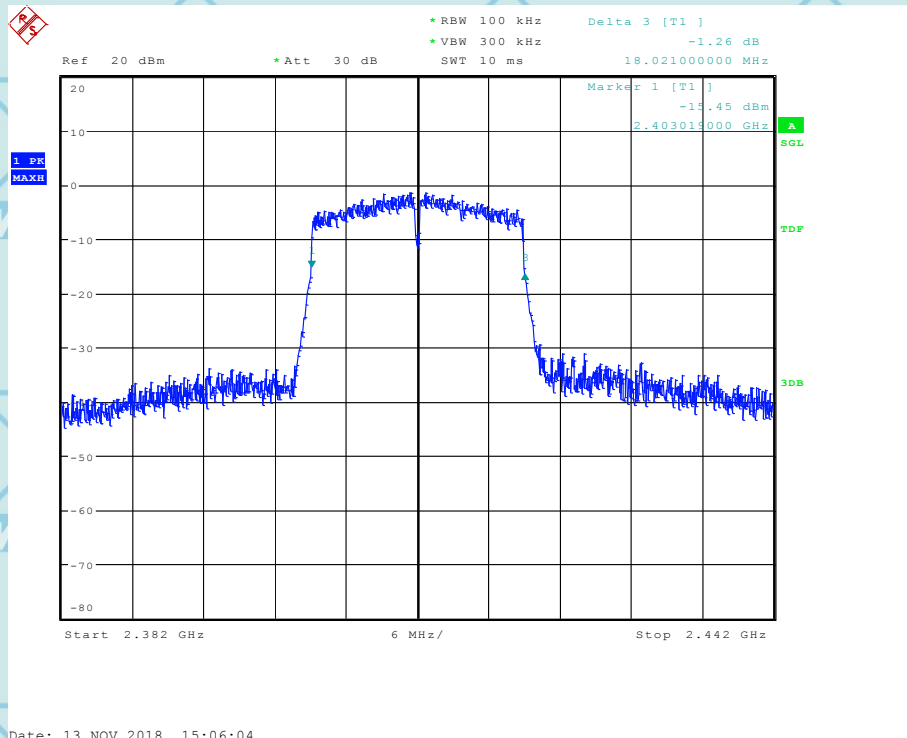

802.11n at HT20 of CH6

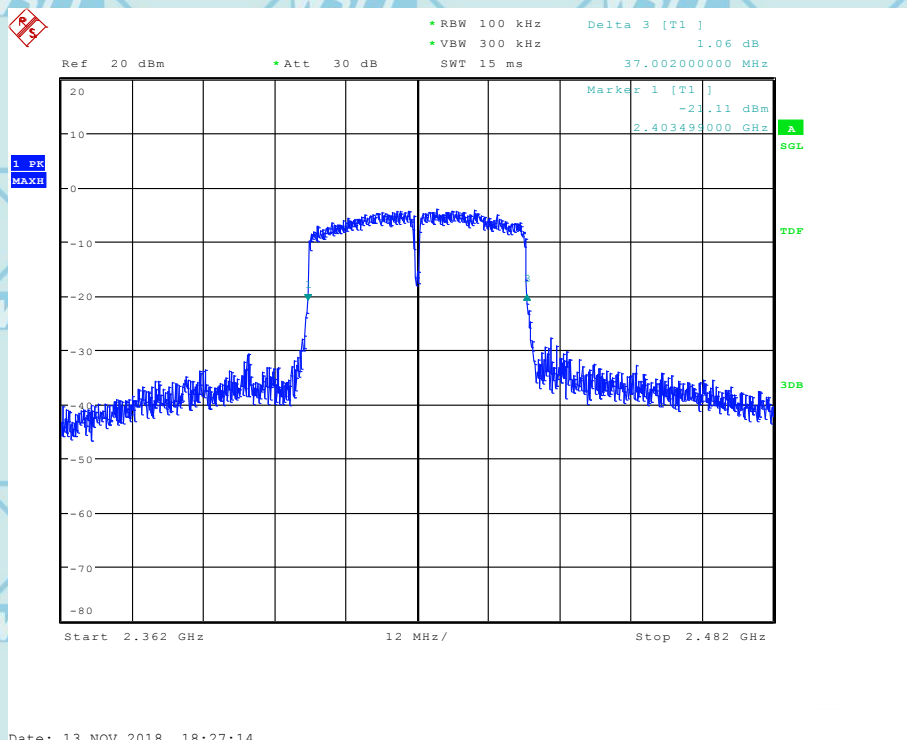



For Question, Please Contact with WSCT www.wsct-cert.com

802.11n at HT20 of CH11

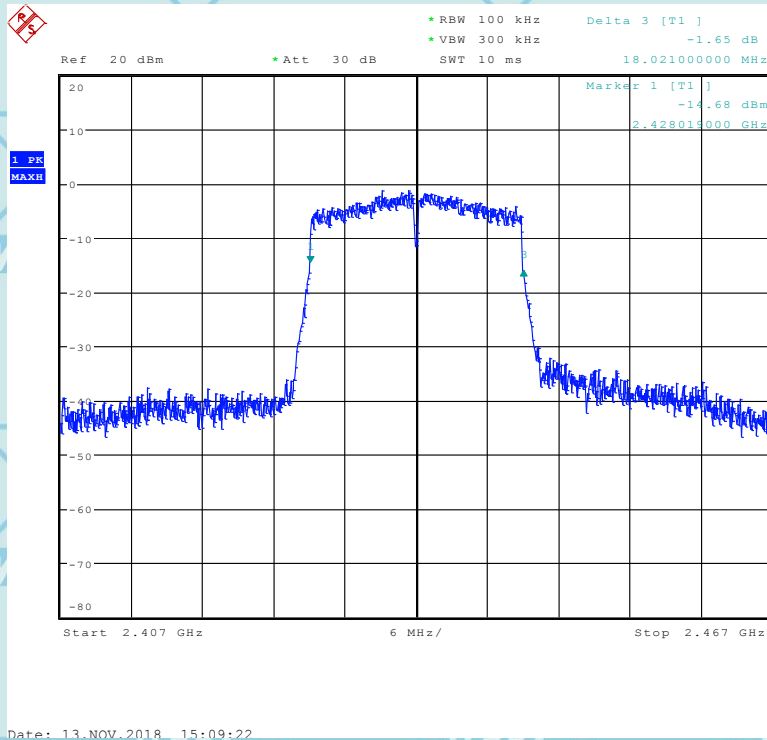



For Question,  
Please Contact with WSCT  
[www.wsct-cert.com](http://www.wsct-cert.com)

### 8. MAXIMUM CONDUCTED OUTPUT POWER

Test Requirement: FCC 47 CFR Part 15 Subpart C 15.247(b)

Test Method: KDB 789033 D02 v01r04 Section E.3.a (Method PM)

The Maximum Peak Output Power Measurement is 30dBm.

Test Procedure:

1. Connected the EUT's antenna port to measure device by 10dB attenuator.
2. Method PM is used to perform output power measurement, trigger and gating function of wide band power meter is enabled to measure max output power of Tx on burst.

For Conducted RF test setup

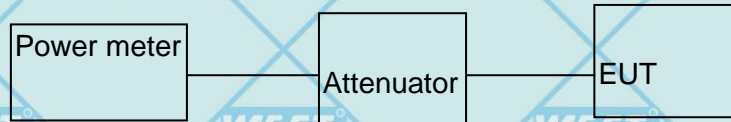

(EUT: Mobile Phone)





For Question,  
Please Contact with WSCT  
www.wsct-cert.com

Test Data:

Mode	Channel/ Frequency (MHz)	Maximum conducted output power (dBm)	Limit(dBm)	Pass / Fail
		Meas Power		
802.11b	1(2412)	17.34	30	Pass
	6(2437)	<b>17.51</b>	30	Pass
	11(2462)	17.31	30	Pass
802.11g	1(2412)	15.08	30	Pass
	6(2437)	15.55	30	Pass
	11(2462)	15.76	30	Pass
802.11n(HT20)	1(2412)	15.34	30	Pass
	6(2437)	15.87	30	Pass
	11(2462)	15.88	30	Pass





## 9. POWER SPECTRAL DENSITY MEASUREMENT

### 9.1 TEST SETUP

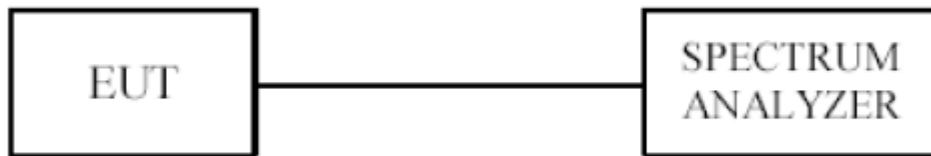

### 9.2 LIMITS OF POWER SPECTRAL DENSITY MEASUREMENT

The Maximum Power Spectral Density Measurement is 8dBm.

### 9.3 TEST PROCEDURE

1. Use this procedure when the maximum peak conducted output power in the fundamental emission is used to demonstrate compliance.
2. Set the RBW = 3 kHz.
3. Set the VBW = 10 kHz.
4. Set the span to 1.5 times the DTS channel bandwidth.
5. Detector = peak.
6. Sweep time = auto couple.
7. Trace mode = max hold.
8. Allow trace to fully stabilize.
9. Use the peak marker function to determine the maximum amplitude level.
10. If measured value exceeds limit, reduce RBW (no less than 3 kHz) and repeat.
11. The resulting peak PSD level must be  $\leq 8$  dBm.



**9.4 TEST RESULT**

Mode	802.11b		Humidity	56% RH	
Temperature	24 deg. C,				
Channel	Channel Frequency (MHz)	Final RF Power Level in (dBm)	Maximum Limit (dBm)	Pass/ Fail	
1Mbps					
1	2412	-14.16	8	Pass	
6	2437	-14.17	8	Pass	
11	2462	-14.39	8	Pass	

For Question, Please Contact with WSCT  
www.wsct-cert.com

Mode	802.11g		Humidity	56% RH	
Temperature	24 deg. C,				
Channel	Channel Frequency (MHz)	Final RF Power Level in (dBm)	Maximum Limit (dBm)	Pass/ Fail	
6Mbps					
1	2412	-14.67	8	Pass	
6	2437	-14.70	8	Pass	
11	2462	-14.85	8	Pass	

Mode	802.11n HT20		Humidity	56% RH	
Temperature	24 deg. C,				
Channel	Channel Frequency (MHz)	Final RF Power Level in (dBm)	Maximum Limit (dBm)	Pass/ Fail	
6.5Mbps					
1	2412	-15.12	8	Pass	
6	2437	-15.26	8	Pass	
11	2462	-14.80	8	Pass	

Remark: All of the modes have been investigated, and only worst mode is presented in this report.





For Question, Please Contact with WSCT w.wsct-cert.com

802.11b at 1Mbps of CH1

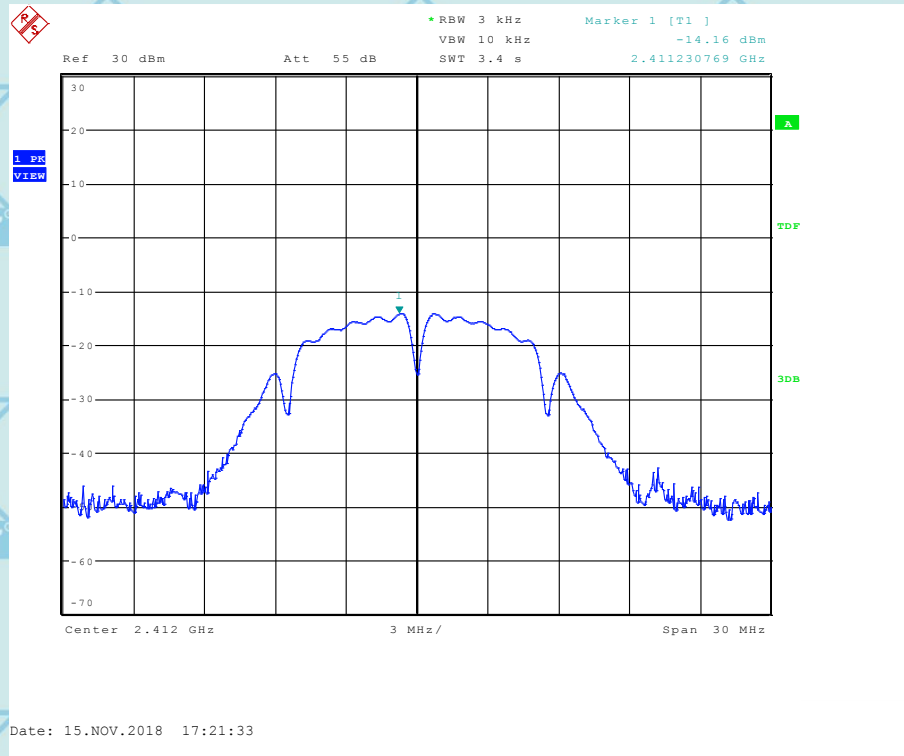

802.11b at 1Mbps at CH6

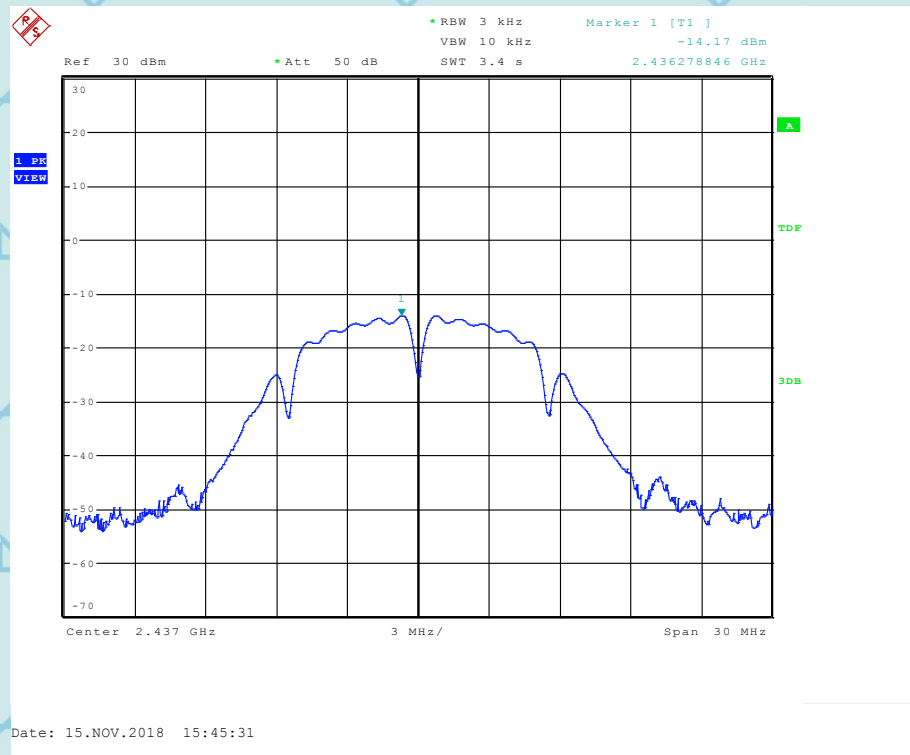



For Question, Please Contact with WSCT www.wsct-cert.com

802.11b at 1Mbps of CH11

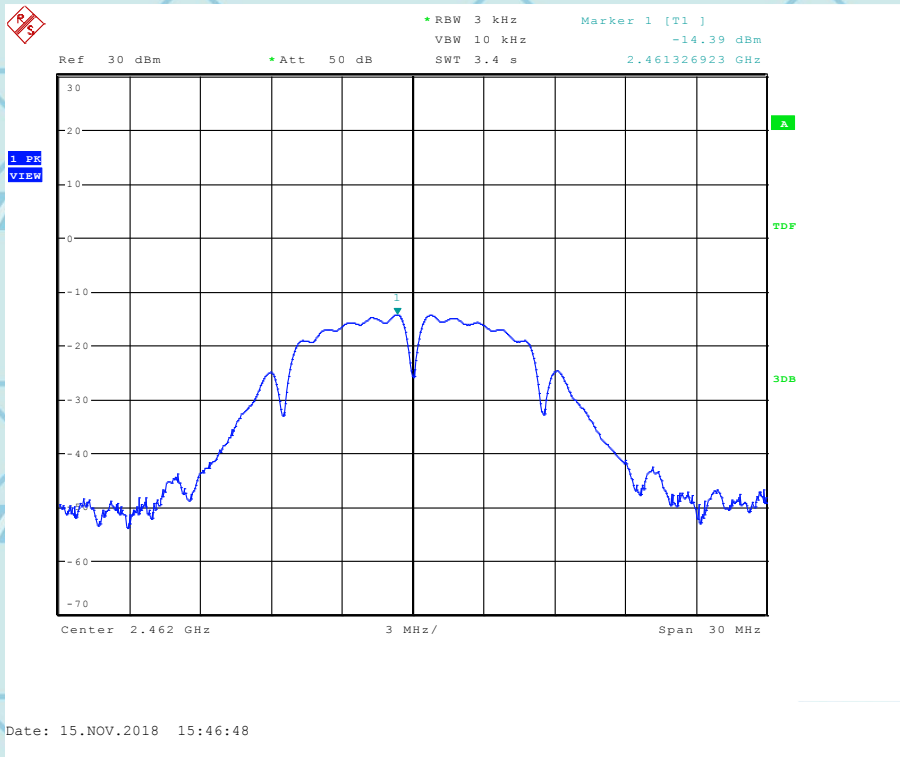

802.11g at 6Mbps of CH1

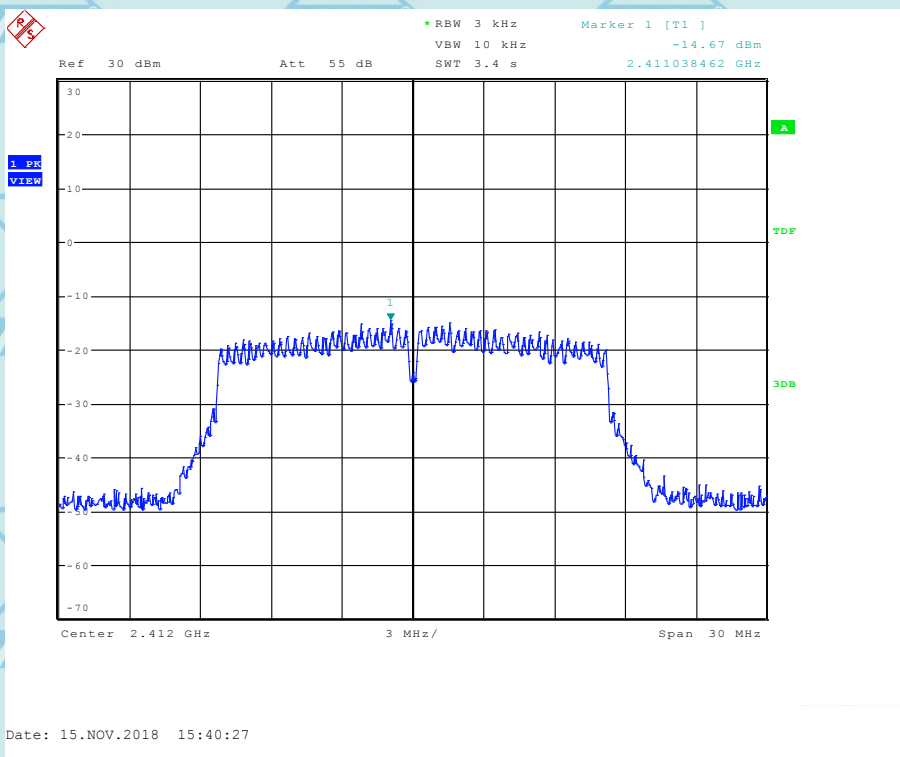

世标检测认证股份 World Standardization Certification & Testing Group Co.,Ltd.

ADD: Building A-B Baoshi Science & technology Park, Baoshi Road, Bao'an District, Shenzhen, Guangdong, China TEL:86-755-26996143/26996144/26996145/26996192 FAX:86-755-86376605 E-mail:Fengbing.Wang@wsct-cert.com Http:www.wsct-cert.com





For Question, Please Contact with WSCT www.wsct-cert.com

802.11g at 6Mbps of CH6

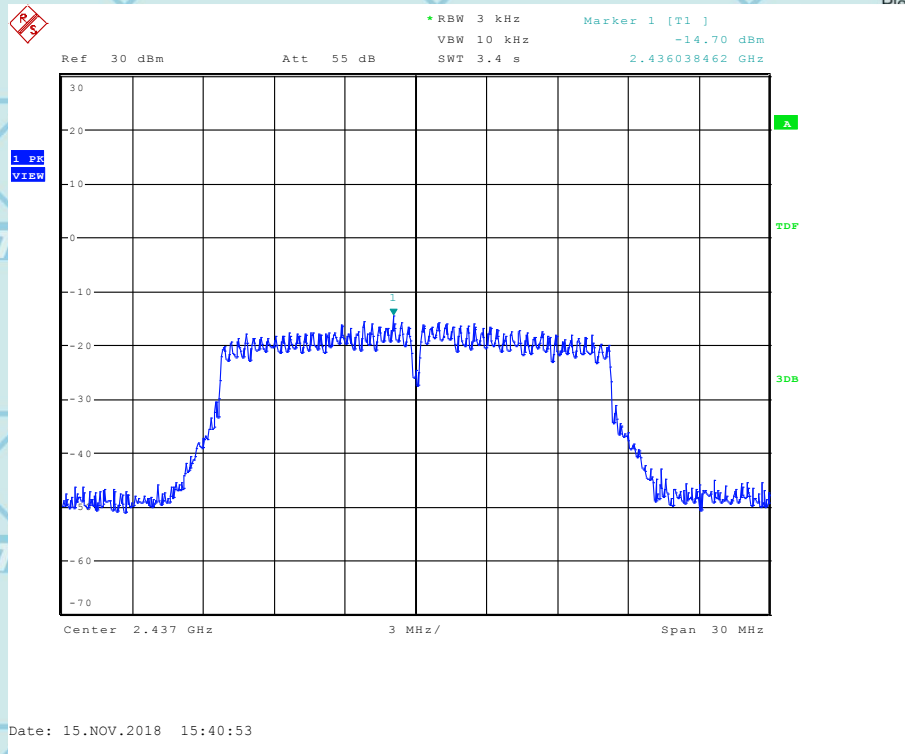

802.11g at 6Mbps of CH11

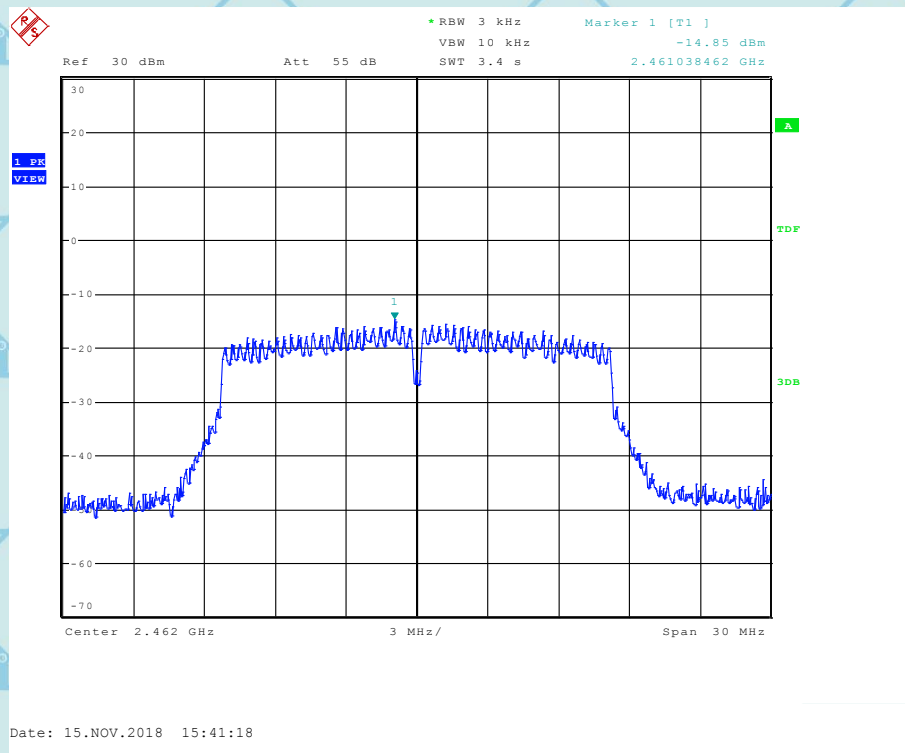



For Question, Please Contact with WSCT w.wsct-cert.com

802.11n HT20 at 6.5Mbps of CH1

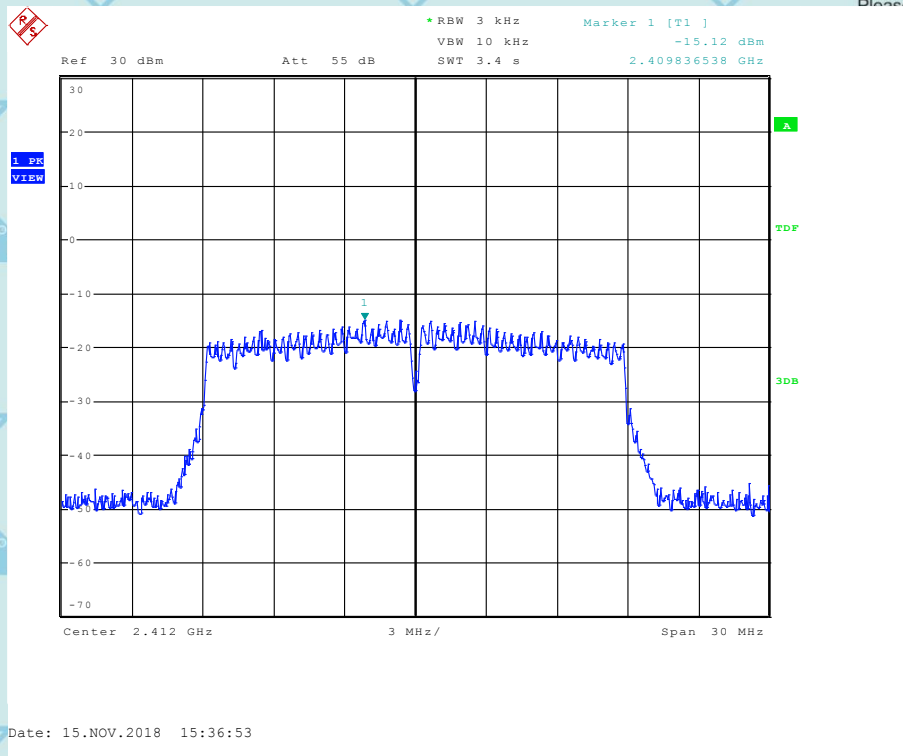

802.11n HT20 at 6.5Mbps of CH6

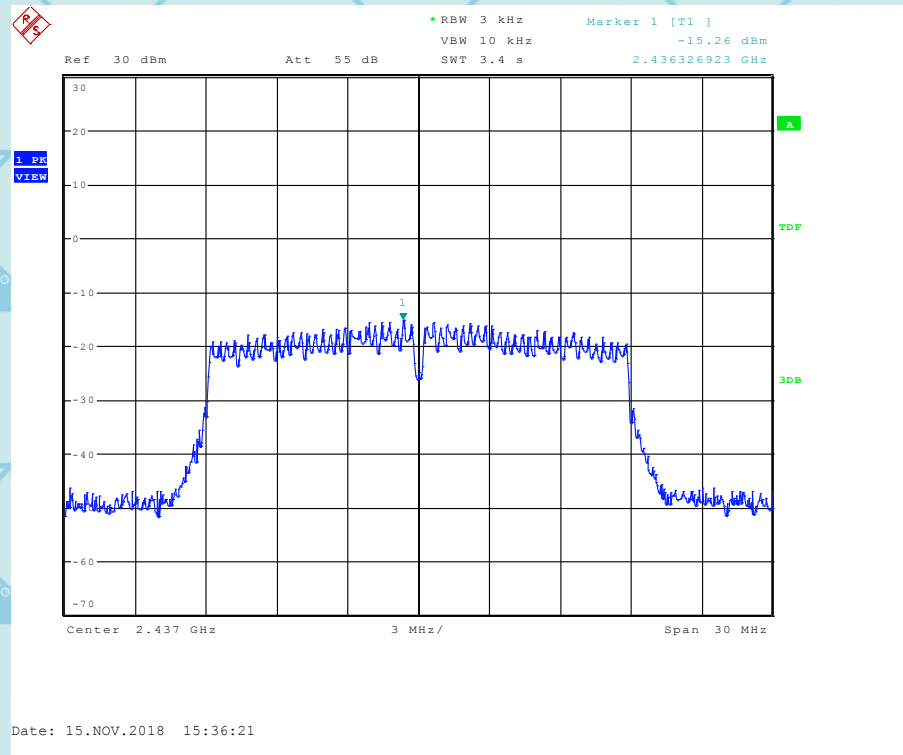



802.11n HT20 at 6.5Mbps of CH11

For Question, e Contact with WSCT www.wsct-cert.com

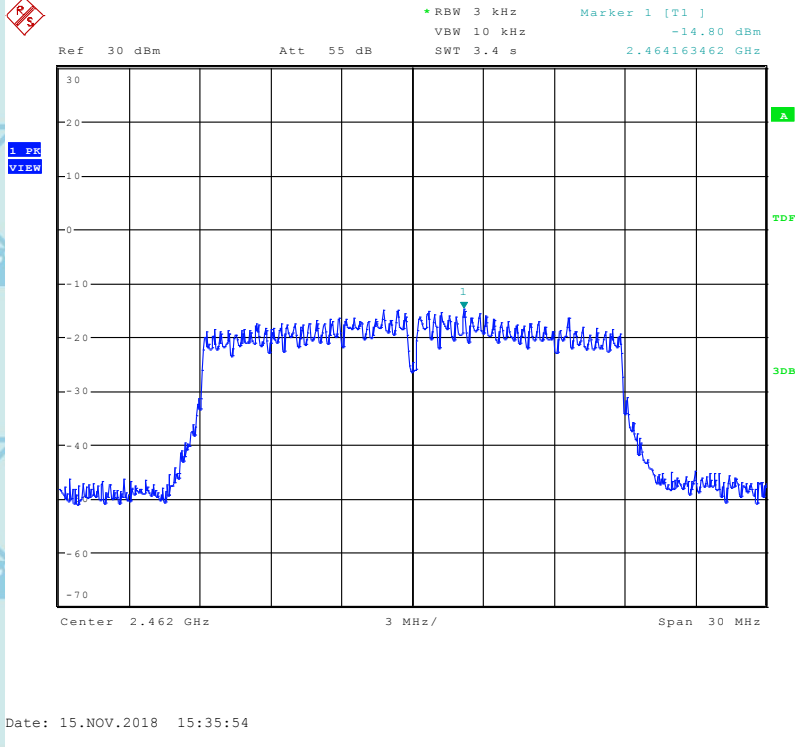

世标检测认证股份 World Standardization Certification & Testing Group Co.,Ltd.

ADD: Building A-B Baoshi Science & technology Park, Baoshi Road, Bao'an District, Shenzhen, Guangdong, China TEL:86-755-26996143/26996144/26996145/26996192 FAX:86-755-86376605 E-mail:Fengbing.Wang@wsct-cert.com Http:www.wsct-cert.com

Member of the WSCT, INC.



## 10. OUT OF BAND MEASUREMENT

### 10.1 TEST SETUP FOR BAND EDGE

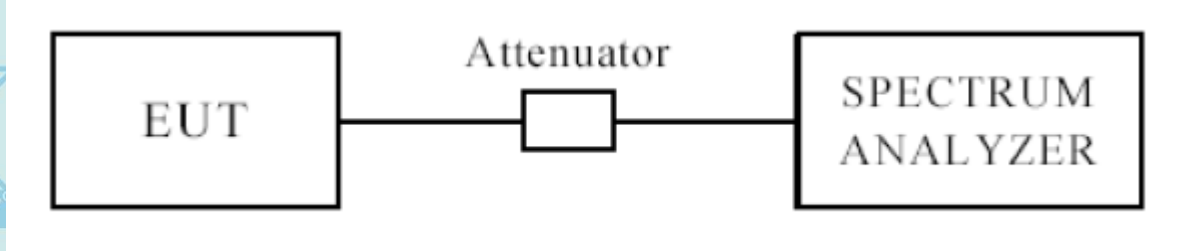

The restricted band requirement based on radiated emission test; please see the clause 6 for the test setup

### 10.2 LIMITS OF OUT OF BAND EMISSIONS MEASUREMENT

1. Below -20dB of the highest emission level of operating band (in 100kHz Resolution Bandwidth).
2. Fall in the restricted bands listed in section 15.205. The maximum permitted average field strength is listed in section 15.209.

### 10.3 TEST PROCEDURE

For signals in the restricted bands above and below the 2.4-2.483GHz allocated band a measurement was made of radiated emission test. ( Peak values with RBW=VBW=1MHz and PK detector. AV value with RBW=1MHz,VBW=10Hz and PK detector)

For bandage test, the spectrum set as follows: RBW=100 kHz, VBW=100 kHz. A conducted measurement used

### 10.4 TEST RESULT

Please see next pages

Note: This is a handheld device. The radiated emissions should be tested under 3-axes position (Lying, Stand), After pre-test. It was found that the worse radiated emission was get at the lying position.





**Radiated measurement:**

**802.11b**

Indicated		result (PK/AV)	Antenna Polar (H/V)	Correction Factor			FCC Part 15.247		
Frequency (MHz)	Receiver Reading (dB $\mu$ V/m)			Ant. Factor (dB/m)	Cable Loss (dB)	Pre-Amp. Gain (dB)	Cord. Amp. (dB $\mu$ V/m)	Limit (dB $\mu$ V/m)	Margin (dB)
Low Channel (2412MHz)									
2390	29.41	AV	V	30.3	4.1	33.1	30.71	54	23.29
2390	30.03	AV	H	30.3	4.1	33.1	31.33	54	22.67
2390	40.74	PK	V	30.3	4.1	33.1	42.04	74	31.96
2390	39.71	PK	H	30.3	4.1	33.1	41.01	74	32.99
High Channel (2462MHz)									
2483.5	30.22	AV	V	31	4.4	32.7	32.92	54	21.08
2483.5	29.88	AV	H	31	4.4	32.7	32.58	54	21.42
2483.5	41.13	PK	V	31	4.4	32.7	43.83	74	30.17
2483.5	41.49	PK	H	31	4.4	32.7	44.19	74	29.81

**802.11g**

Indicated		result (PK/AV)	Antenna Polar (H/V)	Correction Factor			FCC Part 15.247		
Frequency (MHz)	Receiver Reading (dB $\mu$ V/m)			Ant. Factor (dB/m)	Cable Loss (dB)	Pre-Amp. Gain (dB)	Cord. Amp. (dB $\mu$ V/m)	Limit (dB $\mu$ V/m)	Margin (dB)
Low Channel (2412MHz)									
2390	30.56	AV	V	30.3	4.1	33.1	31.86	54	22.14
2390	31.23	AV	H	30.3	4.1	33.1	32.53	54	21.47
2390	40.97	PK	V	30.3	4.1	33.1	42.27	74	31.73
2390	41.60	PK	H	30.3	4.1	33.1	42.90	74	31.10
High Channel (2462MHz)									
2483.5	31.87	AV	V	31	4.4	32.7	34.57	54	19.43
2483.5	29.99	AV	H	31	4.4	32.7	32.69	54	21.31
2483.5	41.77	PK	V	31	4.4	32.7	44.47	74	29.53
2483.5	39.67	PK	H	31	4.4	32.7	42.37	74	31.63

Note: The BAND EDGE RESTRICTED BANDS emission is too low at least 20dB to the Fundamental.





For Question,  
Please Contact with WSCT  
art.com

802.11n HT20

Indicated		result (PK/AV)	Antenna Polar (H/V)	Correction Factor			FCC Part 15.247		
Frequency (MHz)	Receiver Reading (dBμV/m)			Ant. Factor (dB/m)	Cable Loss (dB)	Pre-Amp. Gain (dB)	Cord. Amp. (dBμV/m)	Limit (dBμV/m)	Margin (dB)
Low Channel (2412MHz)									
2390	35.11	AV	V	30.3	4.1	33.1	36.41	54	17.59
2390	33.66	AV	H	30.3	4.1	33.1	34.96	54	19.04
2390	52.23	PK	V	30.3	4.1	33.1	53.53	74	20.47
2390	49.36	PK	H	30.3	4.1	33.1	50.66	74	23.34
High Channel (2462MHz)									
2483.5	30.55	AV	V	31	4.4	32.7	33.25	54	20.75
2483.5	31.58	AV	H	31	4.4	32.7	34.28	54	19.72
2483.5	41.42	PK	V	31	4.4	32.7	44.12	74	29.88
2483.5	42.16	PK	H	31	4.4	32.7	44.86	74	29.14

Note: The BAND EDGE RESTRICTED BANDS emission is too low at least 20dB to the Fundamental.





For Question, Please Contact with WSCT www.wsct-cert.com

Band Edges Measurement:

802.11b:

Low channel

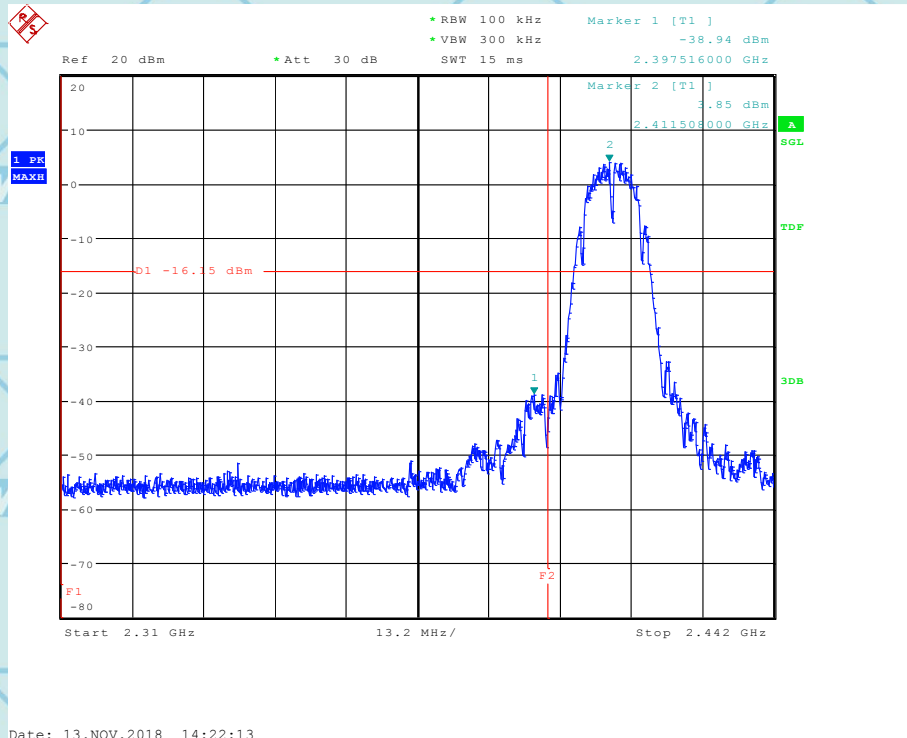

High channel

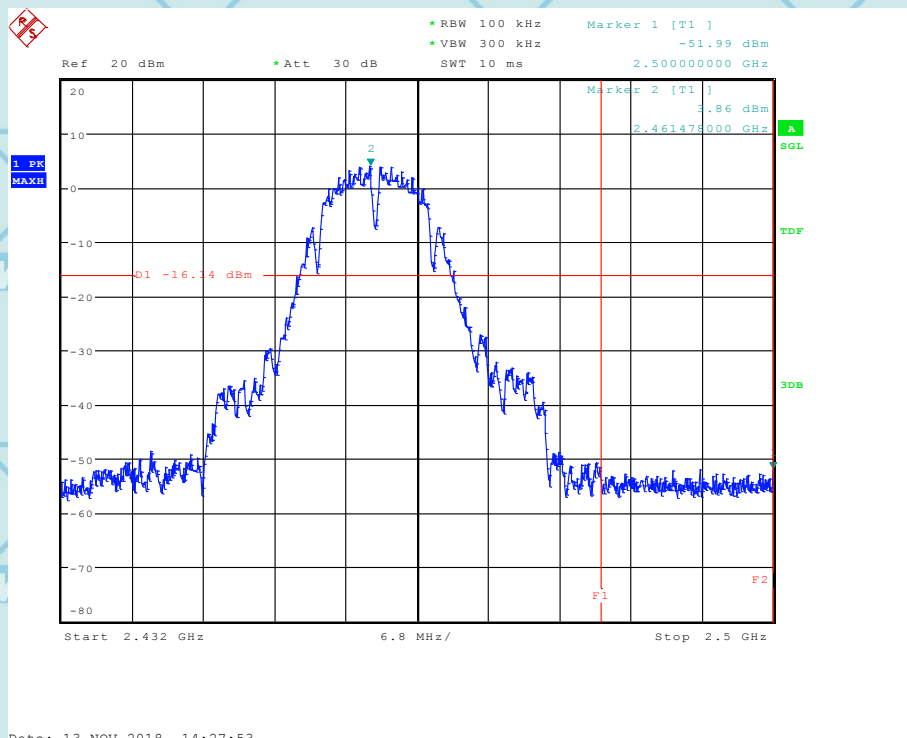



For Question, Please Contact with WSCT www.wsct-cert.com

802.11g:

Low channel

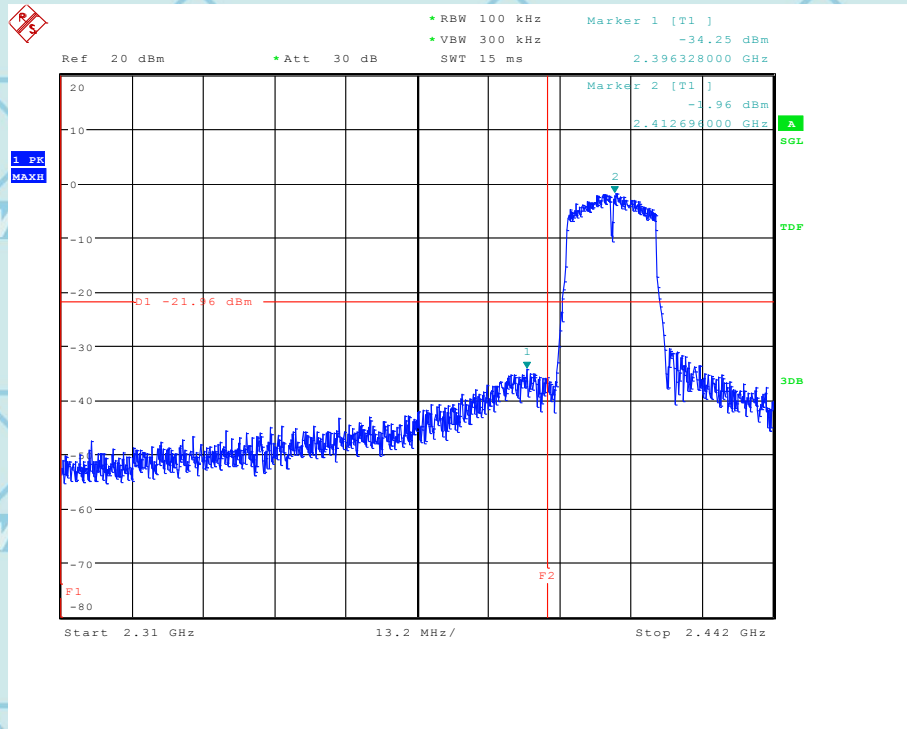

High channel

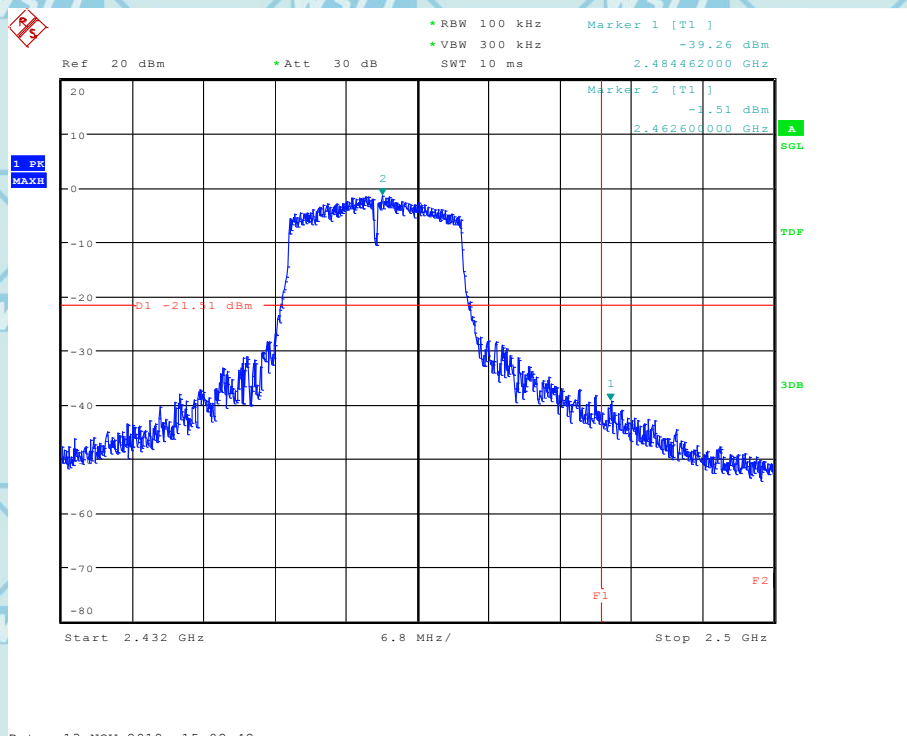

Date: 13.NOV.2018 15:02:42







For Question, Please Contact with WSCT www.wsct-cert.com

802.11n HT20:

Low channel

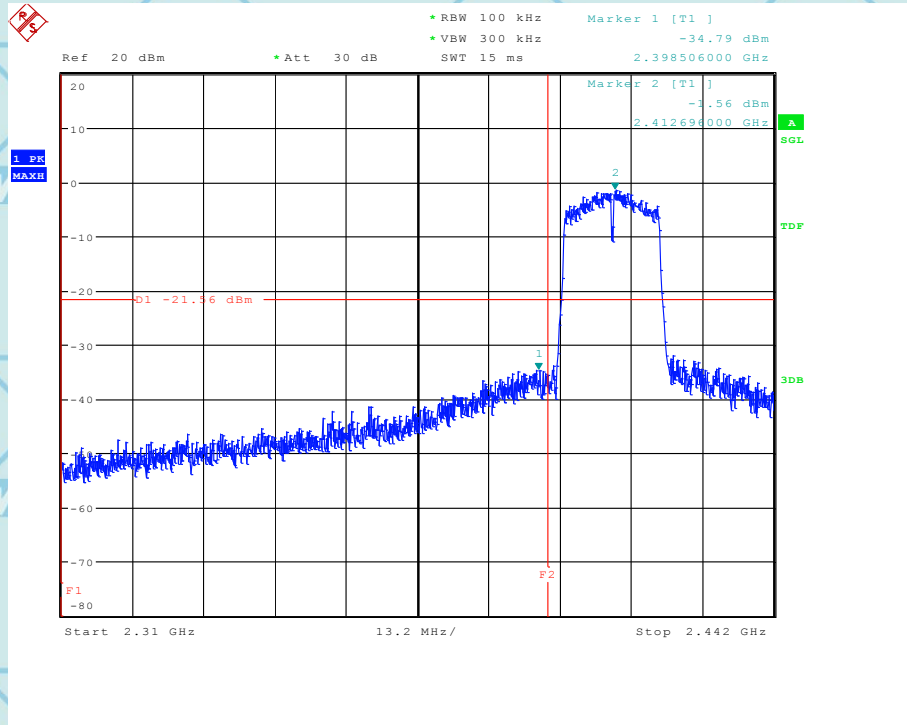

High channel

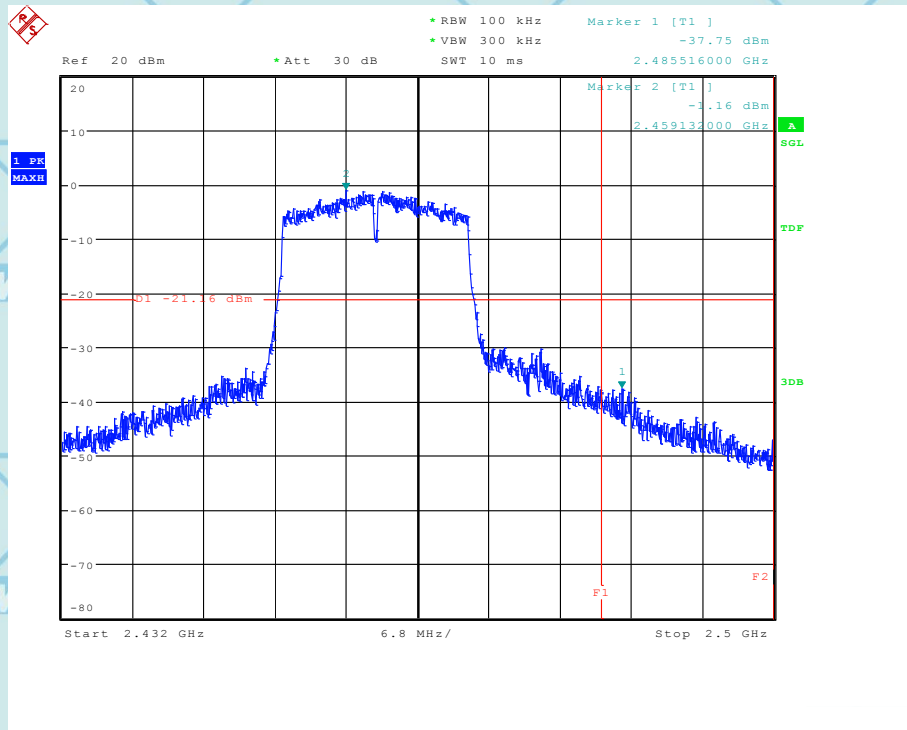

Date: 13 NOV 2018 15:12:48





For Question, Please Contact with WSCT www.wsct-cert.com

Conducted measurement: 802.11b:

Low channel

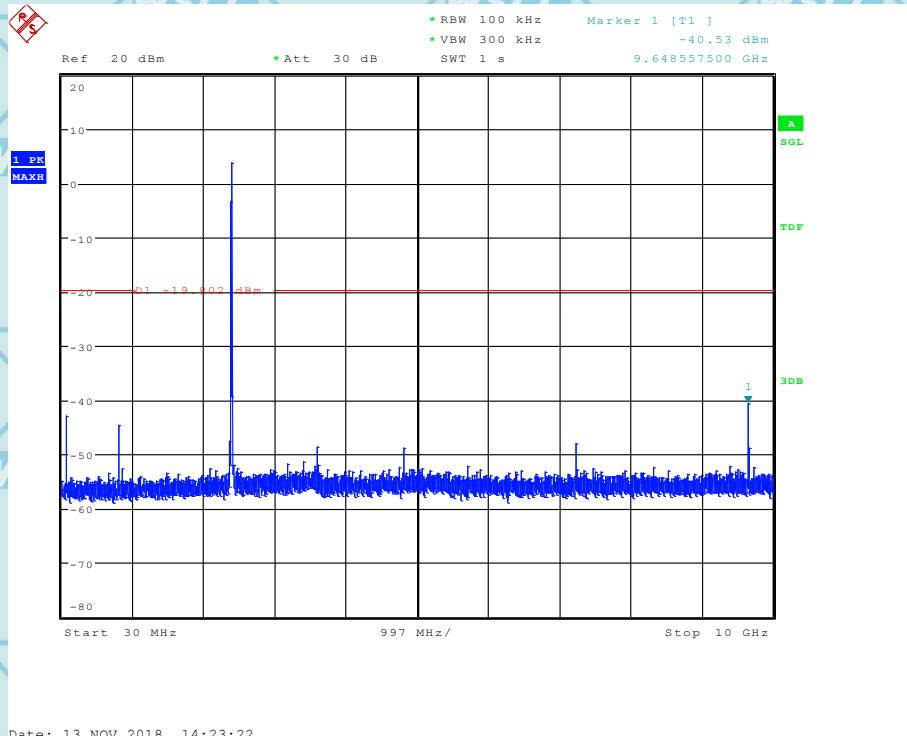

Middle channel

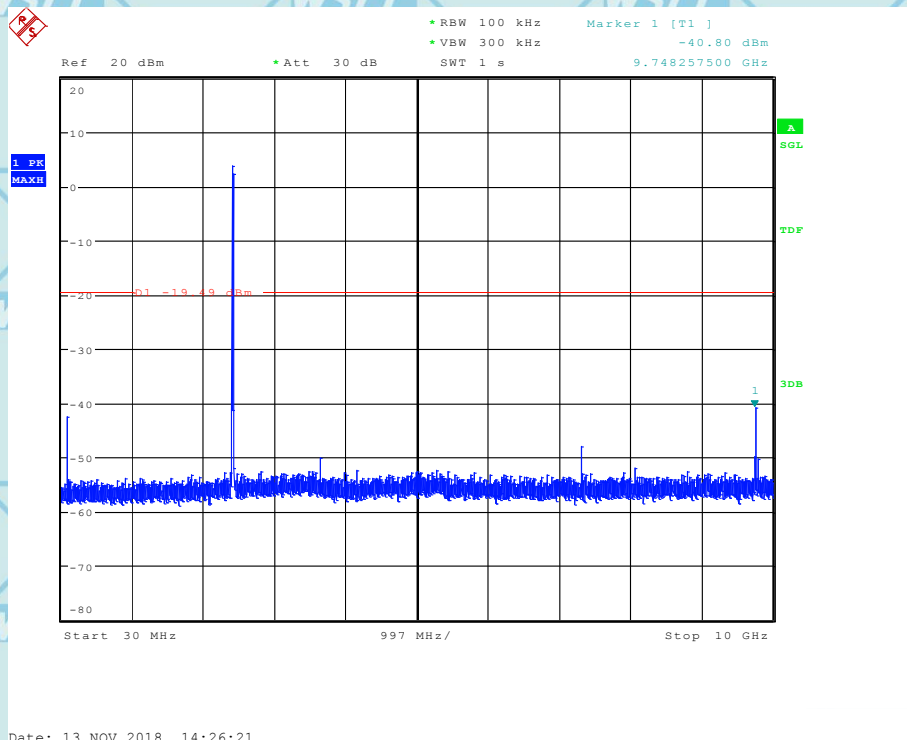



For Question, Please Contact with WSCT www.wsct-cert.com

High channel

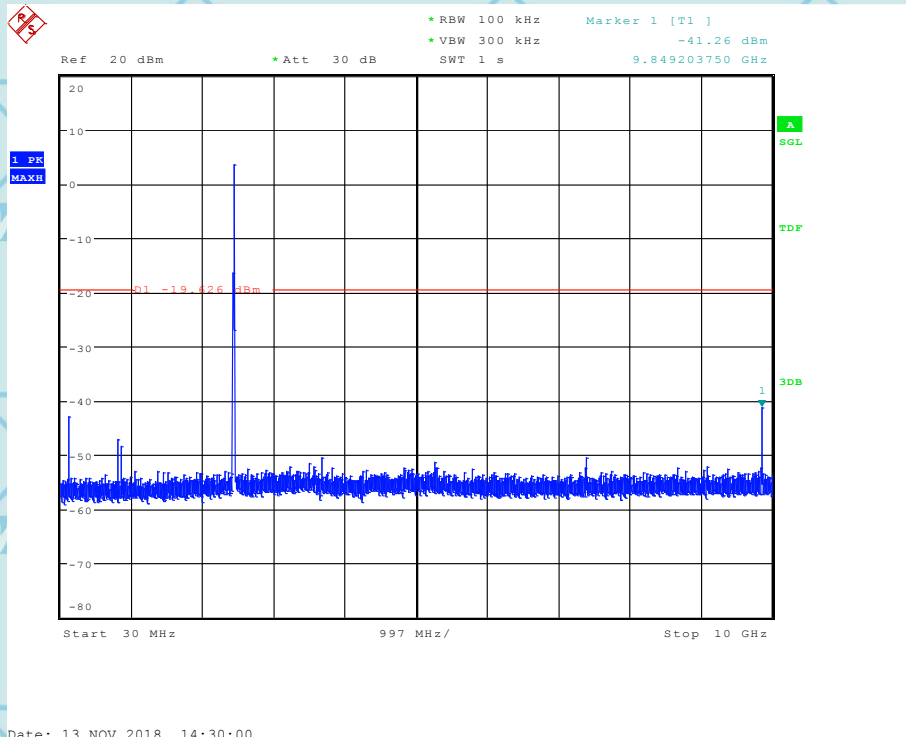

802.11g:

Low channel

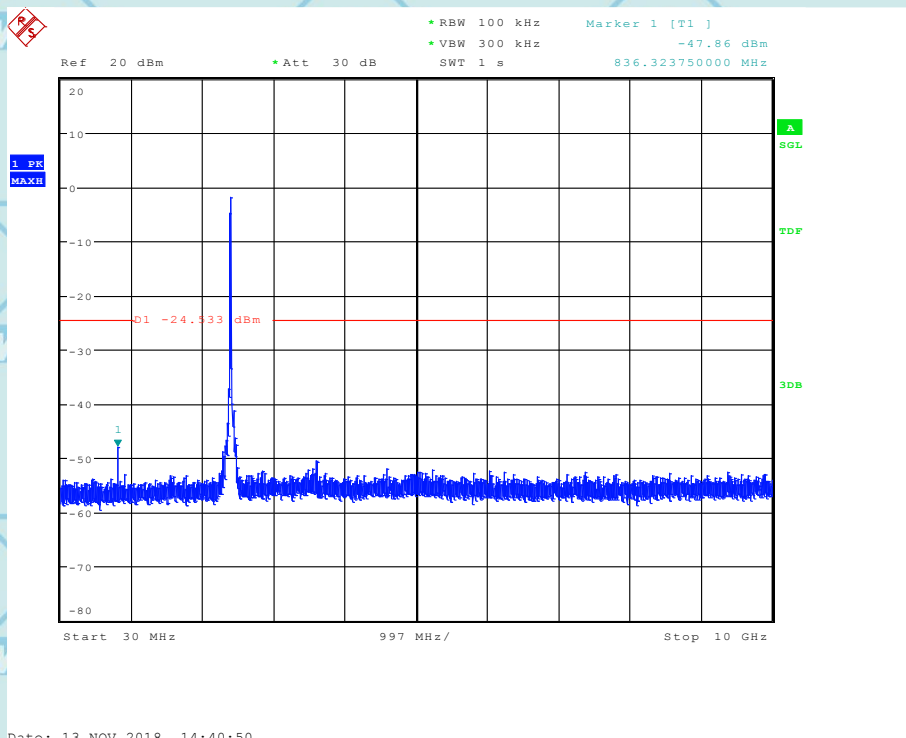



For Question, Please Contact with WSCT www.wsct-cert.com

Middle channel

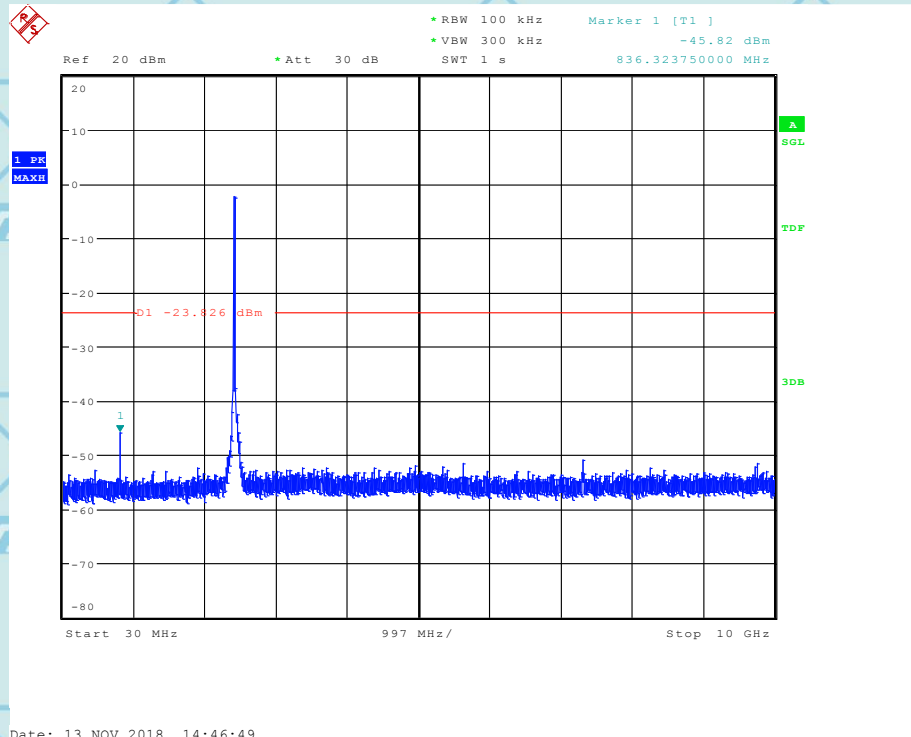

High channel

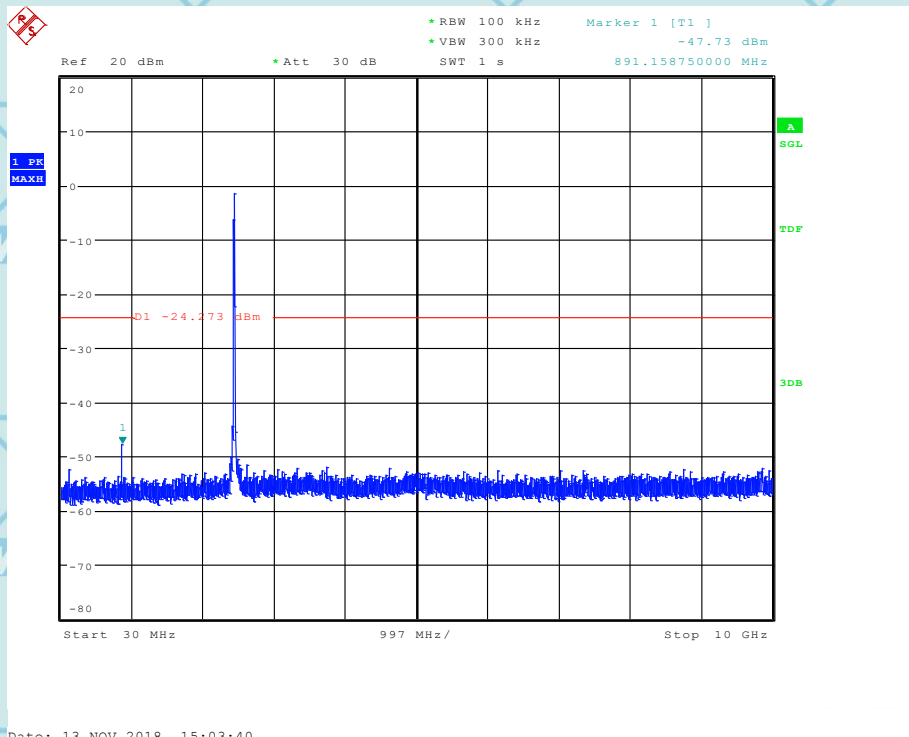



For Question, Please Contact with WSCT www.wsct-cert.com

802.11n HT20:

Low channel

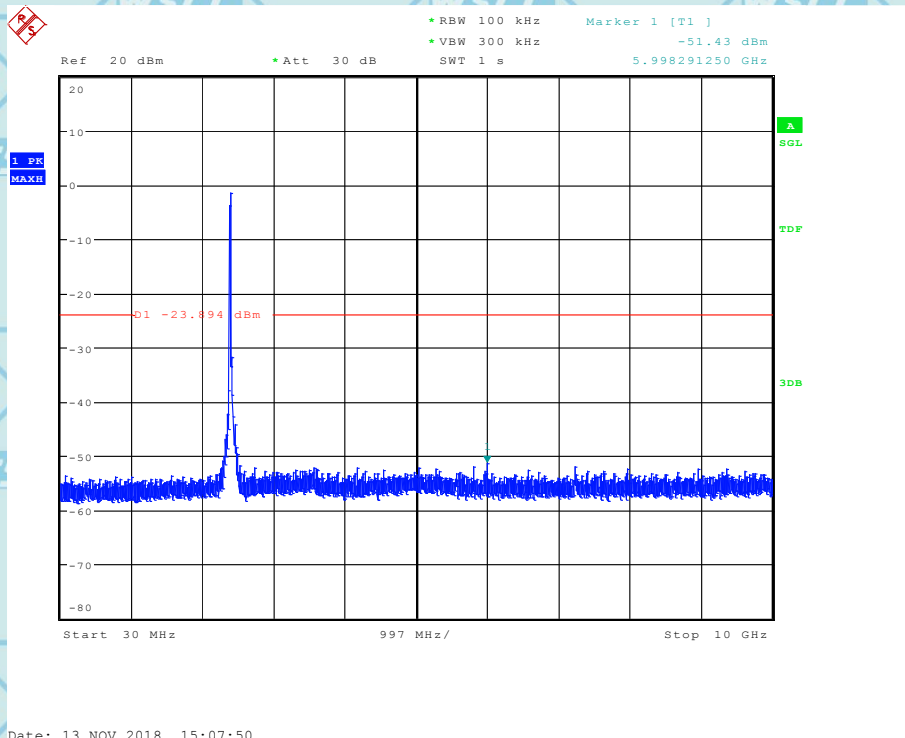

Middle channel

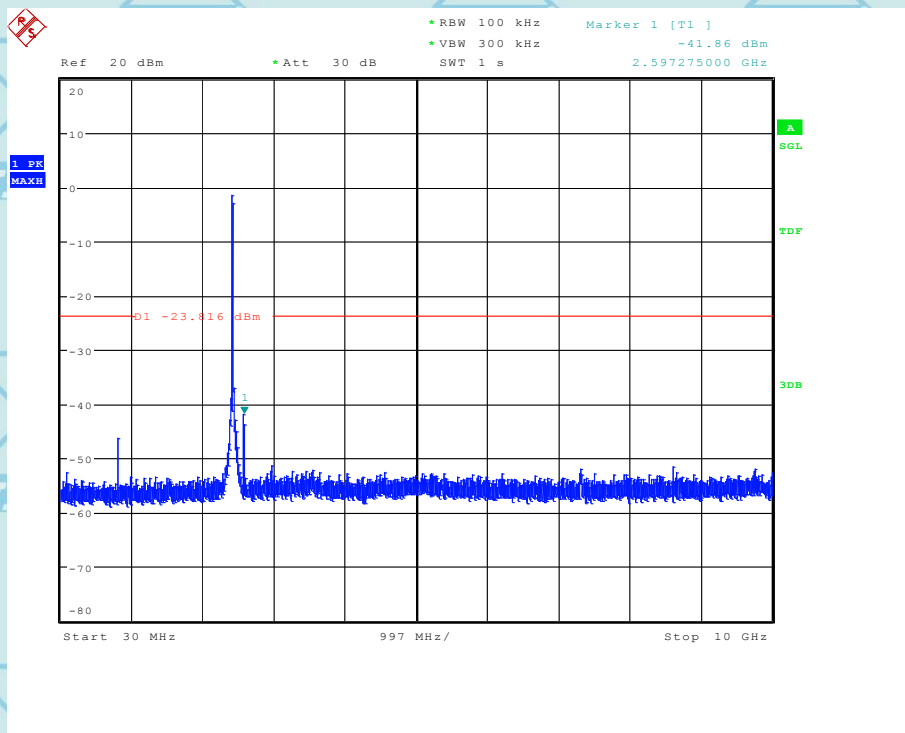



For Question, Please Contact with WSCT www.wsct-cert.com

High channel

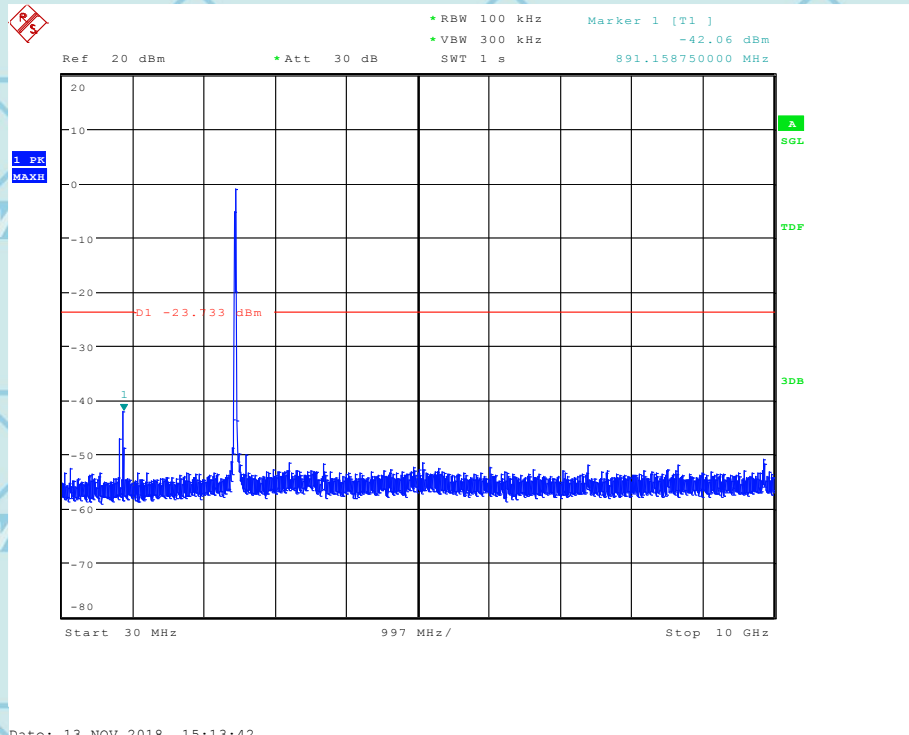

---END OF REPORT---

