



# FCC SAR Compliance Test Report

For

**TECNO MOBILE LIMITED**

**ROOMS 05-15, 13A/F., SOUTH TOWER, WORLD FINANCE CENTRE, HARBOUR CITY, 17**

**CANTON ROAD, TSIM SHA TSUI, KOWLOON, HONG KONG**

Model: B2

Test Engineer:	Hu Tong <i>Hu Tong</i>
Report Number:	FCC18110006A-SAR
Report Date:	Nov. 20, 2018
FCC ID:	2ADYY-B2
Check By:	Lily Zhao <i>Lily Zhao</i>
Approved By:	Wang Fengbing <i>Wang Fengbing</i>
Prepared By:	World Standardization Certification & Testing Group Co.,Ltd. Building A-B, Baoshi Science & Technology Park, Baoshi Road, Bao'an District, Shenzhen, Guangdong, China Tel: +86-755-26996192 Fax: +86-755-86376605





For Question,  
Please Contact with WSCT  
www.wsct-cert.com

## Table of contents

<b>1</b>	<b>General information</b> .....	<b>4</b>
1.1	Notes .....	4
1.2	Application details .....	4
1.3	Statement of Compliance.....	5
1.4	EUT Information .....	6
<b>2</b>	<b>Testing laboratory</b> .....	<b>7</b>
<b>3</b>	<b>Test Environment</b> .....	<b>7</b>
<b>4</b>	<b>Applicant and Manufacturer</b> .....	<b>7</b>
<b>5</b>	<b>Test standard/s:</b> .....	<b>8</b>
5.1	RF exposure limits.....	9
5.2	SAR Definition.....	10
<b>6</b>	<b>SAR Measurement System</b> .....	<b>11</b>
6.1	The Measurement System .....	11
6.2	Robot.....	12
6.3	Probe.....	12
6.4	Measurement procedure .....	13
6.5	Description of interpolation/extrapolation scheme.....	13
6.6	Phantom.....	14
6.7	Device Holder .....	15
6.8	Video Positioning System.....	16
6.9	Tissue simulating liquids: dielectric properties .....	17
6.10	Tissue simulating liquids: parameters .....	18
<b>7</b>	<b>System Check</b> .....	<b>20</b>
7.1	System check procedure .....	20
7.2	System check results .....	21
<b>8</b>	<b>SAR Test Test Configuration</b> .....	<b>22</b>
8.1	GSM Test Configurations.....	22
8.2	Wi-Fi Test Configuration.....	22





<b>9</b>	<b>Detailed Test Results</b> .....	<b>23</b>
9.1	Conducted Power measurements.....	23
9.1.1	Conducted Power of GSM850.....	23
9.1.2	Conducted Power of GSM1900.....	24
9.1.3	Conducted Power of UMTS Band II.....	25
9.1.4	Conducted Power of UMTS Band V .....	26
9.1.5	Conducted Power of Wi-Fi 2.4G .....	27
9.1.6	Conducted Power of BT .....	28
9.1.7	Tune-up power tolerance .....	29
9.2	SAR test results .....	30
9.2.1	Results overview of GSM850.....	32
9.2.2	Results overview of GSM1900.....	33
9.2.3	Results overview of UMTS Band II.....	34
9.2.4	Results overview of UMTS Band V .....	35
9.2.5	Results overview of Wi-Fi 2.4G .....	36
<b>10</b>	<b>Multiple Transmitter Information</b> .....	<b>37</b>
10.1.1	Stand-alone SAR test exclusion.....	38
10.1.2	Simultaneous Transmission Possibilities.....	39
10.1.3	SAR Summation Scenario .....	40
<b>11</b>	<b>Measurement uncertainty evaluation</b> .....	<b>44</b>
11.1	Measurement uncertainty evaluation for SAR test .....	44
11.2	Measurement uncertainty evaluation for system check.....	46
<b>12</b>	<b>Test equipment and ancillaries used for tests</b> .....	<b>48</b>
<b>Annex A:</b>	<b>System performance verification</b> .....	<b>49</b>
<b>Annex B:</b>	<b>Measurement results</b> .....	<b>49</b>
<b>Annex C:</b>	<b>Calibration reports</b> .....	<b>49</b>
<b>Annex D:</b>	<b>Photo documentation</b> .....	<b>49</b>





### Modified History

REV.	Modification Description	Issued Date	Remark
REV.1.0	Initial Test Report Relesse	Nov. 20, 2018	Wang Fengbing

## 1 General information

### 1.1 Notes

The test results of this test report relate exclusively to the test item specified in this test report. World Standardization Certification & Testing Group Co.,Ltd does not assume responsibility for any conclusions and generalisations drawn from the test results with regard to other specimens or samples of the type of the equipment represented by the test item. The test report is not to be reproduced or published in full without the prior written permission.

### 1.2 Application details

Date of receipt of test item: 2018-11-02  
 Start of test: 2018-11-12  
 End of test: 2018-11-13





### 1.3 Statement of Compliance

The maximum results of Specific Absorption Rate (SAR) found during testing for B2 is as below:

Band	Position	MAX Reported SAR <sub>1g</sub> (W/kg)
GSM850	Head	0.208
	Body & Hotspot 10mm	0.329
GSM1900	Head	0.016
	Body & Hotspot 10mm	0.071
UMTS Band II	Head	0.163
	Body & Hotspot 10mm	<b>0.710</b>
UMTS Band V	Head	0.136
	Body & Hotspot 10mm	0.236
Wi-Fi 2450	Head	<b>0.608</b>
	Body & Hotspot 10mm	0.166
The highest simultaneous SAR is 0.876W/kg per KDB690783 D01		

The device is in compliance with Specific Absorption Rate ( SAR ) for general population/uncontrolled exposure limits of 1.6 W/Kg as averaged over any 1g tissue according to the FCC rule §2.1093, the ANSI/IEEE C95.1:2005, the NCRP Report Number 86 for uncontrolled environment, according to the Industry Canada Radio Standards Specification RSS-102 for General Population/Uncontrolled exposure, and had been tested in accordance with the measurement methods and procedures specified in IEEE Std 1528-2013.





### 1.4 EUT Information

<b>Device Information:</b>			
<b>Product Type:</b>	Mobile Phone		
<b>Model:</b>	B2		
<b>Brand Name:</b>	TECNO		
<b>Device Type:</b>	Portable device		
<b>Exposure Category:</b>	uncontrolled environment / general population		
<b>Production Unit or Identical Prototype:</b>	Production Unit		
<b>Hardware version:</b>	V1.1		
<b>Software version :</b>	B2-F8017F-GO-180919V48		
<b>Antenna Type :</b>	Internal Antenna		
<b>Device Operating Configurations:</b>			
<b>Supporting Mode(s) :</b>	GSM850/1900, UMTS Band II /V,Wi-Fi , BT		
<b>Modulation:</b>	GSM(GMSK/8PSK),UMTS(QPSK/16QAM), WiFi(OFDM/CCK),BT(GFSK/π/4-DQPSK/ 8-DPSK), BLE(GFSK)		
<b>Device Class :</b>	Class B, No DTM Mode		
<b>Operating Frequency Range(s)</b>	Band	TX(MHz)	RX(MHz)
	GSM850	824~849	869~894
	GSM1900	1850~1910	1930~1990
	UMTS Band II	1850~1910	1930~1990
	UMTS Band V	824~840	869~894
	Wi-Fi	2412~2462	2412~2462
	BT	2402~2480	2402~2480
<b>GPRS class level:</b>	GPRS class 12		
<b>Test Channels (low-mid-high):</b>	128-190-251(GSM850)		
	512-661-810(GSM1900)		
	9262-9400-9538(UMTS Band II)		
	4132-4182-4233(UMTS Band V)		
	1-6-11 (Wi-Fi)		
	0-39-78(BT)		
	0-19-39(BLE)		
<b>Power Source:</b>	3.85 VDC/3000mAh/11.55Wh Rechargeable Battery		





## 2 Testing laboratory

Test Site	World Standardization Certification & Testing Group Co., Ltd.
Test Location	Building A-B, Baoshi Science & Technology Park, Baoshi Road, Bao'an District, Shenzhen, Guangdong, China
Telephone	+86-755-26996192
Fax	+86-755-86376605

## 3 Test Environment

	Required	Actual
Ambient temperature:	18 – 25 °C	22 ± 2 °C
Tissue Simulating liquid:	22 ± 2 °C	22 ± 2 °C
Relative humidity content:	30 – 70 %	30 – 70 %

## 4 Applicant and Manufacturer

<b>Applicant/Client Name:</b>	TECNO MOBILE LIMITED
<b>Applicant Address:</b>	ROOMS 05-15, 13A/F., SOUTH TOWER, WORLD FINANCE CENTRE, HARBOUR CITY, 17 CANTON ROAD, TSIM SHA TSUI, KOWLOON, HONG KONG
<b>Manufacturer Name:</b>	SHENZHEN TECNO TECHNOLOGY CO.,LTD.
<b>Manufacturer Address:</b>	1/F-4/F,7/F, BUILDING 3, TAIPINGYANG INDUSTRIAL ZONE, NO.2088, SHENYAN ROAD, YANTIAN DISTRICT, SHENZHEN CITY, GUANGDONG PROVINCE, P.R.C





## 5 Test standard/s:

ANSI Std C95.1-2005	Safety Levels with Respect to Human Exposure to Radio Frequency Electromagnetic Fields, 3 kHz to 300 GHz.
IEEE Std 1528-2013	Recommended Practice for Determining the Peak Spatial-Average Specific Absorption Rate (SAR) in the Human Head from Wireless Communications Devices: Measurement Techniques
RSS-102	Radio Frequency Exposure Compliance of Radiocommunication Apparatus (All Frequency Bands (Issue 5 March 2015)
KDB447498 D01	General RF Exposure Guidance v06
KDB648474 D04	Head set SAR v01r03
KDB941225 D06	Hot Spot SAR V02r01
KDB941225 D01	3G SAR Measurement Procedures
KDB248227 D01	SAR meas for 802.11 a/b/g v01r02
KDB865664 D01	SAR Measurement 100 MHz to 6 GHz v01r04
KDB865664 D02	RF Exposure Reporting v01r02







## 5.1 RF exposure limits

Human Exposure	Uncontrolled Environment General Population	Controlled Environment Occupational
<b>Spatial Peak SAR*</b> (Brain/Body/Arms/Legs)	<b>1.60 mW/g</b>	8.00 mW/g
<b>Spatial Average SAR**</b> (Whole Body)	0.08 mW/g	0.40 mW/g
<b>Spatial Peak SAR***</b> (Heads/Feet/Ankle/Wrist)	4.00 mW/g	20.00 mW/g

The limit applied in this test report is shown in bold letters

### Notes:

- \* The Spatial Peak value of the SAR averaged over any 1 gram of tissue (defined as a tissue volume in the shape of a cube) and over the appropriate averaging time.
- \*\* The Spatial Average value of the SAR averaged over the whole body.
- \*\*\* The Spatial Peak value of the SAR averaged over any 10 grams of tissue (defined as a tissue volume in the shape of a cube) and over the appropriate averaging time.

**Uncontrolled Environments** are defined as locations where there is the exposure of individuals who have no knowledge or control of their exposure.

**Controlled Environments** are defined as locations where there is exposure that may be incurred by persons who are aware of the potential for exposure, (i.e. as a result of employment or occupation).





## 5.2 SAR Definition

Specific Absorption Rate is defined as the time derivative (rate) of the incremental energy (dW) absorbed by(dissipated in) an incremental mass (dm) contained in a volume element (dV) of a given density (ρ).

$$SAR = \frac{d}{dt} \left( \frac{dW}{dm} \right) = \frac{d}{dt} \left( \frac{dW}{\rho dV} \right)$$

SAR is expressed in units of watts per kilogram (W/kg). SAR can be related to the electric field at a point by

$$SAR = \frac{\sigma |E|^2}{\rho}$$

where:

$\sigma$  = conductivity of the tissue (S/m)

$\rho$  = mass density of the tissue (kg/m<sup>3</sup>)

E = rms electric field strength (V/m)



## 6 SAR Measurement System

### 6.1 The Measurement System

Comosar is a system that is able to determine the SAR distribution inside a phantom of human being according to different standards. The Comosar system consists of the following items:

- Main computer to control all the system
- 6 axis robot
- Data acquisition system
- Miniature E-field probe
- Device holder
- Head simulating tissue

The following figure shows the system.



The EUT under test operating at the maximum power level is placed in the phone holder, under the phantom, which is filled with head simulating liquid. The E-Field probe measures the electric field inside the phantom. The OpenSAR software computes the results to give a SAR value in a 1g or 10g mass.



## 6.2 Robot

The COMOSAR system uses the high precision robots KR 6 R900 sixx type out of the newer series from Satimo SA (France).For the 6-axis controller COMOSAR system, the KUKA robot controller version from Satimo is used. The KR 6 R900 sixx robot series have many features that are important for our application:

- High precision (repeatability 0.02 mm)
- High reliability (industrial design)
- Jerk-free straight movements
- Low ELF interference (the closed metallic construction shields against motor control fields)
- 6-axis controller

## 6.3 Probe

For the measurements the Specific Dosimetric E-Field Probe SSE 5 with following specifications is used

- Dynamic range: 0.01-100 W/kg
- Tip Diameter : 5 mm
- Distance between probe tip and sensor center: 2.5mm
- Distance between sensor center and the inner phantom surface: 4 mm (repeatability better than +/- 1mm)
- Probe linearity: <0.25 dB
- Axial Isotropy: <0.25 dB
- Spherical Isotropy: <0.50 dB
- Calibration range: 300 to 3G for head & body simulating liquid.

Angle between probe axis (evaluation axis) and suface normal line:less than 30°



## 6.4 Measurement procedure

The following steps are used for each test position

- Establish a call with the maximum output power with a base station simulator. The connection between the mobile and the base station simulator is established via air interface.
- Measurement of the local E-field value at a fixed location. This value serves as a reference value for calculating a possible power drift.
- Measurement of the SAR distribution with a grid of 8 to 16 mm \* 8 to 16 mm and a constant distance to the inner surface of the phantom. Since the sensors can not directly measure at the inner phantom surface, the values between the sensors and the inner phantom surface are extrapolated. With these values the area of the maximum SAR is calculated by an interpolation scheme.
- Around this point, a cube of 30 \* 30 \* 30 mm or 32 \* 32 \* 32 mm is assessed by measuring 5 or 8 \* 5 or 8 \* 4 or 5 mm. With these data, the peak spatial-average SAR value can be calculated.

## 6.5 Description of interpolation/extrapolation scheme

- The local SAR inside the phantom is measured using small dipole sensing elements inside a probe body. The probe tip must not be in contact with the phantom surface in order to minimize measurement errors, but the highest local SAR will occur at the surface of the phantom.
- An extrapolation is used to determine these highest local SAR values. The extrapolation is based on a fourth-order least-square polynomial fit of measured data. The local SAR value is then extrapolated from the liquid surface with a 1 mm step.
- The measurements have to be performed over a limited time (due to the duration of the battery) so the step of measurement is high. It could vary between 5 and 8 mm. To obtain an accurate assessment of the maximum SAR average over 10 grams and 1 gram requires a very fine resolution in the three-dimensional scanned data array.





## 6.6 Phantom

For the measurements the Specific Anthropomorphic Mannequin (SAM) defined by the IEEE SCC-34/SC2 group is used. The phantom is a polyurethane shell integrated in a wooden table. The thickness of the phantom amounts to 2mm +/- 0.2mm. It enables the dosimetric evaluation of left and right phone usage and includes an additional flat phantom part for the simplified performance check. The phantom set-up includes a cover, which prevents the evaporation of the liquid.



System Material	Permittivity	Loss Tangent
Delrin	3.7	0.005





### 6.7 Device Holder

The positioning system allows obtaining cheek and tilting position with a very good accuracy. In compliance with CENELEC, the tilt angle uncertainty is lower than 1°.

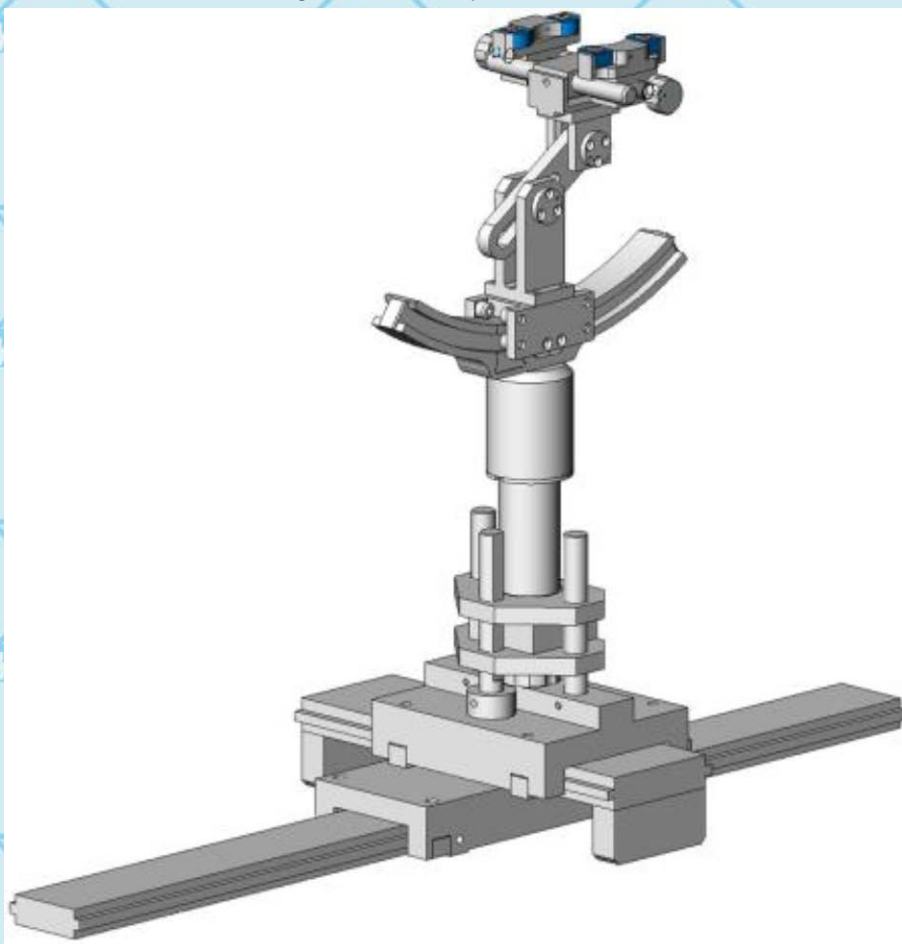

Device holder

System Material	Permittivity	Loss Tangent
Delrin	3.7	0.005





## 6.8 Video Positioning System

- The video positioning system is used in OpenSAR to check the probe. Which is composed of a camera, LED, mirror and mechanical parts. The camera is piloted by the main computer with firewire link.
- During the process, the actual position of the probe tip with respect to the robot arm is measured, as well as the probe length and the horizontal probe offset. The software then corrects all movements, such that the robot coordinates are valid for the probe tip.
- The repeatability of this process is better than 0.1 mm. If a position has been taught with an aligned probe, the same position will be reached with another aligned probe within 0.1 mm, even if the other probe has different dimensions. During probe rotations, the probe tip will keep its actual position.







## 6.9 Tissue simulating liquids: dielectric properties

The following materials are used for producing the tissue-equivalent materials.

(Liquids used for tests are marked with ☒):

Ingredients(% of weight)	Frequency (MHz)				
frequency band	<input type="checkbox"/> 450	<input checked="" type="checkbox"/> 835	<input type="checkbox"/> 1800	<input checked="" type="checkbox"/> 1900	<input checked="" type="checkbox"/> 2450
Tissue Type	Head	Head	Head	Head	Head
Water	38.56	41.45	52.64	55.242	62.7
Salt (NaCl)	3.95	1.45	0.36	0.306	0.5
Sugar	56.32	56.0	0.0	0.0	0.0
HEC	0.98	1.0	0.0	0.0	0.0
Bactericide	0.19	0.1	0.0	0.0	0.0
Triton X-100	0.0	0.0	0.0	0.0	36.8
DGBE	0.0	0.0	47.0	44.542	0.0
Ingredients(% of weight)	Frequency (MHz)				
frequency band	<input type="checkbox"/> 450	<input checked="" type="checkbox"/> 835	<input type="checkbox"/> 1800	<input checked="" type="checkbox"/> 1900	<input checked="" type="checkbox"/> 2450
Tissue Type	Body	Body	Body	Body	Body
Water	51.16	52.4	69.91	69.91	73.2
Salt (NaCl)	1.49	1.40	0.13	0.13	0.04
Sugar	46.78	45.0	0.0	0.0	0.0
HEC	0.52	1.0	0.0	0.0	0.0
Bactericide	0.05	0.1	0.0	0.0	0.0
Triton X-100	0.0	0.0	0.0	0.0	0.0
DGBE	0.0	0.0	29.96	29.96	26.7

Salt: 99+% Pure Sodium Chloride

Sugar: 98+% Pure Sucrose

Water: De-ionized, 16MΩ+ resistivity

HEC: Hydroxyethyl Cellulose

DGBE: 99+% Di(ethylene glycol) butyl ether, [2-(2-butoxyethoxy)ethanol]

Triton X-100(ultra pure): Polyethylene glycol mono [4-(1,1,3,3-tetramethylbutyl)phenyl]ether





### 6.10 Tissue simulating liquids: parameters

Tissue Type	Measured Frequency (MHz)	Target Tissue		Measured Tissue		Liquid Temp.	Test Date
		$\epsilon_r$ (+/-5%)	$\sigma$ (S/m) (+/-5%)	$\epsilon_r$	$\sigma$ (S/m)		
835MHz Head	825	41.50 (39.43~43.58)	0.90 (0.86~0.95)	40.56	0.94	21.6°C	2018/11/13
	835	41.50 (39.43~43.58)	0.90 (0.86~0.95)	40.44	0.95		
	850	41.50 (39.43~43.58)	0.90 (0.86~0.95)	40.33	0.95		
835MHz Body	825	55.20 (52.44~57.96)	0.97 (0.92~1.02)	53.86	0.95	21.6°C	2018/11/13
	835	55.20 (52.44~57.96)	0.97 (0.92~1.02)	53.76	0.96		
	850	55.20 (52.44~57.96)	0.97 (0.92~1.02)	53.50	0.98		
1900MHz Head	1850	40.00 (38.00~42.00)	1.40 (1.33~1.47)	40.54	1.38	21.6°C	2018/11/12
	1880	40.00 (38.00~42.00)	1.40 (1.33~1.47)	40.66	1.37		
	1900	40.00 (38.00~42.00)	1.40 (1.33~1.47)	39.88	1.41		
	1910	40.00 (38.00~42.00)	1.40 (1.33~1.47)	39.54	1.44		
1900MHz Body	1850	53.30 (50.64~55.97)	1.52 (1.44~1.60)	52.62	1.49	21.6°C	2018/11/12
	1880	53.30 (50.64~55.97)	1.52 (1.44~1.60)	51.47	1.57		
	1900	53.30 (50.64~55.97)	1.52 (1.44~1.60)	52.70	1.52		
	1910	53.30 (50.64~55.97)	1.52 (1.44~1.60)	53.63	1.54		
2450MHz Head	2410	39.30 (37.34~41.26)	1.76 (1.67~1.85)	39.29	1.88	21.6°C	2018/11/13
	2435	39.20 (37.24~41.16)	1.79 (1.70~1.88)	39.25	1.87		
	2450	39.20 (37.24~41.16)	1.80 (1.71~1.89)	39.27	1.85		
	2460	39.20 (37.24~41.16)	1.81 (1.72~1.90)	39.27	1.83		





For Question,  
Please Contact with WSCT  
www.wsct-cert.com

Report No.: FCC18110006A-SAR

2450MHz Body	2410	52.80 (50.16~55.44)	1.91 (1.81~2.01)	53.23	1.91	21.6°C	2018/11/13
	2435	52.70 (50.07~55.34)	1.94 (1.84~2.04)	53.05	1.90		
	2450	52.70 (50.07~55.34)	1.95 (1.85~2.05)	53.05	2.03		
	2460	52.70 (50.07~55.34)	1.96 (1.86~2.06)	53.01	2.04		
$\epsilon_r$ = Relative permittivity, $\sigma$ = Conductivity							





## 7 System Check

### 7.1 System check procedure

The System check is performed by using a System check dipole which is positioned parallel to the planar part of the SAM phantom at the reference point. The distance of the dipole to the SAM phantom is determined by a spacer. The dipole is connected to the signal source consisting of signal generator and amplifier via a directional coupler, N-connector cable and adaption to SMA. It is fed with a power of 100 mW. To adjust this power a power meter is used. The power sensor is connected to the cable before the System check to measure the power at this point and do adjustments at the signal generator. At the outputs of the directional coupler both return loss as well as forward power are controlled during the validation to make sure that emitted power at the dipole is kept constant. This can also be checked by the power drift measurement after the test (result on plot).

System check results have to be equal or near the values determined during dipole calibration (target SAR in table above) with the relevant liquids and test system.

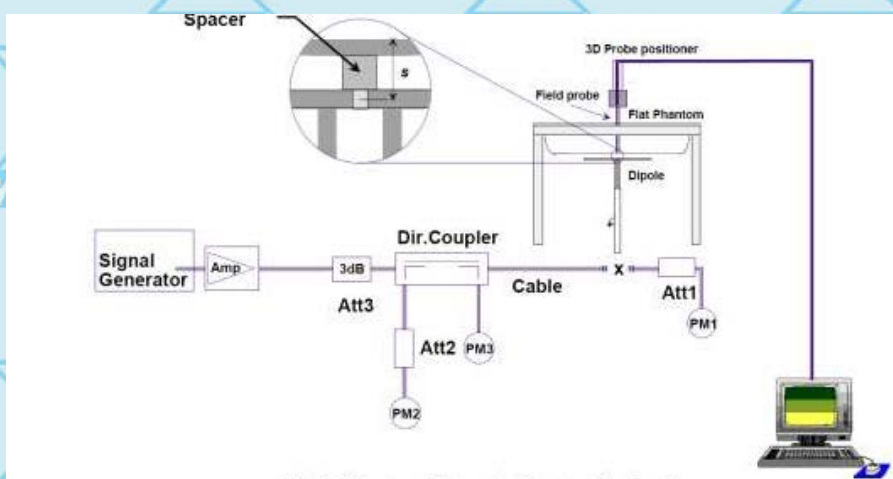



## 7.2 System check results

The system Check is performed for verifying the accuracy of the complete measurement system and performance of the software. The following table shows System check results for all frequency bands and tissue liquids used during the tests (plot(s) see annex A).

System Check	Target SAR (1W) (+/-10%)		Measured SAR (Normalized to 1W)		Liquid Temp.	Test Date
	1-g (mW/g)	10-g (mW/g)	1-g (mW/g)	10-g (mW/g)		
<b>D835V2 Head</b>	9.82 (8.83~10.80)	6.35 (5.71~6.98)	9.120	6.720	21.6°C	2018/11/13
<b>D1900V2 Head</b>	38.93 (35.93~43.92)	20.5 (18.45~22.55)	37.820	20.630	21.6°C	2018/11/12
<b>D2450V2 Head</b>	53.41 (48.06~58.75)	23.95 (21.55~26.34)	51.240	24.800	21.6°C	2018/11/13
<b>D835V2 Body</b>	9.41 (8.46~10.35)	6.22 (5.59~6.84)	8.460	6.300	21.6°C	2018/11/13
<b>D1900V2 Body</b>	38.73 (34.85~42.60)	20.48 (18.62~22.75)	37.200	20.470	21.6°C	2018/11/12
<b>D2450V2 Body</b>	51.39 (46.25~56.52)	23.63 (21.26~23.47)	47.280	23.290	21.6°C	2018/11/13

Note: All SAR values are normalized to 1W forward power.





## 8 SAR Test Test Configuration

### 8.1 GSM Test Configurations

SAR tests for GSM850 and GSM1900, a communication link is set up with a base station by air link. Using CMU200 the power lever is set to “5”and “0” in SAR of GSM850 and GSM1900. The tests in the band of GSM 850 and GSM 1900 are performed in the mode of GPRS/EGPRS function. Since the GPRS class is 12 for this EUT, it has at most 4 timeslots in uplink and at most 4 timeslots in downlink, the maximum total timeslot is 5.

### 8.2 Wi-Fi Test Configuration

For the 802.11b/g SAR tests, a communication link is set up with the test mode software for Wi-Fi mode test. The Absolute Radio Frequency Channel Number(ARFCN) is allocated to 1 ,6 and 11 respectively in the case of 2450 MHz.During the test,at the each test frequency channel, the EUT is operated at the RF continuous emission mode. Each channel should be tested at the lowest data rate. 802.11b/g operating modes are tested independently according to the service requirements in each frquency band. 802.11b/g modes are tested on channel 1, 6, 11; however,if output power reduction is necessary for channels 1 and/or 11 to meet restricted band requirements the highest output channel closest to each of these channels must be tested instead.

SAR is not required for 802.11g/n channels when the maximum average output power is less than 0.25dB higher than that measured on the corresponding 802.11b channels.

Mode	Band	GHz	Channel	“Default Test Channels”	
				802.11b	802.11g
802.11b/g	2.4 GHz	2412	1#	√	Δ
		2437	6	√	Δ
		2462	11#	√	Δ

**Notes:**

√ = “default test channels”

Δ= possible 802.11g channels with maximum average output ¼ dB the “default test channels”

# = when output power is reduced for channel 1 and /or 11 to meet restricted band requirements the highest output channels closest to each of these channels should be tested.

#### 802.11 Test Channels per FCC Requirements





## 9 Detailed Test Results

### 9.1 Conducted Power measurements

The output power was measured using an integrated RF connector and attached RF cable.

#### 9.1.1 Conducted Power of GSM850

GSM850(SIM1)		Burst-Averaged output Power (dBm)			Division Factors	Source Based time Average Power(dBm)		
		128CH	190CH	251CH		128CH	190CH	251CH
GSM(CS)		32.98	33.01	32.95	-9.03	23.95	23.98	23.92
GPRS (GMSK)	1 Tx Slot	32.73	32.68	32.76	-9.03	23.70	23.65	23.73
	2 Tx Slots	31.62	31.56	31.58	-6.02	25.60	25.54	25.56
	3 Tx Slots	30.69	30.59	30.66	-4.26	26.43	26.33	26.40
	4 Tx Slots	<b>29.98</b>	29.88	29.90	-3.01	<b>26.97</b>	<b>26.87</b>	<b>26.89</b>
EGPRS (8-PSK)	1 Tx Slot	28.75	28.74	28.72	-9.03	19.72	19.71	19.69
	2 Tx Slots	27.55	27.54	27.57	-6.02	21.53	21.52	21.55
	3 Tx Slots	26.39	26.42	26.45	-4.26	22.13	22.16	22.19
	4 Tx Slots	25.51	25.55	25.58	-3.01	<b>22.50</b>	<b>22.54</b>	<b>22.57</b>

GSM850(SIM2)		Burst-Averaged output Power (dBm)			Division Factors	Source Based time Average Power(dBm)		
		128CH	190CH	251CH		128CH	190CH	251CH
GSM(CS)		32.92	32.98	32.95	-9.03	23.89	23.95	23.92
GPRS (GMSK)	1 Tx Slot	32.69	32.66	32.68	-9.03	23.66	23.63	23.65
	2 Tx Slots	31.53	31.54	31.57	-6.02	25.51	25.52	25.55
	3 Tx Slots	30.48	30.52	30.55	-4.26	26.22	26.26	26.29
	4 Tx Slots	29.91	29.79	29.87	-3.01	<b>26.90</b>	<b>26.78</b>	<b>26.86</b>
EGPRS (8-PSK)	1 Tx Slot	28.67	28.63	28.62	-9.03	19.64	19.60	19.59
	2 Tx Slots	27.52	27.55	27.56	-6.02	21.50	21.53	21.54
	3 Tx Slots	26.38	26.39	26.43	-4.26	22.12	22.13	22.17
	4 Tx Slots	25.47	25.51	25.55	-3.01	22.46	22.50	22.54

Note: 1) The conducted power of GSM850 is measured with RMS detector.

2) Source Based time Average Power was calculated from the measured burst-averaged output power by converting the slot powers into linear units and calculating the energy over 8 timeslots.

3) The bolded GPRS 4Tx slots mode was selected for SAR testing according the highest Source Based time Average Power table.

4) channel /Frequency: 128/824.2; 190/836.6; 251/848.8





### 9.1.2 Conducted Power of GSM1900

GSM1900(SIM1)		Burst-Averaged output Power (dBm)			Division Factors	Source Based time Average Power(dBm)		
		512CH	661CH	810CH		512CH	661CH	810CH
GSM(CS)		29.89	29.90	29.95	-9.03	20.86	20.87	20.92
GPRS (GMSK)	1 Tx Slot	29.66	29.73	29.68	-9.03	20.63	20.70	20.65
	2 Tx Slots	28.56	28.65	28.61	-6.02	22.54	22.63	22.59
	3 Tx Slots	27.44	27.56	27.50	-4.26	23.18	23.30	23.24
	4 Tx Slots	26.89	<b>27.09</b>	26.98	-3.01	<b>23.88</b>	<b>24.08</b>	<b>23.97</b>
EGPRS (8-PSK)	1 Tx Slot	27.15	27.08	27.12	-9.03	18.12	18.05	18.09
	2 Tx Slots	26.57	26.62	26.65	-6.02	20.55	20.60	20.63
	3 Tx Slots	25.52	25.53	25.57	-4.26	21.26	21.27	21.31
	4 Tx Slots	24.48	24.51	24.56	-3.01	<b>21.47</b>	<b>21.50</b>	<b>21.55</b>

GSM1900(SIM2)		Burst-Averaged output Power (dBm)			Division Factors	Source Based time Average Power(dBm)		
		512CH	661CH	810CH		512CH	661CH	810CH
GSM(CS)		29.87	29.88	29.91	-9.03	20.84	20.85	20.88
GPRS (GMSK)	1 Tx Slot	29.62	29.69	29.66	-9.03	20.59	20.66	20.63
	2 Tx Slots	28.54	28.62	28.58	-6.02	22.52	22.60	22.56
	3 Tx Slots	27.46	27.49	27.47	-4.26	23.20	23.23	23.21
	4 Tx Slots	26.85	26.97	26.92	-3.01	<b>23.84</b>	<b>23.96</b>	<b>23.91</b>
EGPRS (8-PSK)	1 Tx Slot	27.02	27.06	27.07	-9.03	17.99	18.03	18.04
	2 Tx Slots	26.53	26.52	26.54	-6.02	20.51	20.50	20.52
	3 Tx Slots	25.47	25.46	25.48	-4.26	21.21	21.20	21.22
	4 Tx Slots	24.43	24.45	24.51	-3.01	21.42	21.44	21.50

Note: 1) The conducted power of GSM1900 is measured with RMS detector.

2) Source Based time Average Power was calculated from the measured burst-averaged output power by converting the slot powers into linear units and calculating the energy over 8 timeslots.

3) The bolded GPRS 4Tx slots mode was selected for SAR testing according the highest Source Based time Average Power table.

4) channel /Frequency: 512/1850.2; 661/1880; 810/1909.8







### 9.1.3 Conducted Power of UMTS Band II

UMTS Band II		Conducted Power (dBm)		
		9262CH	9400CH	9538CH
WCDMA	12.2kbps RMC	22.10	<b>22.22</b>	22.08
HSDPA	Subtest 1	22.02	22.11	22.00
	Subtest 2	21.95	21.99	21.88
	Subtest 3	21.82	21.90	21.80
	Subtest 4	21.76	21.79	21.75
HSUPA	Subtest 1	22.01	22.06	21.98
	Subtest 2	21.88	21.90	21.79
	Subtest 3	21.75	21.78	21.70
	Subtest 4	21.62	21.71	21.64
	Subtest 5	21.58	21.62	21.55

Note: 1) channel /Frequency: 9262/1852.4, 9400/1880, 9538/1907.6





### 9.1.4 Conducted Power of UMTS Band V

UMTS Band V		Conducted Power (dBm)		
		4132CH	4182CH	4233CH
WCDMA	12.2kbps RMC	<b>22.13</b>	22.10	<b>22.02</b>
HSDPA	Subtest 1	22.10	22.05	22.00
	Subtest 2	21.90	21.86	21.85
	Subtest 3	21.76	21.72	21.70
	Subtest 4	21.65	21.62	21.61
HSUPA	Subtest 1	22.07	22.02	22.01
	Subtest 2	21.88	21.85	21.90
	Subtest 3	21.81	21.78	21.82
	Subtest 4	21.67	21.69	21.76
	Subtest 5	21.60	21.62	21.70

Note: 1) channel /Frequency: 4132/826.4, 4182/836.4, 4233/846.6





### 9.1.5 Conducted Power of Wi-Fi 2.4G

Mode	802.11b		
Channel / Frequency (MHz)	1(2412)	6(2437)	11(2462)
Average Power(dBm)	17.34	<b>17.51</b>	17.31
Mode	802.11g		
Channel / Frequency (MHz)	1(2412)	6(2437)	11(2462)
Average Power(dBm)	15.08	15.55	15.76
Mode	802.11n(HT20)		
Channel / Frequency (MHz)	1(2412)	6(2437)	11(2462)
Average Power(dBm)	15.34	15.87	15.88

Note:

<KDB 248227 D01, SAR Guidance for Wi-Fi Transmitters>

(1) For handsets operating next to ear, hotspot mode or mini-tablet configurations, the initial test position procedures were applied. The test position with the highest extrapolated peak SAR will be used as the initial test position. When the reported SAR of initial test position is  $\leq 0.4$  W/kg, SAR testing for remaining test positions is not required. Otherwise, SAR is evaluated at the subsequent highest peak SAR positions until the reported SAR result is  $\leq 0.8$  W/kg or all test positions are measured.

(2) For Wi-Fi 2.4 GHz, the highest measured maximum output power channel for DSSS was selected for SAR measurement. When the reported SAR is  $\leq 0.8$  W/kg, no further SAR testing is required. Otherwise, SAR is evaluated at the next highest measured output power channel. When any reported SAR is  $> 1.2$  W/kg, SAR is required for the third channel. For OFDM modes (802.11g/n), SAR is not required when the highest reported SAR for DSSS is adjusted by the ratio of OFDM to DSSS specified maximum output power and it is  $\leq 1.2$  W/kg.





### 9.1.6 Conducted Power of BT

The maximum output power of BT is:

Mode		1Mbps		
Channel / Frequency (MHz)	0(2402)	39(2441)	78(2480)	
Average Power(dBm)	2.29	3.24	3.85	
Mode		2Mbps		
Channel / Frequency (MHz)	0(2402)	39(2441)	78(2480)	
Average Power(dBm)	1.44	2.25	2.87	
Mode		3Mbps		
Channel / Frequency (MHz)	0(2402)	39(2441)	78(2480)	
Average Power(dBm)	1.36	2.21	2.82	

The maximum output power of BLE is:

Mode		1Mbps		
Channel / Frequency (MHz)	0(2402)	39(2440)	78(2480)	
Average Power(dBm)	2.18	4.28	3.73	





### 9.1.7 Tune-up power tolerance

Band	Tune-up power tolerance(dBm)		
GSM850	GSM/GPRS (GMSK)	GSM	Max output power =33.0dBm±0.5dBm
		1TXslots	Max output power =32.5dBm±0.5dBm
		2TXslots	Max output power =31.5dBm±0.5dBm
		3TXslots	Max output power =30.5dBm±0.5dBm
		4TXslots	Max output power =29.5dBm±0.5dBm
GSM850	EGPRS (8-PSK)	1TXslots	Max output power =28.5dBm±0.5dBm
		2TXslots	Max output power =27.5dBm±0.5dBm
		3TXslots	Max output power =26.0dBm±0.5dBm
		4TXslots	Max output power =25.5dBm±0.5dBm
GSM1900	GSM/GPRS (GMSK)	GSM	Max output power =29.5dBm±0.5dBm
		1TXslots	Max output power =29.5dBm±0.5dBm
		2TXslots	Max output power =28.5dBm±0.5dBm
		3TXslots	Max output power =27.5dBm±0.5dBm
		4TXslots	Max output power =27.0dBm±0.5dBm
GSM1900	EGPRS (8-PSK)	1TXslots	Max output power =27.0dBm±0.5dBm
		2TXslots	Max output power =26.5dBm±0.5dBm
		3TXslots	Max output power =25.5dBm±0.5dBm
		4TXslots	Max output power =24.5dBm±0.5dBm
WCDMA 2	Max output power =21.5dbm±1.0dbm		
WCDMA 5	Max output power =21.5dbm±1.0dbm		
2.4G Wi-Fi	802.11b	Max output power =17.0±1.0dbm	
	802.11g	Max output power =15.0±1.0dbm	
	802.11n (HT20)	Max output power =15.0±1.0dbm	
BT	1Mbps Power	Max output power =3.0dBm±1dbm	
	2Mbps Power	Max output power =2.0dBm±1dbm	
	3Mbps Power	Max output power =2.0dBm±1dbm	
BLE	1Mbps Power	Max output power =3.5dBm±1dbm	





## 9.2 SAR test results

### Notes:

1) Per KDB447498 D01v05 r02, the SAR test shall be performed at the high, middle and low frequency channels of each operating mode. If the scaled SAR measured at mid-band channel for each test configuration is at least 3.0 dB lower than the SAR limit ( $< 0.8 \text{ W/kg}$ ), testing at the high and low channels is optional.

2) Per KDB447498 D01v05r02, testing of other required channels within the operating mode of a frequency band is not required when the reported 1-g or 10-g SAR for the mid-band or highest output power channel is:  $\leq 0.8 \text{ W/kg}$  or  $2.0 \text{ W/kg}$ , for 1-g or 10-g respectively, when the transmission band is  $\leq 100 \text{ MHz}$ . When the maximum output power variation across the required test channels is  $> \frac{1}{2} \text{ dB}$ , instead of the middle channel, the highest output power channel must be used.

3) Per KDB447498 D01v05r02, All measurement SAR result is scaled-up to account for tune-up tolerance is compliant.

4) Per KDB648474 D04v01r02, body-worn accessory testing is typically associated with voice operations. Therefore, GSM voice was evaluated for body-worn with headset SAR.

5) Per KDB248227 D01v01r02, the procedures required to establish specific device operating configurations for testing the SAR of 802.11 a/b/g transmitters.

6) Per KDB865664 D01v01r04, for each frequency band, repeated SAR measurement is required only when the measured SAR is  $\geq 0.8 \text{ W/Kg}$ ; if the deviation among the repeated measurement is  $\leq 20\%$ , and the measured SAR  $< 1.45 \text{ W/Kg}$ , only one repeated measurement is required.

7) Per KDB865664 D02v01r01, SAR plot is only required for the highest measured SAR in each exposure configuration, wireless mode and frequency band combination; Plots are also required when the measured SAR is  $> 1.5 \text{ W/kg}$ , or  $> 7.0 \text{ W/kg}$  for occupational exposure. The published RF exposure KDB procedures may require additional plots; for example, to support SAR to peak location separation ratio test exclusion and/or volume scan post-processing (Refer to appendix B for details).





8) Per KDB941225 D06v01r01, the DUT Dimension is bigger than 9 cm x 5 cm, so 10mm is chosen as the test separation distance for Hotspot mode. When the antenna-to-edge distance is greater than 2.5cm, such position does not need to be tested.

9) KDB 941225 D01, 3G SAR Measurement Procedures, The mode tested for SAR is referred to as the primary mode. The equivalent modes considered for SAR test reduction are denoted as secondary modes. Both primary and secondary modes must be in the same frequency band. When the maximum output power and tune-up tolerance specified for production units in a secondary mode is  $\leq 1/4$  dB higher than the primary mode or when the highest reported SAR of the primary mode is scaled by the ratio of specified maximum output power and tune-up tolerance of secondary to primary mode and the adjusted SAR is  $\leq 1.2$  W/kg, SAR measurement is not required for the secondary mode.





### 9.2.1 Results overview of GSM850

Test Position of Head	Test channel /Freq.(MHz)	Test Mode	SAR Value (W/kg)		Power Drift (%)	Conducted Power (dBm)	Tune-up Limit (dBm)	Scaled SAR <sub>1-g</sub> (W/kg)	Scaling Factor
			1-g	10-g					
Left Hand Touched	128/824.2	GPRS 4TS	0.207	0.152	2.760	29.980	30.000	<b>0.208</b>	1.005
Left Hand Tilted 15°	128/824.2	GPRS 4TS	0.126	0.091	0.770	29.980	30.000	0.127	1.005
Right Hand Touched	128/824.2	GPRS 4TS	0.193	0.144	4.520	29.980	30.000	0.194	1.005
Right Hand Tilted 15°	128/824.2	GPRS 4TS	0.102	0.075	-1.740	29.980	30.000	0.102	1.005
Test Position of Body with 10mm	Test channel /Freq.(MHz)	Test Mode	SAR Value (W/kg)		Power Drift (%)	Conducted Power (dBm)	Tune-up Limit (dBm)	Scaled SAR <sub>1-g</sub> (W/kg)	Scaling Factor
			1-g	10-g					
<b>SAR Results for Hotspot Exposure Condition</b>									
Front side	128/824.2	GPRS 4TS	0.184	0.137	-1.200	29.980	30.000	0.185	1.005
Rear side	128/824.2	GPRS 4TS	0.327	0.245	1.080	29.980	30.000	<b>0.329</b>	1.005
Left side	128/824.2	GPRS 4TS	0.187	0.129	-0.470	29.980	30.000	0.188	1.005







### 9.2.2 Results overview of GSM1900

Test Position of Head	Test channel /Freq.(MHz)	Test Mode	SAR Value (W/kg)		Power Drift (%)	Conducted Power (dBm)	Tune-up Limit (dBm)	Scaled SAR <sub>1-g</sub> (W/kg)	Scalig Factor
			1-g	10-g					
Left Hand Touched	661/1880	GPRS 4TS	0.013	0.007	-2.250	27.090	27.500	0.014	1.099
Left Hand Tilted 15°	661/1880	GPRS 4TS	0.015	0.007	-1.580	27.090	27.500	<b>0.016</b>	1.099
Right Hand Touched	661/1880	GPRS 4TS	0.014	0.007	-4.150	27.090	27.500	0.015	1.099
Right Hand Tilted 15°	661/1880	GPRS 4TS	0.008	0.006	-0.420	27.090	27.500	0.009	1.099
Test Position of Body with 10mm	Test channel /Freq.(MHz)	Test Mode	SAR Value (W/kg)		Power Drift (%)	Conducted Power (dBm)	Tune-up Limit (dBm)	Scaled SAR <sub>1-g</sub> (W/kg)	Scalig Factor
			1-g	10-g					
<b>SAR Results for Hotspot Exposure Condition</b>									
Front side	661/1880	GPRS 4TS	0.041	0.021	0.310	27.090	27.500	0.045	1.099
Rear side	661/1880	GPRS 4TS	0.065	0.030	-2.190	27.090	27.500	<b>0.071</b>	1.099
Left side	661/1880	GPRS 4TS	0.019	0.010	1.720	27.090	27.500	0.021	1.099





### 9.2.3 Results overview of UMTS Band II

Test Position of Head	Test channel /Freq.(MHz)	Test Mode	SAR Value (W/kg)		Power Drift (%)	Conducted Power (dBm)	Tune-up Limit (dBm)	Scaled SAR <sub>1-g</sub> (W/kg)	Scalig Factor
			1-g	10-g					
Left Hand Touched	9400/1880	RMC	0.153	0.074	-3.340	22.220	22.500	<b>0.163</b>	1.067
Left Hand Tilted 15°	9400/1880	RMC	0.088	0.043	-0.630	22.220	22.500	0.094	1.067
Right Hand Touched	9400/1880	RMC	0.123	0.058	0.080	22.220	22.500	0.131	1.067
Right Hand Tilted 15°	9400/1880	RMC	0.061	0.028	-0.570	22.220	22.500	0.065	1.067
Test Position of Body with 10mm	Test channel /Freq.(MHz)	Test Mode	SAR Value (W/kg)		Power Drift (%)	Conducted Power (dBm)	Tune-up Limit (dBm)	Scaled SAR <sub>1-g</sub> (W/kg)	Scalig Factor
			1-g	10-g					
<b>SAR Results for Hotspot Exposure Condition</b>									
Front side	9400/1880	RMC	0.359	0.177	-1.110	22.220	22.500	0.383	1.067
Rear side	9400/1880	RMC	0.666	0.297	-0.890	22.220	22.500	<b>0.710</b>	1.067
Left side	9400/1880	RMC	0.219	0.105	-4.110	22.220	22.500	0.234	1.067





### 9.2.4 Results overview of UMTS Band V

Test Position of Head	Test channel /Freq.(MHz)	Test Mode	SAR Value (W/kg)		Power Drift (%)	Conducted Power (dBm)	Tune-up Limit (dBm)	Scaled SAR <sub>1-g</sub> (W/kg)	Scalig Factor
			1-g	10-g					
Left Hand Touched	4132/826.4	RMC	0.125	0.094	-2.680	22.130	22.500	<b>0.136</b>	1.089
Left Hand Tilted 15°	4132/826.4	RMC	0.072	0.054	-1.660	22.130	22.500	0.078	1.089
Right Hand Touched	4132/826.4	RMC	0.117	0.088	-1.030	22.130	22.500	0.127	1.089
Right Hand Tilted 15°	4132/826.4	RMC	0.065	0.050	-0.070	22.130	22.500	0.071	1.089
Test Position of Body with 10mm	Test channel /Freq.(MHz)	Test Mode	SAR Value (W/kg)		Power Drift (%)	Conducted Power (dBm)	Tune-up Limit (dBm)	Scaled SAR <sub>1-g</sub> (W/kg)	Scalig Factor
			1-g	10-g					
<b>SAR Results for Hotspot Exposure Condition</b>									
Front side	4132/826.4	RMC	0.105	0.078	-0.680	22.130	22.500	0.114	1.089
Rear side	4132/826.4	RMC	0.217	0.159	-1.230	22.130	22.500	<b>0.236</b>	1.089
Left side	4132/826.4	RMC	0.105	0.072	-1.200	22.130	22.500	0.114	1.089





### 9.2.5 Results overview of Wi-Fi 2.4G

Test Position of Head	Test channel /Freq.(MHz)	Test Mode	SAR Value (W/kg)		Power Drift (%)	Conducted Power (dBm)	Tune-up Limit (dBm)	Scaled SAR <sub>1-g</sub> (W/kg)	Scaling Factor
			1-g	10-g					
Left Hand Touched	6/2437	802.11b	0.379	0.158	-0.250	17.510	18.000	0.424	1.119
Left Hand Tilted 15°	6/2437	802.11b	0.231	0.098	-0.520	17.510	18.000	0.259	1.119
Right Hand Touched	6/2437	802.11b	0.543	0.216	0.240	17.510	18.000	<b>0.608</b>	1.119
Right Hand Tilted 15°	6/2437	802.11b	0.308	0.125	-0.020	17.510	18.000	0.345	1.119
Test Position of Body with 10mm	Test channel /Freq.(MHz)	Test Mode	SAR Value (W/kg)		Power Drift (%)	Conducted Power (dBm)	Tune-up Limit (dBm)	Scaled SAR <sub>1-g</sub> (W/kg)	Scaling Factor
			1-g	10-g					
<b>SAR Results for Hotspot Exposure Condition</b>									
Front side	6/2437	802.11b	0.139	0.063	-1.880	17.510	18.000	0.156	1.119
Rear side	6/2437	802.11b	0.148	0.067	-1.010	17.510	18.000	<b>0.166</b>	1.119
Left side	6/2437	802.11b	0.025	0.012	-1.290	17.510	18.000	0.028	1.119





### 10 Multiple Transmitter Information

The SAR measurement positions of each side are as below:

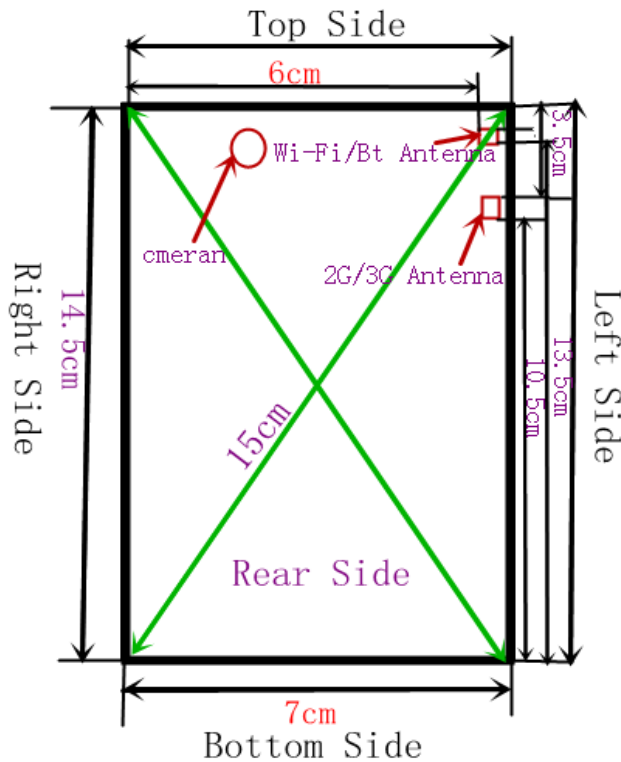

Mode	Front Side	Rear Side	Left Side	Right Side	Top Side	Bottom Side
2G/3G Antenna	Yes	Yes	Yes	No	No	No
Wi-Fi	Yes	Yes	Yes	No	Yes	No

1) Per KDB941225 D06v01r01, the DUT Dimension is bigger than 9 cm x 5 cm, so 10mm is chosen as the test separation distance for Hotspot mode. When the antenna-to-edge distance is greater than 2.5cm, such position does not need to be tested.





### 10.1.1 Stand-alone SAR test exclusion

The 1-g and 10-g SAR test exclusion thresholds for 100 MHz to 6 GHz at test separation distances  $\leq$  50 mm are determined by:

$[(\text{max. power of channel, including tune-up tolerance, mW}) / (\text{min. test separation distance, mm})] \cdot [\sqrt{f(\text{GHz})}] \leq 3.0$  for 1-g SAR and  $\leq 7.5$  for 10-g extremity SAR, where

- $f(\text{GHz})$  is the RF channel transmit frequency in GHz
- Power and distance are rounded to the nearest mW and mm before calculation
- The result is rounded to one decimal place for comparison

When the minimum test separation distance is  $< 5$  mm, a distance of 5 mm is applied to determine SAR test exclusion.

Head position

Mode	Pmax(dBm)	Pmax(mW)	Distance(mm)	f(GHz)	Calculation Result	exclusion Threshold	SAR test exclusion
BLE	4.50	2.82	5.00	2.45	0.88	3.00	Yes

Body-Worn position

Mode	Pmax(dBm)	Pmax(mW)	Distance(mm)	f(GHz)	Calculation Result	exclusion Threshold	SAR test exclusion
BLE	4.50	2.82	10.00	2.45	0.44	3.00	Yes





When the standalone SAR test exclusion applies to an antenna that transmits simultaneously with other antennas, the standalone SAR must be estimated according to the following to determine simultaneous transmission SAR test exclusion

$(\text{max. power of channel, including tune-up tolerance, mW}) / (\text{min. test separation distance, mm}) \cdot [\sqrt{f(\text{GHz})} / x] \text{ W/kg}$  for test separation distances  $\leq 50 \text{ mm}$ , where  $x = 7.5$  for 1-g SAR.

When the minimum test separation distance is  $< 5 \text{ mm}$ , a distance of  $5 \text{ mm}$  is applied to determine SAR test exclusion.

Mode	Position	Pmax(dBm)	Pmax(mW)	Distance(mm)	f(GHz)	X	Estimated SAR(W/Kg)
BLE	Head	4.50	2.82	5.00	2.45	7.50	0.118
BLE	Body	4.50	2.82	10.00	2.45	7.50	0.059

### 10.1.2 Simultaneous Transmission Possibilities

The Simultaneous Transmission Possibilities are as below:

Simultaneous Transmission Possibilities				
Simultaneous Tx Combination	Configuration	Head	Body	Hotspot
1	GSM/GPRS/UMTS +Wi-Fi	YES	YES	YES
	GSM/GPRS/UMTS +BLE	YES	YES	YES

Note: The device does not support simultaneous BT and Wi-Fi ,because the BT and Wi-Fi share the same antenna and can't transmit simultaneously.





### 10.1.3 SAR Summation Scenario

Test Position		Scaled SAR <sub>Max</sub>		Σ <sub>1-g</sub> SAR	SPLSP
		GSM850	Wi-Fi		
Head	Left Head Touched	0.208	0.424	0.632	NA
	Left Head Tilted 15°	0.127	0.259	0.386	NA
	Right Head Touched	0.194	0.608	<b>0.802</b>	NA
	Right Head Tilted 15°	0.102	0.345	0.447	NA
Body Hotspot	Front side	0.185	0.156	0.341	NA
	Rear side	0.329	0.166	0.495	NA
	Top side	/	0.056	0.056	NA
	Left side	0.188	0.028	0.216	NA

Note: Simultaneous Tx Combination of GSM850 and Wi-Fi

Test Position		Scaled SAR <sub>Max</sub>		Σ <sub>1-g</sub> SAR	SPLSP
		GSM1900	Wi-Fi		
Head	Left Head Touched	0.014	0.424	0.438	NA
	Left Head Tilted 15°	0.016	0.259	0.275	NA
	Right Head Touched	0.015	0.608	<b>0.623</b>	NA
	Right Head Tilted 15°	0.009	0.345	0.354	NA
Body Hotspot	Front side	0.045	0.156	0.201	NA
	Rear side	0.071	0.166	0.237	NA
	Top side	/	0.056	0.056	NA
	Left side	0.021	0.028	0.049	NA

Note: Simultaneous Tx Combination of GSM1900 and Wi-Fi

Test Position		Scaled SAR <sub>Max</sub>		Σ <sub>1-g</sub> SAR	SPLSP
		UMTS Band II	Wi-Fi		
Head	Left Head Touched	0.163	0.424	0.587	NA
	Left Head Tilted 15°	0.094	0.259	0.353	NA
	Right Head Touched	0.131	0.608	0.739	NA
	Right Head Tilted 15°	0.065	0.345	0.410	NA
Body Hotspot	Front side	0.383	0.156	0.539	NA
	Rear side	0.710	0.166	<b>0.876</b>	NA
	Top side	/	0.056	0.056	NA
	Left side	0.234	0.028	0.262	NA

Note: Simultaneous Tx Combination of UMTS Band II and Wi-Fi







Test Position	Scaled SAR <sub>Max</sub>		Σ <sub>1-g</sub> SAR	SPLSP	
	UMTS Band V	Wi-Fi			
Head	Left Head Touched	0.136	0.424	0.560	NA
	Left Head Tilted 15°	0.078	0.259	0.337	NA
	Right Head Touched	0.127	0.608	<b>0.735</b>	NA
	Right Head Tilted 15°	0.071	0.345	0.416	NA
Body Hotspot	Front side	0.114	0.156	0.270	NA
	Rear side	0.236	0.166	0.402	NA
	Top side	/	0.056	0.056	NA
	Left side	0.114	0.028	0.142	NA

Note: Simultaneous Tx Combination of UMTS Band V and Wi-Fi

MAX.ΣSAR<sub>1g</sub> = 0.876W/kg < 1.6 W/kg, so the Simultaneous SAR is not required for Wi-Fi and GSM&UMTS antenna.





Test Position		Scaled SAR <sub>Max</sub>		Σ <sub>1-g</sub> SAR	SPLSP
		GSM850	BT		
Head	Left Head Touched	0.208	0.118	0.326	NA
	Left Head Tilted 15°	0.127	0.118	0.245	NA
	Right Head Touched	0.194	0.118	0.312	NA
	Right Head Tilted 15°	0.102	0.118	0.220	NA
Body Hotspot	Front side	0.185	0.059	0.244	NA
	Rear side	0.329	0.059	<b>0.388</b>	NA
	Top side	/	0.059	0.059	NA
	Left side	0.188	0.059	0.247	NA

Note: Simultaneous Tx Combination of GSM850 and BT

Test Position		Scaled SAR <sub>Max</sub>		Σ <sub>1-g</sub> SAR	SPLSP
		GSM1900	BT		
Head	Left Head Touched	0.014	0.118	0.132	NA
	Left Head Tilted 15°	0.016	0.118	<b>0.134</b>	NA
	Right Head Touched	0.015	0.118	0.133	NA
	Right Head Tilted 15°	0.009	0.118	0.127	NA
Body Hotspot	Front side	0.045	0.059	0.104	NA
	Rear side	0.071	0.059	0.130	NA
	Top side	/	0.059	0.059	NA
	Left side	0.021	0.059	0.080	NA

Note: Simultaneous Tx Combination of GSM1900 and BT

Test Position		Scaled SAR <sub>Max</sub>		Σ <sub>1-g</sub> SAR	SPLSP
		UMTS Band II	BT		
Head	Left Head Touched	0.163	0.118	0.281	NA
	Left Head Tilted 15°	0.094	0.118	0.212	NA
	Right Head Touched	0.131	0.118	0.249	NA
	Right Head Tilted 15°	0.065	0.118	0.183	NA
Body Hotspot	Front side	0.383	0.059	0.442	NA
	Rear side	0.710	0.059	<b>0.769</b>	NA
	Top side	/	0.059	0.059	NA
	Left side	0.234	0.059	0.293	NA

Note: Simultaneous Tx Combination of UMTS Band II and BT





Test Position	Scaled SAR <sub>Max</sub>		Σ <sub>1-g</sub> SAR	SPLSP	
	UMTS Band V	BT			
Head	Left Head Touched	0.136	0.118	0.254	NA
	Left Head Tilted 15°	0.078	0.118	0.196	NA
	Right Head Touched	0.127	0.118	0.245	NA
	Right Head Tilted 15°	0.071	0.118	0.189	NA
Body Hotspot	Front side	0.114	0.059	0.173	NA
	Rear side	0.236	0.059	<b>0.295</b>	NA
	Top side	/	0.059	0.059	NA
	Left side	0.114	0.059	0.173	NA

Note: Simultaneous Tx Combination of UMTS Band V and BT

MAX.ΣSAR<sub>1g</sub> = 0.769W/kg < 1.6 W/kg, so the Simultaneous SAR is not required for BT and GSM&UMTS antenna.





## 11 Measurement uncertainty evaluation

### 11.1 Measurement uncertainty evaluation for SAR test

The following table includes the uncertainty table of the IEEE 1528. The values are determined by Satimo. The breakdown of the individual uncertainties is as follows:

Measurement Uncertainty evaluation for SAR test								
Uncertainty Component	Tol. (±%)	Prob. Dist.	Div.	C <sub>i</sub> (1g)	C <sub>i</sub> (10g)	1g U <sub>i</sub> (±%)	10g U <sub>i</sub> (±%)	V <sub>i</sub>
<b>measurement system</b>								
Probe Calibration	5.8	N	1	1	1	5.8	5.8	∞
Axial Isotropy	3.5	R	$\sqrt{3}$	$(1-C_p)^{1/2}$	$(1-C_p)^{1/2}$	1.43	1.43	∞
Hemispherical Isotropy	5.9	R	$\sqrt{3}$	$\sqrt{C_p}$	$\sqrt{C_p}$	2.41	2.41	∞
Boundary Effect	1	R	$\sqrt{3}$	1	1	0.58	0.58	∞
Linearity	4.7	R	$\sqrt{3}$	1	1	2.71	2.71	∞
system Detection Limits	1	R	$\sqrt{3}$	1	1	0.58	0.58	∞
Modulation response	3	N	1	1	1	3.00	3.00	∞
Readout Electronics	0.5	N	1	1	1	0.50	0.50	∞
Response Time	0	R	$\sqrt{3}$	1	1	0.00	0.00	∞
Integration Time	1.4	R	$\sqrt{3}$	1	1	0.81	0.81	∞
RF Ambient Conditions-Noise	3	R	$\sqrt{3}$	1	1	1.73	1.73	∞
RF Ambient Conditions-Reflections	3	R	$\sqrt{3}$	1	1	1.73	1.73	∞
Probe Positioner Mechanical Tolerance	1.4	R	$\sqrt{3}$	1	1	0.81	0.81	∞
Probe positioning with respect to Phantom Shell	1.4	R	$\sqrt{3}$	1	1	0.81	0.81	∞
Extrapolation, interpolation and Integration Algorithms for Max.SAR Evaluation	2.3	R	$\sqrt{3}$	1	1	1.33	1.33	∞
<b>Test sample Related</b>								
Test Sample Positioning	2.6	N	1	1	1	2.60	2.60	11
Device Holder Uncertainty	3	N	1	1	1	3.00	3.00	7
Output Power Variation-SAR drift measurement	5	R	$\sqrt{3}$	1	1	2.89	2.89	∞
SAR scaling	2	R	$\sqrt{3}$	1	1	1.15	1.15	∞





Phantom and Tissue Parameters								
Phantom Uncertainty (shape and thickness tolerances)	4	R	$\sqrt{3}$	1	1	2.31	2.31	$\infty$
Uncertainty in SAR correction for deviation (in permittivity and conductivity)	2	N	1	1	0.84	2.00	1.68	$\infty$
Liquid conductivity ( meas. )	2.5	N	1	0.64	0.43	1.60	1.08	5
Liquid conductivity (target.)	5	R	$\sqrt{3}$	0.64	0.43	1.85	1.24	5
Liquid Permittivity ( meas. )	2.5	N	1	0.60	0.49	1.50	1.23	$\infty$
Liquid Permittivity (target.)	5	R	$\sqrt{3}$	0.60	0.49	1.73	1.42	$\infty$
<b>Combined Standard Uncertainly</b>		Rss				10.63	10.54	
<b>Expanded Uncertainty{95% CONFIDENCE INTERVAL}</b>		k				21.26	21.08	





### 11.2 Measurement uncertainty evaluation for system check

The following table includes the uncertainty table of the IEEE 1528. The values are determined by Satimo. The breakdown of the individual uncertainties is as follows:

Uncertainty For System Performance Check								
Uncertainty Component	Tol. (±%)	Prob. Dist.	Div.	C <sub>i</sub> 1g	C <sub>i</sub> 10g	1g U <sub>i</sub> (±%)	10g U <sub>i</sub> (±%)	V <sub>i</sub>
<b>measurement system</b>								
Probe Calibration	5.8	N	1	1	1	5.80	5.80	∞
Axial Isotropy	3.5	R	$\sqrt{3}$	$(1-C_p)^{1/2}$	$(1-C_p)^{1/2}$	1.43	1.43	∞
Hemispherical Isotropy	5.9	R	$\sqrt{3}$	$\sqrt{C_p}$	$\sqrt{C_p}$	2.41	2.41	∞
Boundary Effect	1	R	$\sqrt{3}$	1	1	0.58	0.58	∞
Linearity	4.7	R	$\sqrt{3}$	1	1	2.71	2.71	∞
system detection Limits	1	R	$\sqrt{3}$	1	1	0.58	0.58	∞
Modulation response	0	N	1	1	1	0.00	0.00	∞
Readout Electronics	0.5	N	1	1	1	0.50	0.50	∞
Response Time	0	R	$\sqrt{3}$	1	1	0.00	0.00	∞
Integration Time	1.4	R	$\sqrt{3}$	1	1	0.81	0.81	∞
RF ambient Conditions - Noise	3	R	$\sqrt{3}$	1	1	1.73	1.73	∞
RF ambient Conditions – Reflections	3	R	$\sqrt{3}$	1	1	1.73	1.73	∞
Probe positioned Mechanical Tolerance	1.4	R	$\sqrt{3}$	1	1	0.81	0.81	∞
Probe positioning with respect to Phantom Shell	1.4	R	$\sqrt{3}$	1	1	0.81	0.81	∞
Extrapolation, interpolation and integration Algorithms for Max. SAR Evaluation	2.3	R	$\sqrt{3}$	1	1	1.33	1.33	∞
<b>Dipole</b>								
Deviation of experimental source from numerical source	4	N	1	1	1	4.00	4.00	∞
Input power and SAR drift measurement	5	R	$\sqrt{3}$	1	1	2.89	2.89	∞
Dipole axis to liquid Distance	2	R	$\sqrt{3}$	1	1	1.16	1.16	∞





Phantom and Tissue Parameters								
Phantom Uncertainty (shape and thickness tolerances)	4	R	$\sqrt{3}$	1	1	2.31	2.31	$\infty$
Uncertainty in SAR correction for deviation (in permittivity and conductivity)	2	N	1	1	0.84	2.00	1.68	$\infty$
Liquid conductivity ( meas. )	2.5	N	1	0.64	0.43	1.60	1.08	5
Liquid conductivity (target.)	5	R	$\sqrt{3}$	0.64	0.43	1.85	1.24	5
Liquid Permittivity ( meas. )	2.5	N	1	0.60	0.49	1.50	1.23	$\infty$
Liquid Permittivity (target.)	5	R	$\sqrt{3}$	0.60	0.49	1.73	1.41	$\infty$
<b>Combined Standard Uncertainty</b>		Rss				10.28	9.98	
<b>Expanded Uncertainty (95% Confidence interval)</b>		k				20.57	19.95	





## 12 Test equipment and ancillaries used for tests

To simplify the identification of the test equipment and/or ancillaries which were used, the reporting of the relevant test cases only refer to the test item number as specified in the table below.

	Manufacturer	Device Type	Type(Model)	Serial number	calibration	
					Last Cal.	Due Date
<input checked="" type="checkbox"/>	SATIMO	COMOSAR DOSIMETRIC E FIELD PROBE	SSE5	SN 07/15 EP252	2017-11-27	2018-11-26
<input checked="" type="checkbox"/>	SATIMO	COMOSAR 835 MHz REFERENCE DIPOLE	SID835	SN 14/13 DIP0G835-235	2018-07-25	2019-07-24
<input type="checkbox"/>	SATIMO	COMOSAR 900 MHz REFERENCE DIPOLE	SID900	SN 14/13 DIP0G900-231	2018-07-25	2019-07-24
<input type="checkbox"/>	SATIMO	COMOSAR 1800 MHz REFERENCE DIPOLE	SID1800	SN 14/13 DIP1G800-232	2018-07-25	2019-07-24
<input checked="" type="checkbox"/>	SATIMO	COMOSAR 1900 MHz REFERENCE DIPOLE	SID1900	SN 14/13 DIP1G900-236	2018-07-25	2019-07-24
<input type="checkbox"/>	SATIMO	COMOSAR 2000 MHz REFERENCE DIPOLE	SID2000	SN 14/13 DIP2G000-237	2018-07-25	2019-07-24
<input checked="" type="checkbox"/>	SATIMO	COMOSAR 2450 MHz REFERENCE DIPOLE	SID2450	SN 14/13 DIP2G450-238	2018-07-25	2019-07-24
<input type="checkbox"/>	SATIMO	COMOSAR 2600 MHz REFERENCE DIPOLE	SID2600	SN 28/14 DIP2G600-327	2018-07-25	2019-07-24
<input checked="" type="checkbox"/>	SATIMO	Software	OPENSAR	N/A	N/A	N/A
<input checked="" type="checkbox"/>	SATIMO	Phantom	COMOSAR IEEE SAM PHANTOM	SN 14/13 SAM99	N/A	N/A
<input checked="" type="checkbox"/>	R & S	Universal Radio Communication Tester	CMU 200	119733	2018-05-24	2019-05-23
<input checked="" type="checkbox"/>	HP	Network Analyser	8753D	3410A08889	2018-10-29	2019-10-28
<input checked="" type="checkbox"/>	HP	Signal Generator	E4421B	GB39340770	2018-10-29	2019-10-28
<input checked="" type="checkbox"/>	Keithley	Multimeter	Keithley 2000	4014539	2018-10-29	2019-10-28
<input checked="" type="checkbox"/>	SATIMO	Amplifier	Power Amplifier	MODU-023-A-0004	2018-10-29	2019-10-28
<input checked="" type="checkbox"/>	Agilent	Power Meter	E4418B	GB43312909	2018-10-29	2019-10-28
<input checked="" type="checkbox"/>	Agilent	Power Meter Sensor	E4412A	MY41500046	2018-10-29	2019-10-28
<input checked="" type="checkbox"/>	Agilent	Power Meter	E4417A	GB41291826	2018-10-29	2019-10-28
<input checked="" type="checkbox"/>	Agilent	Power Meter Sensor	8481H	MY41091215	2018-10-29	2019-10-28







**Annex A: System performance verification**

(Please See the SAR Measurement Plots of annex A.)

**Annex B: Measurement results**

(Please See the SAR Measurement Plots of annex B.)

**Annex C: Calibration reports**

(Please See the Calibration reports of annex C.)

**Annex D: Photo documentation**

(Please See the Photo documentation of annex D.)



	<b>Annex A: System Check</b>
	<b>Tested Model : B2</b>
	<b>Report Number: FCC18110006A-SAR</b>

## I. RESULTS

<u>TYPE</u>	<u>BAND</u>	<u>PARAMETERS</u>
<b>Validation</b>	<b>CW835</b>	<u>Measurement 1</u> : Validation Plane with Dipole device position on Middle Channel in CW mode
<b>Validation</b>	<b>CW835</b>	<u>Measurement 2</u> : Validation Plane with Dipole device position on Middle Channel in CW mode
<b>Validation</b>	<b>CW1900</b>	<u>Measurement 3</u> : Validation Plane with Dipole device position on Middle Channel in CW mode
<b>Validation</b>	<b>CW1900</b>	<u>Measurement 4</u> : Validation Plane with Dipole device position on Middle Channel in CW mode
<b>Validation</b>	<b>CW2450</b>	<u>Measurement 5</u> : Validation Plane with Dipole device position on Middle Channel in CW mode
<b>Validation</b>	<b>CW2450</b>	<u>Measurement 6</u> : Validation Plane with Dipole device position on Middle Channel in CW mode

## MEASUREMENT 1

### BODY

Type: Validation measurement (Complete)

Date of measurement: 13/11/2018

Measurement duration: 11 minutes 38 seconds

### A. Experimental conditions.

<u>Area Scan</u>	<u>dx=8mm dy=8mm</u>
<u>ZoomScan</u>	<u>5x5x7,dx=8mm dy=8mm</u> <u>dz=5mm,Complete</u>
<u>Phantom</u>	<u>Validation plane</u>
<u>Device Position</u>	<u>Dipole</u>
<u>Band</u>	<u>CW835</u>
<u>Channels</u>	<u>Middle</u>
<u>Signal</u>	<u>CW (Crest factor: 1.0)</u>

### B. SAR Measurement Results

Middle Band SAR (Channel -1):

<b>Frequency (MHz)</b>	835.000000
<b>Relative permittivity (real part)</b>	53.458401
<b>Relative permittivity (imaginary part)</b>	20.503000
<b>Conductivity (S/m)</b>	0.951111
<b>Variation (%)</b>	-1.520000

### SURFACE SAR

### VOLUME SAR

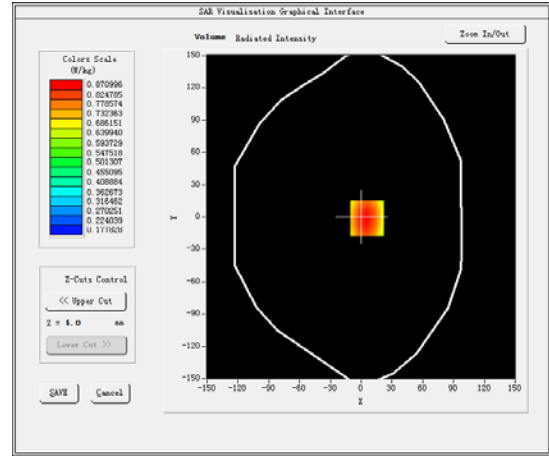
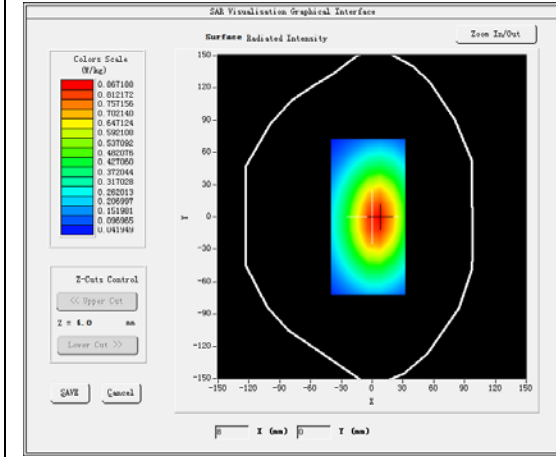

**Maximum location: X=6.00, Y=-1.00**

**SAR Peak: 1.08 W/kg**

<b>SAR 10g (W/Kg)</b>	0.629766
<b>SAR 1g (W/Kg)</b>	0.846036

Z (mm)	0.00	4.00	9.00	14.00	19.00	24.00	29.00
SAR (W/Kg)	1.0747	0.8710	0.6744	0.5294	0.4173	0.3335	0.2689

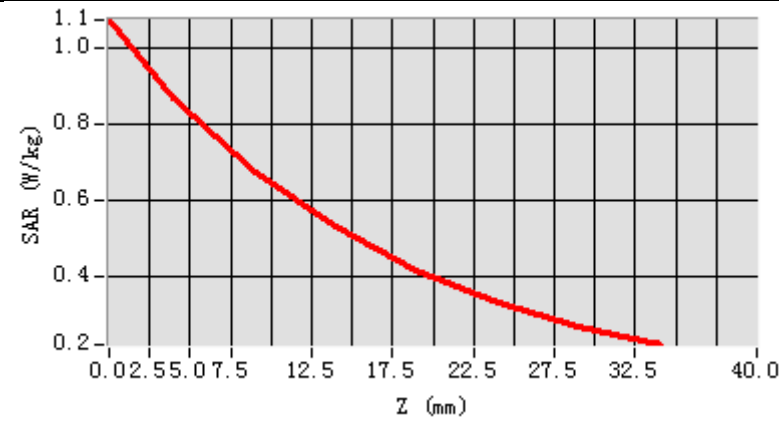

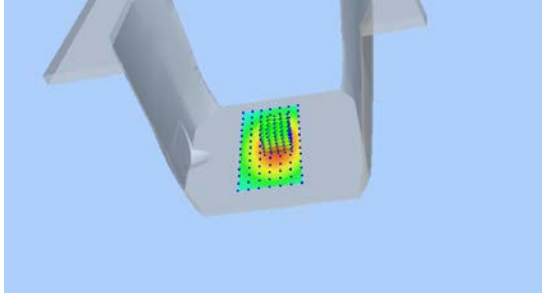
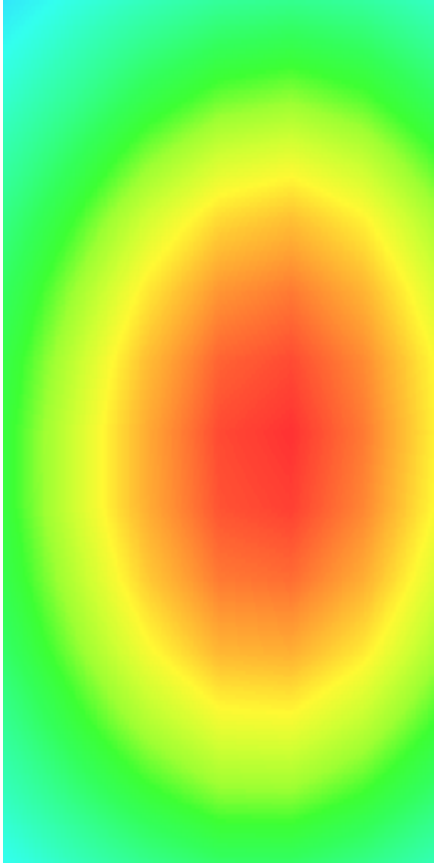
3D screen shot	Hot spot position
	

## MEASUREMENT 2

### HEAD

Type: Validation measurement (Complete)

Date of measurement: 13/11/2018

Measurement duration: 11 minutes 38 seconds

#### A. Experimental conditions.

<u>Area Scan</u>	<u>dx=8mm dy=8mm</u>
<u>ZoomScan</u>	<u>5x5x7,dx=8mm dy=8mm dz=5mm,Complete</u>
<u>Phantom</u>	<u>Validation plane</u>
<u>Device Position</u>	<u>Dipole</u>
<u>Band</u>	<u>CW835</u>
<u>Channels</u>	<u>Middle</u>
<u>Signal</u>	<u>CW (Crest factor: 1.0)</u>

#### B. SAR Measurement Results

Middle Band SAR (Channel -1):

<b>Frequency (MHz)</b>	835.000000
<b>Relative permittivity (real part)</b>	40.441299
<b>Relative permittivity (imaginary part)</b>	20.606899
<b>Conductivity (S/m)</b>	0.955931
<b>Variation (%)</b>	-1.660000

### SURFACE SAR

### VOLUME SAR

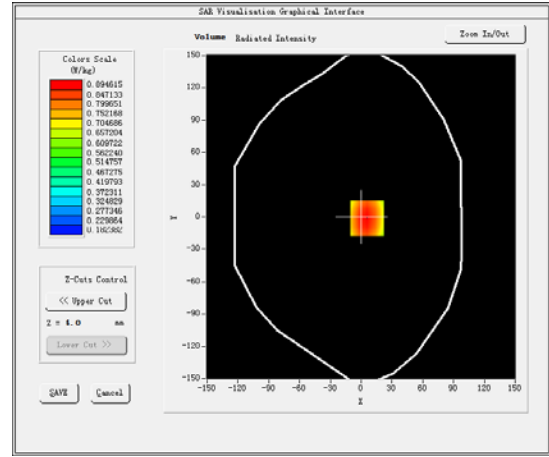
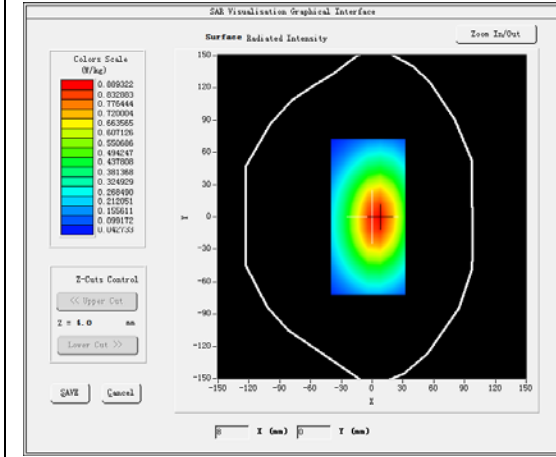

**Maximum location: X=6.00, Y=-1.00**

**SAR Peak: 1.11 W/kg**

<b>SAR 10g (W/Kg)</b>	0.671843
<b>SAR 1g (W/Kg)</b>	0.912096

Z (mm)	0.00	4.00	9.00	14.00	19.00	24.00	29.00
SAR (W/Kg)	1.1043	0.8946	0.6925	0.5438	0.4287	0.3424	0.2762

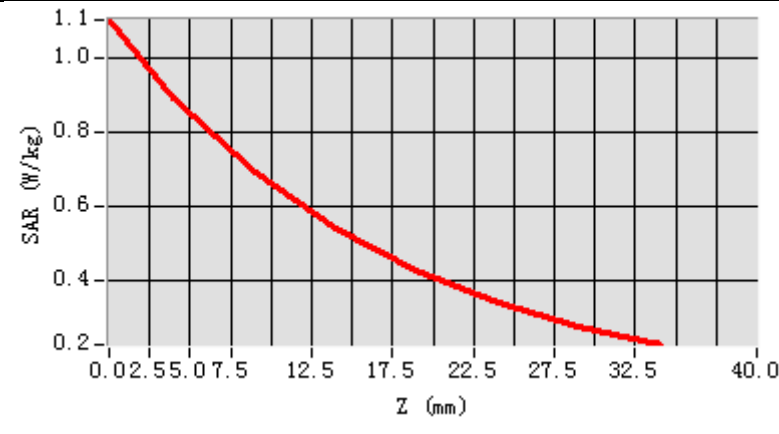

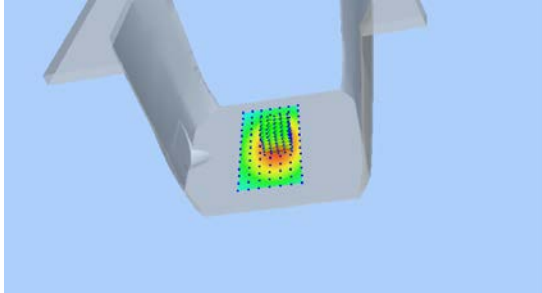
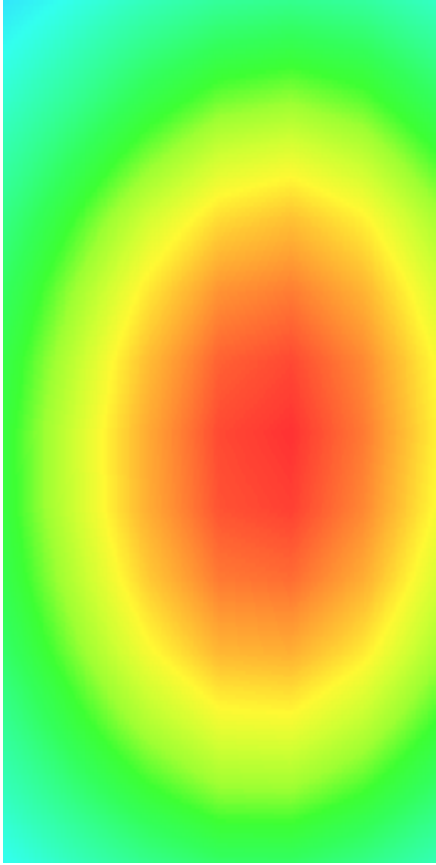
3D screen shot	Hot spot position
	



## MEASUREMENT 3

### BODY

Type: Validation measurement (Complete)

Date of measurement: 12/11/2018

Measurement duration: 9 minutes 55 seconds

### A. Experimental conditions.

<u>Area Scan</u>	<u>dx=8mm dy=8mm</u>
<u>ZoomScan</u>	<u>5x5x7,dx=8mm dy=8mm dz=5mm,Complete</u>
<u>Phantom</u>	<u>Validation plane</u>
<u>Device Position</u>	<u>Dipole</u>
<u>Band</u>	<u>CW1900</u>
<u>Channels</u>	<u>Middle</u>
<u>Signal</u>	<u>CW (Crest factor: 1.0)</u>

### B. SAR Measurement Results

Middle Band SAR (Channel -1):

<b>Frequency (MHz)</b>	1900.000000
<b>Relative permittivity (real part)</b>	52.199100
<b>Relative permittivity (imaginary part)</b>	14.615200
<b>Conductivity (S/m)</b>	1.542716
<b>Variation (%)</b>	-0.660000

### SURFACE SAR

### VOLUME SAR

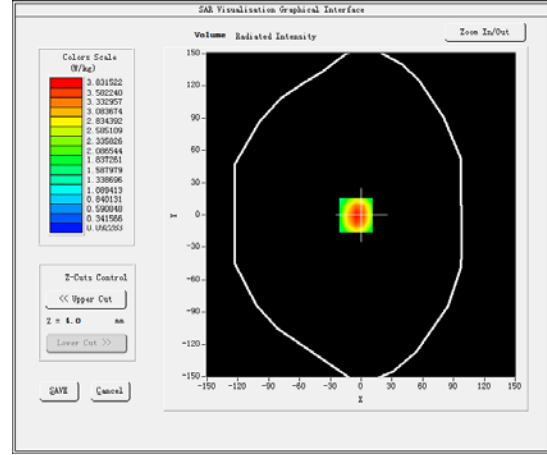
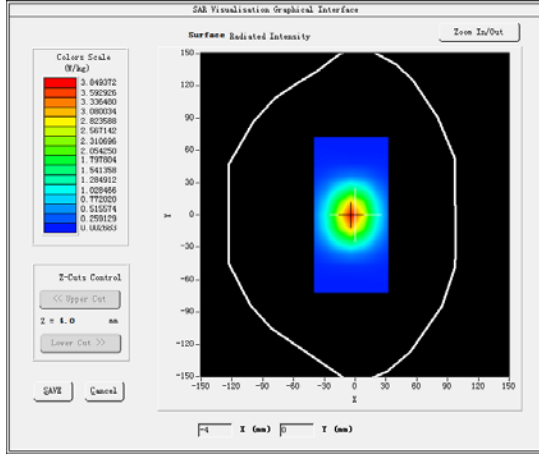

Maximum location: X=-5.00, Y=0.00

SAR Peak: 5.90 W/kg

SAR 10g (W/Kg)	2.047070
SAR 1g (W/Kg)	3.720274

Z (mm)	0.00	4.00	9.00	14.00	19.00	24.00	29.00
SAR (W/Kg)	5.8752	3.8315	2.2043	1.3005	0.7705	0.4595	0.2763

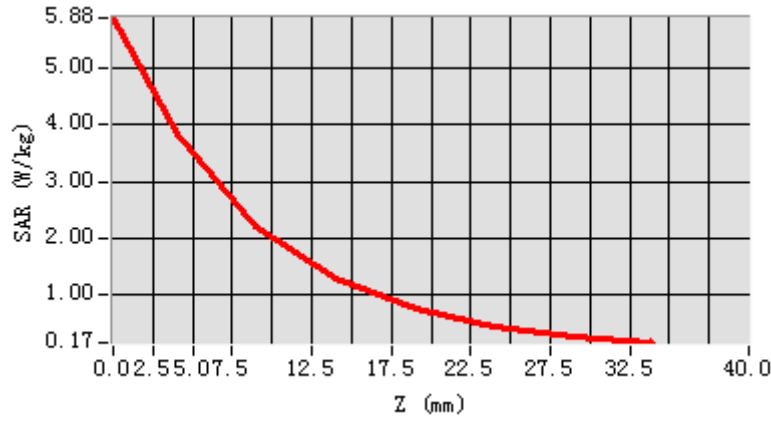

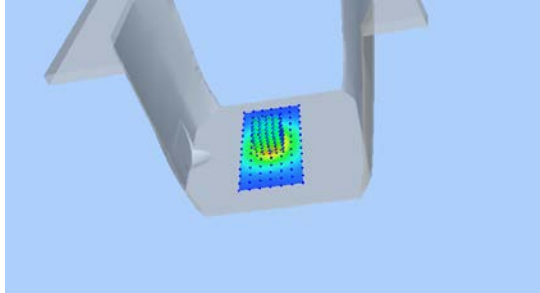
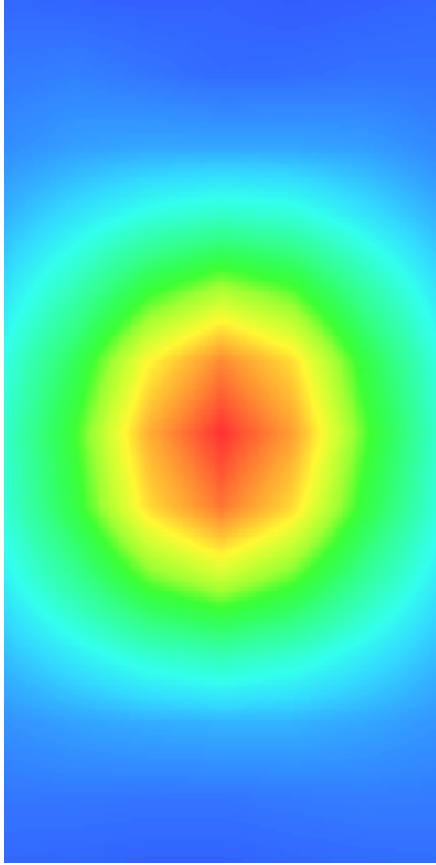
3D screen shot	Hot spot position
	

## MEASUREMENT 4

### HEAD

Type: Validation measurement (Complete)

Date of measurement: 12/11/2018

Measurement duration: 9 minutes 56 seconds

#### A. Experimental conditions.

<u>Area Scan</u>	<u>dx=8mm dy=8mm</u>
<u>ZoomScan</u>	<u>5x5x7,dx=8mm dy=8mm</u> <u>dz=5mm,Complete</u>
<u>Phantom</u>	<u>Validation plane</u>
<u>Device Position</u>	<u>Dipole</u>
<u>Band</u>	<u>CW1900</u>
<u>Channels</u>	<u>Middle</u>
<u>Signal</u>	<u>CW (Crest factor: 1.0)</u>

#### B. SAR Measurement Results

Middle Band SAR (Channel -1):

<b>Frequency (MHz)</b>	1900.000000
<b>Relative permittivity (real part)</b>	39.880501
<b>Relative permittivity (imaginary part)</b>	13.326500
<b>Conductivity (S/m)</b>	1.406686
<b>Variation (%)</b>	-0.860000

### SURFACE SAR

### VOLUME SAR

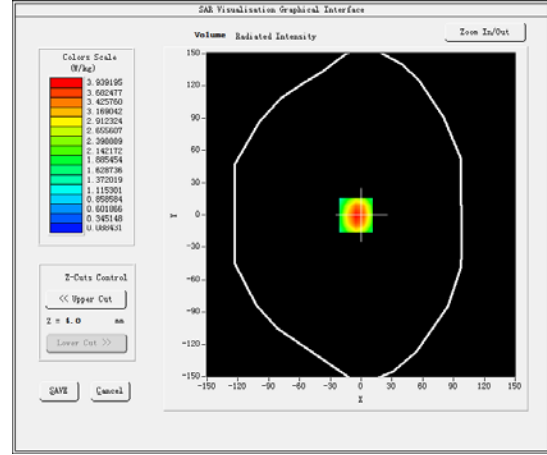
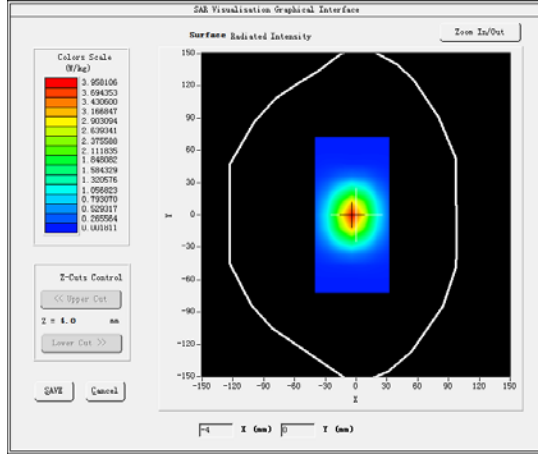

**Maximum location: X=-5.00, Y=0.00**

**SAR Peak: 6.12 W/kg**

<b>SAR 10g (W/Kg)</b>	2.063282
<b>SAR 1g (W/Kg)</b>	3.782124

Z (mm)	0.00	4.00	9.00	14.00	19.00	24.00	29.00
SAR (W/Kg)	6.0938	3.9392	2.2387	1.3105	0.7704	0.4580	0.2736

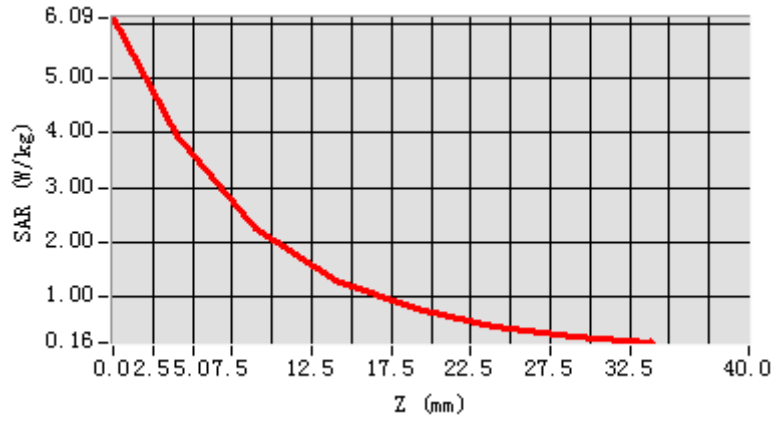

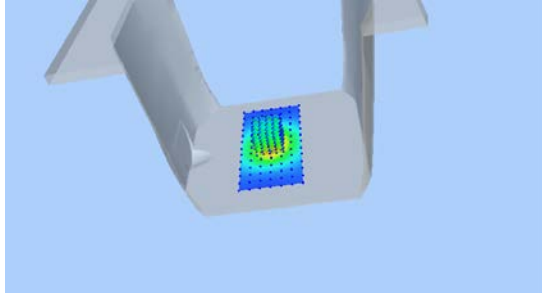
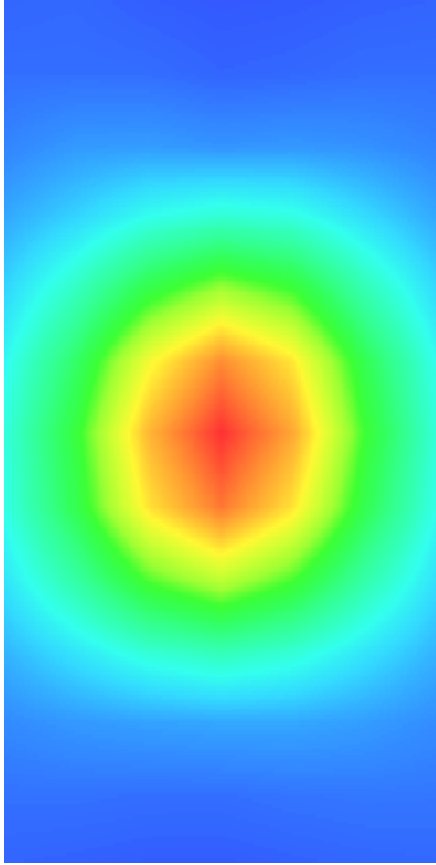
3D screen shot	Hot spot position
	

## MEASUREMENT 5

### BODY

Type: Validation measurement (Complete)

Date of measurement: 13/11/2018

Measurement duration: 9 minutes 58 seconds

### A. Experimental conditions.

<u>Area Scan</u>	<u>dx=8mm dy=8mm</u>
<u>ZoomScan</u>	<u>5x5x7,dx=8mm dy=8mm</u> <u>dz=5mm,Complete</u>
<u>Phantom</u>	<u>Validation plane</u>
<u>Device Position</u>	<u>Dipole</u>
<u>Band</u>	<u>CW2450</u>
<u>Channels</u>	<u>Middle</u>
<u>Signal</u>	<u>CW (Crest factor: 1.0)</u>

### B. SAR Measurement Results

Middle Band SAR (Channel -1):

<b>Frequency (MHz)</b>	2450.000000
<b>Relative permittivity (real part)</b>	52.735699
<b>Relative permittivity (imaginary part)</b>	14.017300
<b>Conductivity (S/m)</b>	1.907910
<b>Variation (%)</b>	-0.880000

### SURFACE SAR

### VOLUME SAR

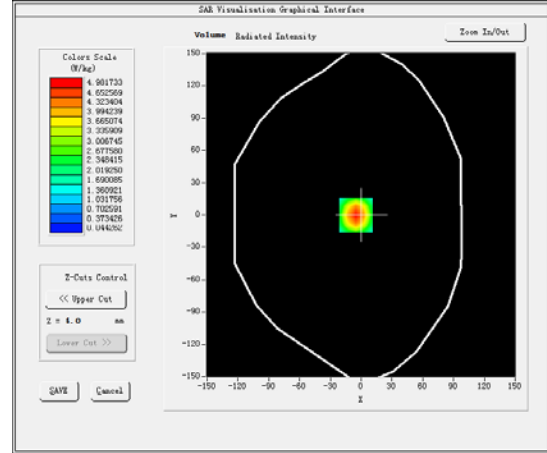
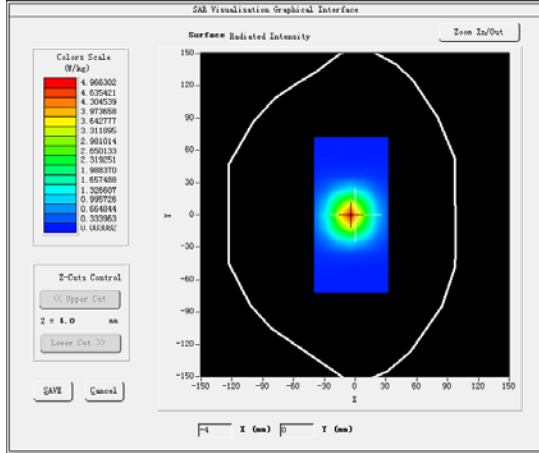

**Maximum location: X=-5.00, Y=0.00**

**SAR Peak: 8.28 W/kg**

<b>SAR 10g (W/Kg)</b>	2.328959
<b>SAR 1g (W/Kg)</b>	4.728068



Z (mm)	0.00	4.00	9.00	14.00	19.00	24.00	29.00
SAR (W/Kg)	8.3759	4.9817	2.4673	1.2566	0.6401	0.3301	0.1714

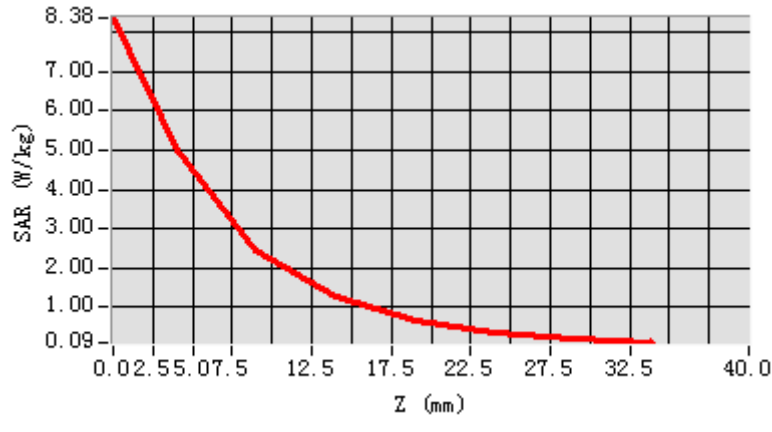

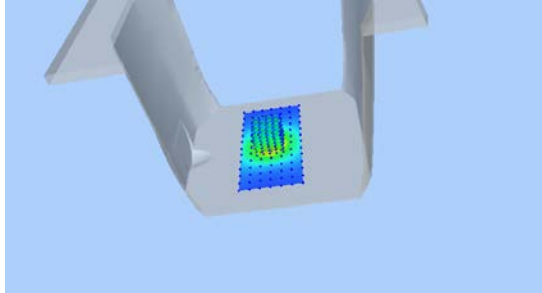
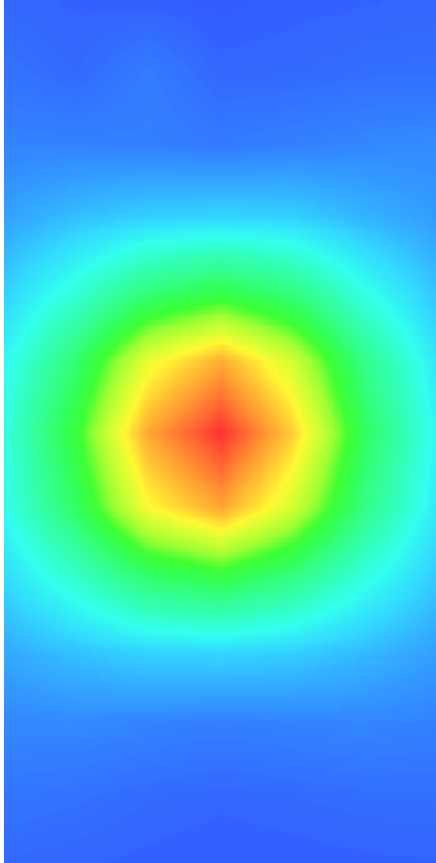
3D screen shot	Hot spot position
	

## MEASUREMENT 6

### HEAD

Type: Validation measurement (Complete)

Date of measurement: 13/11/2018

Measurement duration: 9 minutes 57 seconds

#### A. Experimental conditions.

<u>Area Scan</u>	<u>dx=8mm dy=8mm</u>
<u>ZoomScan</u>	<u>5x5x7,dx=8mm dy=8mm</u> <u>dz=5mm,Complete</u>
<u>Phantom</u>	<u>Validation plane</u>
<u>Device Position</u>	<u>Dipole</u>
<u>Band</u>	<u>CW2450</u>
<u>Channels</u>	<u>Middle</u>
<u>Signal</u>	<u>CW (Crest factor: 1.0)</u>

#### B. SAR Measurement Results

Middle Band SAR (Channel -1):

<b>Frequency (MHz)</b>	2450.000000
<b>Relative permittivity (real part)</b>	39.270901
<b>Relative permittivity (imaginary part)</b>	13.557900
<b>Conductivity (S/m)</b>	1.845381
<b>Variation (%)</b>	-0.750000

### SURFACE SAR

### VOLUME SAR

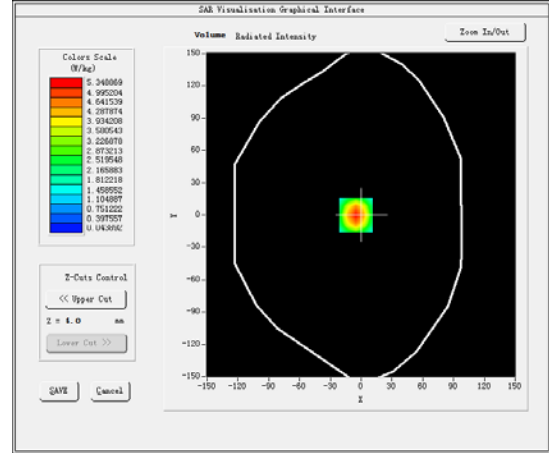
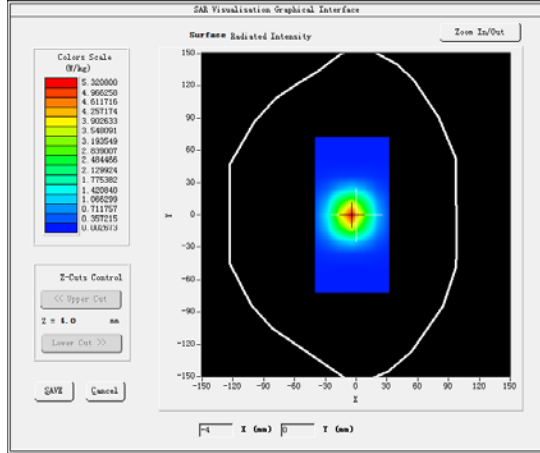

Maximum location: X=-5.00, Y=0.00

SAR Peak: 8.94 W/kg

SAR 10g (W/Kg)	2.480377
SAR 1g (W/Kg)	5.123599

Z (mm)	0.00	4.00	9.00	14.00	19.00	24.00	29.00
SAR (W/Kg)	9.0545	5.3489	2.6192	1.3223	0.6676	0.3420	0.1765

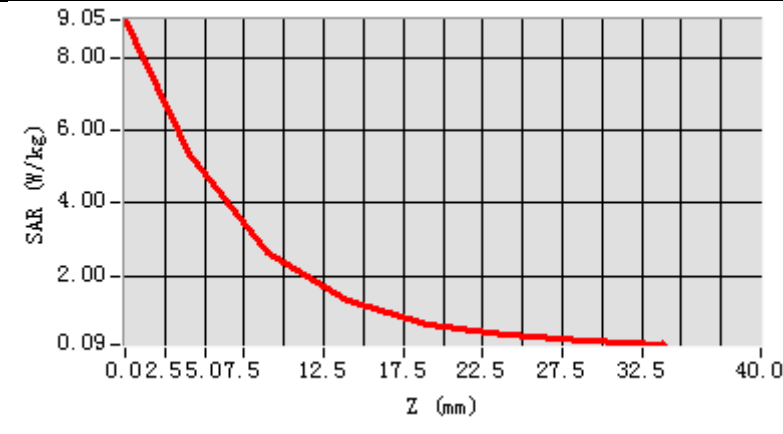

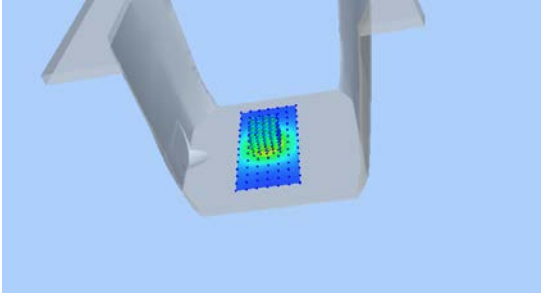
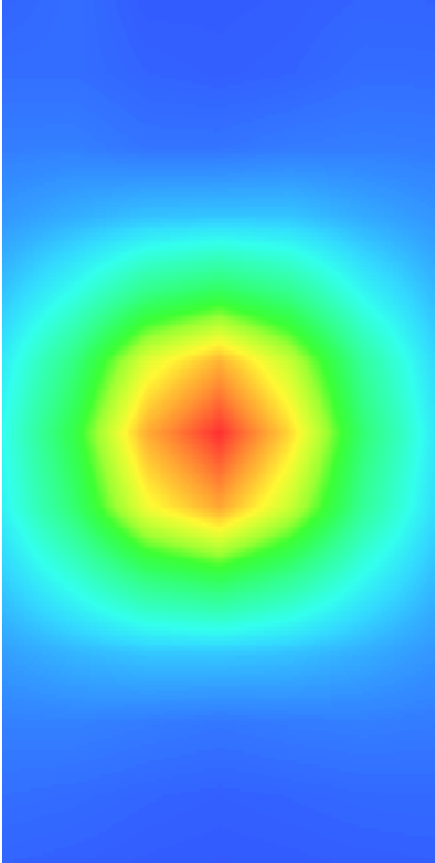
3D screen shot	Hot spot position
	



SATIMO 225, rue Pierre Rivoalon 29200 Brest - France  
Tel: +33 (0)2 98 05 13 34; Fax: +33 (0)2 98 05 53 87; www.satimo.com



## **Annex B: Measurement Results**

**Tested Model : B2**

**Report Number:  
FCC18110006A-SAR**

# MEASUREMENT 1

Type: Phone measurement (Complete)

Date of measurement: 12/11/2018

Measurement duration: 10 minutes 35 seconds

## A. Experimental conditions.

<u>Area Scan</u>	<u>dx=15mm dy=15mm</u>
<u>ZoomScan</u>	<u>5x5x7, dx=8mm dy=8mm dz=5mm, Complete</u>
<u>Phantom</u>	<u>Left head</u>
<u>Device Position</u>	<u>Cheek</u>
<u>Band</u>	<u>Band2 WCDMA1900</u>
<u>Channels</u>	<u>Middle</u>
<u>Signal</u>	<u>WCDMA (Crest factor: 1.0)</u>
<u>Conversion factor</u>	<u>5.17</u>

## B. SAR Measurement Results

Middle Band SAR (Channel 9400):

<b>Frequency (MHz)</b>	1880.000000
<b>Relative permittivity (real part)</b>	51.470901
<b>Relative permittivity (imaginary part)</b>	15.022000
<b>Conductivity (S/m)</b>	1.568964
<b>Variation (%)</b>	-3.340000

### SURFACE SAR

### VOLUME SAR

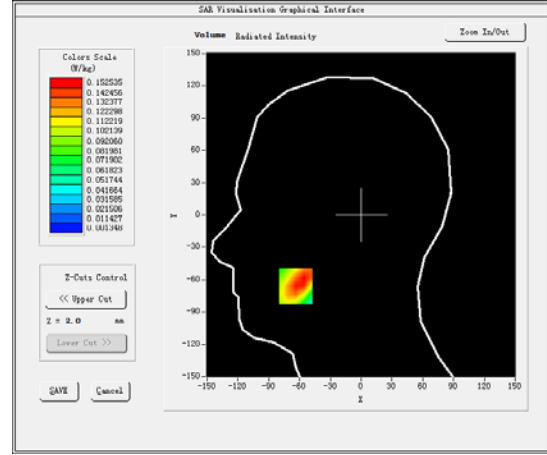
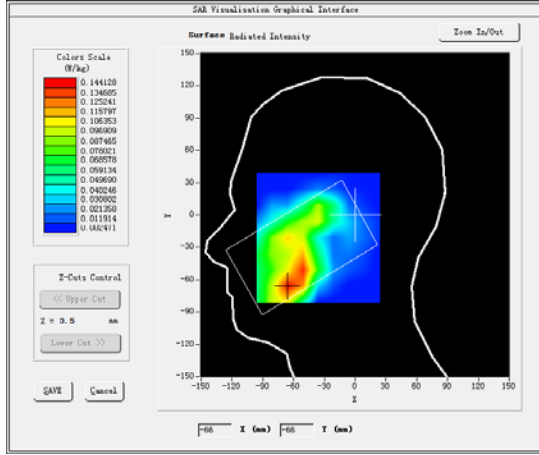

**Maximum location: X=-64.00, Y=-66.00**

**SAR Peak: 0.28 W/kg**

<b>SAR 10g (W/Kg)</b>	0.074112
<b>SAR 1g (W/Kg)</b>	0.152949

Z (mm)	0.00	4.00	9.00	14.00	19.00	24.00	29.00
SAR (W/Kg)	0.3010	0.1525	0.0549	0.0320	0.0119	0.0071	0.0033

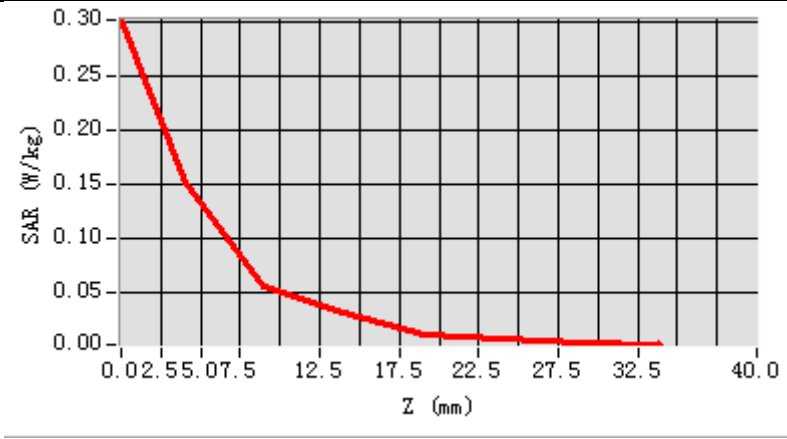

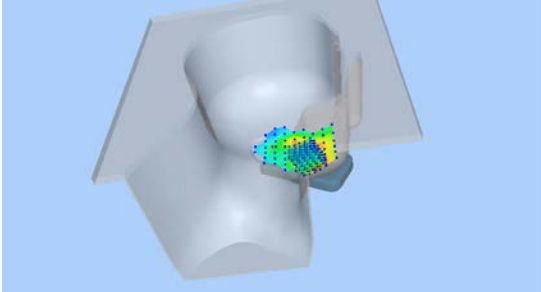
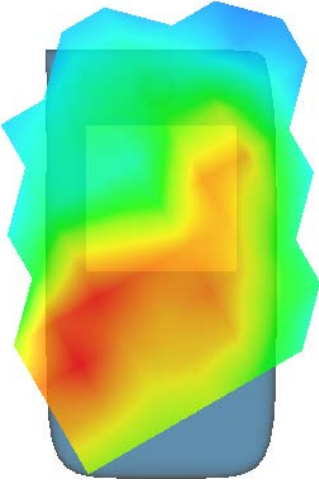
3D screen shot	Hot spot position
	



## MEASUREMENT 2

Rear-side-middle

Type: Phone measurement (Complete)

Date of measurement: 12/11/2018

Measurement duration: 10 minutes 45 seconds

### A. Experimental conditions.

<u>Area Scan</u>	<u>dx=15mm dy=15mm</u>
<u>ZoomScan</u>	<u>5x5x7,dx=8mm dy=8mm dz=5mm,Complete</u>
<u>Phantom</u>	<u>Validation plane</u>
<u>Device Position</u>	<u>Body</u>
<u>Band</u>	<u>Band2_WCDMA1900</u>
<u>Channels</u>	<u>Middle</u>
<u>Signal</u>	<u>WCDMA (Crest factor: 1.0)</u>
<u>Conversion factor</u>	<u>5.28</u>

### B. SAR Measurement Results

Middle Band SAR (Channel 9400):

<b>Frequency (MHz)</b>	1880.000000
<b>Relative permittivity (real part)</b>	51.470901
<b>Relative permittivity (imaginary part)</b>	15.022000
<b>Conductivity (S/m)</b>	1.568964
<b>Variation (%)</b>	-0.890000

### SURFACE SAR

### VOLUME SAR

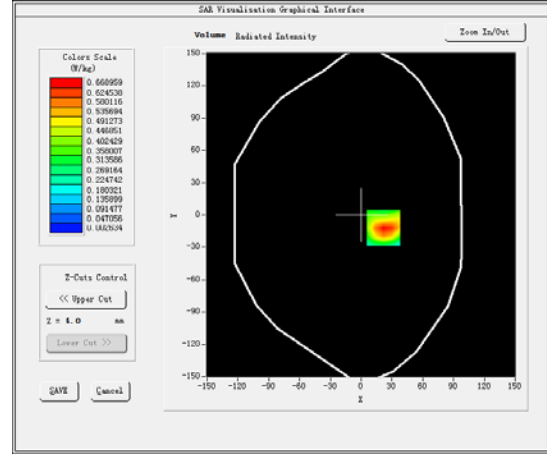
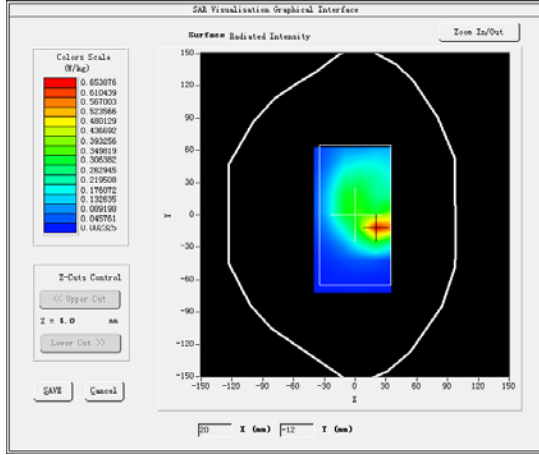

**Maximum location: X=22.00, Y=-12.00**

**SAR Peak: 1.24 W/kg**

<b>SAR 10g (W/Kg)</b>	0.296775
<b>SAR 1g (W/Kg)</b>	0.665589

Z (mm)	0.00	4.00	9.00	14.00	19.00	24.00	29.00
SAR (W/Kg)	1.2340	0.6690	0.2783	0.1183	0.0505	0.0224	0.0101

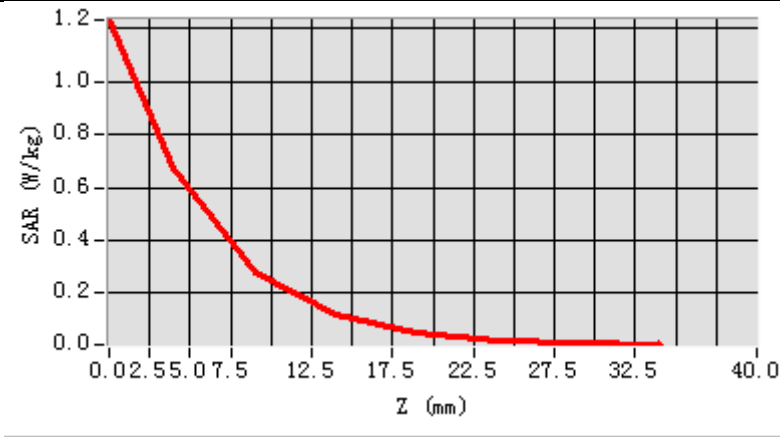

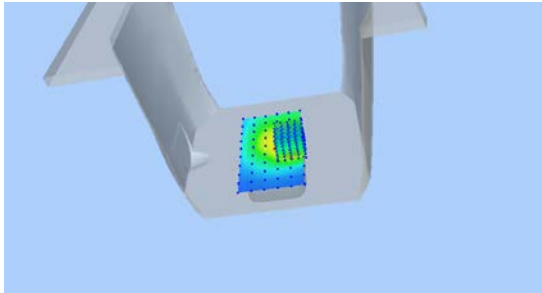
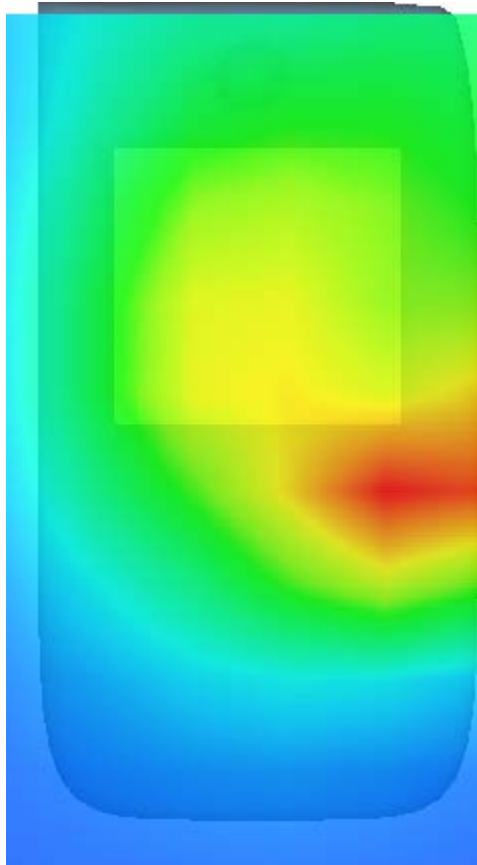
3D screen shot	Hot spot position
	

## MEASUREMENT 3

Type: Phone measurement (Complete)

Date of measurement: 13/11/2018

Measurement duration: 9 minutes 3 seconds

### A. Experimental conditions.

<b><u>Area Scan</u></b>	<u>dx=15mm dy=15mm</u>
<b><u>ZoomScan</u></b>	<u>5x5x7,dx=8mm dy=8mm dz=5mm,Complete</u>
<b><u>Phantom</u></b>	<u>Left head</u>
<b><u>Device Position</u></b>	<u>Cheek</u>
<b><u>Band</u></b>	<u>Band5 WCDMA850</u>
<b><u>Channels</u></b>	<u>Low</u>
<b><u>Signal</u></b>	<u>WCDMA (Crest factor: 1.0)</u>
<b><u>Conversion factor</u></b>	<u>5.54</u>

### B. SAR Measurement Results

Lower Band SAR (Channel 4132):

<b>Frequency (MHz)</b>	826.400024
<b>Relative permittivity (real part)</b>	40.545761
<b>Relative permittivity (imaginary part)</b>	19.543301
<b>Conductivity (S/m)</b>	0.897255
<b>Variation (%)</b>	-2.680000

### SURFACE SAR

### VOLUME SAR

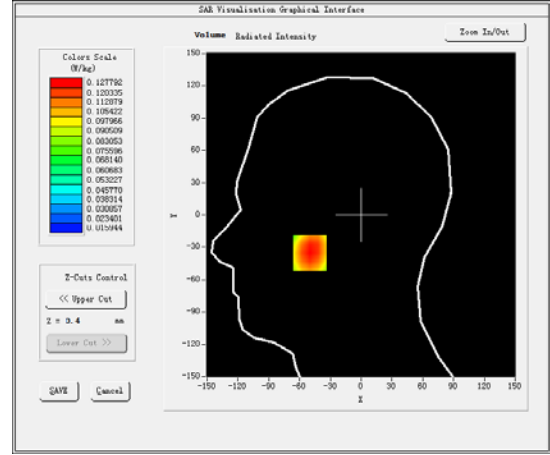
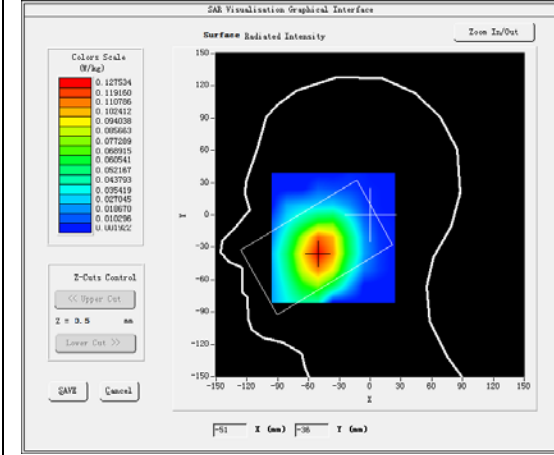

**Maximum location: X=-50.00, Y=-35.00**

**SAR Peak: 0.15 W/kg**

<b>SAR 10g (W/Kg)</b>	0.093939
<b>SAR 1g (W/Kg)</b>	0.124827

Z (mm)	0.00	4.00	9.00	14.00	19.00	24.00	29.00
SAR (W/Kg)	0.1506	0.1278	0.1042	0.0849	0.0682	0.0534	0.0413

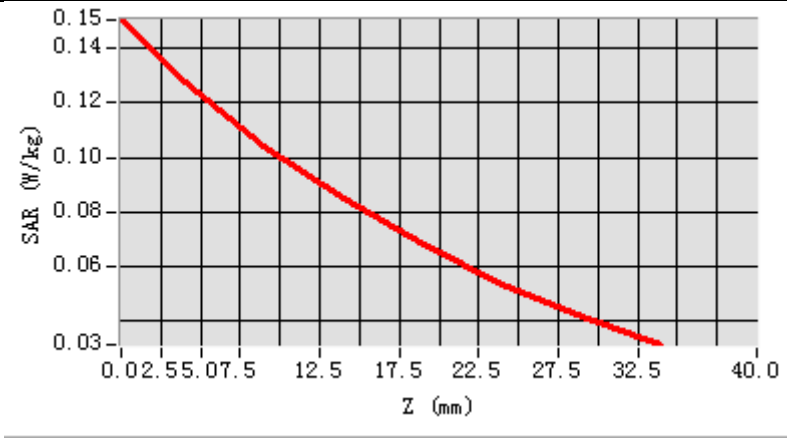

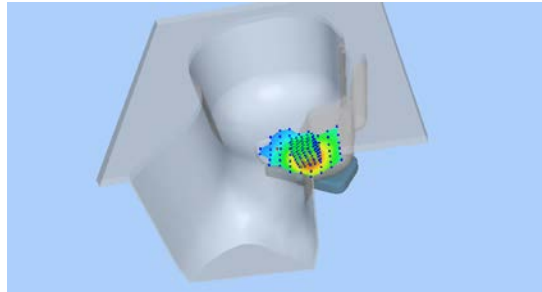
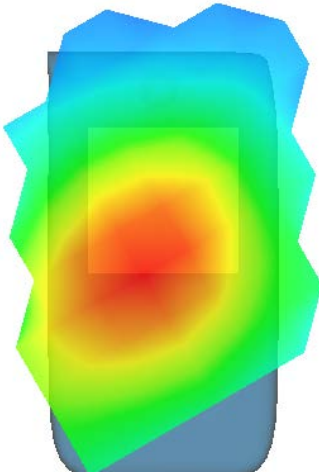
3D screen shot	Hot spot position
	

## MEASUREMENT 4

Rear-side-middle

Type: Phone measurement (Complete)

Date of measurement: 13/11/2018

Measurement duration: 10 minutes 36 seconds

### **A. Experimental conditions.**

<b><u>Area Scan</u></b>	<u>dx=15mm dy=15mm</u>
<b><u>ZoomScan</u></b>	<u>5x5x7,dx=8mm dy=8mm dz=5mm,Complete</u>
<b><u>Phantom</u></b>	<u>Validation plane</u>
<b><u>Device Position</u></b>	<u>Body</u>
<b><u>Band</u></b>	<u>Band5 WCDMA850</u>
<b><u>Channels</u></b>	<u>Low</u>
<b><u>Signal</u></b>	<u>WCDMA (Crest factor: 1.0)</u>
<b><u>Conversion factor</u></b>	<u>5.75</u>

### **B. SAR Measurement Results**

Lower Band SAR (Channel 4132):

<b>Frequency (MHz)</b>	826.400024
<b>Relative permittivity (real part)</b>	53.853939
<b>Relative permittivity (imaginary part)</b>	20.656139
<b>Conductivity (S/m)</b>	0.948346
<b>Variation (%)</b>	-1.230000

### SURFACE SAR

### VOLUME SAR

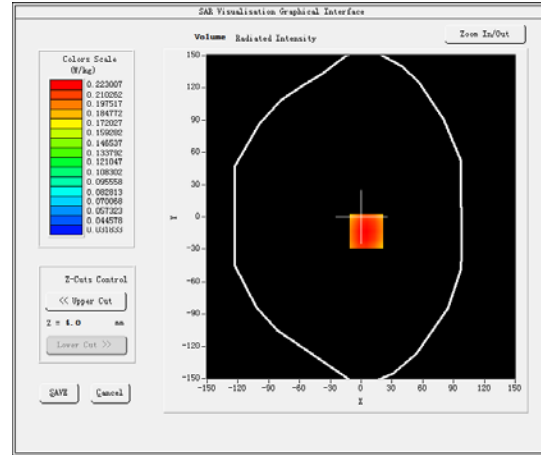
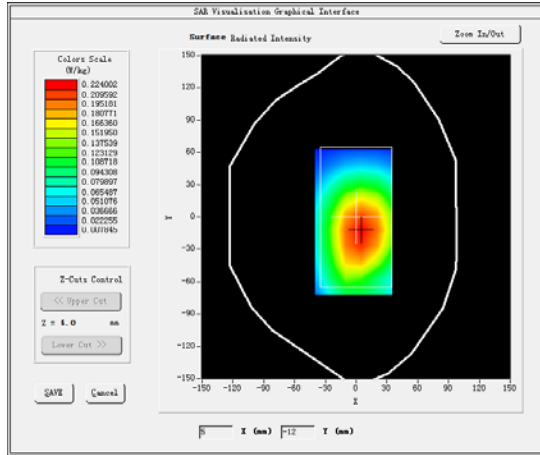

**Maximum location: X=5.00, Y=-13.00**

**SAR Peak: 0.28 W/kg**

<b>SAR 10g (W/Kg)</b>	0.159323
<b>SAR 1g (W/Kg)</b>	0.216583



Z (mm)	0.00	4.00	9.00	14.00	19.00	24.00	29.00
SAR (W/Kg)	0.2763	0.2230	0.1702	0.1311	0.0996	0.0759	0.0579

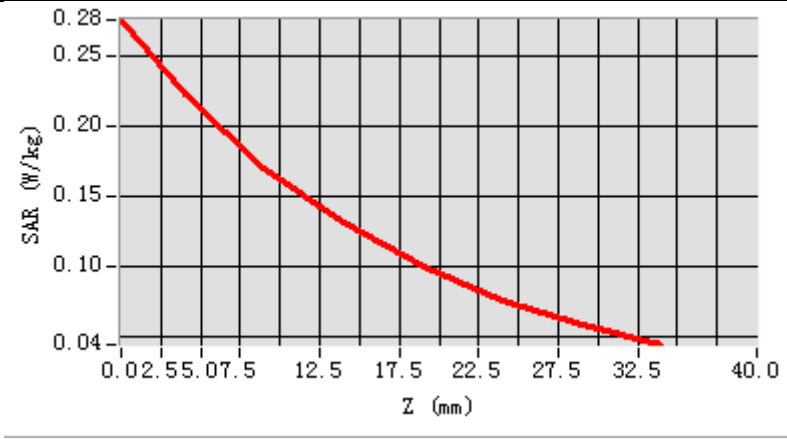

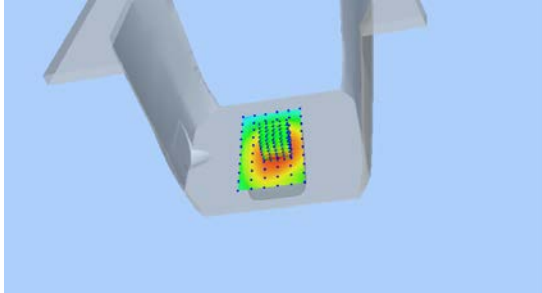
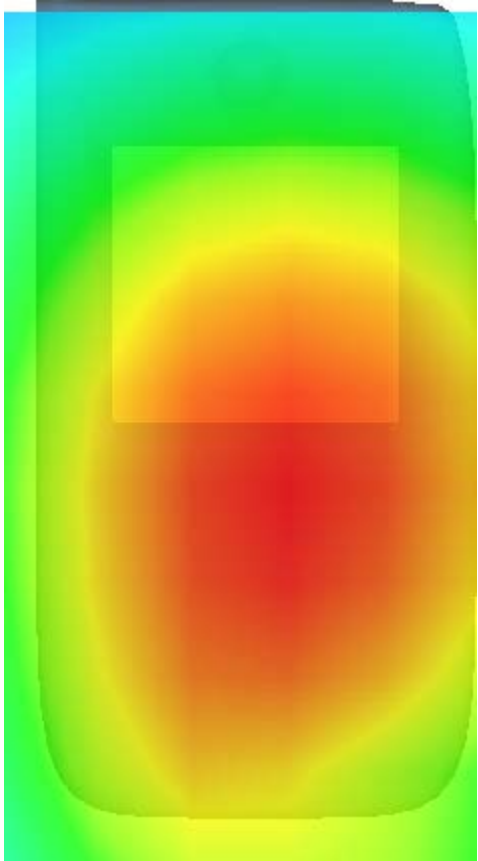
3D screen shot	Hot spot position
	

## MEASUREMENT 5

Type: Phone measurement (Complete)

Date of measurement: 13/11/2018

Measurement duration: 8 minutes 20 seconds

### A. Experimental conditions.

<u>Area Scan</u>	<u>dx=12mm dy=12mm</u>
<u>ZoomScan</u>	<u>7x7x7,dx=5mm dy=5mm dz=5mm,Complete</u>
<u>Phantom</u>	<u>Right head</u>
<u>Device Position</u>	<u>Cheek</u>
<u>Band</u>	<u>IEEE 802.11b ISM</u>
<u>Channels</u>	<u>Middle</u>
<u>Signal</u>	<u>IEEE802.b (Crest factor: 1.0)</u>
<u>Conversion factor</u>	<u>4.83</u>

### B. SAR Measurement Results

Middle Band SAR (Channel 6):

<b>Frequency (MHz)</b>	2437.000000
<b>Relative permittivity (real part)</b>	39.233898
<b>Relative permittivity (imaginary part)</b>	13.206700
<b>Conductivity (S/m)</b>	1.791709
<b>Variation (%)</b>	0.240000

### SURFACE SAR

### VOLUME SAR

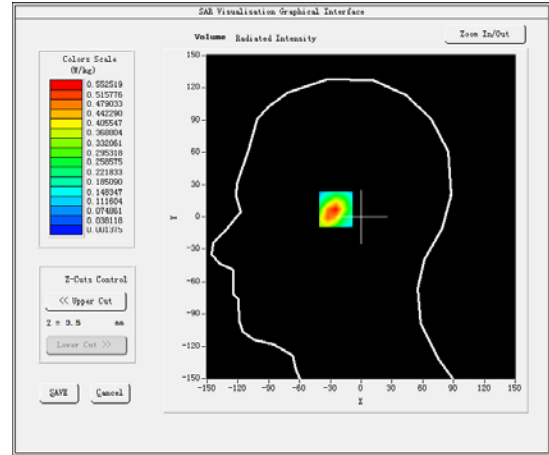
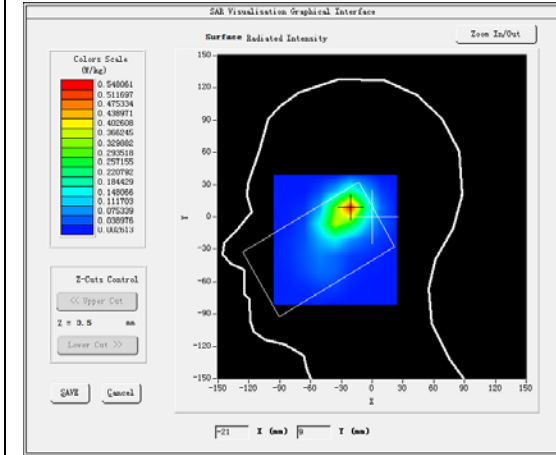

**Maximum location: X=-22.00, Y=9.00**

**SAR Peak: 1.14 W/kg**

<b>SAR 10g (W/Kg)</b>	0.216115
<b>SAR 1g (W/Kg)</b>	0.543107

Z (mm)	0.00	4.00	9.00	14.00	19.00	24.00	29.00
SAR (W/Kg)	1.1552	0.5525	0.1710	0.0540	0.0181	0.0065	0.0029

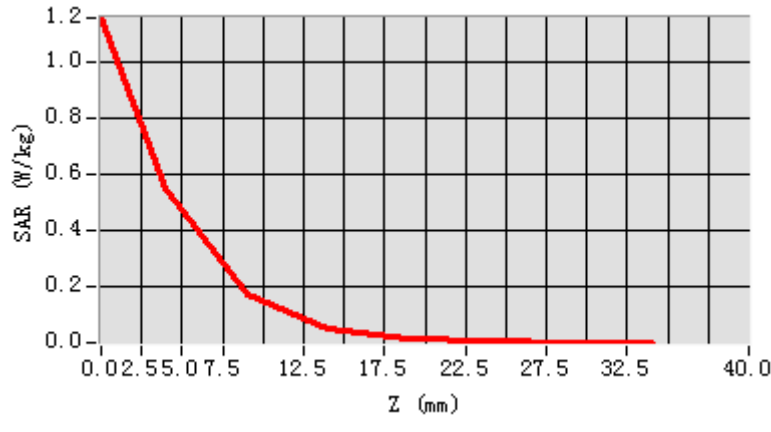

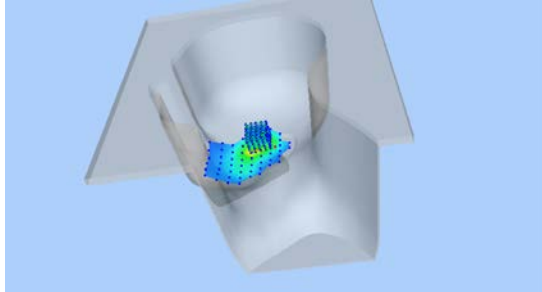
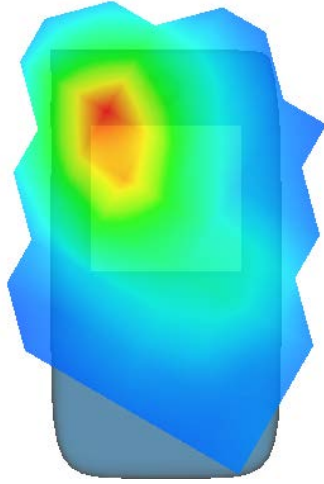
3D screen shot	Hot spot position
	

## MEASUREMENT 6

Rear-side-middle

Type: Phone measurement (Complete)

Date of measurement: 13/11/2018

Measurement duration: 11 minutes 57 seconds

### A. Experimental conditions.

<u>Area Scan</u>	<u>dx=12mm dy=12mm</u>
<u>ZoomScan</u>	<u>7x7x7,dx=5mm dy=5mm dz=5mm,Complete</u>
<u>Phantom</u>	<u>Validation plane</u>
<u>Device Position</u>	<u>Body</u>
<u>Band</u>	<u>IEEE 802.11b ISM</u>
<u>Channels</u>	<u>Middle</u>
<u>Signal</u>	<u>IEEE802.b (Crest factor: 1.0)</u>
<u>Conversion factor</u>	<u>5.02</u>

### B. SAR Measurement Results

Middle Band SAR (Channel 6):

<b>Frequency (MHz)</b>	2437.000000
<b>Relative permittivity (real part)</b>	53.066399
<b>Relative permittivity (imaginary part)</b>	14.968200
<b>Conductivity (S/m)</b>	2.030686
<b>Variation (%)</b>	-1.010000

### SURFACE SAR

### VOLUME SAR

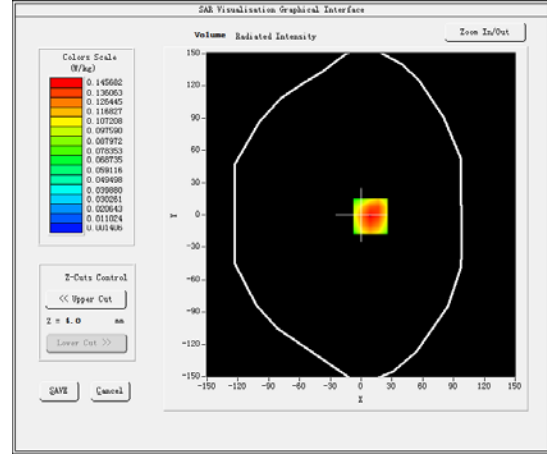
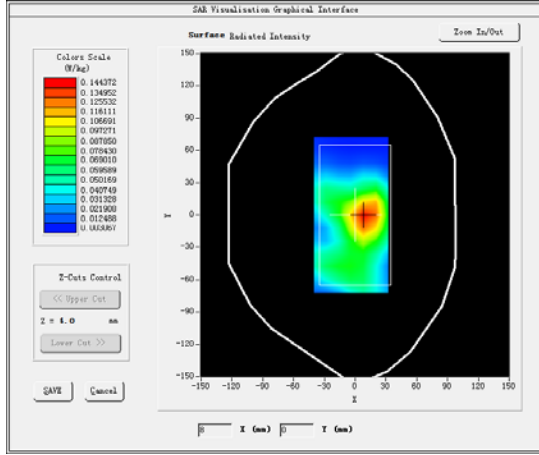

Maximum location: X=9.00, Y=-1.00

SAR Peak: 0.29 W/kg

SAR 10g (W/Kg)	0.067087
SAR 1g (W/Kg)	0.148399

Z (mm)	0.00	4.00	9.00	14.00	19.00	24.00	29.00
SAR (W/Kg)	0.2892	0.1457	0.0517	0.0191	0.0076	0.0036	0.0021

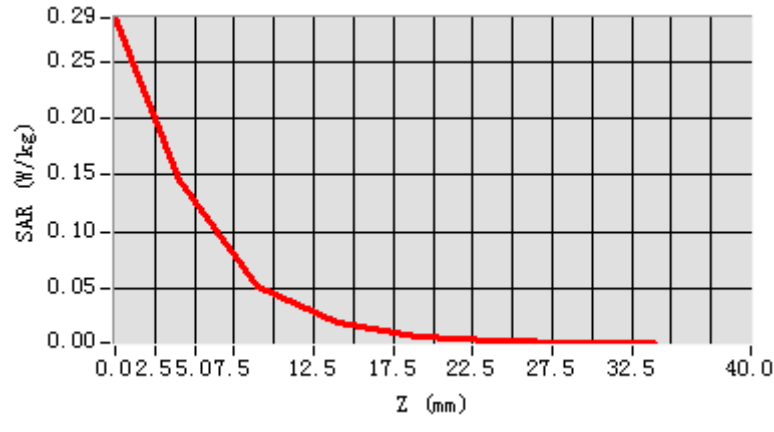

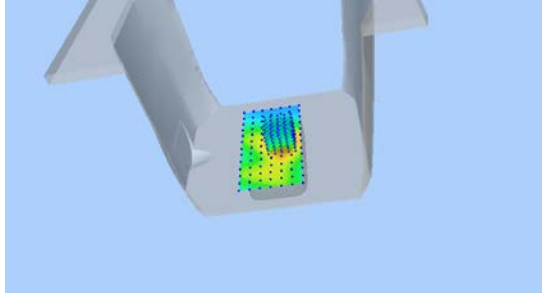
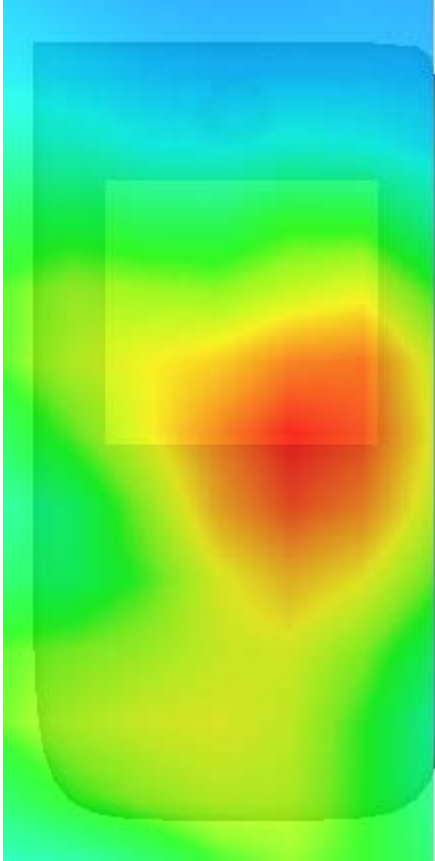
3D screen shot	Hot spot position
	

## MEASUREMENT 7

Rear-side-middle

Type: Phone measurement (Complete)

Date of measurement: 13/11/2018

Measurement duration: 10 minutes 50 seconds

### A. Experimental conditions.

<b><u>Area Scan</u></b>	<u>dx=15mm dy=15mm</u>
<b><u>ZoomScan</u></b>	<u>5x5x7,dx=8mm dy=8mm dz=5mm,Complete</u>
<b><u>Phantom</u></b>	<u>Validation plane</u>
<b><u>Device Position</u></b>	<u>Body</u>
<b><u>Band</u></b>	<u>CUSTOM (GPRS850_1Tx)</u>
<b><u>Channels</u></b>	<u>Low</u>
<b><u>Signal</u></b>	<u>Duty Cycle: 0.12 (Crest factor: 0.1)</u>
<b><u>Conversion factor</u></b>	<u>5.75</u>

### B. SAR Measurement Results

<b>Frequency (MHz)</b>	824.200012
<b>Relative permittivity (real part)</b>	55.242077
<b>Relative permittivity (imaginary part)</b>	21.378187
<b>Conductivity (S/m)</b>	0.978883
<b>Variation (%)</b>	1.080000



### SURFACE SAR

### VOLUME SAR

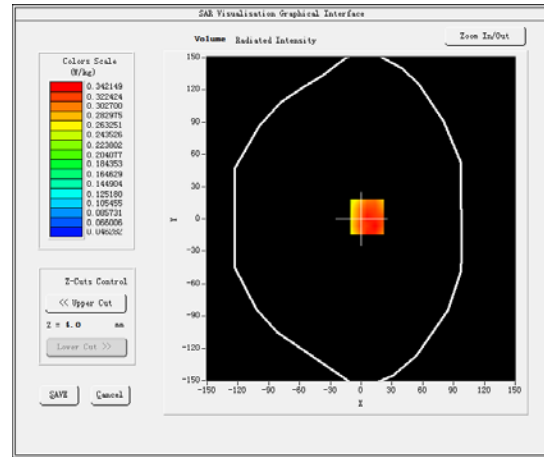
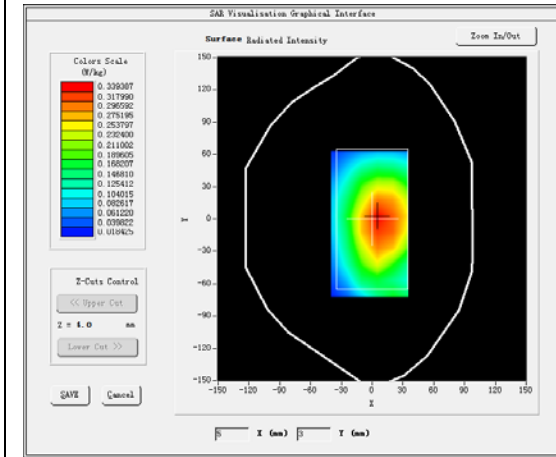

**Maximum location: X=6.00, Y=2.00**

**SAR Peak: 0.42 W/kg**

<b>SAR 10g (W/Kg)</b>	0.244579
<b>SAR 1g (W/Kg)</b>	0.327291

Z (mm)	0.00	4.00	9.00	14.00	19.00	24.00	29.00
SAR (W/Kg)	0.4975	0.3421	0.2270	0.2052	0.1320	0.1210	0.0770

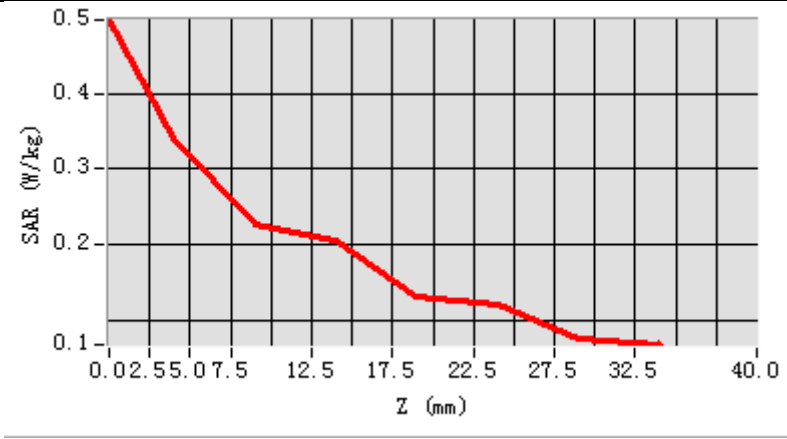

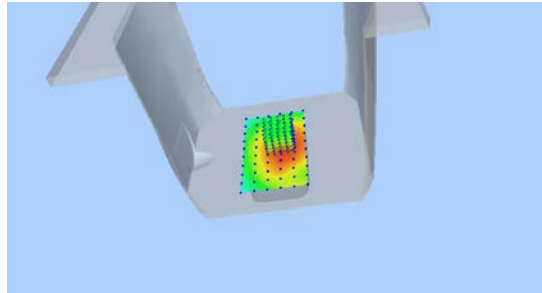
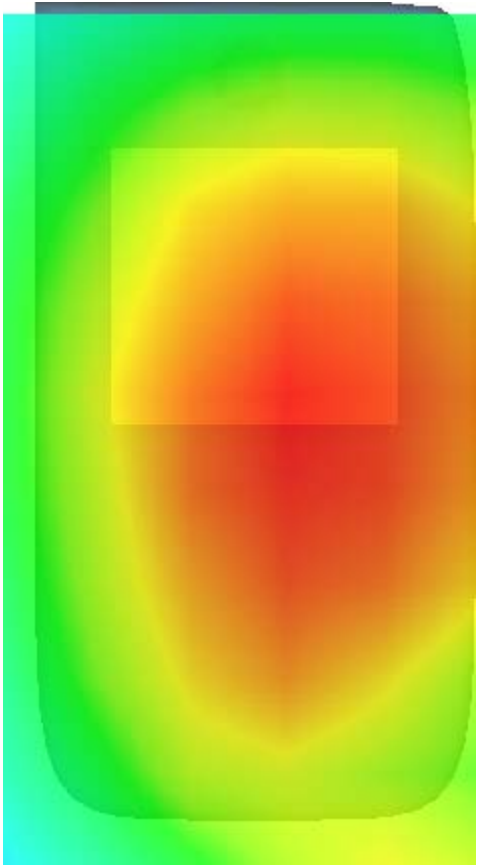
3D screen shot	Hot spot position
	

## MEASUREMENT 8

Type: Phone measurement (Complete)

Date of measurement: 12/11/2018

Measurement duration: 8 minutes 12 seconds

### A. Experimental conditions.

<b><u>Area Scan</u></b>	<u>dx=15mm dy=15mm</u>
<b><u>ZoomScan</u></b>	<u>5x5x7,dx=8mm dy=8mm dz=5mm,Complete</u>
<b><u>Phantom</u></b>	<u>Left head</u>
<b><u>Device Position</u></b>	<u>Tilt</u>
<b><u>Band</u></b>	<u>CUSTOM (GPRS1900 4Tx)</u>
<b><u>Channels</u></b>	<u>Middle</u>
<b><u>Signal</u></b>	<u>Duty Cycle: 2.00 (Crest factor: 2.0)</u>
<b><u>Conversion factor</u></b>	<u>5.17</u>

### B. SAR Measurement Results

<b>Frequency (MHz)</b>	1880.000000
<b>Relative permittivity (real part)</b>	40.660301
<b>Relative permittivity (imaginary part)</b>	13.075800
<b>Conductivity (S/m)</b>	1.365695
<b>Variation (%)</b>	-1.580000

### SURFACE SAR

### VOLUME SAR

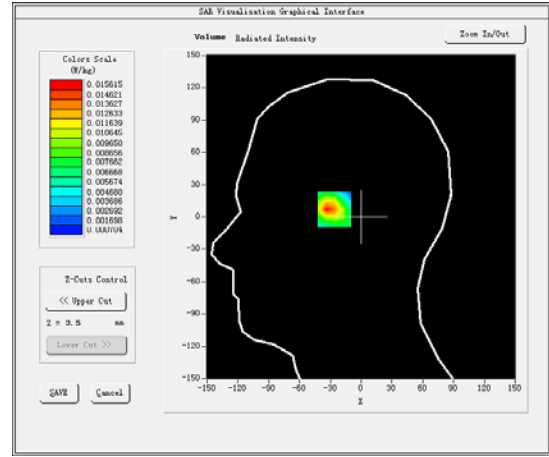
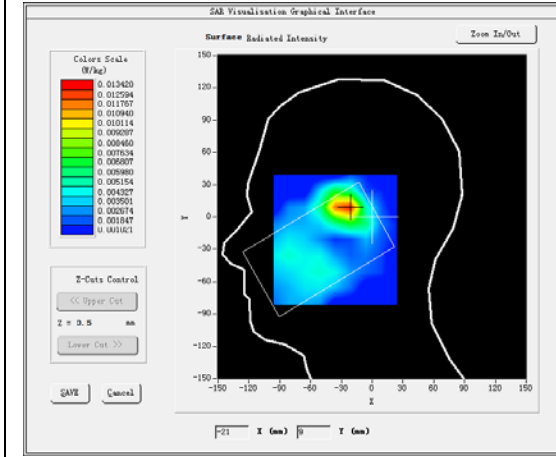

**Maximum location: X=-24.00, Y=9.00**

**SAR Peak: 0.03 W/kg**

<b>SAR 10g (W/Kg)</b>	0.006744
<b>SAR 1g (W/Kg)</b>	0.014570

Z (mm)	0.00	4.00	9.00	14.00	19.00	24.00	29.00
SAR (W/Kg)	0.0324	0.0156	0.0051	0.0039	0.0017	0.0015	0.0010

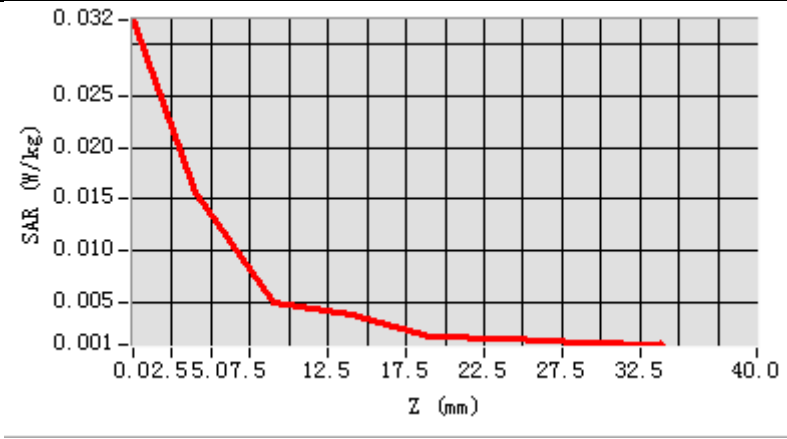

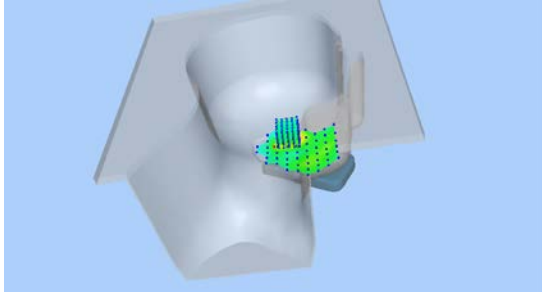
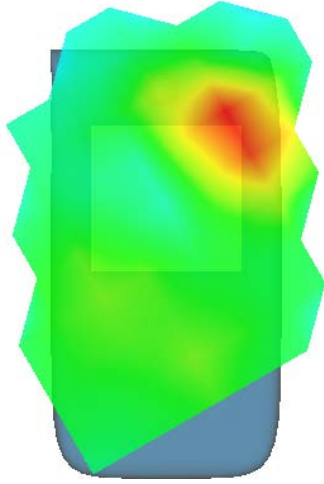
3D screen shot	Hot spot position
	

## MEASUREMENT 9

Rear-side-middle

Type: Phone measurement (Complete)

Date of measurement: 12/11/2018

Measurement duration: 11 minutes 14 seconds

### A. Experimental conditions.

<u>Area Scan</u>	<u>dx=15mm dy=15mm</u>
<u>ZoomScan</u>	<u>5x5x7,dx=8mm dy=8mm dz=5mm,Complete</u>
<u>Phantom</u>	<u>Validation plane</u>
<u>Device Position</u>	<u>Body</u>
<u>Band</u>	<u>CUSTOM (GPRS1900_4Tx)</u>
<u>Channels</u>	<u>Middle</u>
<u>Signal</u>	<u>Duty Cycle: 2.00 (Crest factor: 2.0)</u>
<u>Conversion factor</u>	<u>5.28</u>

### B. SAR Measurement Results

<b>Frequency (MHz)</b>	1880.000000
<b>Relative permittivity (real part)</b>	51.470901
<b>Relative permittivity (imaginary part)</b>	15.022000
<b>Conductivity (S/m)</b>	1.568964
<b>Variation (%)</b>	-2.190000

### SURFACE SAR

### VOLUME SAR

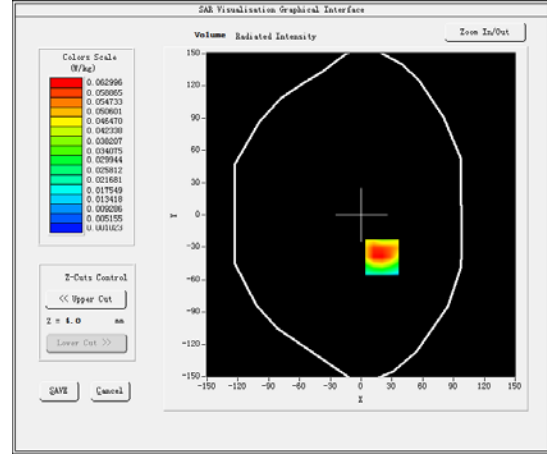
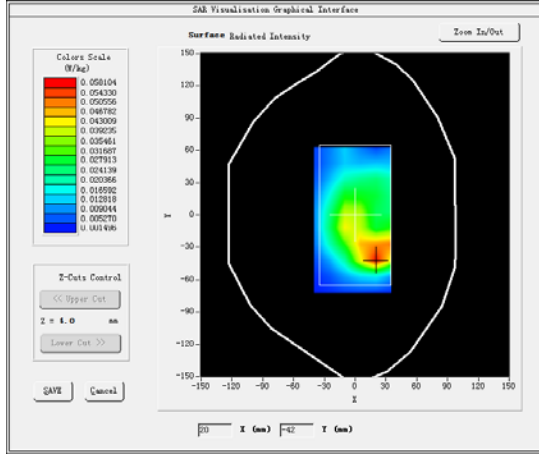

**Maximum location: X=20.00, Y=-39.00**

**SAR Peak: 0.12 W/kg**

<b>SAR 10g (W/Kg)</b>	0.030372
<b>SAR 1g (W/Kg)</b>	0.065269

Z (mm)	0.00	4.00	9.00	14.00	19.00	24.00	29.00
SAR (W/Kg)	0.1118	0.0630	0.0283	0.0129	0.0061	0.0031	0.0018

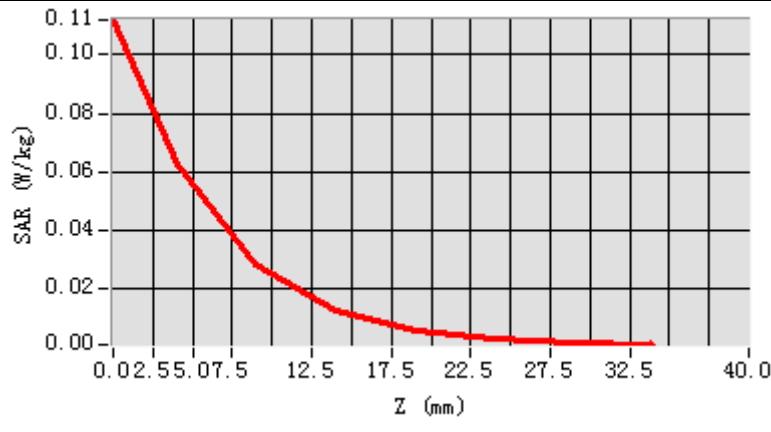

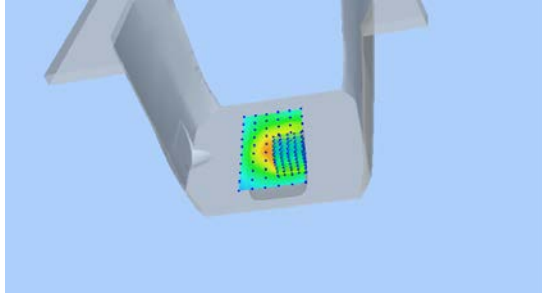
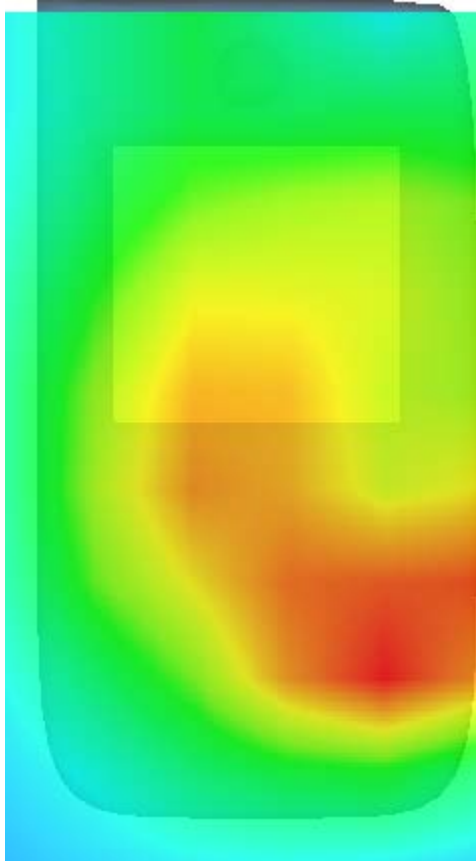
3D screen shot	Hot spot position
	



## MEASUREMENT 10

Type: Phone measurement (Complete)

Date of measurement: 13/11/2018

Measurement duration: 10 minutes 11 seconds

### A. Experimental conditions.

<b><u>Area Scan</u></b>	<u>dx=15mm dy=15mm</u>
<b><u>ZoomScan</u></b>	<u>5x5x7,dx=8mm dy=8mm dz=5mm,Complete</u>
<b><u>Phantom</u></b>	<u>Left head</u>
<b><u>Device Position</u></b>	<u>Cheek</u>
<b><u>Band</u></b>	<u>CUSTOM (GPRS850 4Tx)</u>
<b><u>Channels</u></b>	<u>Low</u>
<b><u>Signal</u></b>	<u>Duty Cycle: 2.00 (Crest factor: 2.0)</u>
<b><u>Conversion factor</u></b>	<u>5.54</u>

### B. SAR Measurement Results

<b>Frequency (MHz)</b>	824.200012
<b>Relative permittivity (real part)</b>	53.891621
<b>Relative permittivity (imaginary part)</b>	20.664499
<b>Conductivity (S/m)</b>	0.946204
<b>Variation (%)</b>	2.760000

### SURFACE SAR

### VOLUME SAR

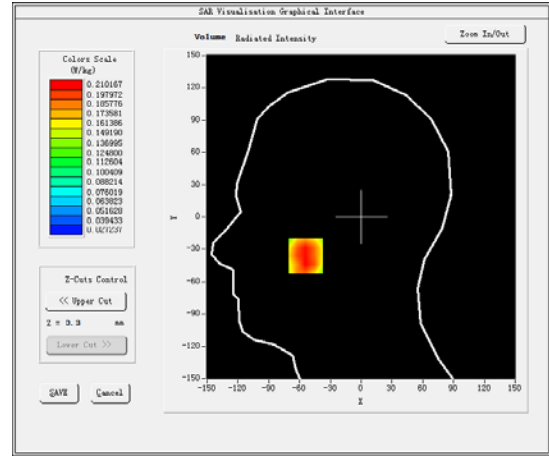
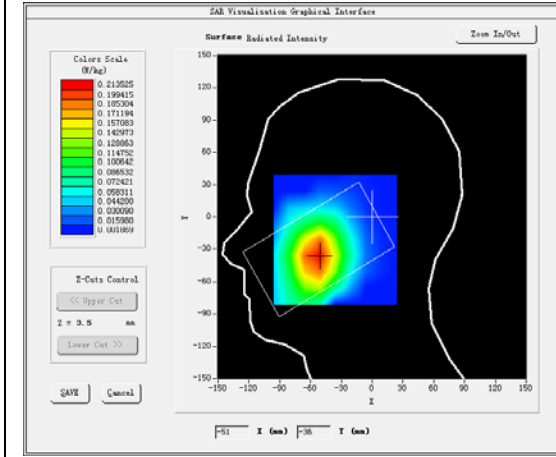

**Maximum location: X=-54.00, Y=-36.00**

**SAR Peak: 0.28 W/kg**

<b>SAR 10g (W/Kg)</b>	0.151734
<b>SAR 1g (W/Kg)</b>	0.207035

Z (mm)	0.00	4.00	9.00	14.00	19.00	24.00	29.00
SAR (W/Kg)	0.2768	0.2102	0.1612	0.1280	0.1064	0.0870	0.0630

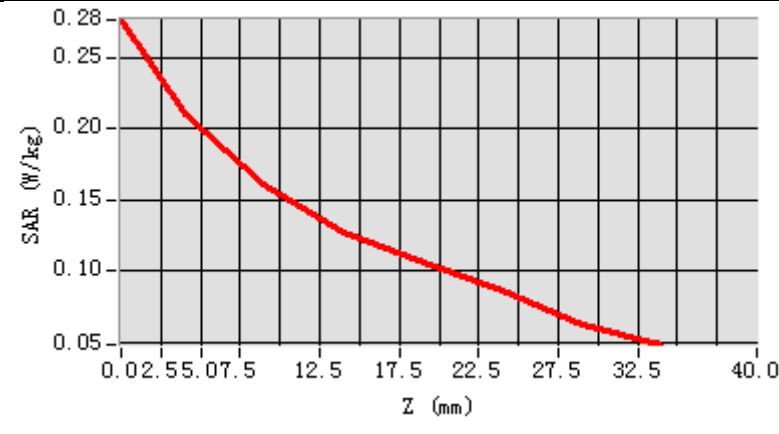

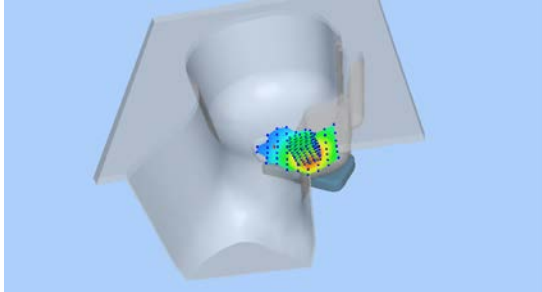
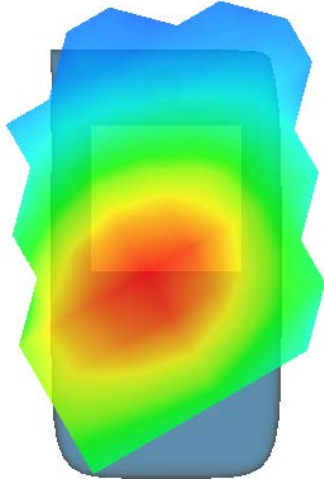
3D screen shot	Hot spot position
	



**Annex C: Calibration Reports**

**Tested Model : B2**

**Report Number:  
FCC18110006A-SAR**



## SAR Reference Dipole Calibration Report

Ref: ACR.176.1.15.SATU.A

WORLD STANDARDIZATION CERTIFICATION  
& TESTING GROUP CO.,LTD  
BLOCK A-B, BAO SHI SCIENCE PARK,BAO SHI ROAD,  
BAO'AN DISTRICT  
SHENZHEN 518108,P.R. CHINA  
**MVG COMOSAR REFERENCE DIPOLE**  
FREQUENCY: 835 MHZ  
SERIAL NO.: SN 14/13 DIP 0G835-235

Calibrated at MVG US  
2105 Barrett Park Dr. - Kennesaw, GA 30144



Calibration Date: 7/25/2018

### *Summary:*

This document presents the method and results from an accredited SAR reference dipole calibration performed in MVG USA using the COMOSAR test bench. All calibration results are traceable to national metrology institutions.



	<i>Name</i>	<i>Function</i>	<i>Date</i>	<i>Signature</i>
<i>Prepared by :</i>	Jérôme LUC	Product Manager	7/25/2018	<i>JS</i>
<i>Checked by :</i>	Jérôme LUC	Product Manager	7/25/2018	<i>JS</i>
<i>Approved by :</i>	Kim RUTKOWSKI	Quality Manager	7/25/2018	<i>Kim Rutkowski</i>

	<i>Customer Name</i>
<i>Distribution :</i>	WORLD STANDARDIZATION CERTIFICATION & TESTING GROUP CO.,LTD

<i>Issue</i>	<i>Date</i>	<i>Modifications</i>
A	7/25/2018	Initial release



**TABLE OF CONTENTS**

1 Introduction ..... 4

2 Device Under Test ..... 4

3 Product Description ..... 4

    3.1 General Information ..... 4

4 Measurement Method ..... 5

    4.1 Return Loss Requirements ..... 5

    4.2 Mechanical Requirements ..... 5

5 Measurement Uncertainty ..... 5

    5.1 Return Loss ..... 5

    5.2 Dimension Measurement ..... 5

    5.3 Validation Measurement ..... 5

6 Calibration Measurement Results ..... 6

    6.1 Return Loss and Impedance In Head Liquid ..... 6

    6.2 Return Loss and Impedance In Body Liquid ..... 6

    6.3 Mechanical Dimensions ..... 6

7 Validation measurement ..... 7

    7.1 Head Liquid Measurement ..... 7

    7.2 SAR Measurement Result With Head Liquid ..... 8

    7.3 Body Liquid Measurement ..... 9

    7.4 SAR Measurement Result With Body Liquid ..... 10

8 List of Equipment ..... 11

**1 INTRODUCTION**

This document contains a summary of the requirements set forth by the IEEE 1528, FCC KDBs and CEI/IEC 62209 standards for reference dipoles used for SAR measurement system validations and the measurements that were performed to verify that the product complies with the fore mentioned standards.

**2 DEVICE UNDER TEST**

<b>Device Under Test</b>	
Device Type	COMOSAR 835 MHz REFERENCE DIPOLE
Manufacturer	MVG
Model	SID835
Serial Number	SN 14/13 DIP 0G835-235
Product Condition (new / used)	Used

A yearly calibration interval is recommended.

**3 PRODUCT DESCRIPTION**

**3.1 GENERAL INFORMATION**

MVG’s COMOSAR Validation Dipoles are built in accordance to the IEEE 1528, FCC KDBs and CEI/IEC 62209 standards. The product is designed for use with the COMOSAR test bench only.



**Figure 1 – MVG COMOSAR Validation Dipole**





#### 4 MEASUREMENT METHOD

The IEEE 1528, FCC KDBs and CEI/IEC 62209 standards provide requirements for reference dipoles used for system validation measurements. The following measurements were performed to verify that the product complies with the fore mentioned standards.

##### 4.1 RETURN LOSS REQUIREMENTS

The dipole used for SAR system validation measurements and checks must have a return loss of -20 dB or better. The return loss measurement shall be performed against a liquid filled flat phantom, with the phantom constructed as outlined in the fore mentioned standards.

##### 4.2 MECHANICAL REQUIREMENTS

The IEEE Std. 1528 and CEI/IEC 62209 standards specify the mechanical components and dimensions of the validation dipoles, with the dimensions frequency and phantom shell thickness dependent. The COMOSAR test bench employs a 2 mm phantom shell thickness therefore the dipoles sold for use with the COMOSAR test bench comply with the requirements set forth for a 2 mm phantom shell thickness.

#### 5 MEASUREMENT UNCERTAINTY

All uncertainties listed below represent an expanded uncertainty expressed at approximately the 95% confidence level using a coverage factor of k=2, traceable to the Internationally Accepted Guides to Measurement Uncertainty.

##### 5.1 RETURN LOSS

The following uncertainties apply to the return loss measurement:

Frequency band	Expanded Uncertainty on Return Loss
400-6000MHz	0.1 dB

##### 5.2 DIMENSION MEASUREMENT

The following uncertainties apply to the dimension measurements:

Length (mm)	Expanded Uncertainty on Length
3 - 300	0.05 mm

##### 5.3 VALIDATION MEASUREMENT

The guidelines outlined in the IEEE 1528, FCC KDBs, CENELEC EN50361 and CEI/IEC 62209 standards were followed to generate the measurement uncertainty for validation measurements.

Scan Volume	Expanded Uncertainty
1g	20.3 %

10 g	20.1 %
------	--------

## 6 CALIBRATION MEASUREMENT RESULTS

### 6.1 RETURN LOSS AND IMPEDANCE IN HEAD LIQUID

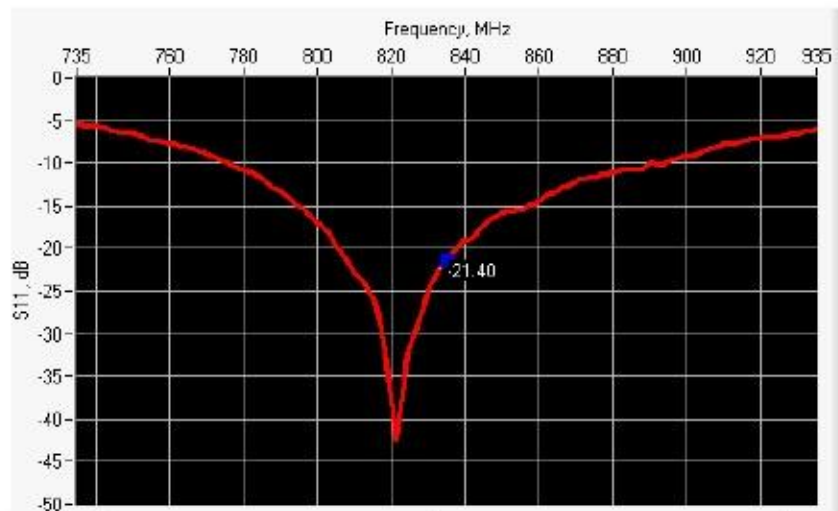

Frequency (MHz)	Return Loss (dB)	Requirement (dB)	Impedance
835	-21.40	-20	59.2 Ω - 1.5 j

### 6.2 RETURN LOSS AND IMPEDANCE IN BODY LIQUID

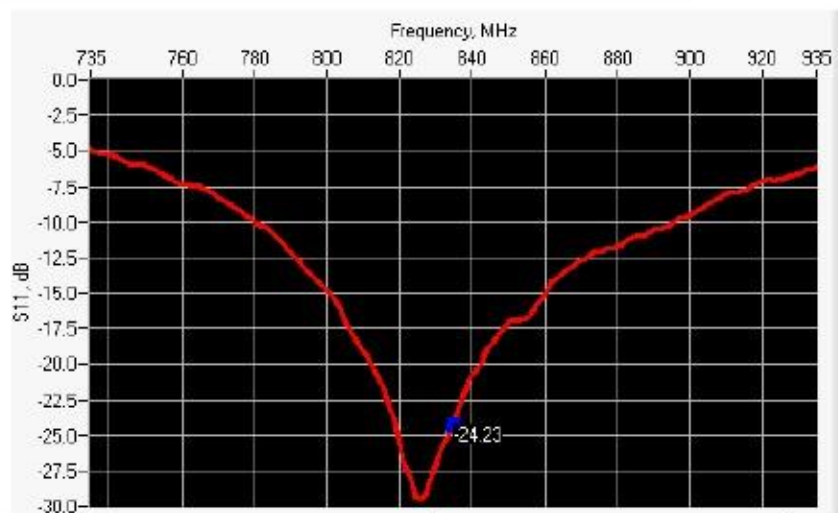

Frequency (MHz)	Return Loss (dB)	Requirement (dB)	Impedance
835	-24.23	-20	56.3 Ω + 1.7 j

### 6.3 MECHANICAL DIMENSIONS

Frequency MHz	L mm		h mm		d mm	
	required	measured	required	measured	required	measured
300	420.0 ± 1 %		250.0 ± 1 %		6.35 ± 1 %	



450	290.0 ±1 %.		166.7 ±1 %.		6.35 ±1 %.	
750	176.0 ±1 %.		100.0 ±1 %.		6.35 ±1 %.	
835	161.0 ±1 %.	PASS	89.8 ±1 %.	PASS	3.6 ±1 %.	PASS
900	149.0 ±1 %.		83.3 ±1 %.		3.6 ±1 %.	
1450	89.1 ±1 %.		51.7 ±1 %.		3.6 ±1 %.	
1500	80.5 ±1 %.		50.0 ±1 %.		3.6 ±1 %.	
1640	79.0 ±1 %.		45.7 ±1 %.		3.6 ±1 %.	
1750	75.2 ±1 %.		42.9 ±1 %.		3.6 ±1 %.	
1800	72.0 ±1 %.		41.7 ±1 %.		3.6 ±1 %.	
1900	68.0 ±1 %.		39.5 ±1 %.		3.6 ±1 %.	
1950	66.3 ±1 %.		38.5 ±1 %.		3.6 ±1 %.	
2000	64.5 ±1 %.		37.5 ±1 %.		3.6 ±1 %.	
2100	61.0 ±1 %.		35.7 ±1 %.		3.6 ±1 %.	
2300	55.5 ±1 %.		32.6 ±1 %.		3.6 ±1 %.	
2450	51.5 ±1 %.		30.4 ±1 %.		3.6 ±1 %.	
2600	48.5 ±1 %.		28.8 ±1 %.		3.6 ±1 %.	
3000	41.5 ±1 %.		25.0 ±1 %.		3.6 ±1 %.	
3500	37.0 ±1 %.		26.4 ±1 %.		3.6 ±1 %.	
3700	34.7 ±1 %.		26.4 ±1 %.		3.6 ±1 %.	

**7 VALIDATION MEASUREMENT**

The IEEE Std. 1528, FCC KDBs and CEI/IEC 62209 standards state that the system validation measurements must be performed using a reference dipole meeting the fore mentioned return loss and mechanical dimension requirements. The validation measurement must be performed against a liquid filled flat phantom, with the phantom constructed as outlined in the fore mentioned standards. Per the standards, the dipole shall be positioned below the bottom of the phantom, with the dipole length centered and parallel to the longest dimension of the flat phantom, with the top surface of the dipole at the described distance from the bottom surface of the phantom.

**7.1 HEAD LIQUID MEASUREMENT**

Frequency MHz	Relative permittivity ( $\epsilon_r$ )		Conductivity ( $\sigma$ ) S/m	
	required	measured	required	measured
300	45.3 ±5 %		0.87 ±5 %	
450	43.5 ±5 %		0.87 ±5 %	
750	41.9 ±5 %		0.89 ±5 %	
835	41.5 ±5 %	PASS	0.90 ±5 %	PASS
900	41.5 ±5 %		0.97 ±5 %	
1450	40.5 ±5 %		1.20 ±5 %	
1500	40.4 ±5 %		1.23 ±5 %	
1640	40.2 ±5 %		1.31 ±5 %	
1750	40.1 ±5 %		1.37 ±5 %	



1800	40.0 ±5 %		1.40 ±5 %	
1900	40.0 ±5 %		1.40 ±5 %	
1950	40.0 ±5 %		1.40 ±5 %	
2000	40.0 ±5 %		1.40 ±5 %	
2100	39.8 ±5 %		1.49 ±5 %	
2300	39.5 ±5 %		1.67 ±5 %	
2450	39.2 ±5 %		1.80 ±5 %	
2600	39.0 ±5 %		1.96 ±5 %	
3000	38.5 ±5 %		2.40 ±5 %	
3500	37.9 ±5 %		2.91 ±5 %	

7.2 SAR MEASUREMENT RESULT WITH HEAD LIQUID

The IEEE Std. 1528 and CEI/IEC 62209 standards state that the system validation measurements should produce the SAR values shown below (for phantom thickness of 2 mm), within the uncertainty for the system validation. All SAR values are normalized to 1 W forward power. In bracket, the measured SAR is given with the used input power.

Software	OPENSAR V4
Phantom	SN 20/09 SAM71
Probe	SN 18/11 EPG122
Liquid	Head Liquid Values: $\epsilon_p' : 42.3$ $\sigma : 0.92$
Distance between dipole center and liquid	15.0 mm
Area scan resolution	$dx=8mm/dy=8mm$
Zoon Scan Resolution	$dx=8mm/dy=8mm/dz=5mm$
Frequency	835 MHz
Input power	20 dBm
Liquid Temperature	21 °C
Lab Temperature	21 °C
Lab Humidity	45 %

Frequency MHz	1 g SAR (W/kg/W)		10 g SAR (W/kg/W)	
	required	measured	required	measured
300	2.85		1.94	
450	4.58		3.06	
750	8.49		5.55	
835	9.56	9.82 (0.98)	6.22	6.35 (0.63)
900	10.9		6.99	
1450	29		16	
1500	30.5		16.8	
1640	34.2		18.4	
1750	36.4		19.3	
1800	38.4		20.1	

1900	39.7		20.5	
1950	40.5		20.9	
2000	41.1		21.1	
2100	43.6		21.9	
2300	48.7		23.3	
2450	52.4		24	
2600	55.3		24.6	
3000	63.8		25.7	
3500	67.1		25	

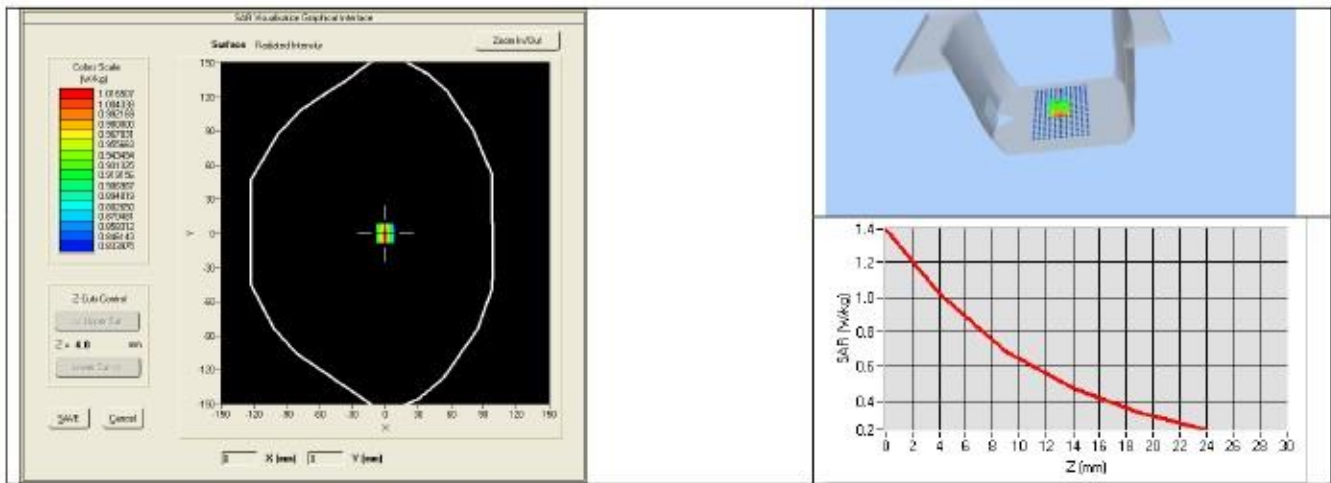

7.3 BODY LIQUID MEASUREMENT

Frequency MHz	Relative permittivity ( $\epsilon'$ )		Conductivity ( $\sigma$ ) S/m	
	required	measured	required	measured
150	61.9 ±5 %		0.80 ±5 %	
300	58.2 ±5 %		0.92 ±5 %	
450	56.7 ±5 %		0.94 ±5 %	
750	55.5 ±5 %		0.96 ±5 %	
835	55.2 ±5 %	PASS	0.97 ±5 %	PASS
900	55.0 ±5 %		1.05 ±5 %	
915	55.0 ±5 %		1.06 ±5 %	
1450	54.0 ±5 %		1.30 ±5 %	
1610	53.8 ±5 %		1.40 ±5 %	
1800	53.3 ±5 %		1.52 ±5 %	
1900	53.3 ±5 %		1.52 ±5 %	
2000	53.3 ±5 %		1.52 ±5 %	
2100	53.2 ±5 %		1.62 ±5 %	
2450	52.7 ±5 %		1.95 ±5 %	

2600	52.5 ±5 %		2.16 ±5 %	
3000	52.0 ±5 %		2.73 ±5 %	
3500	51.3 ±5 %		3.31 ±5 %	
5200	49.0 ±10 %		5.30 ±10 %	
5300	48.9 ±10 %		5.42 ±10 %	
5400	48.7 ±10 %		5.53 ±10 %	
5500	48.6 ±10 %		5.65 ±10 %	
5600	48.5 ±10 %		5.77 ±10 %	
5800	48.2 ±10 %		6.00 ±10 %	

7.4 SAR MEASUREMENT RESULT WITH BODY LIQUID

Software	OPENSAR V4
Phantom	SN 20/09 SAM71
Probe	SN 18/11 EPG122
Liquid	Body Liquid Values: eps' : 53.3 sigma : 0.97
Distance between dipole center and liquid	15.0 mm
Area scan resolution	dx=8mm/dy=8mm
Zoon Scan Resolution	dx=8mm/dy=8mm/dz=5mm
Frequency	835 MHz
Input power	20 dBm
Liquid Temperature	21 °C
Lab Temperature	21 °C
Lab Humidity	45 %

Frequency MHz	1 g SAR (W/kg/W)	10 g SAR (W/kg/W)
	measured	measured
835	9.41 (0.94)	6.22 (0.62)

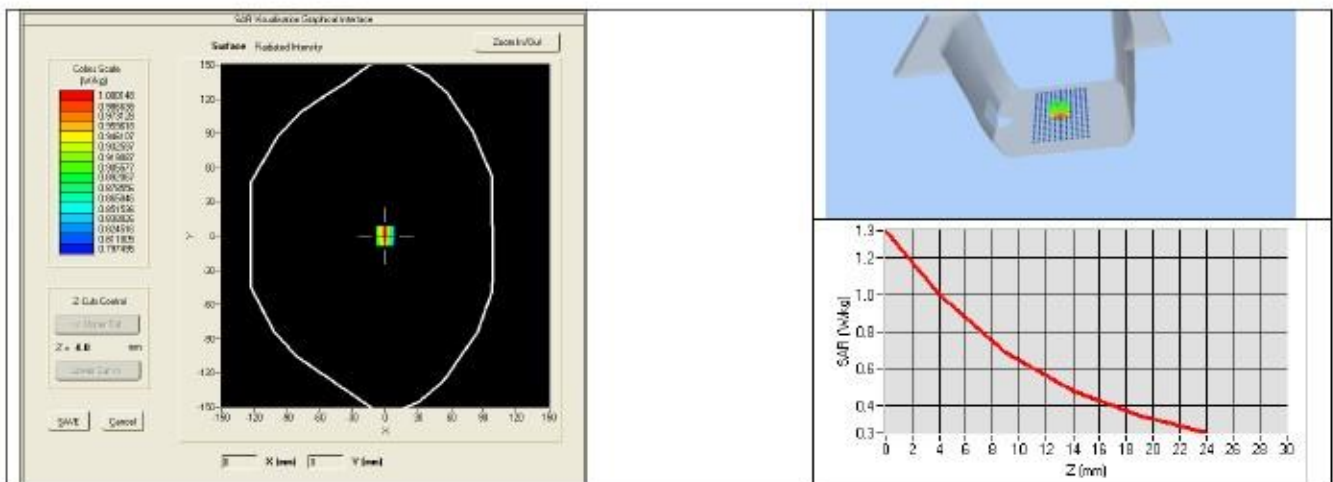

**8 LIST OF EQUIPMENT**

Equipment Summary Sheet				
Equipment Description	Manufacturer / Model	Identification No.	Current Calibration Date	Next Calibration Date
SAM Phantom	MVG	SN-20/09-SAM71	Validated. No cal required.	Validated. No cal required.
COMOSAR Test Bench	Version 3	NA	Validated. No cal required.	Validated. No cal required.
Network Analyzer	Rhode & Schwarz ZVA	SN100132	02/2016	02/2019
Calipers	Carrera	CALIPER-01	12/2016	12/2019
Reference Probe	MVG	EPG122 SN 18/11	01/2017	01/2020
Multimeter	Keithley 2000	1188656	01/2017	01/2020
Signal Generator	Agilent E4438C	MY49070581	012017	01/2020
Amplifier	Aethercomm	SN 046	Characterized prior to test. No cal required.	Characterized prior to test. No cal required.
Power Meter	HP E4418A	US38261498	01/2017	01/2020
Power Sensor	HP ECP-E26A	US37181460	01/2017	01/2020
Directional Coupler	Narda 4216-20	01386	Characterized prior to test. No cal required.	Characterized prior to test. No cal required.
Temperature and Humidity Sensor	Control Company	11-661-9	11/2017	11/2020



## SAR Reference Dipole Calibration Report

Ref: ACR.176.4.15.SATU.A

WORLD STANDARDIZATION CERTIFICATION  
& TESTING GROUP CO.,LTD  
BLOCK A-B, BAO SHI SCIENCE PARK,BAO SHI ROAD,  
BAO'AN DISTRICT  
SHENZHEN 518108,P.R. CHINA  
MVG COMOSAR REFERENCE DIPOLE  
FREQUENCY: 1900 MHZ  
SERIAL NO.: SN 14/13 DIP 1G900-236

Calibrated at MVG US  
2105 Barrett Park Dr. - Kennesaw, GA 30144



Calibration Date: 7/25/2018

### *Summary:*

This document presents the method and results from an accredited SAR reference dipole calibration performed in MVG USA using the COMOSAR test bench. All calibration results are traceable to national metrology institutions.





	<i>Name</i>	<i>Function</i>	<i>Date</i>	<i>Signature</i>
<i>Prepared by :</i>	Jérôme LUC	Product Manager	7/25/2018	<i>JS</i>
<i>Checked by :</i>	Jérôme LUC	Product Manager	7/25/2018	<i>JS</i>
<i>Approved by :</i>	Kim RUTKOWSKI	Quality Manager	7/25/2018	<i>Kim Rutkowski</i>

	<i>Customer Name</i>
<i>Distribution :</i>	WORLD STANDARDIZATION CERTIFICATION & TESTING GROUP CO.,LTD

<i>Issue</i>	<i>Date</i>	<i>Modifications</i>
A	7/25/2018	Initial release



**TABLE OF CONTENTS**

1 Introduction ..... 4

2 Device Under Test ..... 4

3 Product Description ..... 4

    3.1 General Information ..... 4

4 Measurement Method ..... 5

    4.1 Return Loss Requirements ..... 5

    4.2 Mechanical Requirements ..... 5

5 Measurement Uncertainty ..... 5

    5.1 Return Loss ..... 5

    5.2 Dimension Measurement ..... 5

    5.3 Validation Measurement ..... 5

6 Calibration Measurement Results ..... 6

    6.1 Return Loss and Impedance In Head Liquid ..... 6

    6.2 Return Loss and Impedance In Body Liquid ..... 6

    6.3 Mechanical Dimensions ..... 6

7 Validation measurement ..... 7

    7.1 Head Liquid Measurement ..... 7

    7.2 SAR Measurement Result With Head Liquid ..... 8

    7.3 Body Liquid Measurement ..... 9

    7.4 SAR Measurement Result With Body Liquid ..... 10

8 List of Equipment ..... 11

**1 INTRODUCTION**

This document contains a summary of the requirements set forth by the IEEE 1528, FCC KDBs and CEI/IEC 62209 standards for reference dipoles used for SAR measurement system validations and the measurements that were performed to verify that the product complies with the fore mentioned standards.

**2 DEVICE UNDER TEST**

Device Under Test	
Device Type	COMOSAR 1900 MHz REFERENCE DIPOLE
Manufacturer	MVG
Model	SID1900
Serial Number	SN 14/13 DIP 1G900-236
Product Condition (new / used)	Used

A yearly calibration interval is recommended.

**3 PRODUCT DESCRIPTION**

**3.1 GENERAL INFORMATION**

MVG’s COMOSAR Validation Dipoles are built in accordance to the IEEE 1528, FCC KDBs and CEI/IEC 62209 standards. The product is designed for use with the COMOSAR test bench only.



**Figure 1 – MVG COMOSAR Validation Dipole**



#### 4 MEASUREMENT METHOD

The IEEE 1528, FCC KDBs and CEI/IEC 62209 standards provide requirements for reference dipoles used for system validation measurements. The following measurements were performed to verify that the product complies with the fore mentioned standards.

##### 4.1 RETURN LOSS REQUIREMENTS

The dipole used for SAR system validation measurements and checks must have a return loss of -20 dB or better. The return loss measurement shall be performed against a liquid filled flat phantom, with the phantom constructed as outlined in the fore mentioned standards.

##### 4.2 MECHANICAL REQUIREMENTS

The IEEE Std. 1528 and CEI/IEC 62209 standards specify the mechanical components and dimensions of the validation dipoles, with the dimensions frequency and phantom shell thickness dependent. The COMOSAR test bench employs a 2 mm phantom shell thickness therefore the dipoles sold for use with the COMOSAR test bench comply with the requirements set forth for a 2 mm phantom shell thickness.

#### 5 MEASUREMENT UNCERTAINTY

All uncertainties listed below represent an expanded uncertainty expressed at approximately the 95% confidence level using a coverage factor of k=2, traceable to the Internationally Accepted Guides to Measurement Uncertainty.

##### 5.1 RETURN LOSS

The following uncertainties apply to the return loss measurement:

Frequency band	Expanded Uncertainty on Return Loss
400-6000MHz	0.1 dB

##### 5.2 DIMENSION MEASUREMENT

The following uncertainties apply to the dimension measurements:

Length (mm)	Expanded Uncertainty on Length
3 - 300	0.05 mm

##### 5.3 VALIDATION MEASUREMENT

The guidelines outlined in the IEEE 1528, FCC KDBs, CENELEC EN50361 and CEI/IEC 62209 standards were followed to generate the measurement uncertainty for validation measurements.

Scan Volume	Expanded Uncertainty
1g	20.3 %

10 g	20.1 %
------	--------

## 6 CALIBRATION MEASUREMENT RESULTS

### 6.1 RETURN LOSS AND IMPEDANCE IN HEAD LIQUID

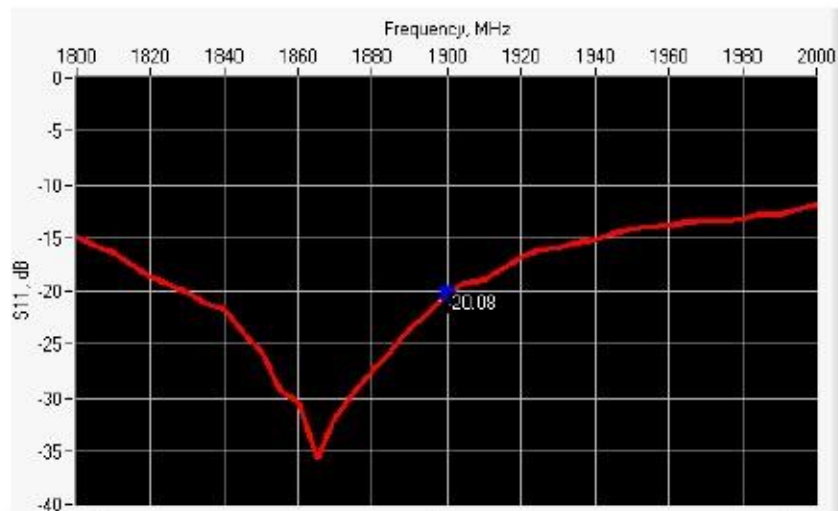

Frequency (MHz)	Return Loss (dB)	Requirement (dB)	Impedance
1900	-20.08	-20	54.9 Ω + 9.2 j

### 6.2 RETURN LOSS AND IMPEDANCE IN BODY LIQUID

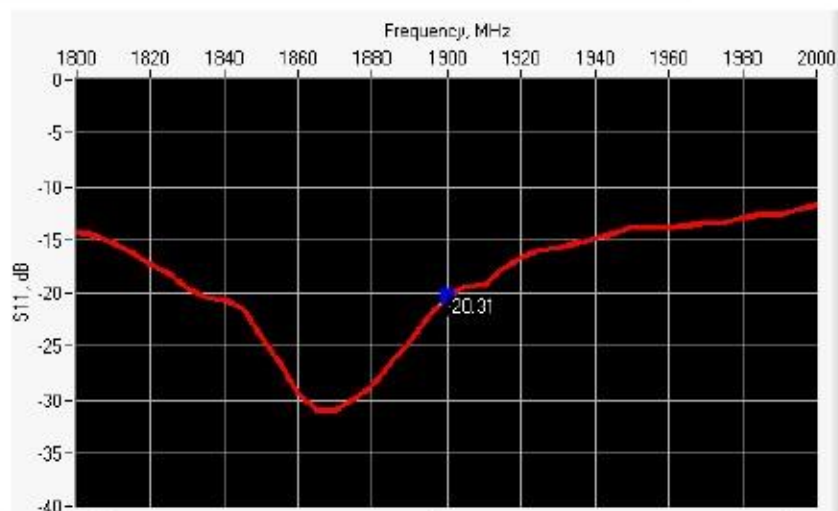

Frequency (MHz)	Return Loss (dB)	Requirement (dB)	Impedance
1900	-20.31	-20	49.7 Ω + 9.7 j

### 6.3 MECHANICAL DIMENSIONS

Frequency MHz	L mm		h mm		d mm	
	required	measured	required	measured	required	measured
300	420.0 ± 1 %.		250.0 ± 1 %.		6.35 ± 1 %.	



450	290.0 ±1 %.		166.7 ±1 %.		6.35 ±1 %.	
750	176.0 ±1 %.		100.0 ±1 %.		6.35 ±1 %.	
835	161.0 ±1 %.		89.8 ±1 %.		3.6 ±1 %.	
900	149.0 ±1 %.		83.3 ±1 %.		3.6 ±1 %.	
1450	89.1 ±1 %.		51.7 ±1 %.		3.6 ±1 %.	
1500	80.5 ±1 %.		50.0 ±1 %.		3.6 ±1 %.	
1640	79.0 ±1 %.		45.7 ±1 %.		3.6 ±1 %.	
1750	75.2 ±1 %.		42.9 ±1 %.		3.6 ±1 %.	
1800	72.0 ±1 %.		41.7 ±1 %.		3.6 ±1 %.	
1900	68.0 ±1 %.	PASS	39.5 ±1 %.	PASS	3.6 ±1 %.	PASS
1950	66.3 ±1 %.		38.5 ±1 %.		3.6 ±1 %.	
2000	64.5 ±1 %.		37.5 ±1 %.		3.6 ±1 %.	
2100	61.0 ±1 %.		35.7 ±1 %.		3.6 ±1 %.	
2300	55.5 ±1 %.		32.6 ±1 %.		3.6 ±1 %.	
2450	51.5 ±1 %.		30.4 ±1 %.		3.6 ±1 %.	
2600	48.5 ±1 %.		28.8 ±1 %.		3.6 ±1 %.	
3000	41.5 ±1 %.		25.0 ±1 %.		3.6 ±1 %.	
3500	37.0 ±1 %.		26.4 ±1 %.		3.6 ±1 %.	
3700	34.7 ±1 %.		26.4 ±1 %.		3.6 ±1 %.	

**7 VALIDATION MEASUREMENT**

The IEEE Std. 1528, FCC KDBs and CEI/IEC 62209 standards state that the system validation measurements must be performed using a reference dipole meeting the fore mentioned return loss and mechanical dimension requirements. The validation measurement must be performed against a liquid filled flat phantom, with the phantom constructed as outlined in the fore mentioned standards. Per the standards, the dipole shall be positioned below the bottom of the phantom, with the dipole length centered and parallel to the longest dimension of the flat phantom, with the top surface of the dipole at the described distance from the bottom surface of the phantom.

**7.1 HEAD LIQUID MEASUREMENT**

Frequency MHz	Relative permittivity ( $\epsilon_r$ )		Conductivity ( $\sigma$ ) S/m	
	required	measured	required	measured
300	45.3 ±5 %		0.87 ±5 %	
450	43.5 ±5 %		0.87 ±5 %	
750	41.9 ±5 %		0.89 ±5 %	
835	41.5 ±5 %		0.90 ±5 %	
900	41.5 ±5 %		0.97 ±5 %	
1450	40.5 ±5 %		1.20 ±5 %	
1500	40.4 ±5 %		1.23 ±5 %	
1640	40.2 ±5 %		1.31 ±5 %	
1750	40.1 ±5 %		1.37 ±5 %	



1800	40.0 ±5 %		1.40 ±5 %	
1900	40.0 ±5 %	PASS	1.40 ±5 %	PASS
1950	40.0 ±5 %		1.40 ±5 %	
2000	40.0 ±5 %		1.40 ±5 %	
2100	39.8 ±5 %		1.49 ±5 %	
2300	39.5 ±5 %		1.67 ±5 %	
2450	39.2 ±5 %		1.80 ±5 %	
2600	39.0 ±5 %		1.96 ±5 %	
3000	38.5 ±5 %		2.40 ±5 %	
3500	37.9 ±5 %		2.91 ±5 %	

7.2 SAR MEASUREMENT RESULT WITH HEAD LIQUID

The IEEE Std. 1528 and CEI/IEC 62209 standards state that the system validation measurements should produce the SAR values shown below (for phantom thickness of 2 mm), within the uncertainty for the system validation. All SAR values are normalized to 1 W forward power. In bracket, the measured SAR is given with the used input power.

Software	OPENSAR V4
Phantom	SN 20/09 SAM71
Probe	SN 18/11 EPG122
Liquid	Head Liquid Values: eps' : 40.4 sigma : 1.41
Distance between dipole center and liquid	10.0 mm
Area scan resolution	dx=8mm/dy=8mm
Zoon Scan Resolution	dx=8mm/dy=8mm/dz=5mm
Frequency	1900 MHz
Input power	20 dBm
Liquid Temperature	21 °C
Lab Temperature	21 °C
Lab Humidity	45 %

Frequency MHz	1 g SAR (W/kg/W)		10 g SAR (W/kg/W)	
	required	measured	required	measured
300	2.85		1.94	
450	4.58		3.06	
750	8.49		5.55	
835	9.56		6.22	
900	10.9		6.99	
1450	29		16	
1500	30.5		16.8	
1640	34.2		18.4	
1750	36.4		19.3	
1800	38.4		20.1	

1900	39.7	38.93 (3.89)	20.5	20.27 (2.03)
1950	40.5		20.9	
2000	41.1		21.1	
2100	43.6		21.9	
2300	48.7		23.3	
2450	52.4		24	
2600	55.3		24.6	
3000	63.8		25.7	
3500	67.1		25	

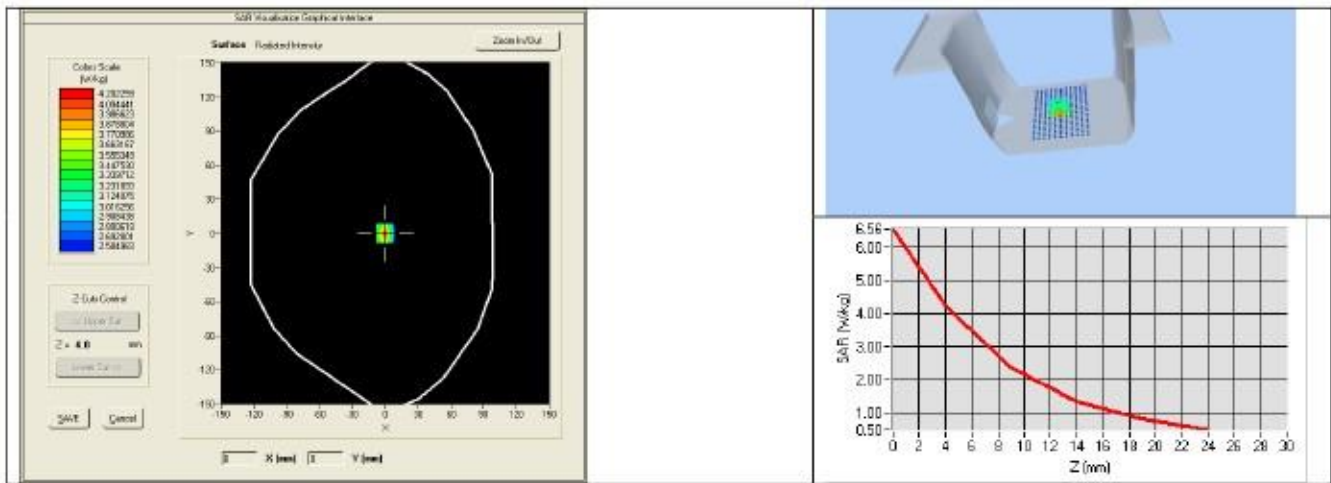

7.3 BODY LIQUID MEASUREMENT

Frequency MHz	Relative permittivity ( $\epsilon'$ )		Conductivity ( $\sigma$ ) S/m	
	required	measured	required	measured
150	61.9 ±5 %		0.80 ±5 %	
300	58.2 ±5 %		0.92 ±5 %	
450	56.7 ±5 %		0.94 ±5 %	
750	55.5 ±5 %		0.96 ±5 %	
835	55.2 ±5 %		0.97 ±5 %	
900	55.0 ±5 %		1.05 ±5 %	
915	55.0 ±5 %		1.06 ±5 %	
1450	54.0 ±5 %		1.30 ±5 %	
1610	53.8 ±5 %		1.40 ±5 %	
1800	53.3 ±5 %		1.52 ±5 %	
1900	53.3 ±5 %	PASS	1.52 ±5 %	PASS
2000	53.3 ±5 %		1.52 ±5 %	
2100	53.2 ±5 %		1.62 ±5 %	
2450	52.7 ±5 %		1.95 ±5 %	



2600	52.5 ±5 %		2.16 ±5 %	
3000	52.0 ±5 %		2.73 ±5 %	
3500	51.3 ±5 %		3.31 ±5 %	
5200	49.0 ±10 %		5.30 ±10 %	
5300	48.9 ±10 %		5.42 ±10 %	
5400	48.7 ±10 %		5.53 ±10 %	
5500	48.6 ±10 %		5.65 ±10 %	
5600	48.5 ±10 %		5.77 ±10 %	
5800	48.2 ±10 %		6.00 ±10 %	

7.4 SAR MEASUREMENT RESULT WITH BODY LIQUID

Software	OPENSAR V4
Phantom	SN 20/09 SAM71
Probe	SN 18/11 EPG122
Liquid	Body Liquid Values: $\epsilon_s'$ : 53.9 $\sigma$ : 1.55
Distance between dipole center and liquid	10.0 mm
Area scan resolution	dx=8mm/dy=8mm
Zoon Scan Resolution	dx=8mm/dy=8mm/dz=5mm
Frequency	1900 MHz
Input power	20 dBm
Liquid Temperature	21 °C
Lab Temperature	21 °C
Lab Humidity	45 %

Frequency MHz	1 g SAR (W/kg/W)	10 g SAR (W/kg/W)
	measured	measured
1900	38.73 (3.87)	20.48 (2.05)

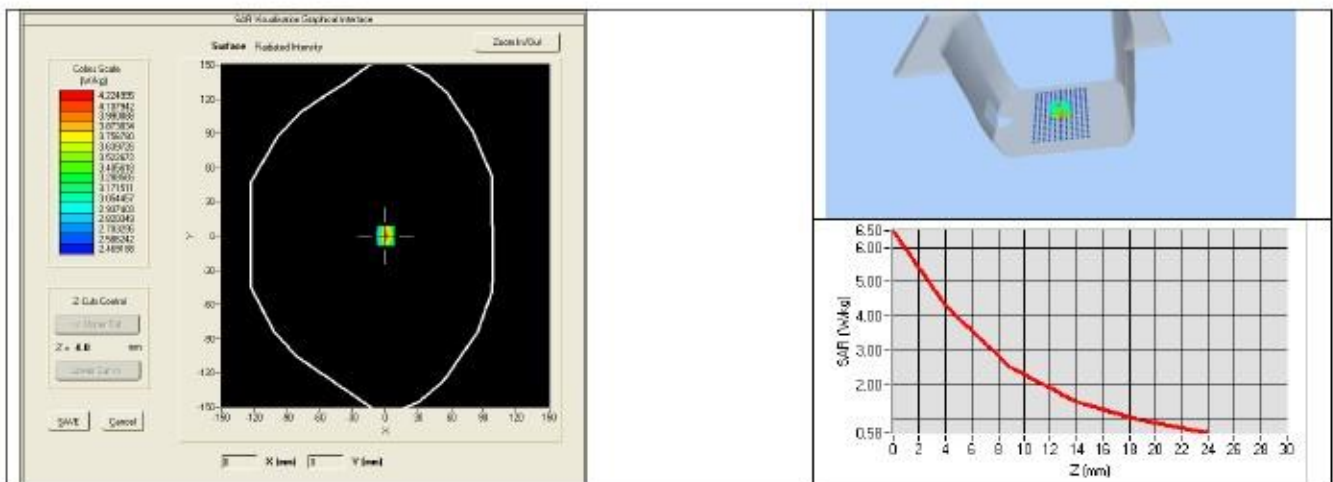



8 LIST OF EQUIPMENT

Equipment Summary Sheet				
Equipment Description	Manufacturer / Model	Identification No.	Current Calibration Date	Next Calibration Date
SAM Phantom	MVG	SN-20/09-SAM71	Validated. No cal required.	Validated. No cal required.
COMOSAR Test Bench	Version 3	NA	Validated. No cal required.	Validated. No cal required.
Network Analyzer	Rhode & Schwarz ZVA	SN100132	02/2016	02/2019
Calipers	Carrera	CALIPER-01	12/2016	12/2019
Reference Probe	MVG	EPG122 SN 18/11	01/2017	01/2020
Multimeter	Keithley 2000	1188656	01/2017	01/2020
Signal Generator	Agilent E4438C	MY49070581	01/2017	01/2020
Amplifier	Aethercomm	SN 046	Characterized prior to test. No cal required.	Characterized prior to test. No cal required.
Power Meter	HP E4418A	US38261498	01/2017	01/2020
Power Sensor	HP ECP-E26A	US37181460	01/2017	01/2020
Directional Coupler	Narda 4216-20	01386	Characterized prior to test. No cal required.	Characterized prior to test. No cal required.
Temperature and Humidity Sensor	Control Company	11-661-9	11/2017	11/2020



## SAR Reference Dipole Calibration Report

Ref: ACR.176.6.15.SATU.A

WORLD STANDARDIZATION CERTIFICATION  
& TESTING GROUP CO.,LTD  
BLOCK A-B, BAO SHI SCIENCE PARK,BAO SHI ROAD,  
BAO'AN DISTRICT  
SHENZHEN 518108,P.R. CHINA  
MVG COMOSAR REFERENCE DIPOLE  
FREQUENCY: 2450 MHZ  
SERIAL NO.: SN 14/13 DIP 2G450-238

Calibrated at MVG US  
2105 Barrett Park Dr. - Kennesaw, GA 30144



Calibration Date: 7/25/2018

### *Summary:*

This document presents the method and results from an accredited SAR reference dipole calibration performed in MVG USA using the COMOSAR test bench. All calibration results are traceable to national metrology institutions.



	<i>Name</i>	<i>Function</i>	<i>Date</i>	<i>Signature</i>
<i>Prepared by :</i>	Jérôme LUC	Product Manager	7/25/2018	<i>JS</i>
<i>Checked by :</i>	Jérôme LUC	Product Manager	7/25/2018	<i>JS</i>
<i>Approved by :</i>	Kim RUTKOWSKI	Quality Manager	7/25/2018	<i>Kim Rutkowski</i>

	<i>Customer Name</i>
<i>Distribution :</i>	WORLD STANDARDIZATION CERTIFICATION & TESTING GROUP CO.,LTD

<i>Issue</i>	<i>Date</i>	<i>Modifications</i>
A	7/25/2018	Initial release



**TABLE OF CONTENTS**

1 Introduction ..... 4

2 Device Under Test ..... 4

3 Product Description ..... 4

    3.1 General Information ..... 4

4 Measurement Method ..... 5

    4.1 Return Loss Requirements ..... 5

    4.2 Mechanical Requirements ..... 5

5 Measurement Uncertainty ..... 5

    5.1 Return Loss ..... 5

    5.2 Dimension Measurement ..... 5

    5.3 Validation Measurement ..... 5

6 Calibration Measurement Results ..... 6

    6.1 Return Loss and Impedance In Head Liquid ..... 6

    6.2 Return Loss and Impedance In Body Liquid ..... 6

    6.3 Mechanical Dimensions ..... 6

7 Validation measurement ..... 7

    7.1 Head Liquid Measurement ..... 7

    7.2 SAR Measurement Result With Head Liquid ..... 8

    7.3 Body Liquid Measurement ..... 9

    7.4 SAR Measurement Result With Body Liquid ..... 10

8 List of Equipment ..... 11

**1 INTRODUCTION**

This document contains a summary of the requirements set forth by the IEEE 1528, FCC KDBs and CEI/IEC 62209 standards for reference dipoles used for SAR measurement system validations and the measurements that were performed to verify that the product complies with the fore mentioned standards.

**2 DEVICE UNDER TEST**

<b>Device Under Test</b>	
Device Type	COMOSAR 2450 MHz REFERENCE DIPOLE
Manufacturer	MVG
Model	SID2450
Serial Number	SN 14/13 DIP 2G450-238
Product Condition (new / used)	Used

A yearly calibration interval is recommended.

**3 PRODUCT DESCRIPTION**

**3.1 GENERAL INFORMATION**

MVG’s COMOSAR Validation Dipoles are built in accordance to the IEEE 1528, FCC KDBs and CEI/IEC 62209 standards. The product is designed for use with the COMOSAR test bench only.



**Figure 1 – MVG COMOSAR Validation Dipole**



4 MEASUREMENT METHOD

The IEEE 1528, FCC KDBs and CEI/IEC 62209 standards provide requirements for reference dipoles used for system validation measurements. The following measurements were performed to verify that the product complies with the fore mentioned standards.

4.1 RETURN LOSS REQUIREMENTS

The dipole used for SAR system validation measurements and checks must have a return loss of -20 dB or better. The return loss measurement shall be performed against a liquid filled flat phantom, with the phantom constructed as outlined in the fore mentioned standards.

4.2 MECHANICAL REQUIREMENTS

The IEEE Std. 1528 and CEI/IEC 62209 standards specify the mechanical components and dimensions of the validation dipoles, with the dimensions frequency and phantom shell thickness dependent. The COMOSAR test bench employs a 2 mm phantom shell thickness therefore the dipoles sold for use with the COMOSAR test bench comply with the requirements set forth for a 2 mm phantom shell thickness.

5 MEASUREMENT UNCERTAINTY

All uncertainties listed below represent an expanded uncertainty expressed at approximately the 95% confidence level using a coverage factor of k=2, traceable to the Internationally Accepted Guides to Measurement Uncertainty.

5.1 RETURN LOSS

The following uncertainties apply to the return loss measurement:

Frequency band	Expanded Uncertainty on Return Loss
400-6000MHz	0.1 dB

5.2 DIMENSION MEASUREMENT

The following uncertainties apply to the dimension measurements:

Length (mm)	Expanded Uncertainty on Length
3 - 300	0.05 mm

5.3 VALIDATION MEASUREMENT

The guidelines outlined in the IEEE 1528, FCC KDBs, CENELEC EN50361 and CEI/IEC 62209 standards were followed to generate the measurement uncertainty for validation measurements.

Scan Volume	Expanded Uncertainty
1g	20.3 %

10 g	20.1 %
------	--------

## 6 CALIBRATION MEASUREMENT RESULTS

### 6.1 RETURN LOSS AND IMPEDANCE IN HEAD LIQUID

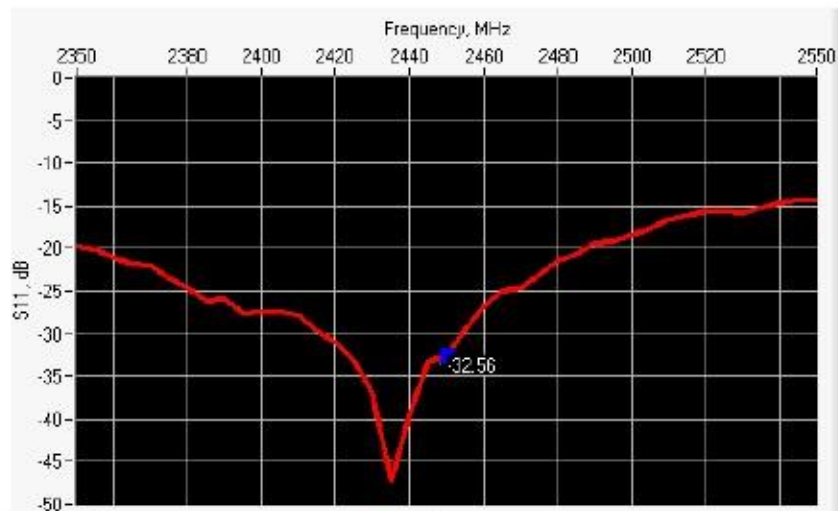

Frequency (MHz)	Return Loss (dB)	Requirement (dB)	Impedance
2450	-32.56	-20	48.3 Ω - 1.6 j

### 6.2 RETURN LOSS AND IMPEDANCE IN BODY LIQUID

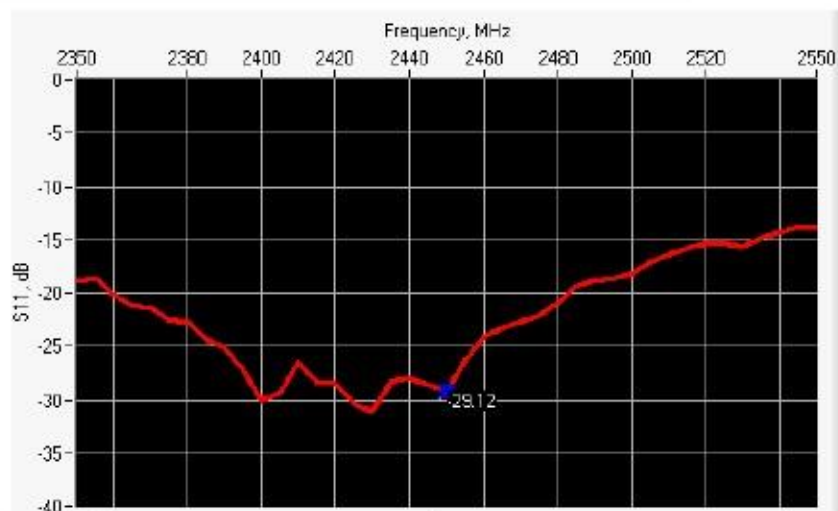

Frequency (MHz)	Return Loss (dB)	Requirement (dB)	Impedance
2450	-29.12	-20	0.0 Ω + 11.0 j

### 6.3 MECHANICAL DIMENSIONS

Frequency MHz	L mm		h mm		d mm	
	required	measured	required	measured	required	measured
300	420.0 ± 1 %.		250.0 ± 1 %.		6.35 ± 1 %.	





450	290.0 ±1 %.		166.7 ±1 %.		6.35 ±1 %.	
750	176.0 ±1 %.		100.0 ±1 %.		6.35 ±1 %.	
835	161.0 ±1 %.		89.8 ±1 %.		3.6 ±1 %.	
900	149.0 ±1 %.		83.3 ±1 %.		3.6 ±1 %.	
1450	89.1 ±1 %.		51.7 ±1 %.		3.6 ±1 %.	
1500	80.5 ±1 %.		50.0 ±1 %.		3.6 ±1 %.	
1640	79.0 ±1 %.		45.7 ±1 %.		3.6 ±1 %.	
1750	75.2 ±1 %.		42.9 ±1 %.		3.6 ±1 %.	
1800	72.0 ±1 %.		41.7 ±1 %.		3.6 ±1 %.	
1900	68.0 ±1 %.		39.5 ±1 %.		3.6 ±1 %.	
1950	66.3 ±1 %.		38.5 ±1 %.		3.6 ±1 %.	
2000	64.5 ±1 %.		37.5 ±1 %.		3.6 ±1 %.	
2100	61.0 ±1 %.		35.7 ±1 %.		3.6 ±1 %.	
2300	55.5 ±1 %.		32.6 ±1 %.		3.6 ±1 %.	
2450	51.5 ±1 %.	PASS	30.4 ±1 %.	PASS	3.6 ±1 %.	PASS
2600	48.5 ±1 %.		28.8 ±1 %.		3.6 ±1 %.	
3000	41.5 ±1 %.		25.0 ±1 %.		3.6 ±1 %.	
3500	37.0 ±1 %.		26.4 ±1 %.		3.6 ±1 %.	
3700	34.7 ±1 %.		26.4 ±1 %.		3.6 ±1 %.	

**7 VALIDATION MEASUREMENT**

The IEEE Std. 1528, FCC KDBs and CEI/IEC 62209 standards state that the system validation measurements must be performed using a reference dipole meeting the fore mentioned return loss and mechanical dimension requirements. The validation measurement must be performed against a liquid filled flat phantom, with the phantom constructed as outlined in the fore mentioned standards. Per the standards, the dipole shall be positioned below the bottom of the phantom, with the dipole length centered and parallel to the longest dimension of the flat phantom, with the top surface of the dipole at the described distance from the bottom surface of the phantom.

**7.1 HEAD LIQUID MEASUREMENT**

Frequency MHz	Relative permittivity ( $\epsilon_r$ )		Conductivity ( $\sigma$ ) S/m	
	required	measured	required	measured
300	45.3 ±5 %		0.87 ±5 %	
450	43.5 ±5 %		0.87 ±5 %	
750	41.9 ±5 %		0.89 ±5 %	
835	41.5 ±5 %		0.90 ±5 %	
900	41.5 ±5 %		0.97 ±5 %	
1450	40.5 ±5 %		1.20 ±5 %	
1500	40.4 ±5 %		1.23 ±5 %	
1640	40.2 ±5 %		1.31 ±5 %	
1750	40.1 ±5 %		1.37 ±5 %	



1800	40.0 ±5 %		1.40 ±5 %	
1900	40.0 ±5 %		1.40 ±5 %	
1950	40.0 ±5 %		1.40 ±5 %	
2000	40.0 ±5 %		1.40 ±5 %	
2100	39.8 ±5 %		1.49 ±5 %	
2300	39.5 ±5 %		1.67 ±5 %	
2450	39.2 ±5 %	PASS	1.80 ±5 %	PASS
2600	39.0 ±5 %		1.96 ±5 %	
3000	38.5 ±5 %		2.40 ±5 %	
3500	37.9 ±5 %		2.91 ±5 %	

7.2 SAR MEASUREMENT RESULT WITH HEAD LIQUID

The IEEE Std. 1528 and CEI/IEC 62209 standards state that the system validation measurements should produce the SAR values shown below (for phantom thickness of 2 mm), within the uncertainty for the system validation. All SAR values are normalized to 1 W forward power. In bracket, the measured SAR is given with the used input power.

Software	OPENSAR V4
Phantom	SN 20/09 SAM71
Probe	SN 18/11 EPG122
Liquid	Head Liquid Values: $\epsilon_p' : 38.3$ $\sigma : 1.80$
Distance between dipole center and liquid	10.0 mm
Area scan resolution	$dx=8mm/dy=8mm$
Zoon Scan Resolution	$dx=5mm/dy=5mm/dz=5mm$
Frequency	2450 MHz
Input power	20 dBm
Liquid Temperature	21 °C
Lab Temperature	21 °C
Lab Humidity	45 %

Frequency MHz	1 g SAR (W/kg/W)		10 g SAR (W/kg/W)	
	required	measured	required	measured
300	2.85		1.94	
450	4.58		3.06	
750	8.49		5.55	
835	9.56		6.22	
900	10.9		6.99	
1450	29		16	
1500	30.5		16.8	
1640	34.2		18.4	
1750	36.4		19.3	
1800	38.4		20.1	

1900	39.7		20.5	
1950	40.5		20.9	
2000	41.1		21.1	
2100	43.6		21.9	
2300	48.7		23.3	
2450	52.4	53.41 (5.34)	24	23.95 (2.40)
2600	55.3		24.6	
3000	63.8		25.7	
3500	67.1		25	

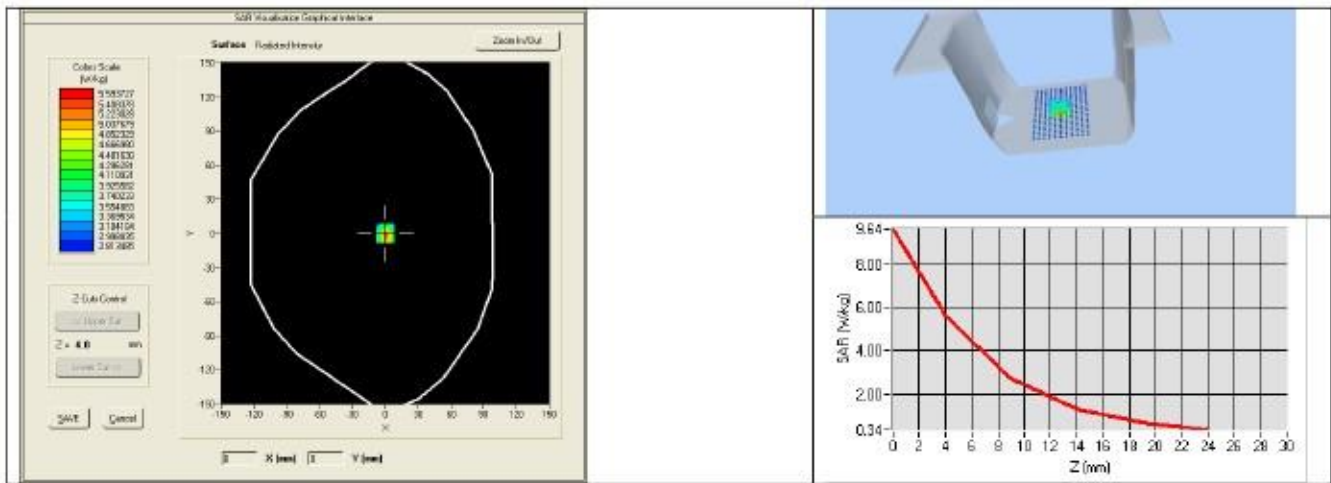

7.3 BODY LIQUID MEASUREMENT

Frequency MHz	Relative permittivity ( $\epsilon'$ )		Conductivity ( $\sigma$ ) S/m	
	required	measured	required	measured
150	61.9 ±5 %		0.80 ±5 %	
300	58.2 ±5 %		0.92 ±5 %	
450	56.7 ±5 %		0.94 ±5 %	
750	55.5 ±5 %		0.96 ±5 %	
835	55.2 ±5 %		0.97 ±5 %	
900	55.0 ±5 %		1.05 ±5 %	
915	55.0 ±5 %		1.06 ±5 %	
1450	54.0 ±5 %		1.30 ±5 %	
1610	53.8 ±5 %		1.40 ±5 %	
1800	53.3 ±5 %		1.52 ±5 %	
1900	53.3 ±5 %		1.52 ±5 %	
2000	53.3 ±5 %		1.52 ±5 %	
2100	53.2 ±5 %		1.62 ±5 %	
2450	52.7 ±5 %	PASS	1.95 ±5 %	PASS

2600	52.5 ±5 %		2.16 ±5 %	
3000	52.0 ±5 %		2.73 ±5 %	
3500	51.3 ±5 %		3.31 ±5 %	
5200	49.0 ±10 %		5.30 ±10 %	
5300	48.9 ±10 %		5.42 ±10 %	
5400	48.7 ±10 %		5.53 ±10 %	
5500	48.6 ±10 %		5.65 ±10 %	
5600	48.5 ±10 %		5.77 ±10 %	
5800	48.2 ±10 %		6.00 ±10 %	

7.4 SAR MEASUREMENT RESULT WITH BODY LIQUID

Software	OPENSAR V4
Phantom	SN 20/09 SAM71
Probe	SN 18/11 EPG122
Liquid	Body Liquid Values: eps' : 52.7 sigma : 1.94
Distance between dipole center and liquid	10.0 mm
Area scan resolution	dx=8mm/dy=8mm
Zoon Scan Resolution	dx=5mm/dy=5mm/dz=5mm
Frequency	2450 MHz
Input power	20 dBm
Liquid Temperature	21 °C
Lab Temperature	21 °C
Lab Humidity	45 %

Frequency MHz	1 g SAR (W/kg/W)	10 g SAR (W/kg/W)
	measured	measured
2450	51.39 (5.14)	23.63 (2.36)

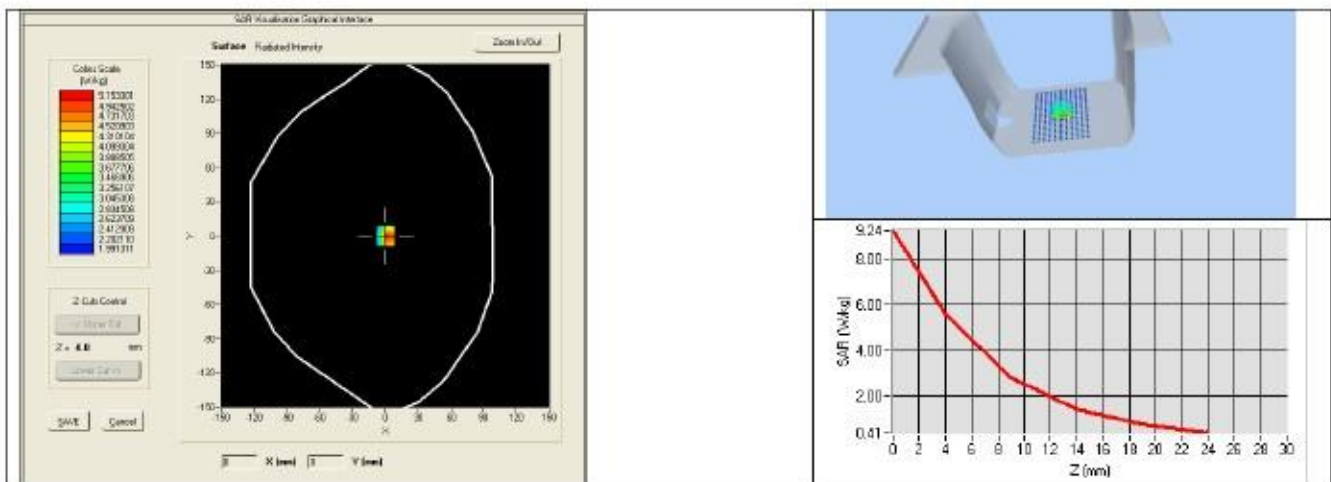



8 LIST OF EQUIPMENT

Equipment Summary Sheet				
Equipment Description	Manufacturer / Model	Identification No.	Current Calibration Date	Next Calibration Date
SAM Phantom	MVG	SN-20/09-SAM71	Validated. No cal required.	Validated. No cal required.
COMOSAR Test Bench	Version 3	NA	Validated. No cal required.	Validated. No cal required.
Network Analyzer	Rhode & Schwarz ZVA	SN100132	02/2016	02/2019
Calipers	Carrera	CALIPER-01	12/2016	12/2019
Reference Probe	MVG	EPG122 SN 18/11	01/2017	01/2020
Multimeter	Keithley 2000	1188656	01/2017	01/2020
Signal Generator	Agilent E4438C	MY49070581	01/2017	01/2020
Amplifier	Aethercomm	SN 046	Characterized prior to test. No cal required.	Characterized prior to test. No cal required.
Power Meter	HP E4418A	US38261498	01/2017	01/2020
Power Sensor	HP ECP-E26A	US37181460	01/2017	01/2020
Directional Coupler	Narda 4216-20	01386	Characterized prior to test. No cal required.	Characterized prior to test. No cal required.
Temperature and Humidity Sensor	Control Company	11-661-9	11/2017	11/2020



## COMOSAR E-Field Probe Calibration Report

Ref : ACR.331.3.17.SATU.A

**WORLD STANDARDIZATION CERTIFICATION  
& TESTING GROUP CO.,LTD**  
**BLOCK A, BAO SHI SCIENCE PARK,BAO SHI ROAD,  
BAO'AN DISTRICT**  
**SHENZHEN 518108,P.R. CHINA**  
**MVG COMOSAR DOSIMETRIC E-FIELD PROBE**  
**SERIAL NO.: SN 07/15 EP252**

**Calibrated at MVG US**  
**2105 Barrett Park Dr. - Kennesaw, GA 30144**



**Calibration Date: 11/27/2017**

### *Summary:*

This document presents the method and results from an accredited COMOSAR Dosimetric E-Field Probe calibration performed in MVG USA using the CALISAR / CALIBAIR test bench, for use with a COMOSAR system only. All calibration results are traceable to national metrology institutions.



	<i>Name</i>	<i>Function</i>	<i>Date</i>	<i>Signature</i>
<i>Prepared by :</i>	Jérôme LUC	Product Manager	11/27/2017	<i>JL</i>
<i>Checked by :</i>	Jérôme LUC	Product Manager	11/27/2017	<i>JL</i>
<i>Approved by :</i>	Kim RUTKOWSKI	Quality Manager	11/27/2017	<i>Kim Rutkowski</i>

	<i>Customer Name</i>
<i>Distribution :</i>	World Standardization Certification & Testing Group Co .Ltd

<i>Issue</i>	<i>Date</i>	<i>Modifications</i>
A	11/27/2017	Initial release



**TABLE OF CONTENTS**

1 Device Under Test ..... 4

2 Product Description ..... 4

    2.1 General Information ..... 4

3 Measurement Method ..... 4

    3.1 Linearity ..... 4

    3.2 Sensitivity ..... 5

    3.3 Lower Detection Limit ..... 5

    3.4 Isotropy ..... 5

    3.5 Boundary Effect ..... 5

4 Measurement Uncertainty ..... 5

5 Calibration Measurement Results ..... 6

    5.1 Sensitivity in air ..... 6

    5.2 Linearity ..... 7

    5.3 Sensitivity in liquid ..... 7

    5.4 Isotropy ..... 8

6 List of Equipment ..... 9



## 1 DEVICE UNDER TEST

Device Under Test	
Device Type	COMOSAR DOSIMETRIC E FIELD PROBE
Manufacturer	MVG
Model	SSE5
Serial Number	SN 07/15 EP252
Product Condition (new / used)	New
Frequency Range of Probe	0.7 GHz-3GHz
Resistance of Three Dipoles at Connector	Dipole 1: R1=0.202 MΩ Dipole 2: R2=0.233 MΩ Dipole 3: R3=0.206 MΩ

A yearly calibration interval is recommended.

## 2 PRODUCT DESCRIPTION

### 2.1 GENERAL INFORMATION

MVG's COMOSAR E field Probes are built in accordance to the IEEE 1528, OET 65 Bulletin C and CEI/IEC 62209 standards.



**Figure 1 – MVG COMOSAR Dosimetric E field Dipole**

Probe Length	330 mm
Length of Individual Dipoles	4.5 mm
Maximum external diameter	8 mm
Probe Tip External Diameter	5 mm
Distance between dipoles / probe extremity	2.7 mm

## 3 MEASUREMENT METHOD

The IEEE 1528, OET 65 Bulletin C, CENELEC EN50361 and CEI/IEC 62209 standards provide recommended practices for the probe calibrations, including the performance characteristics of interest and methods by which to assess their affect. All calibrations / measurements performed meet the fore mentioned standards.

### 3.1 LINEARITY

The evaluation of the linearity was done in free space using the waveguide, performing a power sweep to cover the SAR range 0.01W/kg to 100W/kg.

3.2 SENSITIVITY

The sensitivity factors of the three dipoles were determined using a two step calibration method (air and tissue simulating liquid) using waveguides as outlined in the standards.

3.3 LOWER DETECTION LIMIT

The lower detection limit was assessed using the same measurement set up as used for the linearity measurement. The required lower detection limit is 10 mW/kg.

3.4 ISOTROPY

The axial isotropy was evaluated by exposing the probe to a reference wave from a standard dipole with the dipole mounted under the flat phantom in the test configuration suggested for system validations and checks. The probe was rotated along its main axis from 0 - 360 degrees in 15 degree steps. The hemispherical isotropy is determined by inserting the probe in a thin plastic box filled with tissue-equivalent liquid, with the plastic box illuminated with the fields from a half wave dipole. The dipole is rotated about its axis (0°–180°) in 15° increments. At each step the probe is rotated about its axis (0°–360°).

3.5 BOUNDARY EFFECT

The boundary effect is defined as the deviation between the SAR measured data and the expected exponential decay in the liquid when the probe is oriented normal to the interface. To evaluate this effect, the liquid filled flat phantom is exposed to fields from either a reference dipole or waveguide. With the probe normal to the phantom surface, the peak spatial average SAR is measured and compared to the analytical value at the surface.

4 **MEASUREMENT UNCERTAINTY**

The guidelines outlined in the IEEE 1528, OET 65 Bulletin C, CENELEC EN50361 and CEI/IEC 62209 standards were followed to generate the measurement uncertainty associated with an E-field probe calibration using the waveguide technique. All uncertainties listed below represent an expanded uncertainty expressed at approximately the 95% confidence level using a coverage factor of k=2, traceable to the Internationally Accepted Guides to Measurement Uncertainty.

Uncertainty analysis of the probe calibration in waveguide					
ERROR SOURCES	Uncertainty value (%)	Probability Distribution	Divisor	ci	Standard Uncertainty (%)
Incident or forward power	3.00%	Rectangular	$\sqrt{3}$	1	1.732%
Reflected power	3.00%	Rectangular	$\sqrt{3}$	1	1.732%
Liquid conductivity	5.00%	Rectangular	$\sqrt{3}$	1	2.887%
Liquid permittivity	4.00%	Rectangular	$\sqrt{3}$	1	2.309%
Field homogeneity	3.00%	Rectangular	$\sqrt{3}$	1	1.732%
Field probe positioning	5.00%	Rectangular	$\sqrt{3}$	1	2.887%

Field probe linearity	3.00%	Rectangular	$\sqrt{3}$	1	1.732%
<b>Combined standard uncertainty</b>					5.831%
<b>Expanded uncertainty</b> 95 % confidence level k = 2					12.0%

## 5 CALIBRATION MEASUREMENT RESULTS

Calibration Parameters	
Liquid Temperature	21 °C
Lab Temperature	21 °C
Lab Humidity	45 %

### 5.1 SENSITIVITY IN AIR

Normx dipole 1 ( $\mu\text{V}/(\text{V}/\text{m})^2$ )	Normy dipole 2 ( $\mu\text{V}/(\text{V}/\text{m})^2$ )	Normz dipole 3 ( $\mu\text{V}/(\text{V}/\text{m})^2$ )
5.11	6.67	5.81

DCP dipole 1 (mV)	DCP dipole 2 (mV)	DCP dipole 3 (mV)
99	99	95

Calibration curves  $e_i=f(V)$  ( $i=1,2,3$ ) allow to obtain H-field value using the formula:

$$E = \sqrt{E_1^2 + E_2^2 + E_3^2}$$

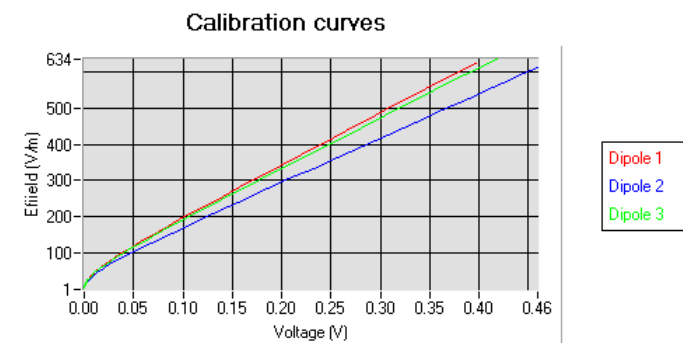

5.2 LINEARITY

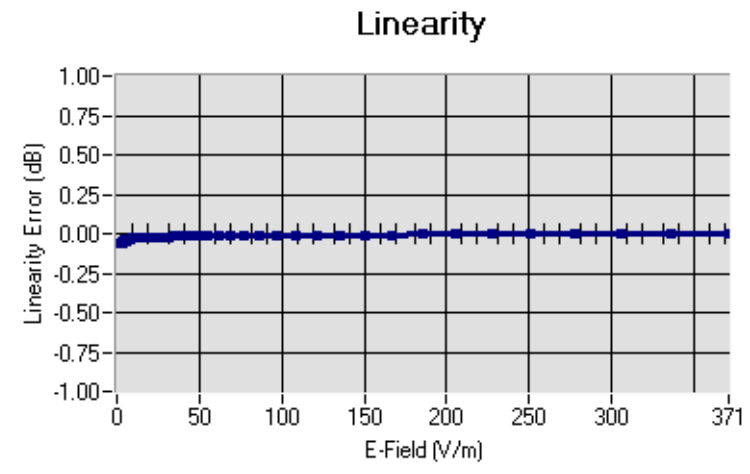

Linearity:  $\pm 1.35\%$  ( $\pm 0.06\text{dB}$ )

5.3 SENSITIVITY IN LIQUID

<u>Liquid</u>	<u>Frequency</u> (MHz +/- 100MHz)	<u>Permittivity</u>	<u>Epsilon (S/m)</u>	<u>ConvF</u>
HL750	750	42.09	0.91	5.38
BL750	750	55.69	0.95	5.54
HL850	835	42.71	0.89	5.54
BL850	835	57.52	1.03	5.75
HL900	900	41.94	0.93	5.53
BL900	900	52.87	1.09	5.74
HL1800	1800	40.62	1.39	4.65
BL1800	1800	53.22	1.47	4.80
HL1900	1900	41.22	1.37	5.17
BL1900	1900	50.99	1.52	5.28
HL2000	2000	40.39	1.36	5.00
BL2000	2000	54.39	1.54	5.14
HL2300	2300	38.10	1.74	4.89
BL2300	2300	53.33	1.85	4.93
HL2450	2450	40.46	1.87	4.83
BL2450	2450	54.62	1.95	5.02
HL2600	2600	38.46	2.01	4.51
BL2600	2600	51.98	2.16	4.66

LOWER DETECTION LIMIT: 8mW/kg

5.4 ISOTROPY

**HL900 MHz**

- Axial isotropy: 0.04 dB
- Hemispherical isotropy: 0.07 dB

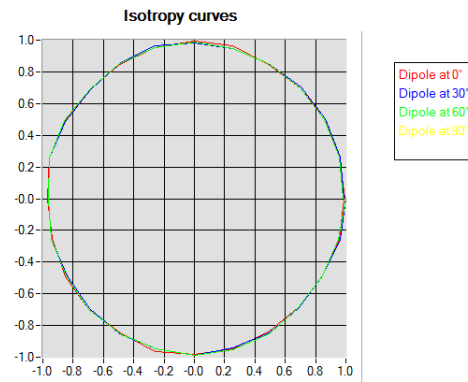

**HL1800 MHz**

- Axial isotropy: 0.04 dB
- Hemispherical isotropy: 0.08 dB

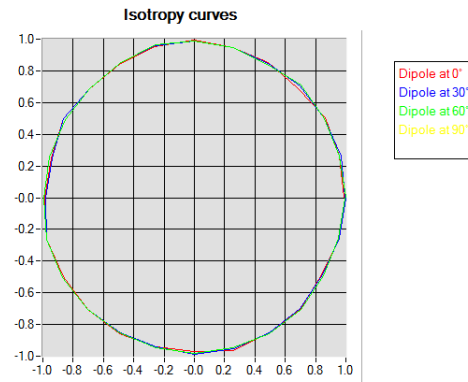



## 6 LIST OF EQUIPMENT

Equipment Summary Sheet				
Equipment Description	Manufacturer / Model	Identification No.	Current Calibration Date	Next Calibration Date
Flat Phantom	MVG	SN-20/09-SAM71	Validated. No cal required.	Validated. No cal required.
COMOSAR Test Bench	Version 3	NA	Validated. No cal required.	Validated. No cal required.
Network Analyzer	Rhode & Schwarz ZVA	SN100132	02/2016	02/2019
Reference Probe	MVG	EP 94 SN 37/08	10/2017	10/2018
Multimeter	Keithley 2000	1188656	01/2017	01/2020
Signal Generator	Agilent E4438C	MY49070581	01/2017	01/2020
Amplifier	Aethercomm	SN 046	Characterized prior to test. No cal required.	Characterized prior to test. No cal required.
Power Meter	HP E4418A	US38261498	01/2017	01/2020
Power Sensor	HP ECP-E26A	US37181460	01/2017	01/2020
Directional Coupler	Narda 4216-20	01386	Characterized prior to test. No cal required.	Characterized prior to test. No cal required.
Waveguide	Mega Industries	069Y7-158-13-712	Validated. No cal required.	Validated. No cal required.
Waveguide Transition	Mega Industries	069Y7-158-13-701	Validated. No cal required.	Validated. No cal required.
Waveguide Termination	Mega Industries	069Y7-158-13-701	Validated. No cal required.	Validated. No cal required.
Temperature / Humidity Sensor	Control Company	150798832	11/2017	11/2020