

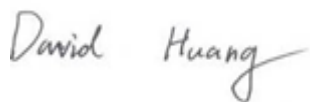

RF TEST REPORT



Report No.: 17070659-FCC-R6

Supersede Report No.: N/A

Applicant	TECNO MOBILE LIMITED	
Product Name	Mobile phone	
Model No.	AX8	
Serial No.	N/A	
Test Standard	FCC Part 15.407: 2016, ANSI C63.10: 2013	
Test Date	July 29 to September 28, 2017	
Issue Date	September 29, 2017	
Test Result	<input checked="" type="checkbox"/> Pass <input type="checkbox"/> Fail	
Equipment complied with the specification	<input checked="" type="checkbox"/>	
Equipment did not comply with the specification	<input type="checkbox"/>	
		
Loren Luo Test Engineer	David Huang Checked By	
This test report may be reproduced in full only Test result presented in this test report is applicable to the tested sample only		

Issued by:

SIEMIC (SHENZHEN-CHINA) LABORATORIES

Zone A, Floor 1, Building 2 Wan Ye Long Technology Park

South Side of Zhoushi Road, Bao' an District, Shenzhen, Guangdong China 518108

Phone: +86 0755 2601 4629801 Email: China@siemic.com.cn

Laboratories Introduction

SIEMIC, headquartered in the heart of Silicon Valley, with superior facilities in US and Asia, is one of the leading independent testing and certification facilities providing customers with one-stop shop services for Compliance Testing and Global Certifications.



In addition to testing and certification, SIEMIC provides initial design reviews and compliance management throughout a project. Our extensive experience with China, Asia Pacific, North America, European, and International compliance requirements, assures the fastest, most cost effective way to attain regulatory compliance for the global markets.

Accreditations for Conformity Assessment

Country/Region	Scope
USA	EMC, RF/Wireless, SAR, Telecom
Canada	EMC, RF/Wireless, SAR, Telecom
Taiwan	EMC, RF, Telecom, SAR, Safety
Hong Kong	RF/Wireless, SAR, Telecom
Australia	EMC, RF, Telecom, SAR, Safety
Korea	EMI, EMS, RF, SAR, Telecom, Safety
Japan	EMI, RF/Wireless, SAR, Telecom
Singapore	EMC, RF, SAR, Telecom
Europe	EMC, RF, SAR, Telecom, Safety

Test Report No.	17070659-FCC-R6
Page	3 of 74

This page has been left blank intentionally.

CONTENTS

1. REPORT REVISION HISTORY	5
2. CUSTOMER INFORMATION	5
3. TEST SITE INFORMATION	6
4. EQUIPMENT UNDER TEST (EUT) INFORMATION	7
5. TEST SUMMARY	10
6. MEASUREMENTS, EXAMINATION AND DERIVED RESULTS	11
6.1 ON TIME, DUTY CYCLE AND MEASUREMENT METHODS	12
6.2 §15.407(A)-DTS (99% &26 DB) CHANNEL BANDWIDTH.....	19
6.3 §15.407(A)-DTS (99% &6 DB) CHANNEL BANDWIDTH.....	27
6.4 §15.407(A)-CONDUCTED MAXIMUM OUTPUT POWER.....	32
6.5 §15.407(A) - POWER SPECTRAL DENSITY	37
6.6 §15.407(1) AND B(4) BAND-EDGE	46
6.7 §15.207 (A) - AC POWER LINE CONDUCTED EMISSIONS	53
6.8 §15.209, §15.205 & §15.407(B) - RADIATED SPURIOUS EMISSIONS & UNWANTED EMISSIONS INTO RESTRICTED FREQUENCY BANDS.....	54
ANNEX A. TEST INSTRUMENT.....	60
ANNEX C. TEST SETUP AND SUPPORTING EQUIPMENT.....	68
ANNEX D. USER MANUAL / BLOCK DIAGRAM / SCHEMATICS / PARTLIST	73
ANNEX E. DECLARATION OF SIMILARITY.....	74

1. Report Revision History

Report No.	Report Version	Description	Issue Date
17070659-FCC-R6	NONE	Original	September 29, 2017

2. Customer information

Applicant Name	TECNO MOBILE LIMITED
Applicant Add	ROOMS 05-15, 13A/F., SOUTH TOWER, WORLD FINANCE CENTRE, HARBOUR CITY, 17 CANTON ROAD, TSIM SHA TSUI, KOWLOON, HONG KONG
Manufacturer	SHENZHEN TECNO TECHNOLOGY CO.,LTD.
Manufacturer Add	1-4th Floor,3rd Building,Pacific Industrial Park,No.2088,Shenyan Road,Yantian District,Shenzhen,Guangdong,China

3. Test site information

Test Lab A:

Lab performing tests	SIEMIC (Shenzhen-China) LABORATORIES
Lab Address	Zone A, Floor 1, Building 2 Wan Ye Long Technology Park South Side of Zhoushi Road, Bao' an District, Shenzhen, Guangdong China 518108
FCC Test Site No.	535293
IC Test Site No.	4842E-1
Test Software	Radiated Emission Program-To Shenzhen v2.0

Test Lab B:

Lab performing tests	BV 7LAYERS COMMUNICATION TRCHNOLOGY(SHENZHEN)CO.,LTD
Lab Address	No. B102, Dazu Cuangxin Mansion, North of Beihuan Avenue, North Area, Hi-Tech Industry Park, Nanshan District Shenzhen, Guangdong China
FCC Test Site No.	525120

Note: We just perform Radiated Spurious Emission above 18GHz in the test Lab. B.

4. Equipment under Test (EUT) Information

Description of EUT:	Mobile phone
Main Model:	AX8
Serial Model:	N/A
Date EUT received:	July 28, 2017
Test Date(s):	July 29 to September 28, 2017
Equipment Category :	NII
Antenna Gain:	GSM850: -2.53dBi PCS1900: -1.31dBi UMTS-FDD Band V: -2dBi UMTS-FDD Band II: -1.74dBi LTE Band II: -1.31dBi LTE Band IV: -2.64dBi LTE Band V: -2.14dBi LTE Band VII: -0.27dBi WIFI(2.4G): -0.87 dBi WIFI(5150-5250MHz): -5.3 dBi WIFI(5250-5350MHz): -5.3 dBi WIFI(5725-5850MHz): -5.3 dBi Bluetooth/BLE: -0.87dBi GPS: -1.47dBi
Antenna Type:	IFA antenna
Type of Modulation:	GSM / GPRS: GMSK EGPRS: GMSK,8PSK UMTS-FDD: QPSK LTE Band: QPSK, 16QAM 802.11b/g/n: DSSS, OFDM Bluetooth: GFSK, π /4DQPSK, 8DPSK BLE: GFSK GPS: BPSK

	GSM 850: 124CH
	PCS1900: 299CH
	UMTS-FDD Band V : 102CH
	UMTS-FDD Band II : 277CH
	WIFI :802.11b/g: 11CH
Number of Channels:	WIFI :802.11a: 24CH
	WIFI :802.11n20: 11CH(2.4GHz); 24CH(5GHz)
	WIFI :802.11n40: 7CH(2.4GHz); 12CH(5GHz)
	Bluetooth: 79CH
	BLE: 40CH
	GPS:1CH
	GSM850 TX: 824.2 ~ 848.8 MHz; RX: 869.2 ~ 893.8 MHz
	PCS1900 TX: 1850.2 ~ 1909.8 MHz; RX: 1930.2 ~ 1989.8 MHz
	UMTS-FDD Band V TX: 826.4 ~ 846.6 MHz; RX: 871.4 ~ 891.6 MHz
	UMTS-FDD Band II TX:1852.4 ~ 1907.6 MHz;
	RX: 1932.4 ~ 1987.6 MHz
	LTE Band II TX: 1850.7 ~ 1909.3MHz; RX : 1930.7 ~ 1989.3 MHz
	LTE Band IV TX: 1710.7 ~ 1754.3 MHz; RX : 2110.7~ 2154.3 MHz
	LTE Band V TX: 824.7~ 848.3 MHz; RX : 869.7 ~ 893.3MHz
RF Operating Frequency (ies):	LTE Band VII TX: 2502.5 ~ 2567.5 MHz; RX : 2622.5 ~ 2687.5 MHz
	802.11b/g: 2412-2462 MHz (TX/RX)
	802.11n20: 2412-2462MHz ; 5180-5240 MHz; 5260-5320 MHz; 5745-5825 MHz; (TX/RX)
	802.11n40: 2422-2452 MHz (TX/RX); 5190-5230 MHz; 5270-5310 MHz; 5755-5795 MHz; (TX/RX)
	802.11 a: 5180-5240 MHz; 5260-5320 MHz; 5745-5825 MHz (TX/RX)
	Bluetooth& BLE: 2402-2480 MHz
	GPS: 1575.42 MHz
Max. Output Power:	802.11a: 9.78dBm
	802.11n(20M): 9.97dBm
	802.11n(40M): 8.88dBm
Port:	USB Port, Earphone Port
Trade Name :	TECNO
GPRS/EGPRS Multi-slot class	8/10/11/12

Test Report No.	17070659-FCC-R6
Page	9 of 74

FCC ID:

2ADYY-AX8

5. Test Summary

The product was tested in accordance with the following specifications.

All testing has been performed according to below product classification:

FCC Rules	Description of Test	Result
§15.407 (i), §2.1093	RF Exposure	Compliance
§15.203	Antenna Requirement	Compliance
§15.407 (a)(1)	DTS (99%&26 dB) CHANNEL BANDWIDTH	Compliance
§15.407 (e)	DTS (99%&6 dB) CHANNEL BANDWIDTH	Compliance
§15.407(a/1/2)	Conducted Maximum Output Power	Compliance
§15.407(a/1/2)	Peak Power Spectral Density	Compliance
§15.407(a)(6)	Peak Power Excursion	Compliance
§15.207 (a)	AC Power Line Conducted Emissions	N/A
§15.205, §15.209, §15.247(b/1/2/3/6)	Radiated Spurious Emissions & Unwanted Emissions into Restricted Frequency Bands	Compliance

6. Measurements, Examination And Derived Results

6.1 §15.203 - ANTENNA REQUIREMENT

Applicable Standard

According to § 15.203, an intentional radiator shall be designed to ensure that no antenna other than that furnished by the responsible party shall be used with the device. The use of a permanently attached antenna or of an antenna that uses a unique coupling to the intentional radiator shall be considered sufficient to comply with the provisions of this section. The manufacturer may design the unit so that a broken antenna can be replaced by the user, but the user of a standard antenna jack or electrical connector is prohibited. The structure and application of the EUT were analyzed to determine compliance with section §15.203 of the rules. §15.203 state that the subject device must meet the following criteria:

- a. Antenna must be permanently attached to the unit.
- b. Antenna must use a unique type of connector to attach to the EUT.

Unit must be professionally installed, and installer shall be responsible for verifying that the correct antenna is employed with the unit.

And according to FCC 47 CFR section 15.247 (b), if the transmitting antennas of directional gain greater than 6dBi are used, the power shall be reduced by the amount in dB that the directional gain of the antenna exceeds 6 dBi.

Antenna Connector Construction

The EUT has 3 antennas:

A permanently attached IFA antenna for Bluetooth/BLE/2.4G WIFI/5G WIFI/GPS, the gain is -0.87dBi for Bluetooth/BLE, the gain is -0.87dBi for 2.4G WIFI, the gain is -5.3dBi for 5150-5250MHz/5250-5350MHz/5725-2850MHz MHz 5G WIFI, the gain is -1.47dBi for GPS.

A permanently attached IFA antenna for GSM/PCS/UMTS, the gain is -2.53dBi for GSM850, -1.31dBi for PCS1900, -2dBi for UMTS-FDD Band V, -1.74dBi for UMTS-FDD Band II.

A permanently attached IFA antenna for LTE Band II/IV/V/VII, the gain is -1.31dBi for LTE Band II, the gain is -2.64dBi for LTE Band IV, the gain is -2.14dBi for LTE Band V, the gain is -0.27dBi for LTE Band VII.

Result: Pass

6.1 ON TIME, DUTY CYCLE AND MEASUREMENT METHODS

Standard Requirement:

None. For reporting purpose only.

PROCEDURE

KDB 789033 Zero-Span Spectrum Analyzer Method.

Environmental Conditions	Temperature	23°C
	Relative Humidity	54%
	Atmospheric Pressure	1020mbar

Test date : September 28, 2017

Tested By : Loren Luo

Test Result: Pass.

Please refer to the following tables and plots.

Measurement result

ON TIME AND DUTY CYCLE RESULTS

Test mode	Freq Band (MHz)	CH	Freq (MHz)	ON Time B(msec)	Period (msec)	Duty Cycle x(linear)	Duty Cycle(%)	Duty Cycle Correction Factor(dB)
820.11 a	5150-5250	Low	5180	1	1	1	100%	0
		Middle	5220	1	1	1	100%	0
		High	5240	1	1	1	100%	0
	5250-5350	Low	5260	1	1	1	100%	0
		Middle	5300	1	1	1	100%	0
		High	5320	1	1	1	100%	0
	5725-5850	Low	5745	1	1	1	100%	0
		Mid	5785	1	1	1	100%	0
		High	5825	1	1	1	100%	0
802.11n (20M)	5150-5250	Low	5180	1	1	1	100%	0
		Middle	5220	1	1	1	100%	0
		High	5240	1	1	1	100%	0
	5250-5350	Low	5260	1	1	1	100%	0
		Middle	5300	1	1	1	100%	0
		High	5320	1	1	1	100%	0
	5725-5850	Low	5745	1	1	1	100%	0
		Mid	5785	1	1	1	100%	0
		High	5825	1	1	1	100%	0
802.11n (40M)	5150-5250	Low	5190	1	1	1	100%	0
		High	5230	1	1	1	100%	0
	5250-5350	Low	5270	1	1	1	100%	0
		High	5310	1	1	1	100%	0
	5725-5850	Low	5755	1	1	1	100%	0
		High	5795	1	1	1	100%	0

Test Plots

Duty cycle measurement result

802.11a

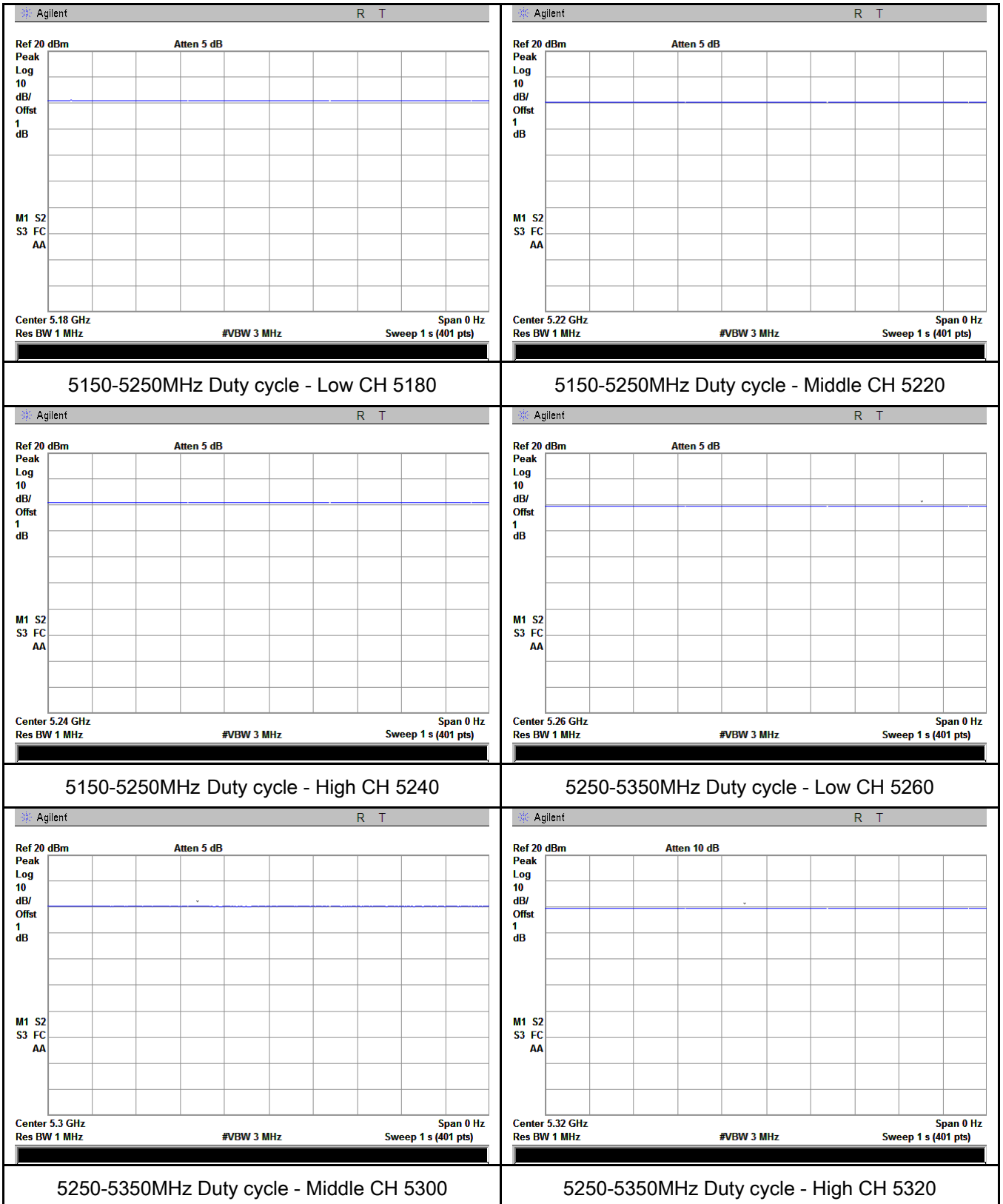

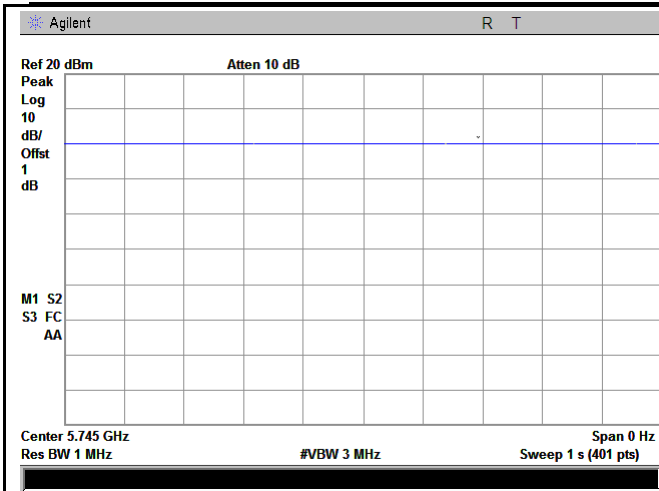

5725-5850MHz Duty cycle - Low CH 5745

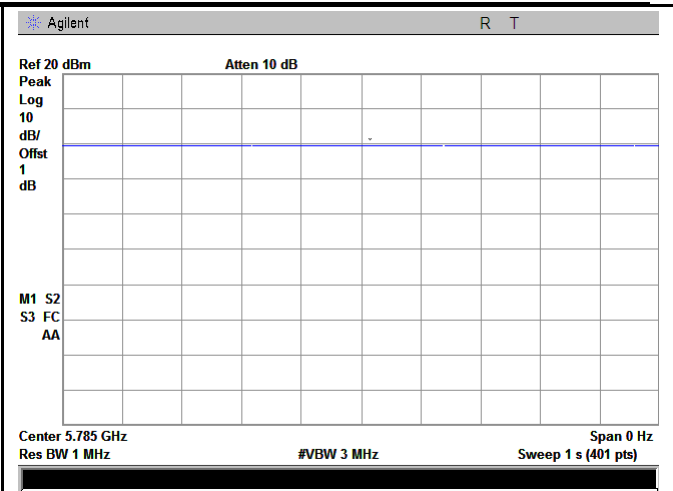

5725-5850MHz Duty cycle - Mid CH 5785

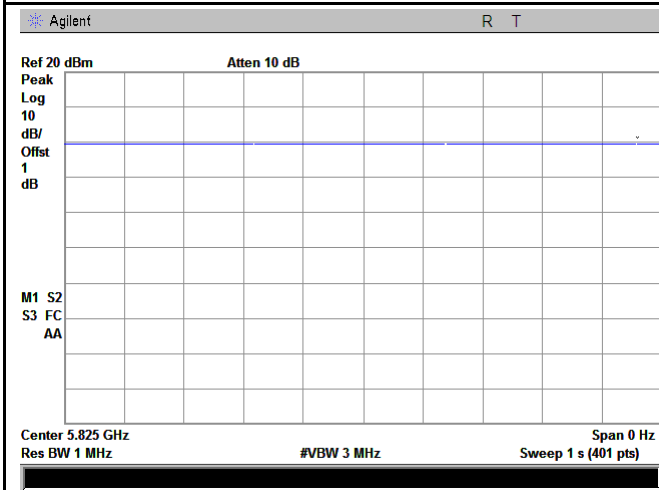

5725-5850MHz Duty cycle - High CH 5825

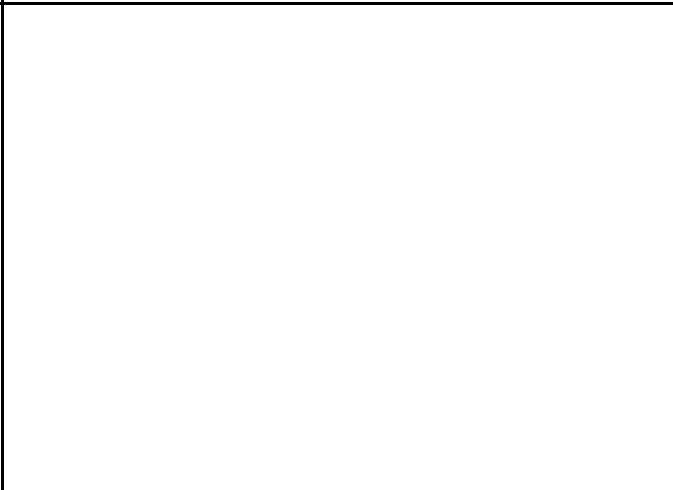

802.11n (20M)

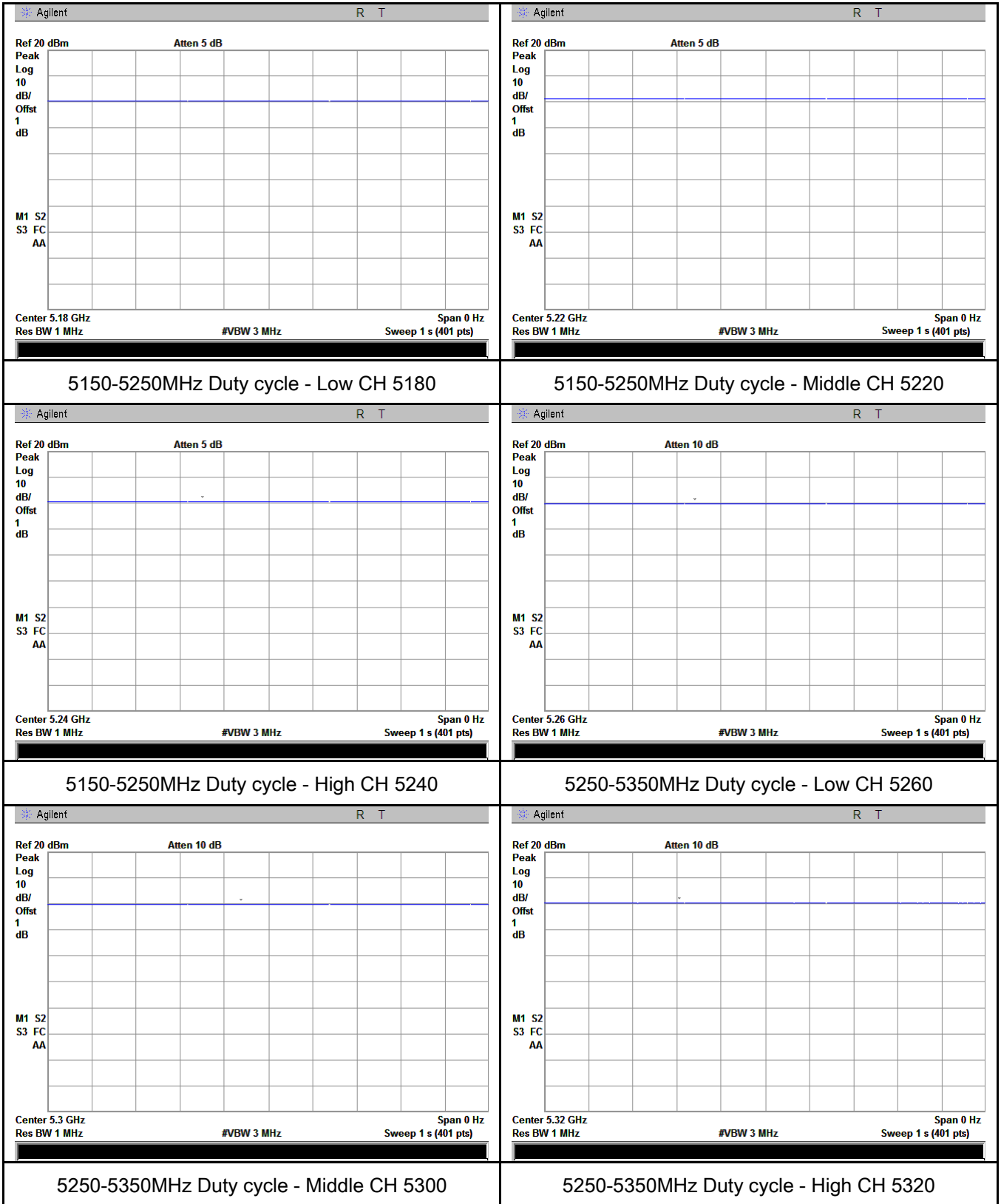

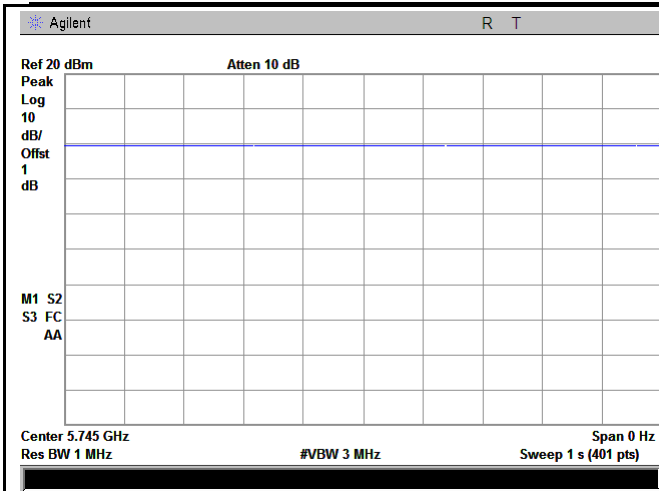

5725-5850MHz Duty cycle - Low CH 5745

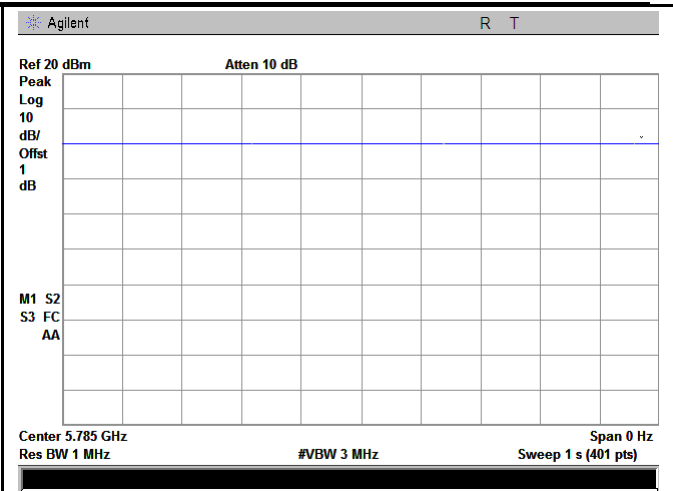

5725-5850MHz Duty cycle - Mid CH 5785

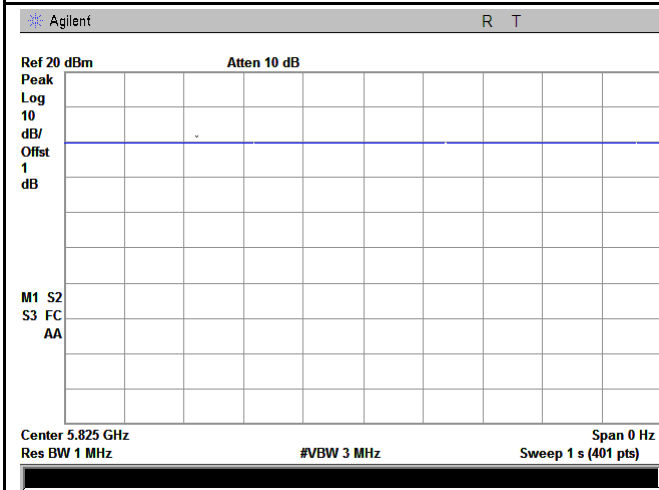

5725-5850MHz Duty cycle - High CH 5825

802.11n (40M)



6.2 §15.407(a)-DTS (99% &26 dB) Channel Bandwidth

1. Conducted Measurement

EUT was set for low, mid, high channel with modulated mode and highest RF output power.

The spectrum analyzer was connected to the antenna terminal.

2. Environmental Conditions	Temperature	25°C
	Relative Humidity	53%
	Atmospheric Pressure	1010mbar

3. Conducted Emissions Measurement Uncertainty

All test measurements carried out are traceable to national standards. The uncertainty of the measurement at a confidence level of approximately 95% (in the case where distributions are normal), with a coverage factor of 2, in the range 30MHz – 40GHz is ± 1.5 dB.

4. Test date : September 12, 2017

Tested By : Loren Luo

Standard Requirement:

None; for reporting purposes only.

Procedures:

99% Bandwidth:

1. Set center frequency to the nominal EUT channel center frequency
2. Set span = 1.5 times to 5.0 times the OBW.
3. Set RBW = 1 % to 5 % of the OBW
4. The video bandwidth (VBW) $\geq 3 \times$ RBW.
5. Video averaging is not permitted. Where practical, a sample detection and single sweep mode shall be used. Otherwise, peak detection and max hold mode (until the trace stabilizes) shall be used
6. Use the 99 % power bandwidth function of the instrument (if available)
7. If the instrument does not have a 99 % power bandwidth function, the trace data points are recovered and directly summed in power units. The recovered amplitude data points, beginning

at the lowest frequency, are placed in a running sum until 0.5 % of the total is reached; that frequency is recorded as the lower frequency. The process is repeated until 99.5 % of the total is reached; that frequency is recorded as the upper frequency. The 99% occupied bandwidth is the difference between these two frequencies.

Emission Bandwidth (EBW)

- 1) Set RBW = approximately 1% of the emission bandwidth.
- 2) Set the VBW > RBW.
- 3) Detector = Peak.
- 4) Trace mode = max hold.
- 5) Measure the maximum width of the emission that is 26 dB down from the maximum of the emission. Compare this with the RBW setting of the analyzer. Readjust

Test Result: Pass.

Please refer to the following tables and plots.

Measurement result

Test mode	Freq Band (MHz)	CH	Freq (MHz)	99% Bandwidth (MHz)	26dB Bandwidth (MHz)
820.11a	5150-5250	Low	5180	16.7789	21.459
		Middle	5220	16.7464	20.175
		High	5240	16.7281	20.001
	5250-5350	Low	5260	16.6894	21.185
		Middle	5300	16.6832	19.600
		High	5320	16.7099	20.474
	5725-5850	Low	5745	16.8674	22.204
		Mid	5785	16.8467	22.356
		High	5825	16.7449	21.950
802.11n (20M)	5150-5250	Low	5180	17.7410	20.213
		Middle	5220	17.7736	22.880
		High	5240	17.8005	22.132
	5250-5350	Low	5260	17.7403	20.873
		Middle	5300	17.7565	19.918
		High	5320	17.7026	20.178
	5725-5850	Low	5745	17.8922	26.337
		Mid	5785	17.8589	24.646
		High	5825	17.8639	24.078
802.11n (40M)	5150-5250	Low	5190	36.2222	40.928
		High	5230	36.1773	40.534
	5250-5350	Low	5270	36.2385	40.556
		High	5310	36.3041	40.701
	5725-5850	Low	5755	36.2555	40.888
High		5795	36.2062	40.710	

Test Plots

Bandwidth measurement result

802.11a

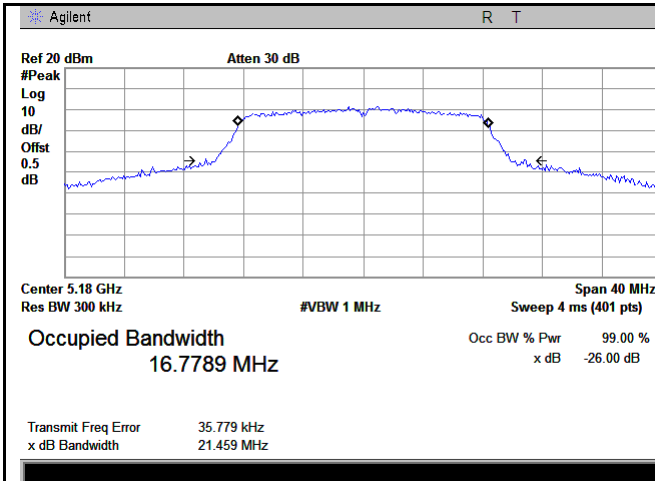

5150-5250MHz Bandwidth - Low CH 5180

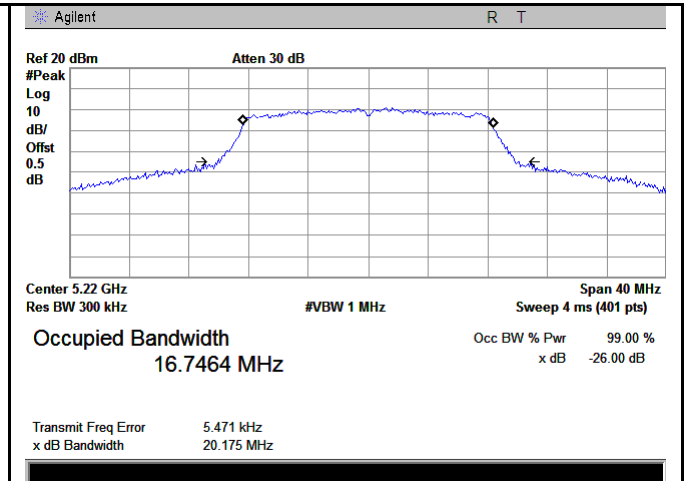

5150-5250MHz Bandwidth - Middle CH 5220

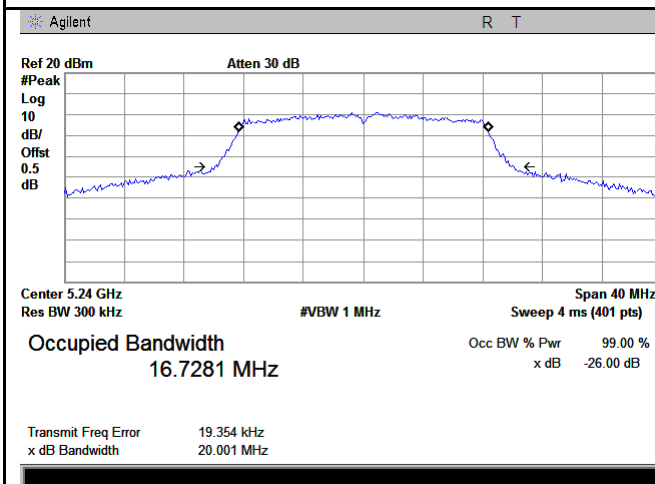

5150-5250MHz Bandwidth - High CH 5240

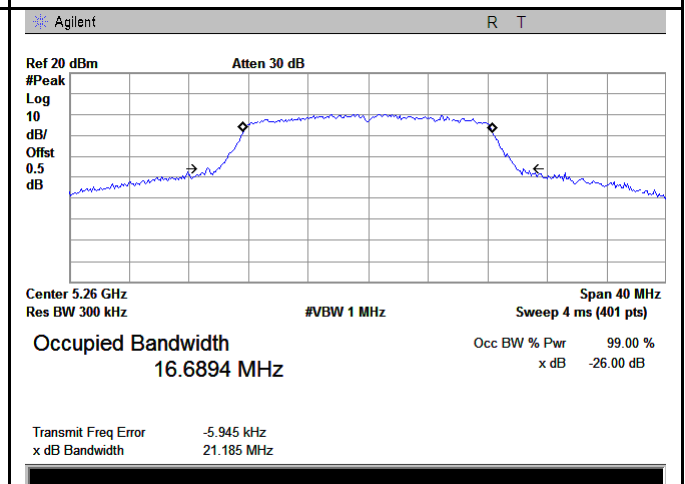

5250-5350MHz Bandwidth - Low CH 5260

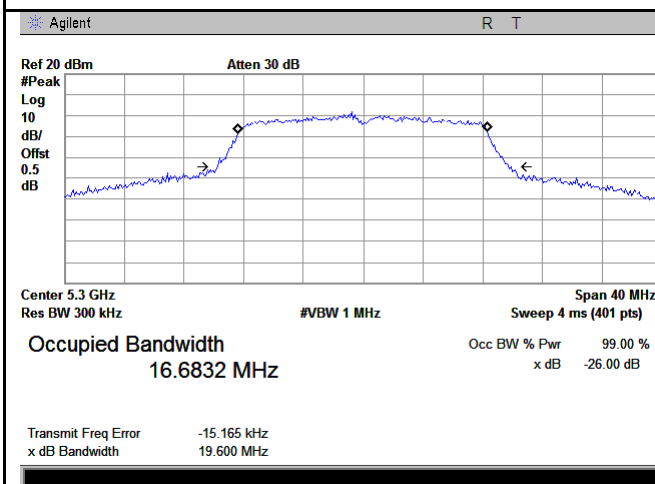

5250-5350MHz Bandwidth - Middle CH 5300

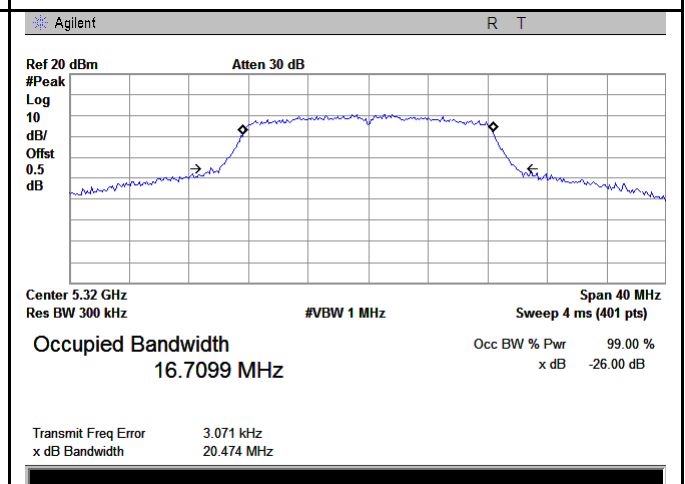

5250-5350MHz Bandwidth - High CH 5320

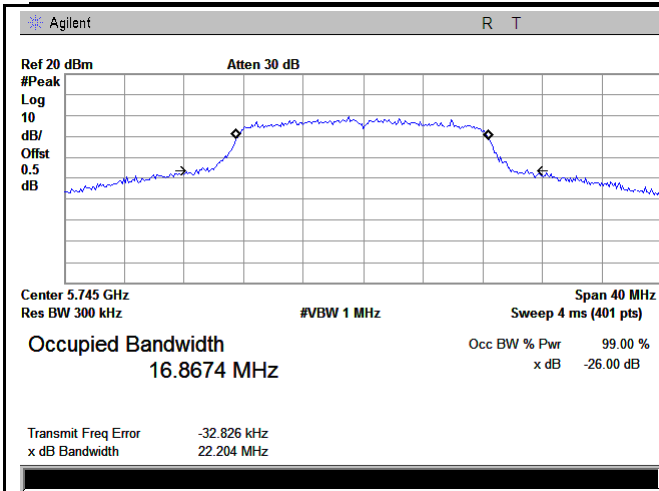

5725-5850MHz Bandwidth - Low CH 5745

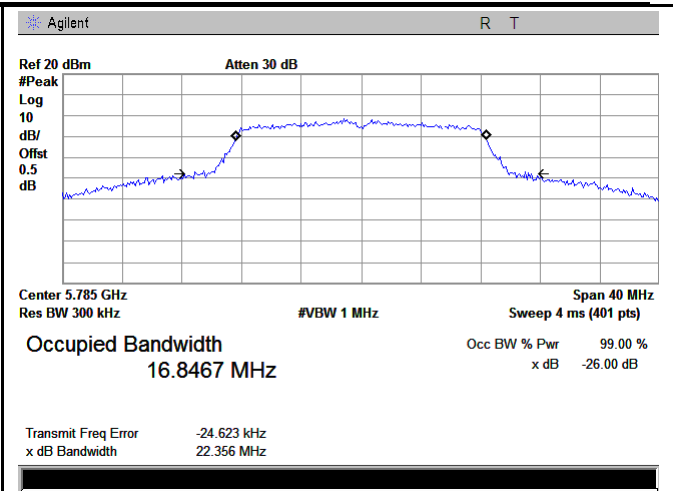

5725-5850MHz Bandwidth - Mid CH 5785

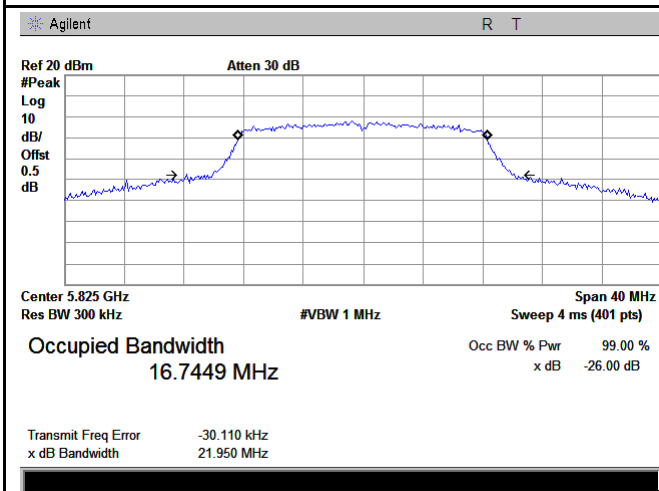

5725-5850MHz Bandwidth - High CH 5825

802.11n (20M)

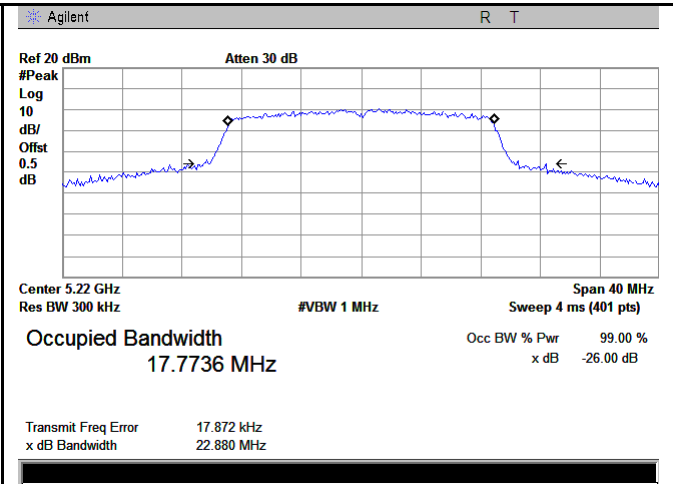
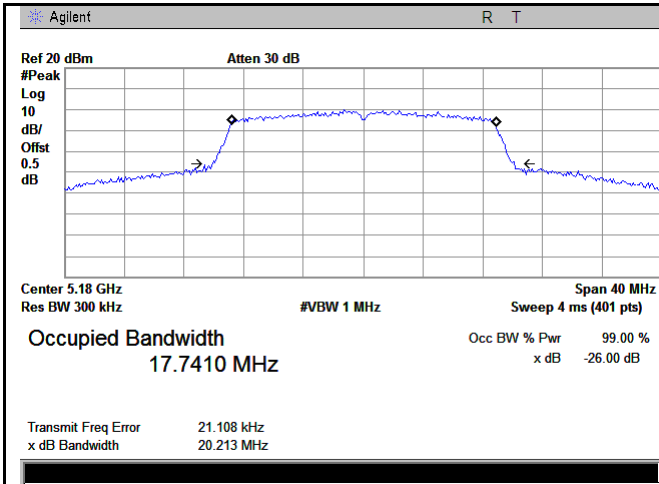

5150-5250MHz Bandwidth - Low CH 5180

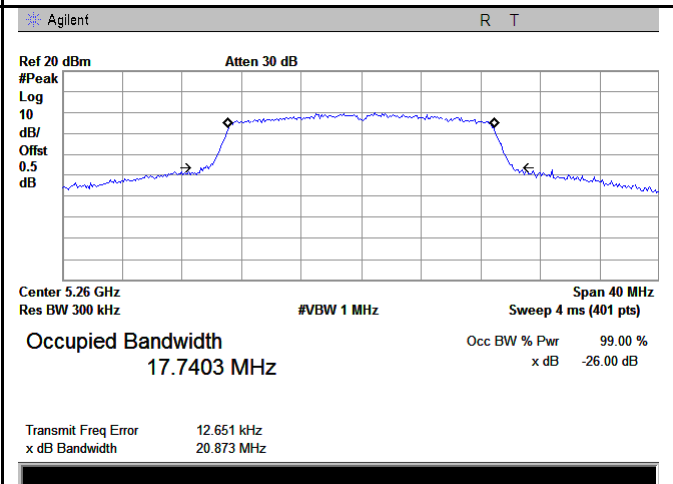
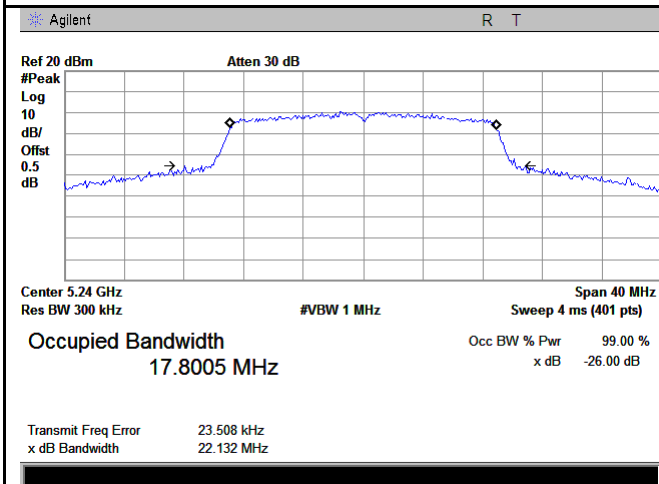

5150-5250MHz Bandwidth - High CH 5240

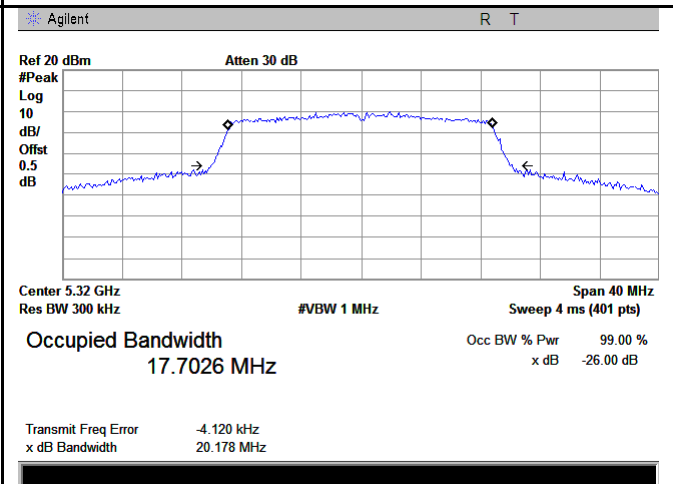
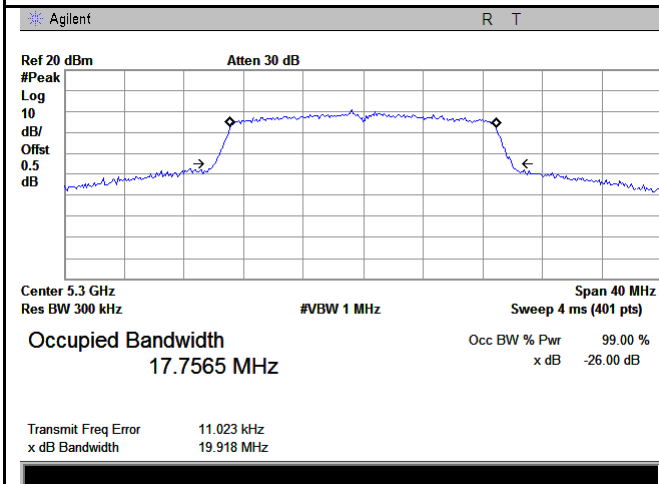

5250-5350MHz Bandwidth - Middle CH 5300

5250-5350MHz Bandwidth - High CH 5320

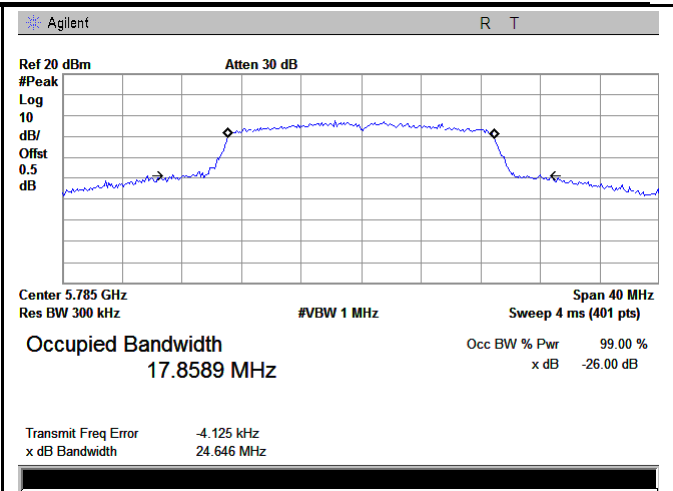
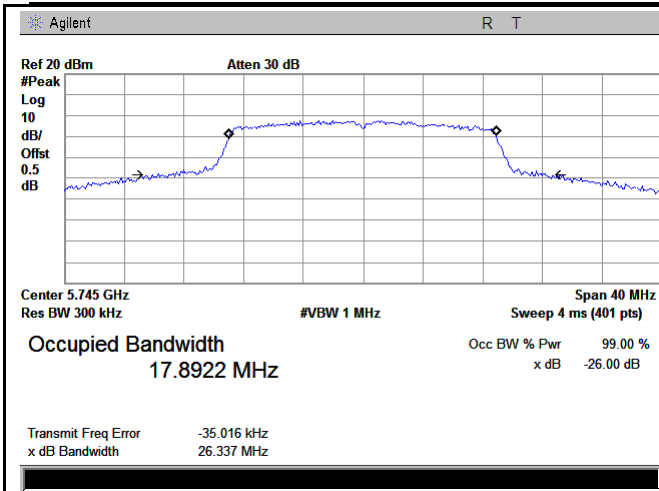

5725-5850MHz Bandwidth - Low CH 5745

5725-5850MHz Bandwidth - Mid CH 5785

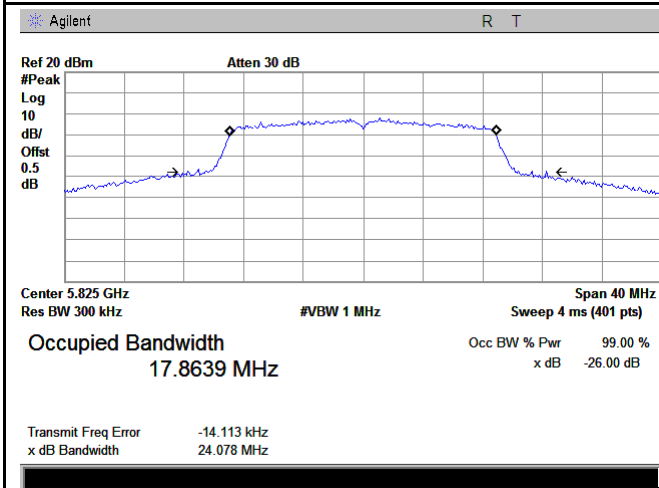

5725-5850MHz Bandwidth - High CH 5825

802.11n (40M)

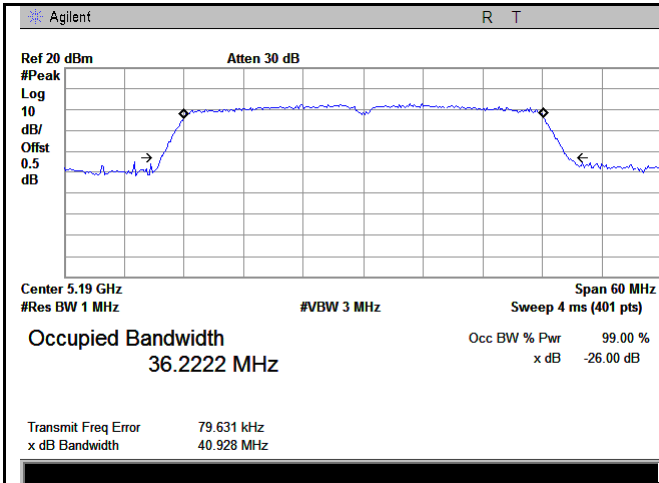

5150-5250MHz Bandwidth - Low CH 5190

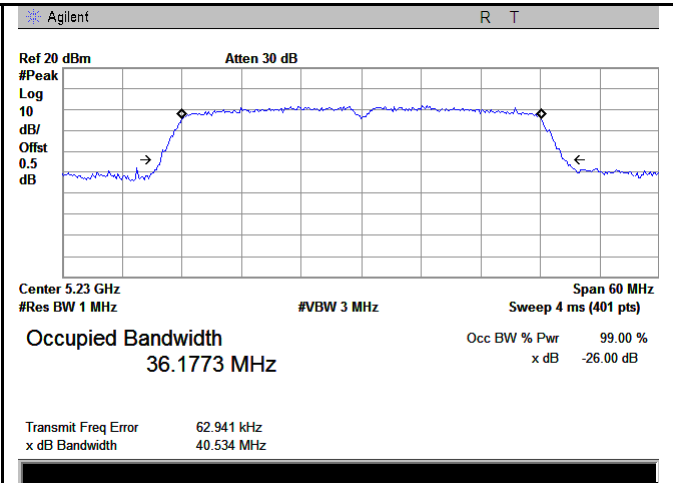

5150-5250MHz Bandwidth - High CH 5230

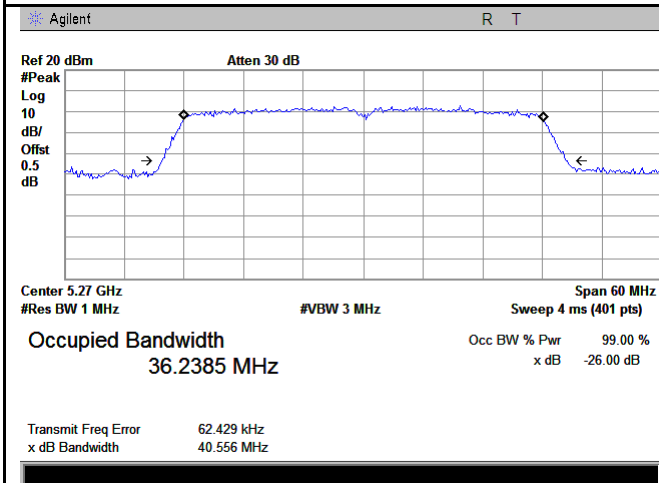

5250-5350MHz Bandwidth - Low CH 5270

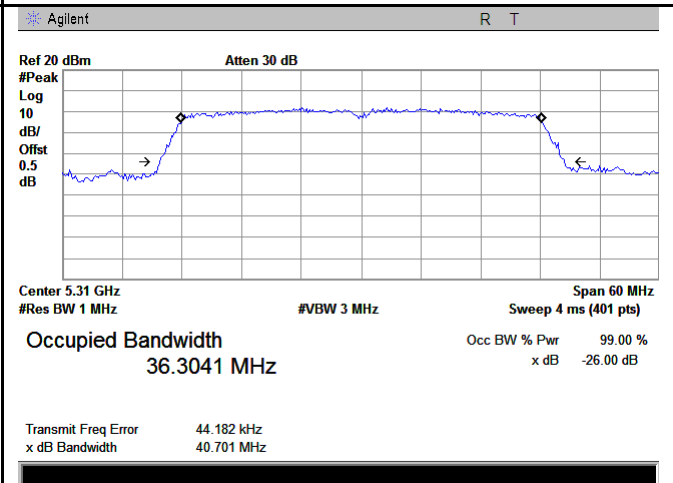

5250-5350MHz Bandwidth - High CH 5310

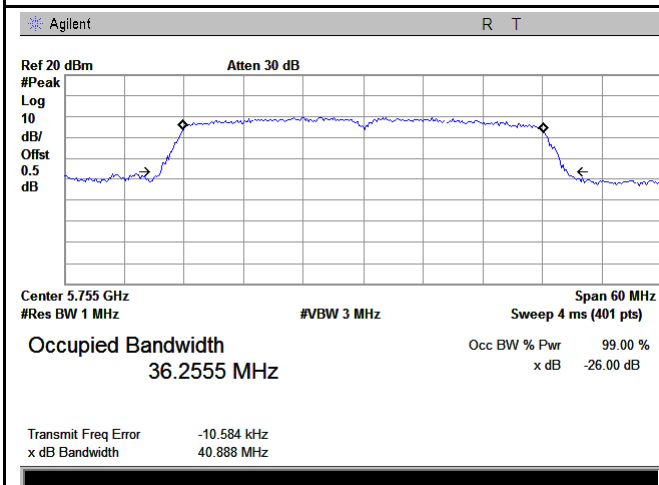

5725-5850MHz Bandwidth - Low CH 5755

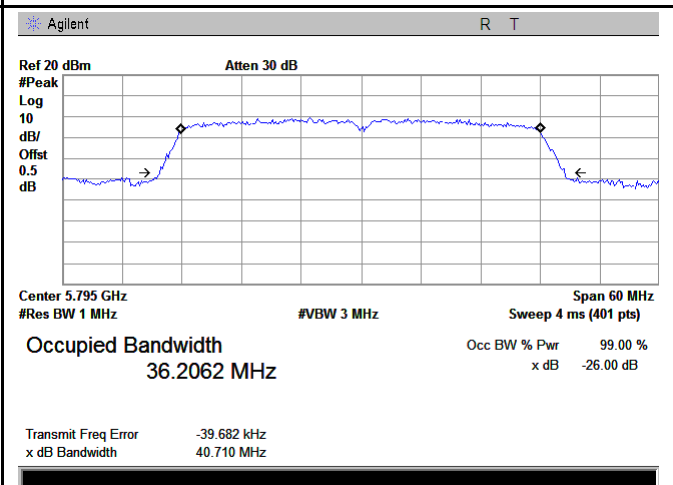

5725-5850MHz Bandwidth - High CH 5795

6.3 §15.407(a)-DTS (99% &6 dB) Channel Bandwidth

1. Conducted Measurement

EUT was set for low, mid, high channel with modulated mode and highest RF output power.

The spectrum analyzer was connected to the antenna terminal.

2. Environmental Conditions	Temperature	25°C
	Relative Humidity	53%
	Atmospheric Pressure	1010mbar

3. Conducted Emissions Measurement Uncertainty

All test measurements carried out are traceable to national standards. The uncertainty of the measurement at a confidence level of approximately 95% (in the case where distributions are normal), with a coverage factor of 2, in the range 30MHz – 40GHz is $\pm 1.5\text{dB}$.

4. Test date : September 12, 2017

Tested By : Loren Luo

Standard Requirement:

Within the 5.725-5.85 GHz band, the minimum 6 dB bandwidth of U-NII devices shall be at least 500 kHz.

Procedures:

99% &6 dB Bandwidth:

Section 15.407(e) specifies the minimum 6 dB emission bandwidth of at least 500 KHz for the band 5.715-5.85 GHz. The following procedure shall be used for measuring this bandwidth:

- a) Set RBW = 100 kHz.
- b) Set the video bandwidth (VBW) $\geq 3 \times$ RBW.
- c) Detector = Peak.
- d) Trace mode = max hold.
- e) Sweep = auto couple.
- f) Allow the trace to stabilize.
- g) Measure the maximum width of the emission that is constrained by the frequencies associated with the two outermost amplitude points (upper and lower frequencies) that are attenuated by 6 dB relative to the maximum level measured in the fundamental emission.

Note: The automatic bandwidth measurement capability of a spectrum analyzer or EMI receiver may be employed if it implements the functionality described above.

Emission Bandwidth (EBW)

- 1) Set RBW = approximately 1% of the emission bandwidth.
- 2) Set the VBW > RBW.
- 3) Detector = Peak.
- 4) Trace mode = max hold.
- 5) Measure the maximum width of the emission that is 26 dB down from the maximum of the emission. Compare this with the RBW setting of the analyzer. Readjust

Test Result: Pass.

Please refer to the following tables and plots.

Measurement result

Test mode	Freq Band (MHz)	CH	Freq (MHz)	99% Occupied Bandwidth (MHz)	6dB Bandwidth (MHz)
802.11a (20M)	5725-5850	Low	5745	16.4132	15.432
		Mid	5785	16.4279	15.997
		High	5825	16.4169	15.715
802.11n (20M)	5725-5850	Low	5745	17.6432	15.334
		Mid	5785	17.6139	15.190
		High	5825	17.5892	15.206
802.11n (40M)	5725-5850	Low	5755	35.8823	35.855
		High	5795	35.8296	35.743

Test Plots (Bandwidth measurement result)

5725-5850MHz

802.11a (20M)

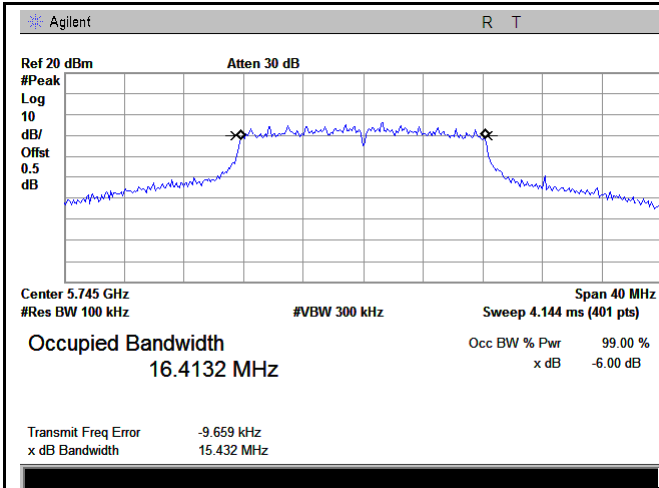

5725-5850MHz Bandwidth - Low CH 5745

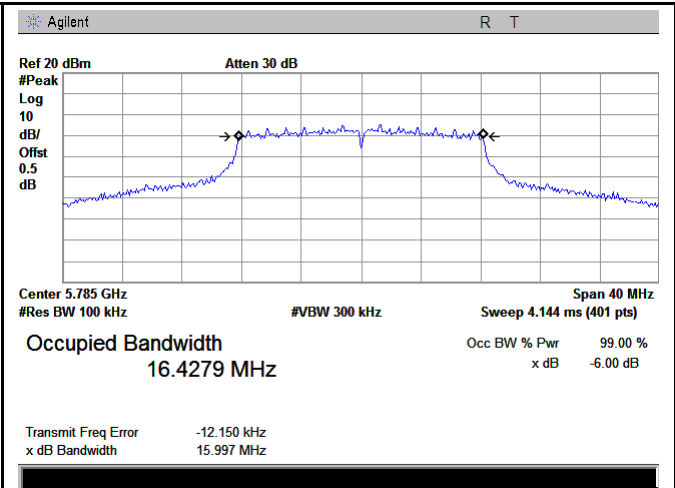

5725-5850MHz Bandwidth - Mid CH 5785

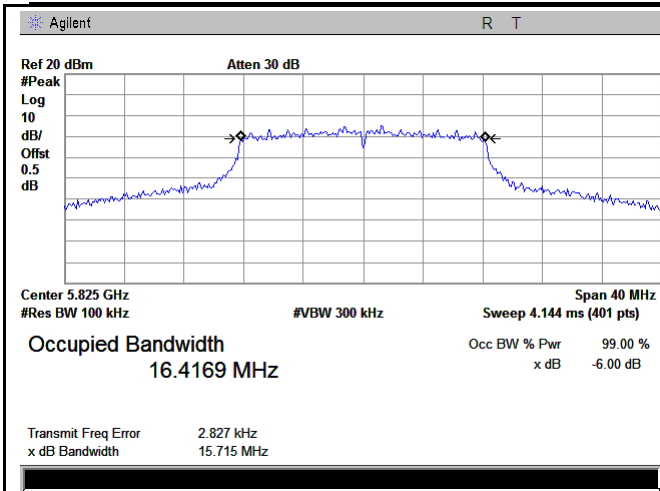

5725-5850MHz Bandwidth - High CH 5825

802.11n (20M)

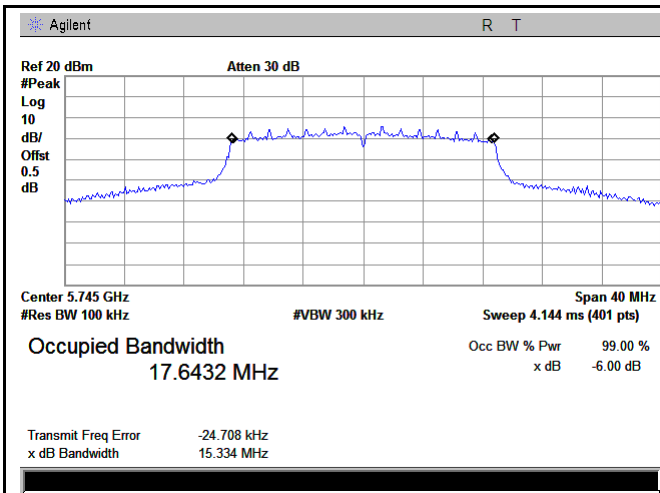

5725-5850MHz Bandwidth - Low CH 5745

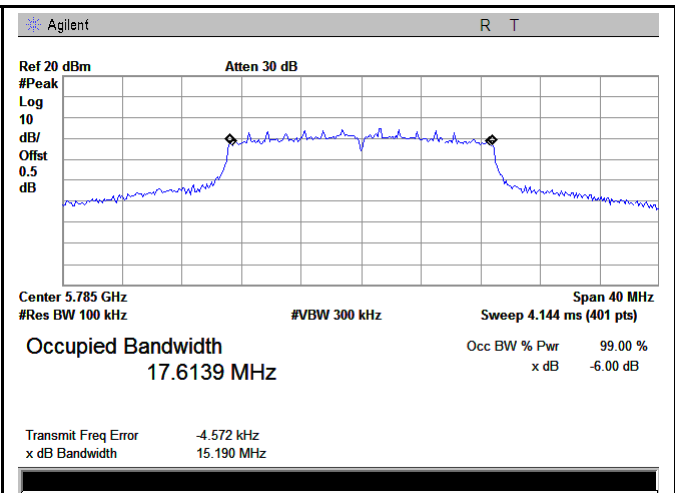

5725-5850MHz Bandwidth - Mid CH 5785

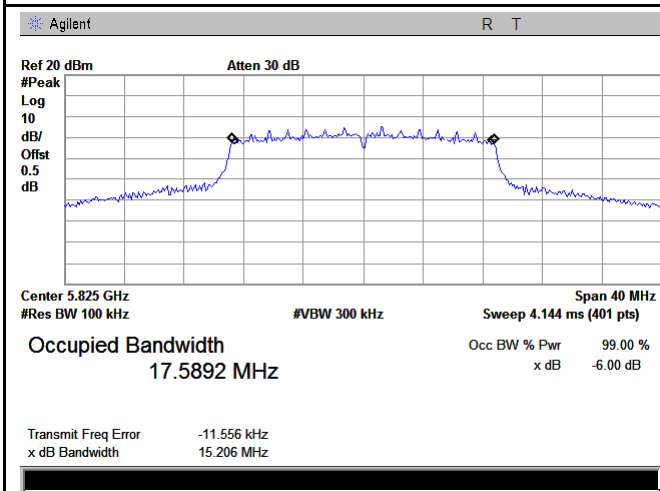

5725-5850MHz Bandwidth - High CH 5825

802.11n (40M)

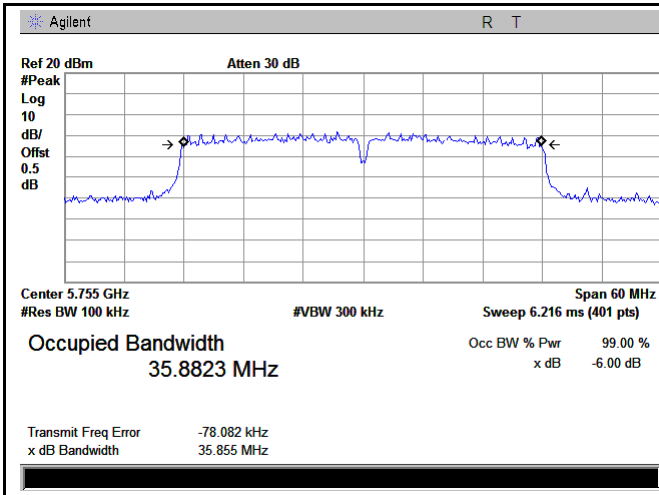

5725-5850MHz Bandwidth - Low CH 5755

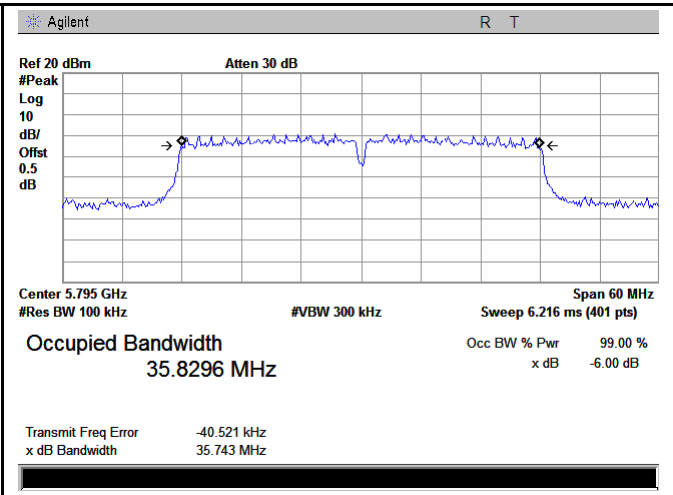

5725-5850MHz Bandwidth - High CH 5795

6.4 §15.407(a)-Conducted Maximum Output Power

1. Conducted Measurement

EUT was set for low, mid, high channel with modulated mode and highest RF output power.

The spectrum analyzer was connected to the antenna terminal.

2. Conducted Emissions Measurement Uncertainty

All test measurements carried out are traceable to national standards. The uncertainty of the measurement at a confidence level of approximately 95% (in the case where distributions are normal), with a coverage factor of 2, in the range 30MHz – 40GHz is $\pm 1.5\text{dB}$.

3. Environmental Conditions	Temperature	25°C
	Relative Humidity	53%
	Atmospheric Pressure	1010mbar

4. Test date : September 12, 2017

Tested By : Loren Luo

Standard Requirement:

For an outdoor access point operating in the band 5.15-5.25 GHz, the maximum conducted output power over the frequency band of operation shall not exceed 1 W provided the maximum antenna gain does not exceed 6 dBi. If transmitting antennas of directional gain greater than 6 dBi are used, both the maximum conducted output power and the maximum power spectral density shall be reduced by the amount in dB that the directional gain of the antenna exceeds 6 dBi. The maximum e.i.r.p. at any elevation angle above 30 degrees as measured from the horizon must not exceed 125 mW (21 dBm).

For the 5.25-5.35 GHz and 5.47-5.725 GHz bands, the maximum conducted output power over the frequency bands of operation shall not exceed the lesser of 250 mW or $11\text{ dBm} + 10\log B$, where B is the 26 dB emission bandwidth in megahertz. If transmitting antennas of directional gain greater than 6 dBi are used, both the maximum conducted output power and the maximum power spectral density shall be reduced by the amount in dB that the directional gain of the antenna exceeds 6 dBi.

For the band 5.725-5.85 GHz, the maximum conducted output power over the frequency band of operation shall not exceed 1 W.

If transmitting antennas of directional gain greater than 6 dBi are used, both the maximum conducted output power and the maximum power spectral density shall be reduced by the amount in dB that the directional gain of the antenna exceeds 6 dBi. However, fixed point-to-point U-NII devices operating in this band may employ transmitting antennas with directional gain greater than 6 dBi without any corresponding reduction in transmitter conducted power. Fixed, point-to-point operations exclude the use of point-to-multipoint systems, omnidirectional applications, and multiple collocated transmitters transmitting the same information. The operator of the U-NII device, or if the equipment is professionally installed, the installer, is responsible for ensuring that systems employing high gain directional antennas are used exclusively for fixed, point-to-point operations.

Procedures:

Measurement Procedure Maximum conducted output power:

Maximum conducted output power may be measured using a spectrum analyzer/EMI receiver or an RF power meter.

1. Device Configuration

If possible, configure or modify the operation of the EUT so that it transmits continuously at its maximum power control level (see section II.B.).

- a) The intent is to test at 100 percent duty cycle; however a small reduction in duty cycle (to no lower than 98 percent) is permitted if required by the EUT for amplitude control purposes. Manufacturers are expected to provide software to the test lab to permit such continuous operation.
- b) If continuous transmission (or at least 98 percent duty cycle) cannot be achieved due to hardware limitations (e.g., overheating), the EUT shall be operated at its maximum power control level with the transmit duration as long as possible and the duty cycle as high as possible.

2. Measurement using a Power Meter (PM)

a) Method PM (Measurement using an RF average power meter):

(i) Measurements may be performed using a wideband RF power meter with a thermocouple detector or equivalent if all of the conditions listed below are satisfied.

- The EUT is configured to transmit continuously or to transmit with a constant duty cycle.
- At all times when the EUT is transmitting, it must be transmitting at its maximum power control level.

- The integration period of the power meter exceeds the repetition period of the transmitted signal by at least a factor of five.

(ii) If the transmitter does not transmit continuously, measure the duty cycle, x , of the transmitter output signal as described in section II.B.

(iii) Measure the average power of the transmitter. This measurement is an average over both the on and off periods of the transmitter.

(iv) Adjust the measurement in dBm by adding $10 \log(1/x)$ where x is the duty cycle (e.g., 10

$\log(1/0.25)$ if the duty cycle is 25 percent).

Test Result: Pass.

Please refer to the following tables and plots:

Output Power measurement result

Test mode	Freq Band (MHz)	CH	Frequency (MHz)	Conducted Power (dBm)	Duty factor (dB)	Conducted Power with D.F(dBm)	Limit (dBm)	Result
820.11a	5150-5250	Low	5180	9.53	0.18	9.71	30	Pass
		Middle	5220	9.31	0.18	9.49	30	Pass
		High	5240	9.59	0.18	9.77	30	Pass
	5250-5350	Low	5260	9.60	0.18	9.78	23.79	Pass
		Middle	5300	9.67	0.18	9.85	23.86	Pass
		High	5320	9.96	0.18	10.14	23.93	Pass
	5725-5850	Low	5745	8.88	0.18	9.06	30	Pass
		Mid	5785	8.52	0.18	8.7	30	Pass
		High	5825	8.26	0.18	8.44	30	Pass
802.11n (20M)	5150-5250	Low	5180	9.26	0.18	9.44	30	Pass
		Middle	5220	9.78	0.18	9.96	30	Pass
		High	5240	9.48	0.18	9.66	30	Pass
	5250-5350	Low	5260	9.97	0.18	10.15	23.98	Pass
		Middle	5300	9.46	0.18	9.64	23.98	Pass
		High	5320	9.40	0.18	9.58	23.98	Pass
	5725-5850	Low	5745	8.80	0.18	8.98	30	Pass
		Mid	5785	8.36	0.18	8.54	30	Pass
		High	5825	8.64	0.18	8.82	30	Pass
802.11n (40M)	5150-5250	Low	5190	8.42	0.36	8.78	30	Pass
		High	5230	8.70	0.36	9.06	30	Pass
	5250-5350	Low	5270	8.65	0.36	9.01	23.98	Pass
		High	5310	8.21	0.36	8.57	23.98	Pass
	5725-5850	Low	5755	7.16	0.36	7.52	30	Pass
		High	5795	7.28	0.36	7.64	30	Pass

Note 1: Duty factor=10log(1/x), where x is the duty cycle.

For 20 MHz bandwidth, the duty cycle is 96%;

For 40 MHz bandwidth, the duty cycle is 92%;

For 80 MHz bandwidth, the duty cycle is 85%;

Test Report No.	17070659-FCC-R6
Page	36 of 74

Note 2: The AX8 will be sold without antenna, it is no requirement that The maximum e.i.r.p. at any elevation angle above 30 degrees as measured from the horizon must not exceed 125 mW (21 dBm) for an outdoor access point operating in the band 5.15-5.25 GHz,.

6.5 §15.407(a) - Power Spectral Density

1. Conducted Measurement

EUT was set for low, mid, high channel with modulated mode and highest RF output power.

The spectrum analyzer was connected to the antenna terminal.

2. Environmental Conditions	Temperature	25°C
	Relative Humidity	53%
	Atmospheric Pressure	1010mbar

3. Conducted Emissions Measurement Uncertainty

All test measurements carried out are traceable to national standards. The uncertainty of the measurement at a confidence level of approximately 95% (in the case where distributions are normal), with a coverage factor of 2, in the range 30MHz – 40GHz is ± 1.5 dB.

4. Test date : September 12&27, 2017

Tested By : Loren Luo

Standard Requirement:

The maximum power spectral density shall not exceed 17 dBm in any 1 megahertz band. If transmitting antennas of directional gain greater than 6 dBi are used, both the maximum conducted output power and the maximum power spectral density shall be reduced by the amount in dB that the directional gain of the antenna exceeds 6 dBi. The maximum e.i.r.p. at any elevation angle above 30 degrees as measured from the horizon must not exceed 125 mW (21 dBm).

The maximum power spectral density shall not exceed 11 dBm in any 1 megahertz band. If transmitting antennas of directional gain greater than 6 dBi are used, both the maximum conducted output power and the maximum power spectral density shall be reduced by the amount in dB that the directional gain of the antenna exceeds 6 dBi.

The maximum power spectral density shall not exceed 30 dBm in any 500-kHz band. If transmitting antennas of directional gain greater than 6 dBi are used, both the maximum conducted output power and the maximum power spectral density shall be reduced by the amount in dB that the directional

gain of the antenna exceeds 6 dBi. However, fixed point-to-point U-NII devices operating in this band may employ transmitting antennas with directional gain greater than 6 dBi without any corresponding reduction in transmitter conducted power. Fixed, point-to-point operations exclude the use of point-to-multipoint systems, omnidirectional applications, and multiple collocated transmitters transmitting the same information. The operator of the U-NII device, or if the equipment is professionally installed, the installer, is responsible for ensuring that systems employing high gain directional antennas are used exclusively for fixed, point-to-point operations.

Procedures:

The rules requires “ maximum power spectral density” measurements where the intent is to measure the maximum value of the time average of the power spectral density measured during a period of continuous transmission.

1. Create an average power spectrum for the EUT operating mode being tested by following the instructions in section II.E.2. for measuring maximum conducted output power using a spectrum analyzer or EMI receiver: select the appropriate test method (SA-1, SA-2, SA-3, or alternatives to each) and apply it up to, but not including, the step labeled, “ Compute power...” . (This procedure is required even if the maximum conducted output power measurement was performed using a power meter, method PM.)
2. Use the peak search function on the instrument to find the peak of the spectrum and record its value.
3. Make the following adjustments to the peak value of the spectrum, if applicable:
 - a) If Method SA-2 or SA-2 Alternative was used, add $10 \log(1/x)$, where x is the duty cycle, to the peak of the spectrum.
 - b) If Method SA-3 Alternative was used and the linear mode was used in step II.E.2.g)(viii), add 1 dB to the final result to compensate for the difference between linear averaging and power averaging.
4. The result is the Maximum PSD over 1 MHz reference bandwidth.
5. For devices operating in the bands 5.15-5.25 GHz, 5.25-5.35 GHz, and 5.47-5.725 GHz, the above procedures make use of 1 MHz RBW to satisfy directly the 1 MHz reference bandwidth specified in § 15.407(a)(5). For devices operating in the band 5.725-5.85 GHz, the rules specify a measurement bandwidth of 500 kHz. Many spectrum analyzers do not have 500 kHz RBW, thus a narrower RBW may need to be used. The rules permit the use of a RBWs less than 1 MHz, or 500 kHz, “ provided that the measured power is integrated over the full reference bandwidth” to show the total power over the specified measurement bandwidth (i.e., 1 MHz, or 500 kHz). If measurements are performed using a reduced resolution bandwidth (< 1 MHz, or < 500 kHz) and

integrated over 1 MHz, or 500 KHz bandwidth, the following adjustments to the procedures apply:

- a) Set $RBW \geq 1/T$, where T is defined in section II.B.I.a).
- b) Set $VBW \geq 3 RBW$.
- c) If measurement bandwidth of Maximum PSD is specified in 500 kHz, add $10\log(500\text{kHz}/RBW)$ to the measured result, whereas $RBW (< 500 \text{ KHz})$ is the reduced resolution bandwidth of the spectrum analyzer set during measurement.
- d) If measurement bandwidth of Maximum PSD is specified in 1 MHz, add $10\log(1\text{MHz}/RBW)$ to the measured result, whereas $RBW (< 1 \text{ MHz})$ is the reduced resolution bandwidth of spectrum analyzer set during measurement.
- e) Care must be taken to ensure that the measurements are performed during a period of continuous transmission or are corrected upward for duty cycle.

Note: As a practical matter, it is recommended to use reduced RBW of 100 KHz for the sections 5.c) and 5.d) above, since $RBW=100 \text{ KHZ}$ is available on nearly all spectrum analyzers.

Test Result: Pass.

Please refer to the following tables and plots.

Power Spectral Density measurement result

Test mode	Freq Band (MHz)	CH	Frequency (MHz)	Measured PSD (dBm)	Duty cycle factor (dB)	PSD (dBm)	Limit (dBm)	Result
820.11a	5150-5250	Low	5180	5.604	0.18	5.784	17	Pass
		Mid	5220	6.694	0.18	6.874	17	Pass
		High	5240	5.391	0.18	5.571	17	Pass
	5250-5350	Low	5260	5.409	0.18	5.589	11	Pass
		Mid	5300	5.323	0.18	5.503	11	Pass
		High	5320	6.521	0.18	6.701	11	Pass
	5725-5850	Low	5745	2.135	0.18	2.315	30	Pass
		Mid	5785	3.439	0.18	3.619	30	Pass
		High	5825	3.496	0.18	3.676	30	Pass
802.11n (20M)	5150-5250	Low	5180	5.873	0.18	6.053	17	Pass
		Middle	5220	4.689	0.18	4.869	17	Pass
		High	5240	5.479	0.18	5.659	17	Pass
	5250-5350	Low	5260	5.643	0.18	5.823	11	Pass
		Middle	5300	4.358	0.18	4.538	11	Pass
		High	5320	5.313	0.18	5.493	11	Pass
	5725-5850	Low	5745	1.517	0.18	1.697	30	Pass
		Mid	5785	3.944	0.18	4.124	30	Pass
		High	5825	3.572	0.18	3.752	30	Pass
802.11n (40M)	5150-5250	Low	5190	2.520	0.36	2.880	17	Pass
		High	5230	1.134	0.36	1.494	17	Pass
	5250-5350	Low	5270	2.117	0.36	2.477	11	Pass
		High	5310	1.873	0.36	2.233	11	Pass
	5725-5850	Low	5755	1.492	0.36	1.852	30	Pass
		High	5795	1.188	0.36	1.548	30	Pass

Note: Duty factor=10log(1/x), where x is the duty cycle.

For 20 MHz bandwidth, the duty cycle is 96%;

For 40 MHz bandwidth, the duty cycle is 92%;

For 80 MHz bandwidth, the duty cycle is 85%;

Test Plots

Power Spectral Density measurement result Test Plots

802.11a

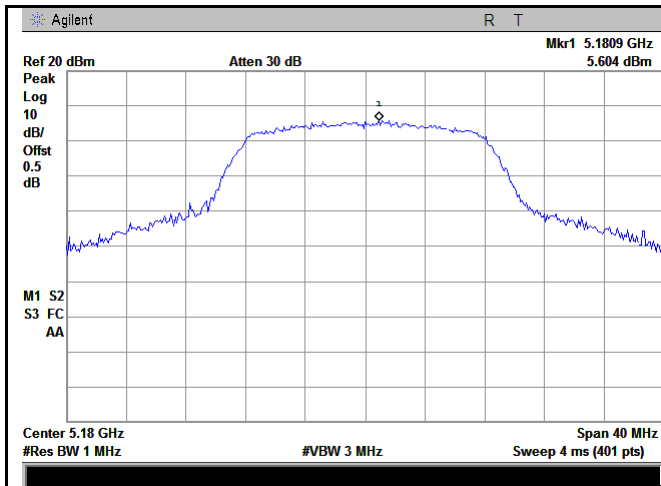

5150-5250MHz PSD - Low CH 5180

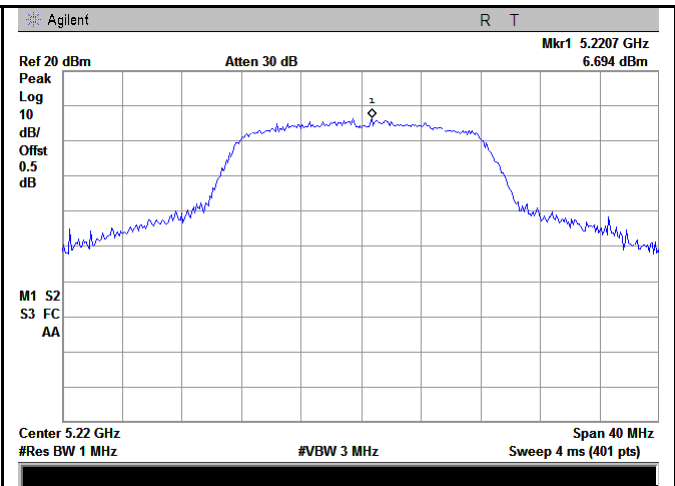

5150-5250MHz PSD - Middle CH 5220

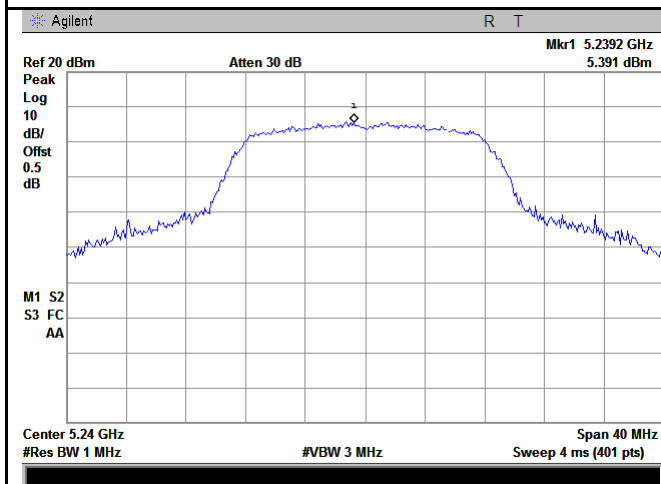

5150-5250MHz PSD - High CH 5240

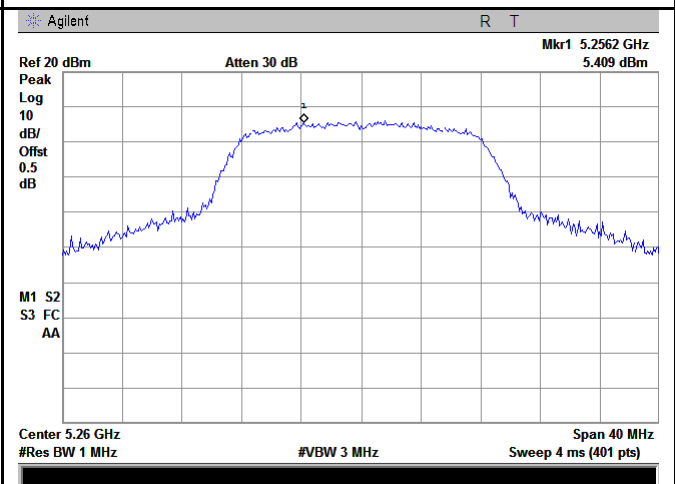

5250-5350MHz PSD - Low CH 5260

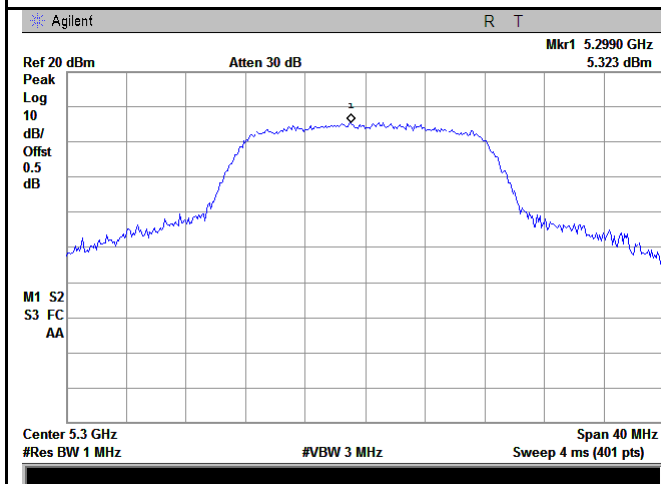

5250-5350MHz PSD - Middle CH 5300

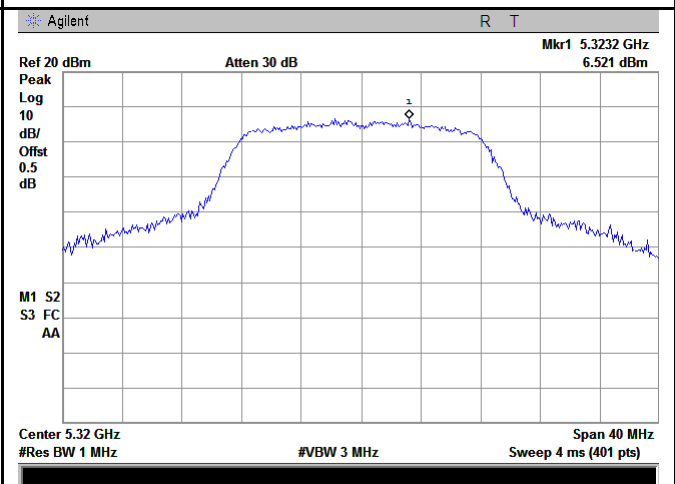

5250-5350MHz PSD - High CH 5320

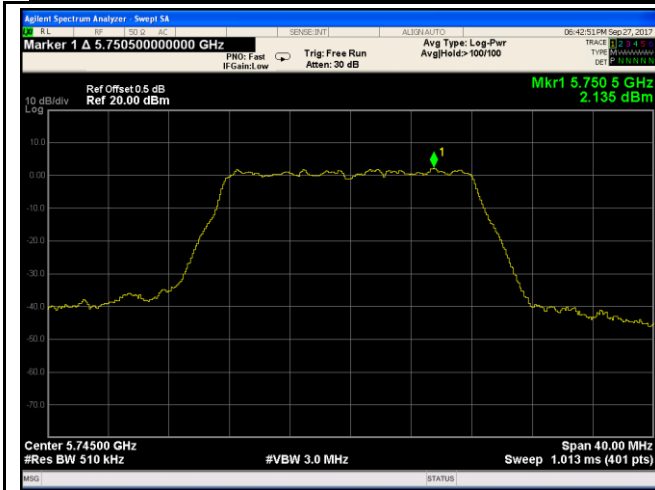

5725-5850MHz PSD - Low CH 5745

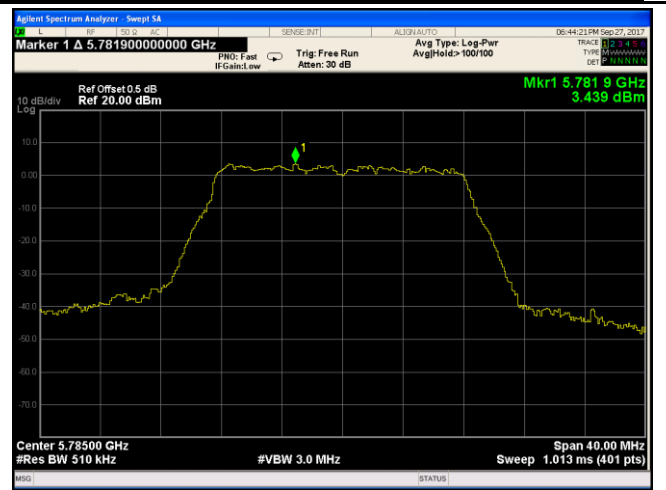

5725-5850MHz PSD - Mid CH 5785

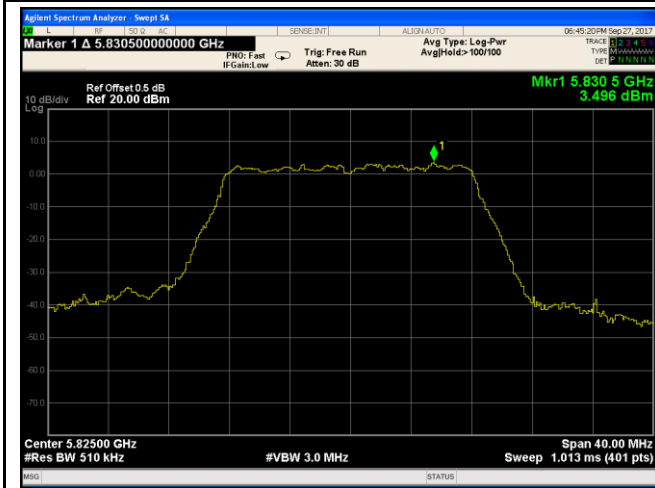

5725-5850MHz PSD - High CH 5825

802.11n (20M)

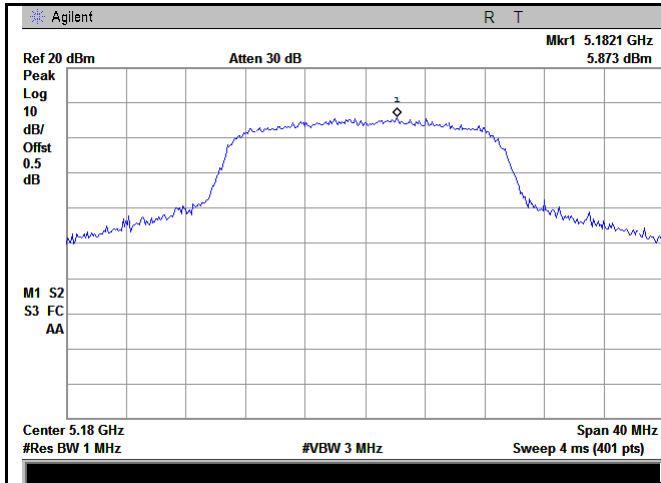

5150-5250MHz PSD - Low CH 5180

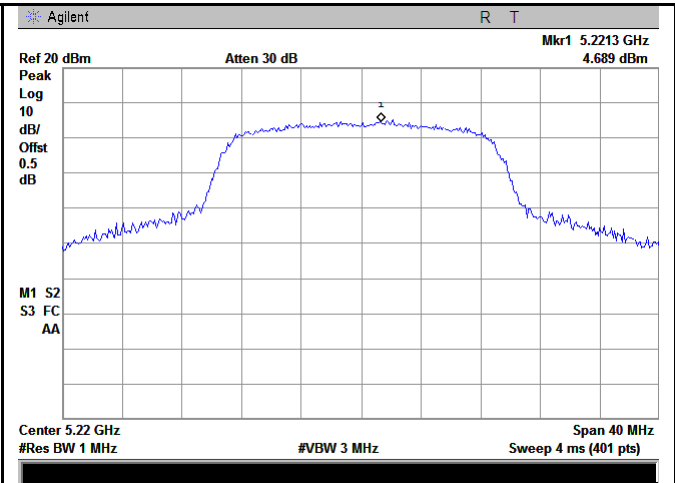

5150-5250MHz PSD - Middle CH 5220

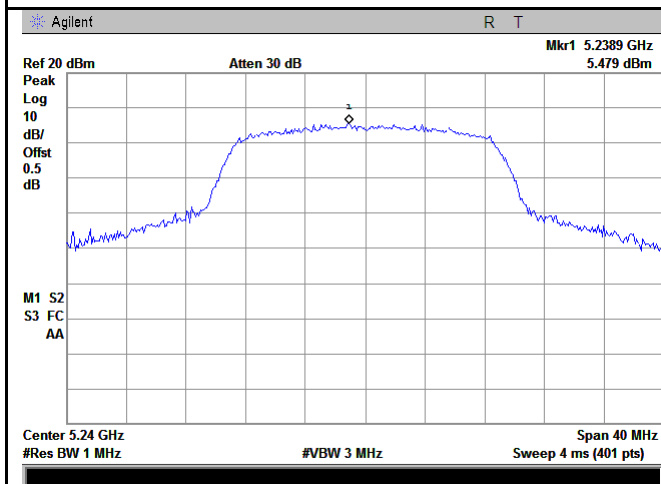

5150-5250MHz PSD - High CH 5240

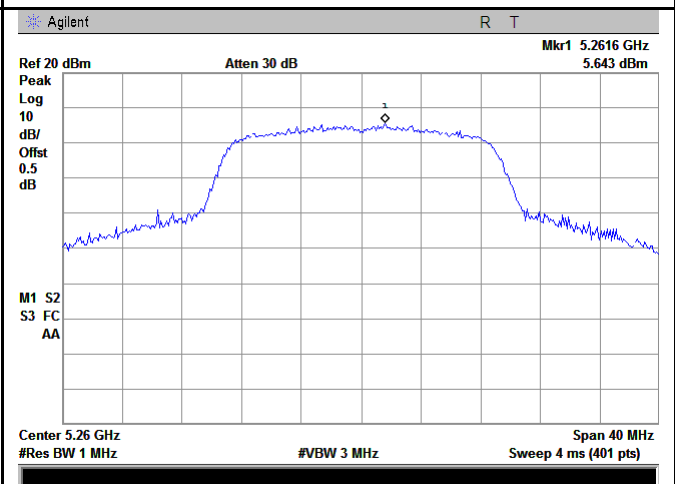

5250-5350MHz PSD - Low CH 5260

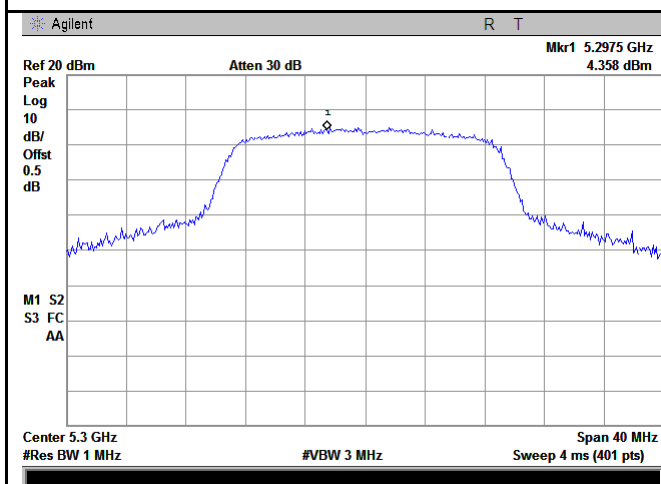

5250-5350MHz PSD - Middle CH 5300

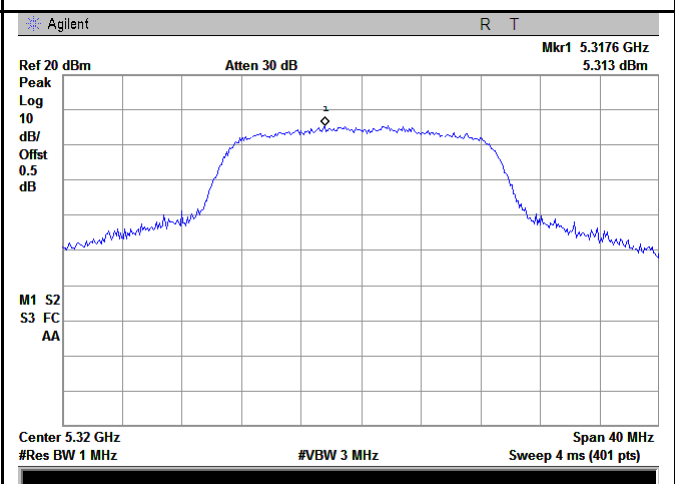

5250-5350MHz PSD - High CH 5320

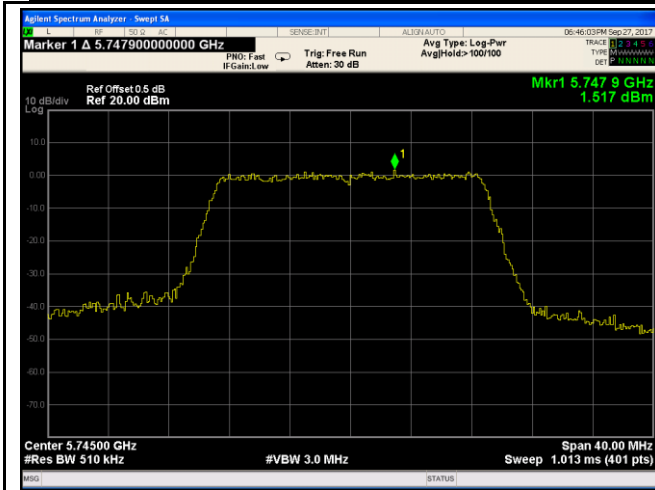

5725-5850MHz PSD - Low CH 5745

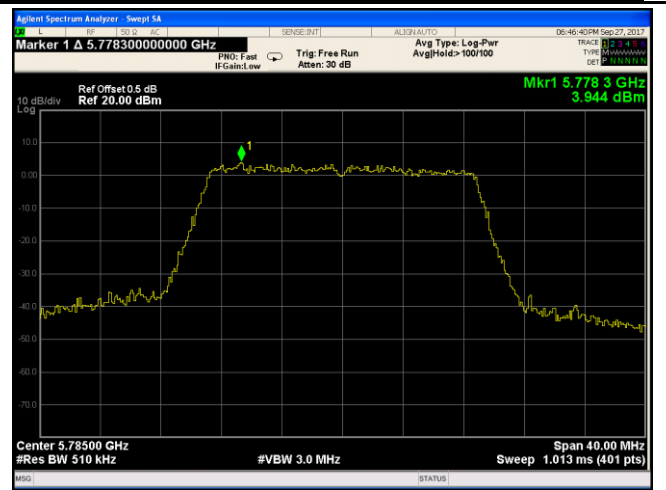

5725-5850MHz PSD - Mid CH 5785

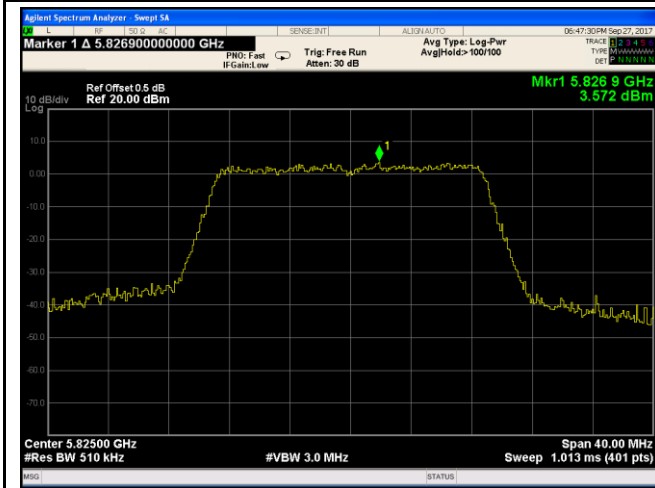

5725-5850MHz PSD - High CH 5825



802.11n (40M)

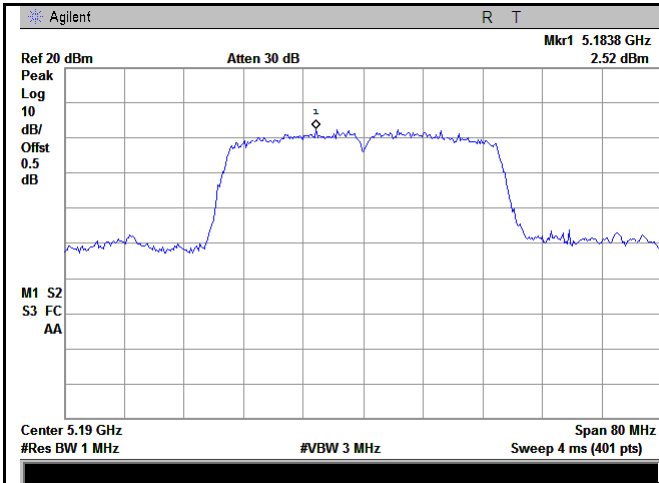

5150-5250MHz PSD - Low CH 5190

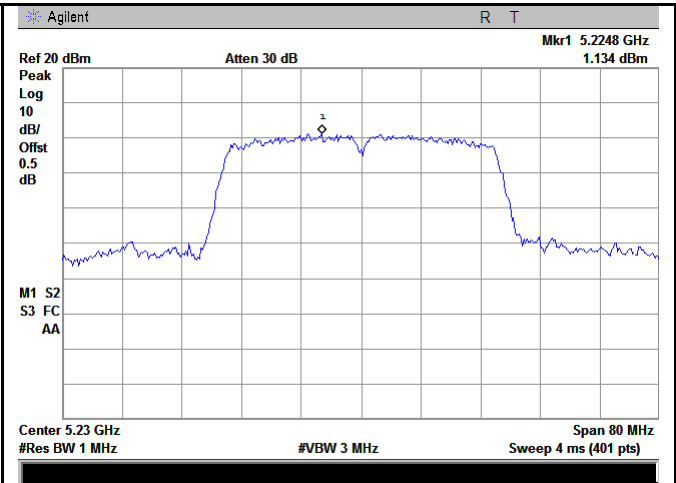

5150-5250MHz PSD - High CH 5230

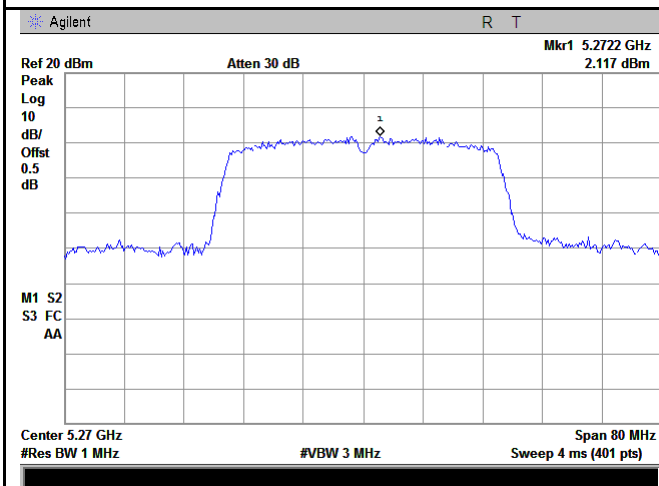

5250-5350MHz PSD - Low CH 5270

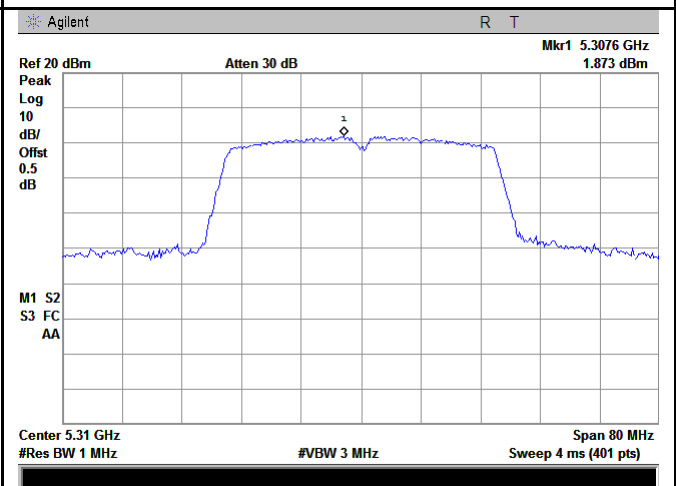

5250-5350MHz PSD - High CH 5310

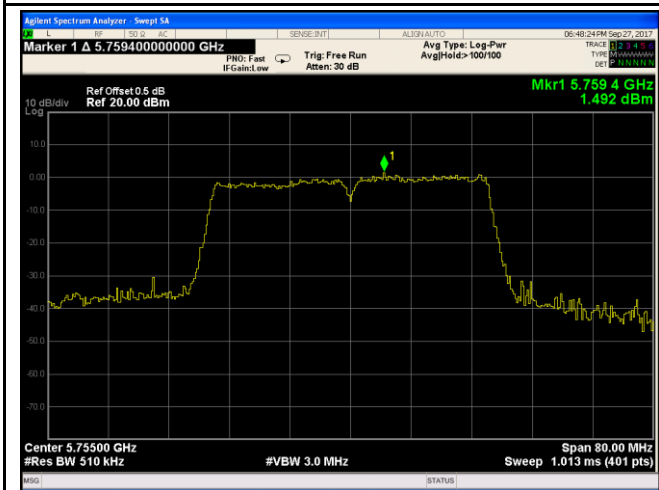

5725-5850MHz PSD - Low CH 5755

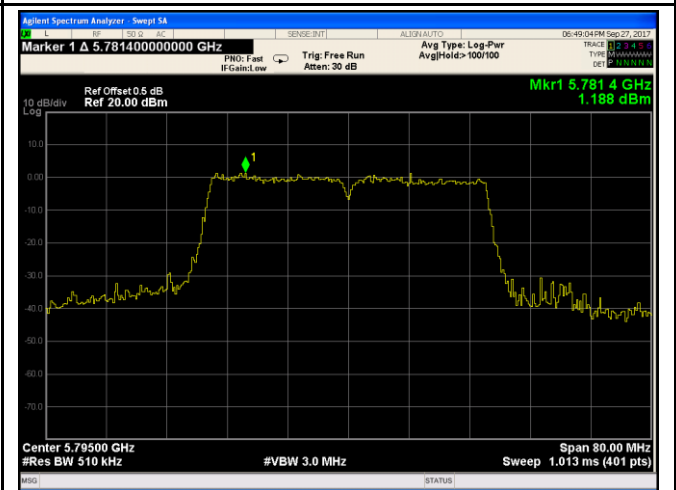

5725-5850MHz PSD - High CH 5795

6.6 §15.407(1) and b(4) Band-Edge

1. Conducted Measurement

EUT was set for low, mid, high channel with modulated mode and highest RF output power.

The spectrum analyzer was connected to the antenna terminal.

2. Environmental Conditions	Temperature	25°C
	Relative Humidity	53%
	Atmospheric Pressure	1010mbar

3. Conducted Emissions Measurement Uncertainty

All test measurements carried out are traceable to national standards. The uncertainty of the measurement at a confidence level of approximately 95% (in the case where distributions are normal), with a coverage factor of 2, in the range 30MHz – 40GHz is ± 1.5 dB.

4. Test date : Septemebr12&28, 2017

Tested By : Loren Luo

Standard Requirement:

(b) Undesirable emission limits. Except as shown in paragraph (b)(7) of this section, the maximum emissions outside of the frequency bands of operation shall be attenuated in accordance with the following limits:

(1) For transmitters operating in the 5.15-5.25 GHz band: All emissions outside of the 5.15-5.35 GHz band shall not exceed an e.i.r.p. of - 27 dBm/MHz.

(2) For transmitters operating in the 5.25-5.35 GHz band: All emissions outside of the 5.15-5.35 GHz band shall not exceed an e.i.r.p. of - 27 dBm/MHz.

(3) For transmitters operating in the 5.47-5.725 GHz band: All emissions outside of the 5.47-5.725 GHz band shall not exceed an e.i.r.p. of - 27 dBm/MHz.

(4) For transmitters operating in the 5.725-5.85 GHz band:

Procedures:

Measurement Procedure Band edge:

Bandedge are measured by setting the analyzer as follows:

- (i) RBW = 1 MHz.
- (ii) VBW \geq 3 MHz.
- (iii) Detector = Peak.
- (iv) Sweep time = auto.
- (v) Trace mode = max hold.
- (vi) Allow sweeps to continue until the trace stabilizes. Note that if the transmission is not continuous, the time required for the trace to stabilize will increase by a factor of approximately $1/x$, where x is the duty cycle. For example, at 50 percent duty cycle, the measurement time will increase by a factor of two relative to measurement time for continuous transmission.

Unwanted band-edge emissions may be measured using either of the special band-edge measurement techniques (the marker-delta or integration methods) described below. Note that the marker-delta method is primarily a radiated measurement technique that requires the 99% occupied bandwidth edge to be within 2 MHz of the authorized band edge, whereas the integration method can be used in either a radiated or conducted measurement without any special requirement with regards to the displacement of the unwanted emission(s) relative to the authorized bandwidth.

(i) Marker-Delta Method.

The marker-delta method, as described in ANSI C63.10, can be used to perform measurements of the radiated unwanted emissions level of emissions provided that the 99% occupied bandwidth of the fundamental is within 2 MHz of the authorized band-edge..

(ii) Integration Method •

For maximum emissions measurements, follow the procedures described in section II.G.5., “ Procedures for Unwanted Maximum Emissions Measurements above 1000 MHz” , except for the following changes:

- Set RBW = 100 kHz

- Set $VBW \geq 3 \cdot RBW$
- Perform a band-power integration across the 1 MHz bandwidth in which the band-edge emission level is to be measured. CAUTION: You must ensure that the spectrum analyzer or EMI receiver is set for peak-detection and max-hold for this measurement.
- For average emissions measurements, follow the procedures described in section II.G.6., “Procedures for Average Unwanted Emissions Measurements above 1000 MHz”, except for the following changes:
 - Set $RBW = 100 \text{ kHz}$
 - Set $VBW \geq 3 \cdot RBW$
 - Perform a band-power integration across the 1 MHz bandwidth in which the band-edge emission level is to be measured.

Test Result: Pass.

Please refer to the following tables and plots.

Band edge measurement result

Test mode	Freq Band (MHz)	CH	Frequency (MHz)	Measured Bandedge (dBm)	Corrected factor (dB)	Bandedge (dBm)	Limit (dBm)	Result
820.11a	5150-5350	Low	5180	-46.91	10	-36.91	-27	Pass
		High	5350	-47.00	10	-37.00	-27	Pass
802.11n (20M)	5150-5350	Low	5180	-47.73	10	-37.73	-27	Pass
		High	5320	-47.51	10	-37.51	-27	Pass
802.11n (40M)	5150-5350	Low	5190	-42.27	10	-32.27	-27	Pass
		High	5310	-40.93	10	-30.93	-27	Pass

Note: Corrected factor= $10\log(1\text{MHz}/100\text{KHz})=10$.

Test Plots

Band Edge measurement result

802.11a

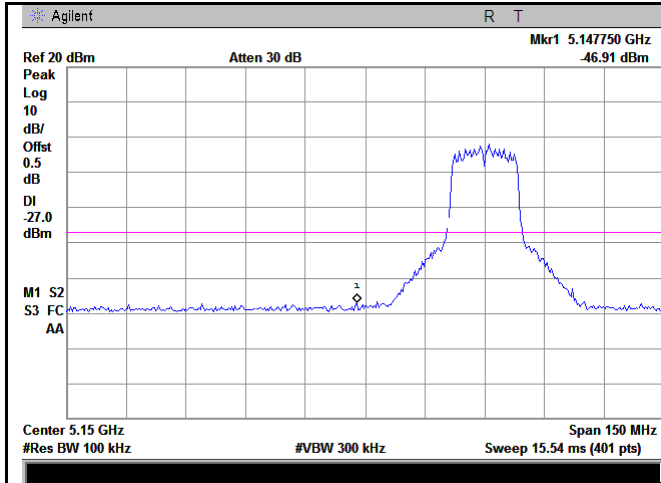

5150-5350MHz Band Edge - Low CH 5180

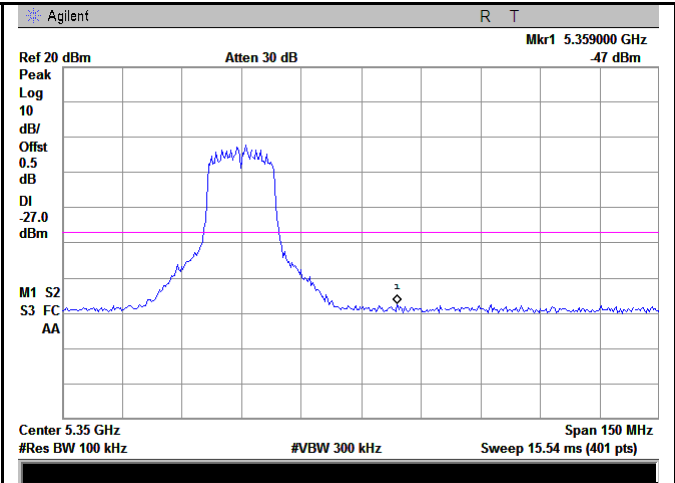

5150-5350MHz Band Edge - High CH 5320

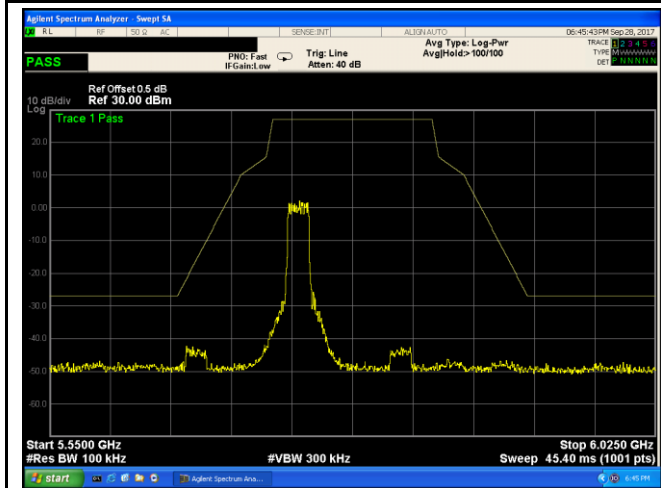

5725-5850MHz Band Edge - Low CH 5550

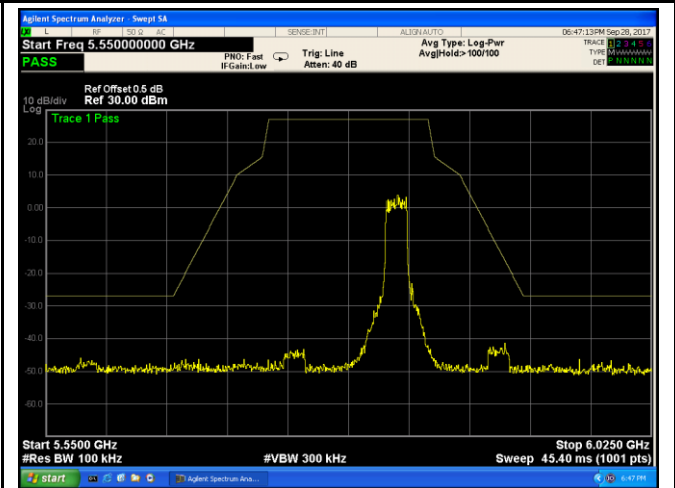

5725-5850MHz Band Edge - High CH 5550

802.11n (20M)

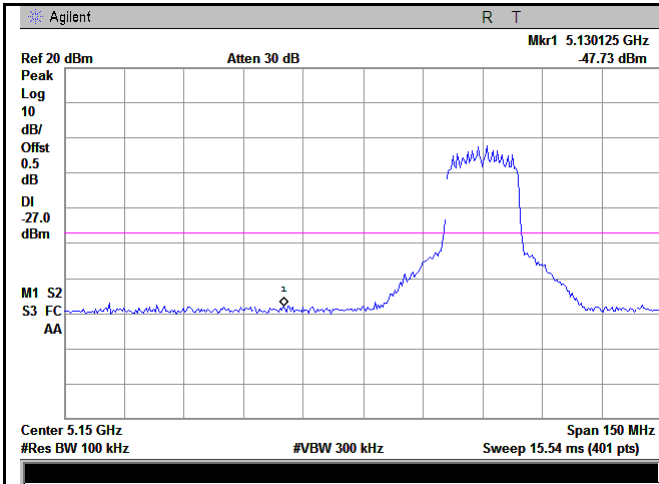

5150-5350MHz Band Edge - Low CH 5180

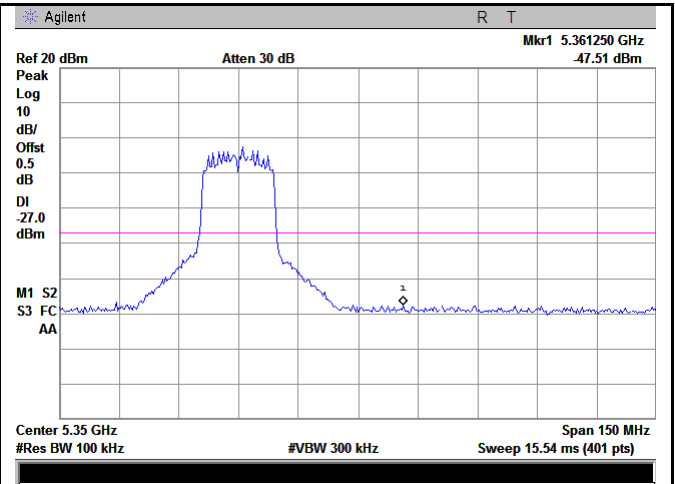

5150-5350MHz Band Edge - High CH 5320

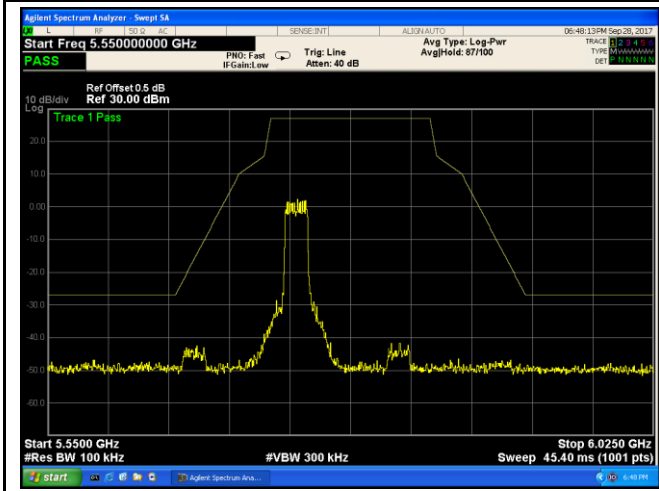

5725-5850MHz Band Edge - Low CH 5550

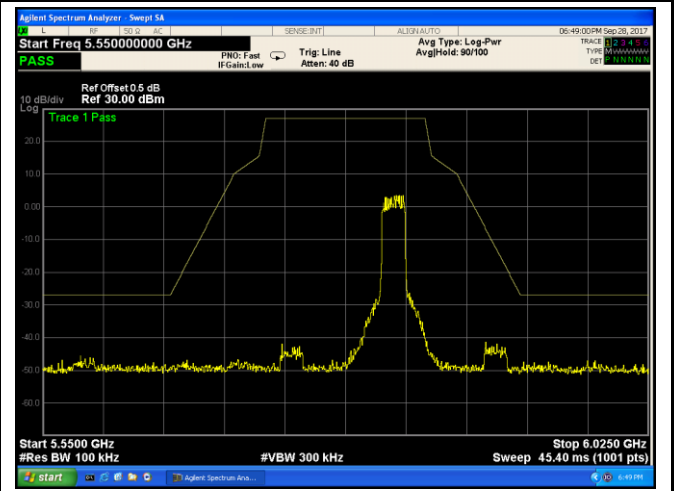

5725-5850MHz Band Edge - High CH 5550

802.11n (40M)

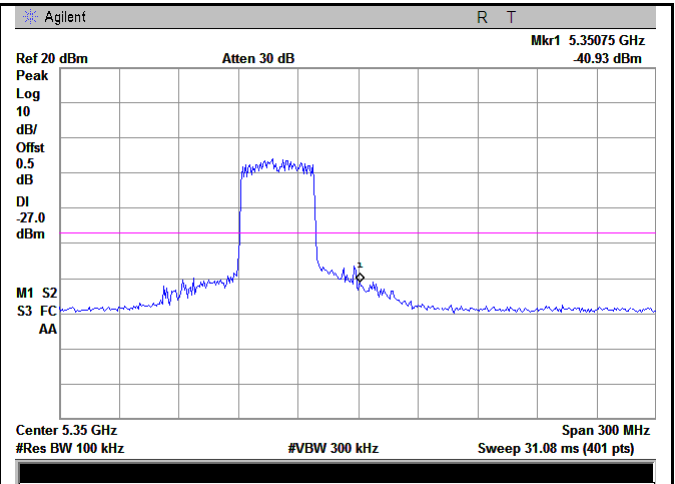
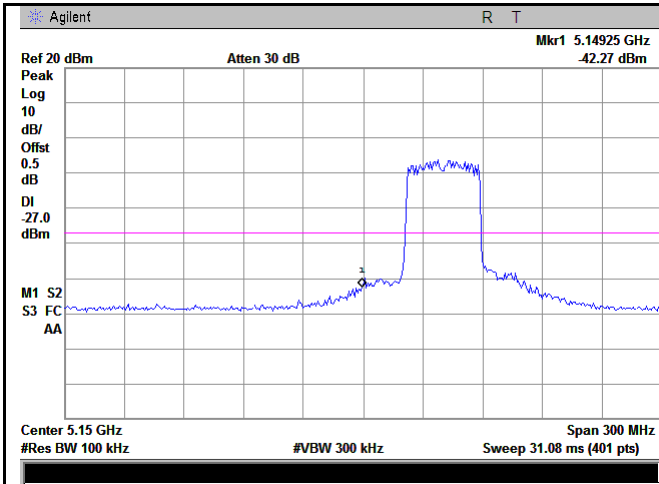

5150-5350MHz Band Edge - Low CH 5190

5150-5350MHz Band Edge - High CH 5310

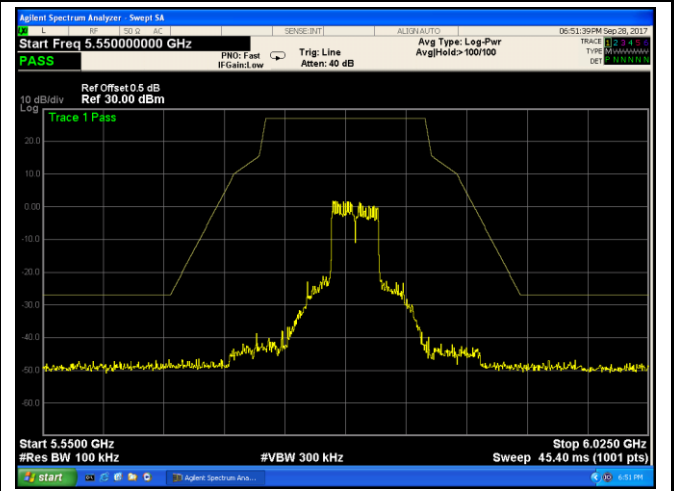
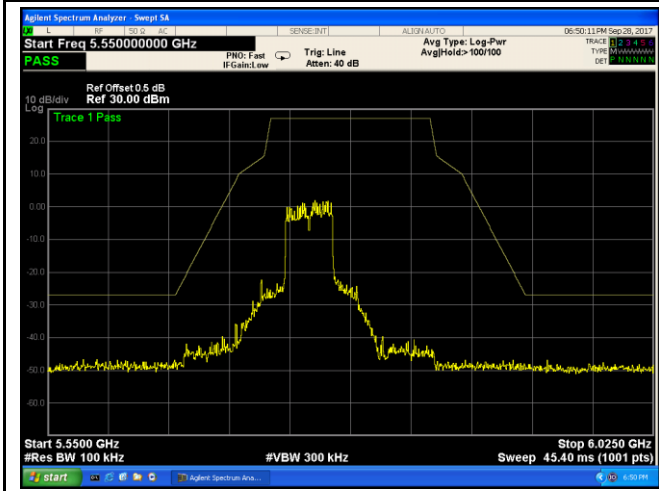

5725-5850MHz Band Edge - Low CH 5550

5725-5850MHz Band Edge - High CH 5550

Note: Add a correction factor (antenna gain+ attenuator loss + cable loss) to the offset of the spectrum analyzer.

6.7 §15.207 (a) - AC Power Line Conducted Emissions

Requirement:

Frequency of emission (MHz)	Conducted limit (dBμ V)	
	Quasi-peak	Average
0.15– 0.5	66 to 56*	56 to 46*
0.5– 5	56	46
5– 30	60	50

*Decreases with the logarithm of the frequency.

Procedures:

- All possible modes of operation were investigated. Only the 6 worst case emissions measured, using the correct CISPR and Average detectors, are reported. All other emissions were relatively insignificant.
- A "-ve" margin indicates a PASS as it refers to the margin present below the limit line at the particular frequency.
- Conducted Emissions Measurement Uncertainty
All test measurements carried out are traceable to national standards. The uncertainty of the measurement at a confidence level of approximately 95% (in the case where distributions are normal), with a coverage factor of 2, in the range 9kHz – 30MHz (Average & Quasi-peak) is ±3.5dB.
- Environmental Conditions

Temperature	22°C
Relative Humidity	57%
Atmospheric Pressure	1005mbar
- Test date: -----
Tested By :-----

Result : N/A

Note: The AX8 is powered by battery, so it is no need to test against this item.

6.8 §15.209, §15.205 & §15.407(b) - Radiated Spurious Emissions & Unwanted Emissions into Restricted Frequency Bands

1. All possible modes of operation were investigated. Only the 6 worst case emissions measured, using the correct CISPR detectors, are reported. All other emissions were relatively insignificant.
2. A "-ve" margin indicates a PASS as it refers to the margin present below the limit line at the particular frequency.
3. Radiated Emissions Measurement Uncertainty
All test measurements carried out are traceable to national standards. The uncertainty of the measurement at a confidence level of approximately 95% (in the case where distributions are normal), with a coverage factor of 2, in the range 30MHz – 1GHz & 1GHz above (3m & 10m) is +/-6dB.
4. Environmental Conditions

Temperature	23°C
Relative Humidity	54%
Atmospheric Pressure	1014mbar
5. Test date : September 11, 2017
Tested By : Loren Luo

Requirement: §15.407(b) specifies that emissions which fall in the restricted bands, as defined in **§15.205(a)**, must comply with the radiated emission limits specified in **§15.209(a)**.

Procedures:

Radiated Spurious Emissions Measurement

An additional consideration when performing conducted measurements of restricted band emissions is that unwanted emissions radiating from the EUT cabinet, control circuits, power leads, or intermediate circuit elements will likely go undetected in a conducted measurement configuration. To address this concern, a radiated test shall be performed to ensure that emissions emanating from the EUT cabinet (rather than the antenna port) also comply with the applicable limits.

For these radiated spurious emission measurements the EUT transmit antenna may be replaced with a termination matching the nominal impedance of the antenna. Established procedures for performing radiated measurements shall be used (see C63.10). All detected emissions must comply with the applicable limits.

Measurement Detectors

§15.35(a) specifies that on frequencies less than and below 1000 MHz, the radiated emissions limits assume the use of a CISPR quasi-peak detector function and related measurement bandwidths. §15.35(b) specifies that on frequencies above 1000 MHz, the radiated emissions limits assume the use of an average detector and a minimum resolution bandwidth of 1 MHz. In addition, §15.35(b) that when average radiated emissions measurements are specified there is also a limit on the peak emissions level which is 20 dB above the applicable maximum permitted average emission limit. These specifications also apply to conducted emissions measurements.

1. CISPR Quasi-Peak Measurement

The specifications for the measuring instrument using the CISPR quasi-peak detector can be found in Publication 16 of the International Special Committee on Radio Frequency Interference (CISPR) of the International Electrotechnical Commission.

As an alternative to CISPR quasi-peak measurement, compliance can be demonstrated to the applicable emission limits using a peak detector.

2. Peak Power Measurement Procedure

Utilize the peak power measurement procedure specified in Section 8.1.1 with the following modifications:

Set analyzer center frequency to the frequency associated with the restricted band emission under examination.

Set RBW = 1 MHz.

Note that if the peak measured value complies with the average limit, it is not necessary to perform a separate average measurement. If this option is exercised, it should be so noted in the test report.

3. Average Power Measurement Procedures

The average restricted band emission levels must be measured with the EUT transmitting continuously ($\geq 98\%$ duty cycle) at its maximum power control level. Optionally, video triggering/signal gating can be used to ensure that measurements are performed only when the EUT is transmitting at its maximum power control level.

The average power measurement procedures described in Section 8.2 shall be used with the following modifications:

Set analyzer center frequency to the frequency associated with the restricted band emission.

Set span to at least 1 MHz.

Use peak marker function to determine the highest amplitude within the RBW (1 MHz).

Test Mode:	Transmitting Mode
-------------------	--------------------------

(Below 1GHz)

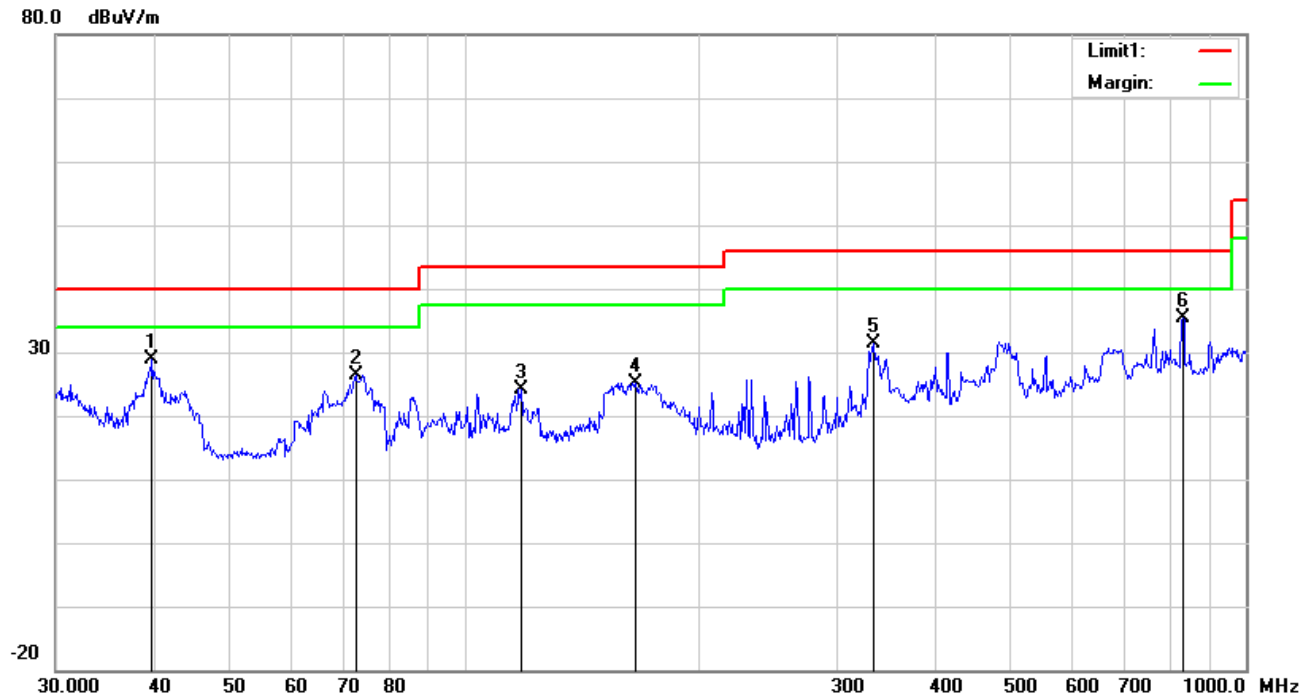

Test Data

Vertical Polarity Plot @3m

No	P/L	Frequency (MHz)	Reading (dBμV)	Detector	Corrected (dB)	Result (dBμV)	Limit (dBμV)	Margin (dB)	Height	Degree
1	V	39.8542	36.30	peak	14.01	22.28	0.79	28.82	40.00	-11.18
2	V	72.5917	39.98	peak	7.75	22.39	0.97	26.31	40.00	-13.69
3	V	118.1862	31.87	peak	13.58	22.36	1.16	24.25	43.50	-19.25
4	V	165.4867	33.95	peak	12.16	22.26	1.37	25.22	43.50	-18.28
5	V	333.6867	37.29	peak	14.31	22.20	1.96	31.36	46.00	-14.64
6	V	830.4002	31.89	peak	21.73	21.07	2.91	35.46	46.00	-10.54

(Below 1GHz)

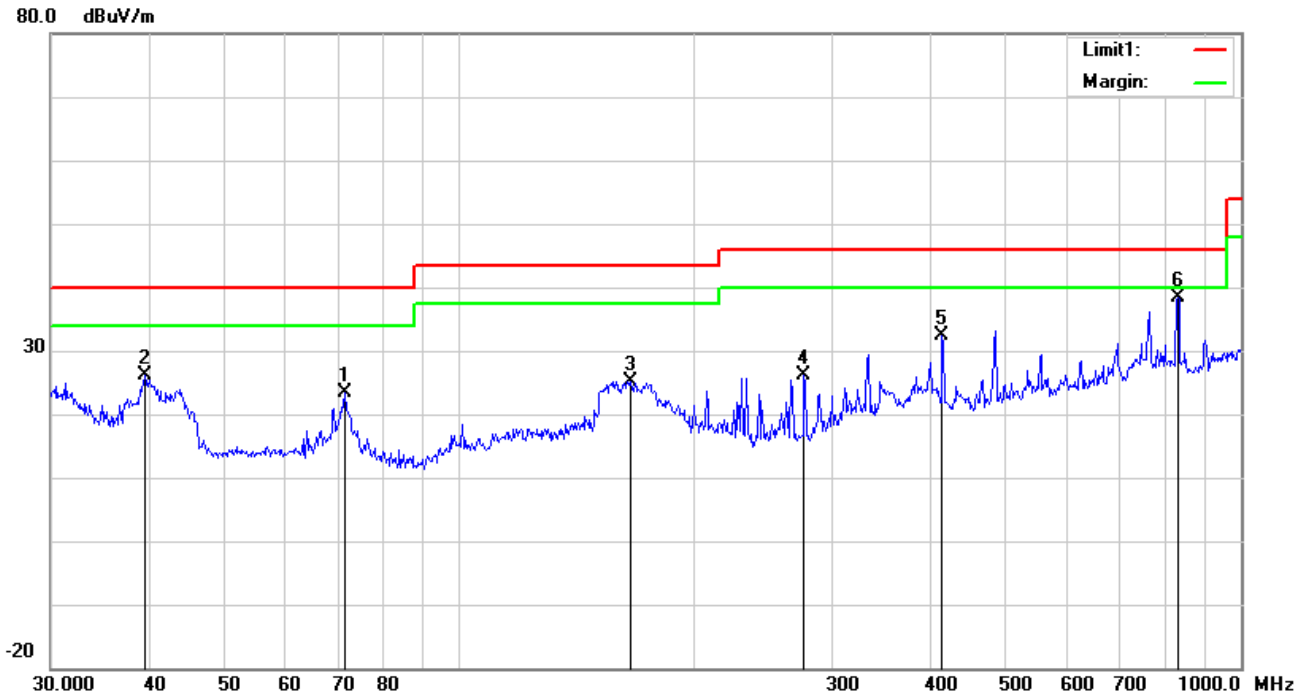

Test Data

Horizontal Polarity Plot @3m

No	P/L	Frequency (MHz)	Reading (dBμV)	Detector	Corrected (dB)	Result (dBμV)	Limit (dBμV)	Margin (dB)	Height	Degree
1	H	71.3300	37.01	peak	7.77	22.39	0.97	23.36	40.00	-16.64
2	H	39.5757	33.32	peak	14.21	22.28	0.79	26.04	40.00	-13.96
3	H	165.4867	33.95	peak	12.16	22.26	1.37	25.22	43.50	-18.28
4	H	276.1236	34.16	peak	12.55	22.29	1.75	26.17	46.00	-19.83
5	H	414.7223	36.29	peak	15.99	21.98	2.05	32.35	46.00	-13.65
6	H	830.4002	34.89	peak	21.73	21.07	2.91	38.46	46.00	-7.54

Above 1GHz

Test Mode:	Transmitting Mode
-------------------	--------------------------

Low Channel (5180 MHz) (802.11n20 mode worst case)

Frequency (MHz)	S.A. Reading (dB μ V)	Detector (PK/AV)	Polarity (H/V)	Ant. Factor (dB/m)	Cable Loss (dB)	Pre-Amp. Gain (dB)	Cord Amp. (dB μ V/m)	Limit (dB μ V/m)	Margin (dB)
10360	30.25	AV	V	39.61	9.75	46.86	32.75	54	-21.25
10360	28.76	AV	H	39.61	9.75	46.86	31.26	54	-22.74
10360	49.72	PK	V	39.61	9.75	46.86	52.22	74	-21.78
10360	45.37	PK	H	39.61	9.75	46.86	47.87	74	-26.13
4417	36.87	AV	V	32.4	6.69	48.97	26.99	54	-27.01
4417	34.92	AV	H	32.4	6.69	48.97	25.04	54	-28.96
4417	57.82	PK	V	32.4	6.69	48.97	47.94	74	-26.06
4417	53.81	PK	H	32.4	6.69	48.97	43.93	74	-30.07

Middle Channel (5200 MHz) (802.11n20 mode worst case)

Frequency (MHz)	S.A. Reading (dB μ V)	Detector (PK/AV)	Polarity (H/V)	Ant. Factor (dB/m)	Cable Loss (dB)	Pre-Amp. Gain (dB)	Cord Amp. (dB μ V/m)	Limit (dB μ V/m)	Margin (dB)
10440	34.16	AV	V	39.63	9.79	46.87	36.71	54	-17.29
10440	33.85	AV	H	39.63	9.79	46.87	36.4	54	-17.6
10440	45.29	PK	V	39.63	9.79	46.87	47.84	74	-26.16
10440	43.71	PK	H	39.63	9.79	46.87	46.26	74	-27.74
12467	26.52	AV	V	40.44	13.42	46.15	34.23	54	-19.77
12467	23.41	AV	H	40.44	13.42	46.15	31.12	54	-22.88
12467	46.85	PK	V	40.44	13.42	46.15	54.56	74	-19.44
12467	44.35	PK	H	40.44	13.42	46.15	52.06	74	-21.94

High Channel (5240 MHz) (802.11a mode worst case)

Frequency (MHz)	S.A. Reading (dBμV)	Detector (PK/AV)	Polarity (H/V)	Ant. Factor (dB/m)	Cable Loss (dB)	Pre-Amp. Gain (dB)	Cord Amp. (dBμV/m)	Limit (dBμV/m)	Margin (dB)
10480	35.26	AV	V	39.73	10.52	47.01	38.5	54	-15.5
10480	26.84	AV	H	39.73	10.52	47.01	30.08	54	-23.92
10480	47.62	PK	V	39.73	10.52	47.01	50.86	74	-23.14
10480	45.13	PK	H	39.73	10.52	47.01	48.37	74	-25.63
18245	21.35	AV	V	42.61	18.44	43.5	38.9	54	-15.1
18245	20.64	AV	H	42.61	18.44	43.5	38.19	54	-15.81
18245	42.06	PK	V	42.61	18.44	43.5	59.61	74	-14.39
18245	39.59	PK	H	42.61	18.44	43.5	57.14	74	-16.86

Note:

- 1, The testing has been conformed to 40GHz;
- 2, All other emissions more than 30 dB below the limit
- 3, X-Axis, Y-Axis and Z-Axis were investigated. The results above show only the worst case.
- 4, The radiated spurious test above 18GHz is subcontracted to "BV 7LAYERS COMMUNICATION TECHNOLOGY(SHENZHEN)CO.,LTD" Laboratories. and found 30dB below the limit at least.

Annex A. TEST INSTRUMENT

Annex A.i. TEST INSTRUMENTATION & GENERAL PROCEDURES

Instrument	Model	Serial #	Cal Date	Cal Due	In use
RF conducted test					
Agilent ESA-E SERIES	E4407B	MY45108319	09/16/2016	09/15/2017	<input checked="" type="checkbox"/>
Power Splitter	1#	1#	08/30/2017	08/29/2018	<input checked="" type="checkbox"/>
DC Power Supply	E3640A	MY40004013	09/16/2016	09/15/2017	<input checked="" type="checkbox"/>
Radiated Emissions					
EMI test receiver	ESL6	100262	09/16/2016	09/15/2017	<input checked="" type="checkbox"/>
Positioning Controller	UC3000	MF780208282	11/18/2016	11/17/2017	<input checked="" type="checkbox"/>
OPT 010 AMPLIFIER (0.1-1300MHz)	8447E	2727A02430	08/30/2017	08/29/2018	<input checked="" type="checkbox"/>
Microwave Preamplifier (1 ~ 26.5GHz)	8449B	3008A02402	03/23/2017	03/22/2018	<input checked="" type="checkbox"/>
Bilog Antenna (30MHz~6GHz)	JB6	A110712	09/20/2016	09/19/2017	<input checked="" type="checkbox"/>
Double Ridge Horn Antenna (1 ~18GHz)	AH-118	71283	09/23/2016	09/22/2017	<input checked="" type="checkbox"/>
Universal Radio Communication Tester	CMU200	121393	09/24/2016	09/23/2017	<input checked="" type="checkbox"/>

Equipment	Manufacturer	Model No.	Serial No.	Last Cal.	Next Cal.
3m Semi-anechoic Chamber	ETS-LINDGREN	9m*6m*6m	Euroshieldpn-CT0001143-1216	May 06,17	May 05,18
Horn Antenna (18GHz-40GHz)	N/A	QWH-SL-18-40-K-SG/QMS-00361	15433	Dec. 16,16	Dec. 15,17
Test Software	ADT	ADT_Radiated_V7.6.15.9.2	N/A	N/A	N/A
10dB Attenuator	JFW/USA	50HF-010-SMA	1505	Jul. 24,17	Jul. 23,18
MXE EMI Receiver	KEYSIGHT	N9038A-544	MY54450026	Mar. 10,17	Mar. 09,18
Signal Pre-Amplifier	EMSI	EMC 184045B	980259	Jul. 24,17	Jul. 23,18

Annex A.ii. CONDUCTED EMISSIONS TEST DESCRIPTION

Test Set-up

1. The EUT and supporting equipment were set up in accordance with the requirements of the standard on top of a 1.5m x 1m x 0.8m high, non-metallic table, as shown in Annex B.
2. The power supply for the EUT was fed through a 50 Ω /50 μ H EUT LISN, connected to filtered mains.
3. The RF OUT of the EUT LISN was connected to the EMI test receiver via a low-loss coaxial cable.
4. All other supporting equipments were powered separately from another main supply.

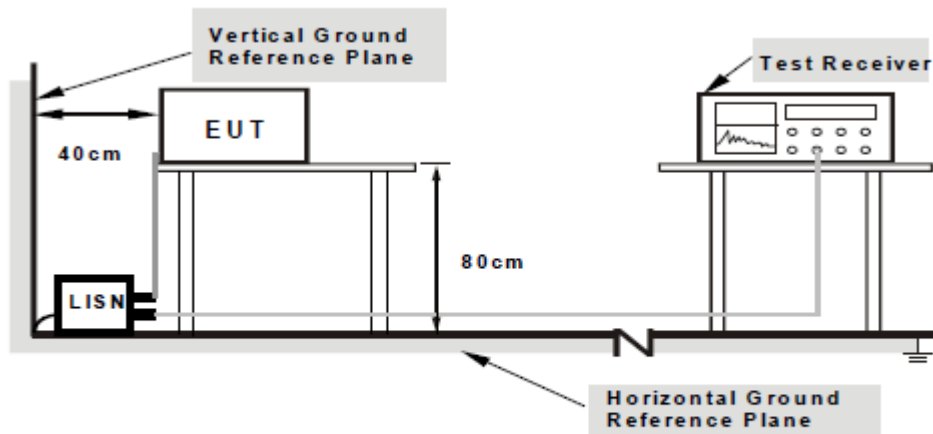

**Note: 1. Support units were connected to second LISN.
2. Both of LISNs (AMN) are 80cm from EUT and at least 80cm from other units and other metal planes support units.**

For the actual test configuration, please refer to the related item – Photographs of the Test Configuration1.

Test Method

1. The EUT was switched on and allowed to warm up to its normal operating condition.
2. A scan was made on the NEUTRAL line (for AC mains) or Earth line (for DC power) over the required frequency range using an EMI test receiver.

3. High peaks, relative to the limit line, were then selected.
4. The EMI test receiver was then tuned to the selected frequencies and the necessary measurements made with a receiver bandwidth setting of 10 kHz. For FCC tests, only Quasi-peak measurements were made; while for CISPR/EN tests, both Quasi-peak and Average measurements were made.
5. Steps 2 to 4 were then repeated for the LIVE line (for AC mains) or DC line (for DC power).

Description of Conducted Emission Program

This EMC Measurement software run LabView automation software and offers a common user interface for electromagnetic interference (EMI) measurements. This software is a modern and powerful tool for controlling and monitoring EMI test receivers and EMC test systems. It guarantees reliable collection, evaluation, and documentation of measurement results. Basically, this program will run a pre-scan measurement before it proceeds with the final measurement. The pre-scan routine will run the common scan range from 150 kHz to 30 MHz; the program will first start a peak and average scan on selectable measurement time and step size. After the program complete the pre-scan, this program will perform the Quasi Peak and Average measurement, based on the pre-scan peak data reduction result.

Sample Calculation Example

At 20 MHz limit = 250 μ V = 47.96
dB μ V

Transducer factor of LISN, pulse limiter & cable loss at 20 MHz = 11.20 dB

Q-P reading obtained directly from EMI Receiver = 40.00 dB μ V
(Calibrated for system losses)

Therefore, Q-P margin = 47.96 – 40.00 = 7.96 i.e. **7.96 dB below**
limit

Annex A. iii RADIATED EMISSIONS TEST DESCRIPTION

EUT Characterisation

EUT characterisation, over the frequency range from 30MHz to 10th Harmonic , was done in order to minimise radiated emissions testing time while still maintaining high confidence in the test results.

The EUT was placed in the chamber, at a height of about 0.8m on a turntable. Its radiated emissions frequency profile was observed, using a spectrum analyzer /receiver with the appropriate broadband antenna placed 3m away from the EUT. Radiated emissions from the EUT were maximised by rotating the turntable manually, changing the antenna polarisation and manipulating the EUT cables while observing the frequency profile on the spectrum analyzer / receiver. Frequency points at which maximum emissions occurred, clock frequencies and operating frequencies were then noted for the formal radiated emissions test at the Open Area Test Site (OATS).

Test Set-up

1. The EUT and supporting equipment were set up in accordance with the requirements of the standard on top of a 1.5m X 1.0m X 0.8m high, non-metallic table.
2. The filtered power supply for the EUT and supporting equipment were tapped from the appropriate power sockets located on the turntable.
3. The relevant broadband antenna was set at the required test distance away from the EUT and supporting equipment boundary.

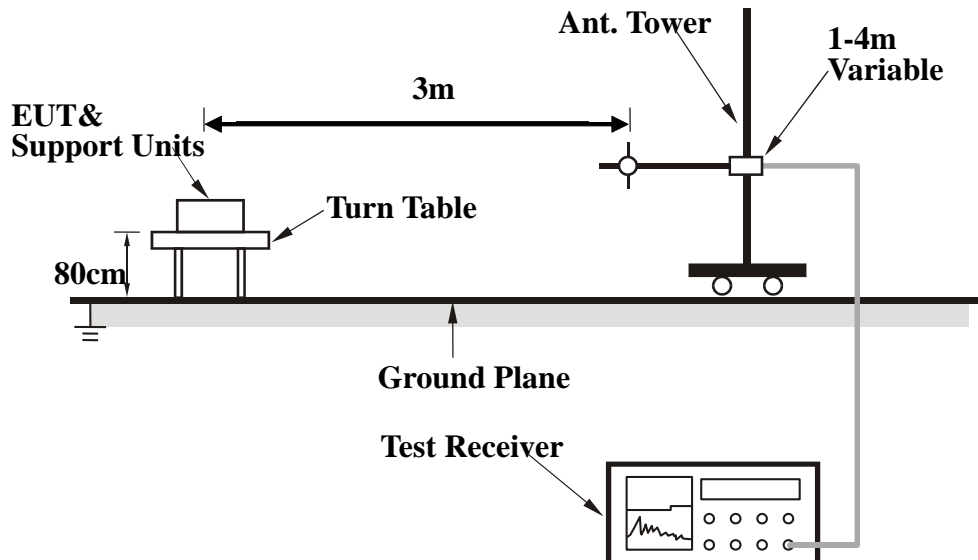

Test Method

The following procedure was performed to determine the maximum emission axis of EUT:

1. With the receiving antenna is H polarization, rotate the EUT in turns with three orthogonal axes to determine the axis of maximum emission.
2. With the receiving antenna is V polarization, rotate the EUT in turns with three orthogonal axes to determine the axis of maximum emission.
3. Compare the results derived from above two steps. So, the axis of maximum emission from EUT was determined and the configuration was used to perform the final measurement.

Final Radiated Emission Measurement

1. Setup the configuration according to figure 1. Turn on EUT and make sure that it is in normal function.
2. For emission frequencies measured below 1 GHz, a pre-scan is performed in a shielded chamber to determine the accurate frequencies of higher emissions will be checked on a open test site. As the same purpose, for emission frequencies measured above 1 GHz, a pre-scan also be performed with a 1 meter measuring distance before final test.
3. For emission frequencies measured below and above 1 GHz, set the spectrum analyzer on a 100 kHz and 1 MHz resolution bandwidth respectively for each frequency measured in step 2.
4. The search antenna is to be raised and lowered over a range from 1 to 4 meters in horizontally polarized orientation. Position the highness when the highest value is indicated on spectrum analyzer, then change the orientation of EUT on test table over a range from 0. to 360. with a speed as slow as possible, and keep the azimuth that highest emission is indicated on the spectrum analyzer. Vary the antenna position again and record the highest value as a final reading.
5. Repeat step 4 until all frequencies need to be measured was complete.
6. Repeat step 5 with search antenna in vertical polarized orientations.

During the radiated emission test, the Spectrum Analyzer was set with the following configurations:

Frequency Band (MHz)	Function	Resolution bandwidth	Video Bandwidth
30 to 1000	Peak	100 kHz	100 kHz

Above 1000	Peak	1 MHz	1 MHz
	Average	1 MHz	10 Hz

Sample Calculation Example

The field strength is calculated by adding the Antenna Factor and Cable Factor, and subtracting the Amplifier Gain (if any) from the measured reading. For the limit is employed average value, therefore the peak value can be transferred to average value by subtracting the duty factor. The basic equation with a sample calculation is as follows:

$$\text{Peak} = \text{Reading} + \text{Corrected Factor}$$

where

$$\text{Corr. Factor} = \text{Antenna Factor} + \text{Cable Factor} - \text{Amplifier Gain (if any)}$$

And the average value is

$$\text{Average} = \text{Peak Value} + \text{Duty Factor or}$$

$$\text{Set RBW} = 1\text{MHz}, \text{VBW} = 10\text{Hz}.$$

Note :

If the measured frequencies are fall in the restricted frequency band, the limit employed must be quasi peak value when frequencies are below or equal to 1 GHz. And the measuring instrument is set to quasi peak detector function.

Annex C. TEST SETUP AND SUPPORTING EQUIPMENT

Test Setup Photo



Radiated Spurious Emissions Test Setup Above 1GHz

Annex C. i. SUPPORTING EQUIPMENT DESCRIPTION

The following is a description of supporting equipment and details of cables used with the EUT.

Supporting Equipment:

Manufacturer	Equipment Description	Model	Serial No
TECNO MOBILE LIMITED	Adapter	CQ-18KX	N/A
TECNO MOBILE LIMITED	Earphone	AX8	N/A

Block Configuration Diagram for AC Line Conducted Emissions

N/A

Block Configuration Diagram for Radiated Emissions (Below 1GHz) .

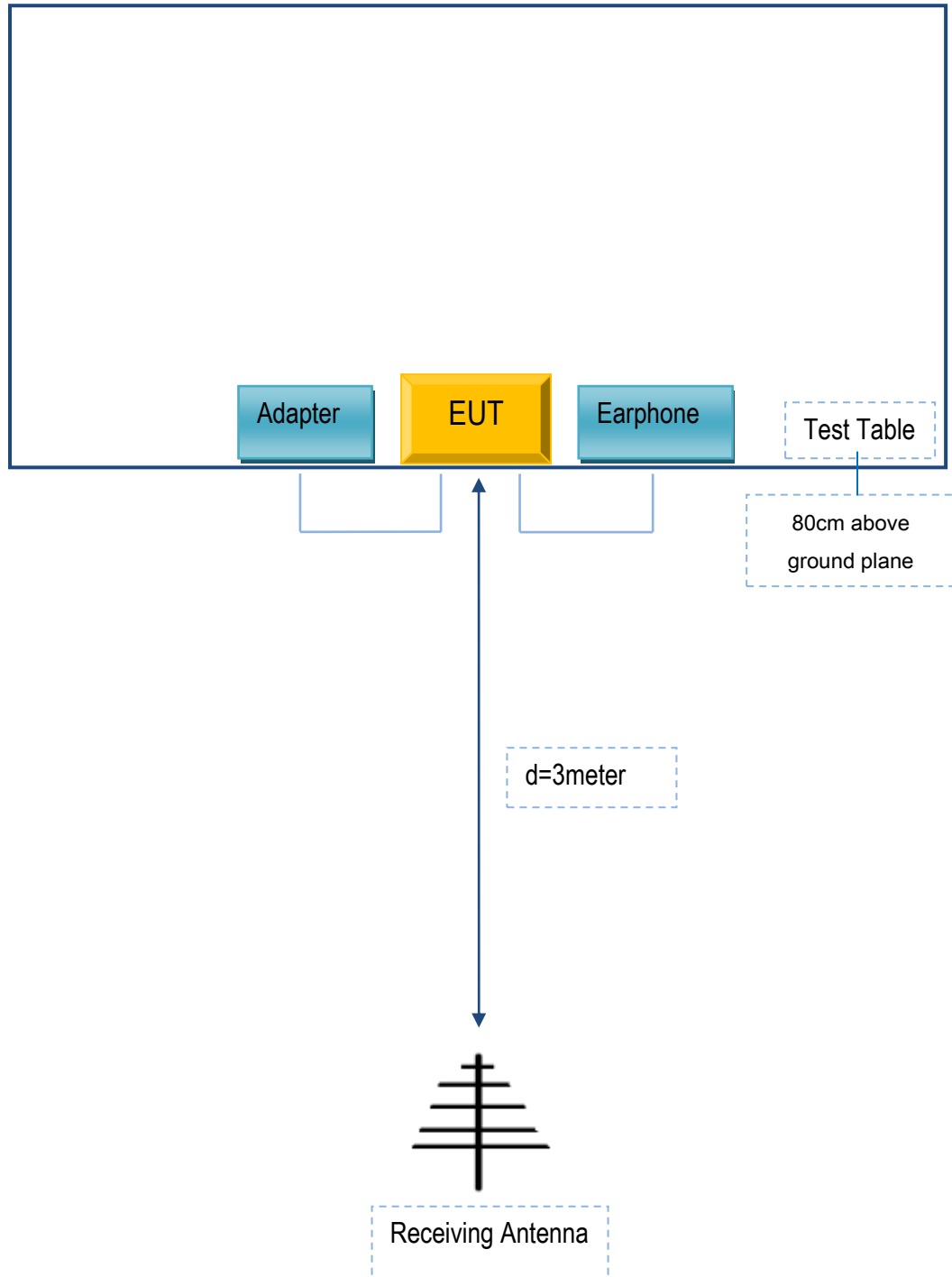

Block Configuration Diagram for Radiated Emissions (Above 1GHz) .

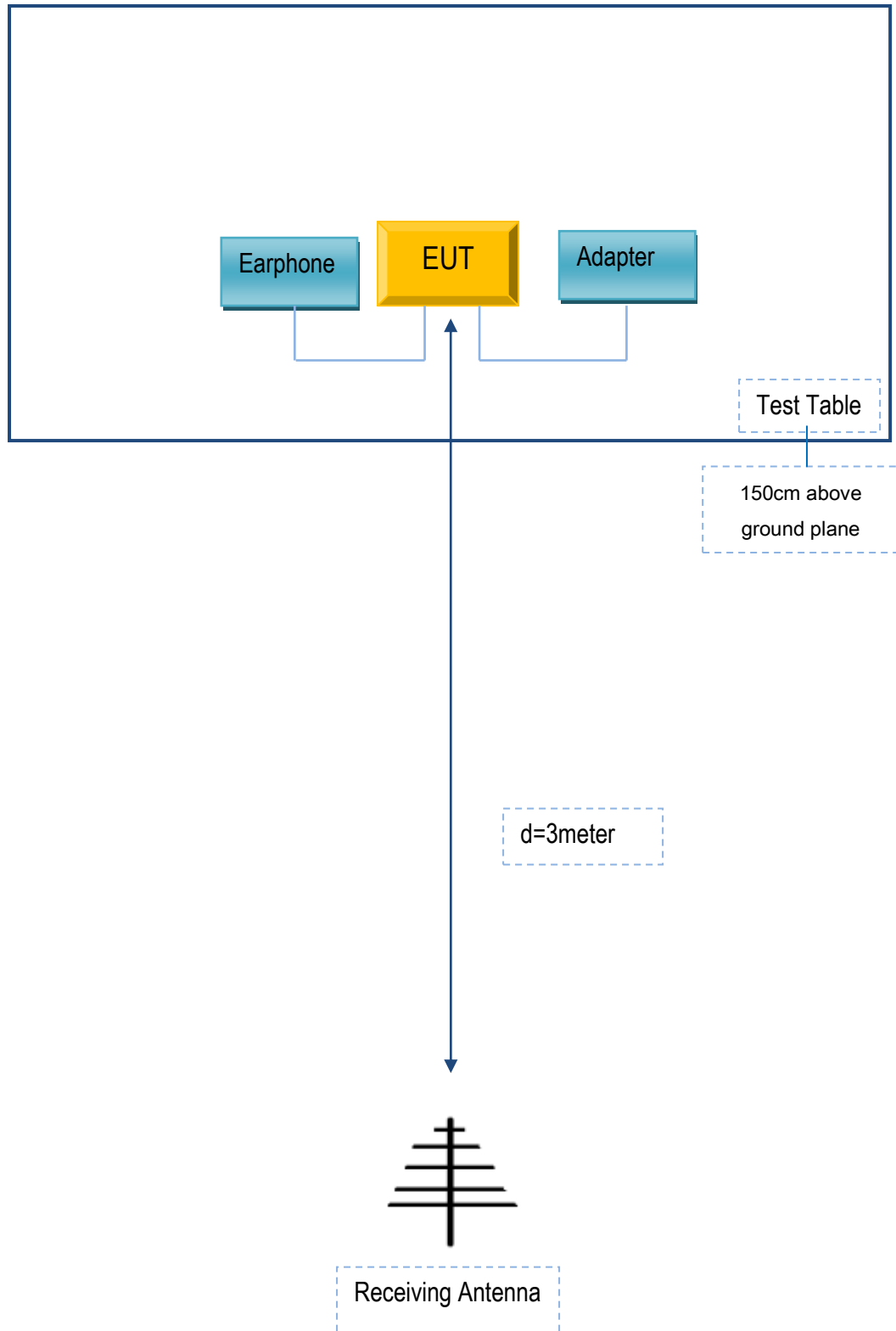

Annex C.ii. EUT OPERATING CONDITIONS

The following is the description of how the EUT is exercised during testing.

Test	Description Of Operation
Emissions Testing	The EUT was continuously transmitting to stimulate the worst case.

Test Report No.	17070659-FCC-R6
Page	73 of 74

Annex D. User Manual / Block Diagram / Schematics / Partlist

See attachment

Test Report No.	17070659-FCC-R6
Page	74 of 74

Annex E. DECLARATION OF SIMILARITY

N/A