

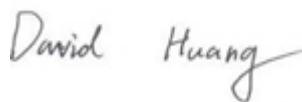

RF TEST REPORT



Report No.: 17070659-FCC-R2

Supersede Report No.: N/A

Applicant	TECNO MOBILE LIMITED	
Product Name	Mobile phone	
Model No.	AX8	
Serial No.	N/A	
Test Standard	FCC Part 15.247: 2016, ANSI C63.10: 2013	
Test Date	July 29 to September 14, 2017	
Issue Date	September 15, 2017	
Test Result	<input checked="" type="checkbox"/> Pass <input type="checkbox"/> Fail	
Equipment complied with the specification	<input checked="" type="checkbox"/>	
Equipment did not comply with the specification	<input type="checkbox"/>	
		
Loren Luo Test Engineer	David Huang Checked By	
This test report may be reproduced in full only Test result presented in this test report is applicable to the tested sample only		

Issued by:

SIEMIC (SHENZHEN-CHINA) LABORATORIES

Zone A, Floor 1, Building 2 Wan Ye Long Technology Park

South Side of Zhoushi Road, Bao' an District, Shenzhen, Guangdong China 518108

Phone: +86 0755 2601 4629801 Email: China@siemic.com.cn

Laboratories Introduction

SIEMIC, headquartered in the heart of Silicon Valley, with superior facilities in US and Asia, is one of the leading independent testing and certification facilities providing customers with one-stop shop services for Compliance Testing and Global Certifications.



In addition to testing and certification, SIEMIC provides initial design reviews and compliance management throughout a project. Our extensive experience with China, Asia Pacific, North America, European, and International compliance requirements, assures the fastest, most cost effective way to attain regulatory compliance for the global markets.

Accreditations for Conformity Assessment

Country/Region	Scope
USA	EMC, RF/Wireless, SAR, Telecom
Canada	EMC, RF/Wireless, SAR, Telecom
Taiwan	EMC, RF, Telecom, SAR, Safety
Hong Kong	RF/Wireless, SAR, Telecom
Australia	EMC, RF, Telecom, SAR, Safety
Korea	EMI, EMS, RF, SAR, Telecom, Safety
Japan	EMI, RF/Wireless, SAR, Telecom
Singapore	EMC, RF, SAR, Telecom
Europe	EMC, RF, SAR, Telecom, Safety

Test Report No.	17070659-FCC-R2
Page	3 of 64

This page has been left blank intentionally.

CONTENTS

1. REPORT REVISION HISTORY	5
2. CUSTOMER INFORMATION	5
3. TEST SITE INFORMATION	5
4. EQUIPMENT UNDER TEST (EUT) INFORMATION	6
5. TEST SUMMARY	9
6. MEASUREMENTS, EXAMINATION AND DERIVED RESULTS	10
6.1 ANTENNA REQUIREMENT	10
6.2 DTS (6 DB&20 DB) CHANNEL BANDWIDTH.....	11
6.3 MAXIMUM OUTPUT POWER	18
6.4 POWER SPECTRAL DENSITY.....	22
6.5 BAND-EDGE & UNWANTED EMISSIONS INTO RESTRICTED FREQUENCY BANDS	26
6.6 AC POWER LINE CONDUCTED EMISSIONS.....	32
6.7 RADIATED SPURIOUS EMISSIONS & RESTRICTED BAND	38
ANNEX A. TEST INSTRUMENT.....	46
ANNEX B. EUT AND TEST SETUP PHOTOGRAPHS.....	47
ANNEX C. TEST SETUP AND SUPPORTING EQUIPMENT.....	59
ANNEX D. USER MANUAL / BLOCK DIAGRAM / SCHEMATICS / PARTLIST	63
ANNEX E. DECLARATION OF SIMILARITY.....	64

1. Report Revision History

Report No.	Report Version	Description	Issue Date
17070659-FCC-R2	NONE	Original	September 15, 2017

2. Customer information

Applicant Name	TECNO MOBILE LIMITED
Applicant Add	ROOMS 05-15, 13A/F., SOUTH TOWER, WORLD FINANCE CENTRE, HARBOUR CITY, 17 CANTON ROAD, TSIM SHA TSUI, KOWLOON, HONG KONG
Manufacturer	SHENZHEN TECNO TECHNOLOGY CO.,LTD.
Manufacturer Add	1-4th Floor,3rd Building,Pacific Industrial Park,No.2088,Shenyan Road,Yantian District,Shenzhen,Guangdong,China

3. Test site information

Test Lab A:

Lab performing tests	SIEMIC (Shenzhen-China) LABORATORIES
Lab Address	Zone A, Floor 1, Building 2 Wan Ye Long Technology Park South Side of Zhoushi Road, Bao' an District, Shenzhen, Guangdong China 518108
FCC Test Site No.	535293
IC Test Site No.	4842E-1
Test Software	Radiated Emission Program-To Shenzhen v2.0

Test Lab B:

Lab performing tests	SIEMIC (Nanjing-China) Laboratories
Lab Address	2-1 Longcang Avenue Yuhua Economic and Technology Development Park, Nanjing, China
FCC Test Site No.	694825
IC Test Site No.	4842B-1
Test Software	EZ_EMG(ver.lcp-03A1)

Note: We just perform Radiated Spurious Emission above 18GHz in the test Lab. B.

4. Equipment under Test (EUT) Information

Description of EUT:	Mobile phone
Main Model:	AX8
Serial Model:	N/A
Date EUT received:	July 28, 2017
Test Date(s):	July 29 to September 14, 2017
Equipment Category :	DTS
Antenna Gain:	GSM850: -2.53dBi PCS1900: -1.31dBi UMTS-FDD Band V: -2dBi UMTS-FDD Band II: -1.74dBi LTE Band II: -1.31dBi LTE Band IV: -2.64dBi LTE Band V: -2.14dBi LTE Band VII: -0.27dBi WIFI(2.4G): -0.87 dBi WIFI(5150-5250MHz): -5.3 dBi WIFI(5250-5350MHz): -5.3 dBi WIFI(5725-5850MHz): -5.3 dBi Bluetooth/BLE: -0.87dBi GPS: -1.47dBi
Antenna Type:	IFA antenna
Type of Modulation:	GSM / GPRS: GMSK EGPRS: GMSK,8PSK UMTS-FDD: QPSK LTE Band: QPSK, 16QAM 802.11b/g/n: DSSS, OFDM Bluetooth: GFSK, π /4DQPSK, 8DPSK BLE: GFSK GPS:BPSK

	GSM850 TX: 824.2 ~ 848.8 MHz; RX: 869.2 ~ 893.8 MHz
	PCS1900 TX: 1850.2 ~ 1909.8 MHz; RX: 1930.2 ~ 1989.8 MHz
	UMTS-FDD Band V TX: 826.4 ~ 846.6 MHz; RX: 871.4 ~ 891.6 MHz
	UMTS-FDD Band II TX:1852.4 ~ 1907.6 MHz;
	RX: 1932.4 ~ 1987.6 MHz
	LTE Band II TX: 1850.7 ~ 1909.3MHz; RX : 1930.7 ~ 1989.3 MHz
	LTE Band IV TX: 1710.7 ~ 1754.3 MHz; RX : 2110.7~ 2154.3 MHz
	LTE Band V TX: 824.7~ 848.3 MHz; RX : 869.7 ~ 893.3MHz
RF Operating Frequency (ies):	LTE Band VII TX: 2502.5 ~ 2567.5 MHz; RX : 2622.5 ~ 2687.5 MHz
	802.11b/g: 2412-2462 MHz (TX/RX)
	802.11n20: 2412-2462MHz ; 5180-5240 MHz; 5260-5320 MHz; 5745-5825 MHz; (TX/RX)
	802.11n40: 2422-2452 MHz (TX/RX); 5190-5230 MHz; 5270-5310 MHz; 5755-5795 MHz; (TX/RX)
	802.11 a: 5180-5240 MHz; 5260-5320 MHz; 5745-5825 MHz (TX/RX)
	Bluetooth& BLE: 2402-2480 MHz
	GPS: 1575.42 MHz
Max. Output Power:	802.11b: 12.10dBm
	802.11g: 11.11dBm
	802.11n(20M): 10.97dBm
	802.11n(40M):10.83dBm
Number of Channels:	GSM 850: 124CH
	PCS1900: 299CH
	UMTS-FDD Band V : 102CH
	UMTS-FDD Band II : 277CH
	WIFI :802.11b/g: 11CH
	WIFI :802.11a: 24CH
	WIFI :802.11n20: 11CH(2.4GHz); 24CH(5GHz)
	WIFI :802.11n40: 7CH(2.4GHz); 12CH(5GHz)
	Bluetooth: 79CH
	BLE: 40CH
	GPS:1CH
Port:	USB Port, Earphone Port

Test Report No.	17070659-FCC-R2
Page	8 of 64

Adapter:

Model: CQ-18KX

Input: AC100-240V~50/60Hz,400mA

Output: DC 5V-9V,2A

DC9V-12V,1.5A

Input Power:

Battery:

Model: BL-35AT

Rating: 3.85V, 3500mAh/3600mAh(min/typ)

13.47Wh/13.86Wh(min/typ)

Limited charge voltage: 4.4V

Trade Name :

TECNO

FCC ID:

2ADYY-AX8

5. Test Summary

The product was tested in accordance with the following specifications.

All testing has been performed according to below product classification:

FCC Rules	Description of Test	Result
§15.203	Antenna Requirement	Compliance
§15.247 (a)(2)	DTS (6 dB&20 dB) CHANNEL BANDWIDTH	Compliance
§15.247(b)(3)	Conducted Maximum Output Power	Compliance
§15.247(e)	Power Spectral Density	Compliance
§15.247(d)	Band-Edge & Unwanted Emissions into Restricted Frequency Bands	Compliance
§15.207 (a),	AC Power Line Conducted Emissions	Compliance
§15.205, §15.209, §15.247(d)	Radiated Emissions & Unwanted Emissions into Restricted Frequency Bands	Compliance

Measurement Uncertainty

Emissions		
Test Item	Description	Uncertainty
Band-Edge & Unwanted Emissions into Restricted Frequency Bands and Radiated Emissions & Unwanted Emissions into Restricted Frequency Bands	Confidence level of approximately 95% (in the case where distributions are normal), with a coverage factor of 2 (for EUTs < 0.5m X 0.5m X 0.5m)	+5.6dB/-4.5dB
-	-	-

6. Measurements, Examination And Derived Results

6.1 Antenna Requirement

Applicable Standard

According to § 15.203, an intentional radiator shall be designed to ensure that no antenna other than that furnished by the responsible party shall be used with the device. The use of a permanently attached antenna or of an antenna that uses a unique coupling to the intentional radiator shall be considered sufficient to comply with the provisions of this section. The manufacturer may design the unit so that a broken antenna can be replaced by the user, but the user of a standard antenna jack or electrical connector is prohibited. The structure and application of the EUT were analyzed to determine compliance with section §15.203 of the rules. §15.203 state that the subject device must meet the following criteria:

- a. Antenna must be permanently attached to the unit.
- b. Antenna must use a unique type of connector to attach to the EUT.

Unit must be professionally installed, and installer shall be responsible for verifying that the correct antenna is employed with the unit.

And according to FCC 47 CFR section 15.247 (b), if the transmitting antennas of directional gain greater than 6dBi are used, the power shall be reduced by the amount in dB that the directional gain of the antenna exceeds 6 dBi.

Antenna Connector Construction

The EUT has 3 antennas:

A permanently attached IFA antenna for Bluetooth/BLE/2.4G WIFI/5G WIFI/GPS, the gain is -0.87dBi for Bluetooth/BLE, the gain is -0.87dBi for 2.4G WIFI, the gain is -5.3dBi for 5150-5250MHz/5250-5350MHz/5725-2850MHz MHz 5G WIFI, the gain is -1.47dBi for GPS.

A permanently attached IFA antenna for GSM/PCS/UMTS, the gain is -2.53dBi for GSM850, -1.31dBi for PCS1900, -2dBi for UMTS-FDD Band V, -1.74dBi for UMTS-FDD Band II.

A permanently attached IFA antenna for LTE Band II/IV/V/VII, the gain is -1.31dBi for LTE Band II, the gain is -2.64dBi for LTE Band IV, the gain is -2.14dBi for LTE Band V, the gain is -0.27dBi for LTE Band VII.

The antenna meets up with the ANTENNA REQUIREMENT.

Result: Compliance.

6.2 DTS (6 dB&20 dB) Channel Bandwidth

Temperature	25°C
Relative Humidity	53%
Atmospheric Pressure	1010mbar
Test date :	September 12, 2017
Tested By :	Loren Luo

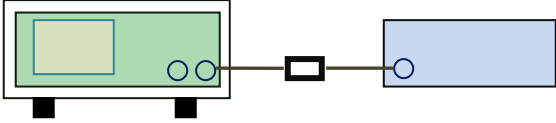
Spec	Item	Requirement	Applicable
§ 15.247(a)(2)	a)	6dB BW \geq 500kHz;	<input checked="" type="checkbox"/>
RSS Gen(4.6.1)	b)	99% BW: For FCC reference only; required by IC.	<input checked="" type="checkbox"/>
Test Setup	 <p style="text-align: center;">Spectrum Analyzer EUT</p>		
Test Procedure	<p>558074 D01 DTS MEAS Guidance v03r03, 8.1 DTS bandwidth</p> <p><u>6dB bandwidth</u></p> <ol style="list-style-type: none"> a) Set RBW = 100 kHz. b) Set the video bandwidth (VBW) \geq 3 \times RBW. c) Detector = Peak. d) Trace mode = max hold. e) Sweep = auto couple. f) Allow the trace to stabilize. g) Measure the maximum width of the emission that is constrained by the frequencies associated with the two outermost amplitude points (upper and lower frequencies) that are attenuated by 6 dB relative to the maximum level measured in the fundamental emission. <p><u>20dB bandwidth</u></p> <p>C63.10 Occupied Bandwidth (OBW=20dB bandwidth)</p> <ol style="list-style-type: none"> 1. Set RBW = 1%-5% OBW. 2. Set the video bandwidth (VBW) \geq 3 x RBW. 3. Set the span range between 2 times and 5 times of the OBW. 4. Sweep time=Auto, Detector=PK, Trace=Max hold. 5. Once the reference level is established, the equipment is conditioned with typical modulating signals to produce the worst- 		

	case (i.e., the widest) bandwidth. Unless otherwise specified for an unlicensed wireless device, measure the bandwidth at the 20 dB levels with respect to the reference level.
Remark	
Result	<input checked="" type="checkbox"/> Pass <input type="checkbox"/> Fail

Test Data Yes N/A

Test Plot Yes (See below) N/A

Measurement result

Test mode	CH	Freq (MHz)	6dB Bandwidth (MHz)	Limit (MHz)
802.11b	Low	2412	9.097	≥ 0.5
	Mid	2437	9.546	≥ 0.5
	High	2462	10.024	≥ 0.5
802.11g	Low	2412	15.125	≥ 0.5
	Mid	2437	15.476	≥ 0.5
	High	2462	15.658	≥ 0.5
802.11n (20M)	Low	2412	15.119	≥ 0.5
	Mid	2437	15.262	≥ 0.5
	High	2462	16.080	≥ 0.5
802.11n (40M)	Low	2422	36.824	≥ 0.5
	Mid	2437	35.332	≥ 0.5
	High	2452	35.468	≥ 0.5

Test mode	CH	Freq (MHz)	20dB Bandwidth (MHz)
802.11b	Low	2412	14.216
	Mid	2437	14.367
	High	2462	14.780
802.11g	Low	2412	18.374
	Mid	2437	18.754
	High	2462	19.122
802.11n (20M)	Low	2412	19.058
	Mid	2437	19.405
	High	2462	19.364
802.11n (40M)	Low	2422	39.433
	Mid	2437	39.454
	High	2452	39.809

Test Plots

6dB Bandwidth measurement result

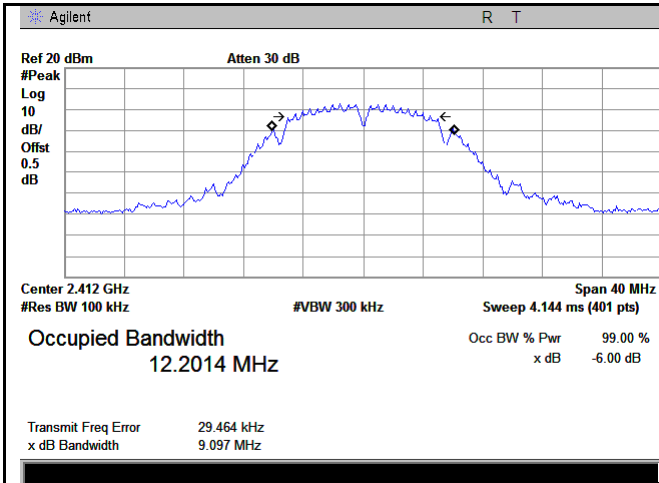

802.11b 6dB Bandwidth - Low CH 2412

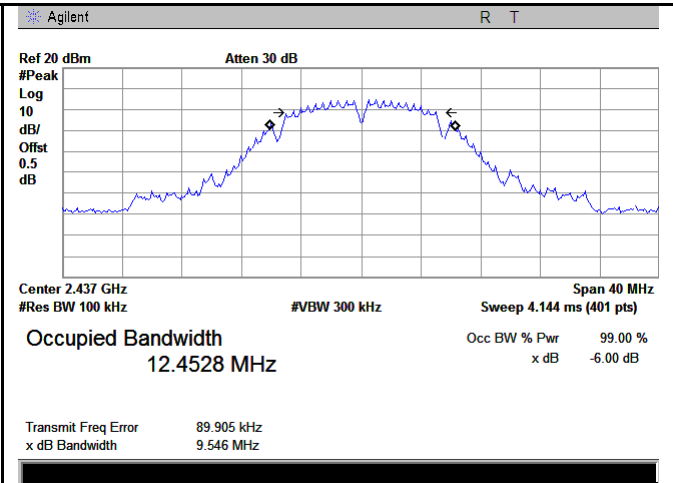

802.11b 6dB Bandwidth - Mid CH 2437

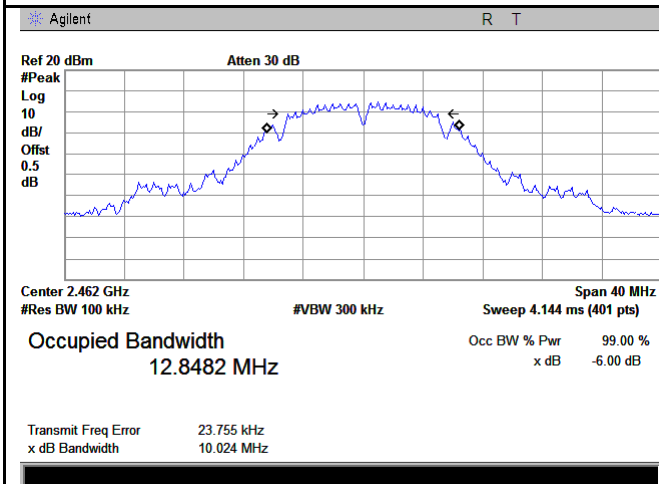

802.11b 6dB Bandwidth - High CH 2462

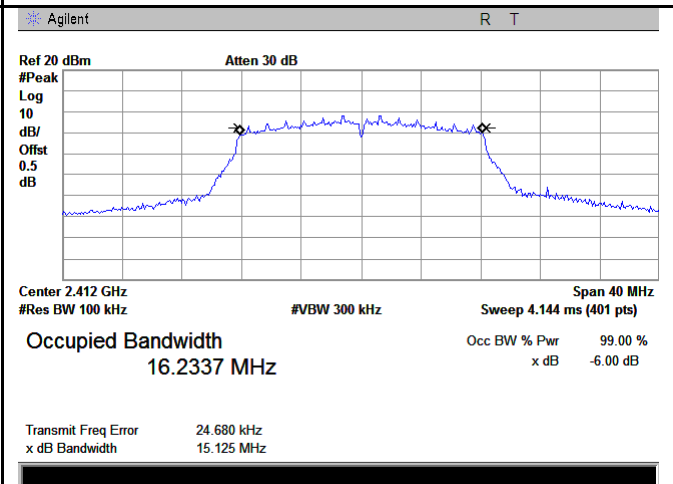

802.11g 6dB Bandwidth - Low CH 2412

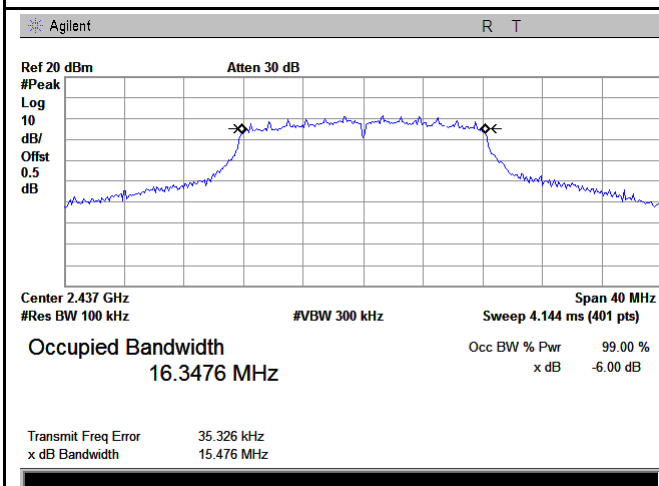

802.11g 6dB Bandwidth - Mid CH 2437

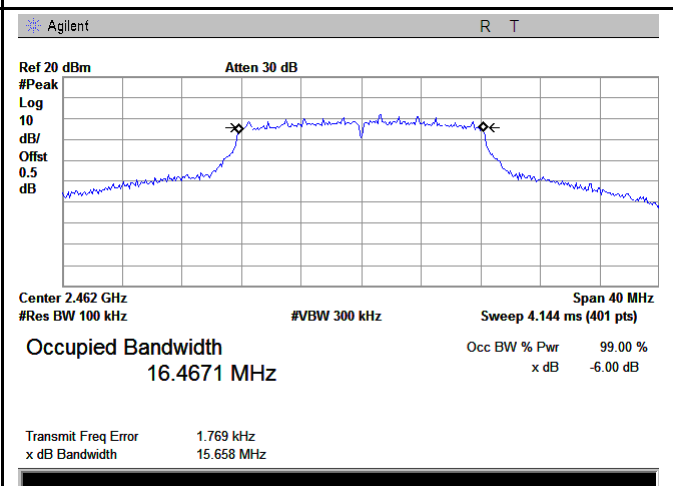

802.11g 6dB Bandwidth - High CH 2462

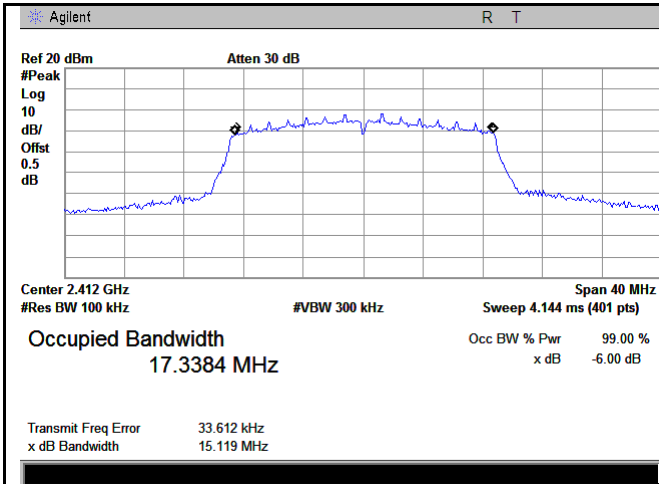

802.11n20 6dB Bandwidth - Low CH 2412

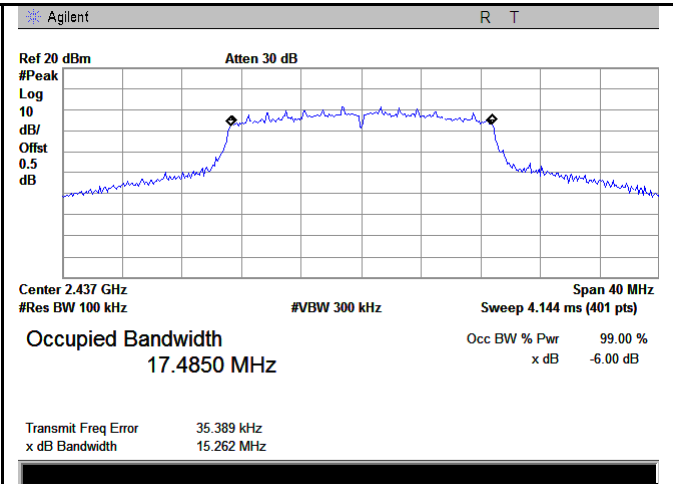

802.11n20 6dB Bandwidth - Mid CH 2437

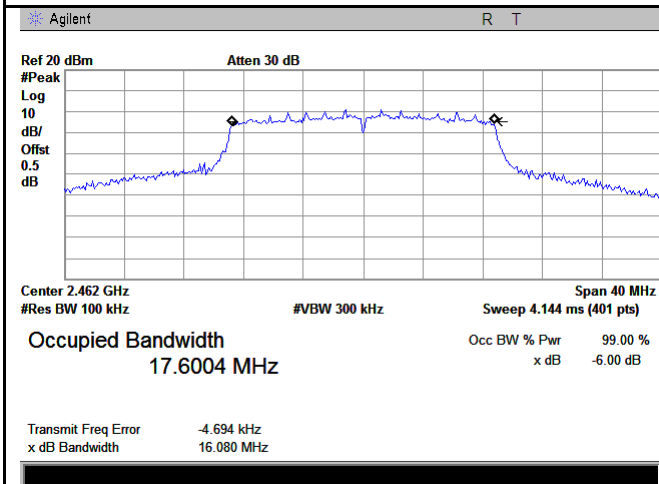

802.11n20 6dB Bandwidth - High CH 2462

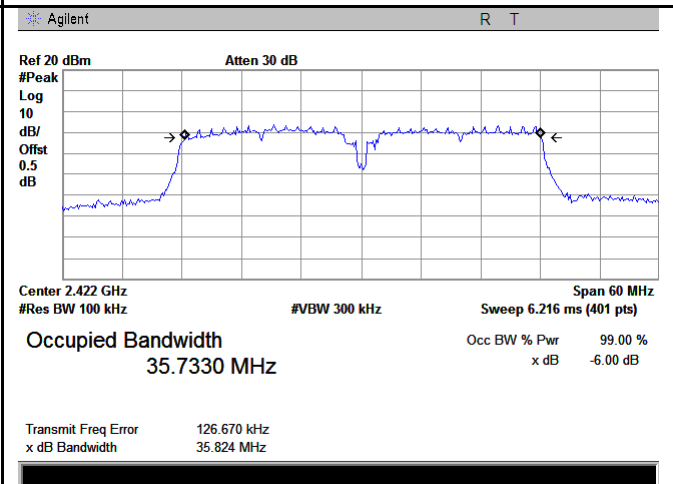

802.11n40 6dB Bandwidth - Low CH 2422

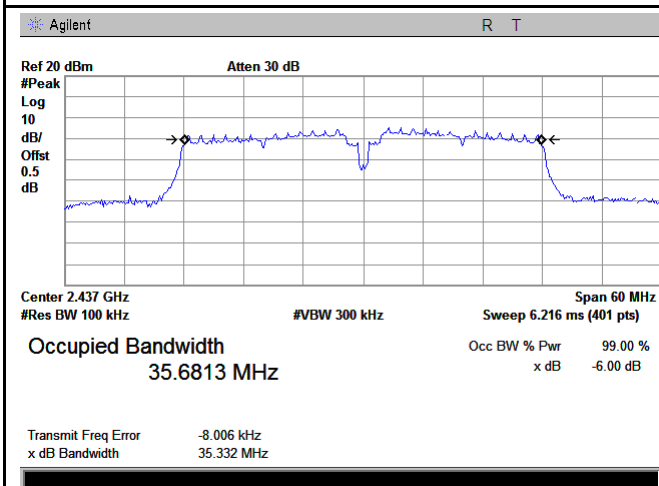

802.11n40 6dB Bandwidth - Mid CH 2437

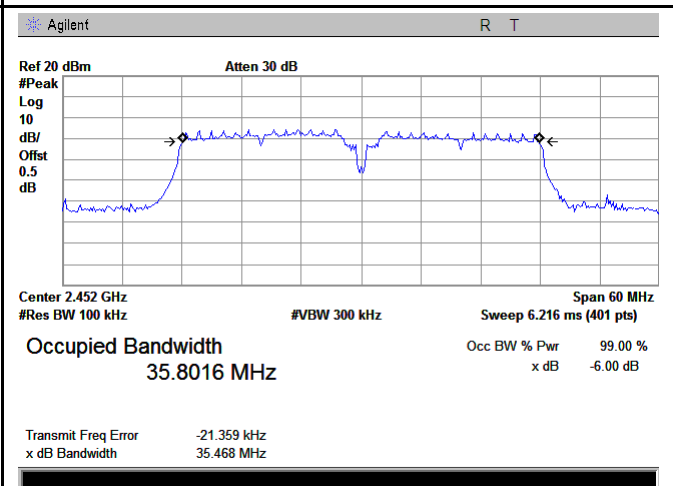

802.11n40 6dB Bandwidth - High CH 2452

20 dB Bandwidth measurement result

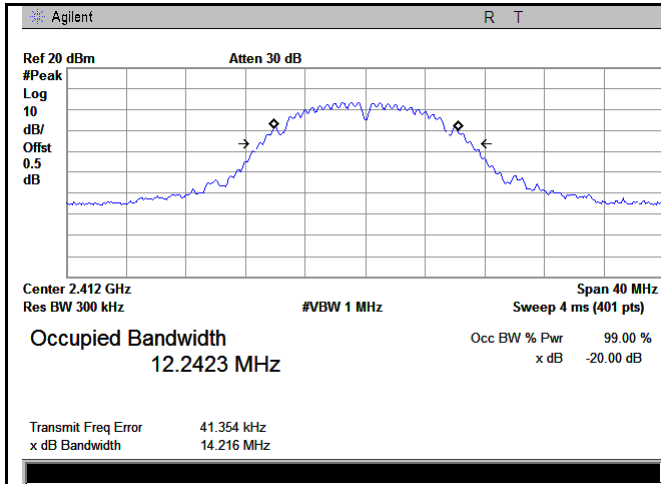

802.11b 20dB Bandwidth - Low CH 2412

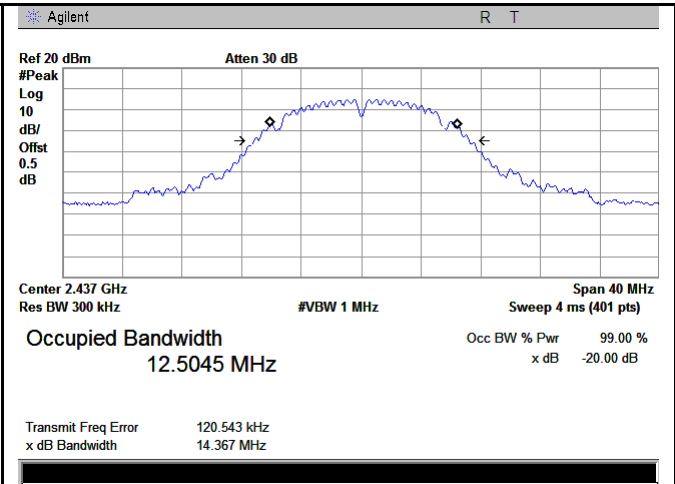

802.11b 20dB Bandwidth - Mid CH 2437

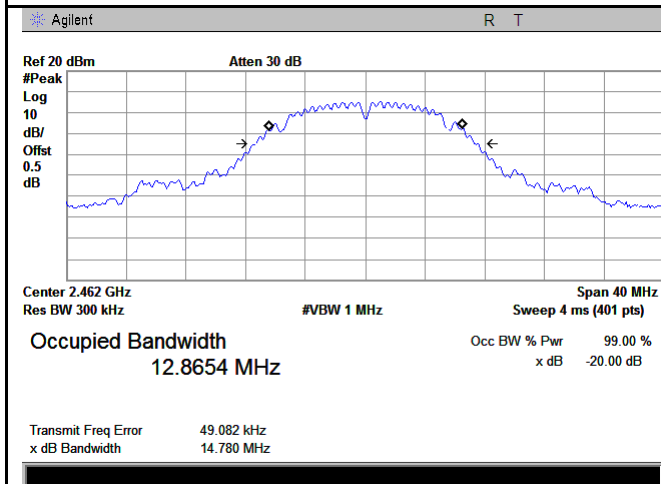

802.11b 20dB Bandwidth - High CH 2462

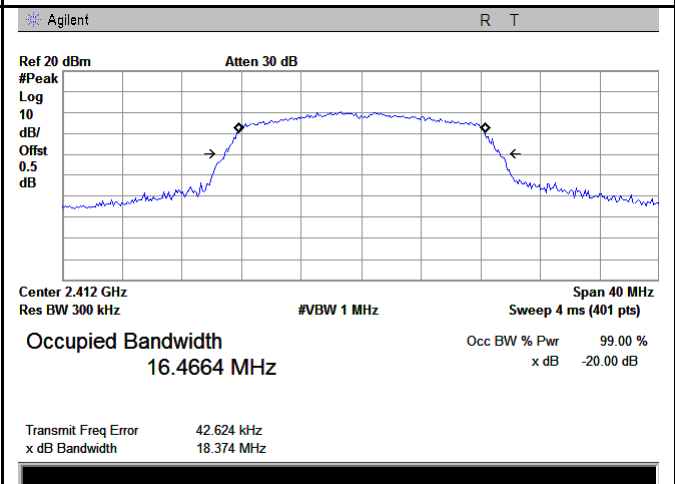

802.11g 20dB Bandwidth - Low CH 2412

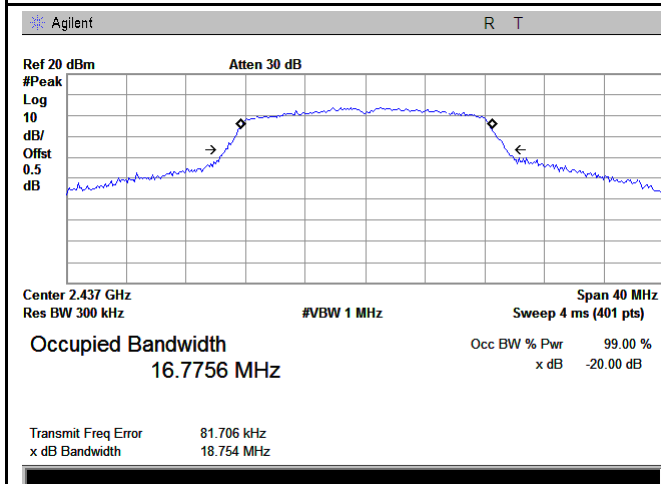

802.11g 20dB Bandwidth - Mid CH 2437

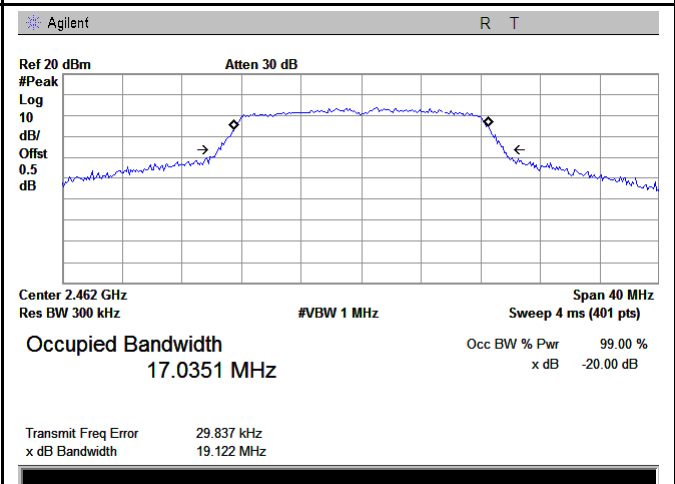

802.11g 20dB Bandwidth - High CH 2462

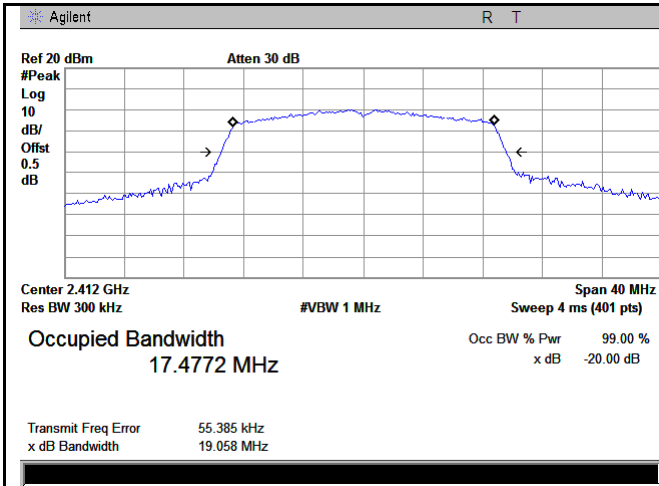

802.11n20 20dB Bandwidth - Low CH 2412

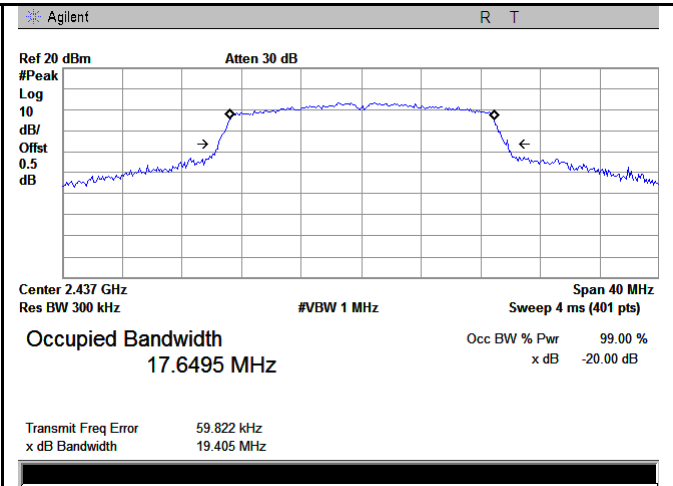

802.11n20 20dB Bandwidth - Mid CH 2437

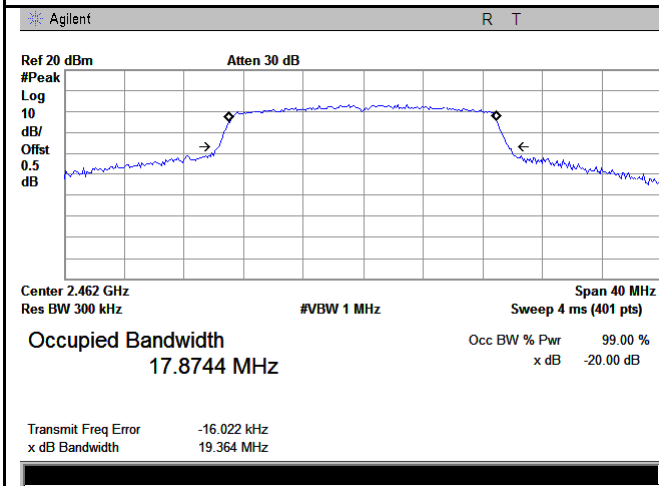

802.11n20 20dB Bandwidth - High CH 2462

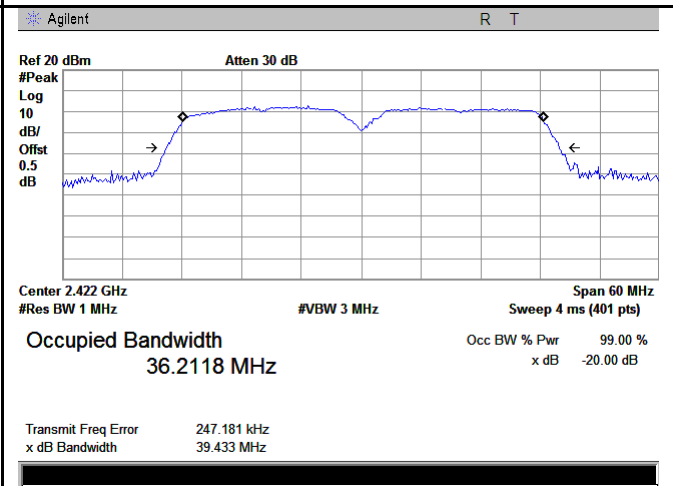

802.11n40 20dB Bandwidth - Low CH 2422

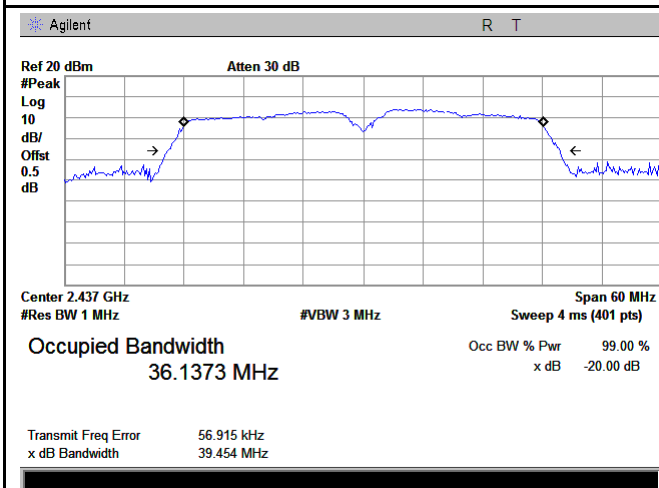

802.11n40 20dB Bandwidth - Mid CH 2437

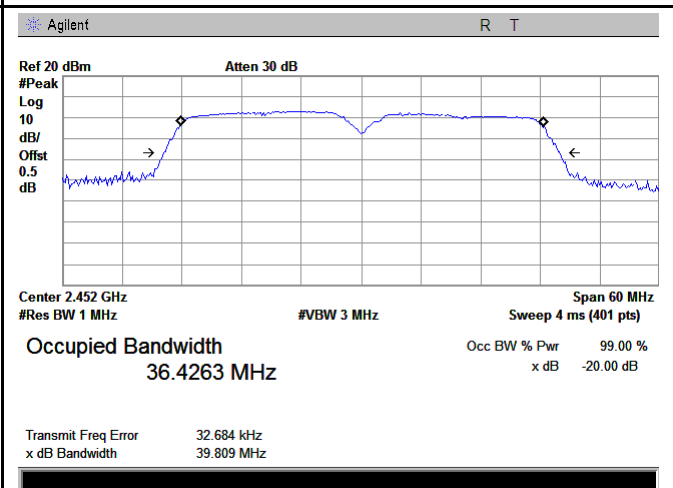

802.11n40 20dB Bandwidth - High CH 2452

6.3 Maximum Output Power

Temperature	25°C
Relative Humidity	53%
Atmospheric Pressure	1010mbar
Test date :	September 12, 2017
Tested By :	Loren Luo

Requirement(s):

Spec	Item	Requirement	Applicable
§15.247(b) (3),RSS210 (A8.4)	a)	FHSS in 2400-2483.5MHz with ≥ 75 channels: ≤ 1 Watt	<input type="checkbox"/>
	b)	FHSS in 5725-5850MHz: ≤ 1 Watt	<input type="checkbox"/>
	c)	For all other FHSS in the 2400-2483.5MHz band: ≤ 0.125 Watt.	<input type="checkbox"/>
	d)	FHSS in 902-928MHz with ≥ 50 channels: ≤ 1 Watt	<input type="checkbox"/>
	e)	FHSS in 902-928MHz with ≥ 25 & <50 channels: ≤ 0.25 Watt	<input type="checkbox"/>
	f)	DTS in 902-928MHz, 2400-2483.5MHz: ≤ 1 Watt	<input checked="" type="checkbox"/>

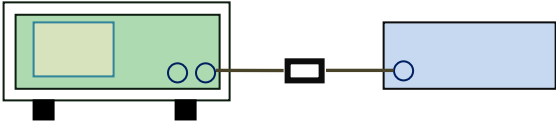
Test Setup	 <p style="text-align: center;">Spectrum Analyzer EUT</p>
------------	--

Test Procedure	<p>558074 D01 DTS MEAS Guidance v03r03, 9.1.2 Integrated band power method Maximum output power measurement procedure</p> <ul style="list-style-type: none"> - a) Set span to at least 1.5 times the OBW. - b) Set RBW = 1-5% of the OBW, not to exceed 1 MHz. - c) Set VBW $\geq 3 \times$ RBW. - d) Number of points in sweep $\geq 2 \times$ span / RBW. (This gives bin-to-bin spacing \leq RBW/2, so that narrowband signals are not lost between frequency bins.) - e) Sweep time = auto. - f) Detector = RMS (i.e., power averaging), if available. Otherwise, use sample detector mode. - g) If transmit duty cycle < 98 %, use a sweep trigger with the level set to enable triggering only on full power pulses. The transmitter shall operate at maximum
----------------	---

	<p>power control level for the entire duration of every sweep. If the EUT transmits continuously (i.e., with no off intervals) or at duty cycle $\geq 98\%$, and if each transmission is entirely at the maximum power control level, then the trigger shall be set to “ free run” .</p> <ul style="list-style-type: none"> - h) Trace average at least 100 traces in power averaging (i.e., RMS) mode. - i) Compute power by integrating the spectrum across the OBW of the signal using the instrument’ s band power measurement function, with band limits set equal to the OBW band edges. If the instrument does not have a band power function, sum the spectrum levels (in power units) at intervals equal to the RBW extending across the entire OBW of the spectrum.
Remark	
Result	<input checked="" type="checkbox"/> Pass <input type="checkbox"/> Fail

Test Data Yes N/A

Test Plot Yes (See below) N/A

Output Power measurement result

Type	Test mode	CH	Frequency (MHz)	Conducted Power (dBm)	Limit (dBm)	Result
Output power	802.11b	Low	2412	11.76	30	Pass
		Mid	2437	11.90	30	Pass
		High	2462	12.10	30	Pass
	802.11g	Low	2412	11.01	30	Pass
		Mid	2437	11.02	30	Pass
		High	2462	11.11	30	Pass
	802.11n (20M)	Low	2412	10.83	30	Pass
		Mid	2437	10.97	30	Pass
		High	2462	10.92	30	Pass
	802.11n (40M)	Low	2422	10.75	30	Pass
		Mid	2437	10.43	30	Pass
		High	2452	10.83	30	Pass

Test Plots

The Average Power

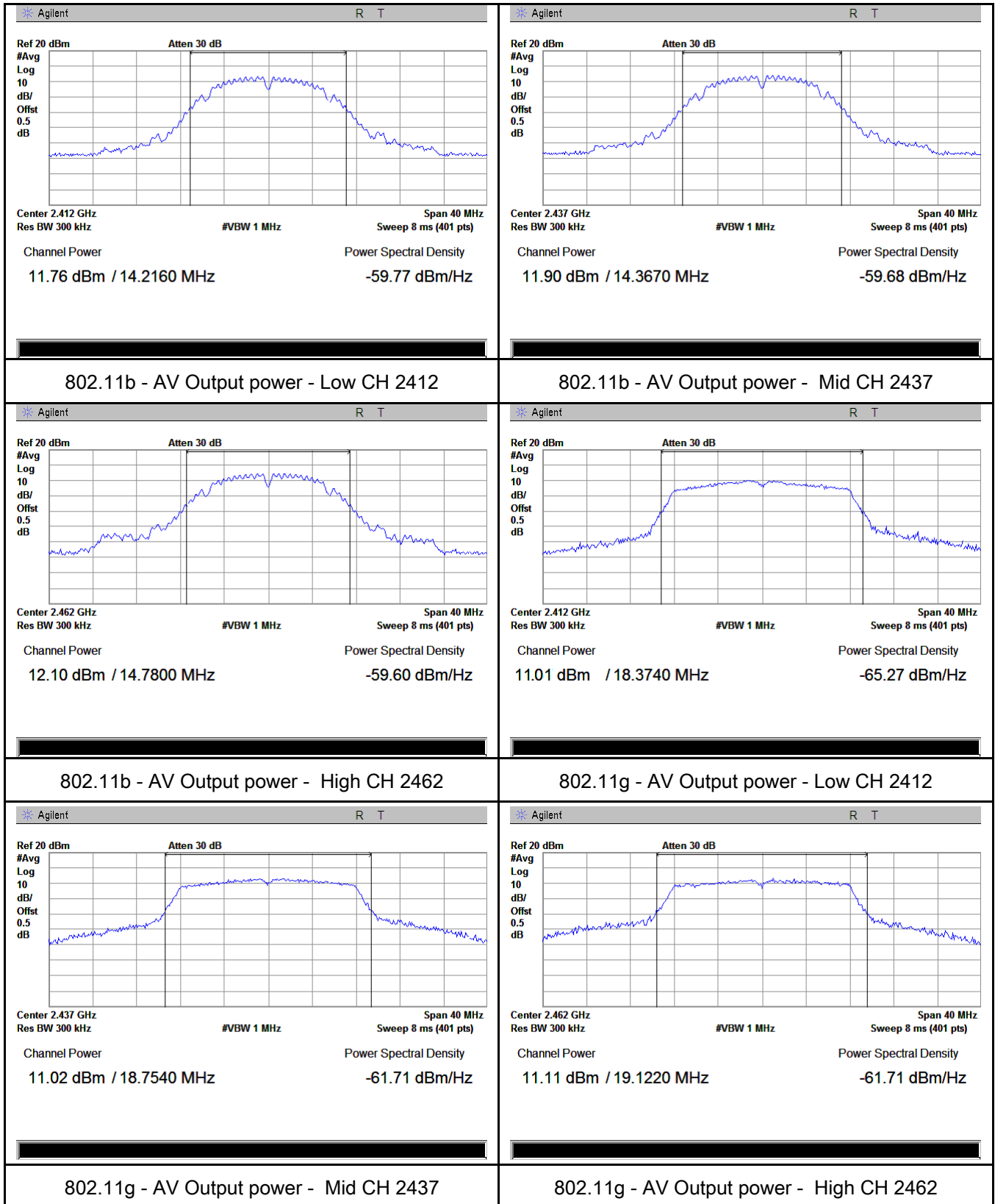

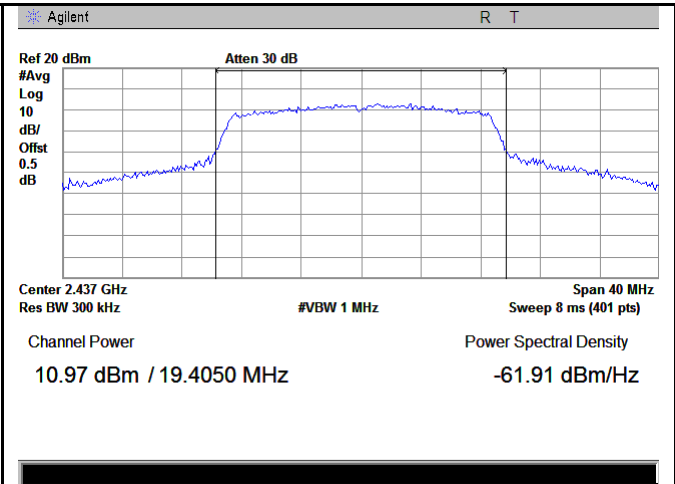
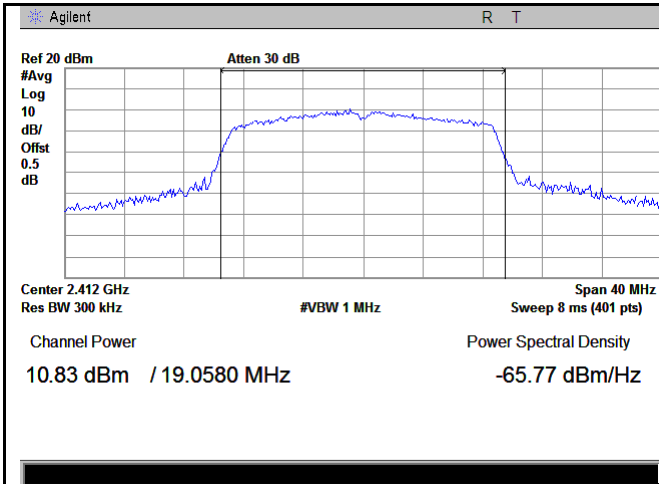

802.11n20 - AV Output power - Low CH 2412

802.11n20 - AV Output power - Mid CH 2437

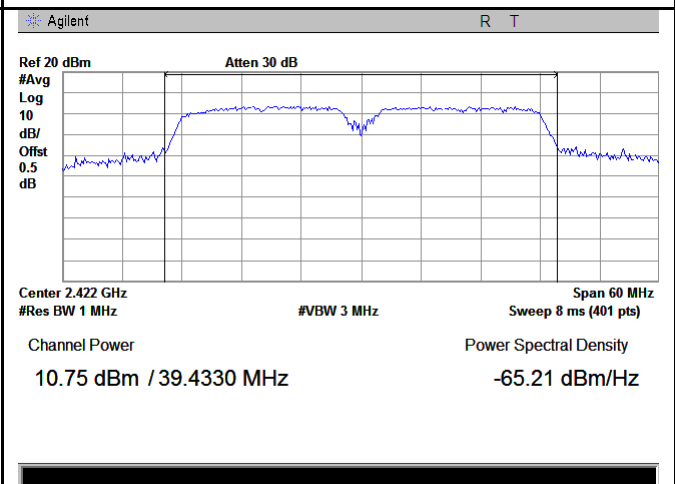
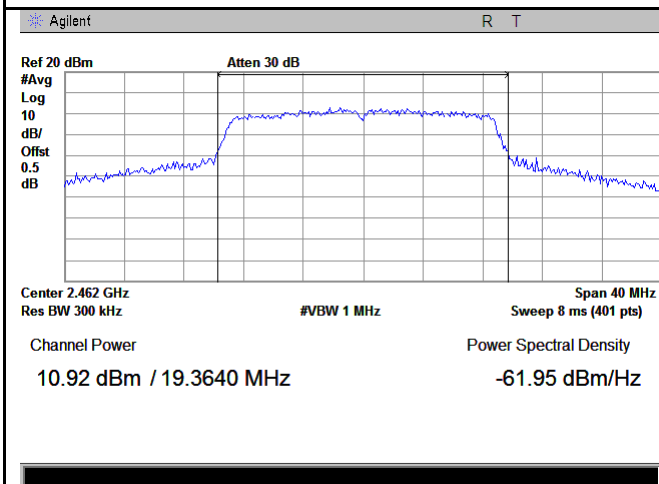

802.11n20 - AV Output power - High CH 2462

802.11n40 - AV Output power - Low CH 2422

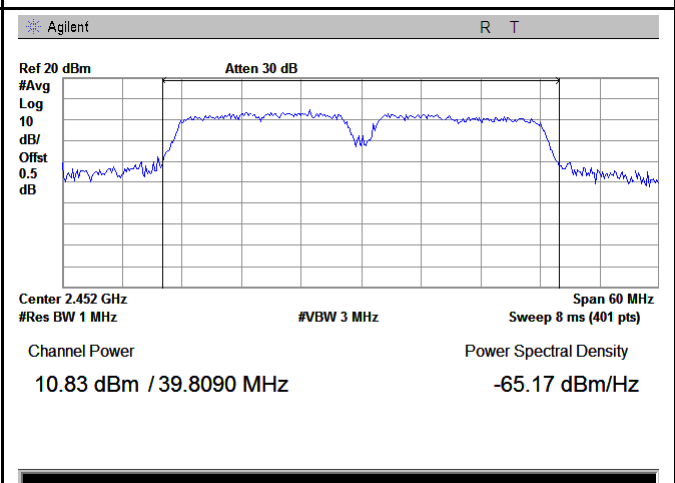
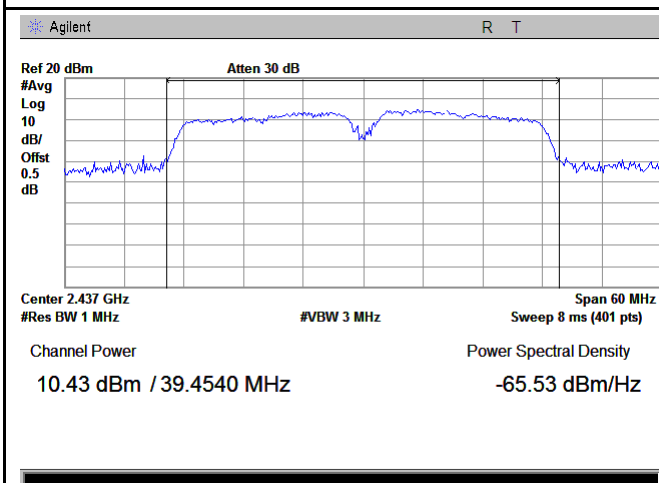

802.11n40 - AV Output power - Mid CH 2437

802.11n40 - AV Output power - High CH 2452

6.4 Power Spectral Density

Temperature	25°C
Relative Humidity	53%
Atmospheric Pressure	1010mbar
Test date :	September 12, 2017
Tested By :	Loren Luo

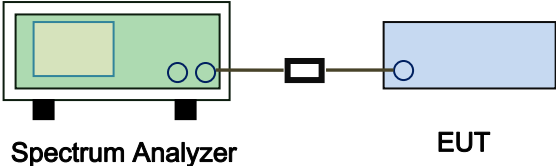
Spec	Item	Requirement	Applicable
§15.247(e)	a)	The power spectral density conducted from the intentional radiator to the antenna shall not be greater than 8 dBm in any 3 kHz band during any time interval of continuous transmission.	<input checked="" type="checkbox"/>
Test Setup	 <p style="text-align: center;">Spectrum Analyzer EUT</p>		
Test Procedure	<p>558074 D01 DTS MEAS Guidance v03r03, 10.2 power spectral density method power spectral density measurement procedure</p> <ul style="list-style-type: none"> - a) Set analyzer center frequency to DTS channel center frequency. - b) Set the span to 1.5 times the DTS bandwidth. - c) Set the RBW to: $3 \text{ kHz} \leq \text{RBW} \leq 100 \text{ kHz}$. - d) Set the VBW $\geq 3 \times \text{RBW}$. - e) Detector = peak. - f) Sweep time = auto couple. - g) Trace mode = max hold. - h) Allow trace to fully stabilize. - i) Use the peak marker function to determine the maximum amplitude level within the RBW. - j) If measured value exceeds limit, reduce RBW (no less than 3 kHz) and repeat. 		
Remark			
Result	<input checked="" type="checkbox"/> Pass <input type="checkbox"/> Fail		

Test Data Yes N/A
 Test Plot Yes (See below) N/A

Power Spectral Density measurement result

Type	Test mode	CH	Freq (MHz)	PSD	Limit (dBm)	Result
				(dBm)		
PSD	802.11b	Low	2412	-10.76	8	Pass
		Mid	2437	-8.219	8	Pass
		High	2462	-9.540	8	Pass
	802.11g	Low	2412	-15.07	8	Pass
		Mid	2437	-12.96	8	Pass
		High	2462	-13.41	8	Pass
	802.11n (20M)	Low	2412	-16.06	8	Pass
		Mid	2437	-13.43	8	Pass
		High	2462	-12.64	8	Pass
	802.11n (40M)	Low	2422	-16.30	8	Pass
		Mid	2437	-14.68	8	Pass
		High	2452	-15.41	8	Pass

Test Plots

Power Spectral Density measurement result

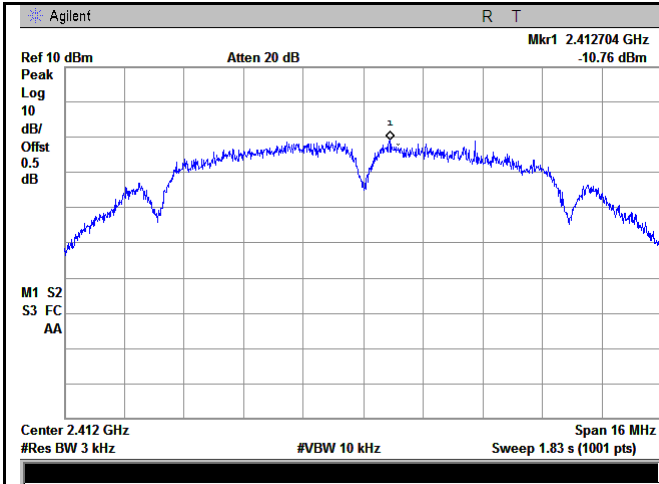

PSD - Low CH 2412 - 802.11b

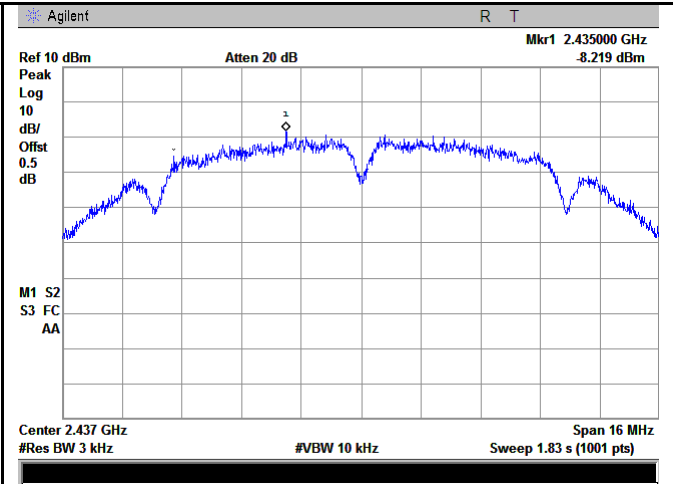

PSD - Mid CH 2437 - 802.11b

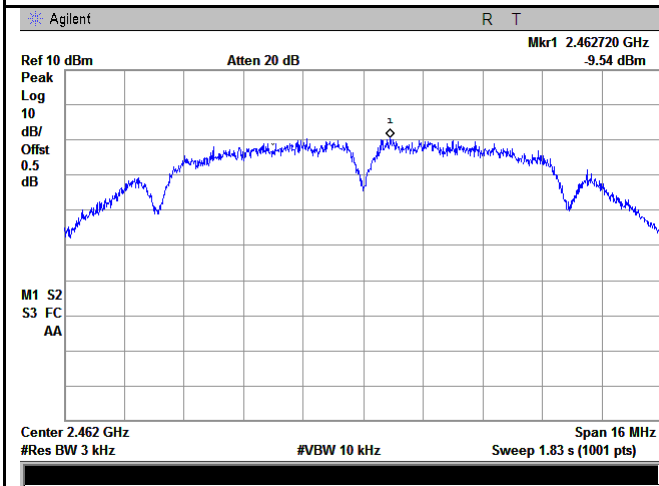

PSD - High CH 2462 - 802.11b

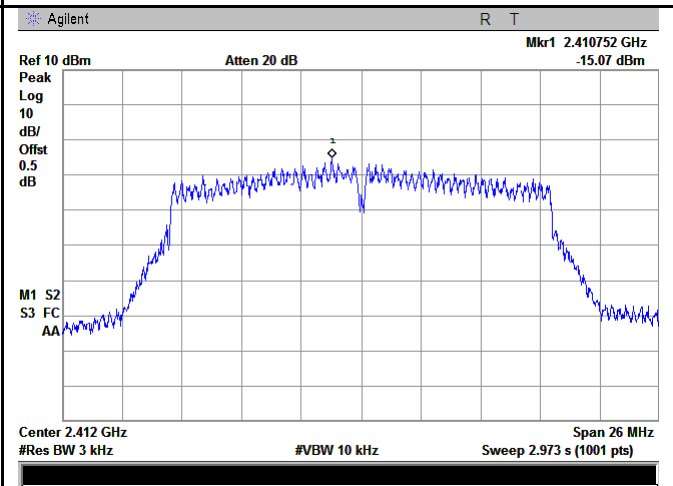

PSD - Low CH 2412 - 802.11g

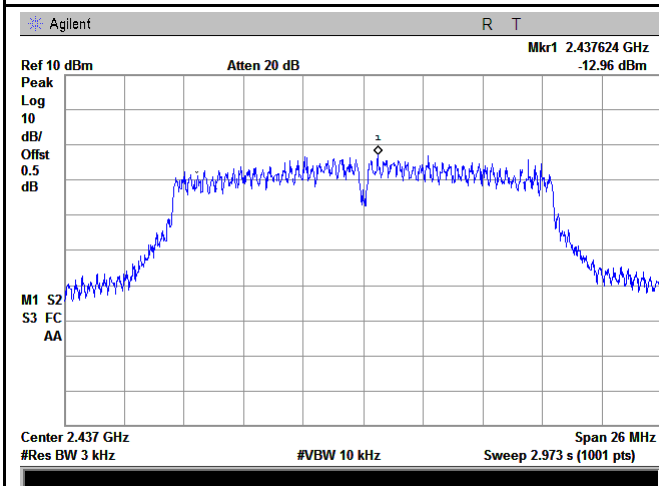

PSD - Mid CH 2437 - 802.11g

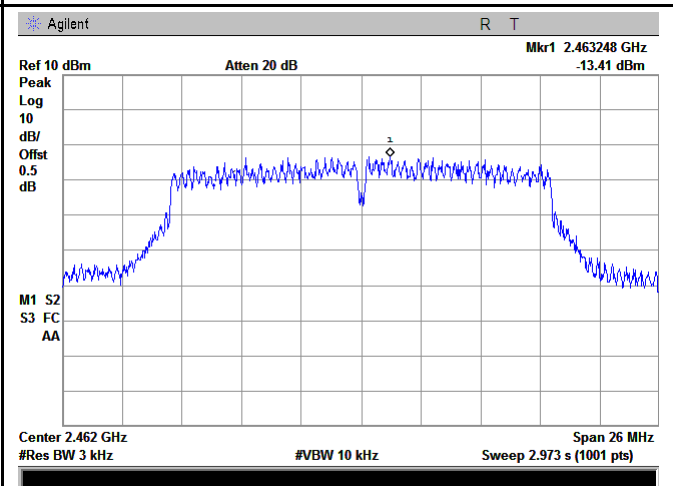

PSD - High CH 2462 - 802.11g

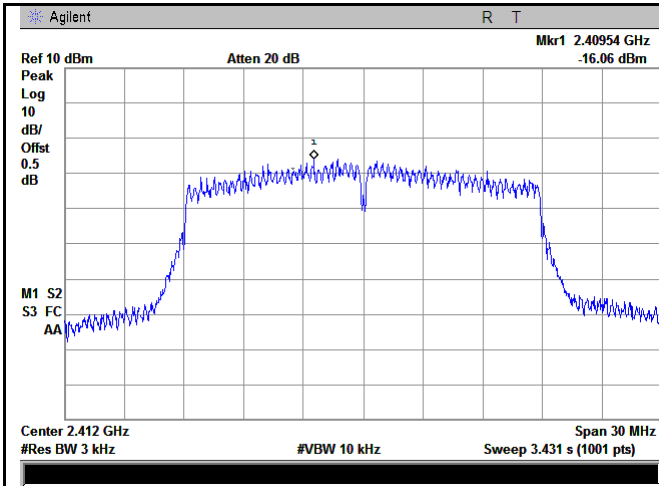

PSD - Low CH 2412 - 802.11n20

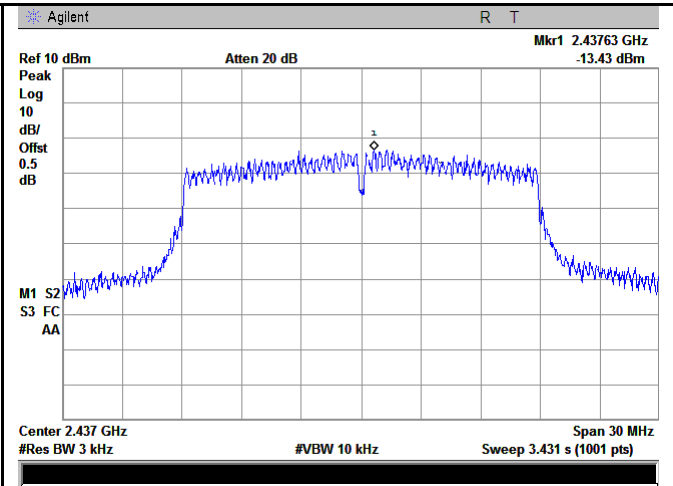

PSD - Mid CH 2437 - 802.11n20

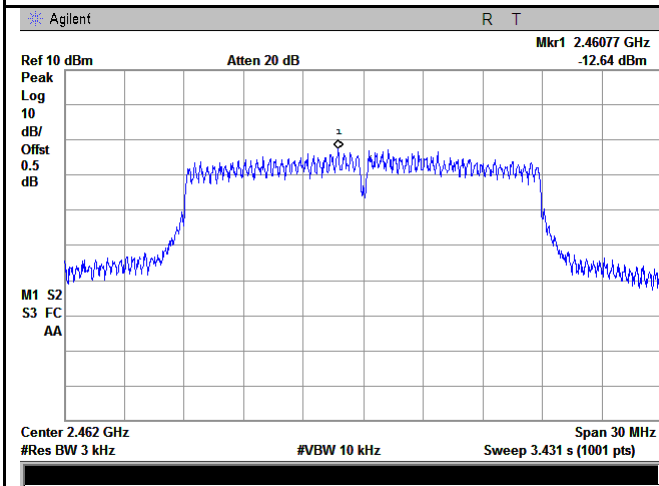

PSD - High CH 2472 - 802.11n20

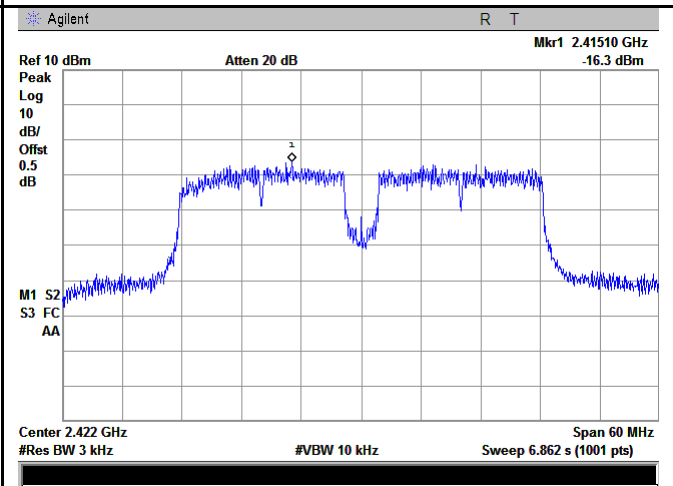

PSD - Low CH 2422 - 802.11n40

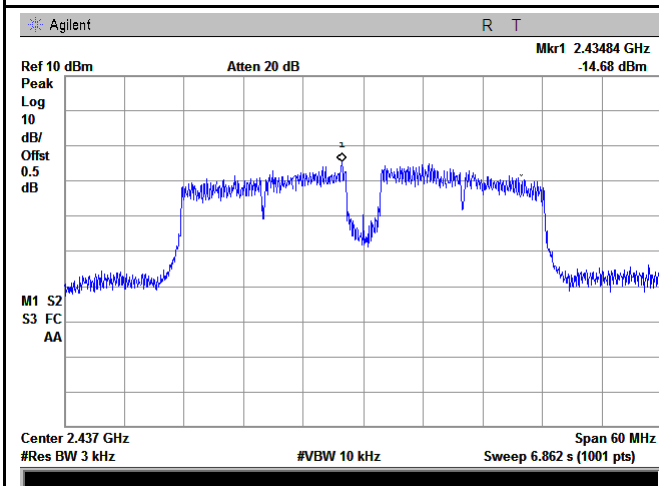

PSD - Mid CH 2437 - 802.11n40

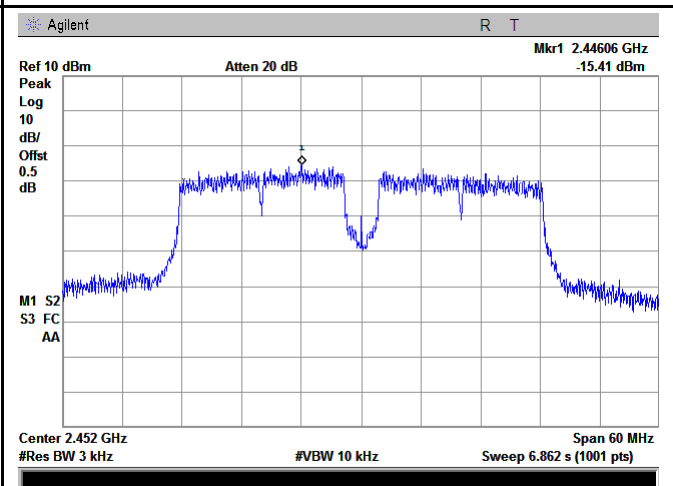

PSD - High CH 2452 - 802.11n40

6.5 Band-Edge & Unwanted Emissions into Restricted Frequency Bands

Temperature	25°C
Relative Humidity	57%
Atmospheric Pressure	1015mbar
Test date :	August 07, 2017
Tested By :	Evans He

Requirement(s):

Spec	Item	Requirement	Applicable
§15.247(d)	a)	In any 100 kHz bandwidth outside the frequency band in which the spread spectrum or digitally modulated intentional radiator is operating, the radio frequency power that is produced by the intentional radiator shall be at least 20 dB below that in the 100 kHz bandwidth within the band that contains the highest level of the desired power, based on either an RF conducted or a radiated measurement, provided the transmitter demonstrates compliance with the peak conducted power limits.	<input checked="" type="checkbox"/>

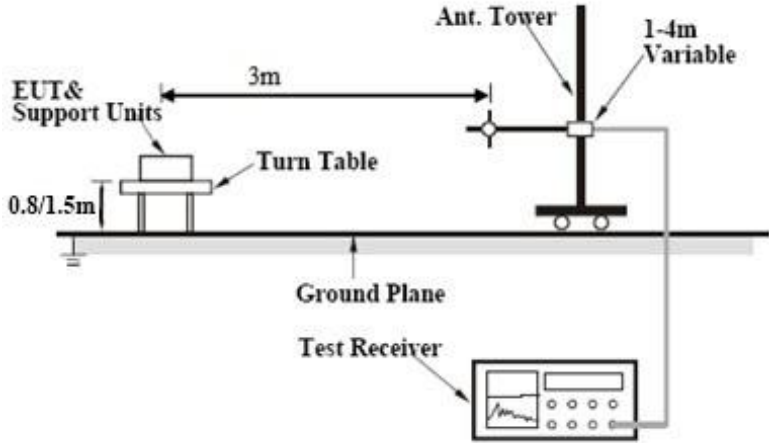
Test Setup	
------------	--

Test Procedure	<p>Radiated Method Only</p> <ul style="list-style-type: none"> - 1. Check the calibration of the measuring instrument using either an internal calibrator or a known signal from an external generator. - 2. Position the EUT without connection to measurement instrument. Put it on the Rotated table and turn on the EUT and make it operate in transmitting mode. Then set it to Low Channel and High Channel within its operating range, and make sure the instrument is operated in its linear range.
----------------	---

Test Report No.	17070659-FCC-R2
Page	27 of 64

	<ul style="list-style-type: none"> - 3. First, set both RBW and VBW of spectrum analyzer to 100 kHz with a convenient frequency span including 100kHz bandwidth from band edge, check the emission of EUT, if pass then set Spectrum Analyzer as below: <ul style="list-style-type: none"> a. The resolution bandwidth and video bandwidth of test receiver/spectrum analyzer is 120 kHz for Quasi Peak detection at frequency below 1GHz. b. The resolution bandwidth of test receiver/spectrum analyzer is 1MHz and video bandwidth is 3MHz with Peak detection for Peak measurement at frequency above 1GHz. c. The resolution bandwidth of test receiver/spectrum analyzer is 1MHz and the video bandwidth is 10Hz with Peak detection for Average Measurement as below at frequency above 1GHz. - 4. Measure the highest amplitude appearing on spectral display and set it as a reference level. Plot the graph with marking the highest point and edge frequency. - 5. Repeat above procedures until all measured frequencies were complete.
Remark	
Result	<input checked="" type="checkbox"/> Pass <input type="checkbox"/> Fail

Test Data Yes N/A
 Test Plot Yes (See below) N/A

Test Plots

Band Edge measurement result

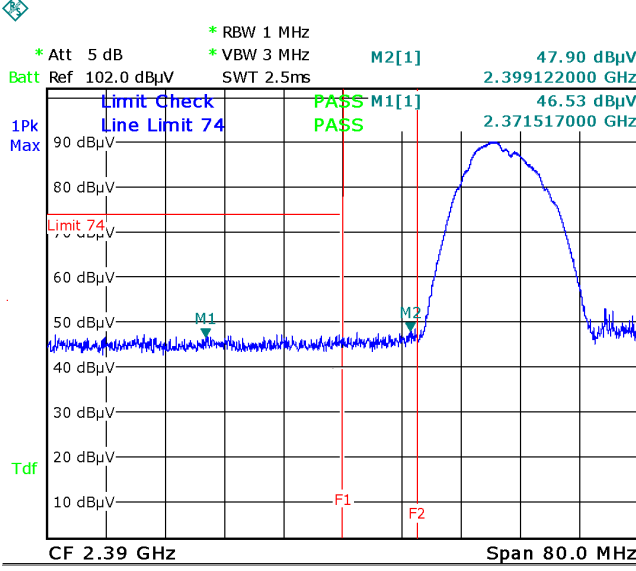
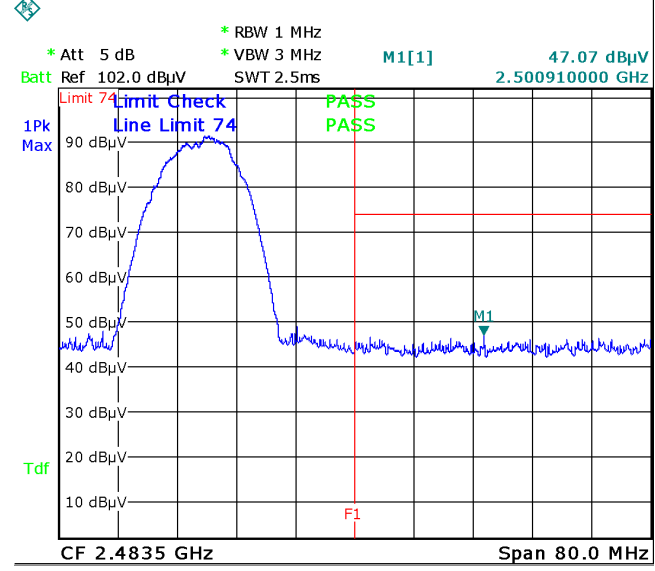
 <p> Band Edge, Left Side (Peak) - 802.11b Note: F1 is frequency 2390MHz; F2 is frequency 2400MHz </p>	 <p> Band Edge, Right Side (Peak) - 802.11b Note: F1 is frequency 2483.5MHz </p>
<p>Note: (no need if PK value less than the AV limit)</p>	<p>Note: (no need if PK value less than the AV limit)</p>
<p>Band Edge, Left Side (Average) - 802.11b</p>	<p>Band Edge, Right Side (Average) - 802.11b</p>

Note: Both Horizontal and vertical polarities were investigated

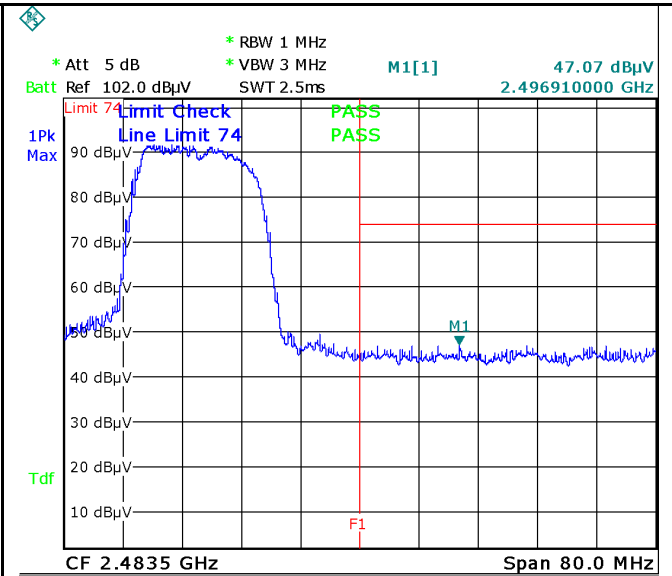
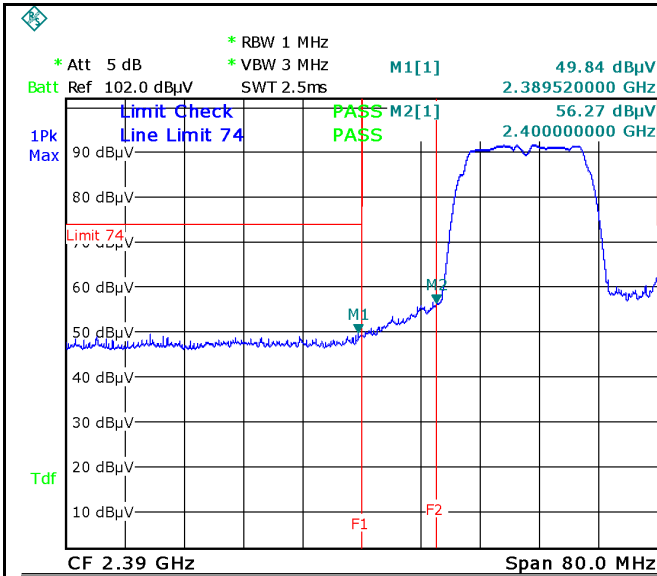

Date: 8.AUG.2017 09:28:37

Date: 7.AUG.2017 12:00:41

Band Edge, Left Side (Peak) - 802.11g
Note: F1 is frequency 2390MHz; F2 is frequency 2400MHz

Band Edge, Right Side (Peak) - 802.11g
Note: F1 is frequency 2483.5MHz

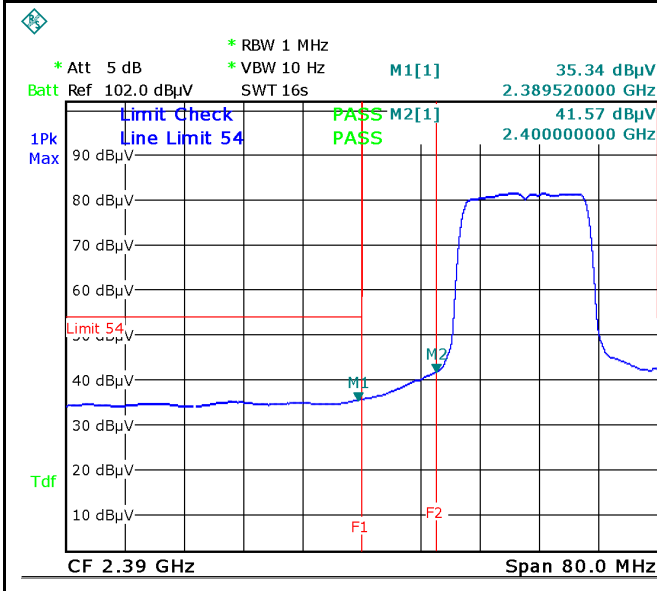

Note: (no need if PK value less than the AV limit)

Date: 8.AUG.2017 09:30:18

Band Edge, Left Side (Average) - 802.11g
Note: F1 is frequency 2390MHz; F2 is frequency 2400MHz

Band Edge, Right Side (Average) - 802.11g
Note: F1 is frequency 2483.5MHz

Note: Both Horizontal and vertical polarities were investigated

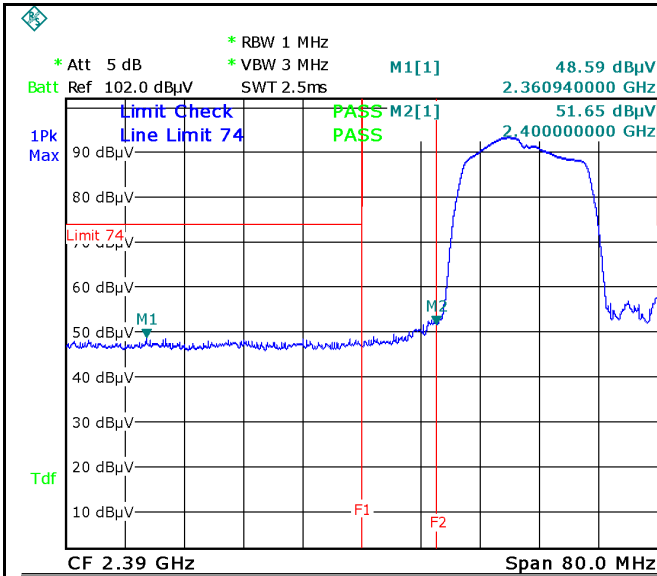

Date: 7.AUG.2017 13:27:30

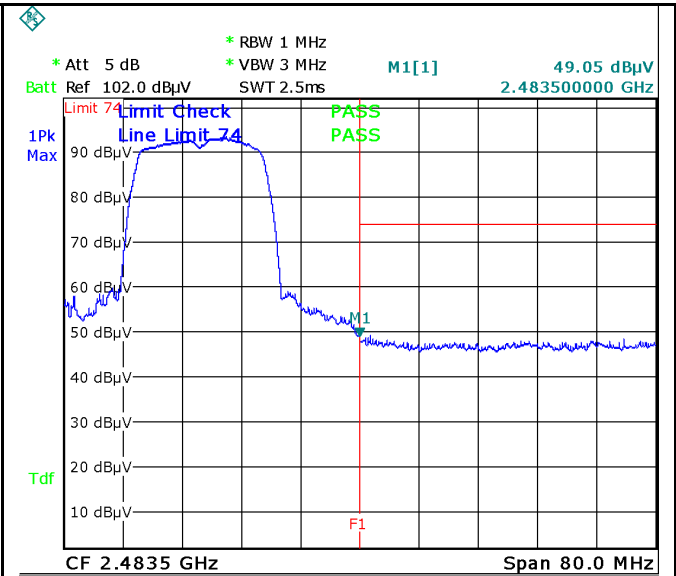

Date: 7.AUG.2017 13:37:59

Band Edge, Left Side (Peak) - 802.11n20

Note: F1 is frequency 2390MHz; F2 is frequency 2400MHz

Band Edge, Right Side (Peak) - 802.11n20

Note: F1 is frequency 2483.5MHz

Note: (no need if PK value less than the AV limit)

Note: (no need if PK value less than the AV limit)

Band Edge, Left Side (Average) - 802.11n20

Note: F1 is frequency 2390MHz; F2 is frequency 2400MHz

Band Edge, Right Side (Average) - 802.11n20

Note: F1 is frequency 2483.5MHz

Note: Both Horizontal and vertical polarities were investigated

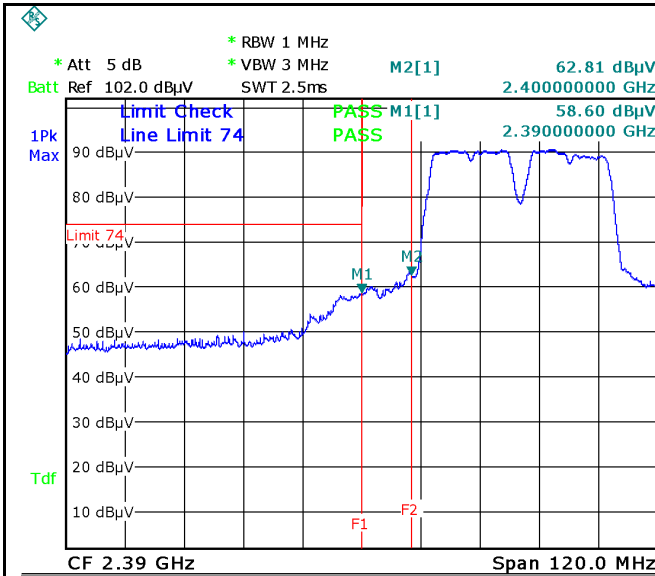

Date: 8.AUG.2017 09:47:24

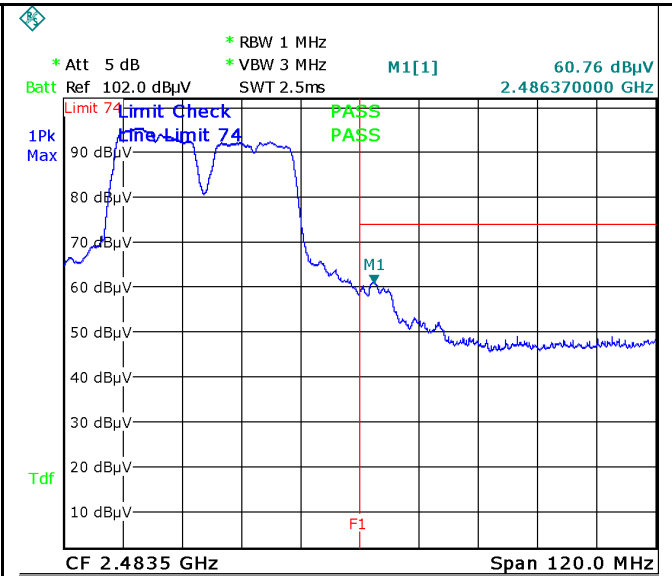

Date: 7.AUG.2017 13:52:12

Band Edge, Left Side (Peak) - 802.11n40

Note: F1 is frequency 2390MHz; F2 is frequency 2400MHz

Band Edge, Right Side (Peak) - 802.11n40

Note: F1 is frequency 2483.5MHz

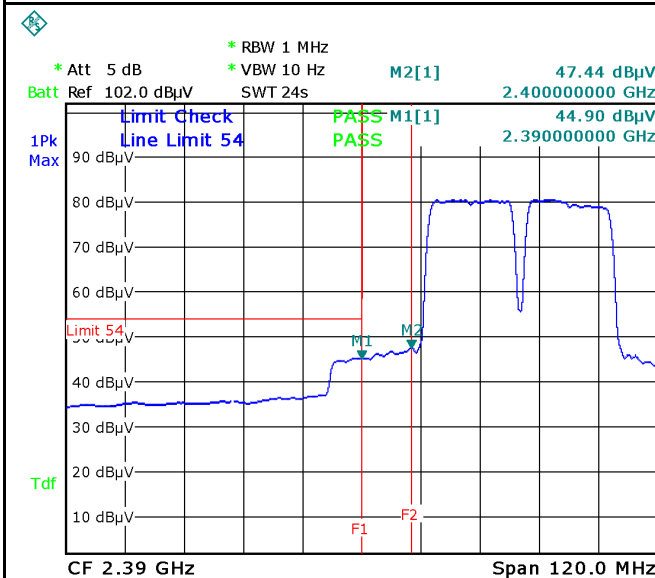

Date: 8.AUG.2017 09:49:12

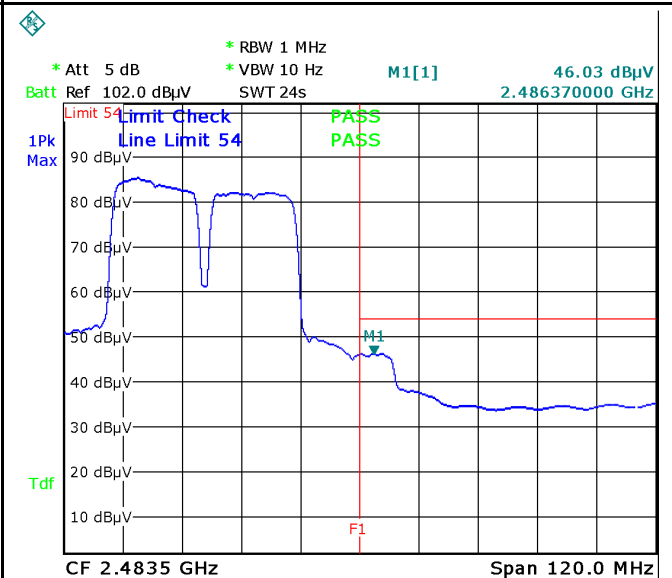

Date: 7.AUG.2017 13:53:27

Band Edge, Left Side (Average) - 802.11n40

Note: F1 is frequency 2390MHz; F2 is frequency 2400MHz

Band Edge, Right Side (Average) - 802.11n40

Note: F1 is frequency 2483.5MHz

Note: Both Horizontal and vertical polarities were investigated

6.6 AC Power Line Conducted Emissions

Temperature	25°C
Relative Humidity	57%
Atmospheric Pressure	1015mbar
Test date :	August 07, 2017
Tested By :	Evans He

Requirement(s):

Spec	Item	Requirement	Applicable														
47CFR§15.207, RSS210 (A8.1)	a)	For Low-power radio-frequency devices that is designed to be connected to the public utility (AC) power line, the radio frequency voltage that is conducted back onto the AC power line on any frequency or frequencies, within the band 150 kHz to 30 MHz, shall not exceed the limits in the following table, as measured using a 50 [mu] H/50 ohms line impedance stabilization network (LISN). The lower limit applies at the boundary between the frequencies ranges.	<input checked="" type="checkbox"/>														
		<table border="1"> <thead> <tr> <th rowspan="2">Frequency ranges (MHz)</th> <th colspan="2">Limit (dBµV)</th> </tr> <tr> <th>QP</th> <th>Average</th> </tr> </thead> <tbody> <tr> <td>0.15 ~ 0.5</td> <td>66 – 56</td> <td>56 – 46</td> </tr> <tr> <td>0.5 ~ 5</td> <td>56</td> <td>46</td> </tr> <tr> <td>5 ~ 30</td> <td>60</td> <td>50</td> </tr> </tbody> </table>		Frequency ranges (MHz)	Limit (dBµV)		QP	Average	0.15 ~ 0.5	66 – 56	56 – 46	0.5 ~ 5	56	46	5 ~ 30	60	50
		Frequency ranges (MHz)			Limit (dBµV)												
				QP	Average												
0.15 ~ 0.5	66 – 56	56 – 46															
0.5 ~ 5	56	46															
5 ~ 30	60	50															

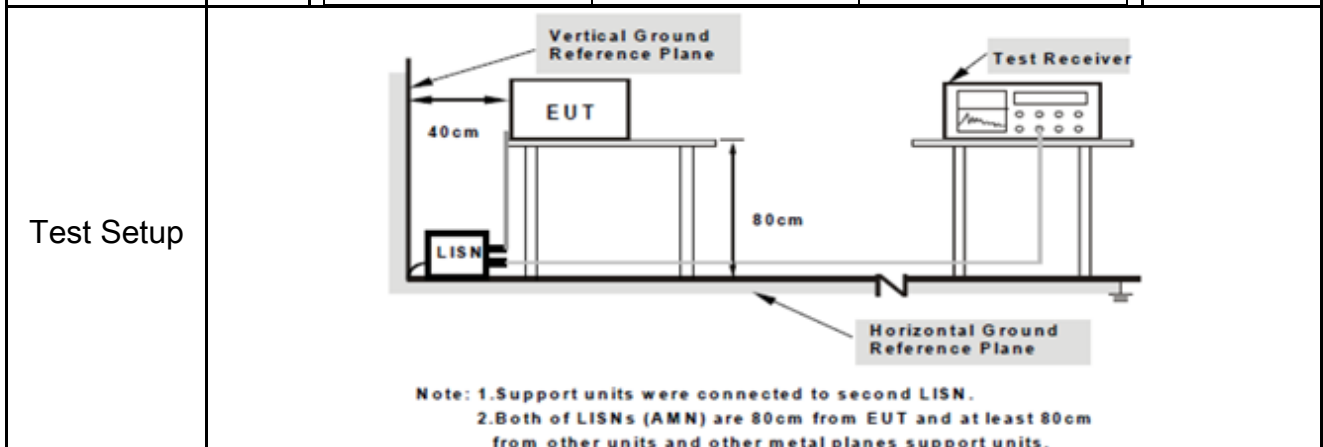

Procedure	<ol style="list-style-type: none"> The EUT and supporting equipment were set up in accordance with the requirements of the standard on top of a 1.5m x 1m x 0.8m high, non-metallic table. The power supply for the EUT was fed through a 50W/50mH EUT LISN, connected to filtered mains. The RF OUT of the EUT LISN was connected to the EMI test receiver via a low-loss
-----------	---

Test Report No.	17070659-FCC-R2
Page	33 of 64

	<p>coaxial cable.</p> <ol style="list-style-type: none"> 4. All other supporting equipment were powered separately from another main supply. 5. The EUT was switched on and allowed to warm up to its normal operating condition. 6. A scan was made on the NEUTRAL line (for AC mains) or Earth line (for DC power) over the required frequency range using an EMI test receiver. 7. High peaks, relative to the limit line, The EMI test receiver was then tuned to the selected frequencies and the necessary measurements made with a receiver bandwidth setting of 10 kHz. 8. Step 7 was then repeated for the LIVE line (for AC mains) or DC line (for DC power).
Remark	
Result	<input checked="" type="checkbox"/> Pass <input type="checkbox"/> Fail

Test Data Yes N/A

Test Plot Yes (See below) N/A

Test Mode:	Transmitting Mode
-------------------	--------------------------

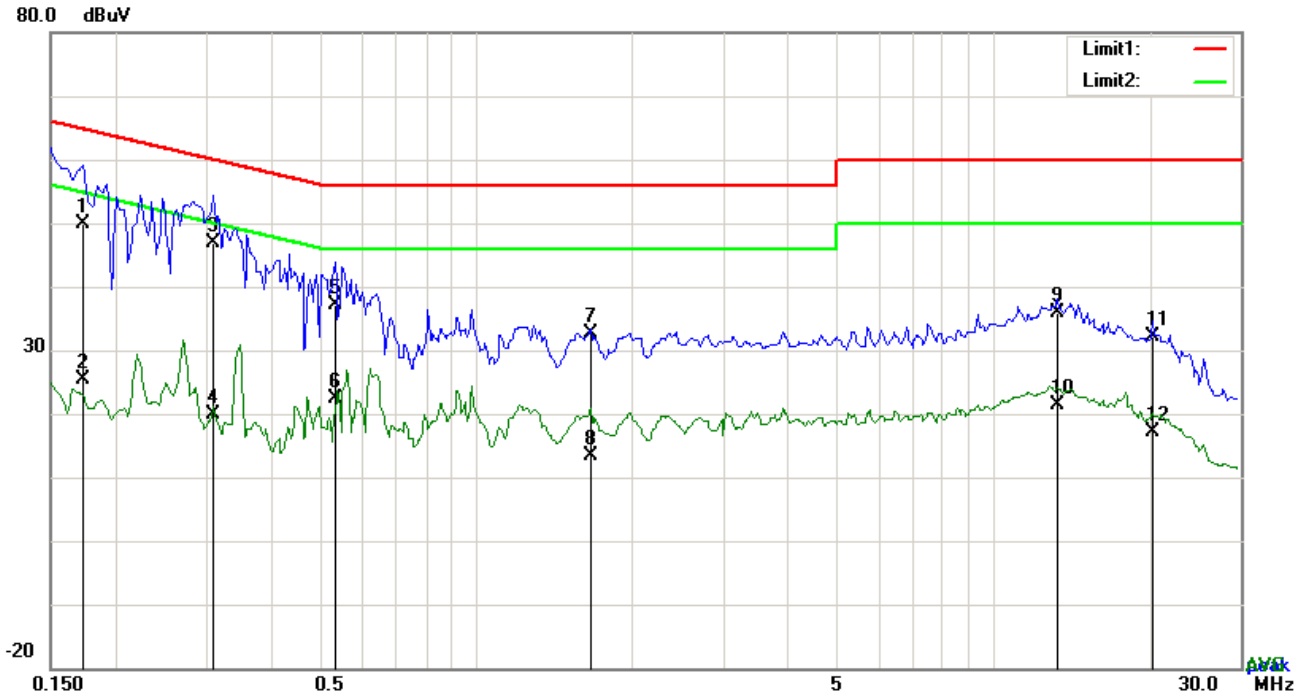

Test Data

Phase Line Plot at 120Vac, 60Hz

No.	P/L	Frequency (MHz)	Reading (dBµV)	Detector	Corrected (dB)	Result (dBµV)	Limit (dBµV)	Margin (dB)
1	L1	0.1734	39.94	QP	10.03	49.97	64.80	-14.83
2	L1	0.1734	15.37	AVG	10.03	25.40	54.80	-29.40
3	L1	0.3099	36.90	QP	10.03	46.93	59.97	-13.04
4	L1	0.3099	9.87	AVG	10.03	19.90	49.97	-30.07
5	L1	0.5322	27.21	QP	10.03	37.24	56.00	-18.76
6	L1	0.5322	12.43	AVG	10.03	22.46	46.00	-23.54
7	L1	1.6671	22.54	QP	10.04	32.58	56.00	-23.42
8	L1	1.6671	3.43	AVG	10.04	13.47	46.00	-32.53
9	L1	13.3116	25.60	QP	10.20	35.80	60.00	-24.20
10	L1	13.3116	11.30	AVG	10.20	21.50	50.00	-28.50
11	L1	20.3121	21.73	QP	10.31	32.04	60.00	-27.96
12	L1	20.3121	6.75	AVG	10.31	17.06	50.00	-32.94

Test Mode: Transmitting Mode

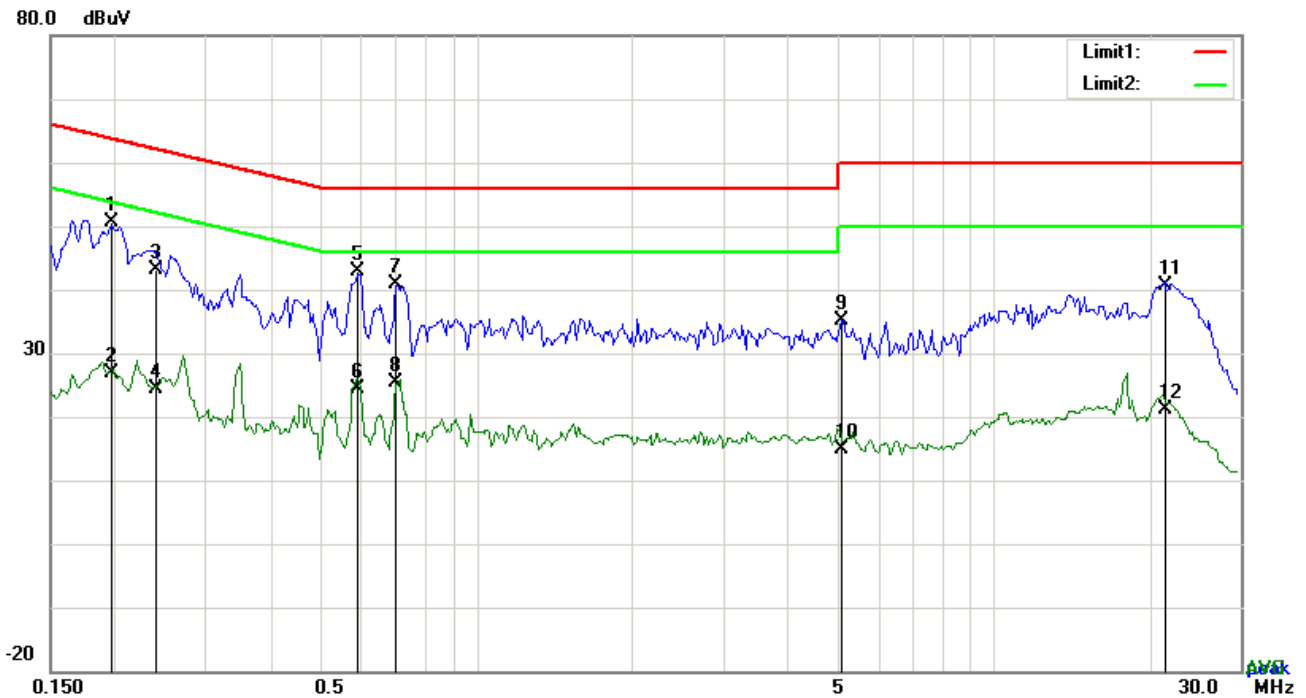

Test Data

Phase Neutral Plot at 120Vac, 60Hz

No.	P/L	Frequency (MHz)	Reading (dBµV)	Detector	Corrected (dB)	Result (dBµV)	Limit (dBµV)	Margin (dB)
1	N	0.1968	40.49	QP	10.03	50.52	63.74	-13.22
2	N	0.1968	16.80	AVG	10.03	26.83	53.74	-26.91
3	N	0.2404	33.02	QP	10.03	43.05	62.08	-19.03
4	N	0.2404	14.41	AVG	10.03	24.44	52.08	-27.64
5	N	0.5907	32.79	QP	10.03	42.82	56.00	-13.18
6	N	0.5907	14.46	AVG	10.03	24.49	46.00	-21.51
7	N	0.6999	30.74	QP	10.03	40.77	56.00	-15.23
8	N	0.6999	15.28	AVG	10.03	25.31	46.00	-20.69
9	N	5.0982	24.97	QP	10.08	35.05	60.00	-24.95
10	N	5.0982	4.79	AVG	10.08	14.87	50.00	-35.13
11	N	21.4470	30.23	QP	10.33	40.56	60.00	-19.44
12	N	21.4470	10.86	AVG	10.33	21.19	50.00	-28.81

Test Mode:	Transmitting Mode
-------------------	--------------------------

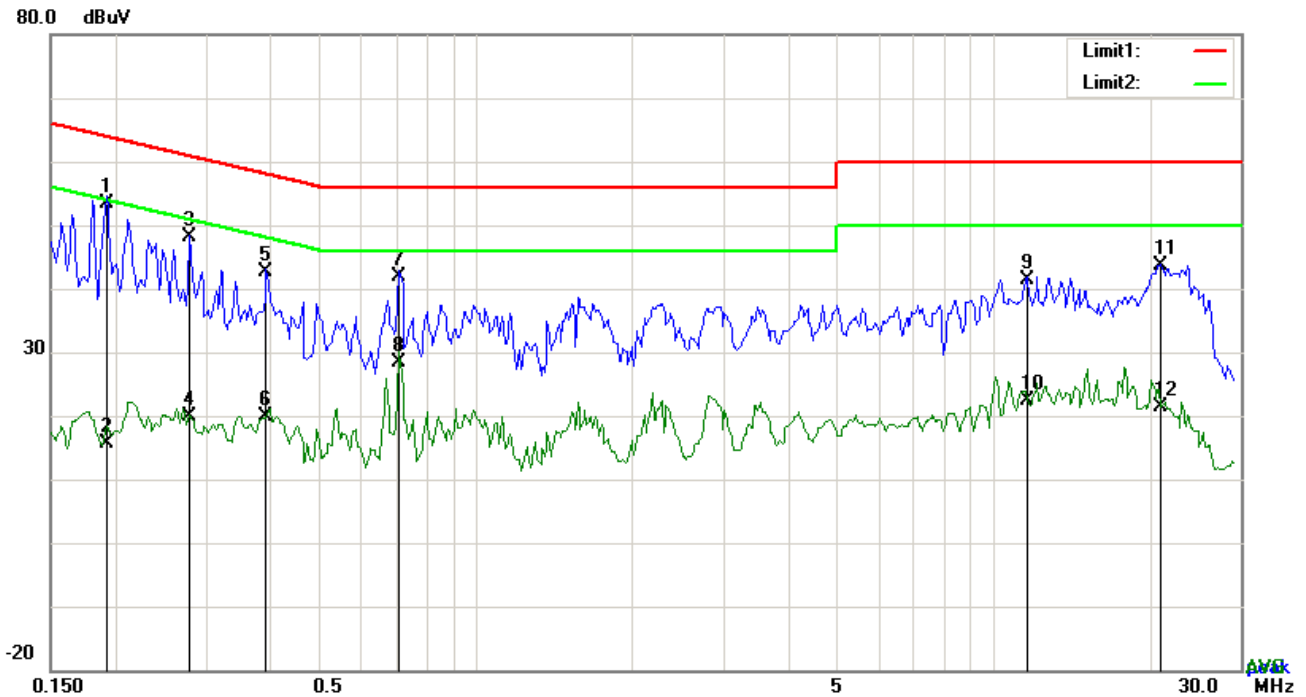

Test Data

Phase Line Plot at 240Vac, 60Hz

No.	P/L	Frequency (MHz)	Reading (dBμV)	Detector	Corrected (dB)	Result (dBμV)	Limit (dBμV)	Margin (dB)
1	L1	0.1929	43.27	QP	10.02	53.29	63.91	-10.62
2	L1	0.1929	5.71	AVG	10.02	15.73	53.91	-38.18
3	L1	0.2787	38.18	QP	10.02	48.20	60.85	-12.65
4	L1	0.2787	9.84	AVG	10.02	19.86	50.85	-30.99
5	L1	0.3918	32.71	QP	10.02	42.73	58.03	-15.30
6	L1	0.3918	9.83	AVG	10.02	19.85	48.03	-28.18
7	L1	0.7077	31.79	QP	10.02	41.81	56.00	-14.19
8	L1	0.7077	18.36	AVG	10.02	28.38	46.00	-17.62
9	L1	11.5722	31.34	QP	10.16	41.50	60.00	-18.50
10	L1	11.5722	12.14	AVG	10.16	22.30	50.00	-27.70
11	L1	21.0336	33.43	QP	10.28	43.71	60.00	-16.29
12	L1	21.0336	11.08	AVG	10.28	21.36	50.00	-28.64

Test Mode:	Transmitting Mode
-------------------	--------------------------

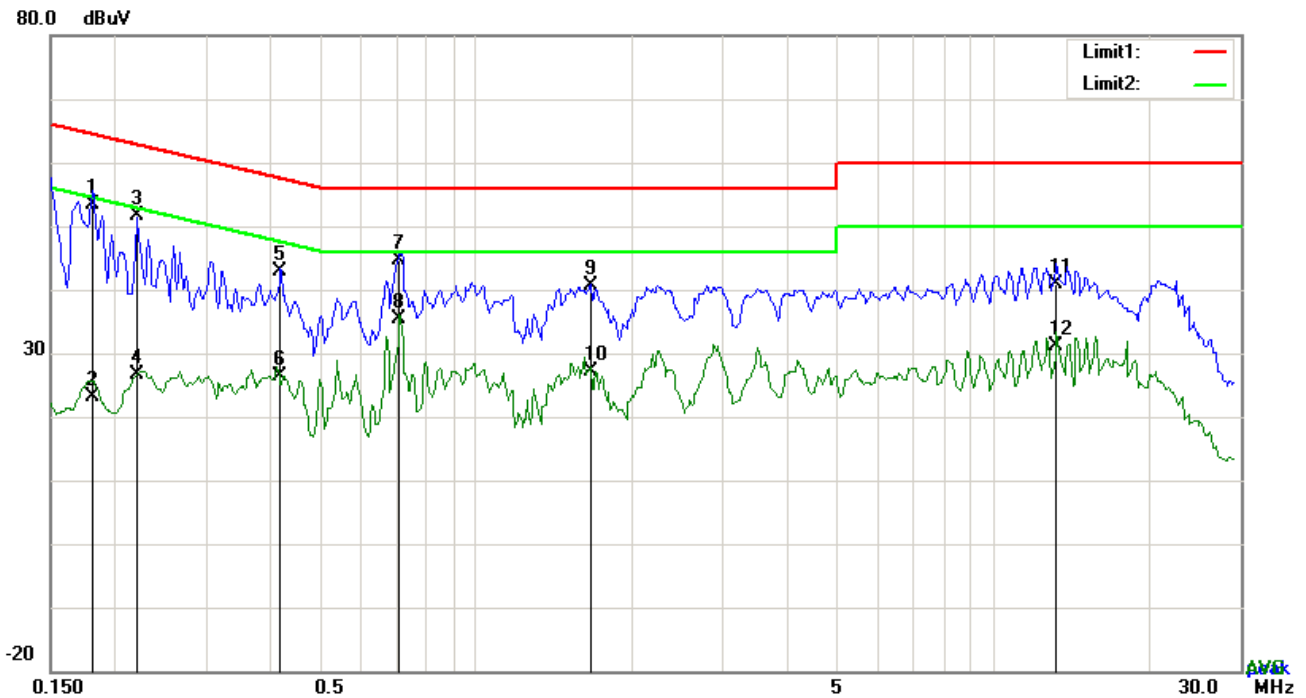

Test Data

Phase Neutral Plot at 240Vac, 60Hz

No.	P/L	Frequency (MHz)	Reading (dBμV)	Detector	Corrected (dB)	Result (dBμV)	Limit (dBμV)	Margin (dB)
1	N	0.1812	43.40	QP	10.02	53.42	64.43	-11.01
2	N	0.1812	13.08	AVG	10.02	23.10	54.43	-31.33
3	N	0.2202	41.70	QP	10.02	51.72	62.81	-11.09
4	N	0.2202	16.67	AVG	10.02	26.69	52.81	-26.12
5	N	0.4191	32.89	QP	10.02	42.91	57.47	-14.56
6	N	0.4191	16.33	AVG	10.02	26.35	47.47	-21.12
7	N	0.7116	34.64	QP	10.02	44.66	56.00	-11.34
8	N	0.7116	25.48	AVG	10.02	35.50	46.00	-10.50
9	N	1.6632	30.68	QP	10.04	40.72	56.00	-15.28
10	N	1.6632	17.10	AVG	10.04	27.14	46.00	-18.86
11	N	13.2297	30.79	QP	10.18	40.97	60.00	-19.03
12	N	13.2297	20.99	AVG	10.18	31.17	50.00	-18.83

6.7 Radiated Spurious Emissions & Restricted Band

Temperature	25°C
Relative Humidity	57%
Atmospheric Pressure	1015mbar
Test date :	August 07, 2017
Tested By :	Evans He

Requirement(s):

Spec	Item	Requirement	Applicable																
47CFR§15.247(d), RSS210 (A8.5)	a)	<p>Except higher limit as specified elsewhere in other section, the emissions from the low-power radio-frequency devices shall not exceed the field strength levels specified in the following table and the level of any unwanted emissions shall not exceed the level of the fundamental emission. The tighter limit applies at the band edges</p> <table border="1"> <thead> <tr> <th>Frequency range (MHz)</th> <th>Field Strength (µV/m)</th> </tr> </thead> <tbody> <tr> <td>0.009~0.490</td> <td>2400/F(KHz)</td> </tr> <tr> <td>0.490~1.705</td> <td>24000/F(KHz)</td> </tr> <tr> <td>1.705~30.0</td> <td>30</td> </tr> <tr> <td>30 – 88</td> <td>100</td> </tr> <tr> <td>88 – 216</td> <td>150</td> </tr> <tr> <td>216 960</td> <td>200</td> </tr> <tr> <td>Above 960</td> <td>500</td> </tr> </tbody> </table>	Frequency range (MHz)	Field Strength (µV/m)	0.009~0.490	2400/F(KHz)	0.490~1.705	24000/F(KHz)	1.705~30.0	30	30 – 88	100	88 – 216	150	216 960	200	Above 960	500	<input checked="" type="checkbox"/>
	Frequency range (MHz)	Field Strength (µV/m)																	
	0.009~0.490	2400/F(KHz)																	
0.490~1.705	24000/F(KHz)																		
1.705~30.0	30																		
30 – 88	100																		
88 – 216	150																		
216 960	200																		
Above 960	500																		
b)	<p>For non-restricted band, In any 100 kHz bandwidth outside the frequency band in which the spread spectrum or digitally modulated intentional radiator is operating, the radio frequency power that is produced by the intentional radiator shall be at least 20 dB or 30dB below that in the 100 kHz bandwidth within the band that contains the highest level of the desired power, determined by the measurement method on output power to be used. Attenuation below the general limits specified in § 15.209(a) is not required</p> <p><input checked="" type="checkbox"/> 20 dB down <input type="checkbox"/> 30 dB down</p>	<input checked="" type="checkbox"/>																	
c)	<p>or restricted band, emission must also comply with the radiated emission limits specified in 15.209</p>	<input checked="" type="checkbox"/>																	

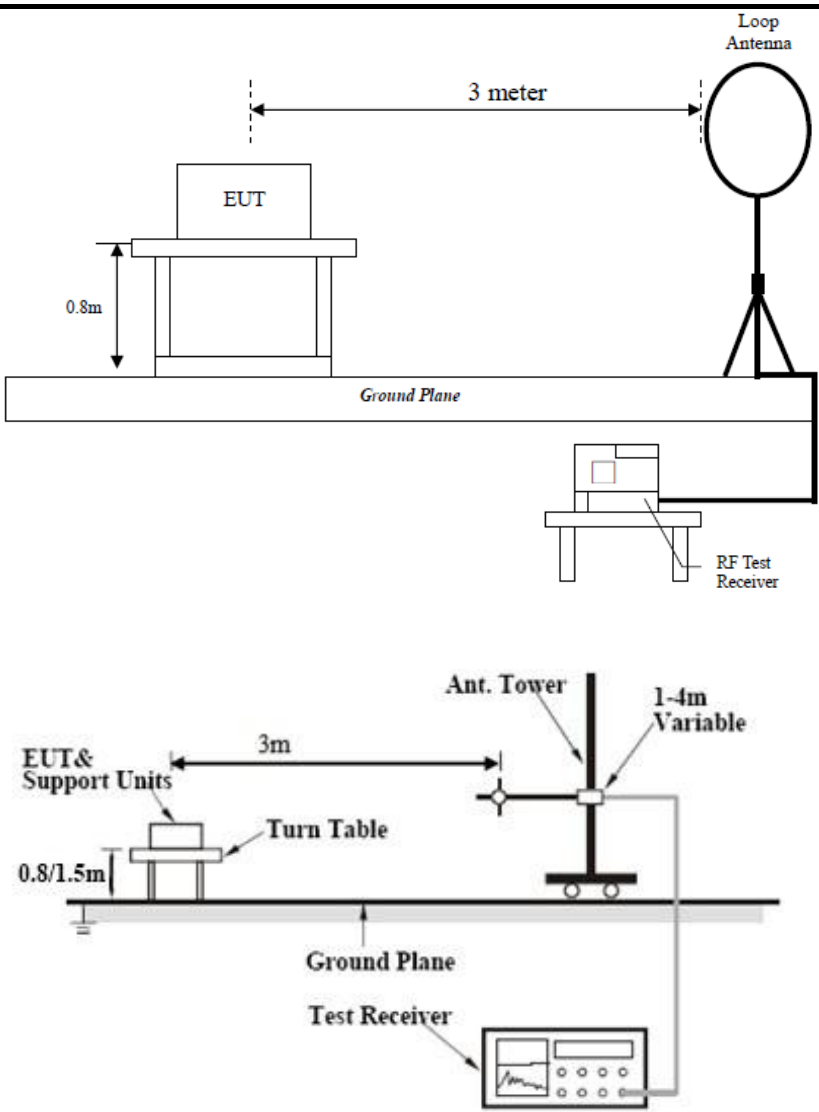
<p>Test Setup</p>	
<p>Procedure</p>	<ol style="list-style-type: none"> 1. The EUT was switched on and allowed to warm up to its normal operating condition. 2. The test was carried out at the selected frequency points obtained from the EUT characterization. Maximization of the emissions, was carried out by rotating the EUT, changing the antenna polarization, and adjusting the antenna height in the following manner: <ol style="list-style-type: none"> a. Vertical or horizontal polarization (whichever gave the higher emission level over a full rotation of the EUT) was chosen. b. The EUT was then rotated to the direction that gave the maximum emission. c. Finally, the antenna height was adjusted to the height that gave the maximum emission. 3. The resolution bandwidth and video bandwidth of test receiver/spectrum analyzer is 120 kHz for Quasiy Peak detection at frequency below 1GHz. 4. The resolution bandwidth of test receiver/spectrum analyzer is 1MHz and video bandwidth is 3MHz with Peak detection for Peak measurement at frequency above 1GHz.

Test Report No.	17070659-FCC-R2
Page	40 of 64

	<p>The resolution bandwidth of test receiver/spectrum analyzer is 1MHz and the video bandwidth is 10Hz with Peak detection for Average Measurement as below at frequency above 1GHz.</p> <p>5. Steps 2 and 3 were repeated for the next frequency point, until all selected frequency points were measured.</p>
Remark	Different RF configuration has been evaluated but not much difference was found. The data presented here is the worst case data with EUT under 802.11n – HT20-2437MHz mode.
Result	<input checked="" type="checkbox"/> Pass <input type="checkbox"/> Fail

Test Data Yes N/A

Test Plot Yes (See below) N/A

Test Result:

Test Mode:	Transmitting Mode
-------------------	-------------------

Frequency range: 9KHz - 30MHz

Freq. (MHz)	Detection value	Factor (dB/m)	Reading (dBuV/m)	Result (dBuV/m)	Limit@3m (dBuV/m)	Margin (dB)
--	--	--	--	--	--	>20
--	--	--	--	--	--	>20

Note:

The amplitude of spurious emissions which are attenuated by more than 20dB below the permissible value has no need to be reported.

Distance extrapolation factor = $40 \log (\text{specific distance}/\text{test distance})$ (dB);

Limit line = specific limits(dBuv) + distance extrapolation factor.

Test Mode:	Transmitting Mode
-------------------	--------------------------

30MHz -1GHz

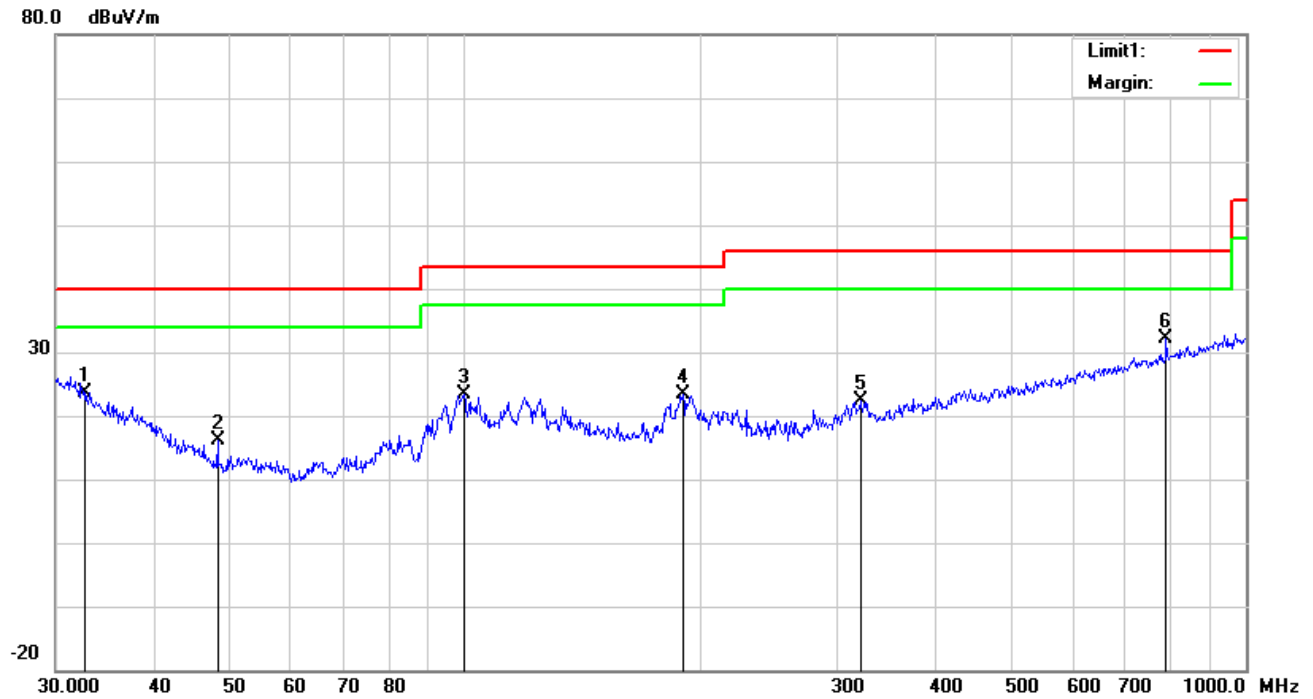

Test Data

Vertical Polarity Plot @3m

No.	P/L	Frequency	Reading	Detect or	Ant_F	PA_G	Cab_L	Result	Limit	Margin	Height	Degree
		(MHz)	(dBuV/m)		(dB/m)	(dB)	(dB)	(dBuV/m)	(dBuV/m)	(dB)	(cm)	(°)
1	H	32.7486	26.01	peak	19.28	22.26	0.70	23.73	40.00	-16.27	200	274
2	H	48.3318	28.61	peak	9.13	22.35	0.78	16.17	40.00	-23.83	100	223
3	H	99.8777	34.11	peak	10.37	22.32	1.12	23.28	43.50	-20.22	100	262
4	H	190.4050	32.47	peak	11.57	22.32	1.54	23.26	43.50	-20.24	100	209
5	H	321.0608	28.72	peak	14.04	22.23	1.90	22.43	46.00	-23.57	100	187
6	H	790.6188	29.02	peak	21.29	21.17	2.94	32.08	46.00	-13.92	100	295

30MHz -1GHz

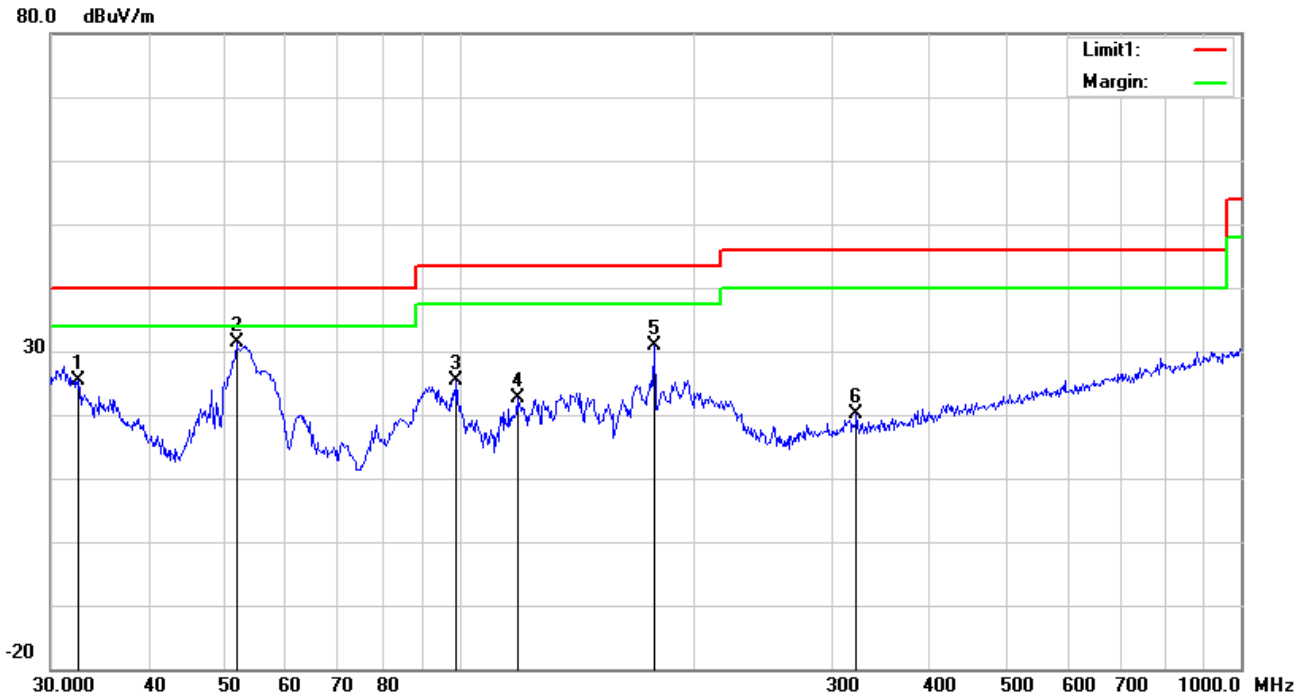

Test Data

Horizontal Polarity Plot @3m

N o.	P/ L	Frequency (MHz)	Reading (dBuV/m)	Detect or	Ant_F (dB/m)	PA_G (dB)	Cab_L (dB)	Result (dBuV/m)	Limit (dBuV/m)	Margin (dB)	Height (cm)	Degr ee (°)
1	V	32.5198	27.50	peak	19.46	22.26	0.69	25.39	40.00	-14.61	100	314
2	V	51.8430	44.77	peak	8.20	22.39	0.79	31.37	40.00	-8.63	100	118
3	V	99.1797	36.51	peak	10.20	22.32	1.10	25.49	43.50	-18.01	100	314
4	V	118.6014	30.06	peak	13.66	22.36	1.16	22.52	43.50	-20.98	100	46
5	V	177.5092	40.62	peak	11.20	22.25	1.36	30.93	43.50	-12.57	100	202
6	V	322.1886	26.31	peak	14.07	22.23	1.90	20.05	46.00	-25.95	200	120

Above 1GHz

Test Mode:	Transmitting Mode
-------------------	--------------------------

Low Channel (2412 MHz) (b mode worst case)

Frequency (MHz)	S.A. Reading (dBμV)	Detector (PK/AV)	Polarity (H/V)	Ant. Factor (dB/m)	Cable Loss (dB)	Pre-Amp. Gain (dB)	Cord Amp. (dBμV/m)	Limit (dBμV/m)	Margin (dB)
4824	44.23	AV	V	33.39	7.22	48.46	36.38	54	-17.62
4824	42.67	AV	H	33.39	7.22	48.46	34.82	54	-19.18
4824	53.16	PK	V	33.39	7.22	48.46	45.31	74	-28.69
4824	51.28	PK	H	33.39	7.22	48.46	43.43	74	-30.57
3611	31.05	AV	V	31.06	6.34	48.89	19.56	54	-34.44
3611	29.67	AV	H	31.06	6.34	48.89	18.18	54	-35.82
3611	48.51	PK	V	31.06	6.34	48.89	37.02	74	-36.98
3611	46.37	PK	H	31.06	6.34	48.89	34.88	74	-39.12

Middle Channel (2437 MHz) (b mode worst case)

Frequency (MHz)	S.A. Reading (dBμV)	Detector (PK/AV)	Polarity (H/V)	Ant. Factor (dB/m)	Cable Loss (dB)	Pre-Amp. Gain (dB)	Cord Amp. (dBμV/m)	Limit (dBμV/m)	Margin (dB)
4874	41.57	AV	V	33.62	7.53	48.36	34.36	54	-19.64
4874	40.23	AV	H	33.62	7.53	48.36	33.02	54	-20.98
4874	54.87	PK	V	33.62	7.53	48.36	47.66	74	-26.34
4874	53.1	PK	H	33.62	7.53	48.36	45.89	74	-28.11
7946	26.87	AV	V	37.89	7.3	47.29	24.77	54	-29.23
7946	24.33	AV	H	37.89	7.3	47.29	22.23	54	-31.77
7946	45.28	PK	V	37.89	7.3	47.29	43.18	74	-30.82
7946	43.16	PK	H	37.89	7.3	47.29	41.06	74	-32.94

High Channel (2462 MHz) (b mode worst case)

Frequency (MHz)	S.A. Reading (dB μ V)	Detector (PK/AV)	Polarity (H/V)	Ant. Factor (dB/m)	Cable Loss (dB)	Pre-Amp. Gain (dB)	Cord Amp. (dB μ V/m)	Limit (dB μ V/m)	Margin (dB)
4924	40.23	AV	V	33.74	7.78	48.34	33.41	54	-20.59
4924	38.57	AV	H	33.74	7.78	48.34	31.75	54	-22.25
4924	49.51	PK	V	33.74	7.78	48.34	42.69	74	-31.31
4924	46.38	PK	H	33.74	7.78	48.34	39.56	74	-34.44
17924	19.65	AV	V	43.21	19.44	44.4	37.9	54	-16.1
17924	18.43	AV	H	43.21	19.44	44.4	36.68	54	-17.32
17924	38.79	PK	V	43.21	19.44	44.4	57.04	74	-16.96
17924	37.45	PK	H	43.21	19.44	44.4	55.7	74	-18.3

Note:

- 1, The testing has been conformed to $10 \times 2462 \text{MHz} = 24,620 \text{MHz}$
- 2, All other emissions more than 30 dB below the limit
- 3, X-Axis, Y-Axis and Z-Axis were investigated. The results above show only the worst case.
- 4, The radiated spurious test above 18GHz is subcontracted to SIEMIC (Nanjing-China) Laboratories. and found 30dB below the limit at least.

Annex A. TEST INSTRUMENT

Instrument	Model	Serial #	Cal Date	Cal Due	In use
AC Line Conducted					
EMI test receiver	ESCS30	8471241027	09/16/2016	09/15/2017	<input checked="" type="checkbox"/>
Line Impedance	LI-125A	191106	09/24/2016	09/23/2017	<input checked="" type="checkbox"/>
Line Impedance	LI-125A	191107	09/24/2016	09/23/2017	<input checked="" type="checkbox"/>
ISN	ISN T800	34373	09/24/2016	09/23/2017	<input type="checkbox"/>
Transient Limiter	LIT-153	531118	08/31/2016	08/30/2017	<input checked="" type="checkbox"/>
RF conducted test					
Agilent ESA-E SERIES	E4407B	MY45108319	09/16/2016	09/15/2017	<input checked="" type="checkbox"/>
Power Splitter	1#	1#	08/30/2017	08/29/2018	<input checked="" type="checkbox"/>
DC Power Supply	E3640A	MY40004013	08/30/2017	08/29/2018	<input checked="" type="checkbox"/>
Radiated Emissions					
EMI test receiver	ESL6	100262	09/16/2016	09/15/2017	<input checked="" type="checkbox"/>
Positioning Controller	UC3000	MF780208282	11/18/2016	11/17/2017	<input checked="" type="checkbox"/>
OPT 010 AMPLIFIER (0.1-1300MHz)	8447E	2727A02430	08/31/2016	08/30/2017	<input checked="" type="checkbox"/>
Microwave Preamplifier (1 ~ 26.5GHz)	8449B	3008A02402	03/23/2017	03/22/2018	<input checked="" type="checkbox"/>
Horn Antenna	BBHA9170	3145226D1	09/28/2016	09/27/2017	<input checked="" type="checkbox"/>
Active Antenna (9kHz-30MHz)	AL-130	121031	10/13/2016	10/12/2017	<input checked="" type="checkbox"/>
Bilog Antenna (30MHz~6GHz)	JB6	A110712	09/20/2016	09/19/2017	<input checked="" type="checkbox"/>
Double Ridge Horn Antenna (1 ~18GHz)	AH-118	71283	09/23/2016	09/22/2017	<input checked="" type="checkbox"/>
Universal Radio Communication Tester	CMU200	121393	09/24/2016	09/23/2017	<input checked="" type="checkbox"/>

Annex B. EUT and Test Setup Photographs

Annex B.i. Photograph: EUT External Photo

Whole Package View

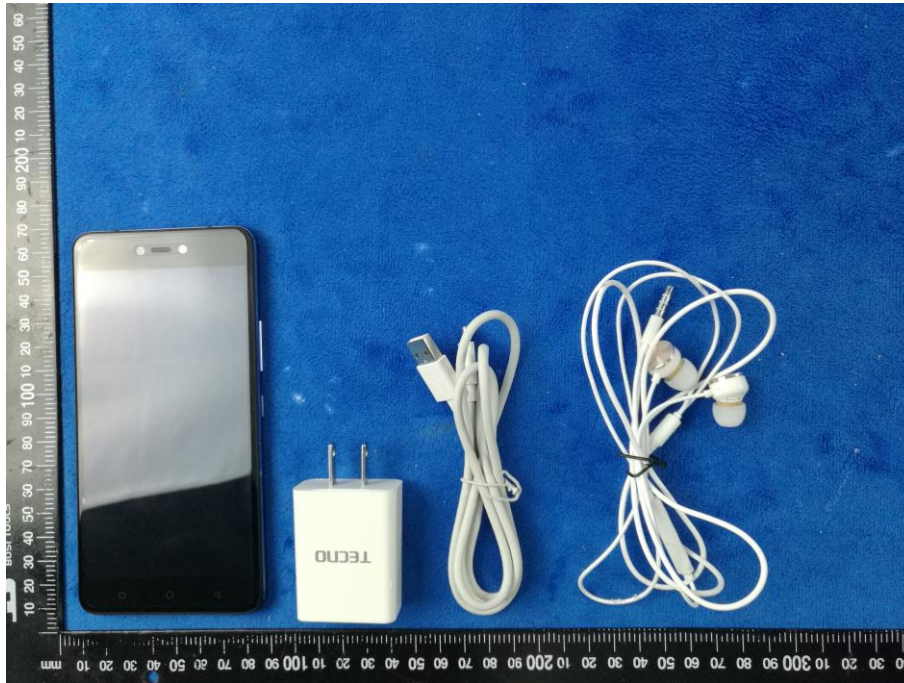

Adapter - Label View



EUT - Front View

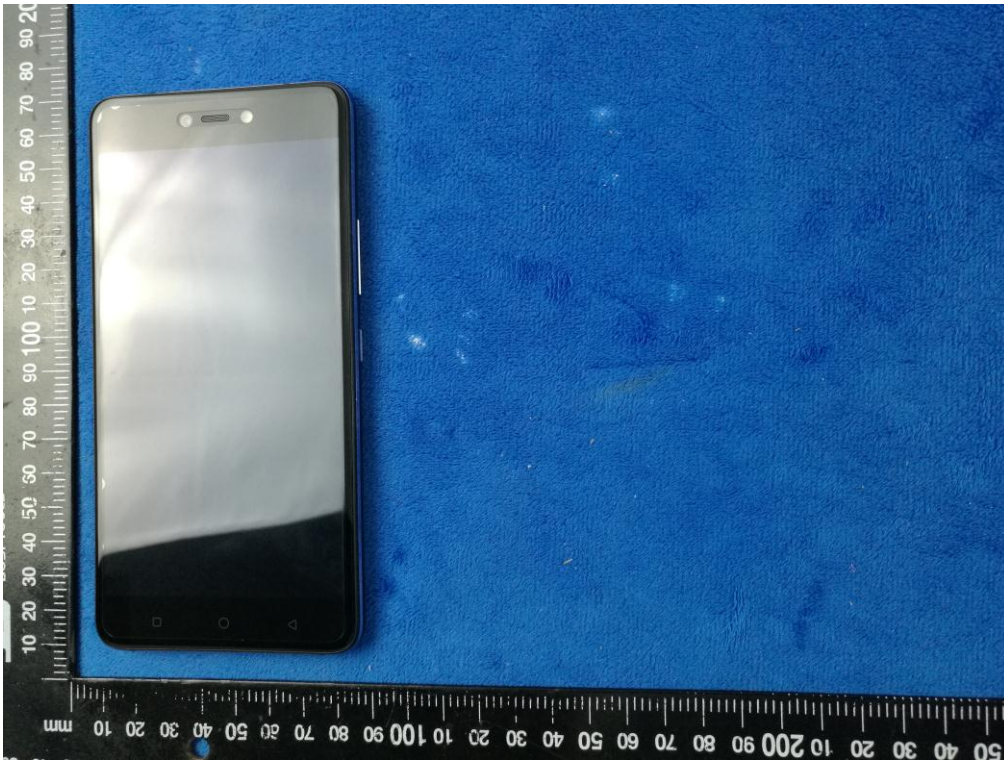

EUT - Rear View

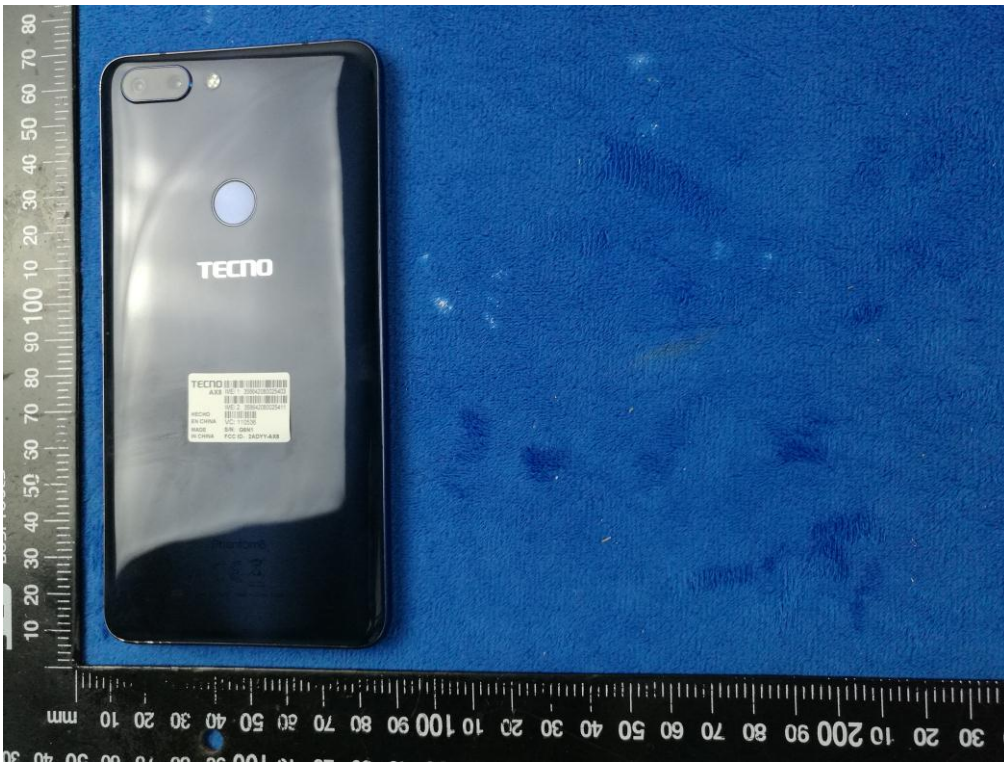

EUT - Top View



EUT - Bottom View



Test Report No.	17070659-FCC-R2
Page	50 of 64

EUT - Left View

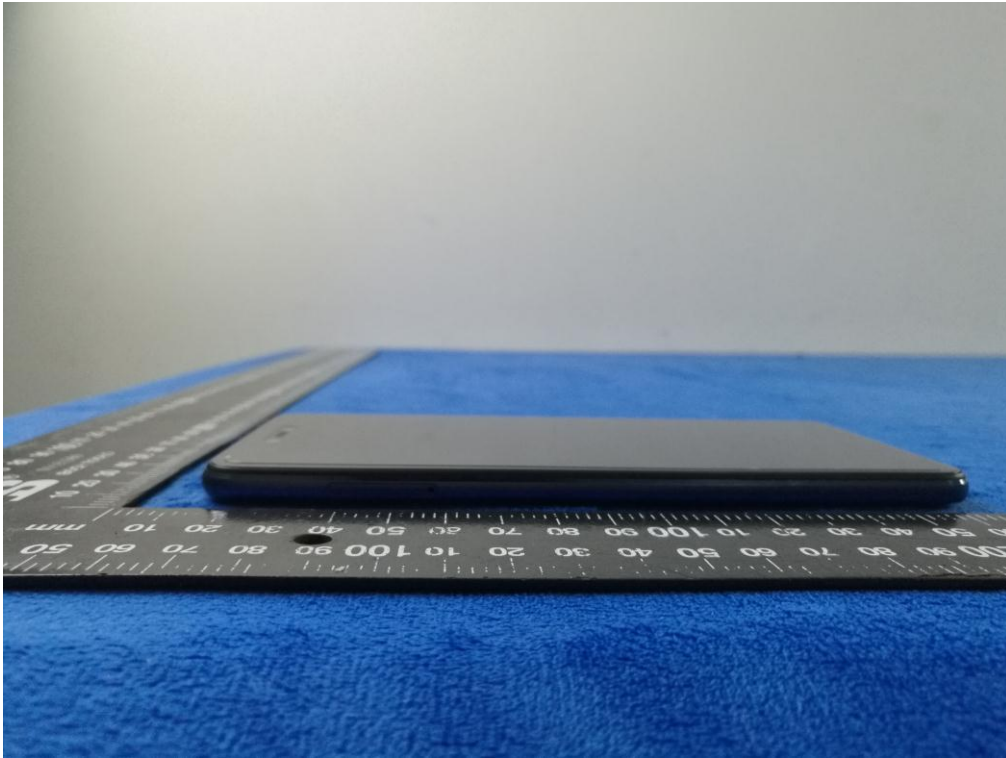

EUT - Right View

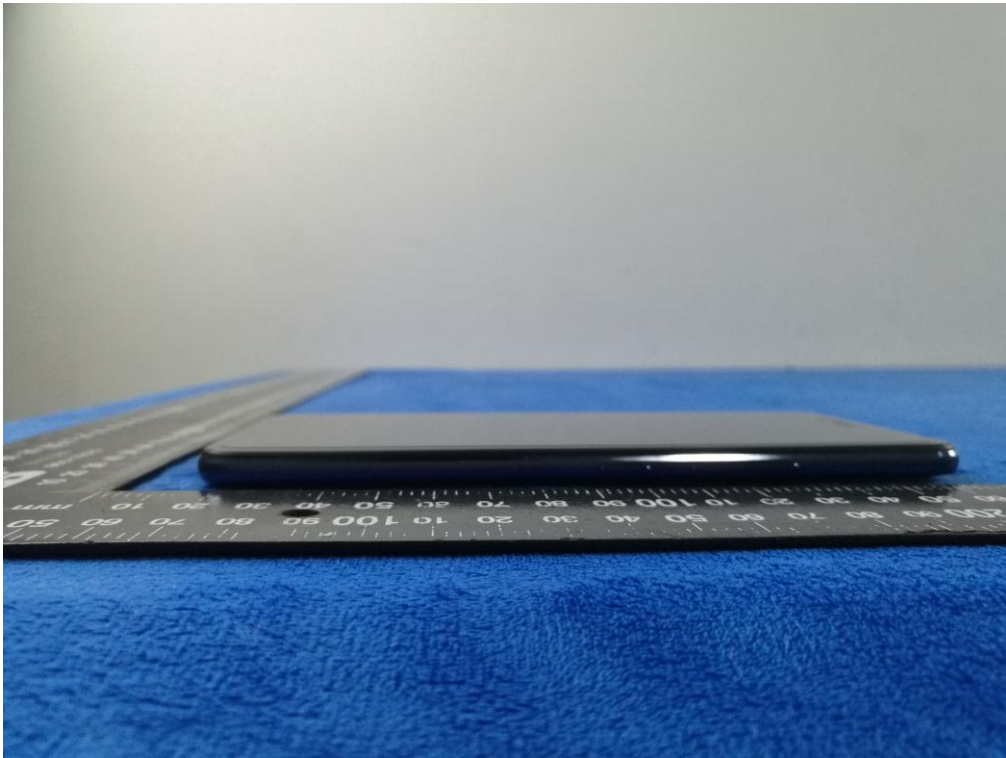

Annex B.ii. Photograph: EUT Internal Photo

Cover Off - Top View 1



Cover Off - Top View 2



Battery - Front View



Battery - Rear View

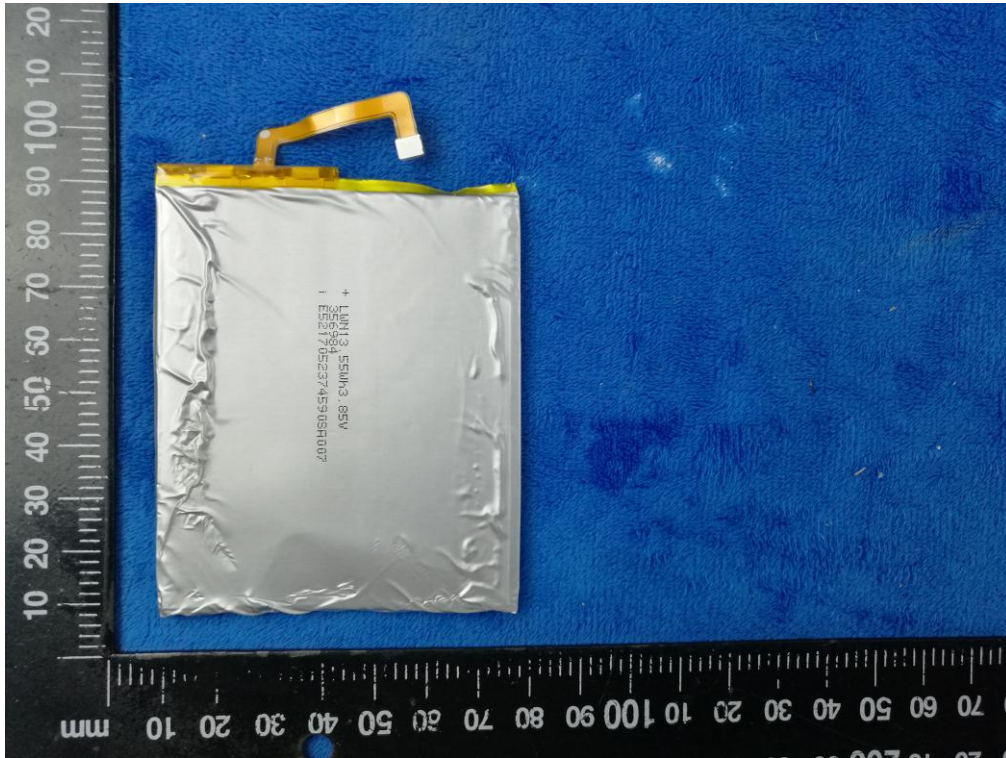

Mainboard with Shielding - Front View

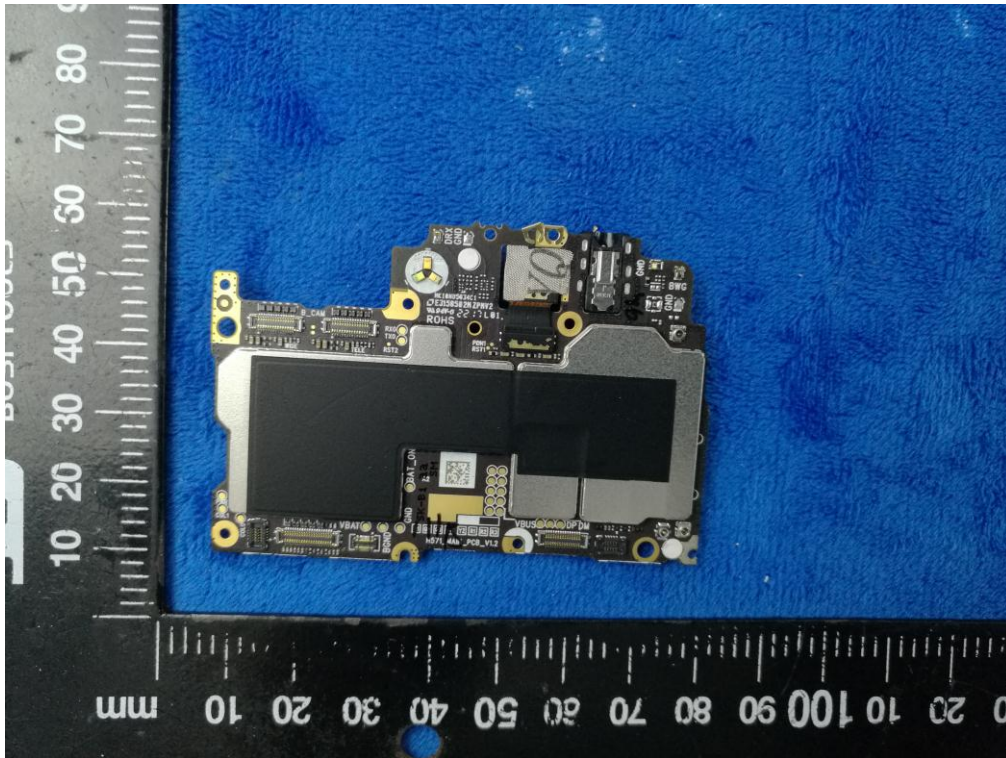

Mainboard without Shielding - Front View

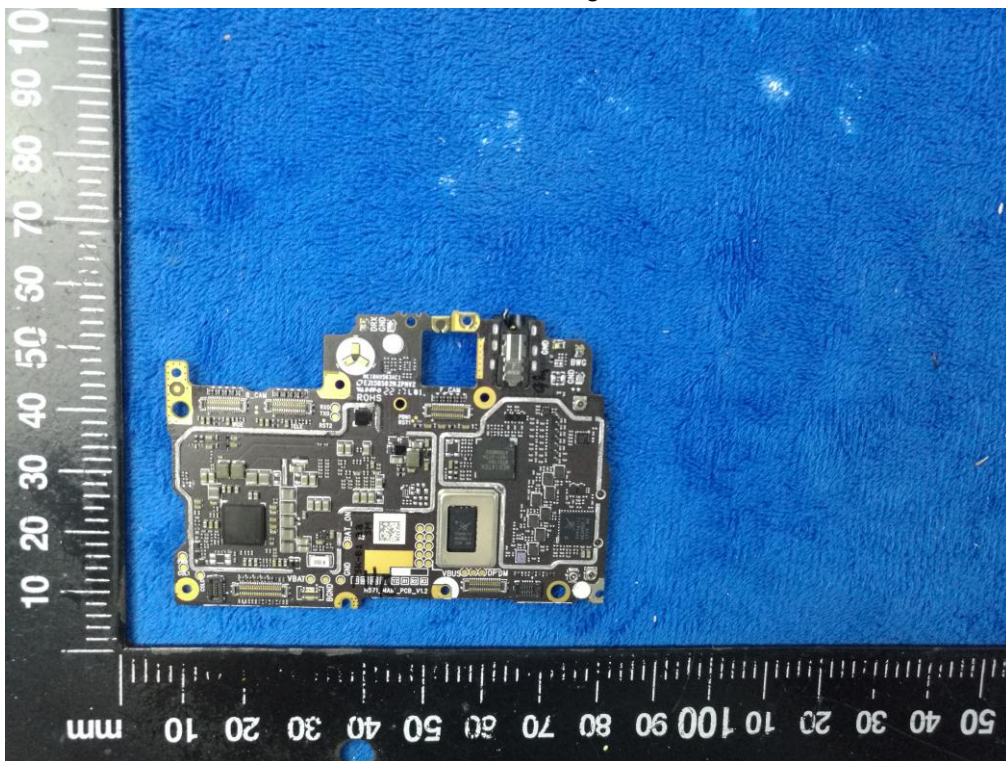

Mainboard with Shielding- Rear View

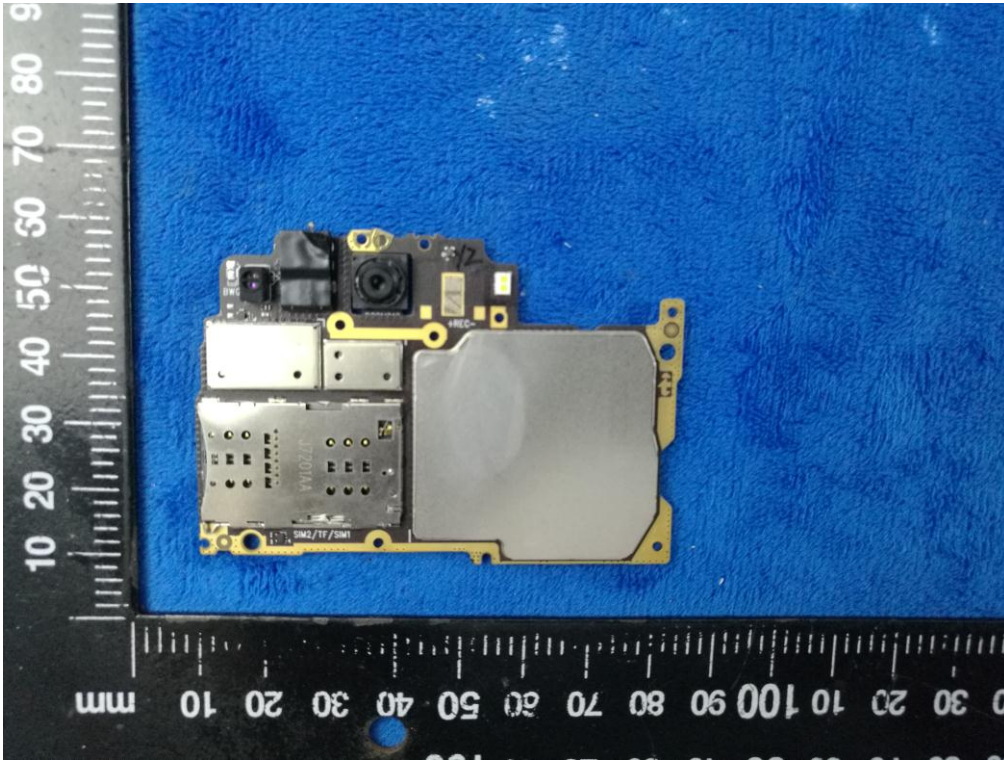

Mainboard without Shielding- Rear View

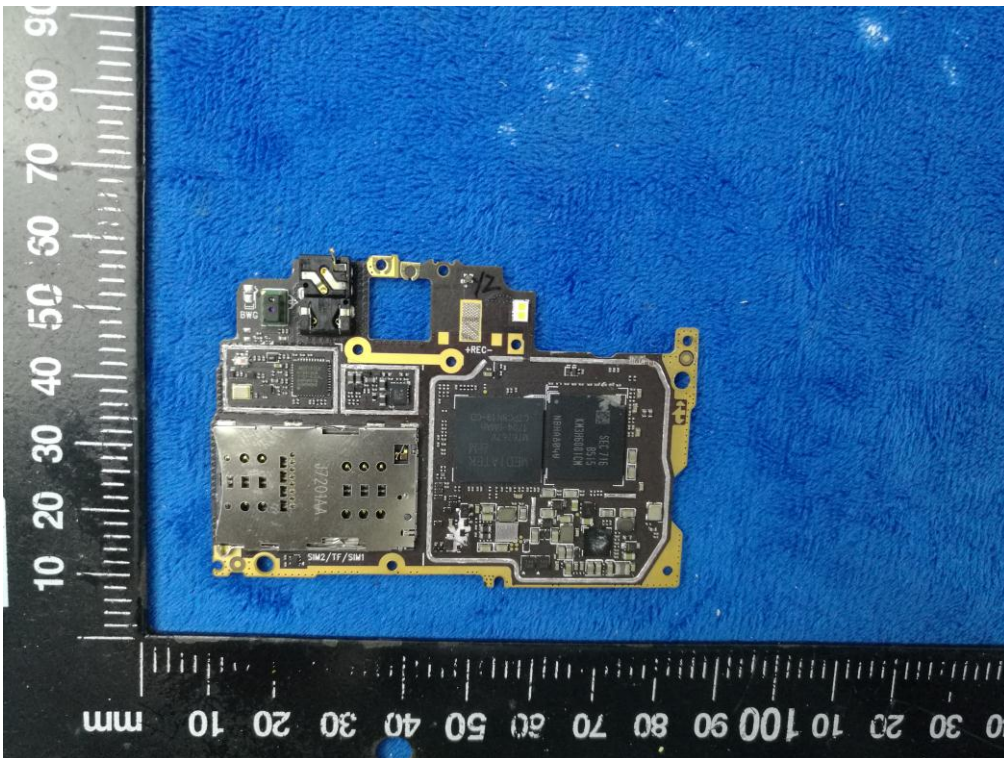

LCD – Front View



LCD – Rear View

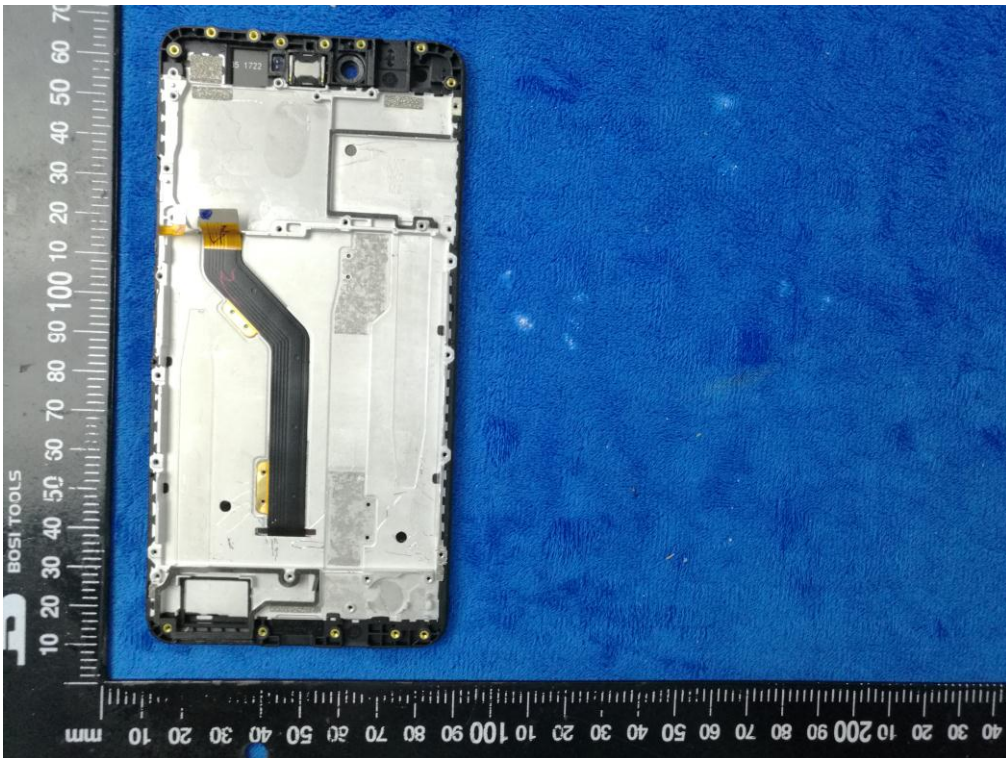

GSM/PCS/UMTS-FDD Antenna View

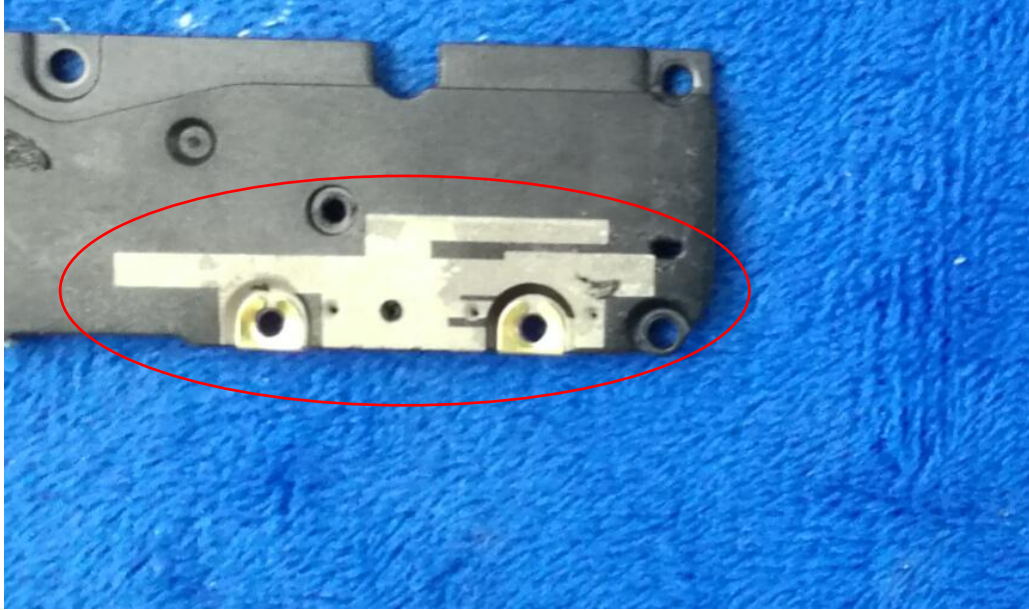

2.4WIFI/5G WIFI/BT/BLE/GPS - Antenna View



LTE - Antenna View



Annex B.iii. Photograph: Test Setup Photo



Conducted Emissions Test Setup Front View



Conducted Emissions Test Setup Side View

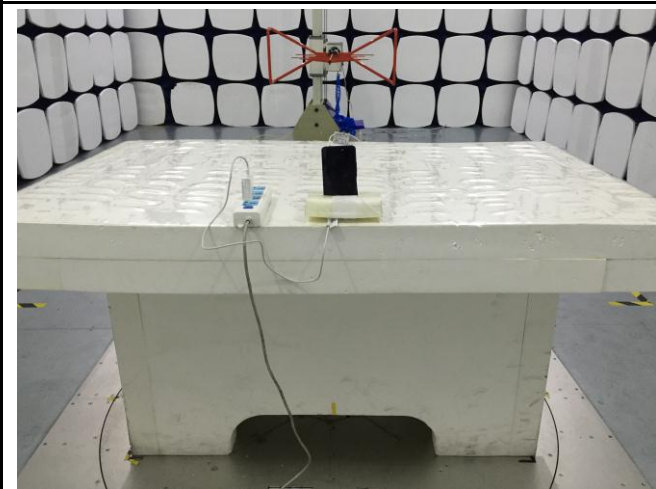

Radiated Spurious Emissions Test Setup Below 1GHz

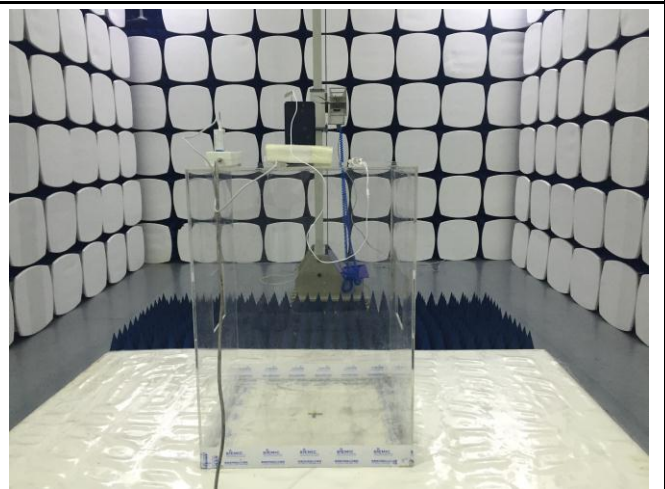

Radiated Spurious Emissions Test Setup Above 1GHz

Annex C. TEST SETUP AND SUPPORTING EQUIPMENT

Annex C.ii. TEST SET UP BLOCK

Block Configuration Diagram for AC Line Conducted Emissions

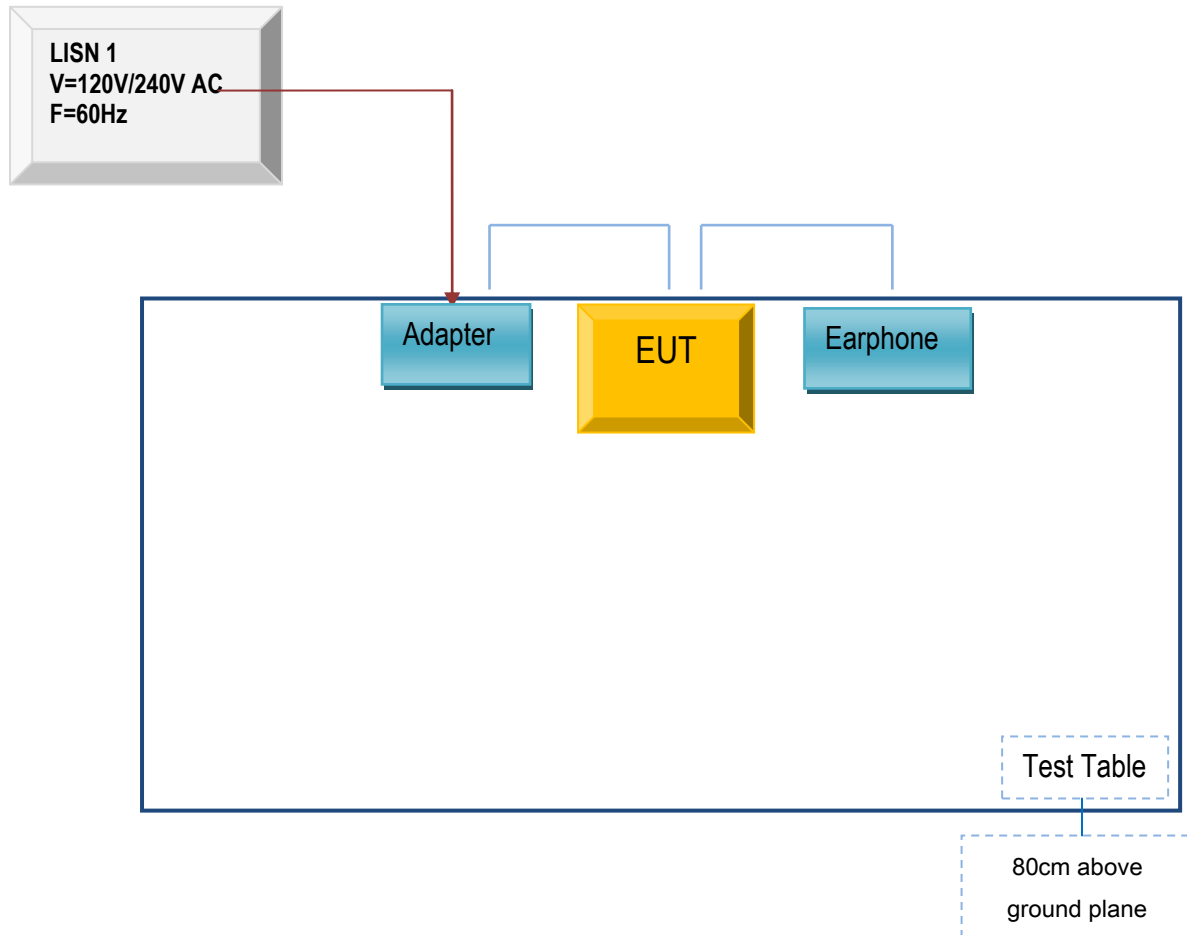

Block Configuration Diagram for Radiated Emissions (Below 1GHz) .

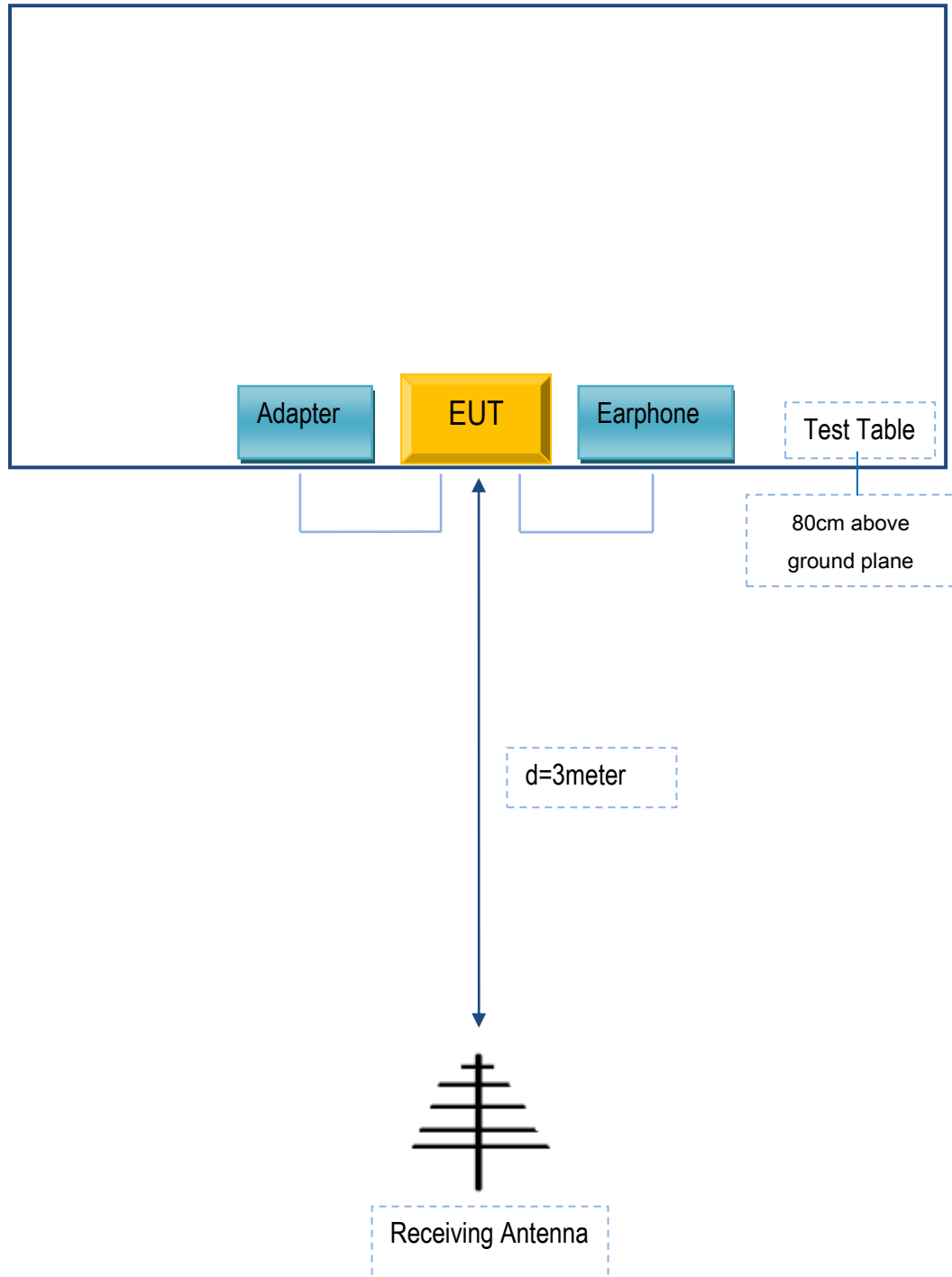

Block Configuration Diagram for Radiated Emissions (Above 1GHz) .

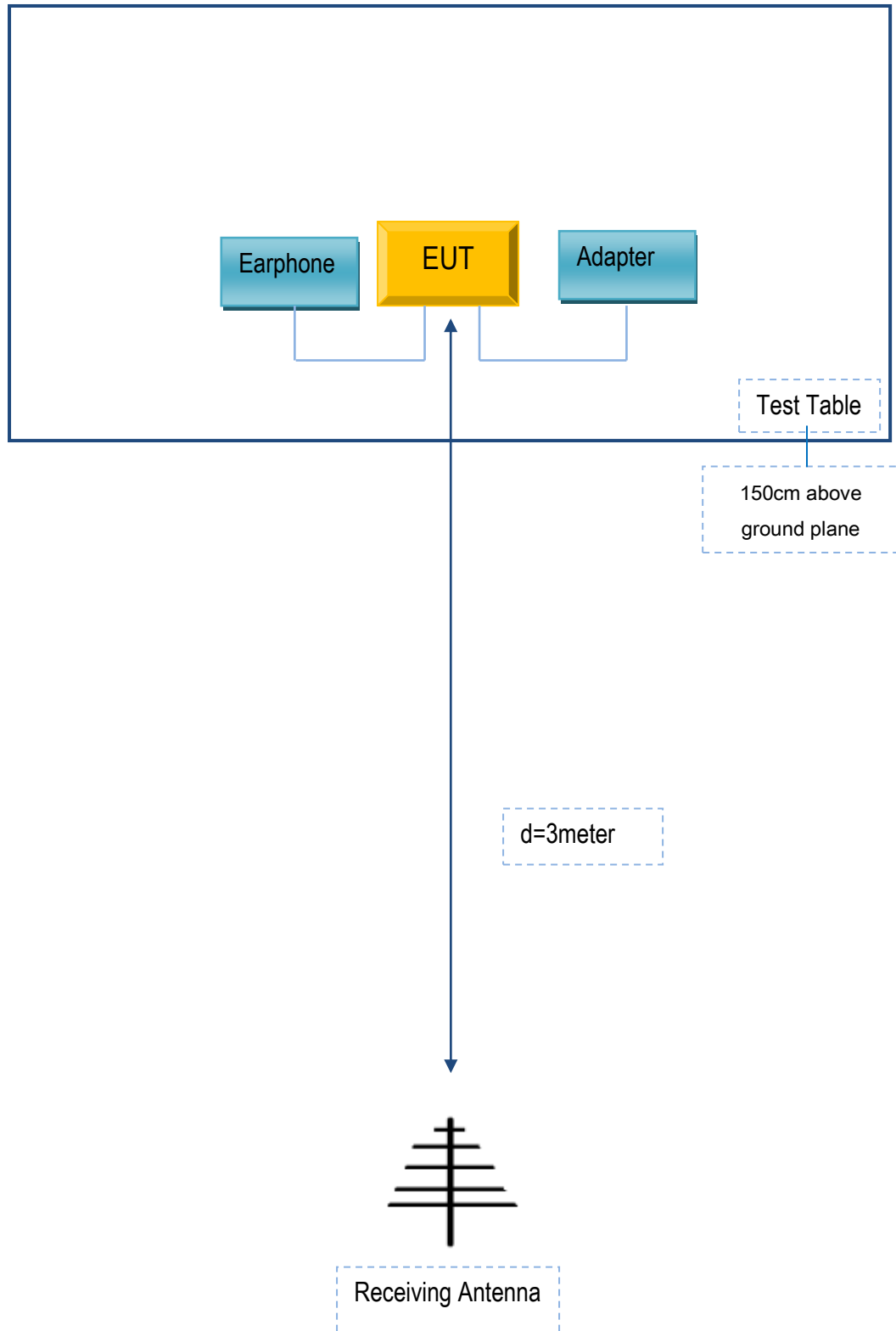

Annex C. ii. SUPPORTING EQUIPMENT DESCRIPTION

The following is a description of supporting equipment and details of cables used with the EUT.

Supporting Equipment:

Manufacturer	Equipment Description	Model	Serial No
TECNO MOBILE LIMITED	Adapter	CQ-18KX	N/A
TECNO MOBILE LIMITED	Earphone	AX8	N/A

Supporting Cable:

Cable type	Shield Type	Ferrite Core	Length	Serial No
USB Cable	Un-shielding	No	0.8m	N/A

Test Report No.	17070659-FCC-R2
Page	63 of 64

Annex D. User Manual / Block Diagram / Schematics / Partlist

Please see the attachment

Test Report No.	17070659-FCC-R2
Page	64 of 64

Annex E. DECLARATION OF SIMILARITY

N/A