

Feature

Manufacture

name:深圳市威尔创通讯科技有限公司

Shenzhen Wei'erchuang Communication Technology Co.,Ltd.

address:深圳市龙华区大浪街道大浪社区同富邨工业区第 8 栋 1-3 层,

Building 8, Tongfu Estate Industrial Zone, Dalang Community, Dalang Street, Longhua District, Shenzhen

Model:

AD10-ANT2/3/4/5/6

- ※ High gain
- ※ Omani-directional
- ※ Wide bandwidth

Application

※ GSM850/900/DCS/PCS/WCDMA B1/B2/B4/B5/B8
LTE B1/B2/B3/B4/B5/B7/B8/B20/B28/B38/B40/B41/B66
N1/3/5/7/8/20/28/66/71/38/40/41/71/77/78/79

GPS/WIFI/BT
communication applications

TYPE	
Transmitter Frequency	GSM 850/WCDMA B5/LTE B5: 824 – 849 MHz
	GSM 900/WCDMA B8/LTE B8: 880 – 915 MHz
	DCS /WCDMA B4/LTE B3/B4/B66: 1710 – 1785 MHz
	PCS/WCDMA B2/LTE B2:1850-1910MHz
	WCDMA B1/LTE B1: 1920 – 1980MHz
	LTE B7:2496-2565MHz
	LTE B40:2300-2400MHz
	LTE B38/B41:2565-2645MHz
	LTE B20:832-862MHz
LTE B28:710-755MHz	
Receiver Frequency	GSM 850/WCDMA B5/LTE B5: 869 – 894 MHz

	GSM 900/WCDMA B8/LTE B8: 925 – 960 MHz
	DCS/LTE B3/B66: 1805 – 1880 MHz
	WCDMA 4/LTE B4: 2110-2155 MHz
	PCS/WCDMA B2/LTE B2:1930-1990MHz
	WCDMA B1/LTE B1: 2110 – 2170MHz
	LTE B7:2620-2690MHz
	LTE B40:2300-2400MHz
	LTE B38/41:2565-2645MHz
	LTE B20:791-821MHz
	LTE B17/B28:758-803MHz
RF-Output Power (E.I.R.P)	GSM850/900: 32+/-2dBm
	DCS/PCS: 30+/-2dBm
	LTE B1/B2/B3/ B4/B5 /B7/B8/B20/B28/B38/B40/B41/B66: 23+/-2dBm
	WCDMA B1/B2/B4/B5/ B8: 23+/-2dBm
Main Antenna Gain - Unfold(Peak Gain)	GSM 850/WCDMA B5/LTE B5/B20/ NR N5/N20 PRX: -5.3
	GSM 900/WCDMA B8/LTE B8/ NR N5 PRX: -3
	DPDT SWAP:GSM 850/WCDMA B5/LTE B5/NR N5/N20 DRX: -8.75
	DPDT SWAP:GSM 900/WCDMA B8/LTE B8/NR N8 DRX: -11.11
	DCS/WCDMA B4/ LTE B3/B4/B66/NR N3/N66 PRX: 0.07
	PCS/WCDMA B2/LTE B2/NR N2 PRX: -0.05
	WCDMA B1/LTE B1NR /N1 PRX: -1.57
	LTE B7/NR N7 PRX: -1.8
	DPDT SWAP:LTE B20/N20: -8
	DPDT SWAP:LTE B17/B28 NR N28 DRX: -9.18
	DPDT SWAP:NR N71 DRX: -12.37
	LTE B38/B41: -2.68
	EN-DC B41:-1.8
	LTE B40 NR N40: -1.78
	LTE B28 N28: :-4.3
	N71:-4.9
	N1 DRX:-3.2
N3/N66 DRX: :-9	
Main Antenna Gain - Fold(Peak Gain)	GSM 850/WCDMA B5/LTE B5/B20/NR N5/N20 PRX: -7.2
	GSM 900/WCDMA B8/LTE B8/ NR N8 PRX: -7.1
	DPDT SWAP:GSM 850/WCDMA B5/LTE B5/NR N5 DRX: -10.96
	DPDT SWAP:GSM 900/WCDMA B8/NR N8 DRX: -13.53
	DCS/WCDMA B4/ LTE B3/B4/B66/NR N3/N66 PRX: -1.32
	PCS/WCDMA B2/LTE B2/NR N2 PRX: -1.73
	WCDMA B1/LTE B1N1 PRX: -4.94
	LTE B7/NR N7 PRX: -4.15
	DPDT SWAP:LTE B20/N20: -10.72
	DPDT SWAP:LTE B17/B28 NR N28 DRX: -11.3
	DPDT SWAP:NR n71 DRX: -14.15
	LTE B38/B41 NR N38/41: -3.3
	EN-DC B41:-4.15
LTE B40 NR N40: -3.81	

	LTE B28 N28: -6.5
	N71:-6.3
	N1 DRX:-3
	N3/N66 DRX:-10
GPS&WIFI 2.4G MIMO 0 Antenna Gain unfold (Peak Gain)	GPS:-2.5 WIFI 2.4G:-2.3
GPS&WIFI 2.4G MIMO 0 Antenna Gain fold (Peak Gain)	GPS:-3.1 WIFI 2.4G:-3.2
WIFI 5G MIMO 1 Antenna Gain- Unfold (Peak Gain)	WIFI 2.4G:-1.5
WIFI 5G MIMO 1 Antenna Gain- Fold (Peak Gain)	WIFI 2.4G:-2
SUB 6G PRX Antenna Gain Unfold (Peak Gain)	N40: -1.78 N38/41: -2.68 N77/N78: -0.6 N79: -4.32
SUB 6G PRX Antenna Gain Fold (Peak Gain)	N40: -3.81 N38/41: -3.3 N77/N78: -1.49 N79: -3.79
SUB 6G DRX1 Antenna Gain Unfold (Peak Gain)	N77/N78:-7.37 N79:-7.27 N38/41:-2.8 N40:-7.7
SUB 6G DRX2 Antenna Gain Unfold (Peak Gain)	N38:-4.26 N40:-2.48 N41: -4.39 N77/N78:-1.5 N79:-1.27
SUB 6G DRX3 Antenna Gain Unfold (Peak Gain)	N38/41:-4.3 N40:-3.6 N77/78:-3.2 N79:-5.3
SUB 6G DRX1 Antenna Gain fold (Peak Gain)	N77/N78:-7.37 N79:-7.27 N38/41:-7.3 N40:-2.6
SUB 6G DRX2 Antenna Gain fold (Peak Gain)	N38:-4.94 N40:-5.48 N41: -5.46 N77/N78:-3.6 N79: -1.27
SUB 6G DRX3 Antenna Gain fold (Peak Gain)	N1:-3 N3:-10 N38/41:-5.5

	<p>N40:-5.6 N77/78:-4.2 N79:</p>
<p>LDS1- 5G WIFI MIMO0 Antenna Gain fold&unfold(Peak Gain)</p>	<p>WIFI 5G:-0.62</p>
<p>LDS2-5G WIFI MIMO1 Antenna Gain fold&unfold(Peak Gain)</p>	<p>WIFI 5G:2.75</p>

※ Antenna Gain

4G&5G Main Antenna

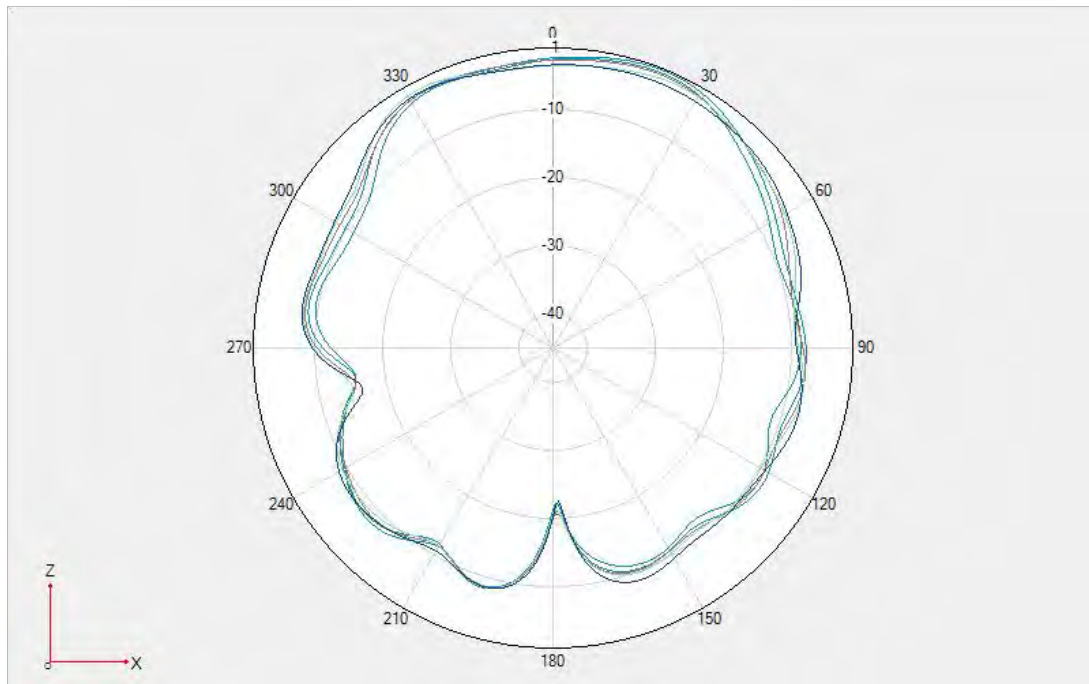

Unfold- LTE B40/N40 Phi=0deg

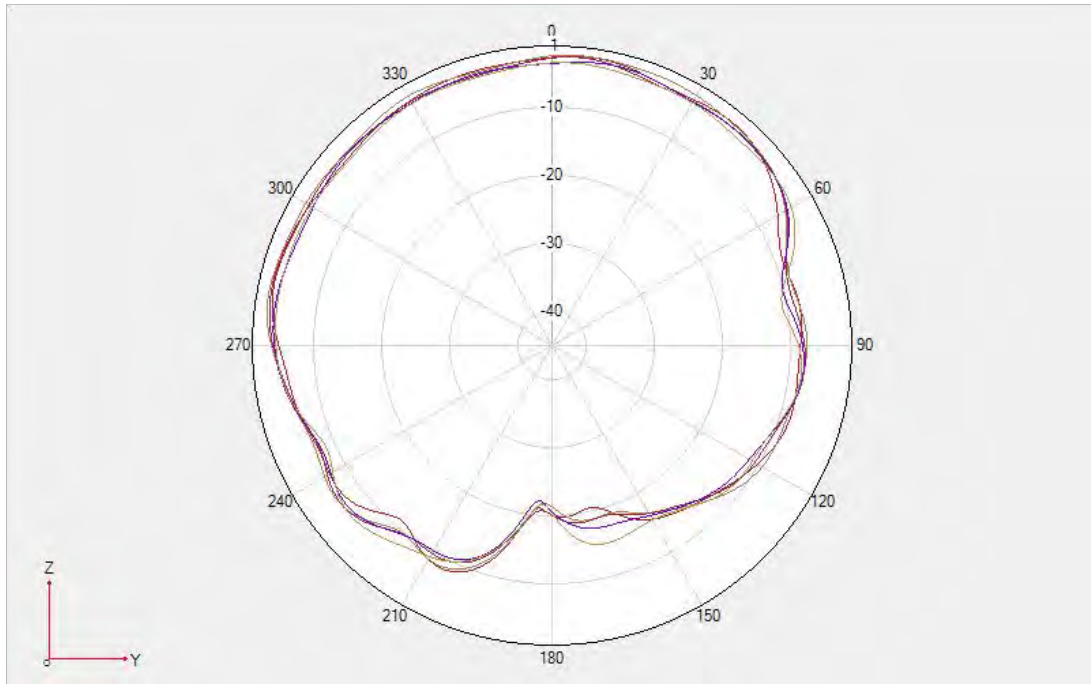

Unfold- LTE B40/N40 $\Phi=90\text{deg}$

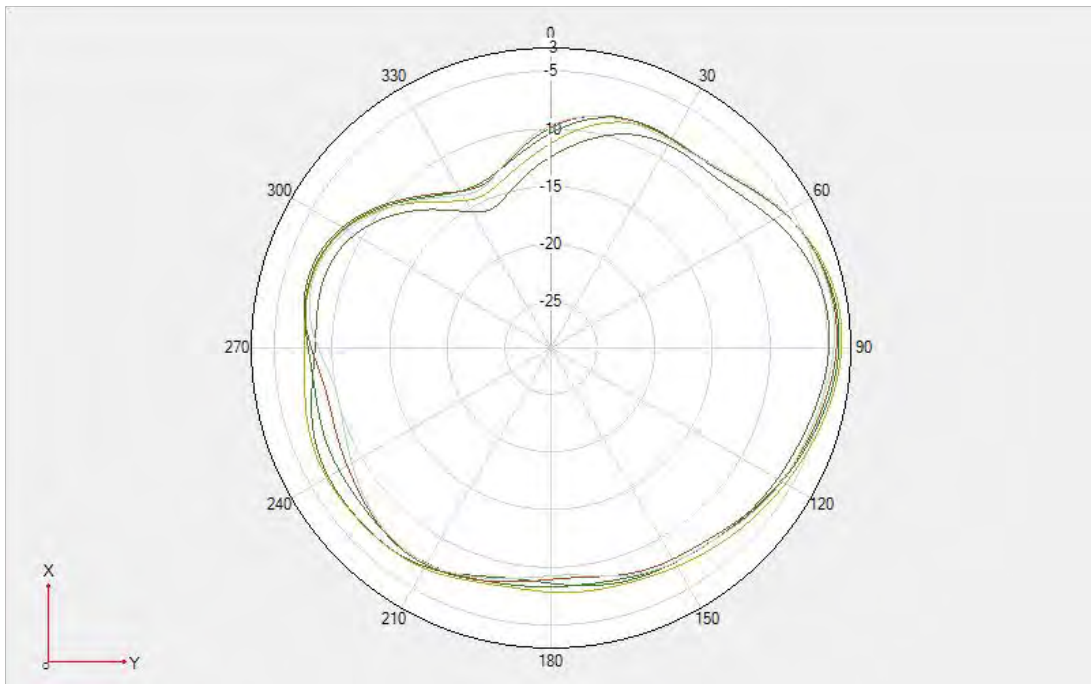

Unfold- LTE B40/N40 $\Theta=90\text{deg}$

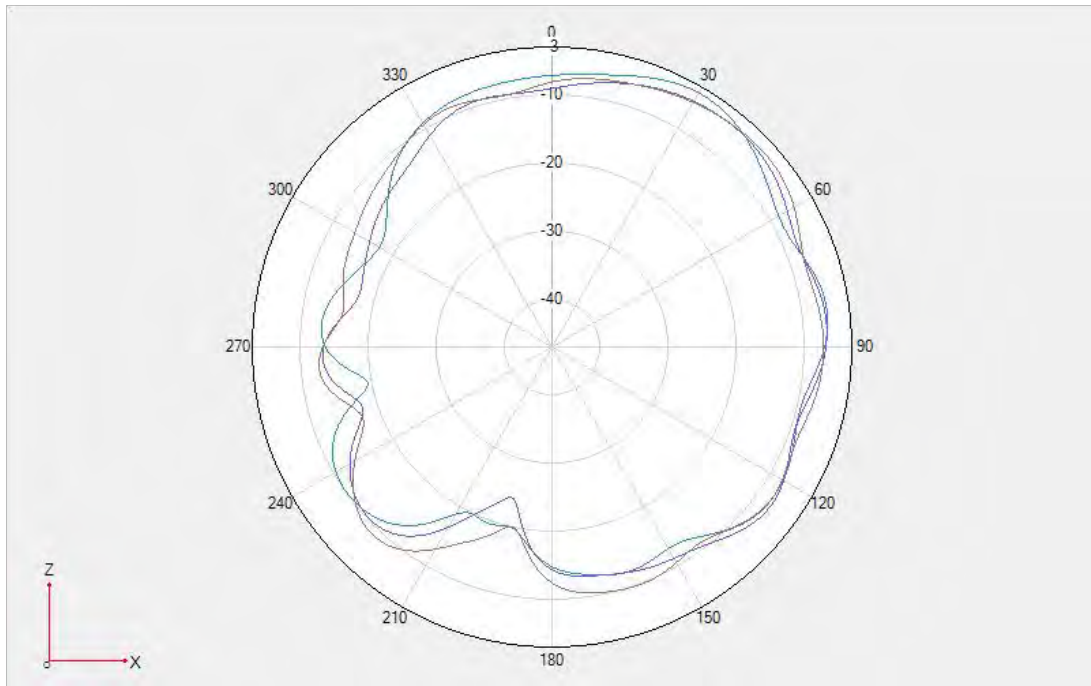

Fold- LTE B40/N40 $\Phi=0^\circ$

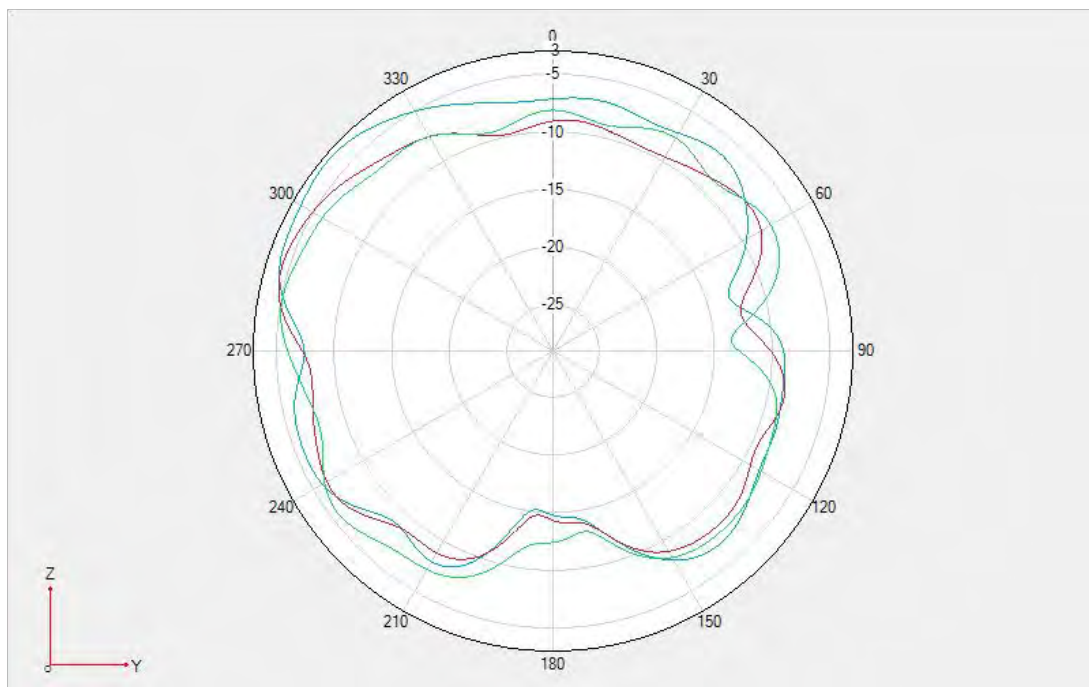

Fold- LTE B40/N40 $\Phi=90^\circ$

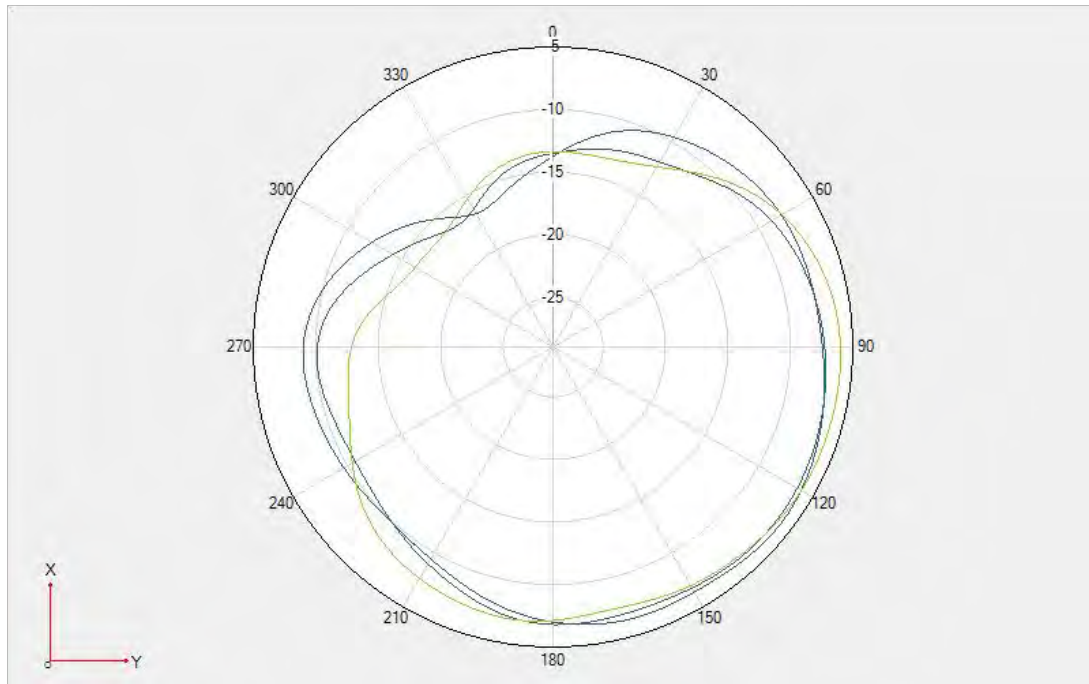

Fold- LTE B40/N40 Theta=90deg

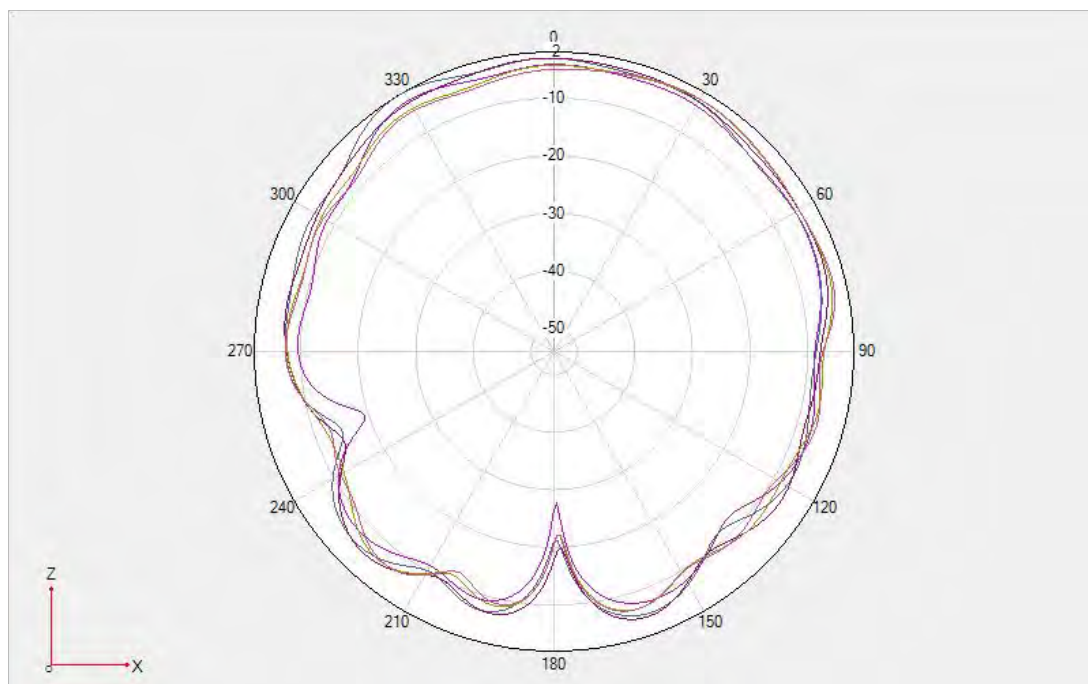

Unfold- LTE B38/41/ N38/41 Phi=0deg

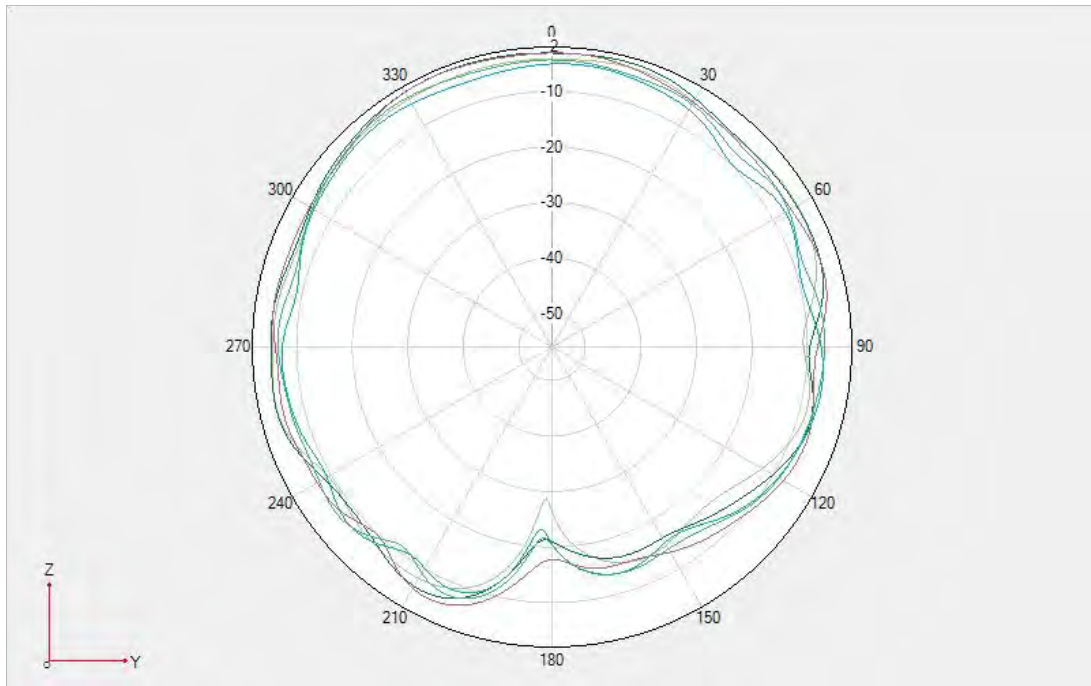

Unfold- LTE B38/41 N38/41 $\Phi=90^\circ$

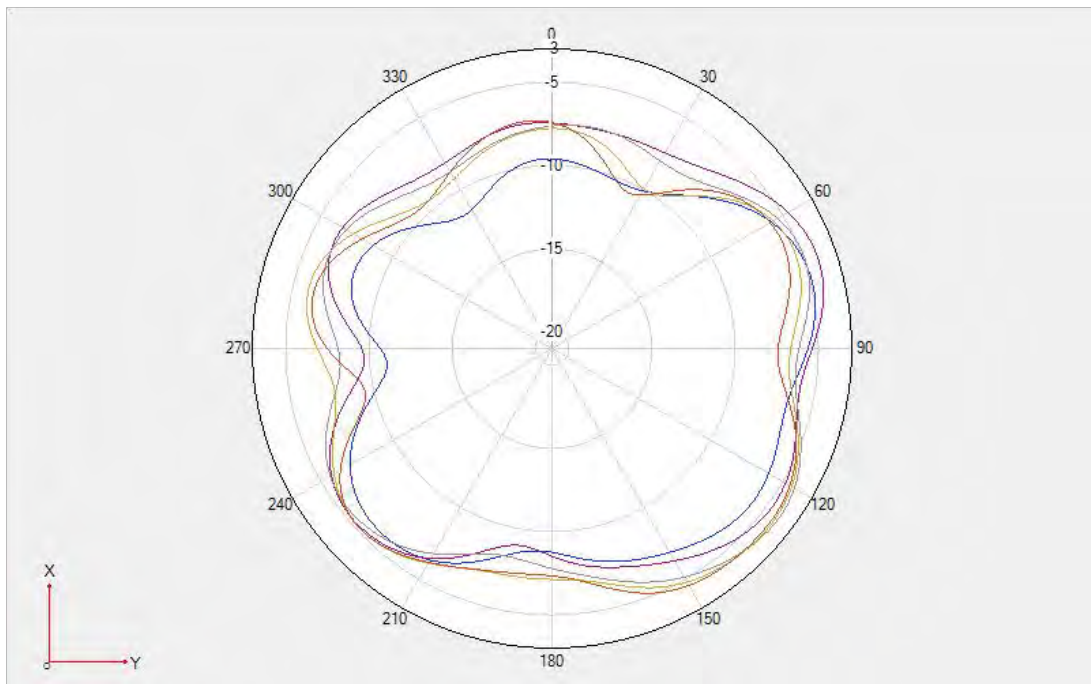

Unfold- LTE B38/41 N38/41 $\Theta=90^\circ$

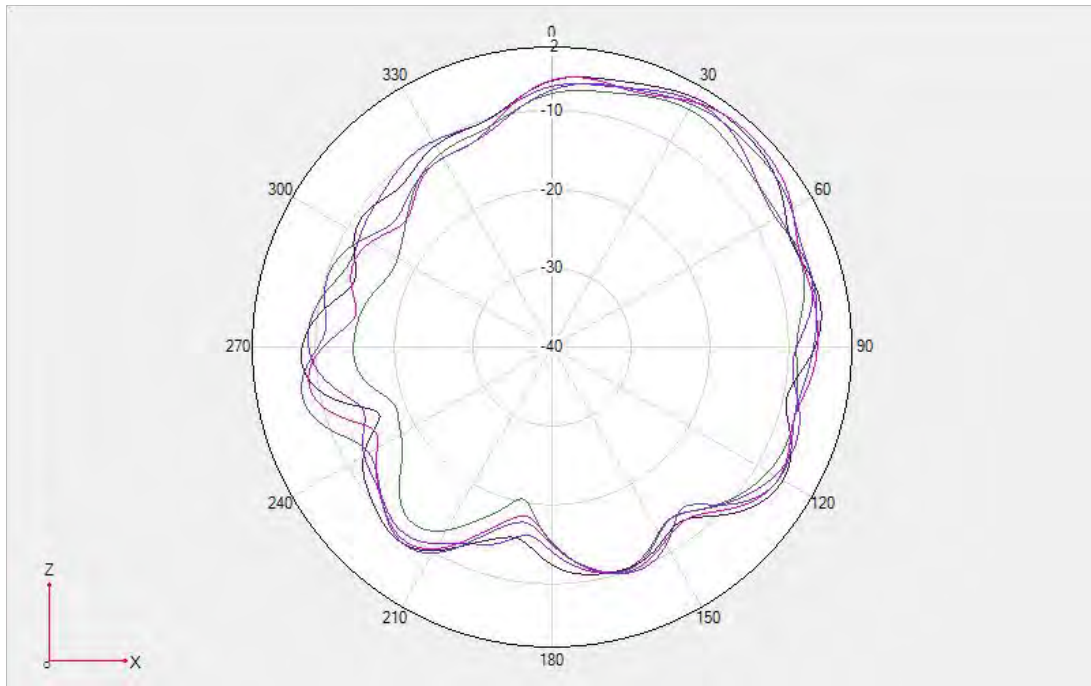

Fold- LTE B38/41/ N38/41 $\Phi=0^\circ$

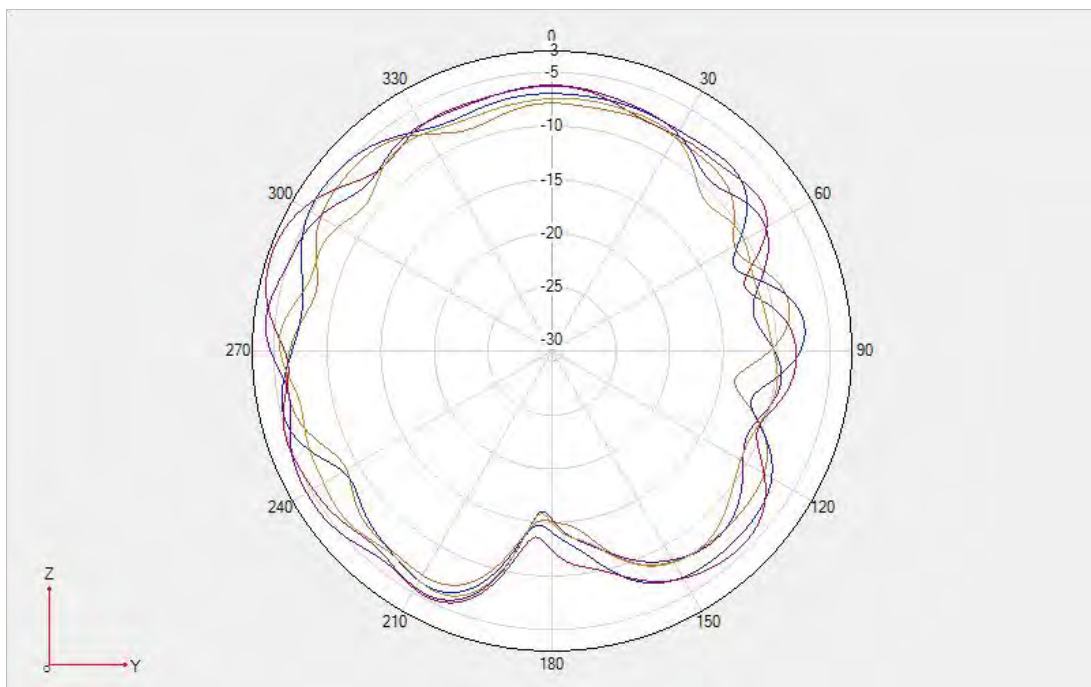

Fold- LTE B38/41 N38/41 $\Phi=90^\circ$

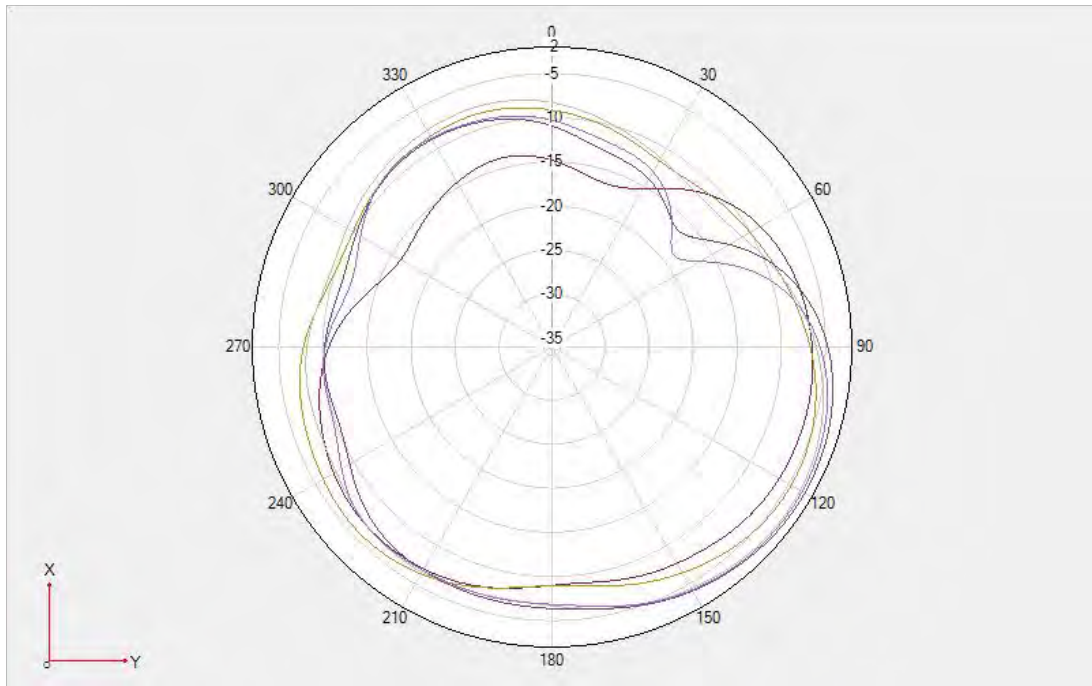

Fold- LTE B38/41 N38/41 Theta=90deg

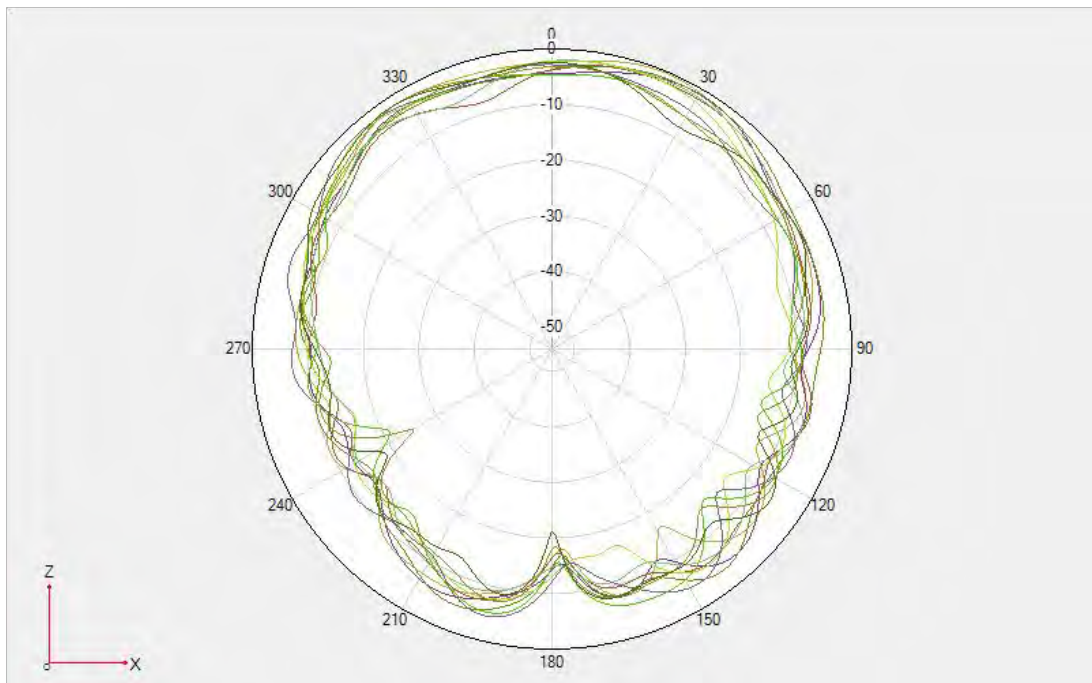

Unfold- N77/N78 Phi=0deg

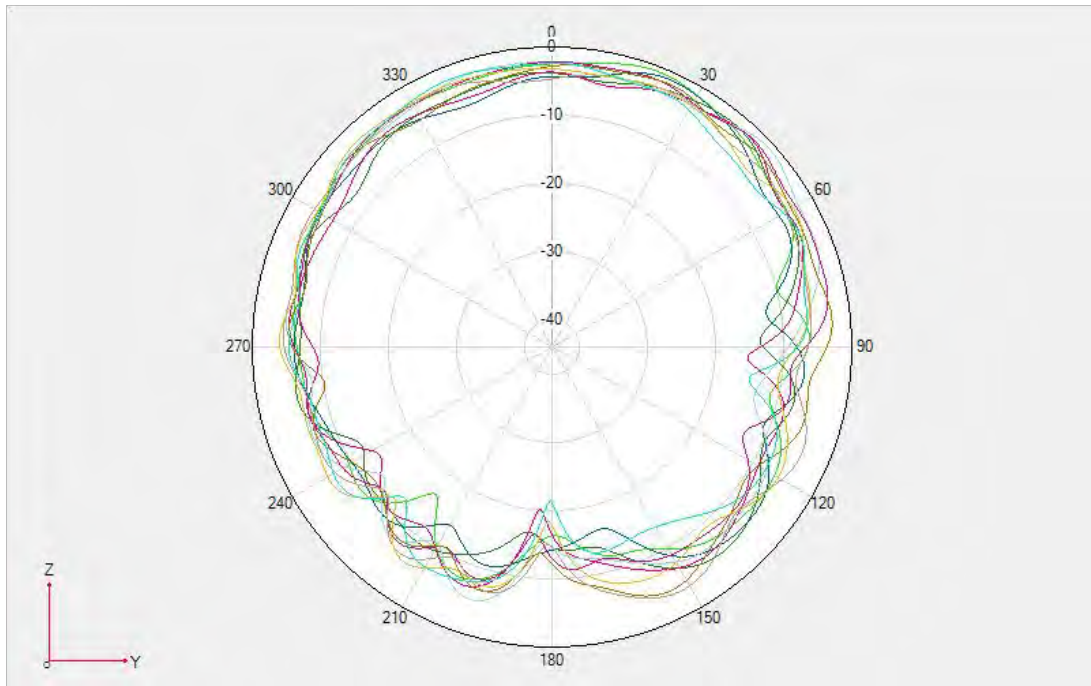

Unfold- N77/N78 $\Phi = 90^\circ$

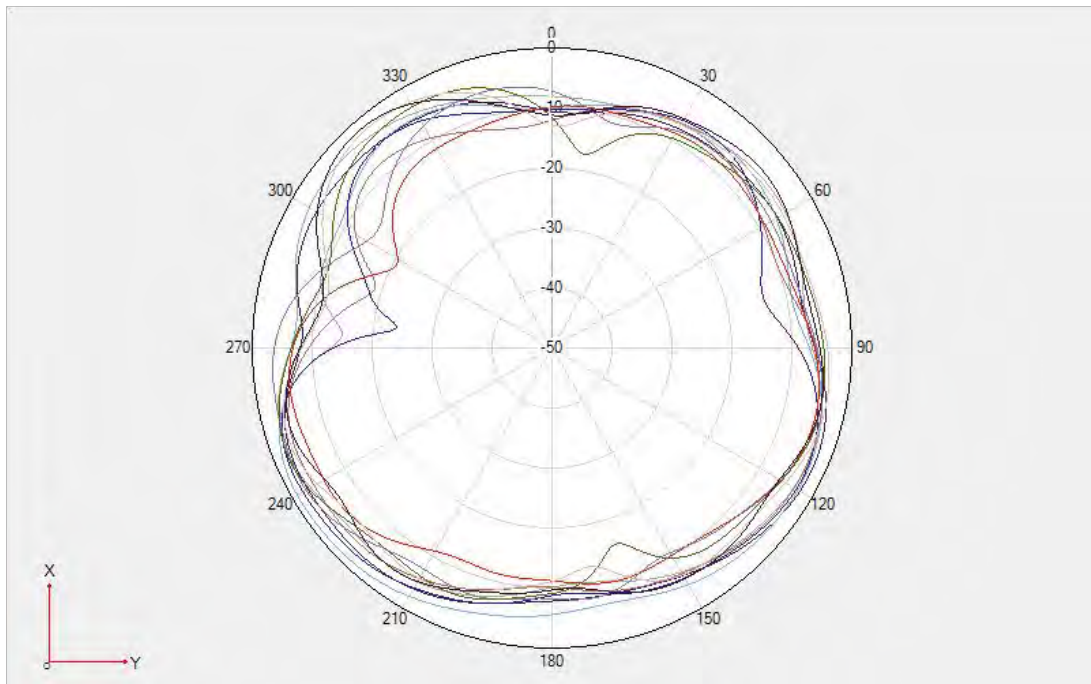

Unfold- N77/N78 $\Theta = 90^\circ$

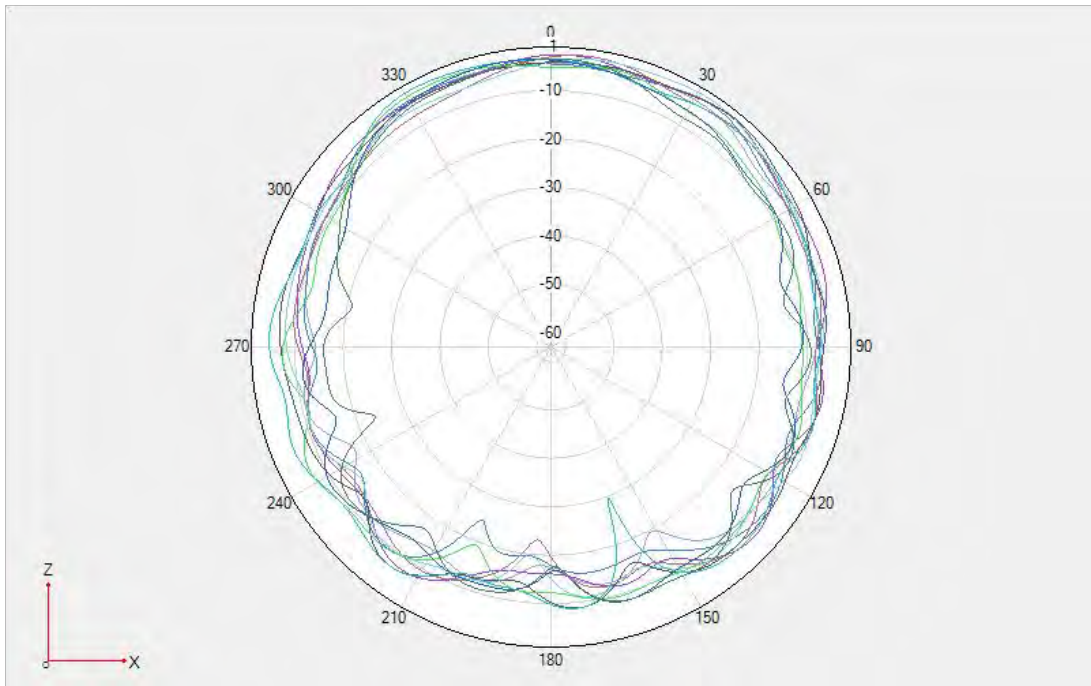

Fold- N77/N78 $\Phi=0\text{deg}$

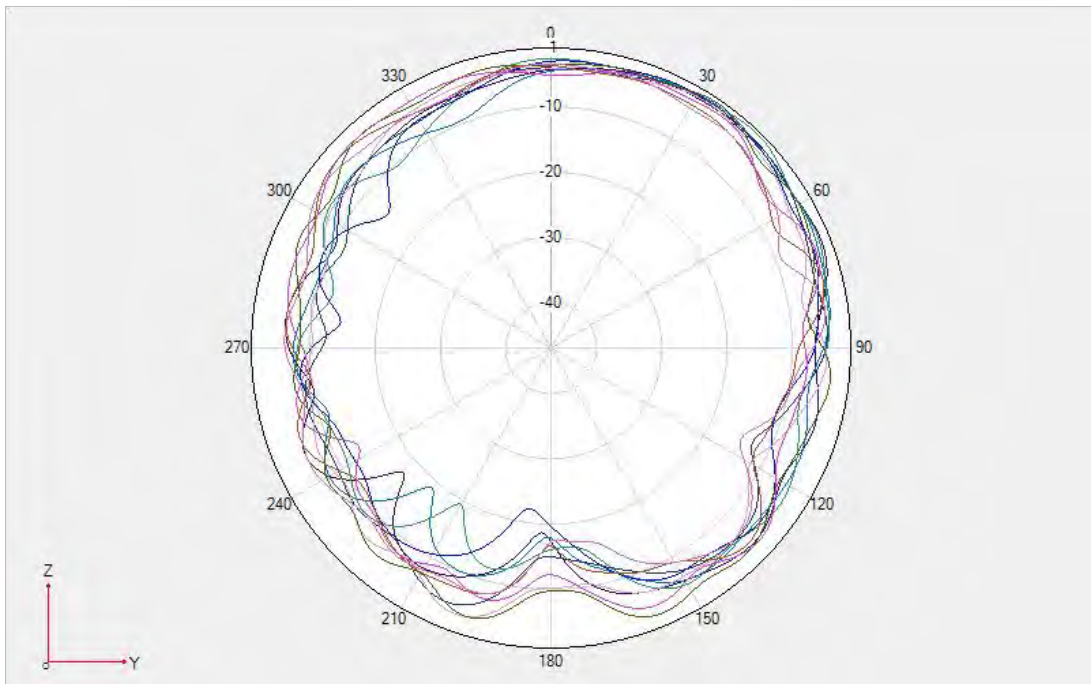

Fold- N77/N78 $\Phi=90\text{deg}$

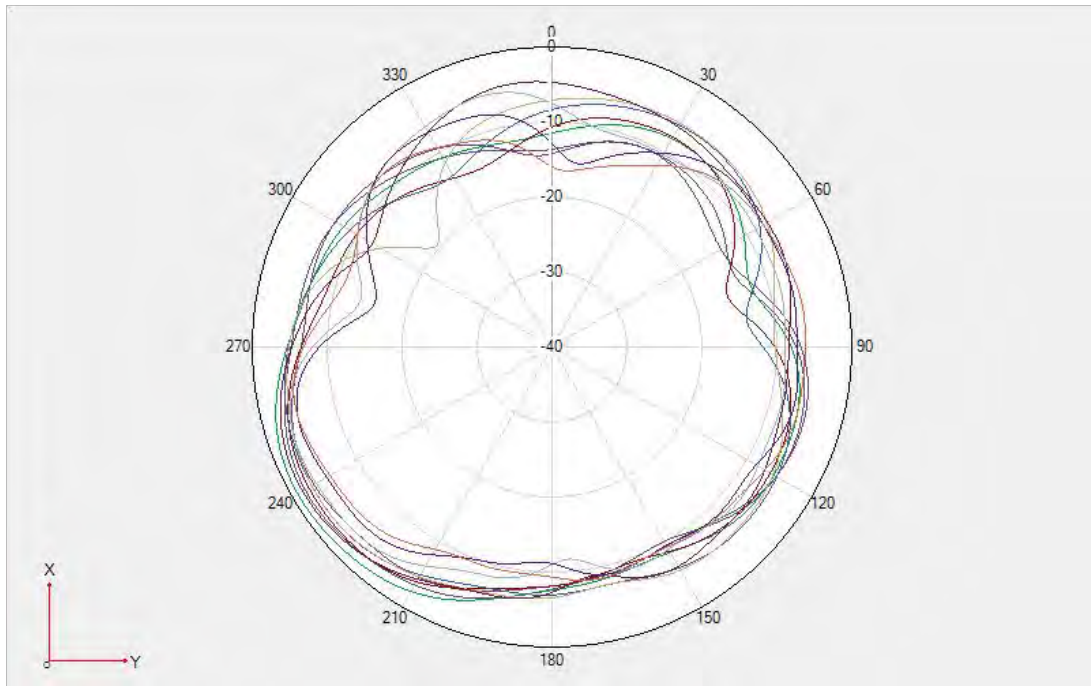

Fold- N77/N78 Theta=90deg

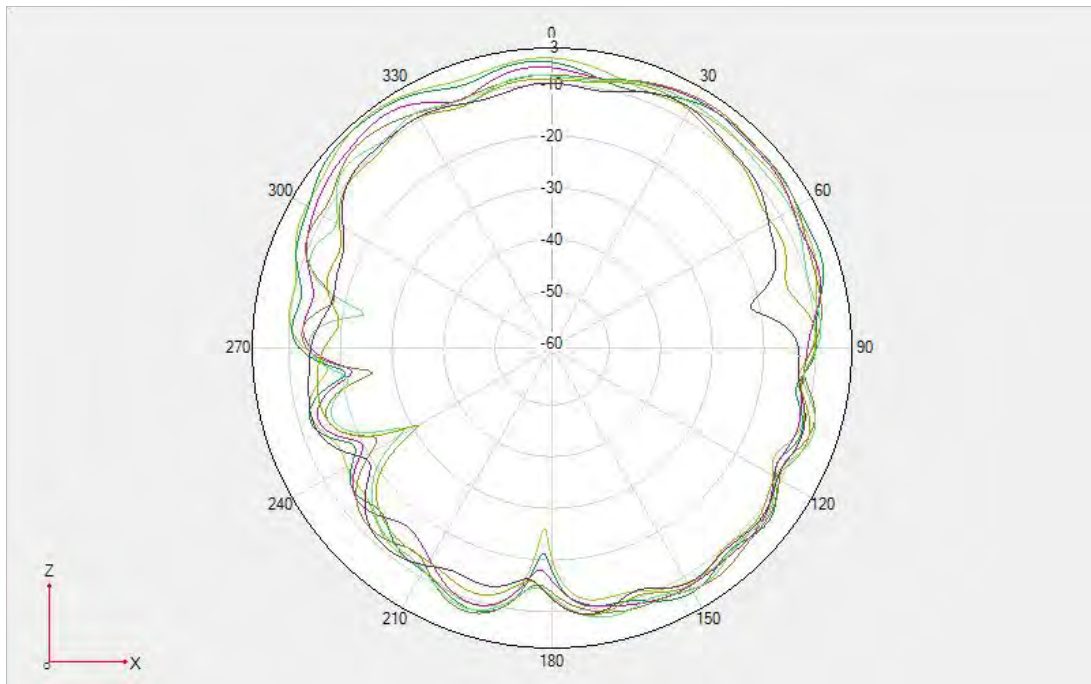

Unfold- N79 Phi=0deg

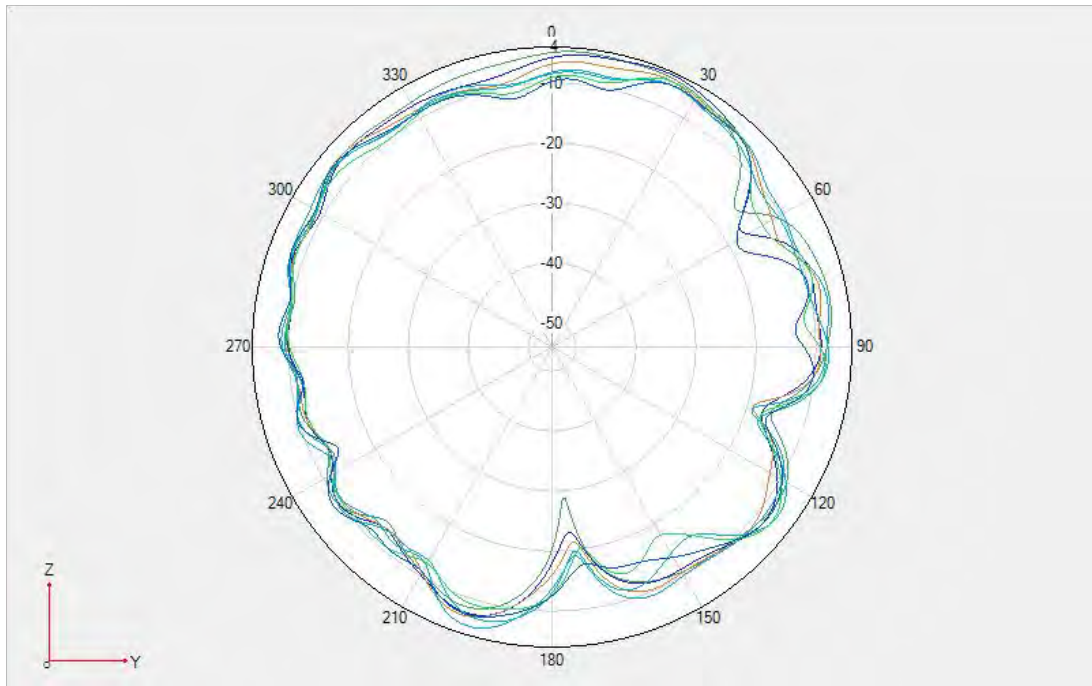

Unfold- N79 $\Phi=90\text{deg}$

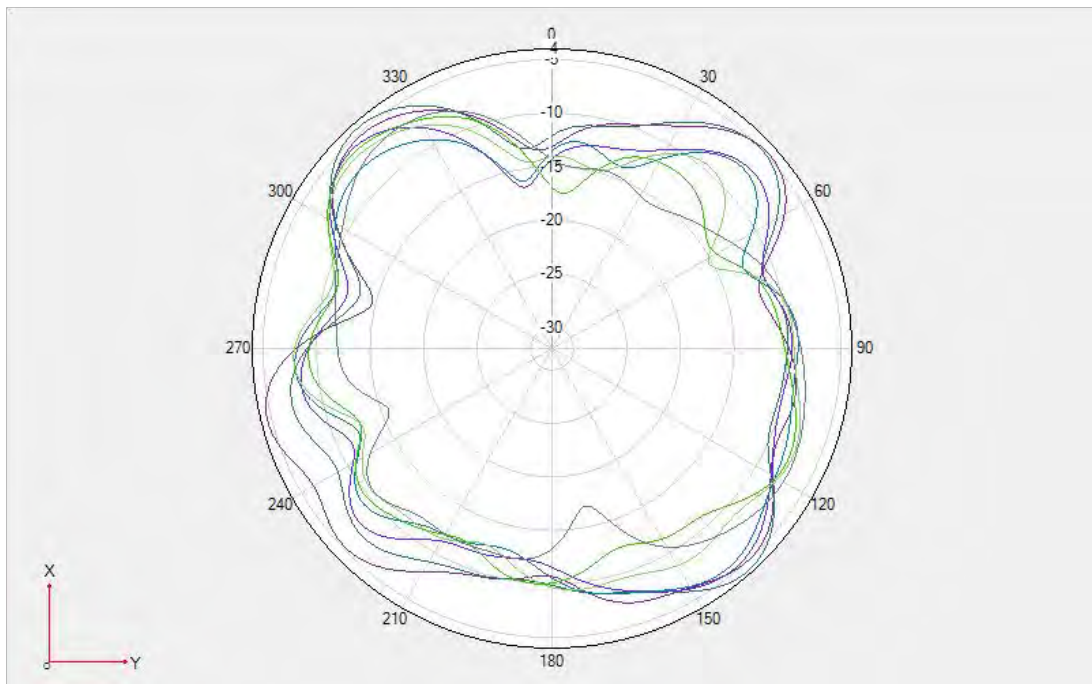

Unfold- N79 $\Theta=90\text{deg}$

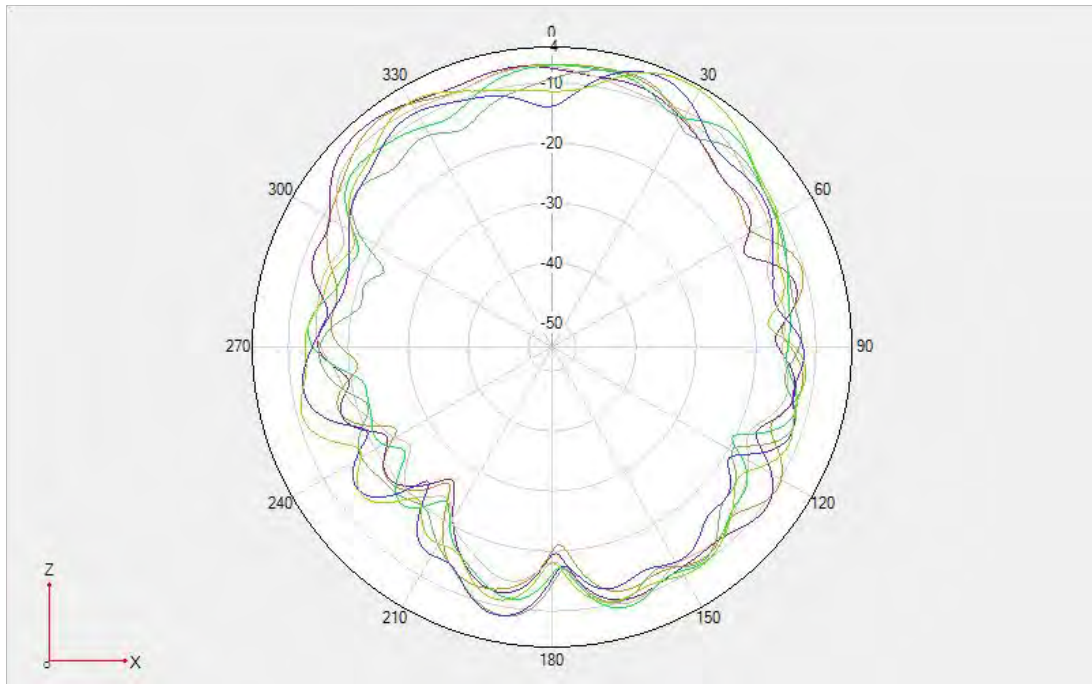

Fold- N79 $\Phi=0\text{deg}$

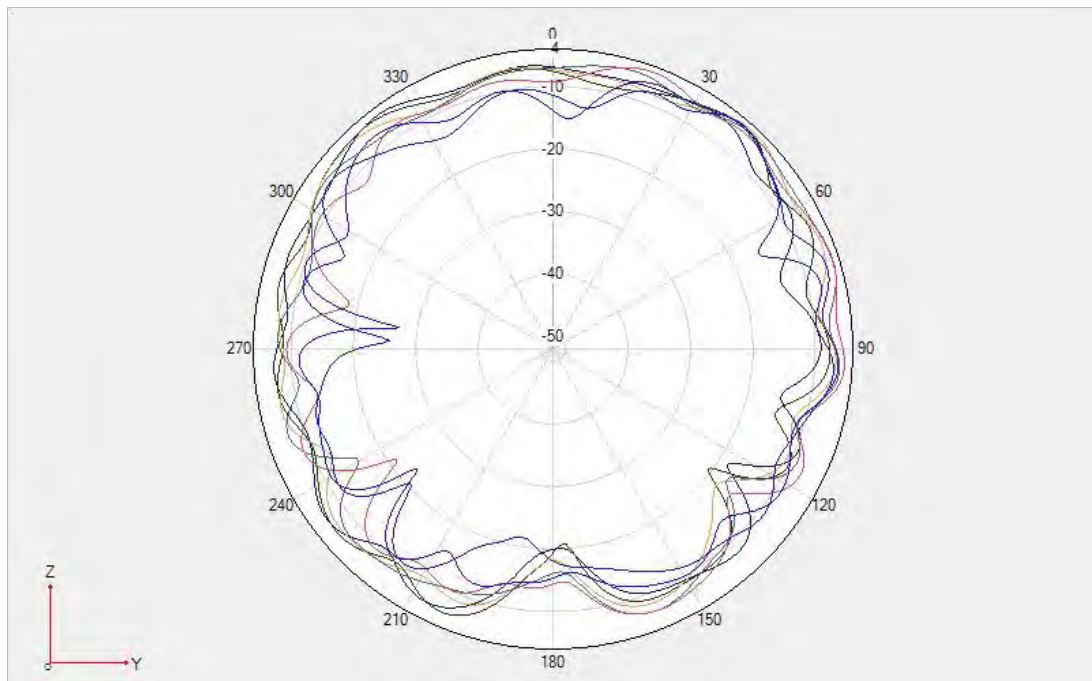

Fold- N79 $\Phi=90\text{deg}$

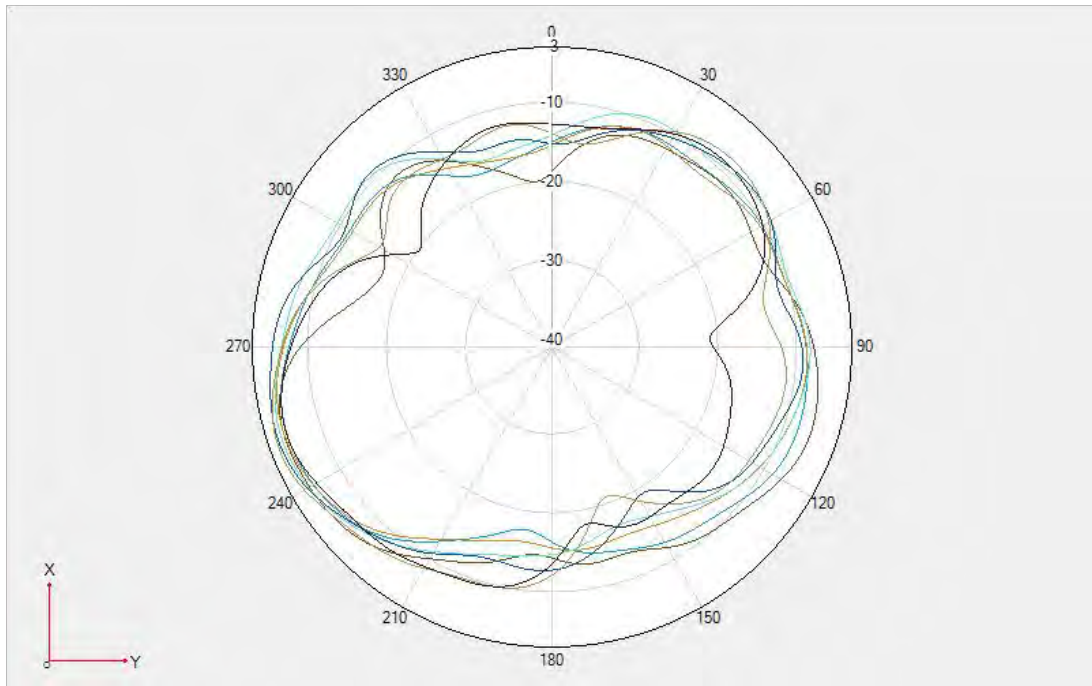

Fold- N79 Theta=90deg

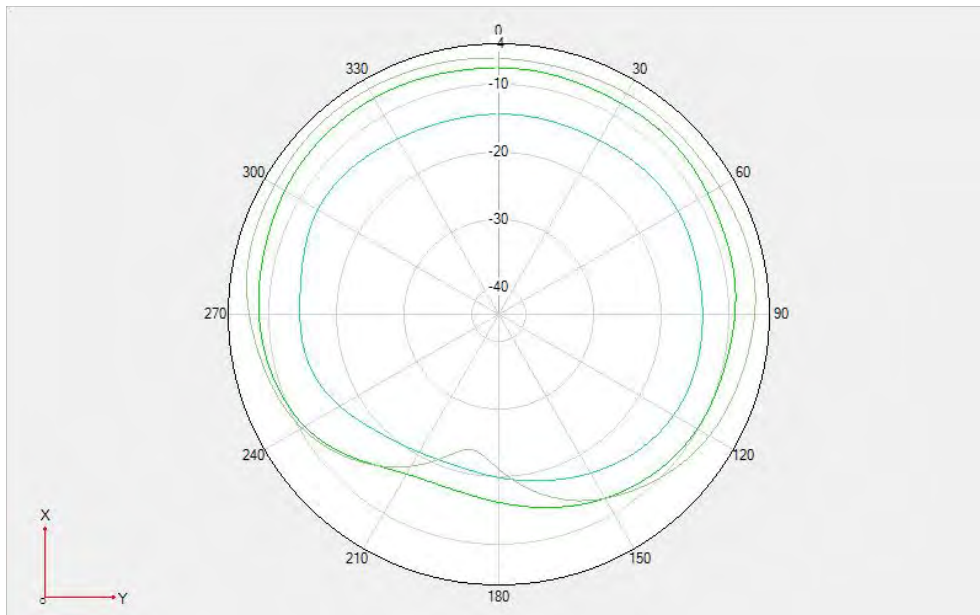

Unfold-N71 Theta=90deg

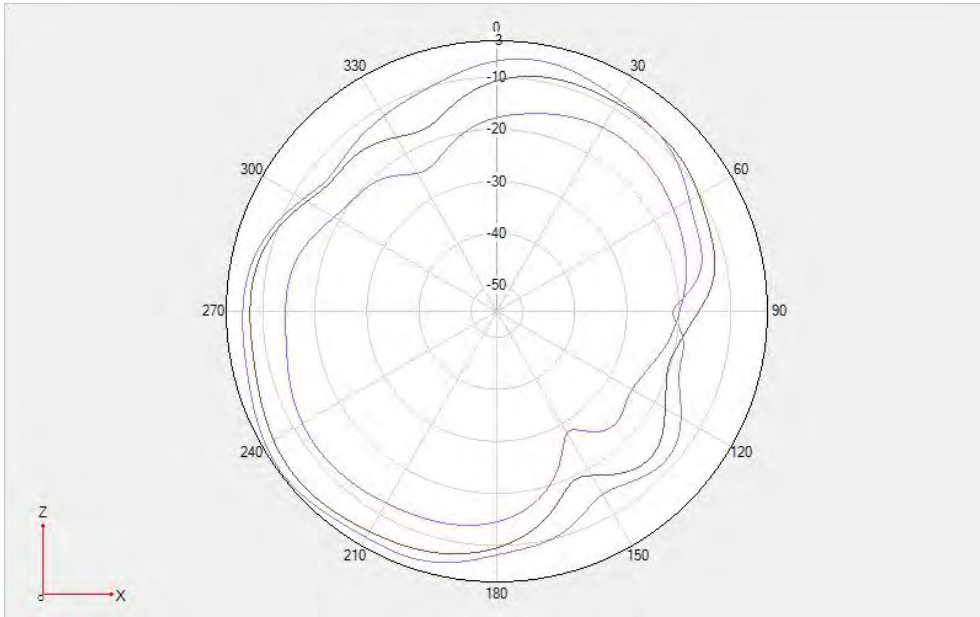

Unfold-N71 $\Phi=0^\circ$

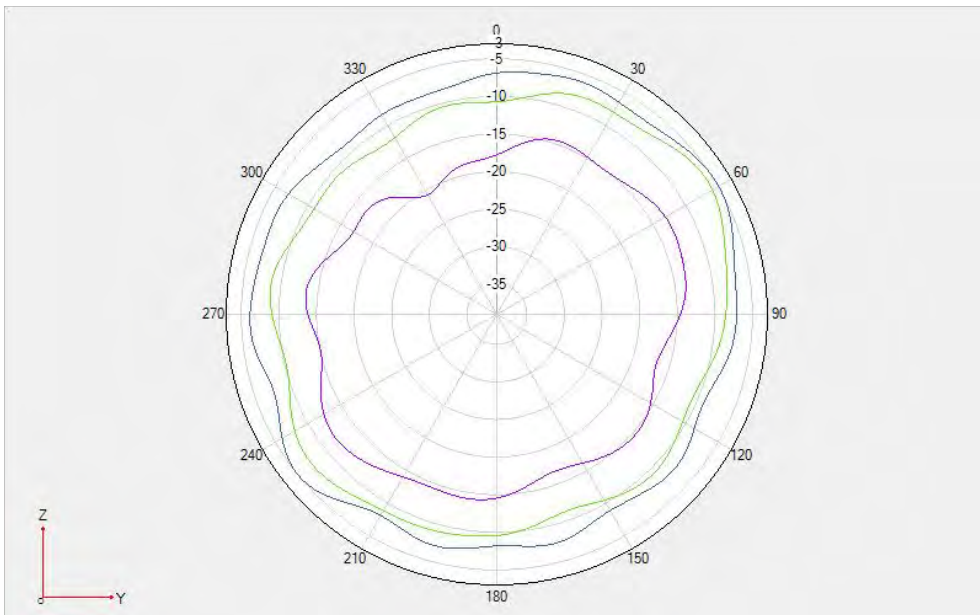

Unfold-N71 $\Phi=90^\circ$

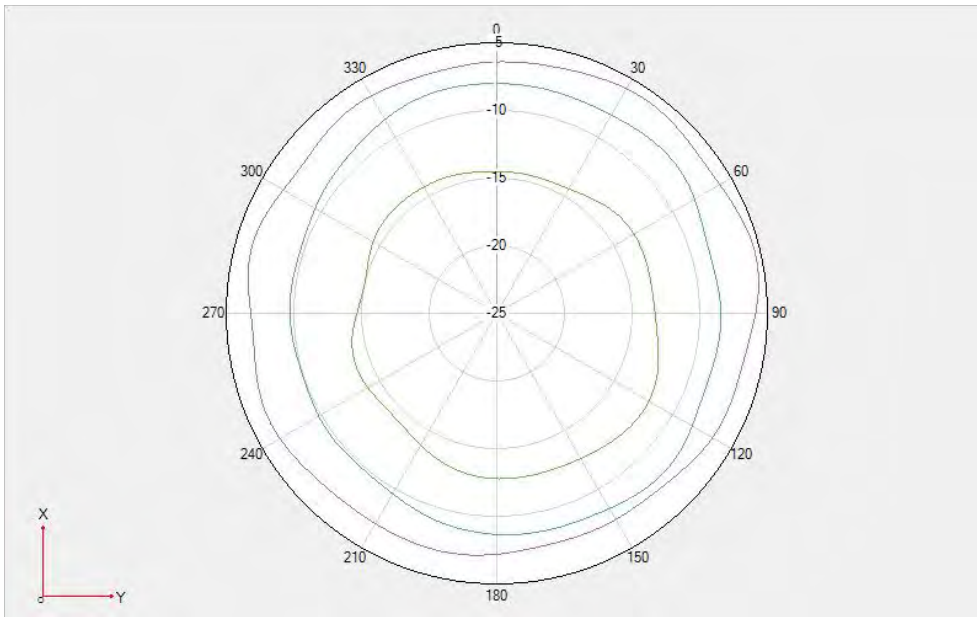

Fold-N71 $\Theta = 90^\circ$

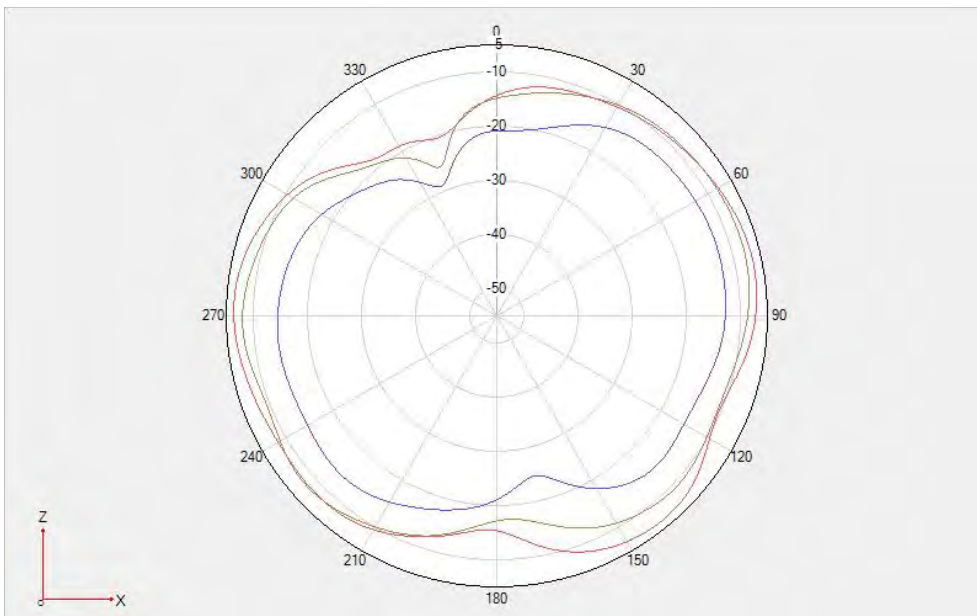

Fold-N71 $\Phi = 0^\circ$

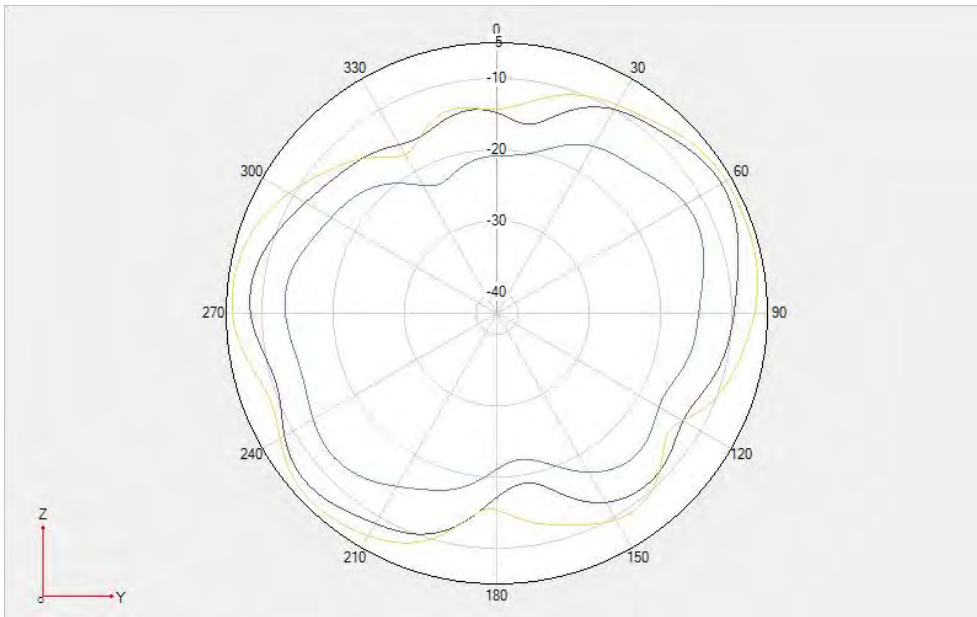

Fold-N71 Phi=90deg

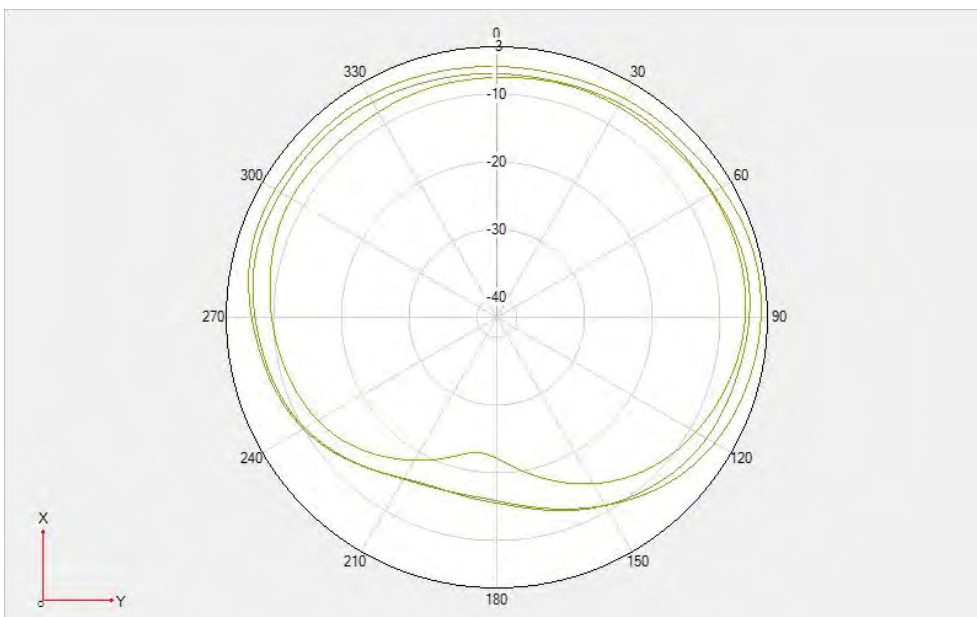

Unfold-Lte B28 Theta=90deg

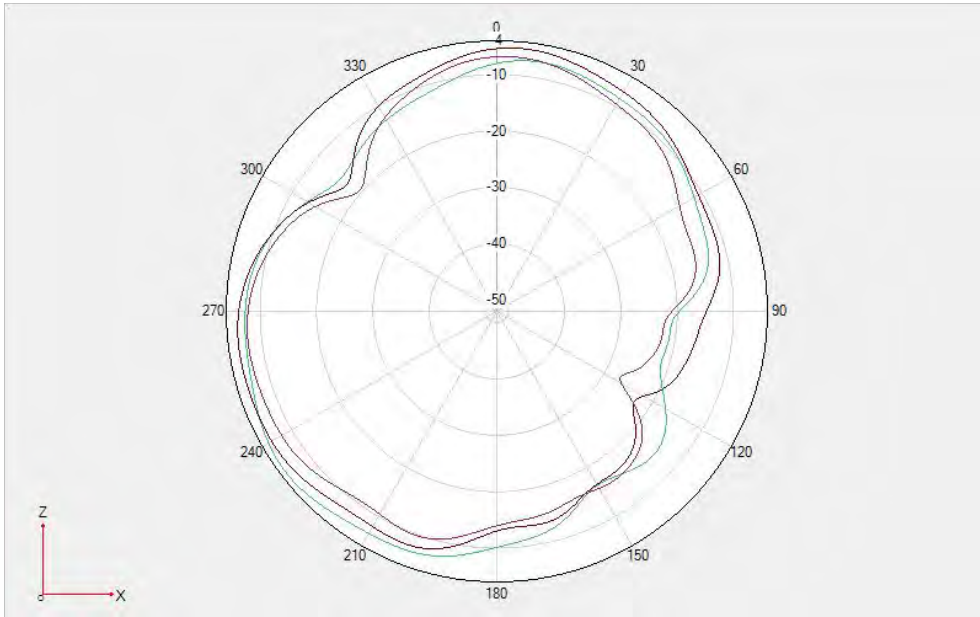

Unfold-Lte B28/N28 $\Phi=0^\circ$

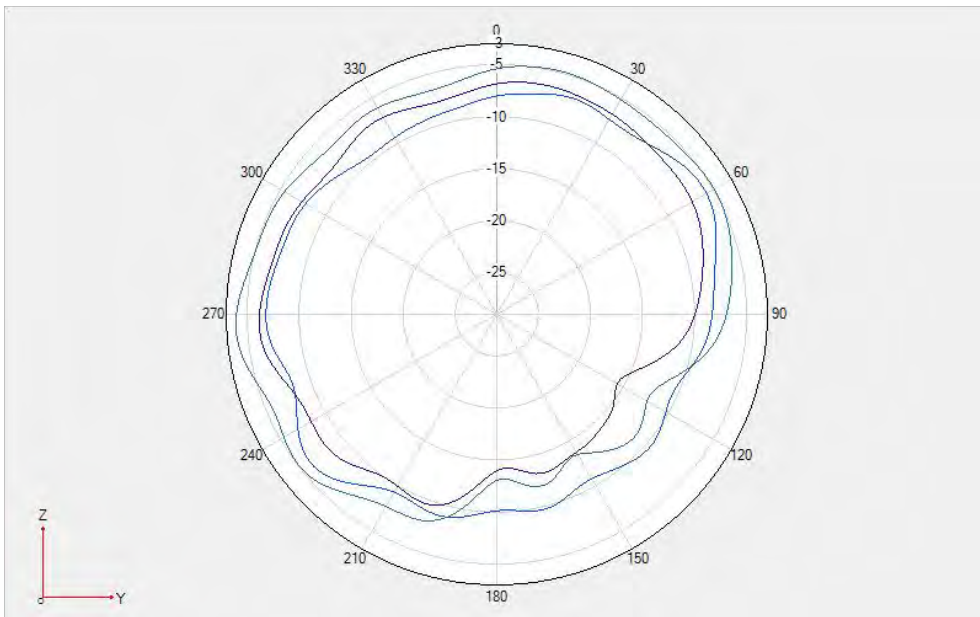

Unfold-Lte B28/N28 $\Phi=90^\circ$

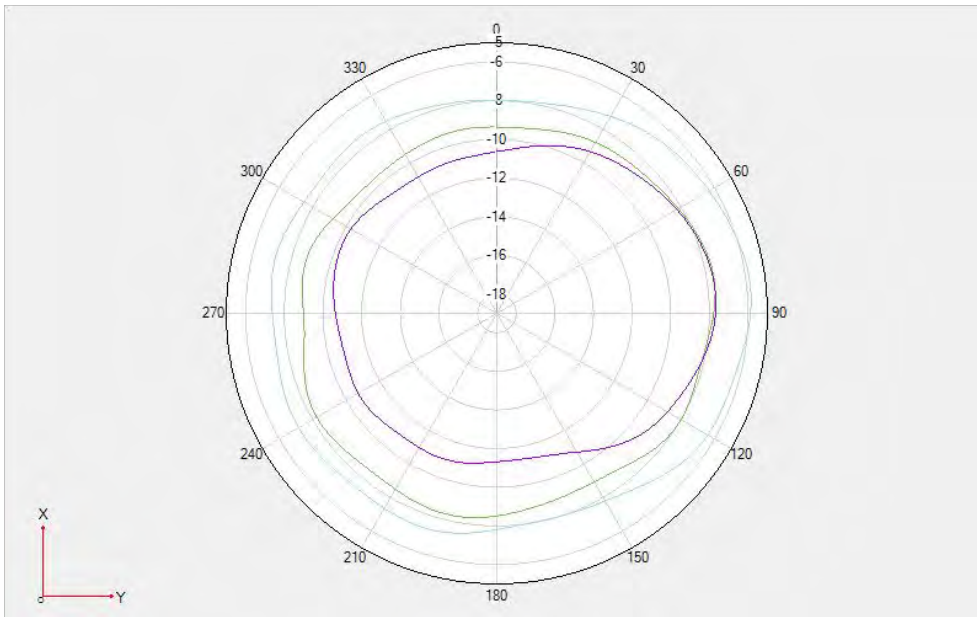

Fold-Lte B28/N28 $\Theta=90^\circ$

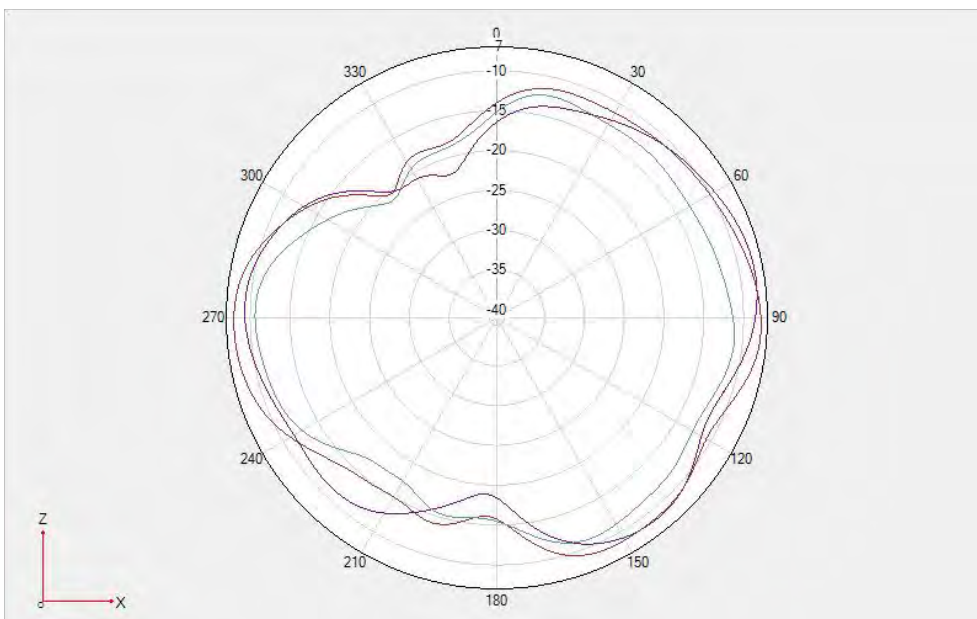

Fold-Lte B28/N28 $\Phi=0^\circ$

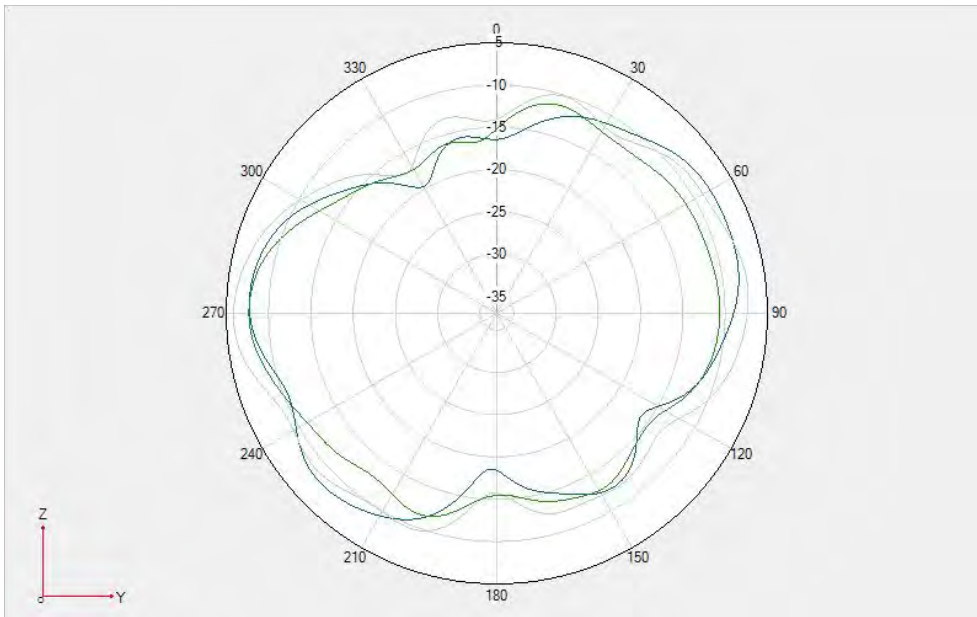

Fold-Lte B28/N28 Phi=90deg

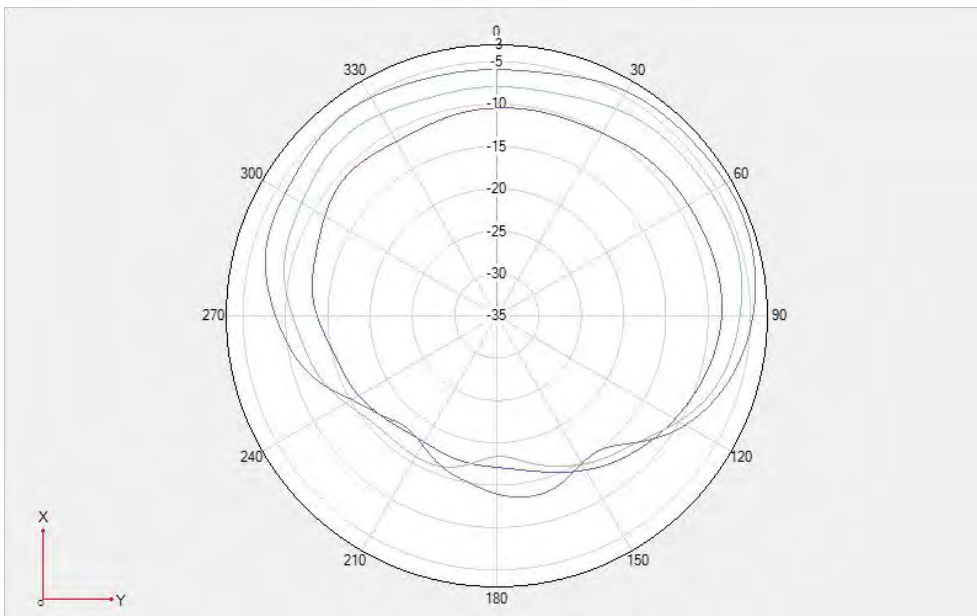

Unfold-LTE B5/B20N20 Theta=90deg

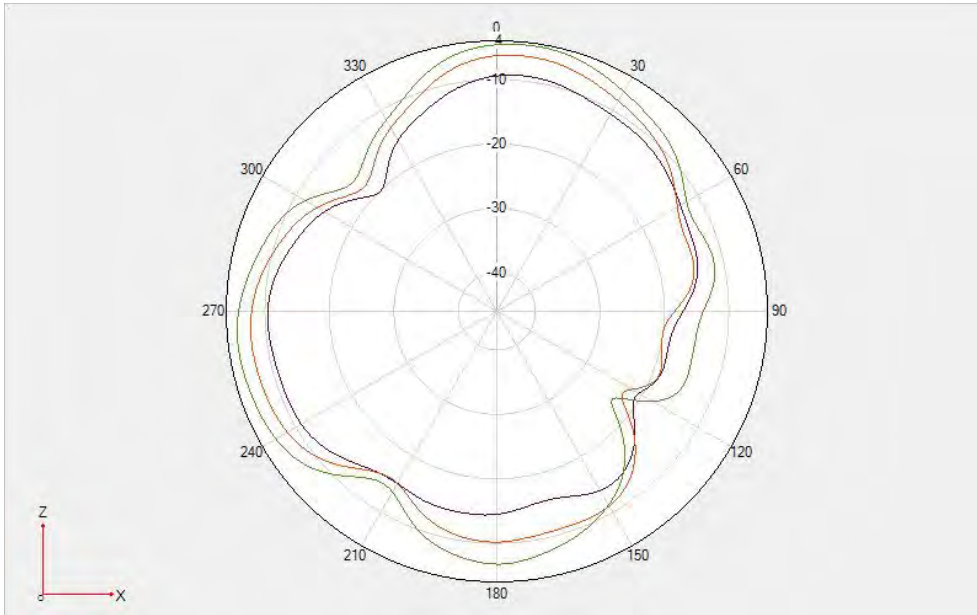

Unfold-GSM 850/WCDMA B5/LTE B5/B20/N20 $\Phi=0^\circ$

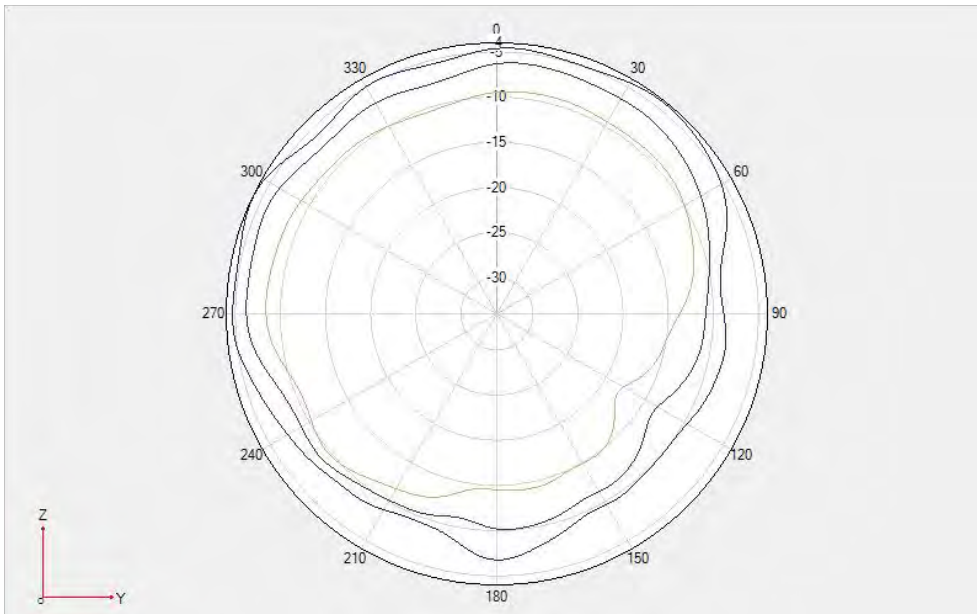

Unfold-GSM 850/WCDMA B5/LTE B5/B20/N20 $\Phi=90^\circ$

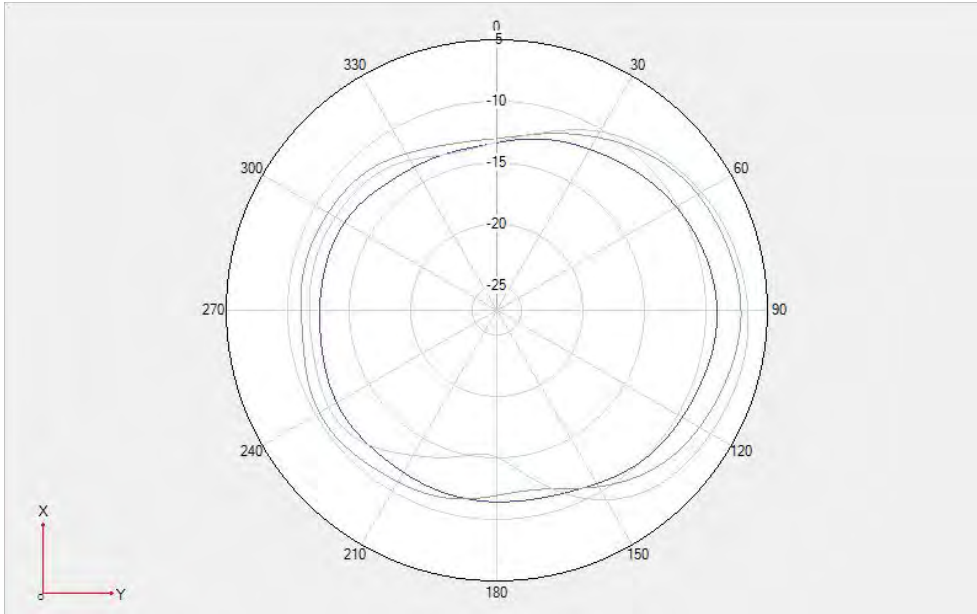

Fold-GSM 850/WCDMA B5/LTE B5/B20/N20 $\Theta = 90^\circ$

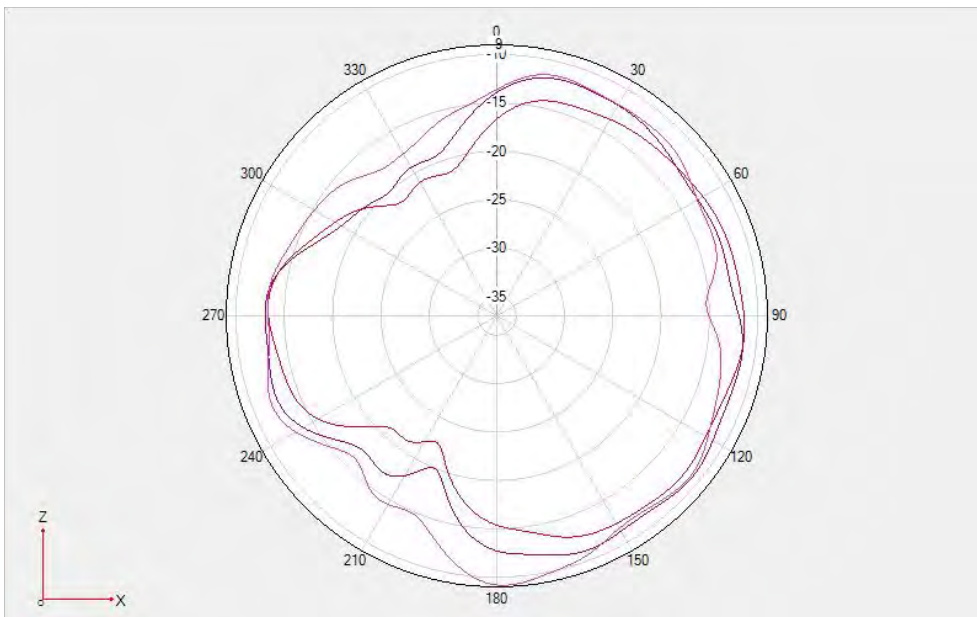

Fold-GSM 850/WCDMA B5/LTE B5/B20/N20 $\Phi = 0^\circ$

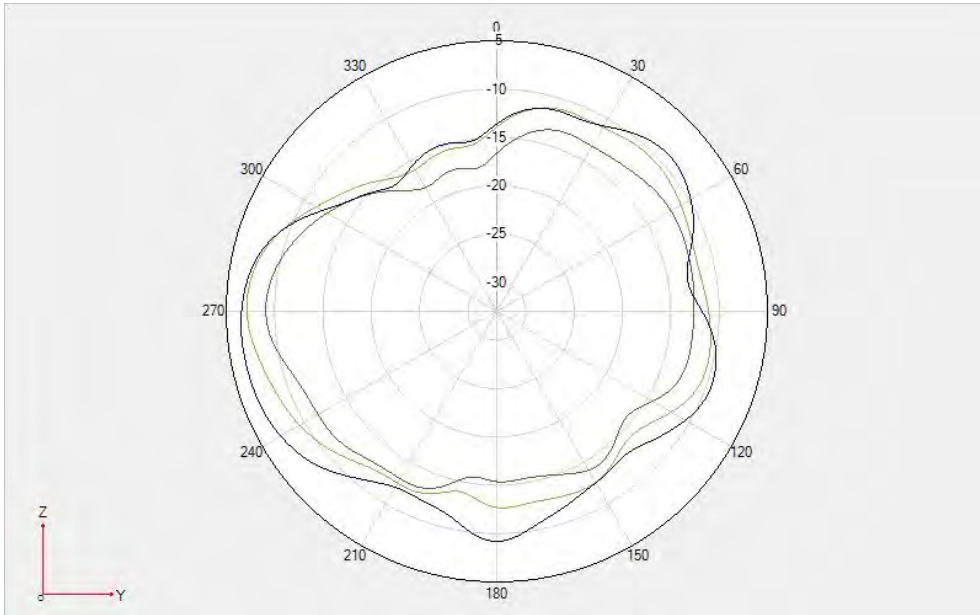

Fold-GSM 850/WCDMA B5/LTE B5/B20/N20 $\Phi=90^\circ$

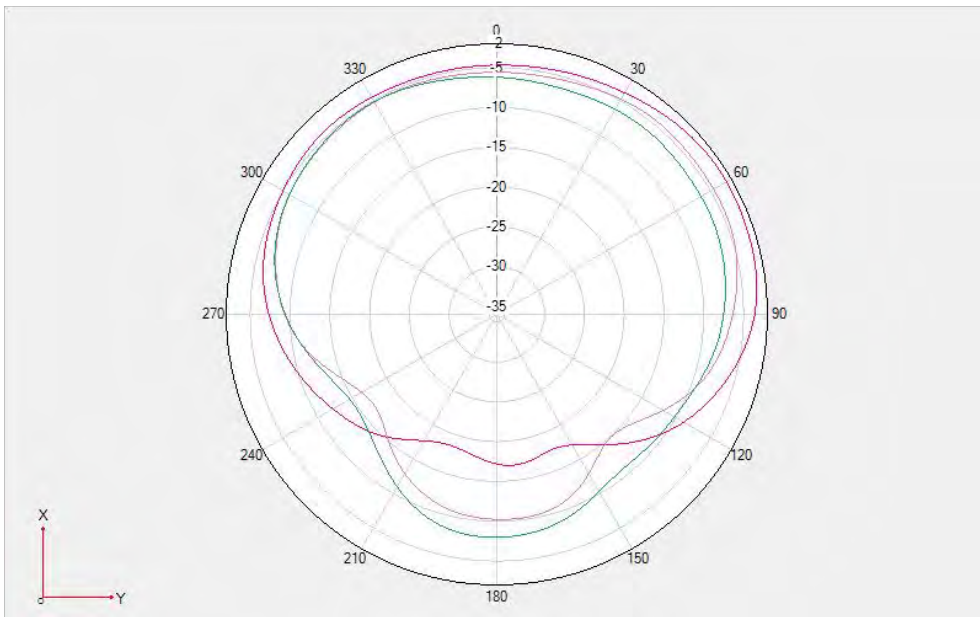

Unfold-GSM 900/WCDMA B8/LTE B8 $\Theta=90^\circ$

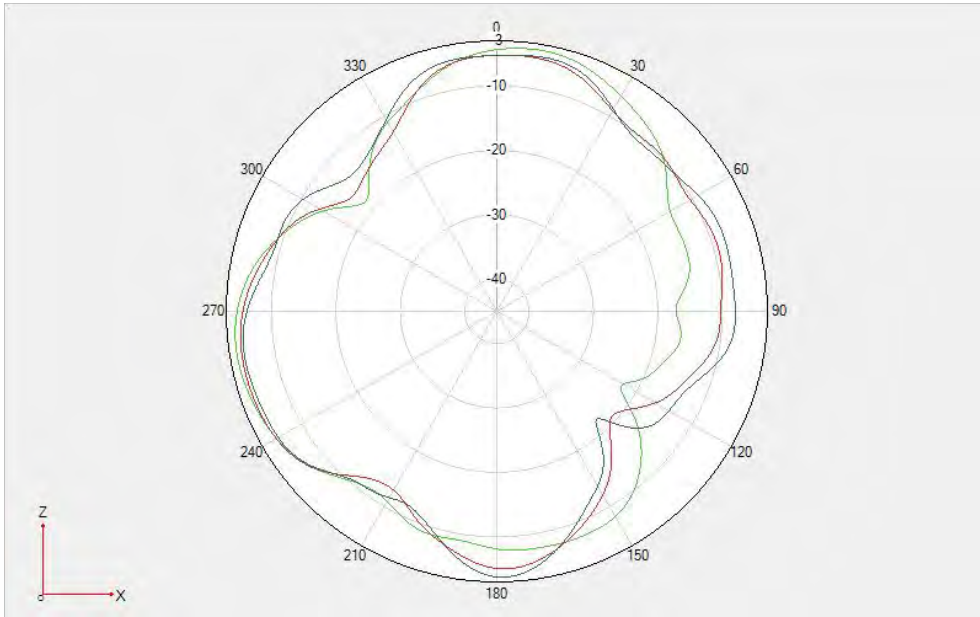

Unfold-GSM 900/WCDMA B8/LTE B8 $\Phi=0^\circ$

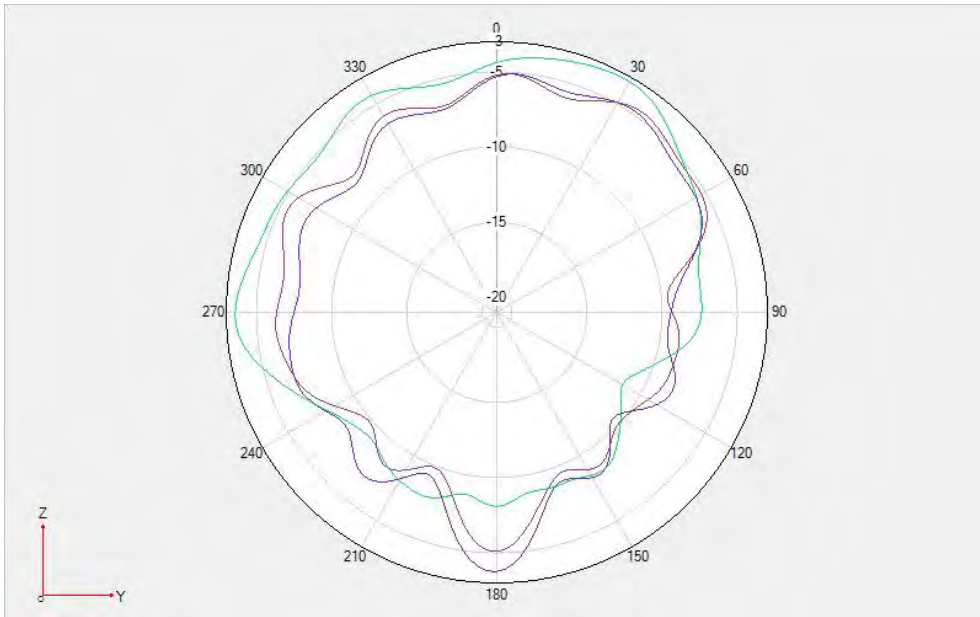

Unfold-GSM 900/WCDMA B8/LTE B8 $\Phi=90^\circ$

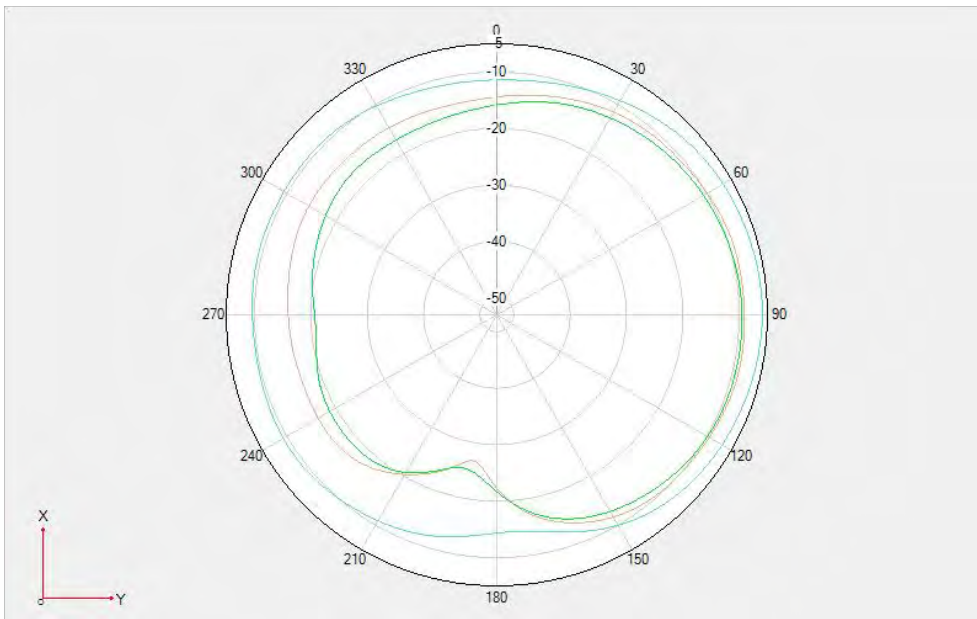

Fold-GSM 900/WCDMA B8/LTE B8 $\Theta = 90^\circ$

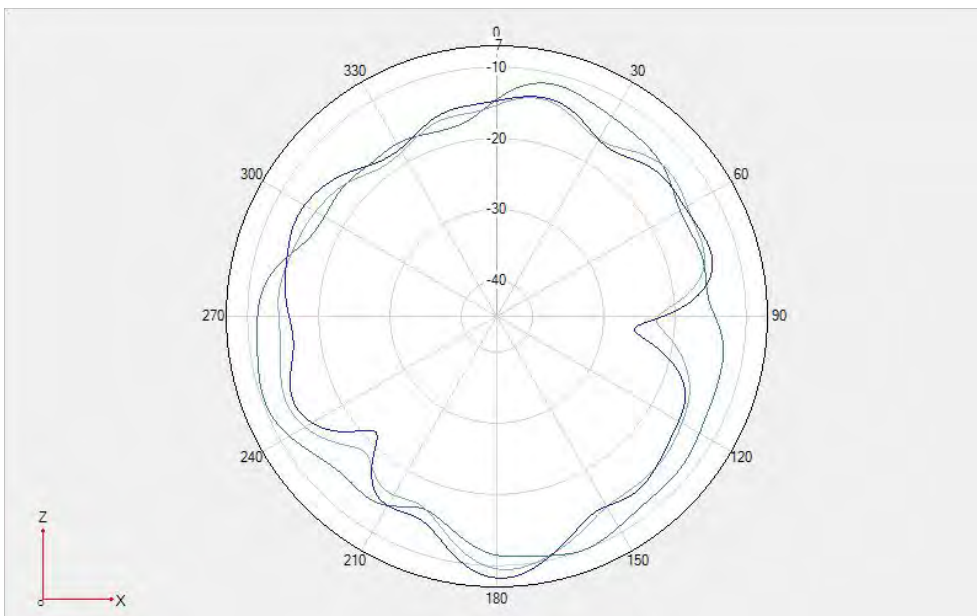

Fold-GSM 900/WCDMA B8/LTE B8 $\Phi = 0^\circ$

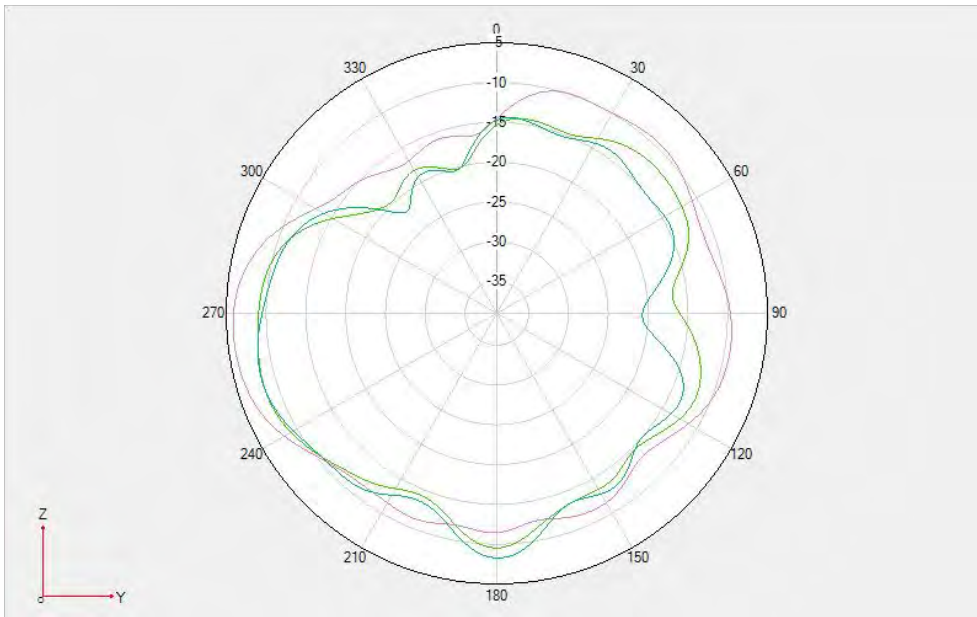

Fold-GSM 900/WCDMA B8/LTE B8 $\Phi=90\text{deg}$

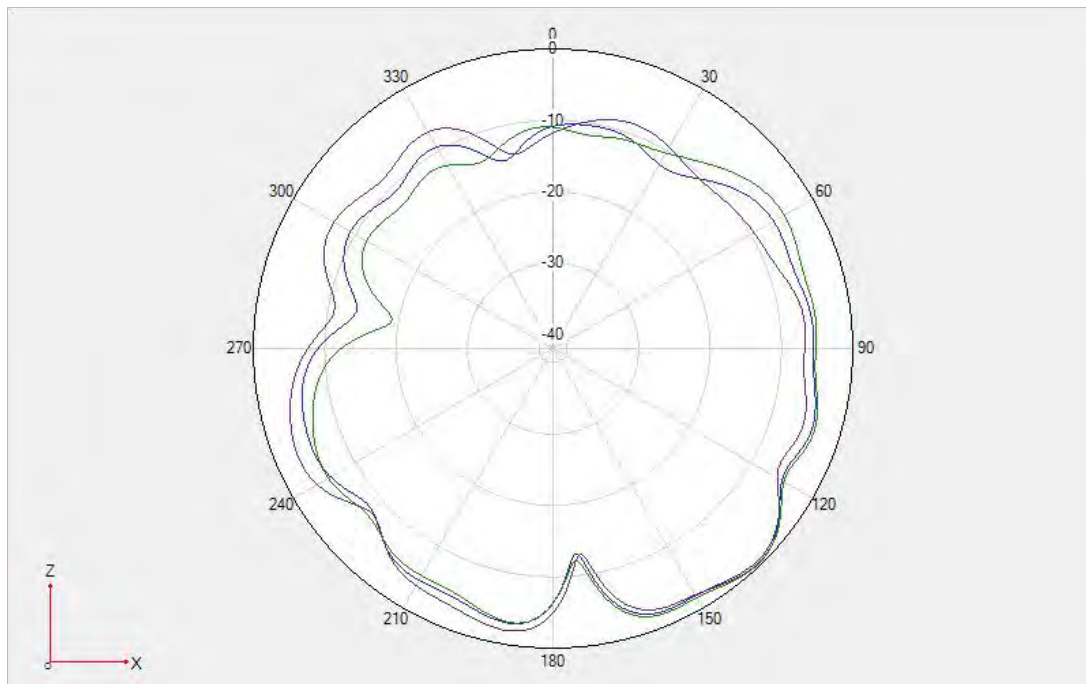

Unfold-DCS/WCDMA B4/LTE B3/B4/B66N3/N66 $\Phi=0\text{deg}$

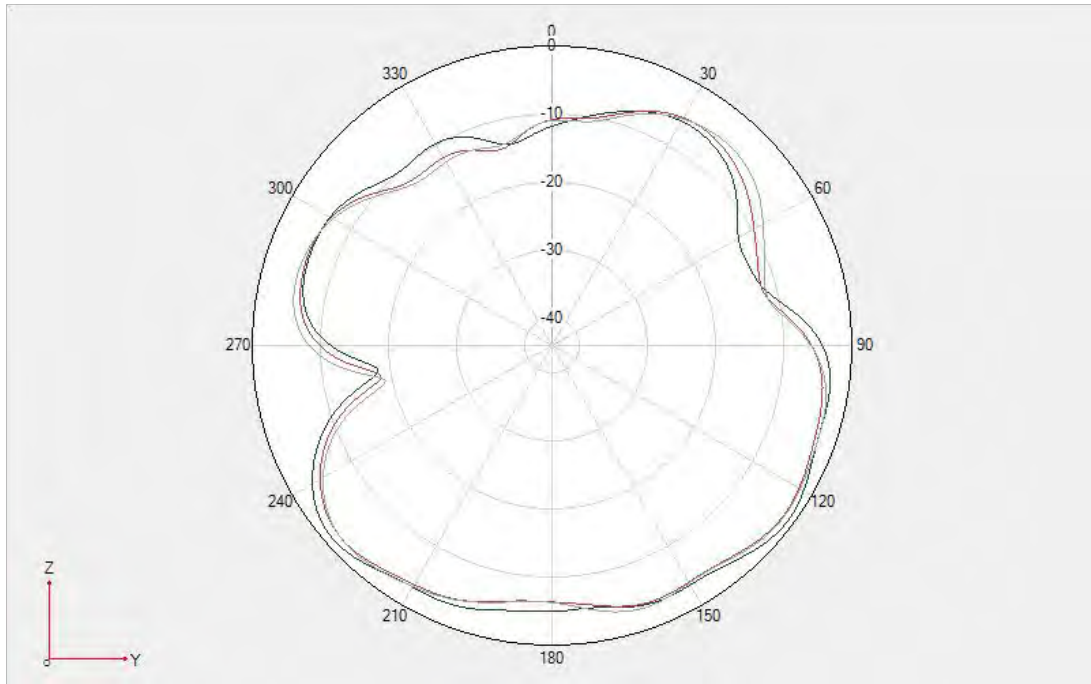

Unfold- DCS/WCDMA B4/ LTE B3/B4/B66/N3/N66 Phi=90deg

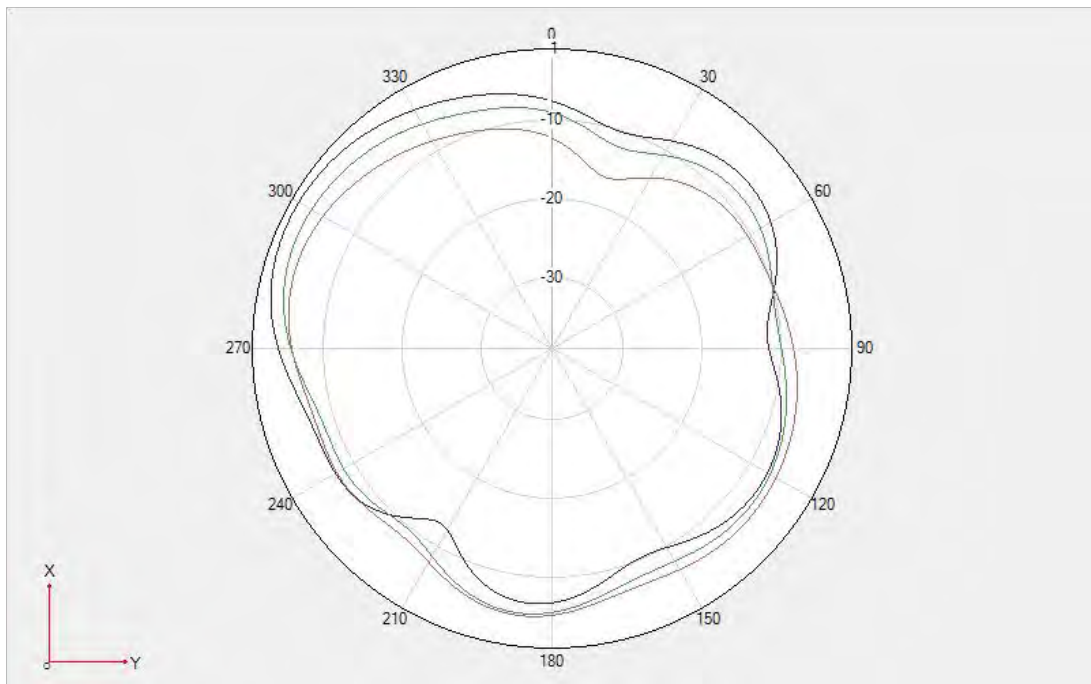

Unfold- DCS/WCDMA B4/ LTE B3/B4/B66/N3/N66 Theta=90deg

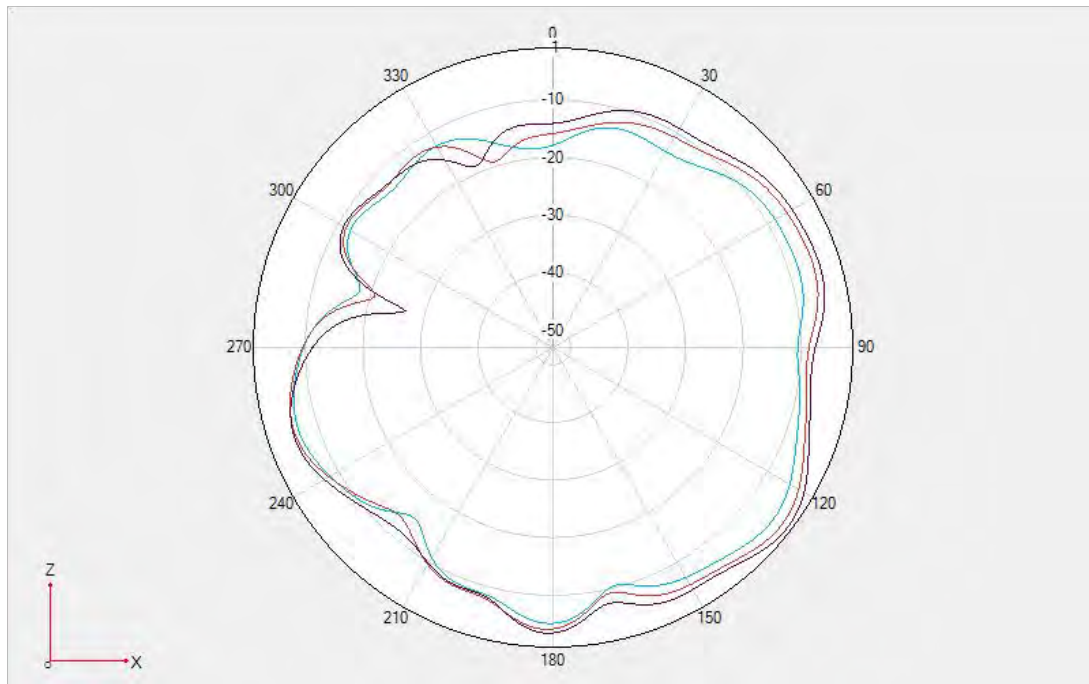

Fold- DCS/WCDMA B4/ LTE B3/B4/B66/N3/N66 $\Phi=0\text{deg}$

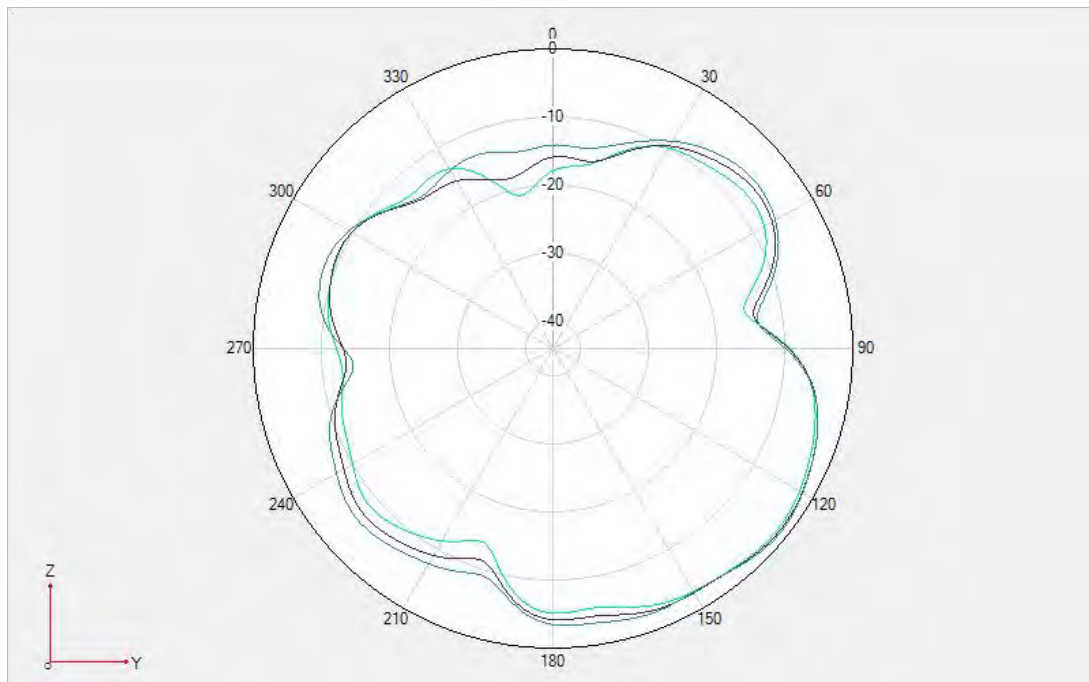

Fold- DCS/WCDMA B4/ LTE B3/B4/B66/N3/N66 $\Phi=90\text{deg}$

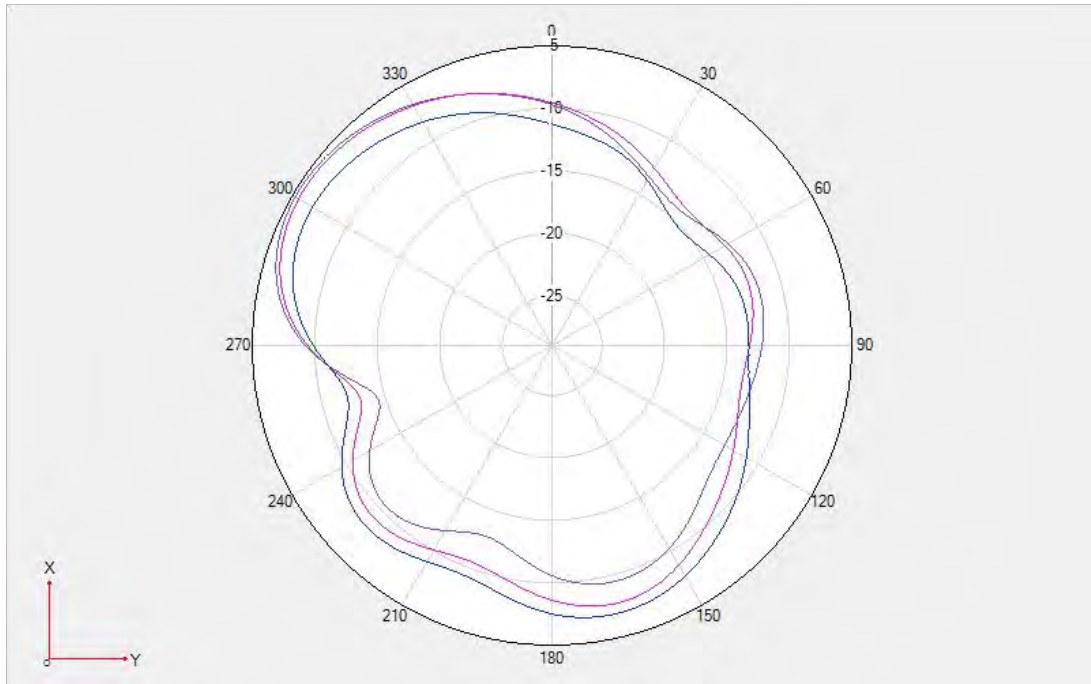

Fold- DCS/WCDMA B4/ LTE B3/B4/B66/N3/N66 Theta=90deg

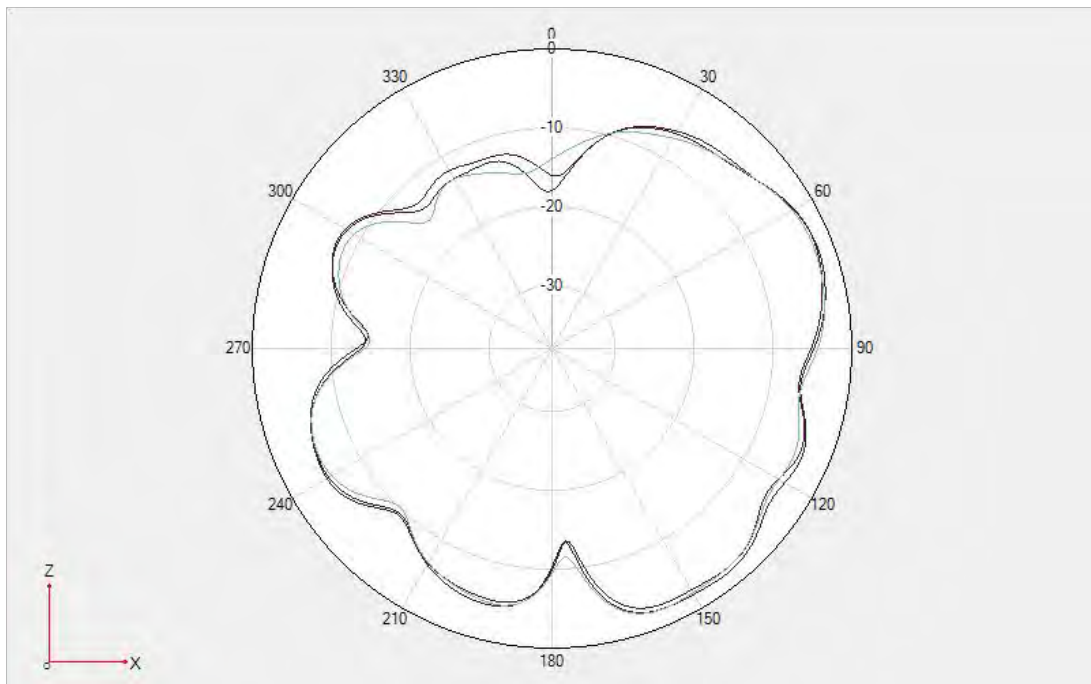

Unfold- WCDMA B1/LTE B1 Phi=0deg

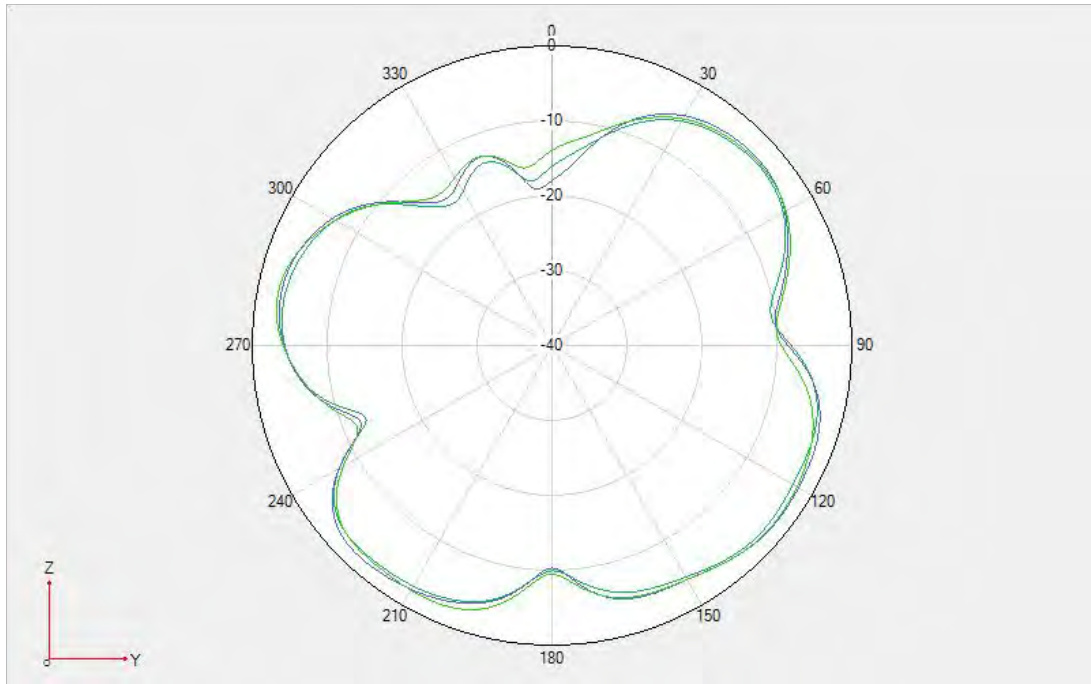

Unfold- WCDMA B1/LTE B1 $\Phi=90^\circ$

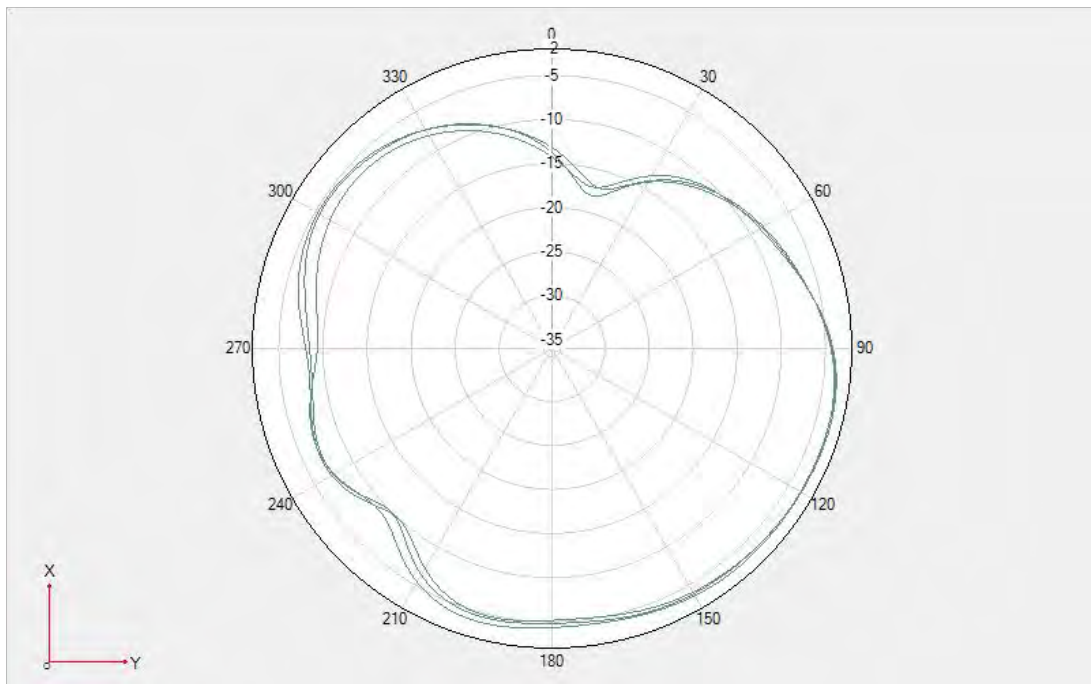

Unfold- WCDMA B1/LTE B1 $\Theta=90^\circ$

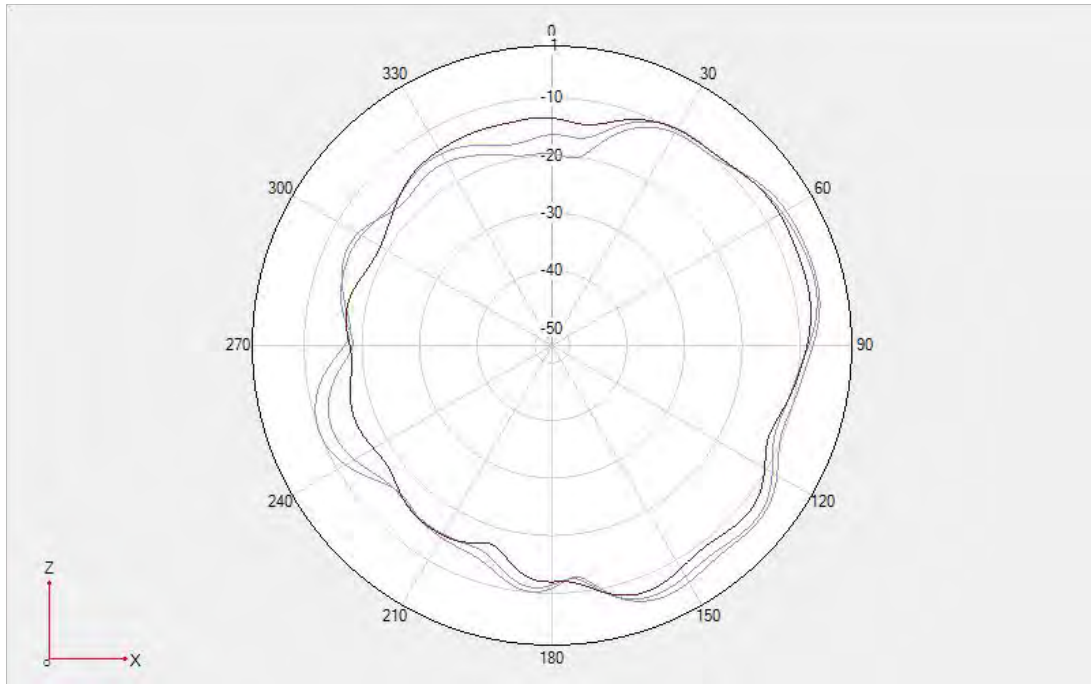

Fold- WCDMA B1/LTE B1 $\Phi=0^\circ$

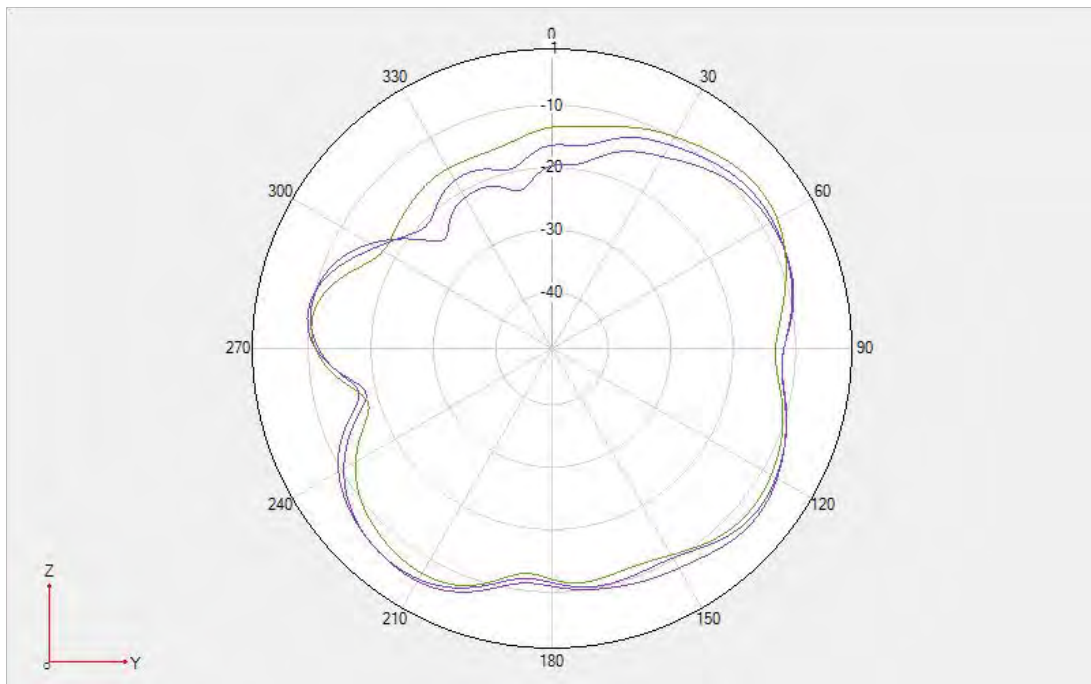

Fold- WCDMA B1/LTE B1 $\Phi=90^\circ$

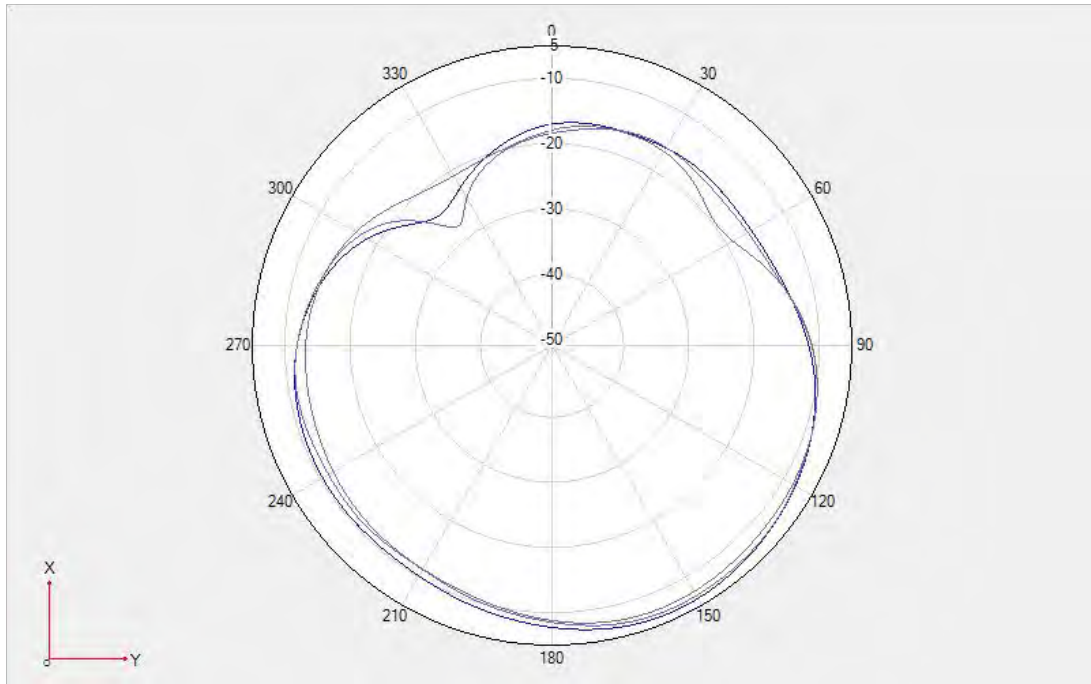

Fold- WCDMA B1/LTE B1 Theta=90deg

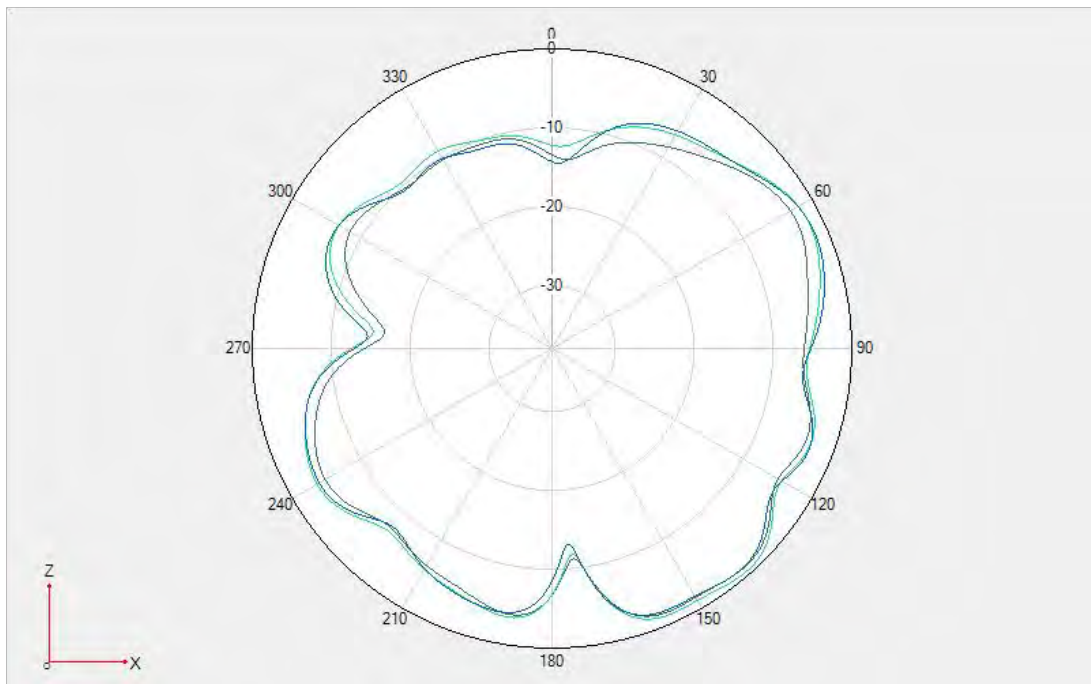

Unfold- PCS/WCDMA B2/LTE B2 Phi=0deg

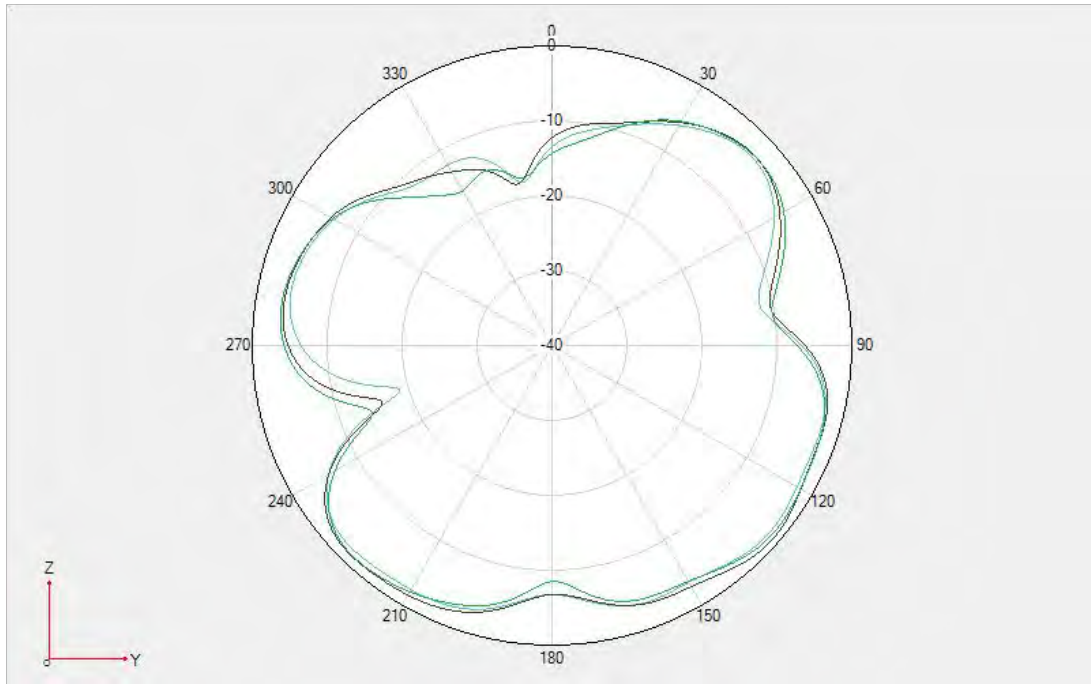

Unfold- PCS/WCDMA B2/LTE B2Phi=90deg

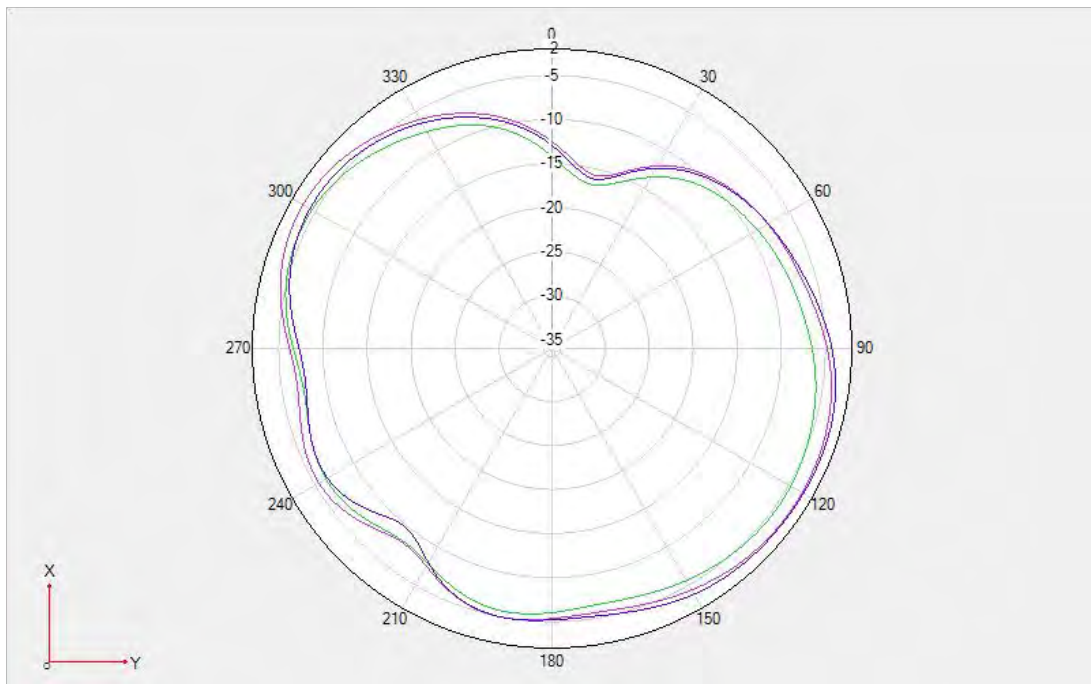

Unfold- PCS/WCDMA B2/LTE B2 Theta=90deg

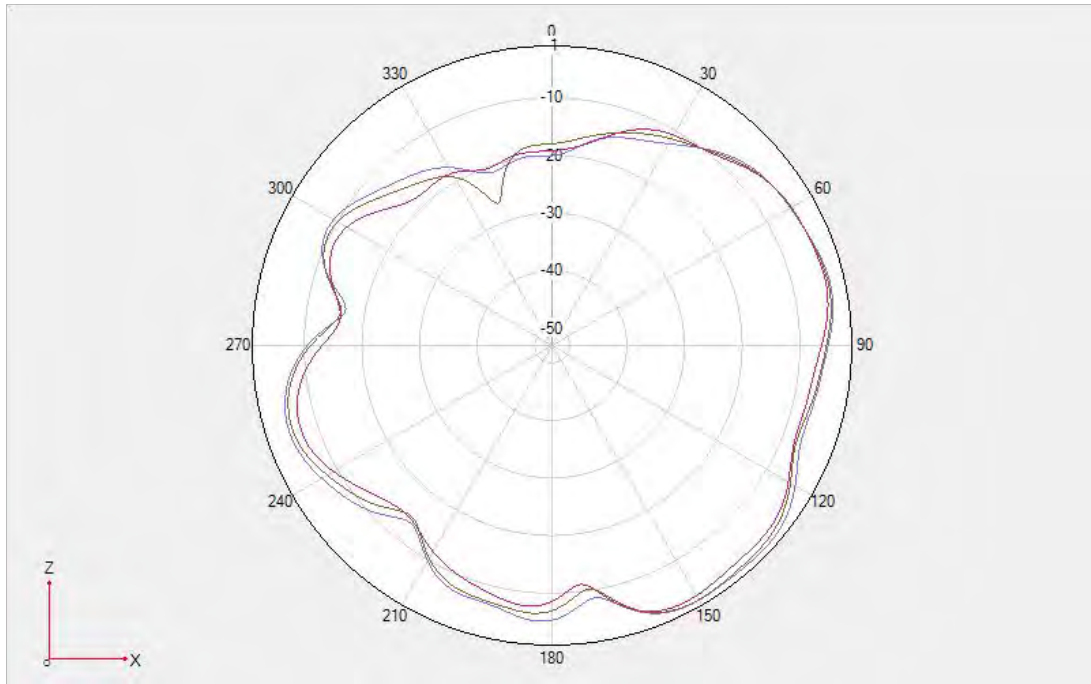

Fold- PCS/WCDMA B2/LTE B2 $\Phi = 0^\circ$

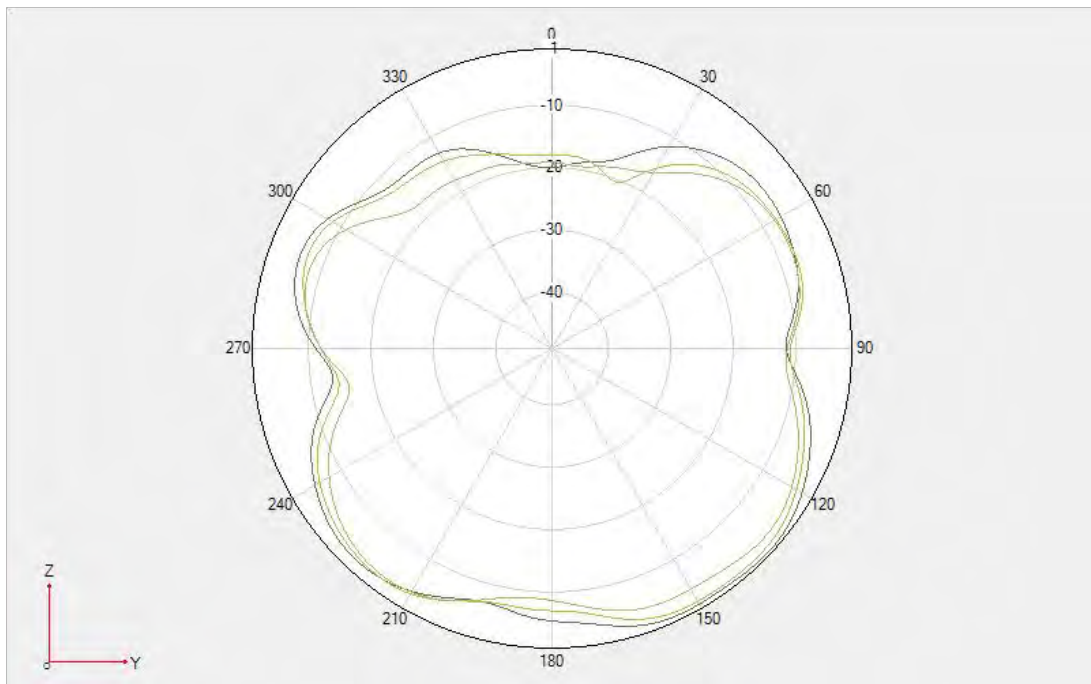

Fold- PCS/WCDMA B2/LTE B2 $\Phi = 90^\circ$

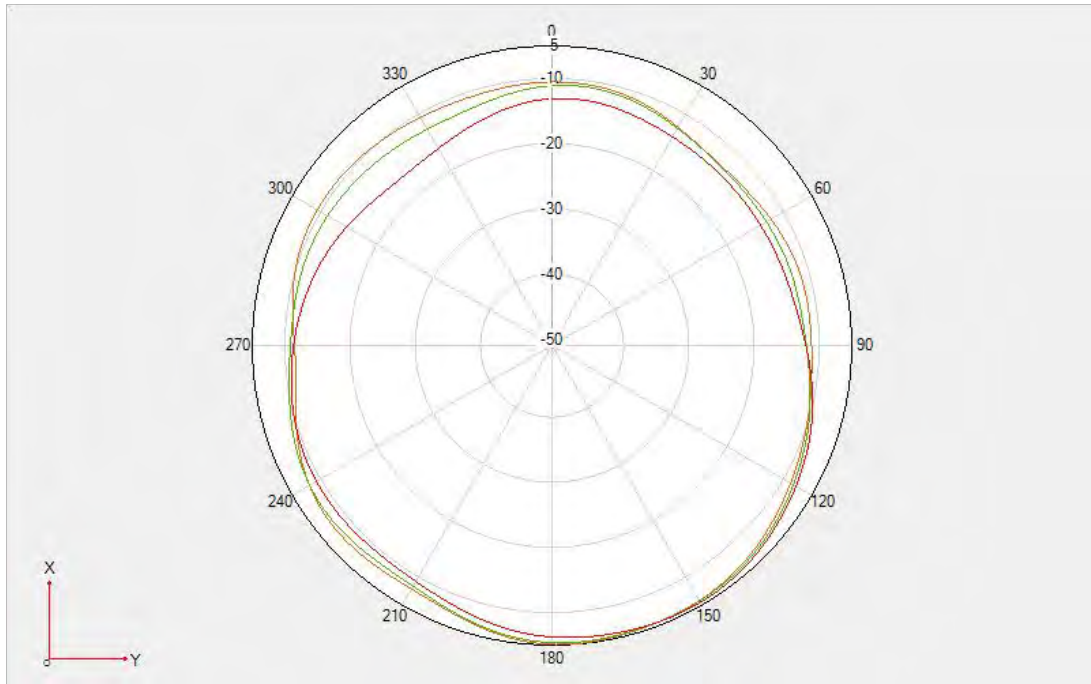

Fold- PCS/WCDMA B2/LTE B2 Theta=90deg

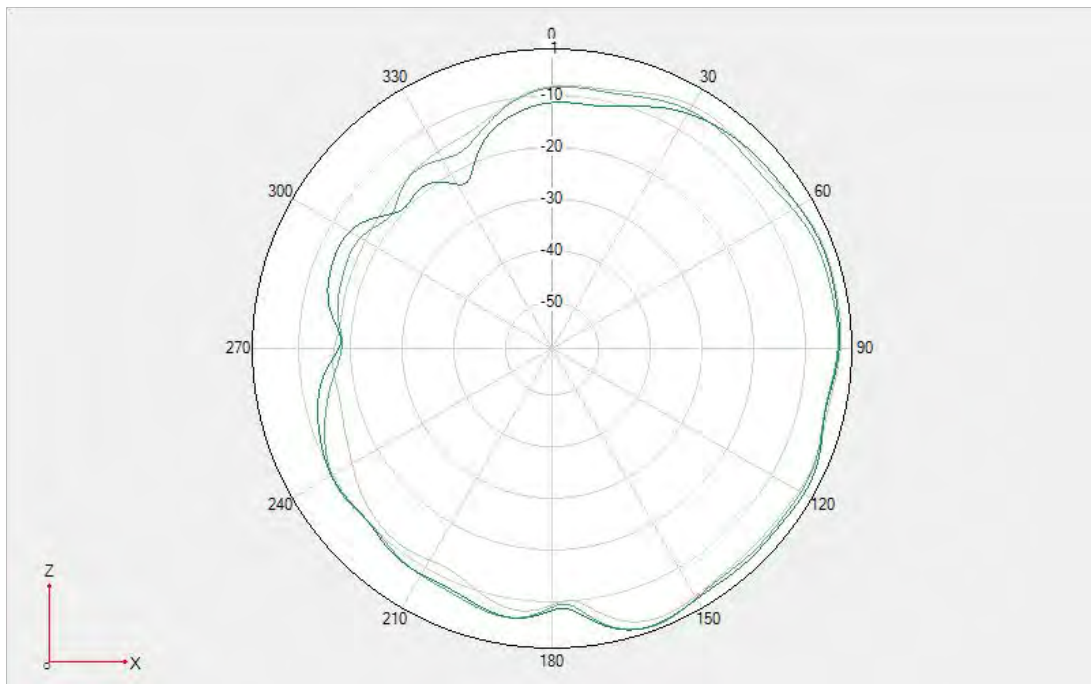

Unfold- LTE B7 Phi=0deg

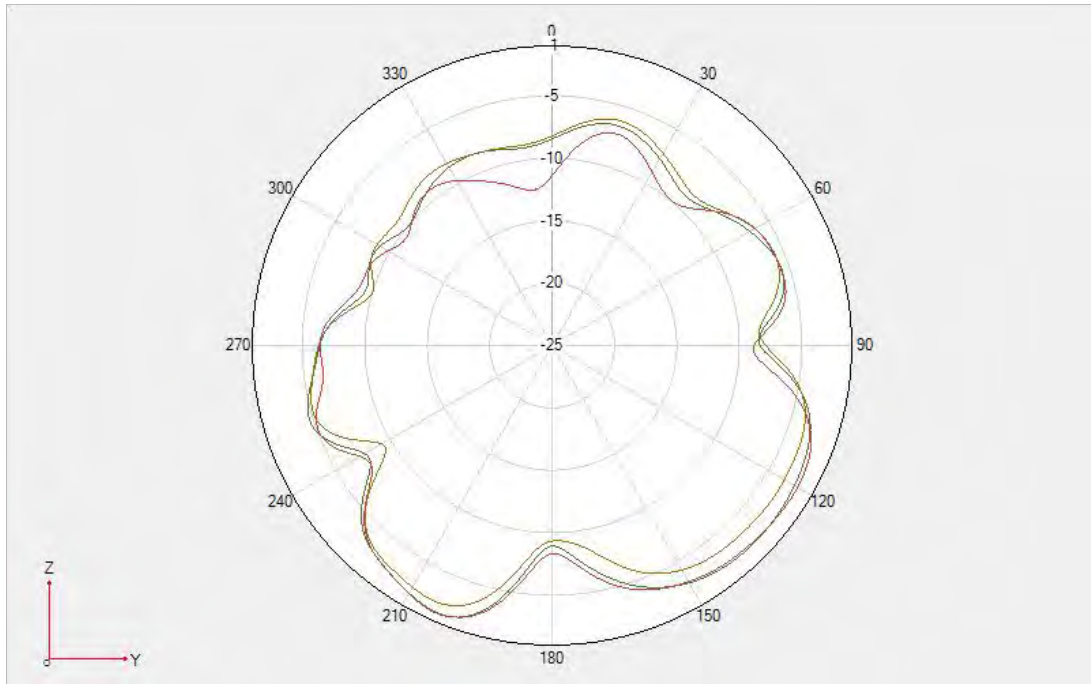

Unfold- LTE B7 $\Phi=90^\circ$

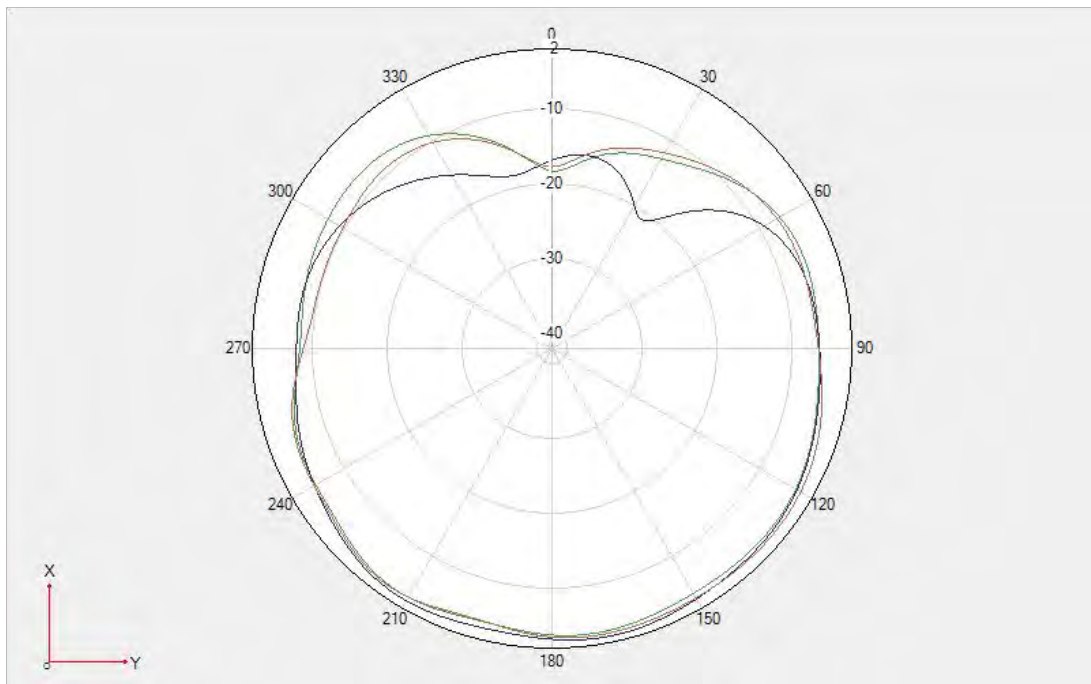

Unfold- LTE B7 $\Theta=90^\circ$

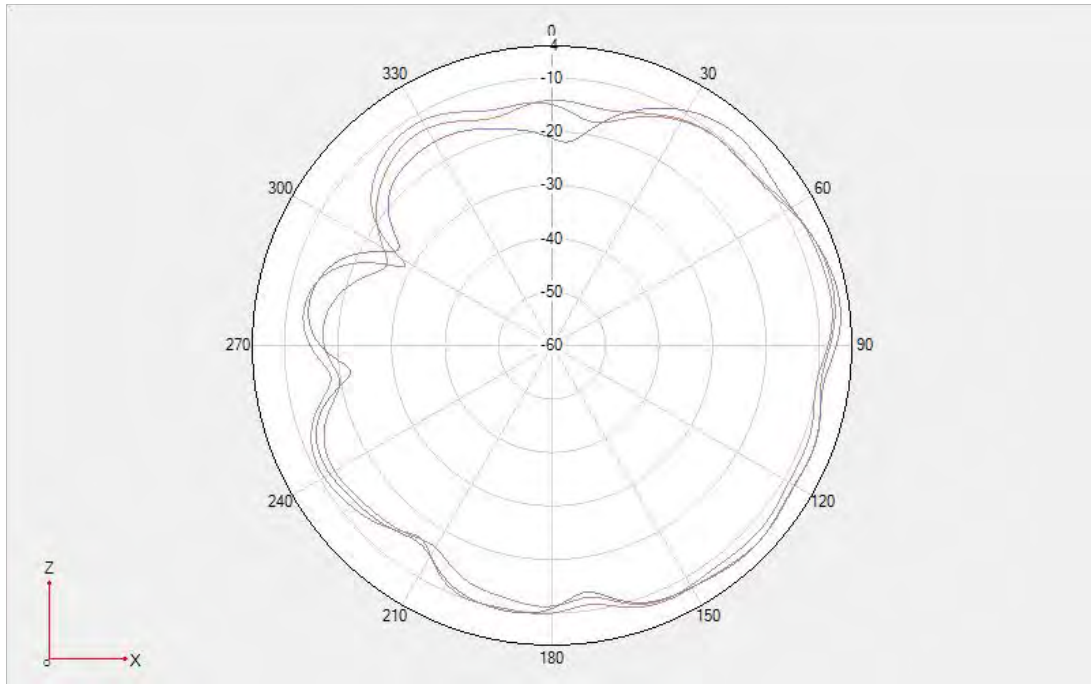

Fold- LTE B7 $\Phi=0^\circ$

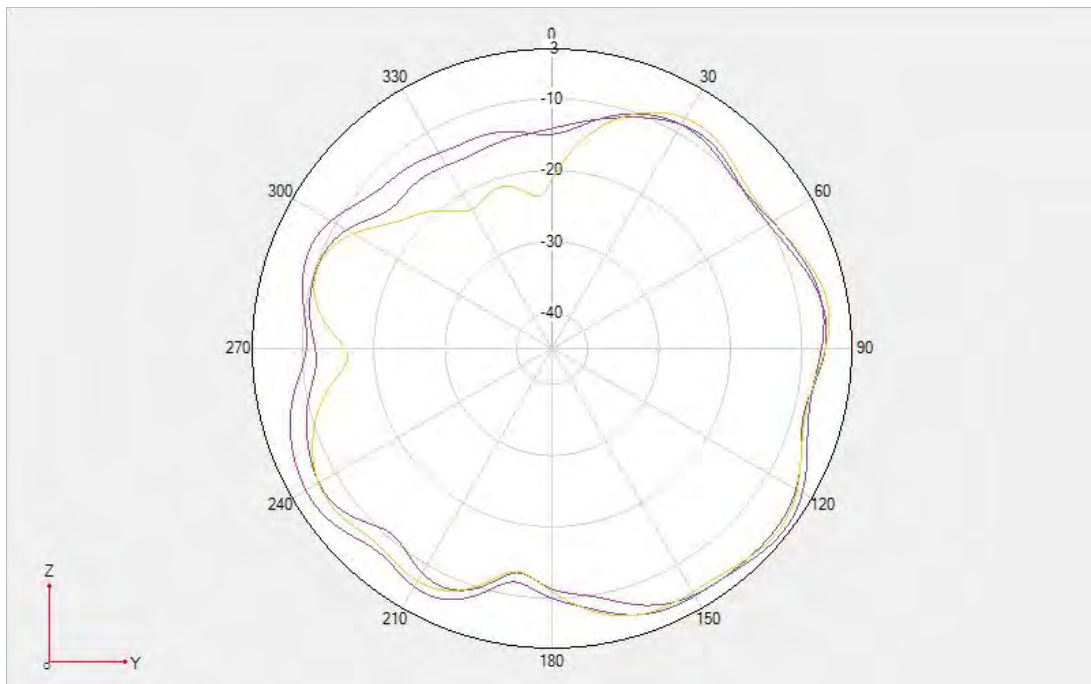

Fold- LTE B7 $\Phi=90^\circ$

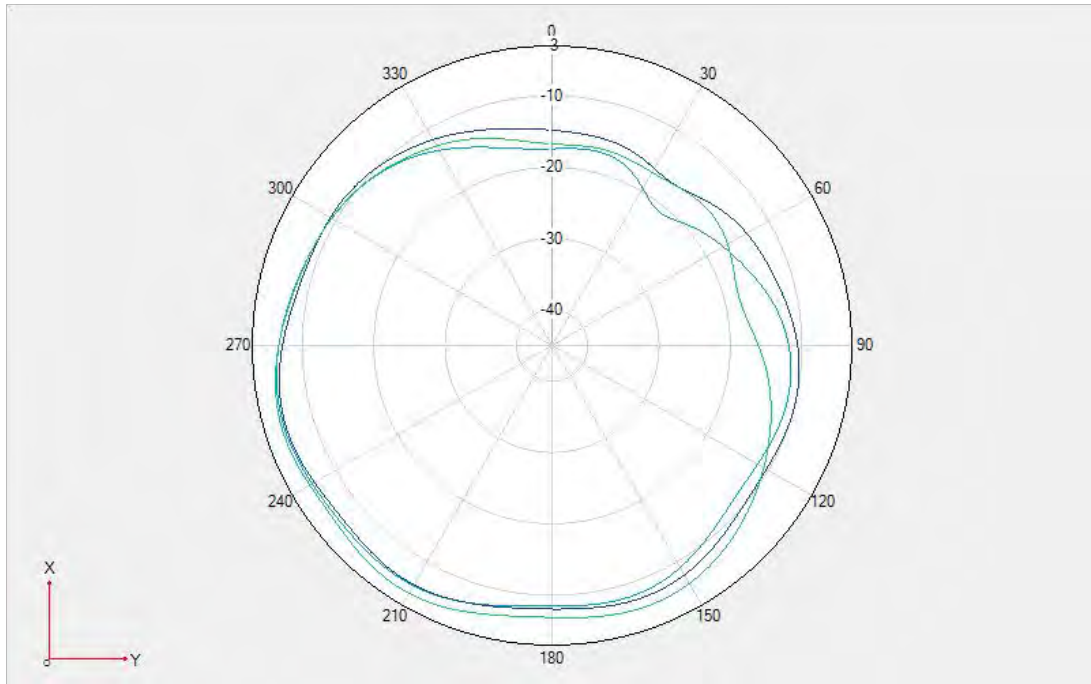

Fold- LTE B7 Theta=90deg

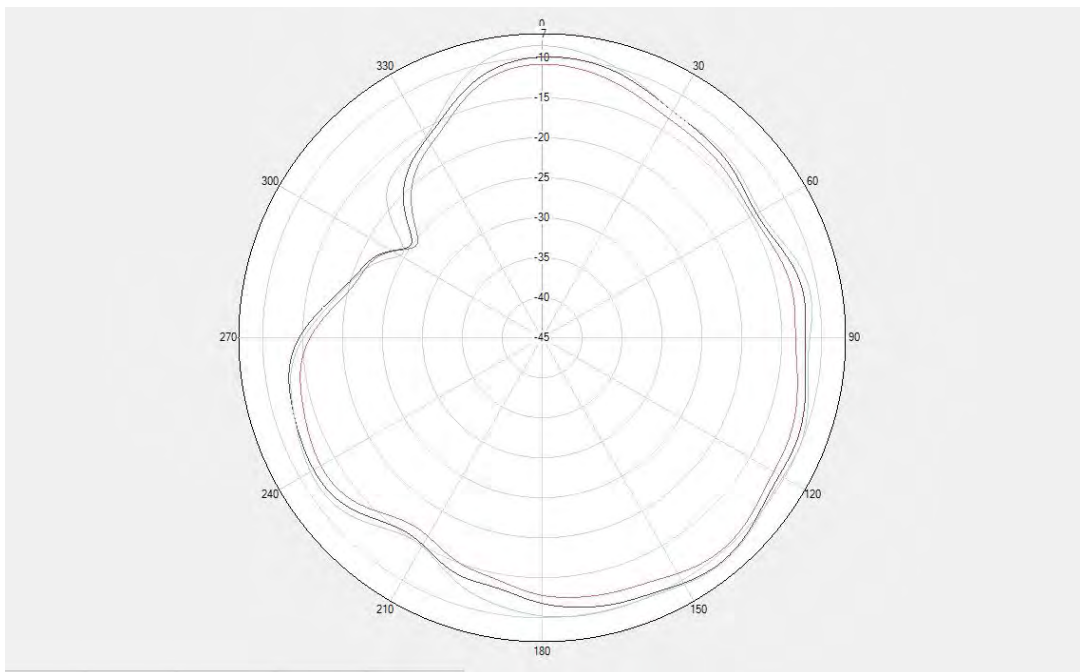

Unfold- DPDT SWAP:GSM 850/WCDMA B5/LTE B5 Phi=0deg

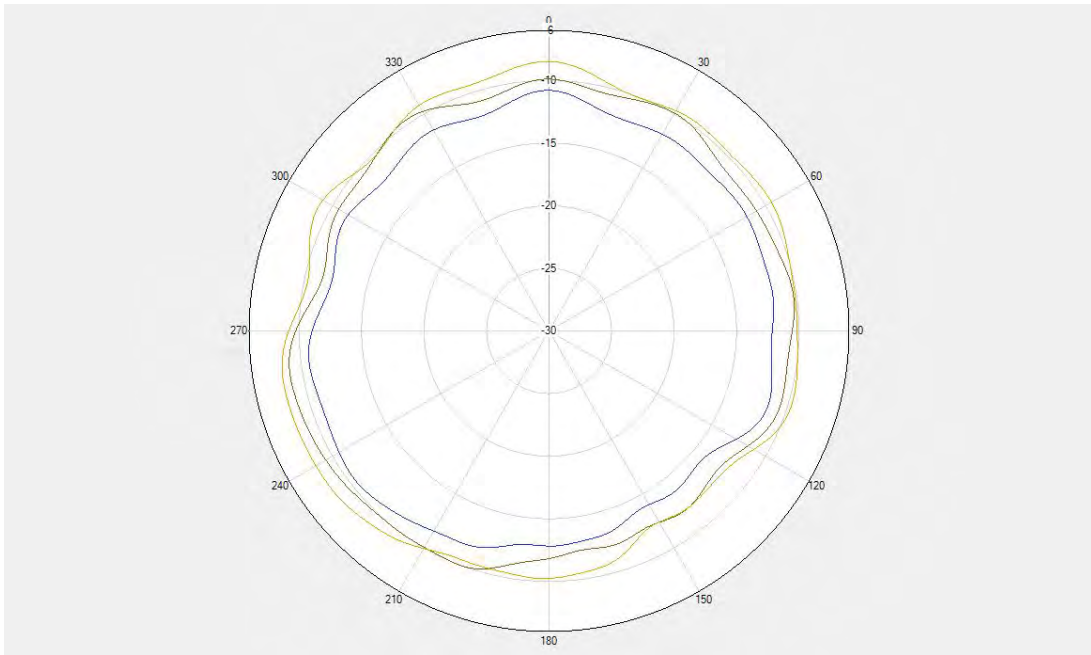

Unfold- **DPDT SWAP**:GSM 850/WCDMA B5/LTE B5 Phi=90deg

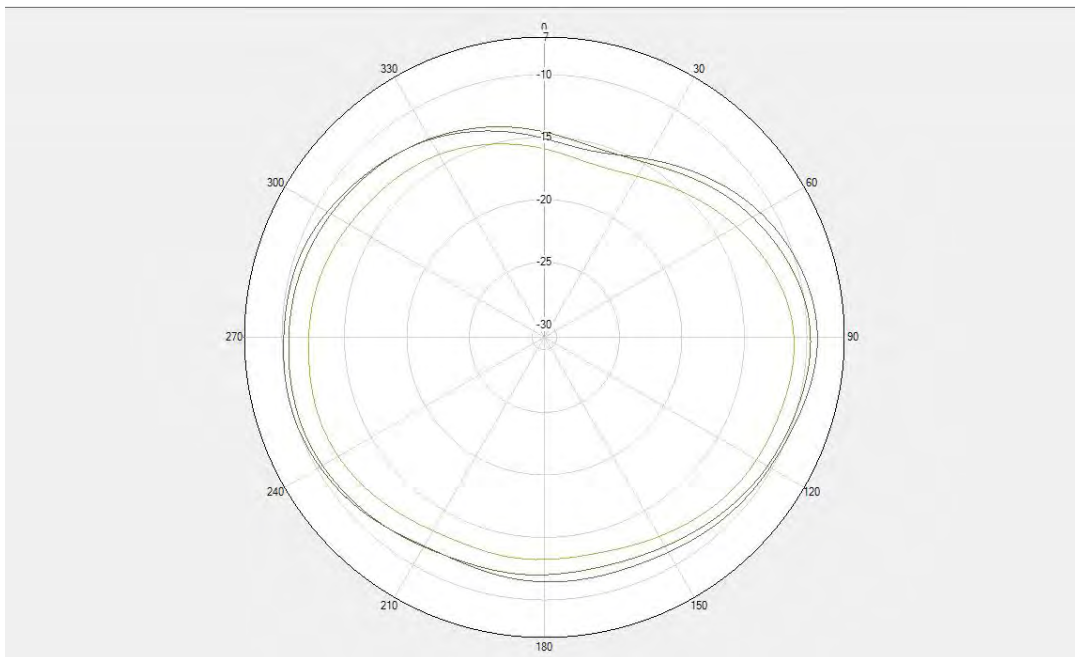

Unfold- **DPDT SWAP**:GSM 850/WCDMA B5/LTE B5 Theta=90deg

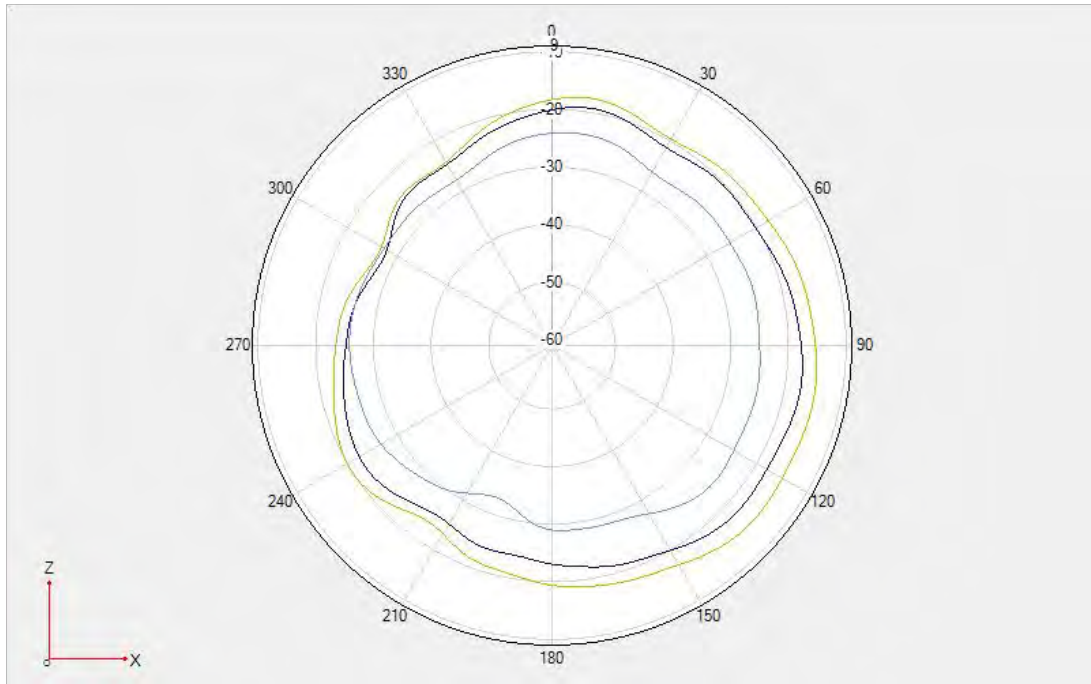

Fold- DPDT SWAP:GSM 850/WCDMA B5/LTE B5 $\Phi=0\text{deg}$

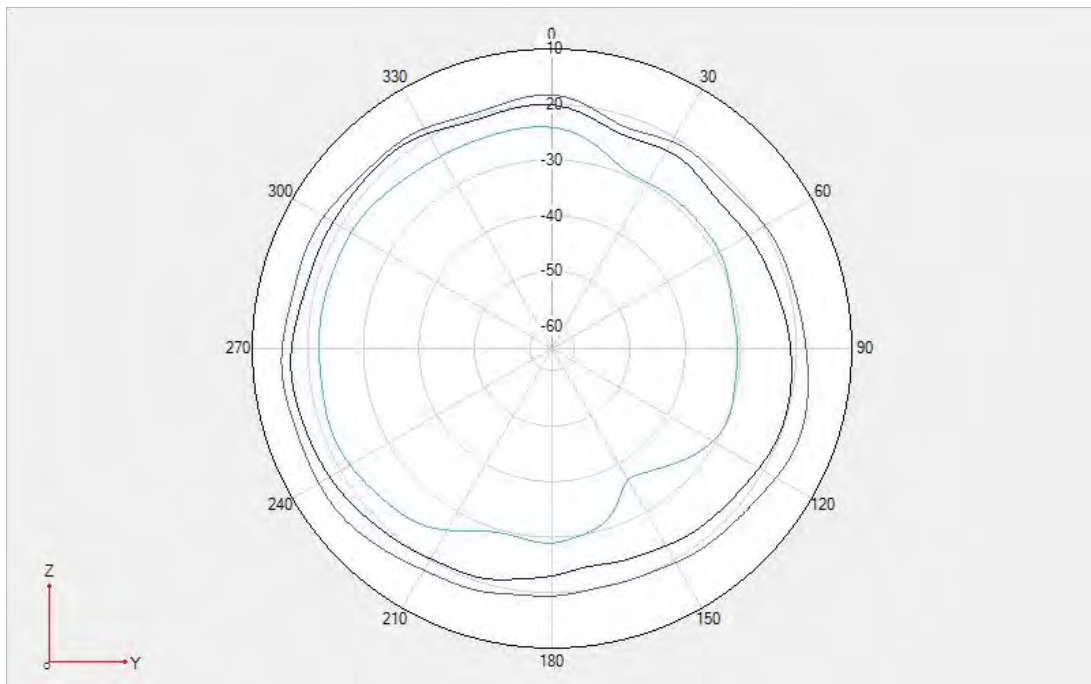

Fold- DPDT SWAP:GSM 850/WCDMA B5/LTE B5 $\Phi=90\text{deg}$

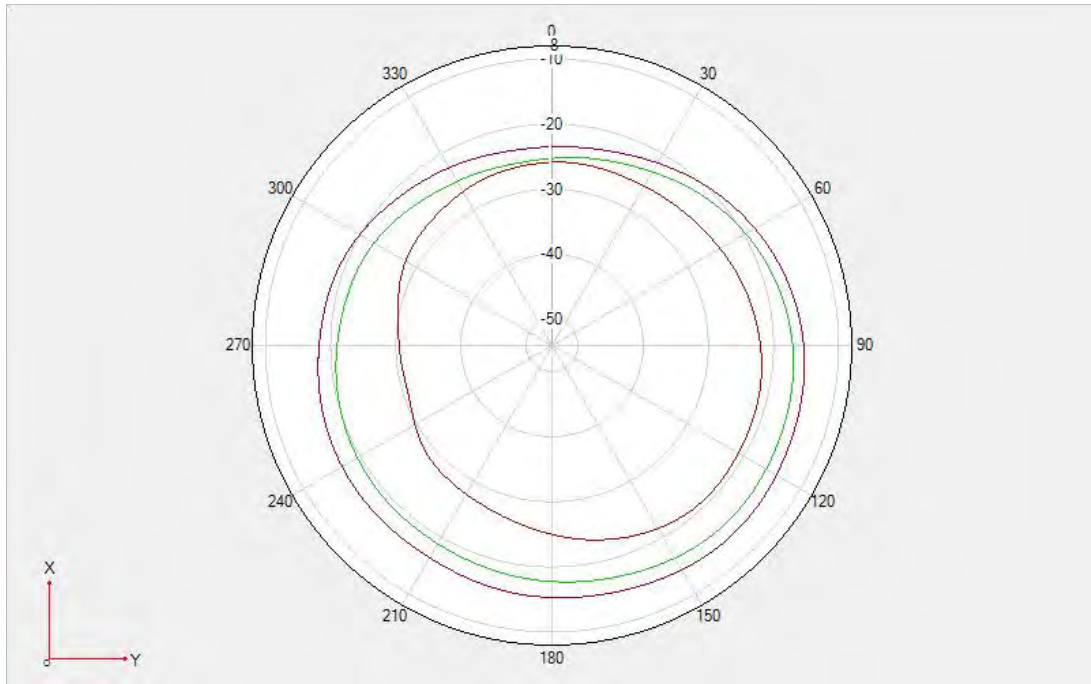

Fold- DPDT SWAP:GSM 850/WCDMA B5/LTE B5 Theta=90deg

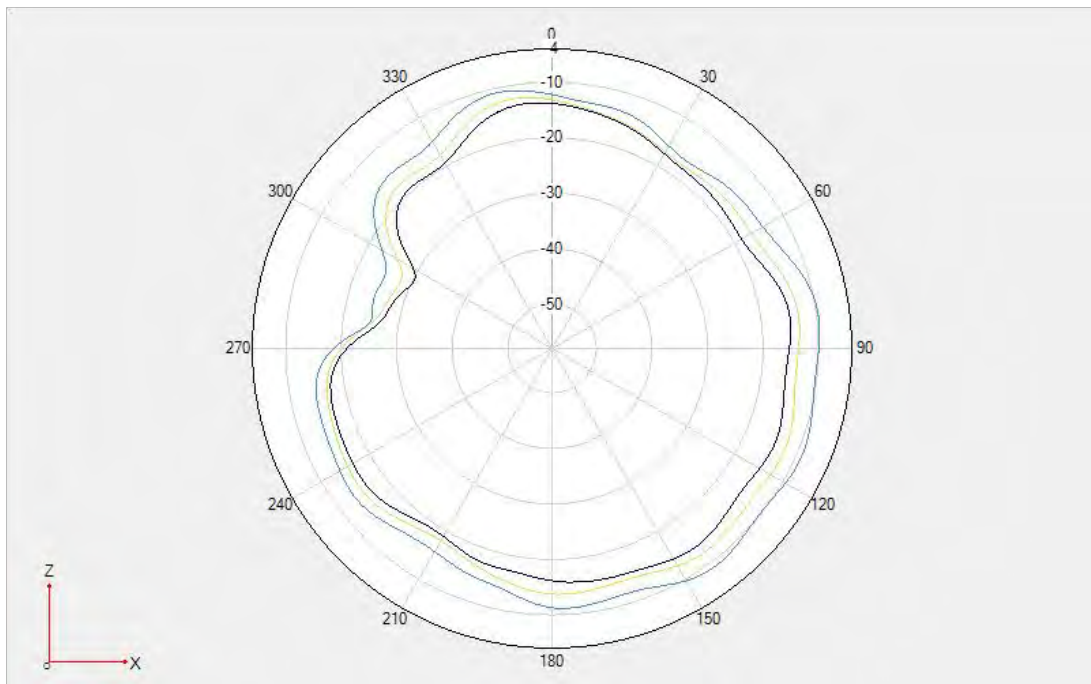

Unfold- DPDT SWAP:GSM 900/WCDMA B8/LTE B8 Phi=0deg

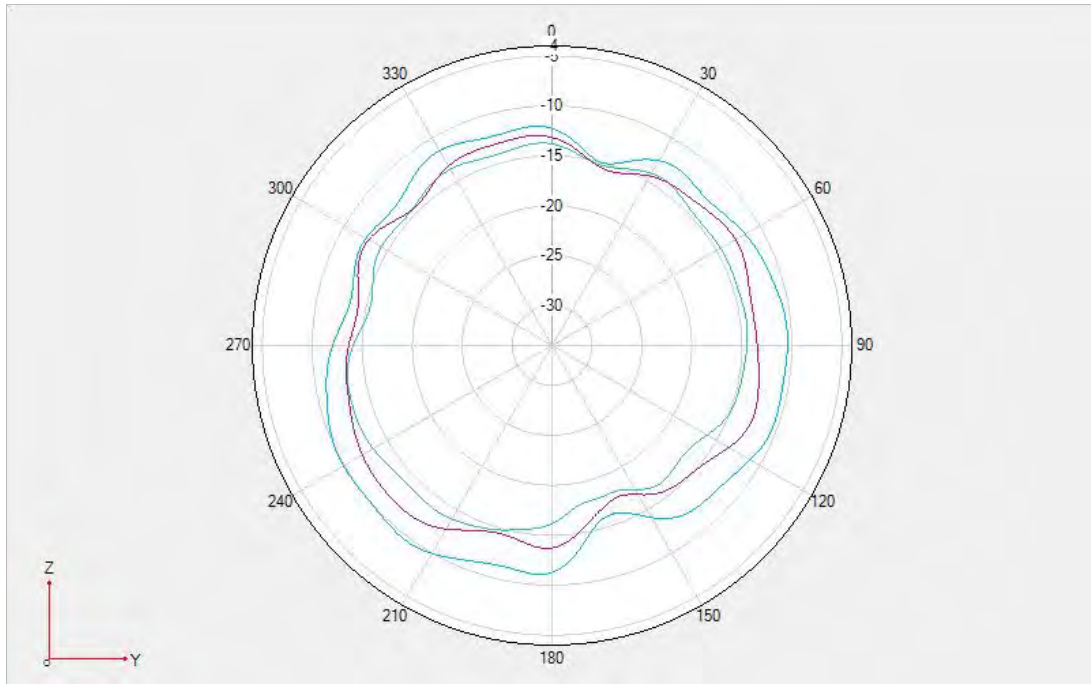

Unfold-DPDT SWAP:GSM 900/WCDMA B8/LTE B8 $\Phi=90\text{deg}$

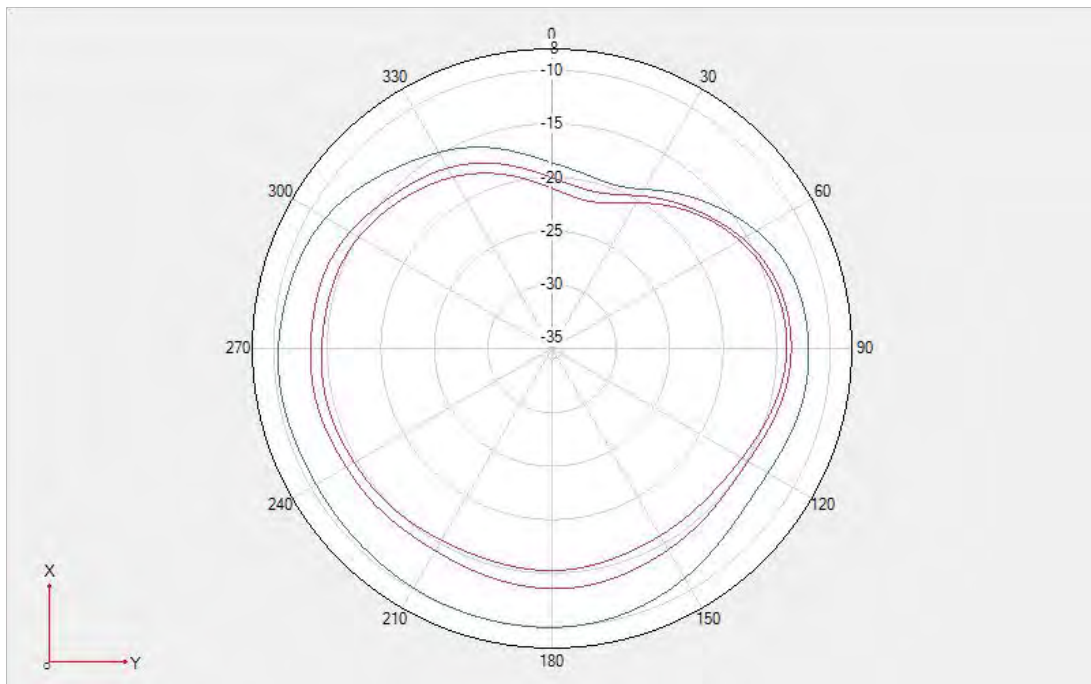

Unfold-DPDT SWAP:GSM 900/WCDMA B8/LTE B8 $\Theta=90\text{deg}$

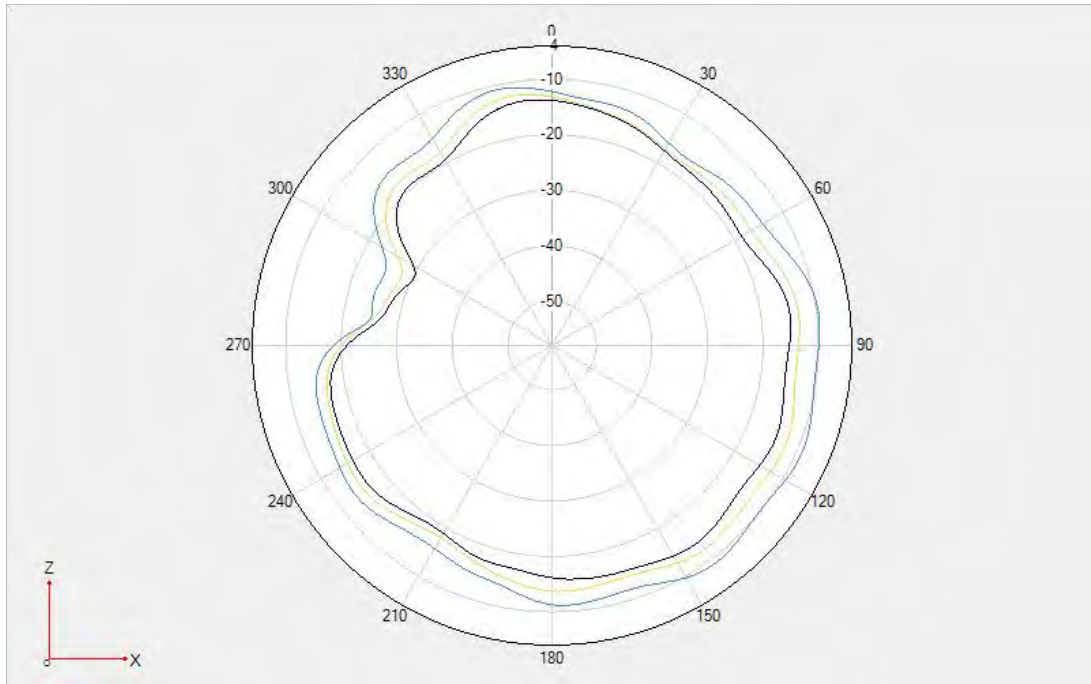

Fold- DPDT SWAP:GSM 900/WCDMA B8/LTE B8 $\Phi=0^\circ$

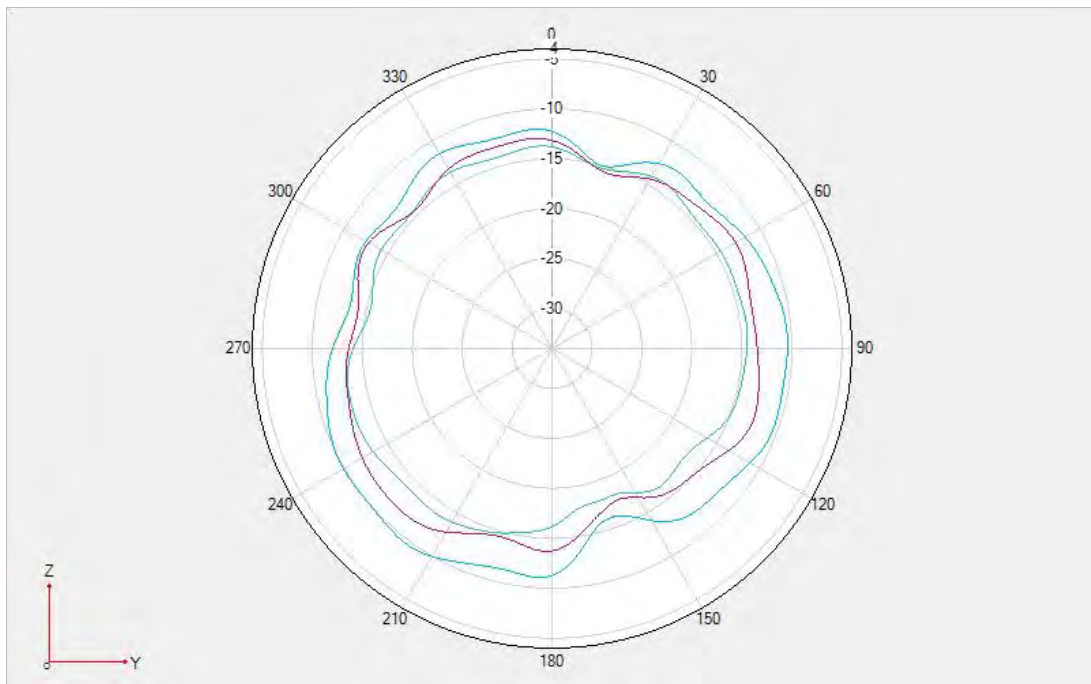

Fold- DPDT SWAP:GSM 900/WCDMA B8/LTE B8 $\Phi=90^\circ$

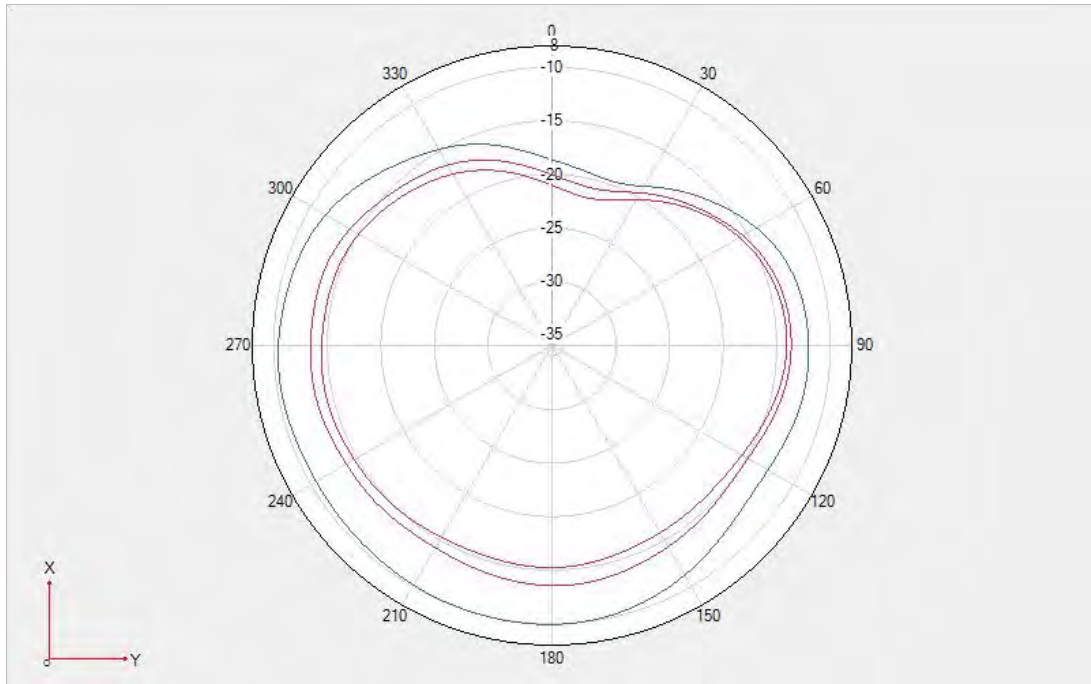

Fold- DPDT SWAP:GSM 900/WCDMA B8/LTE B8 Theta=90deg

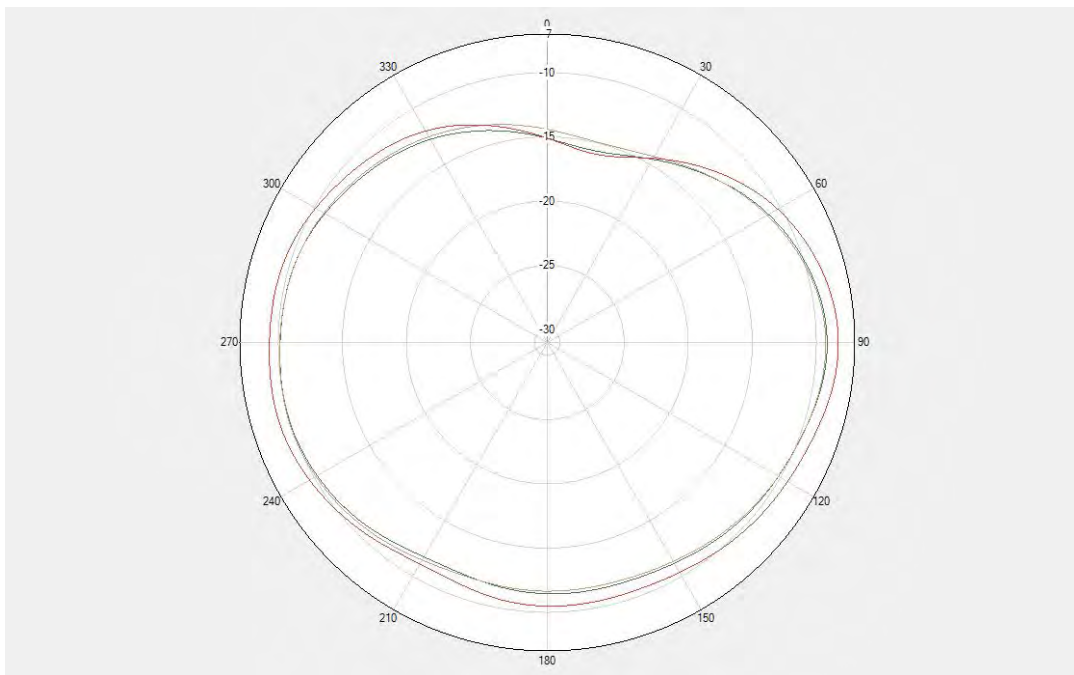

Unfold- DPDT SWAP LTE B20/N20 Phi=0deg

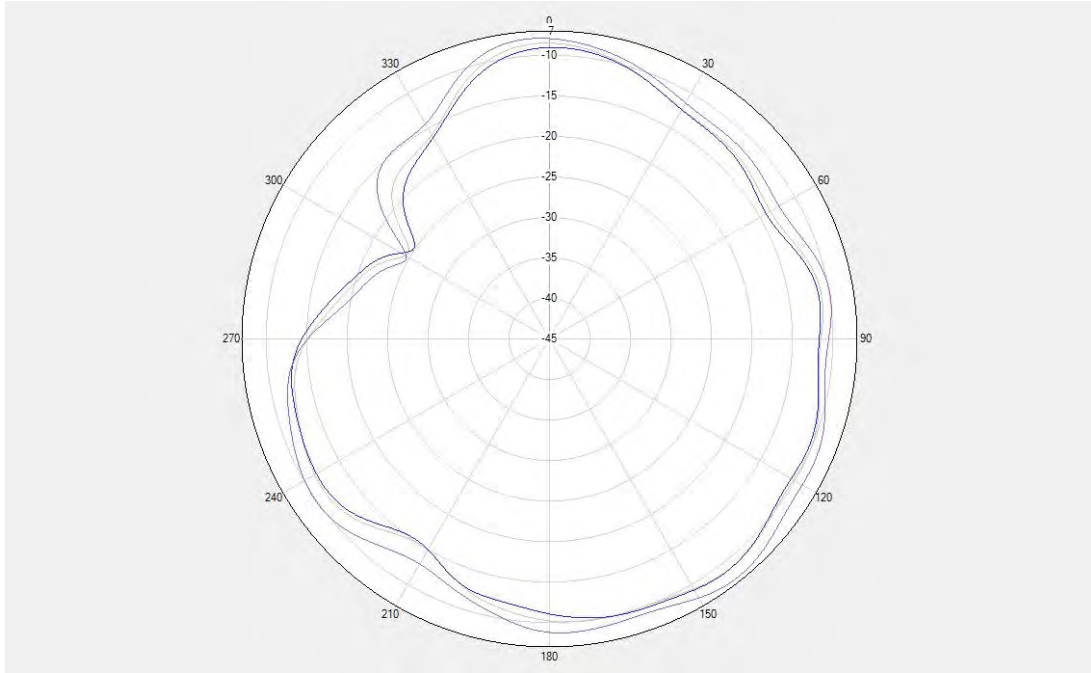

Unfold-DPDT SWAP LTE B20/N20 $\Phi=90^\circ$

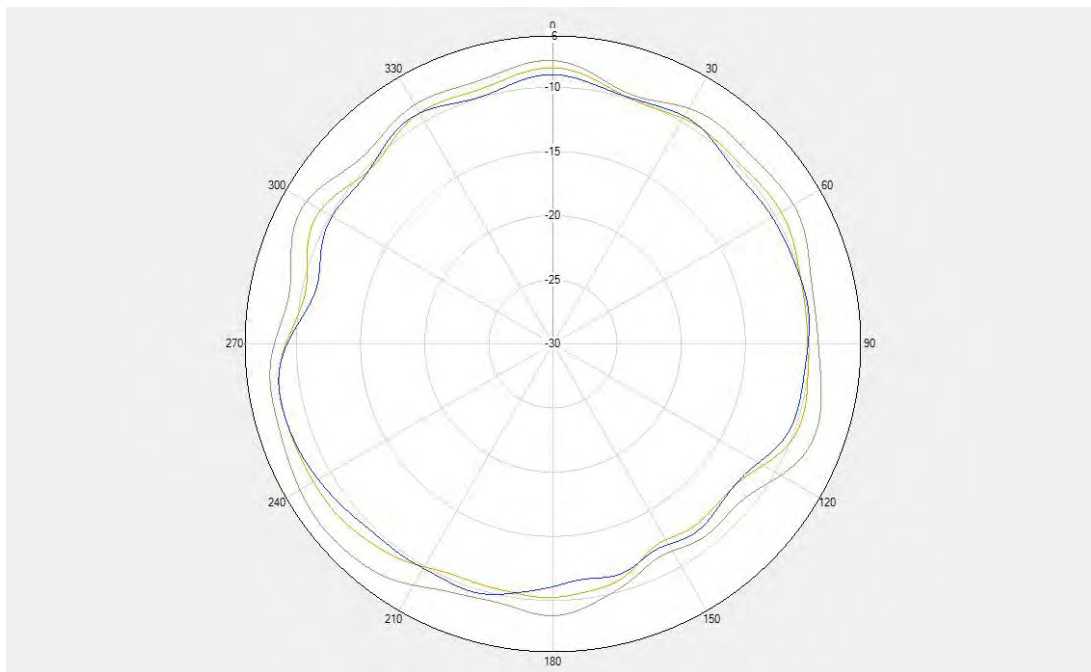

Unfold-DPDT SWAP LTE B20/N20 $\Theta=90^\circ$

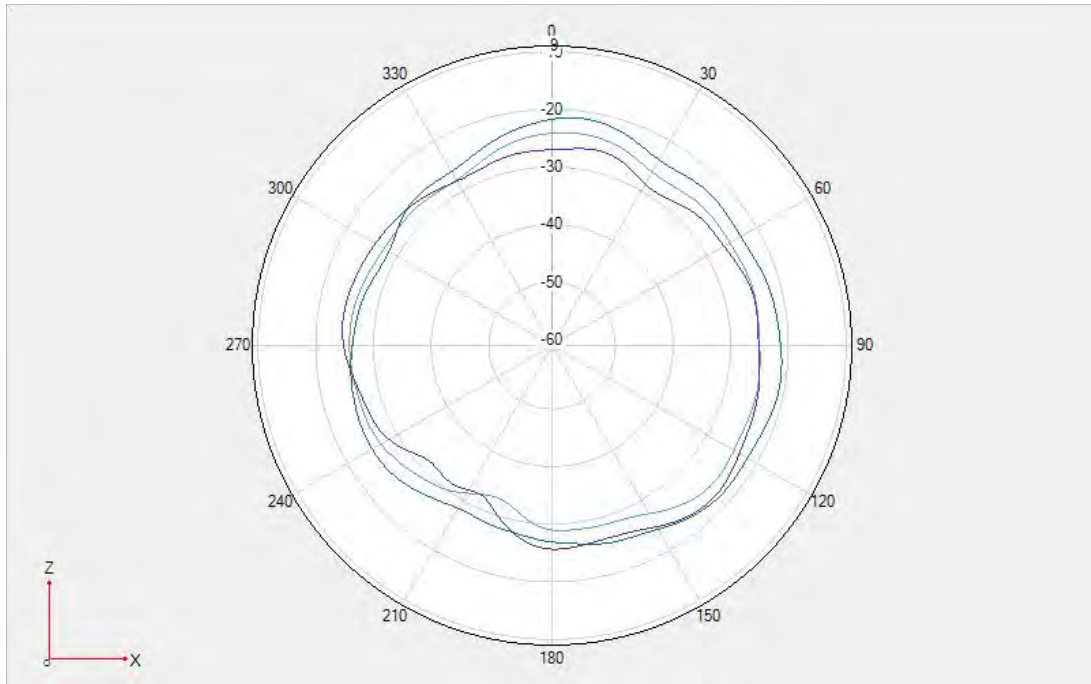

Fold- DPDT SWAPLTE B20/N20 $\Phi=0^\circ$

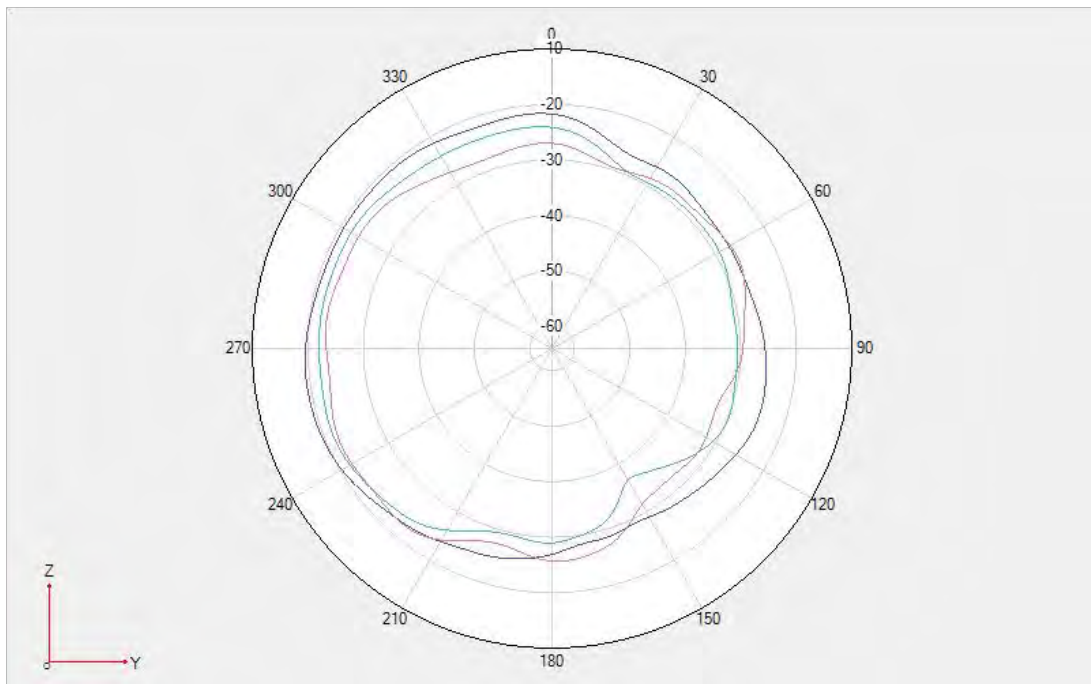

Fold-DPDT SWAP LTE B20/N20 $\Phi=90^\circ$

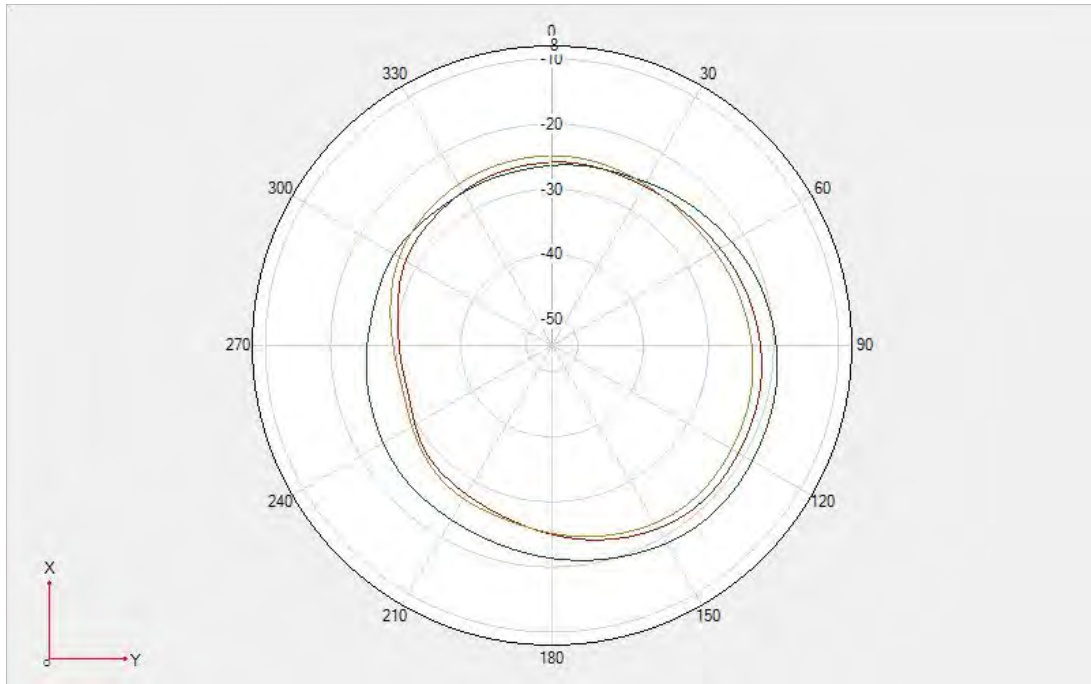

Fold- DPDT SWAPLTE B20/N20 Theta=90deg

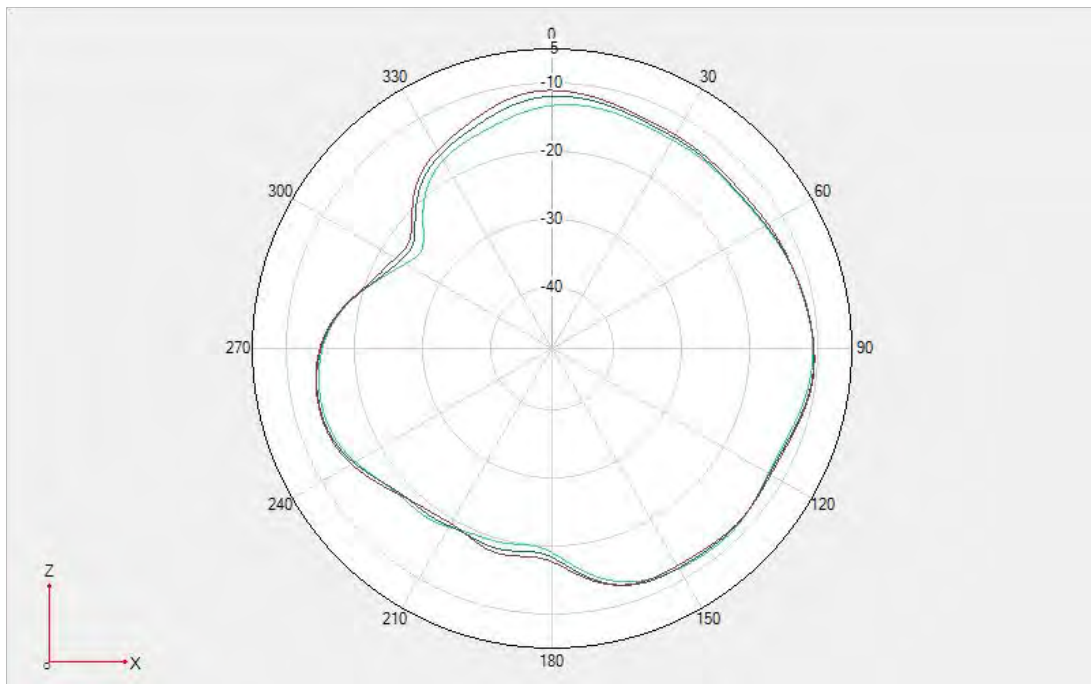

Unfold-DPDT SWAP LTE B28/N28 Phi=0deg

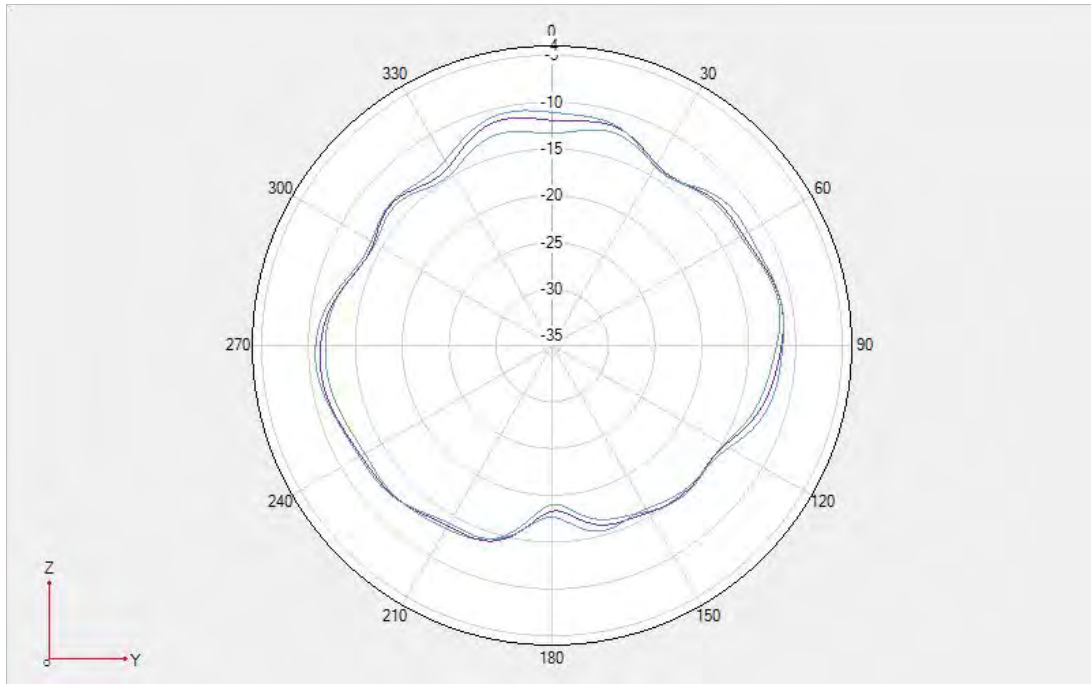

Unfold-DPDT SWAPLTE B28/N28 $\Phi=90^\circ$

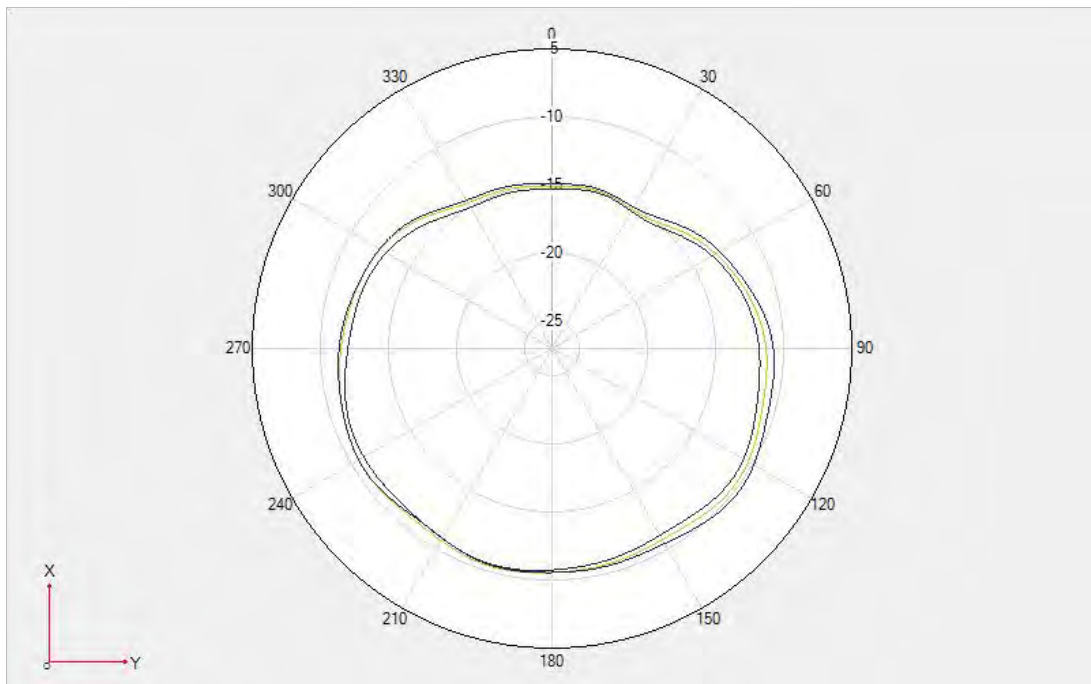

Unfold-DPDT SWAPLTE B28/N28 $\Theta=90^\circ$

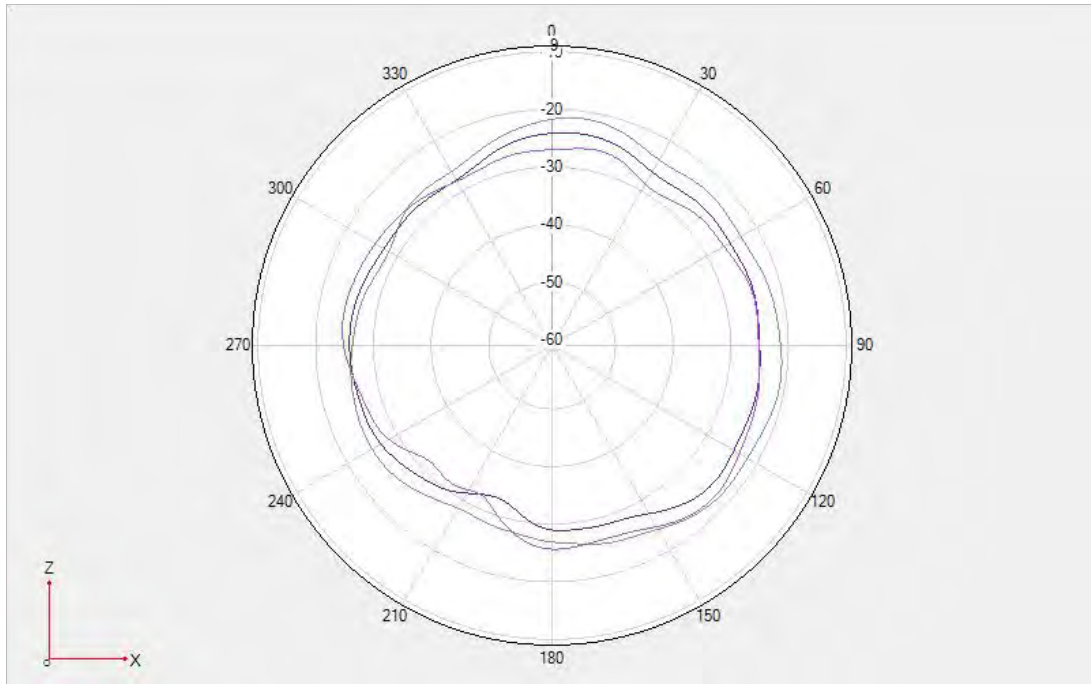

Fold- DPDT SWAPLTE B28/N28 $\Phi = 0^\circ$

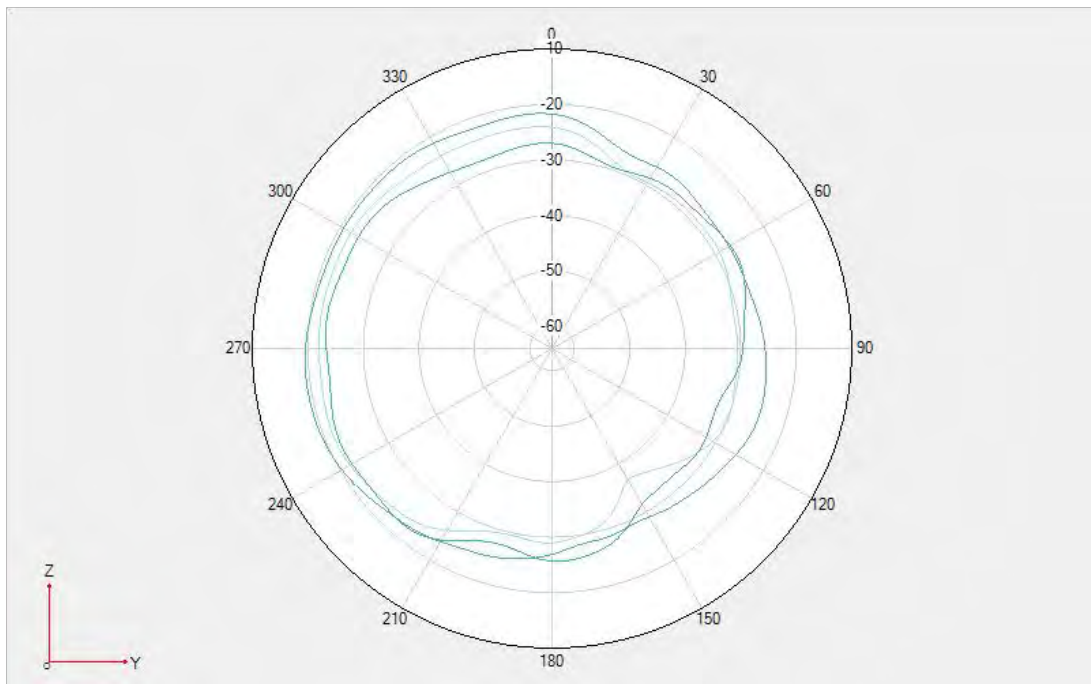

Fold- DPDT SWAPLTE B28/N28 $\Phi = 90^\circ$

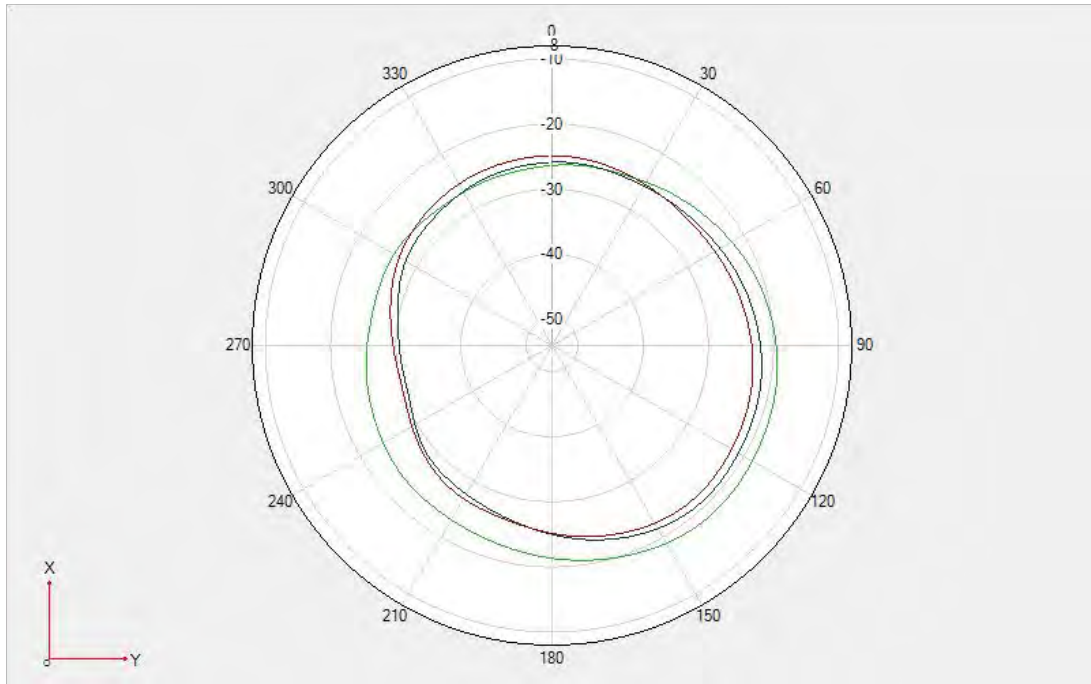

Fold-DPDT SWAP LTE B28/N28 Theta=90deg

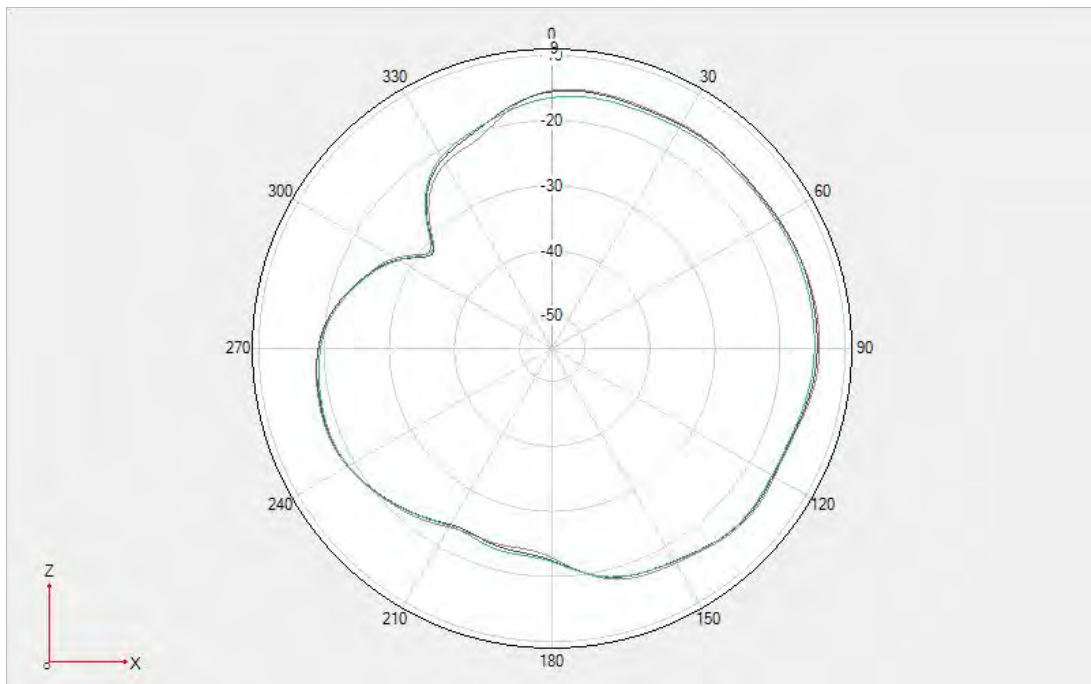

Unfold-DPDT SWAP N71 Phi=0deg

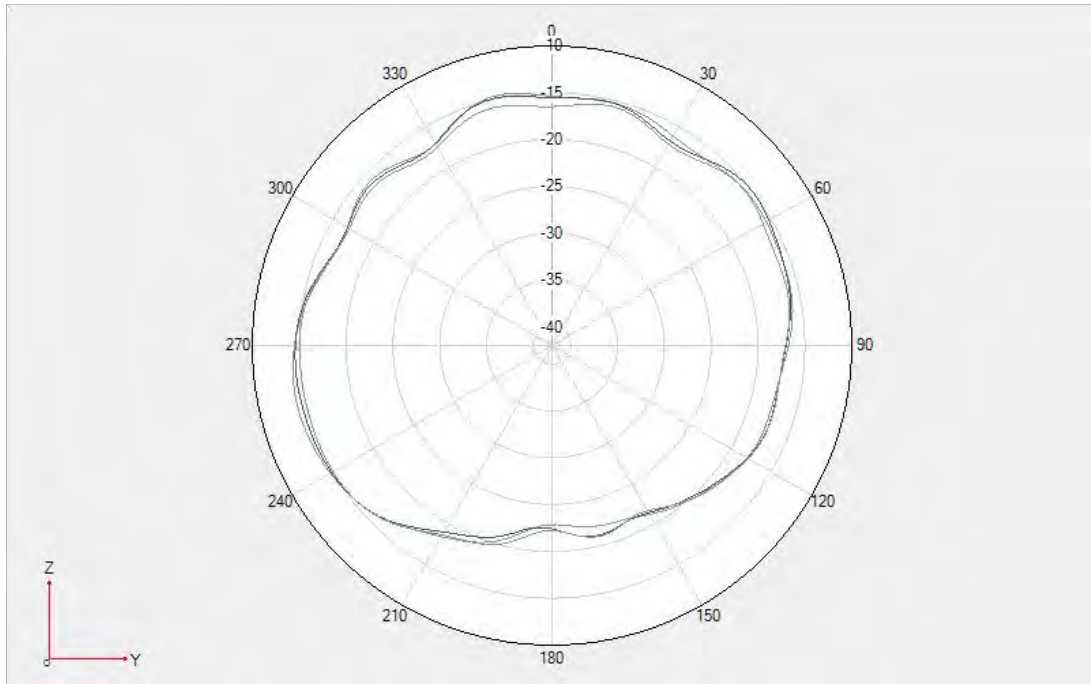

Unfold-DPDT SWAP N71 Phi=90deg

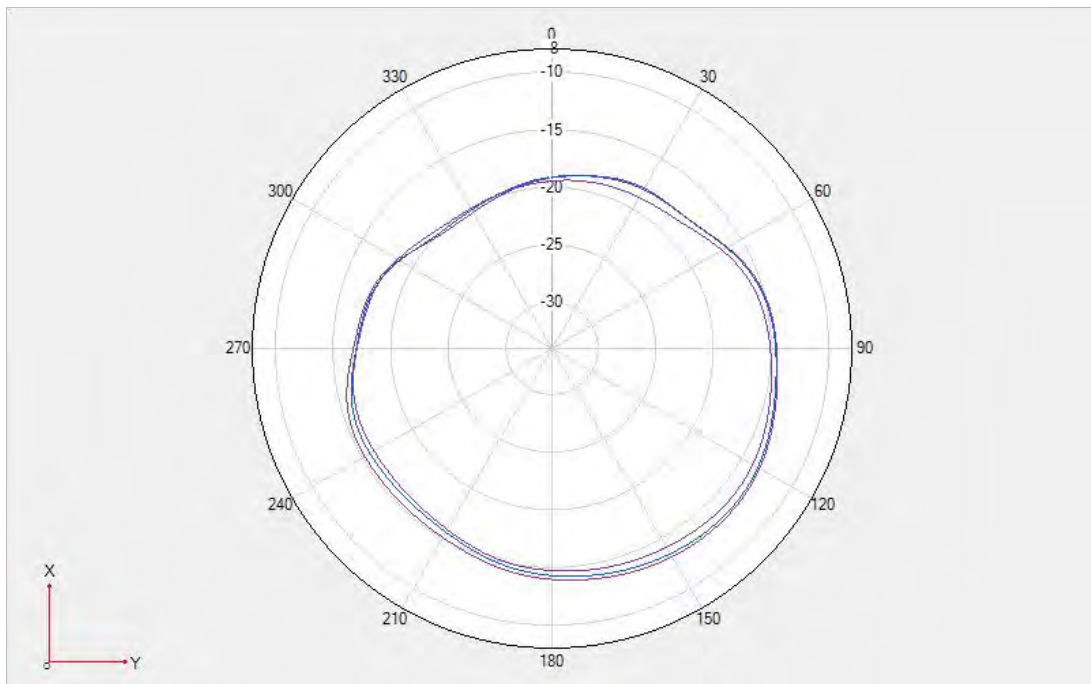

Unfold-DPDT SWAP N71 Theta=90deg

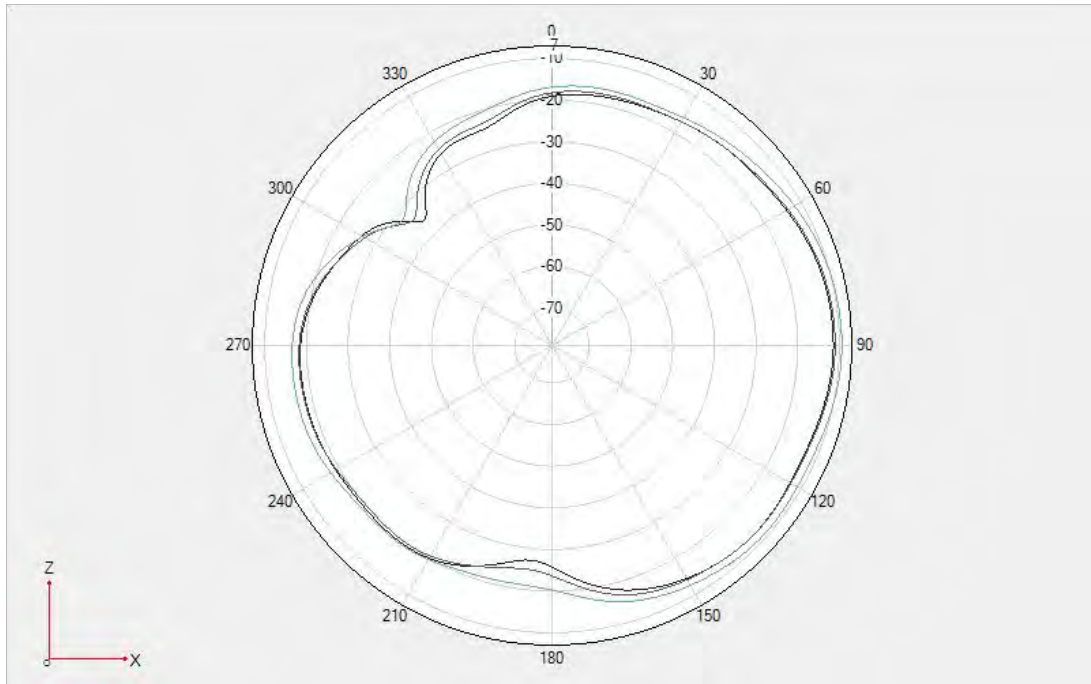

Fold-DPDT SWAP N71 $\Phi=0^\circ$

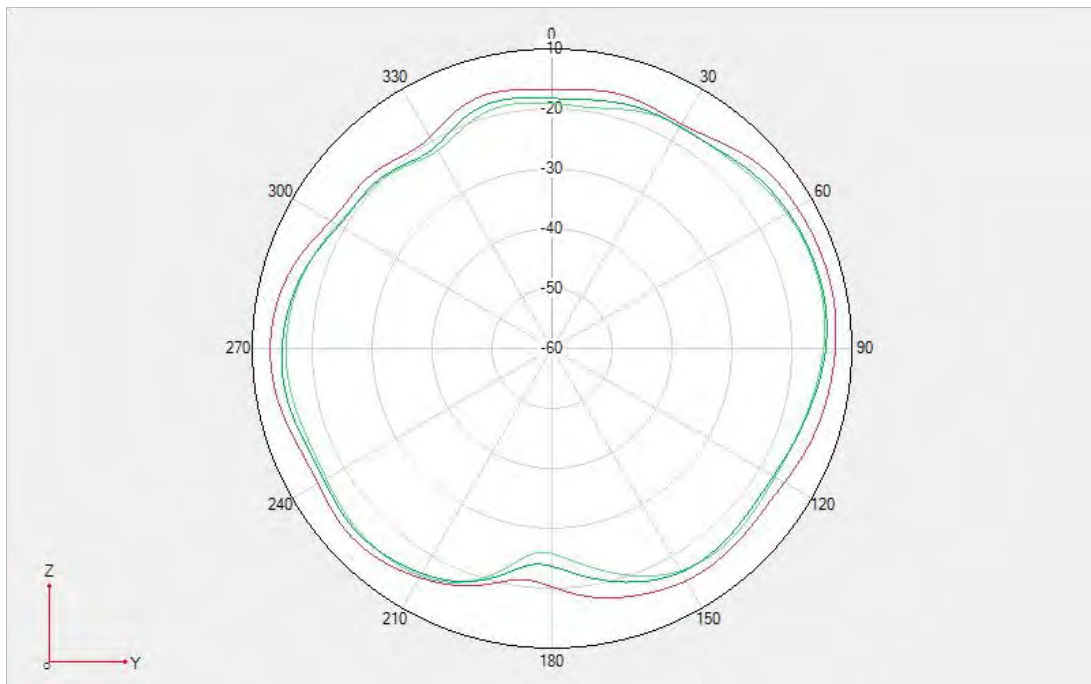

Fold-DPDT SWAP N71 $\Phi=90^\circ$

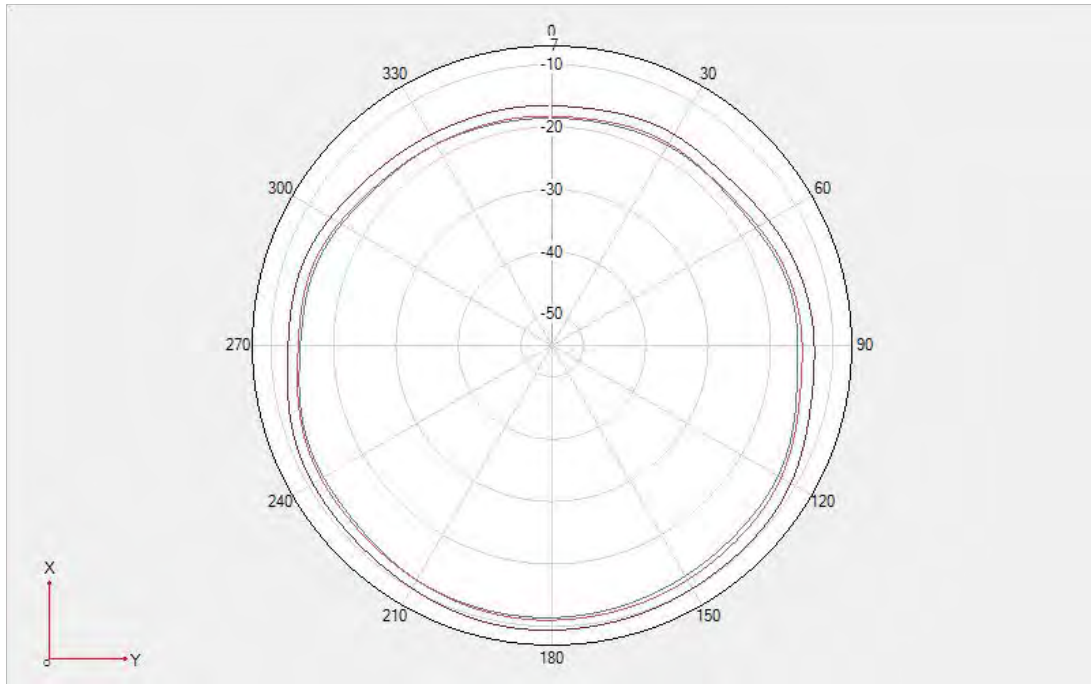

Fold-DPDT SWAP N71 Theta=90deg

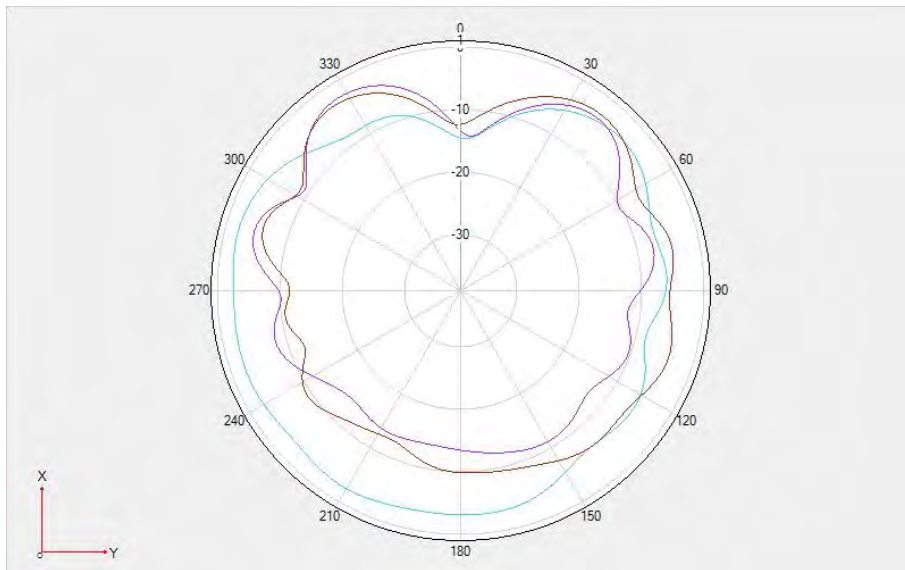

Unfold- NR n38/41DRX1 theta =90

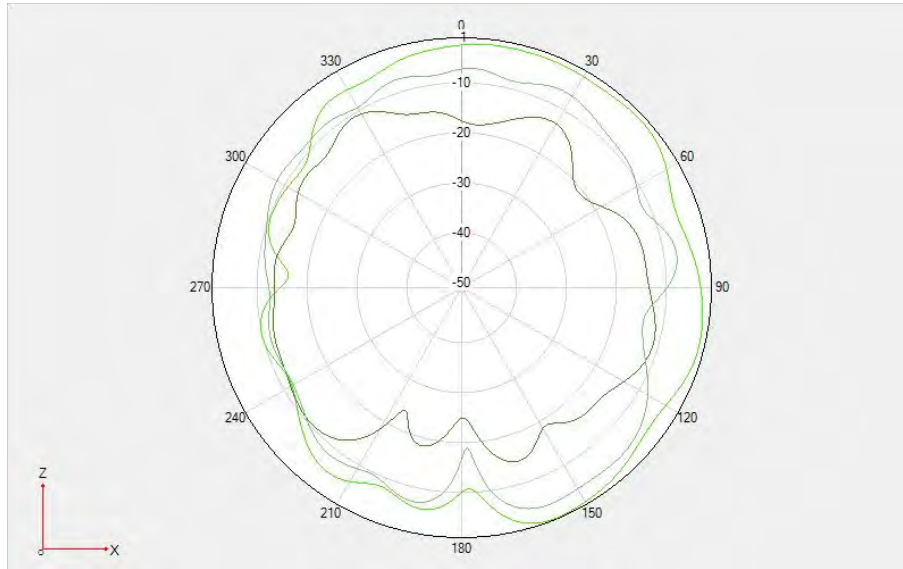

Unfold- NR n38/41DRX1 $\phi=0$

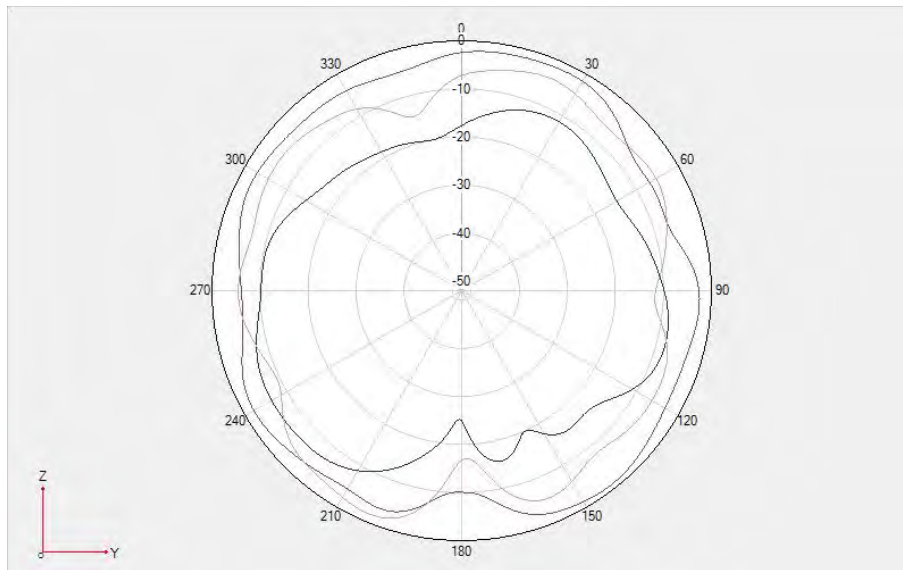

Unfold- NR n38/41DRX1 phi=90

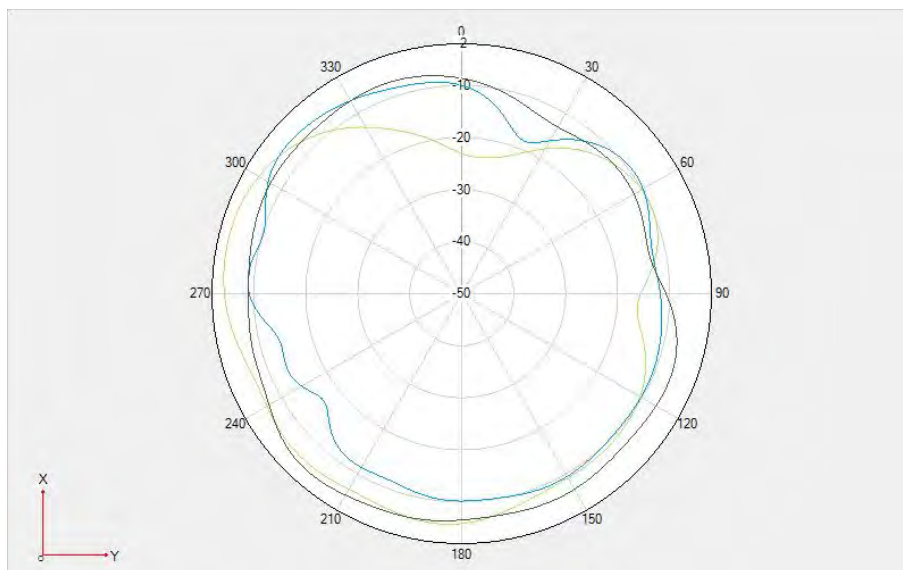

Fold- NR n38/41 DRX1 theta =90

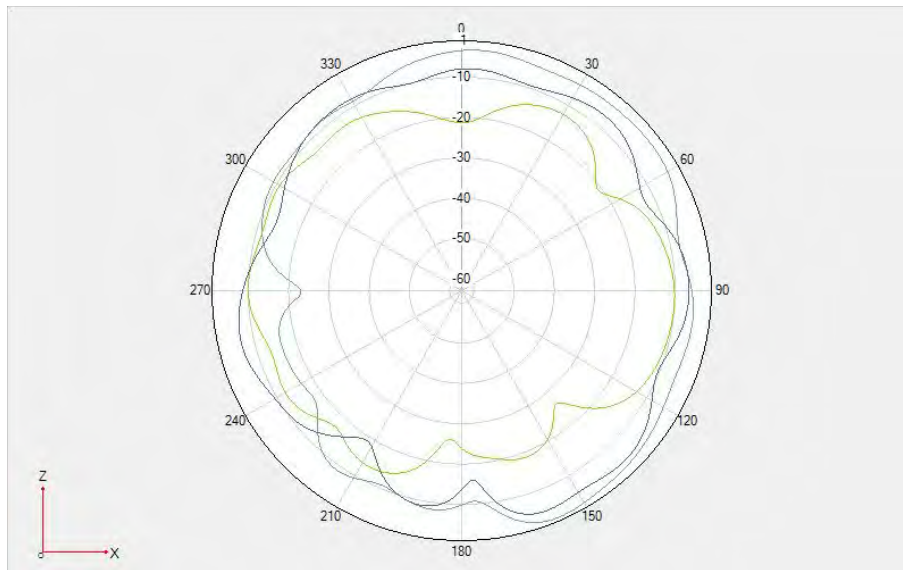

Fold- NR n38/41DRX1 $\phi=0$

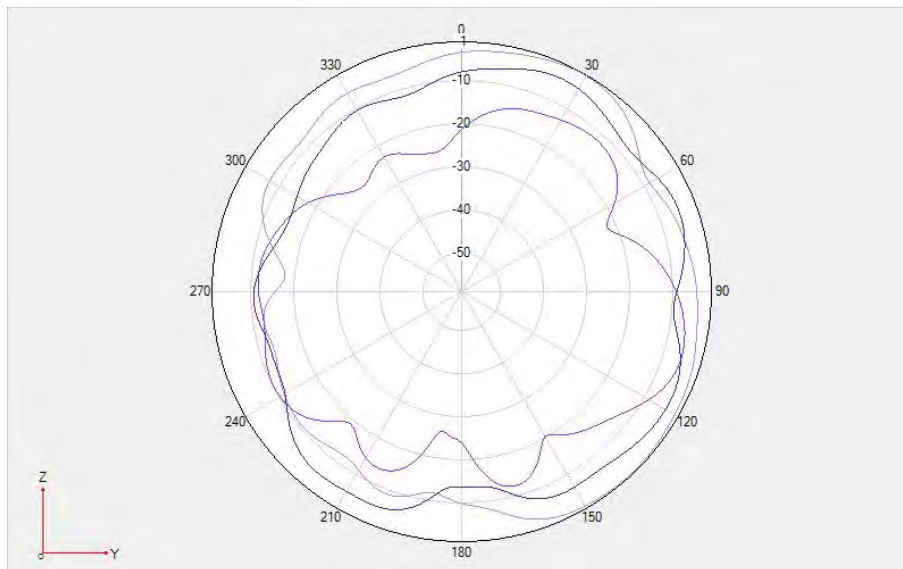

Fold- NR n38/41 DRX1 $\phi=90$

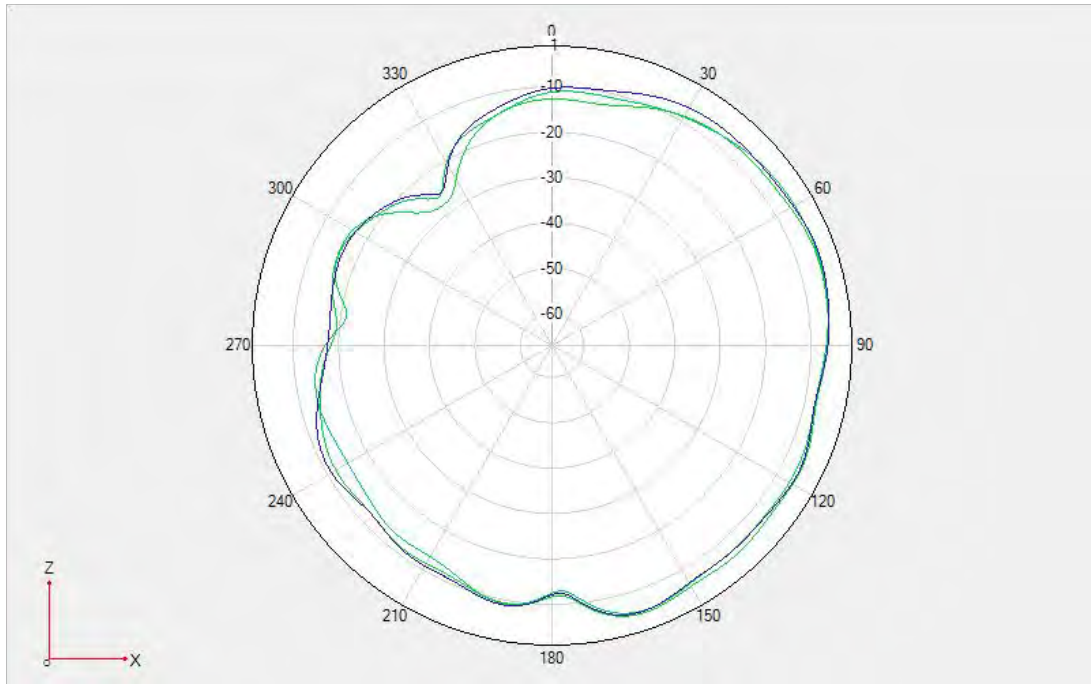

Unfold- NR n38DRX2 $\Phi=0^\circ$

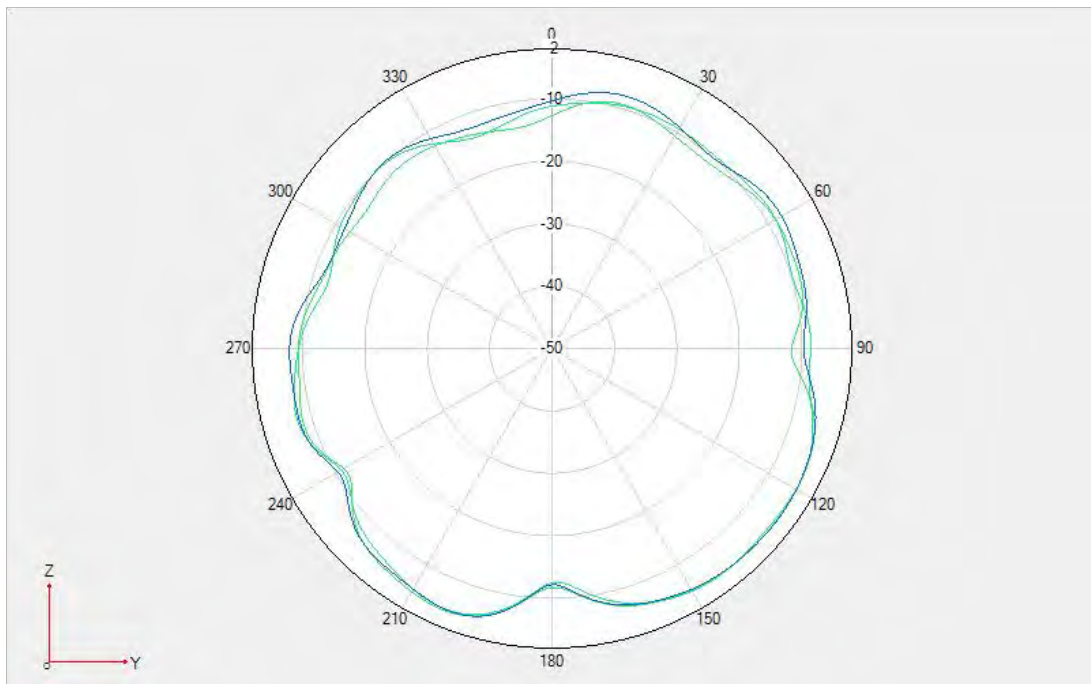

Unfold- NR n38DRX2 $\Phi=90^\circ$

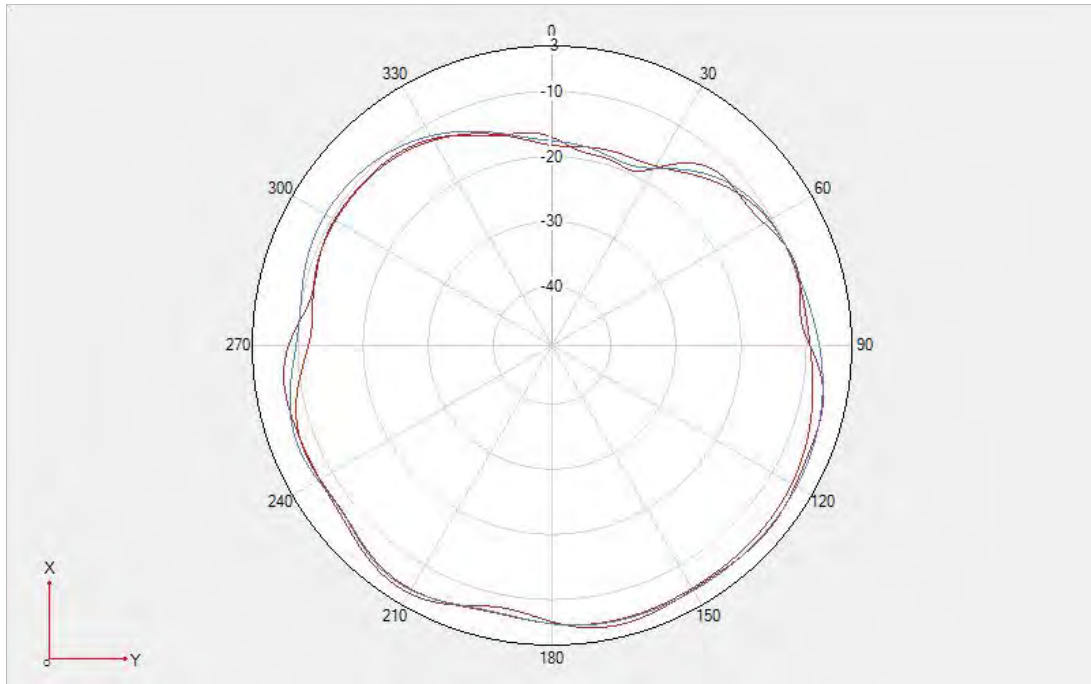

Unfold- NRn38 DRX2 Theta=90deg

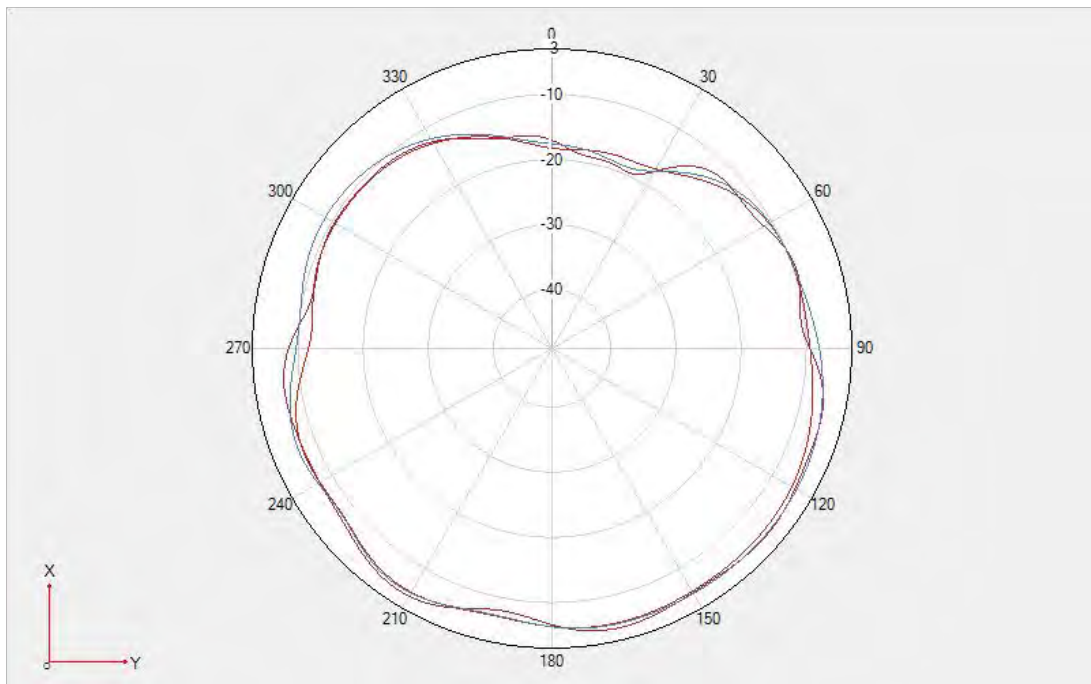

Fold- NR n38DRX2 Phi=0deg

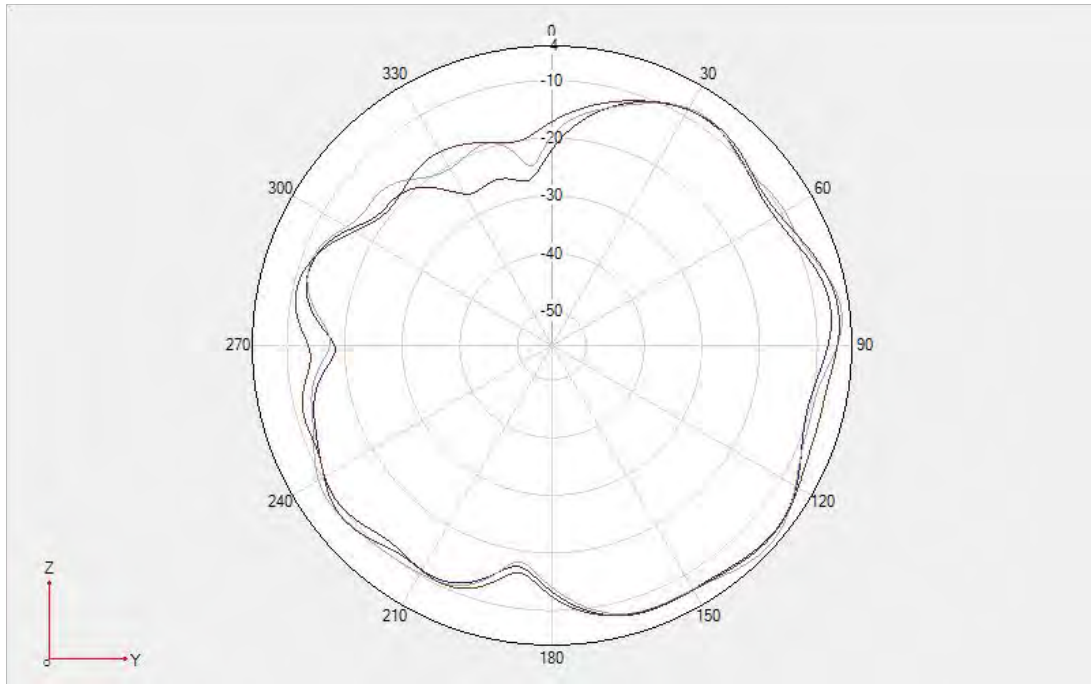

Fold- NR n38DRX2 $\Phi=90\text{deg}$

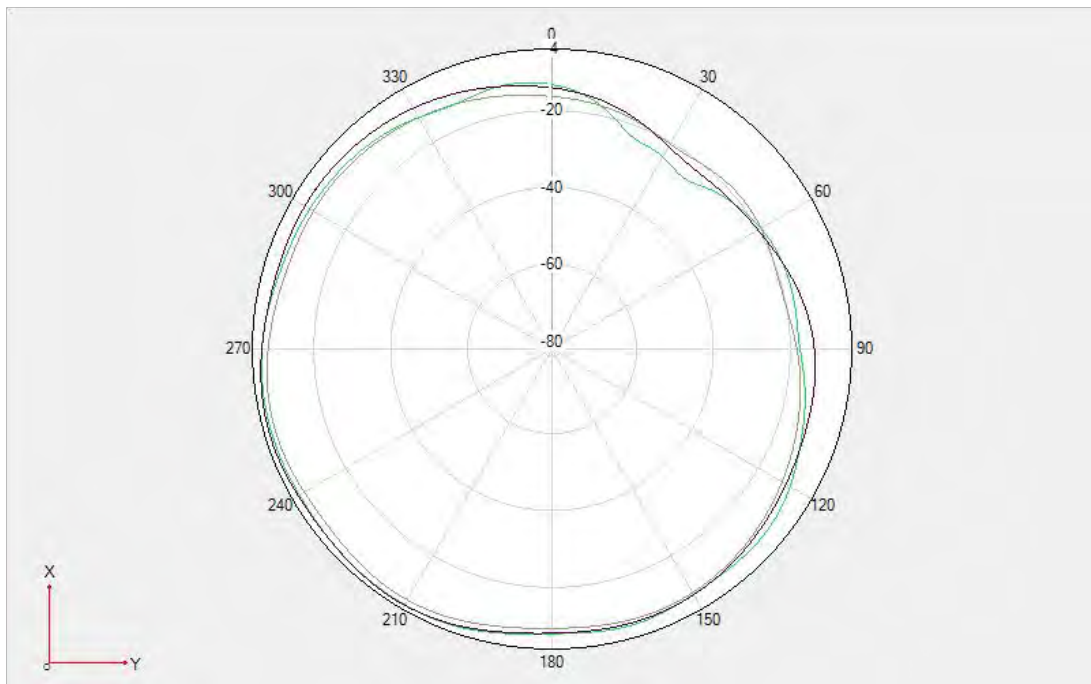

Fold- NR n38 DRX2 $\Theta=90\text{deg}$

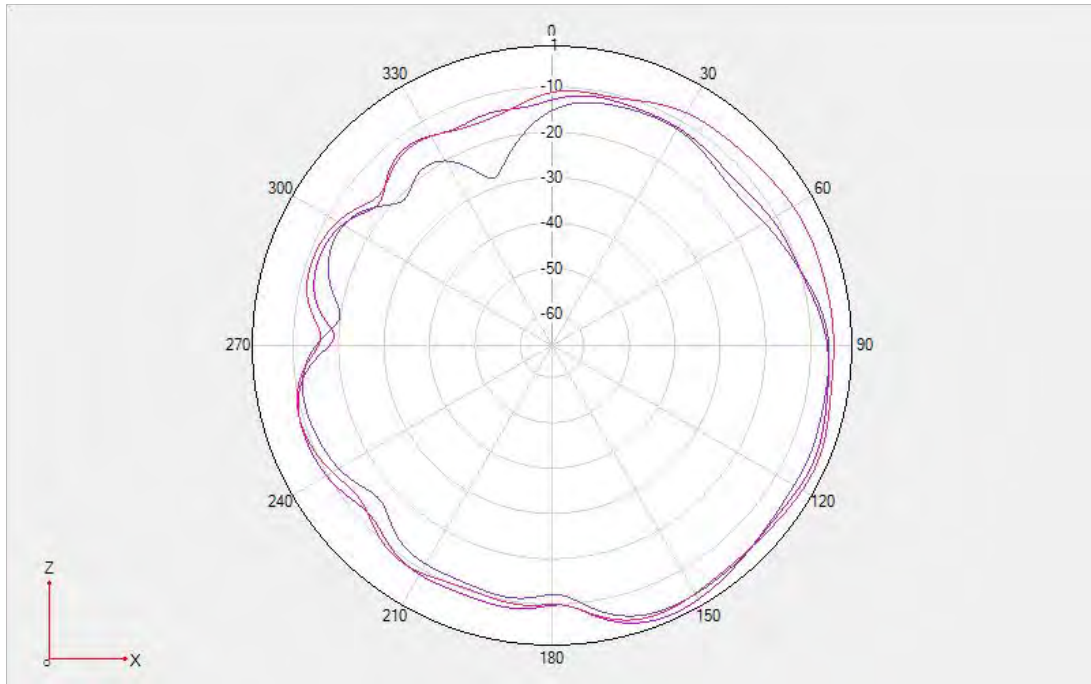

Unfold- NR n40DRX2 Phi=0deg

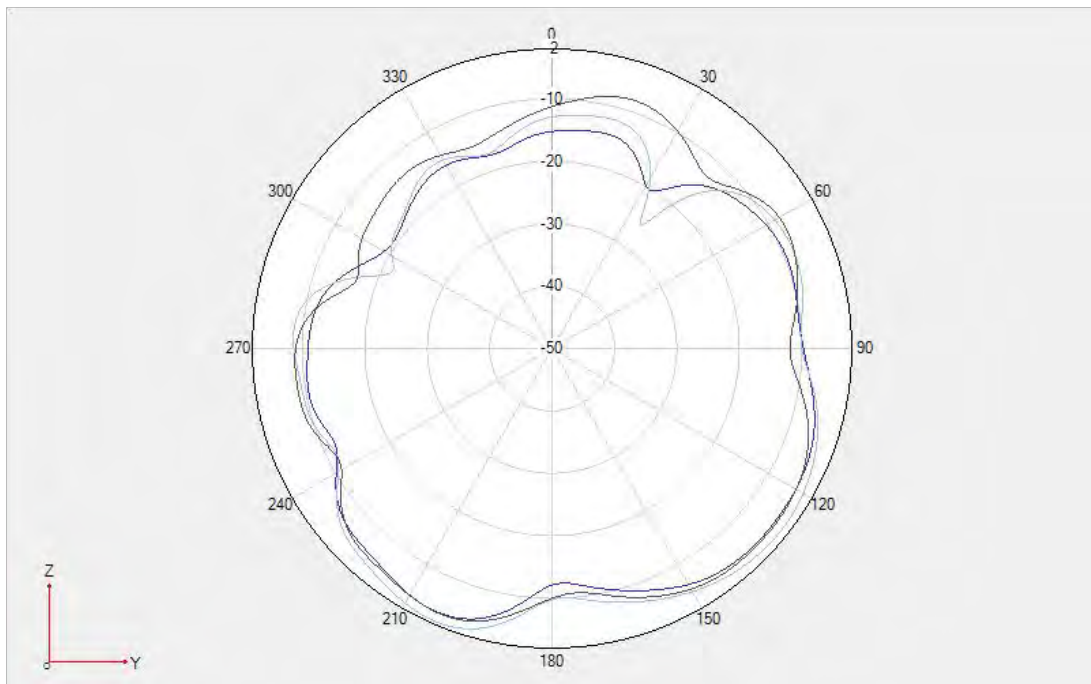

Unfold- NR n40 DRX2 Phi=90deg

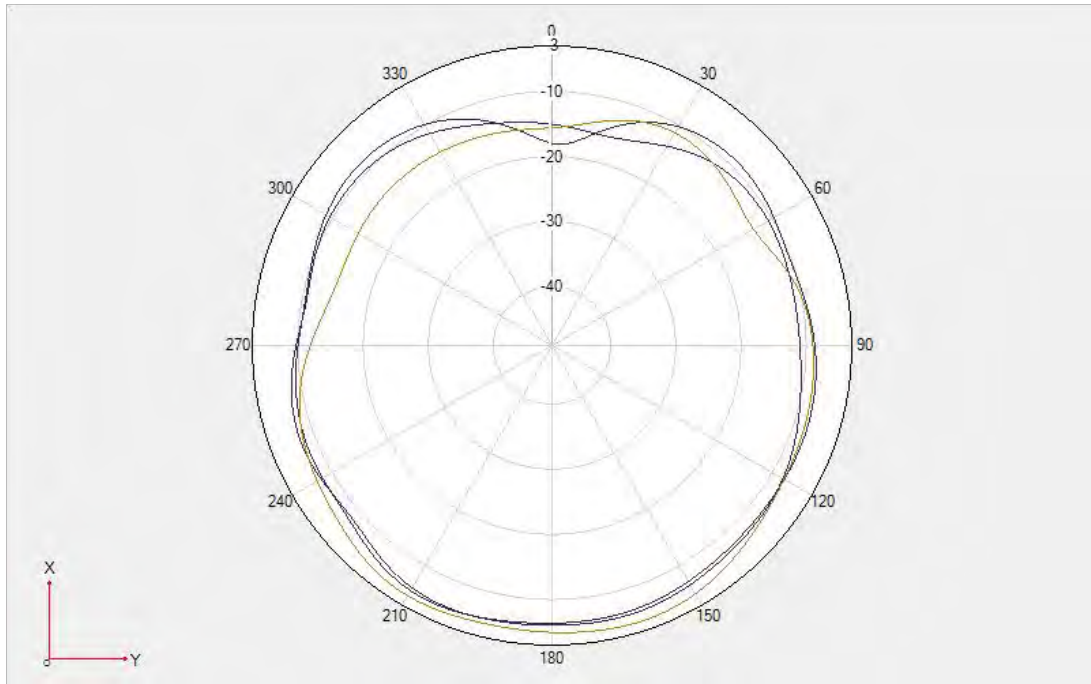

Unfold- NRn40DRX2 $\Theta = 90^\circ$

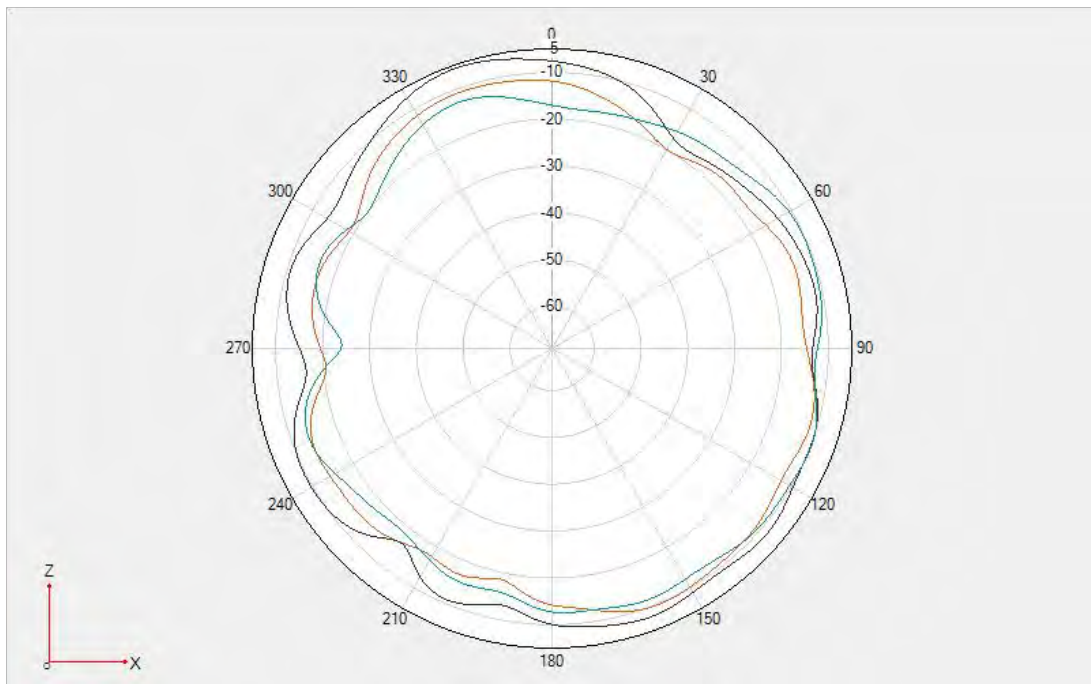

Fold- NR n40DRX2 $\Phi = 0^\circ$

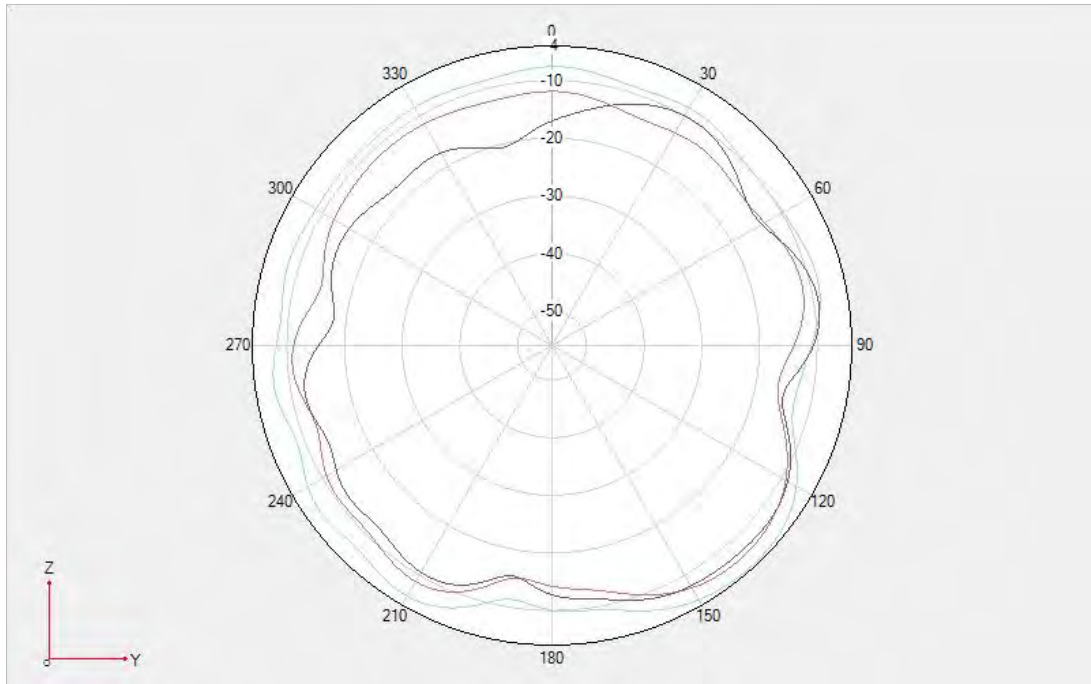

Fold- NR n40DRX2 $\Phi=90\text{deg}$

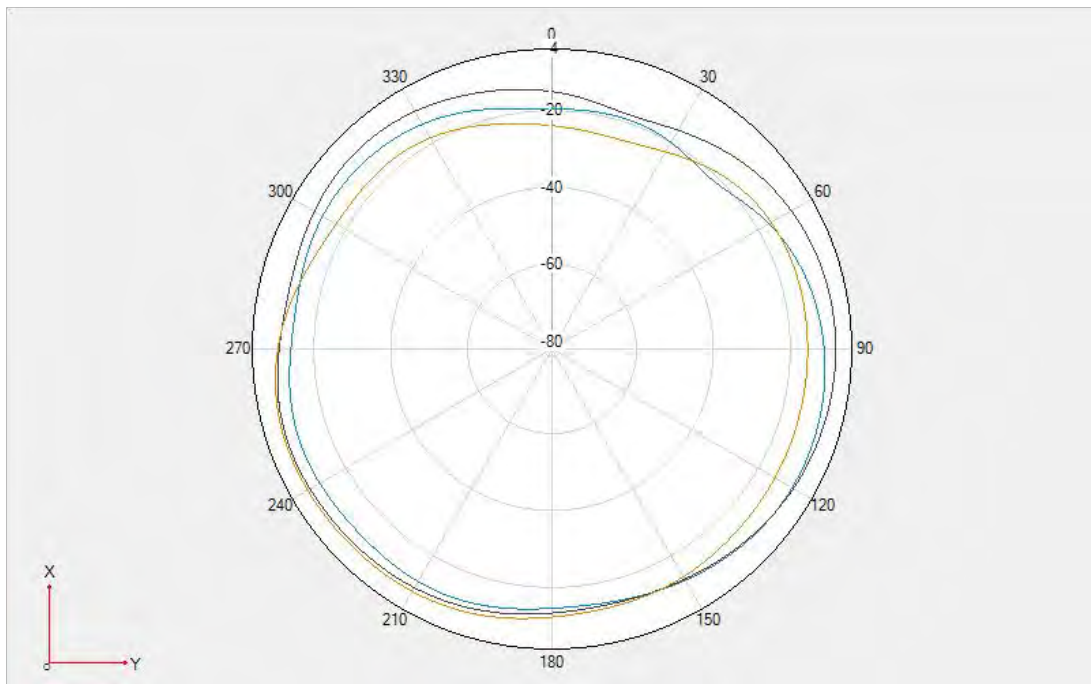

Fold- NR n40DRX2 $\Theta=90\text{deg}$

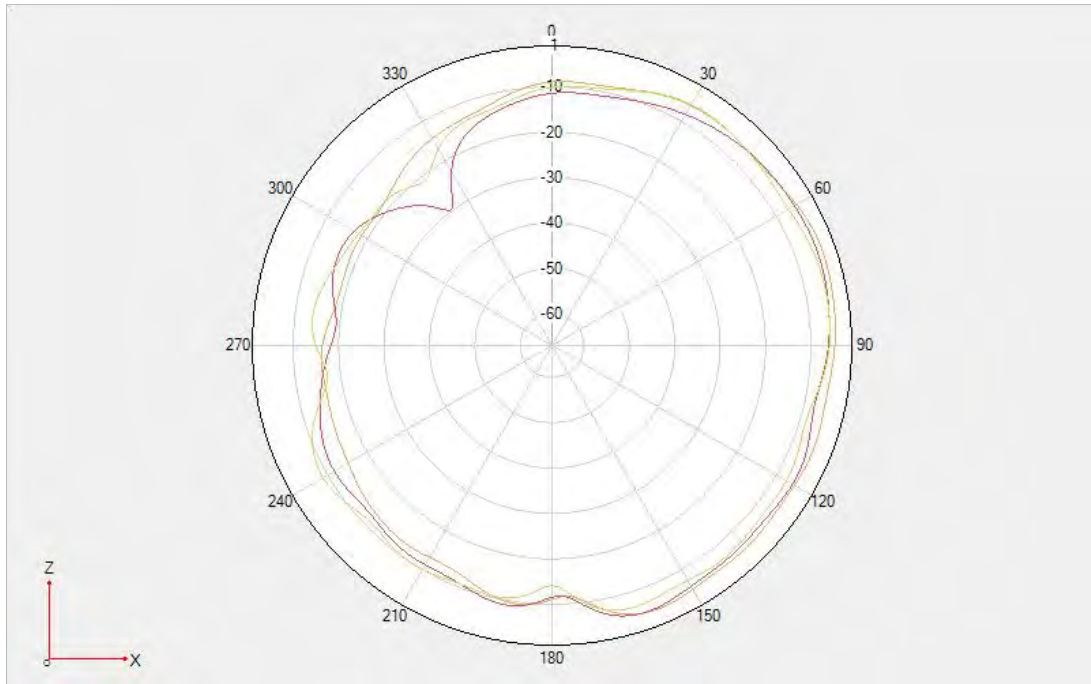

Unfold- NR n41DRX2 $\Phi=0^\circ$

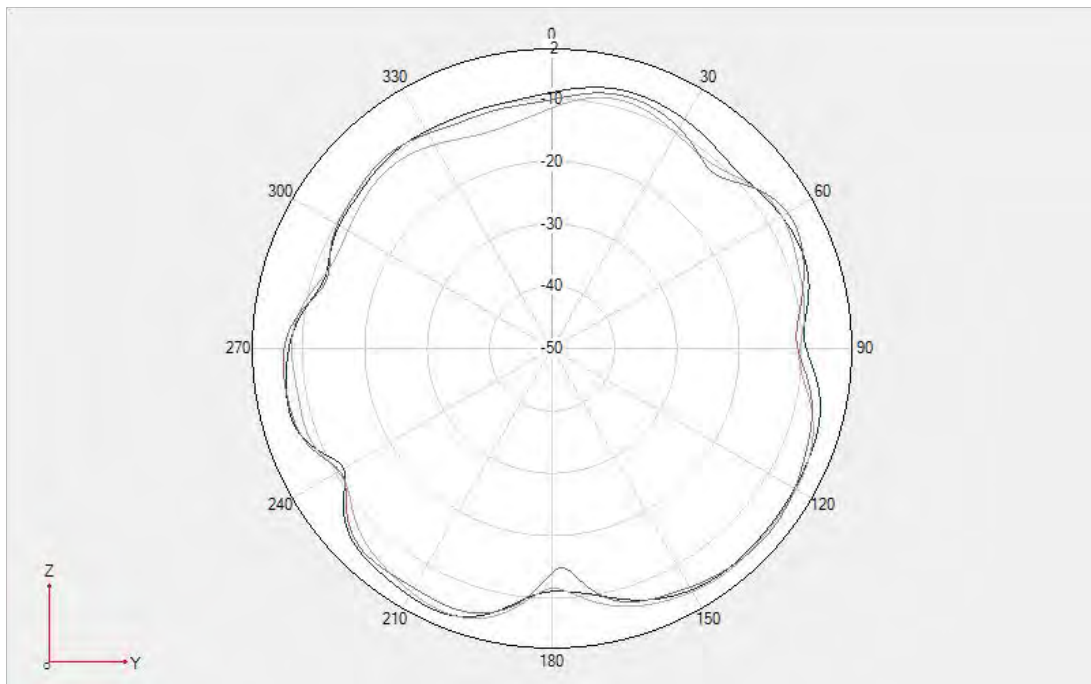

Unfold- NR n41DRX2 $\Phi=90^\circ$

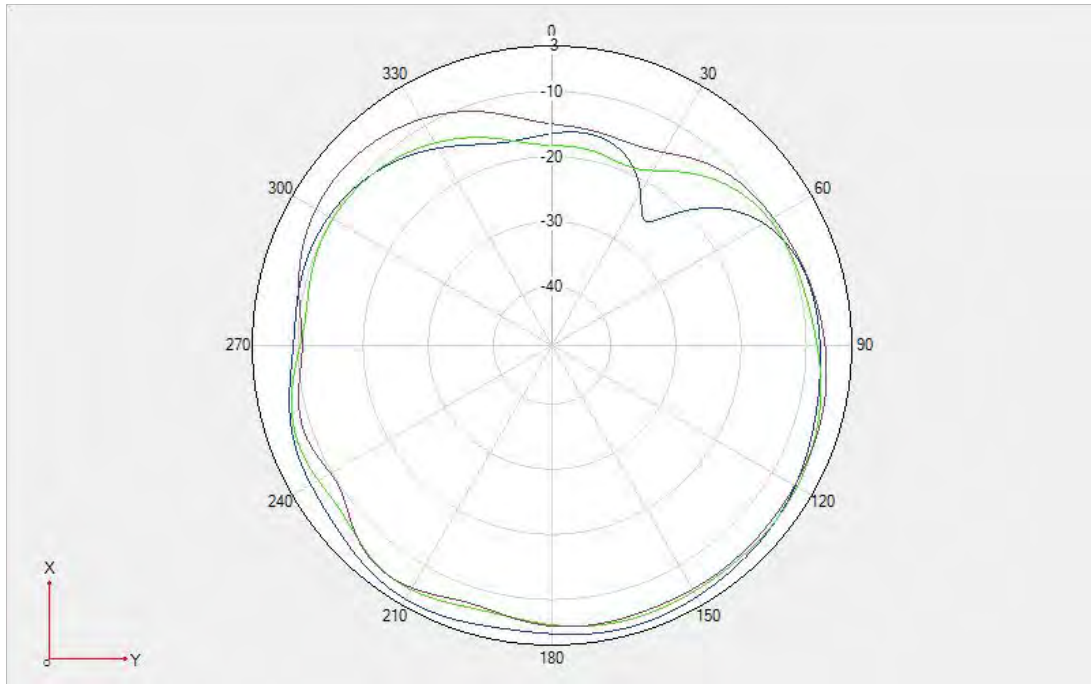

Unfold- NRn41 DRX2 Theta=90deg

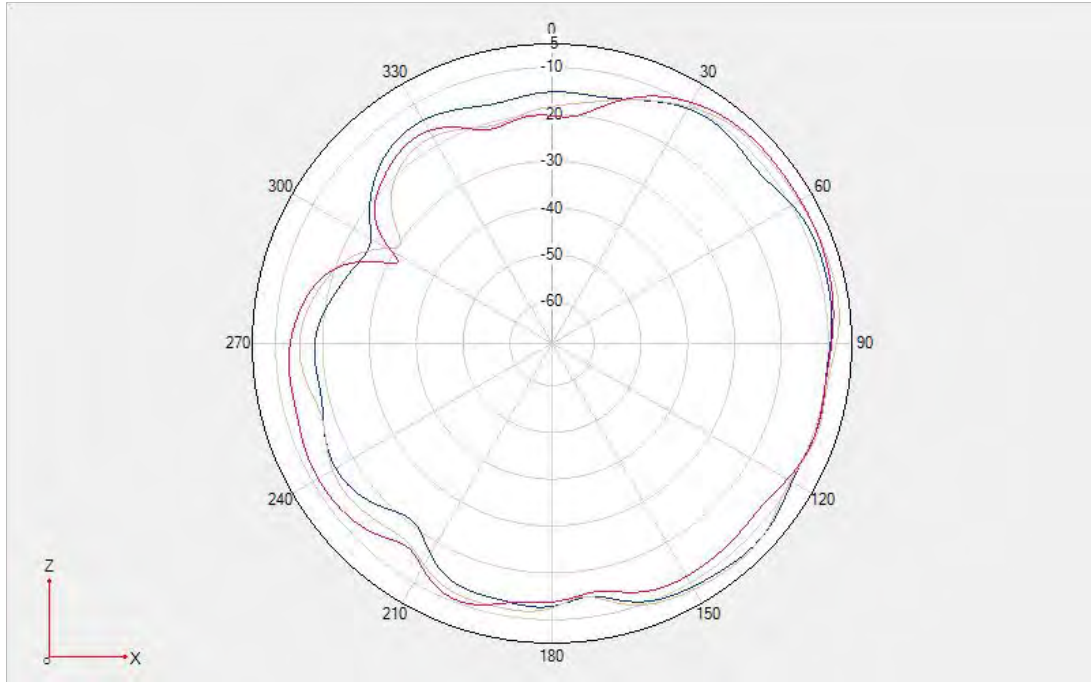

Fold- NR n41DRX2 Phi=0deg

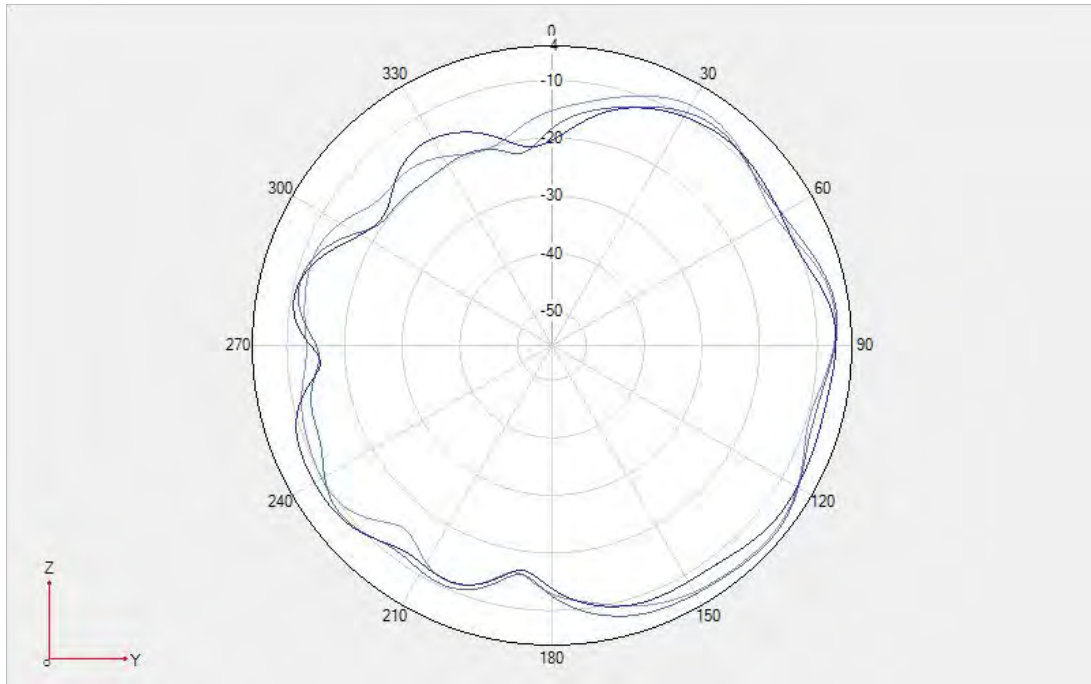

Fold- NR n41DRX2 Phi=90deg

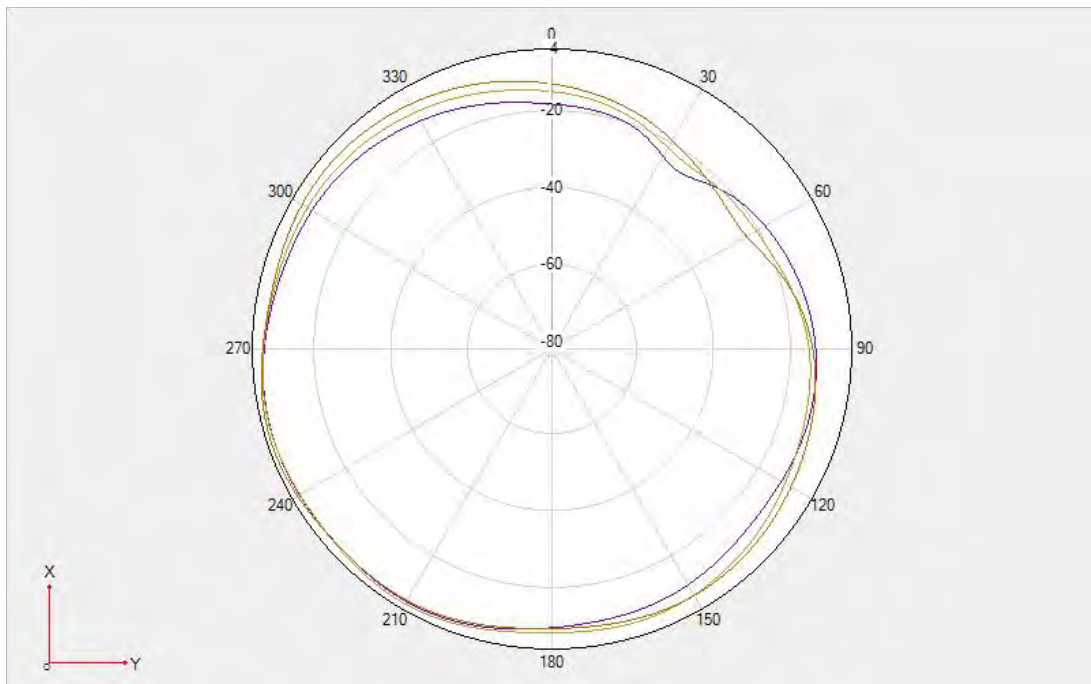

Fold- NR n41 DRX2 Theta=90deg

SUB 6G LDS3- DRX2 Antenna fold&unfold

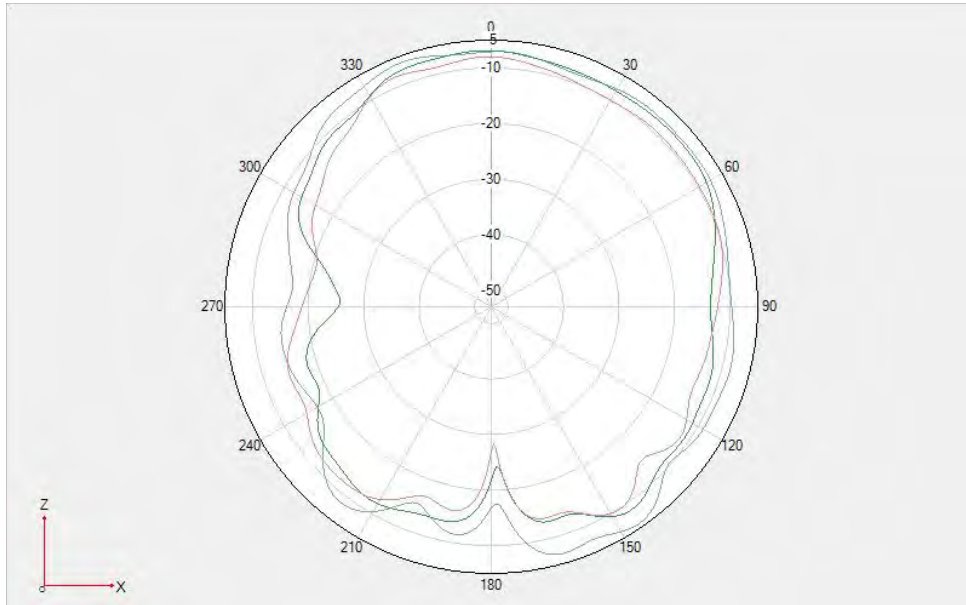

N79 DRX2 Antenna fold&unfold $\Phi = 0^\circ$

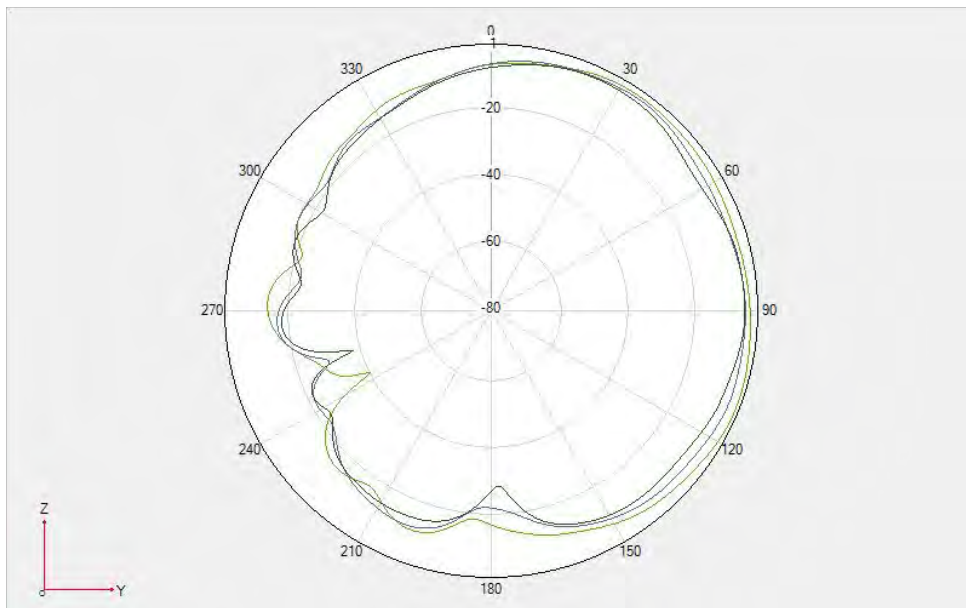

N79 DRX2 Antenna fold&unfold $\Phi = 90^\circ$

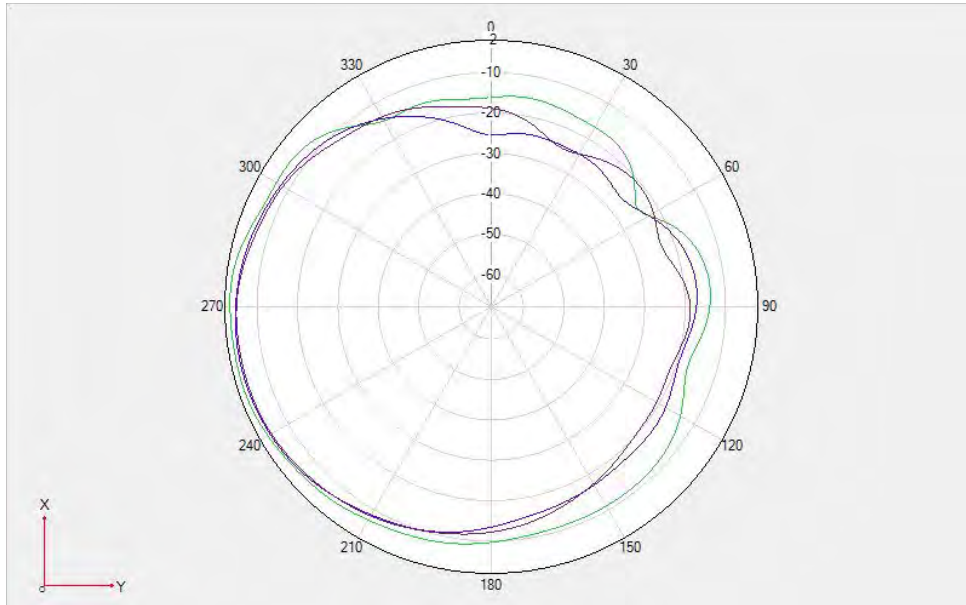

N79 DRX2 Antenna fold&unfold Theta=90deg

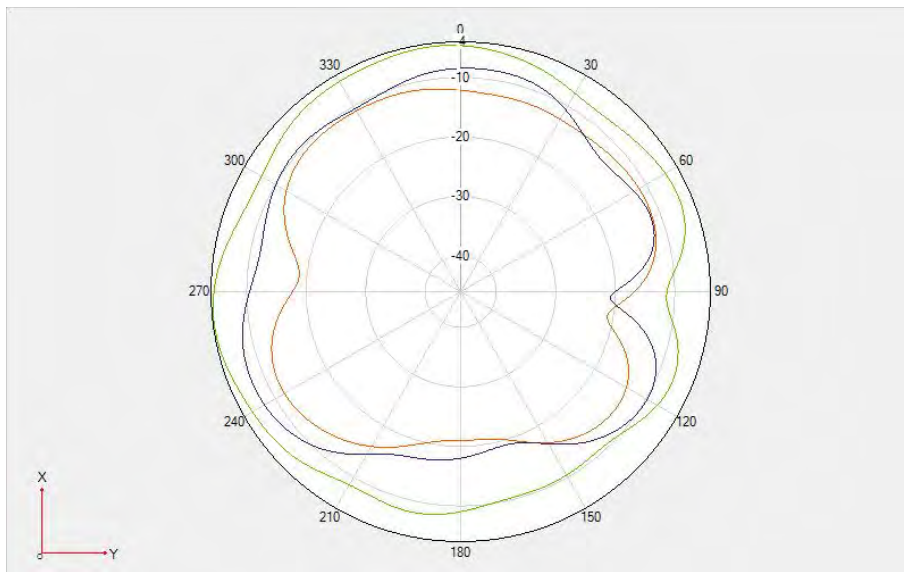

Unfold- NR n77/78 DRX2 theta =90

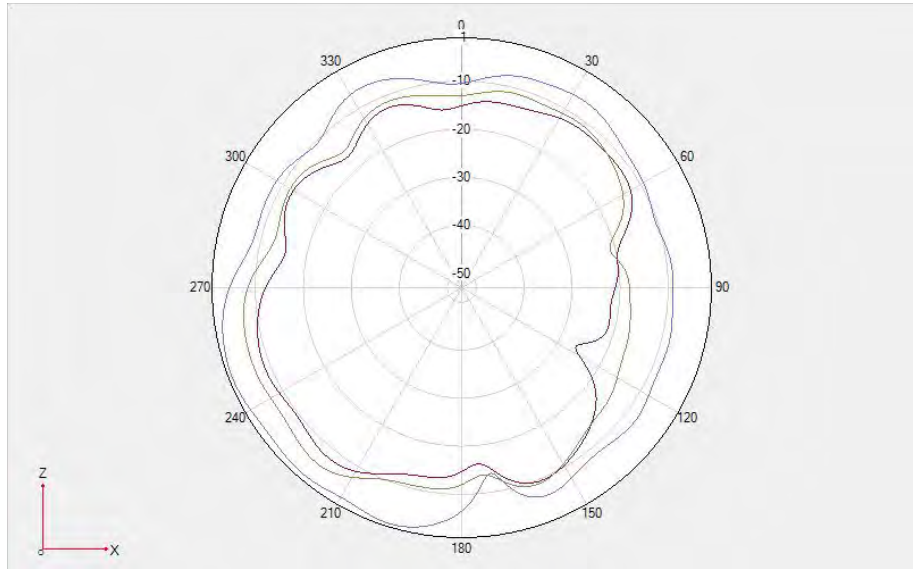

Unfold- NR n77/78 DRX2 $\phi=0$

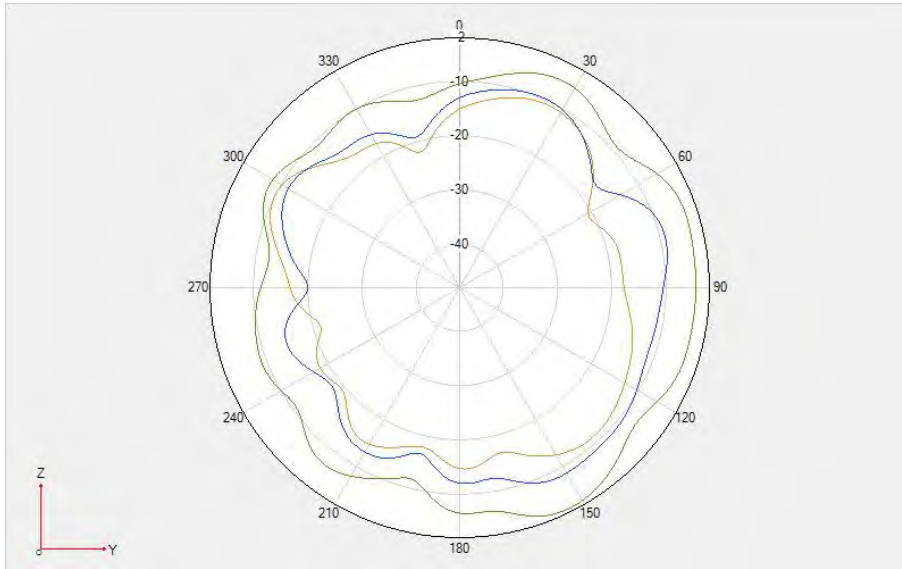

Unfold- NR n77/78 DRX2 $\phi=90$

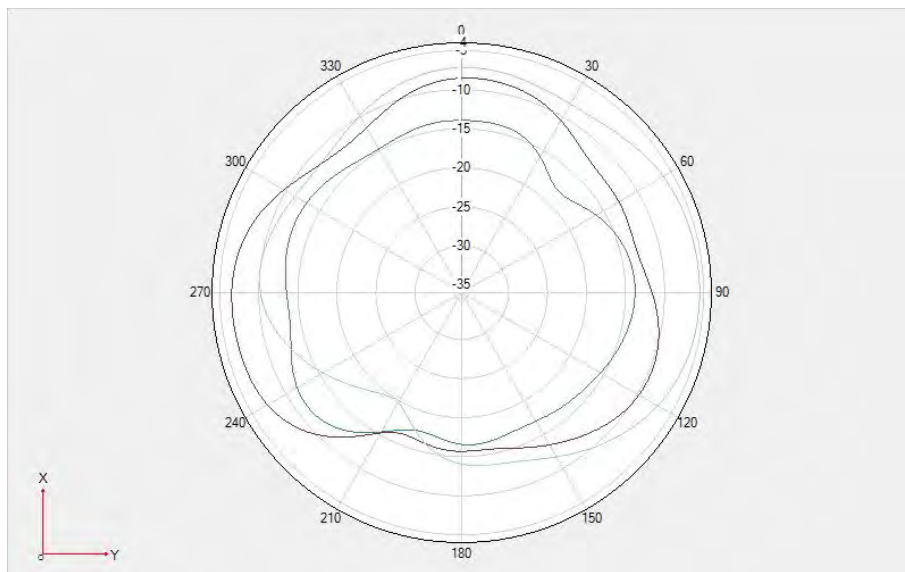

Fold- NR n77/78 DRX2 $\theta =90$

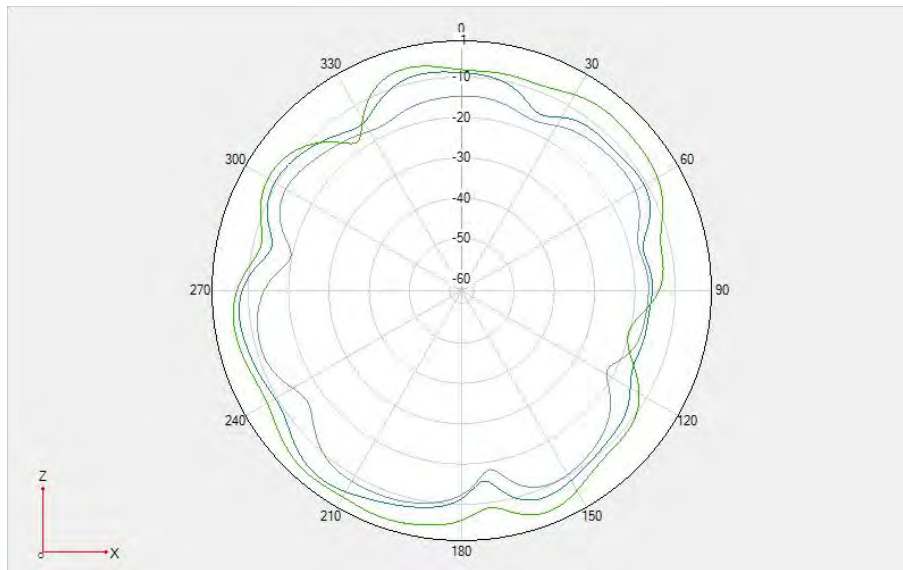

Fold- NR n77/78 DRX2 $\phi=0$

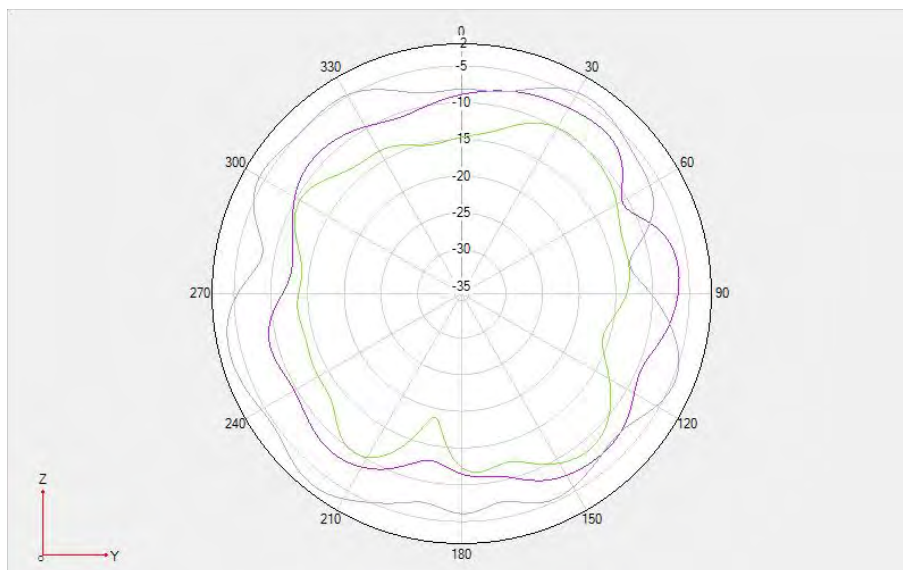

Fold- NR n77/78 DRX2 $\phi=90$

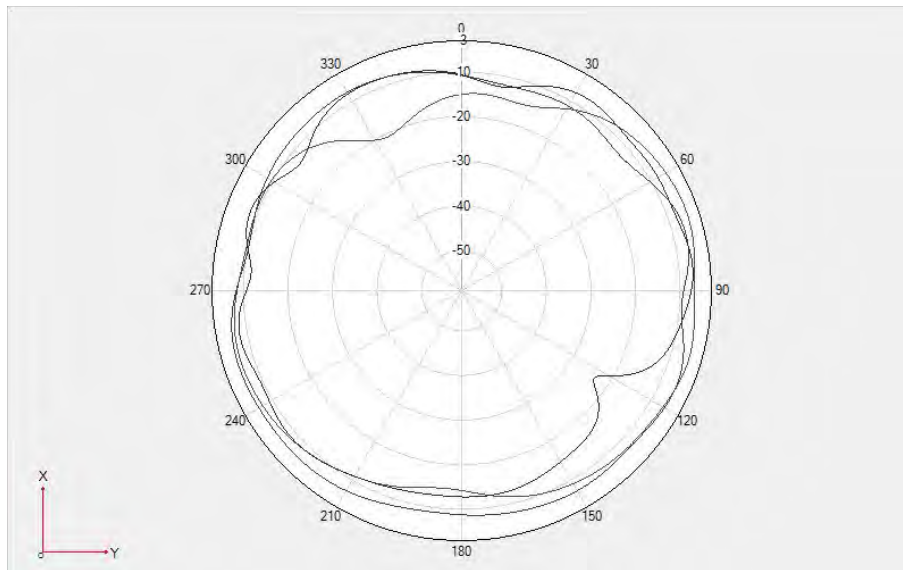

Unfold- NR n77/78/79 DRX3 theta =90

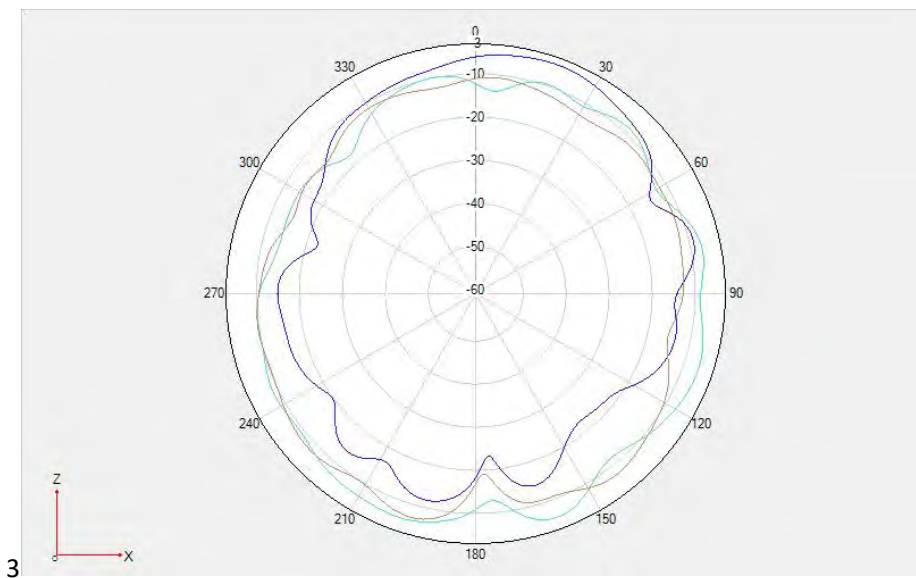

Unfold- NR n77/78/79 DRX3 phi=0

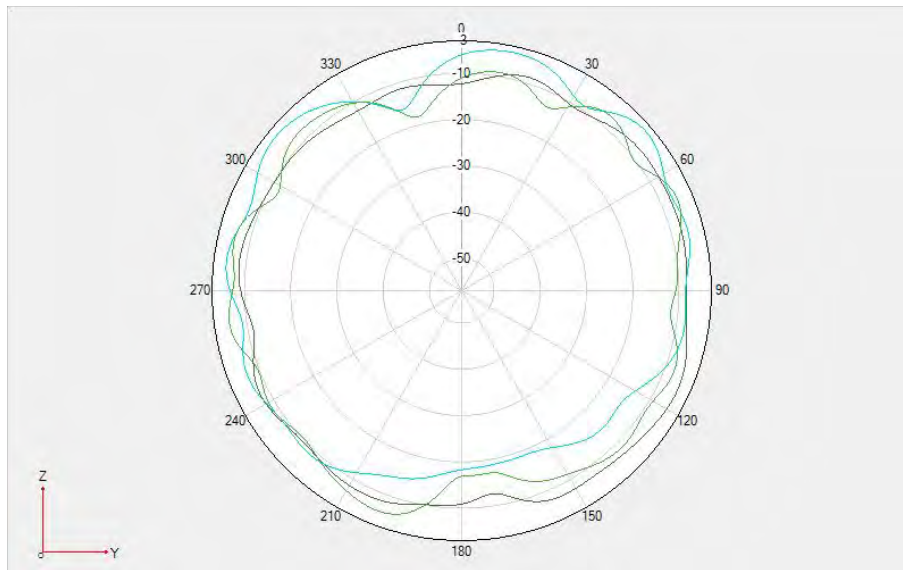

Unfold- NR n77/78/79DRX3 $\phi=90$

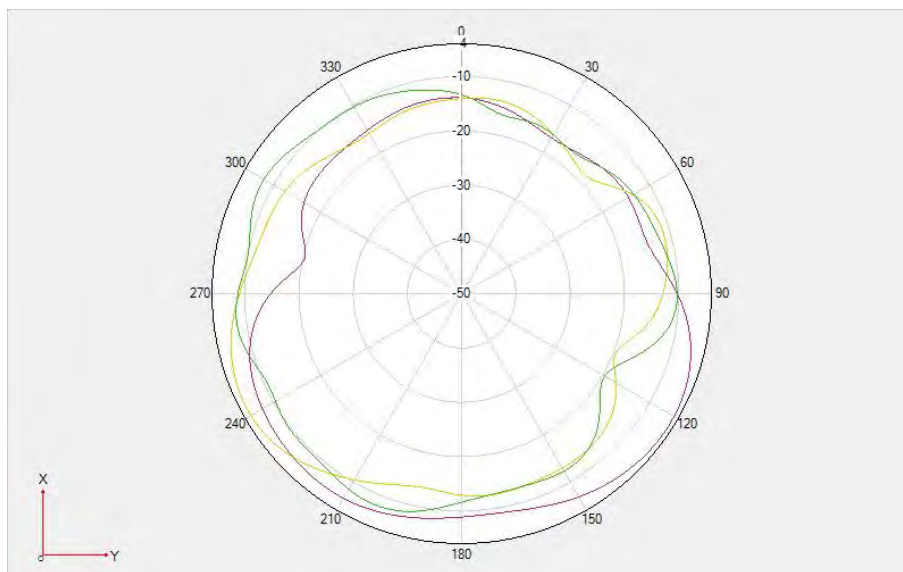

Fold- NR n77/78/79 DRX3 $\theta =90$

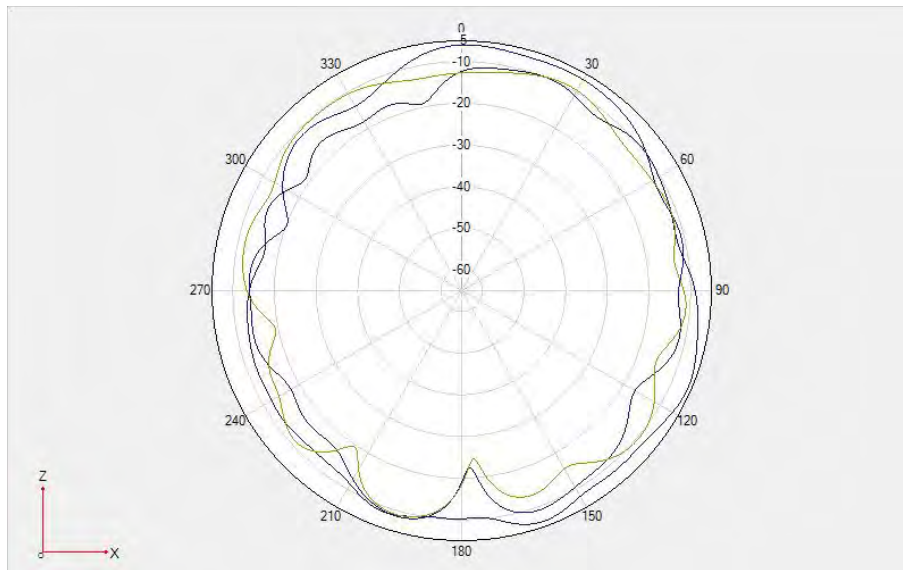

Fold- NR n77/78/79DRX3 phi=0

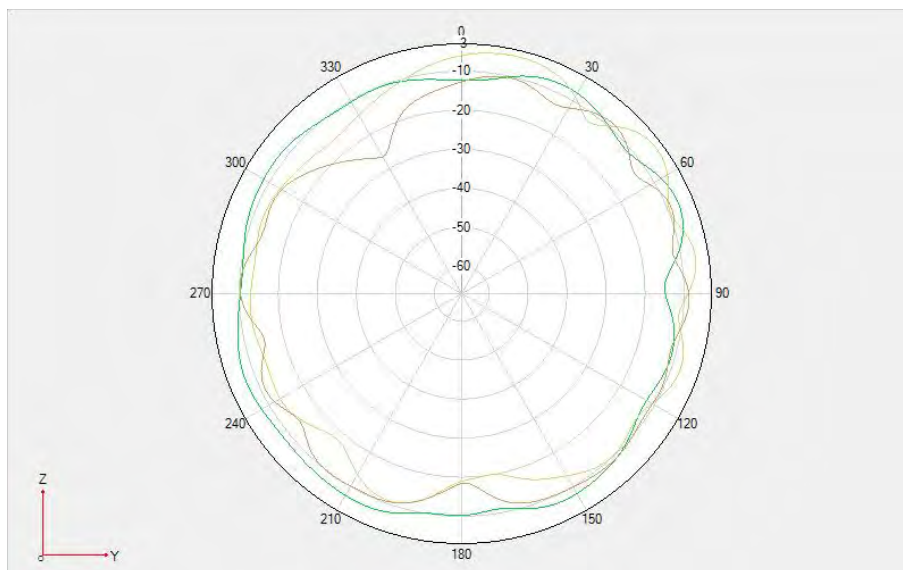

Fold- NR n77/78/79 DRX3 phi=90

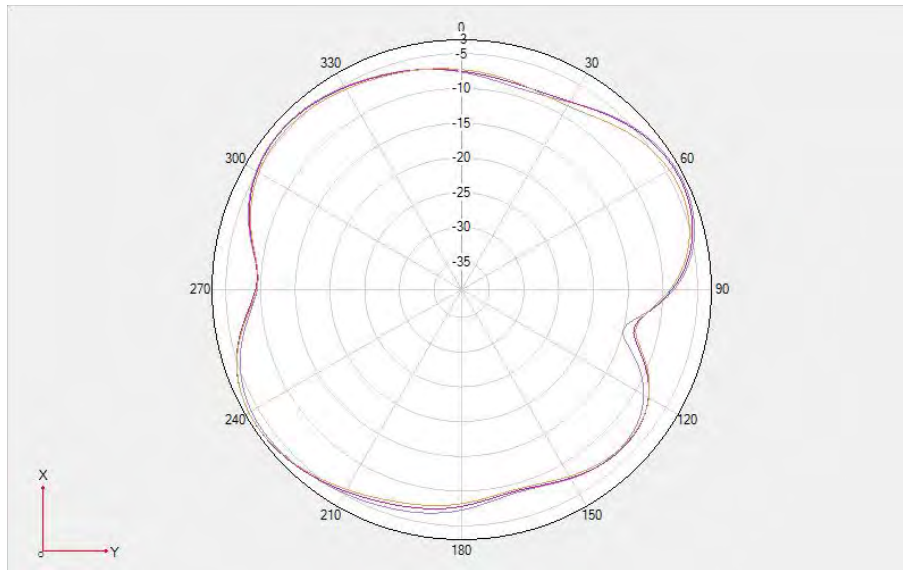

Unfold- NR n1 DRX theta =90

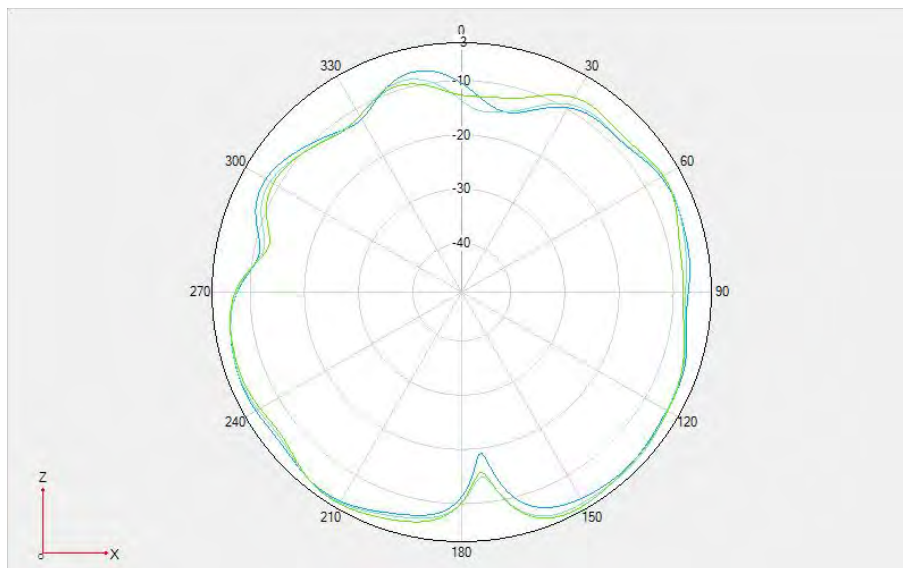

Unfold- NR n1 DRX phi=0

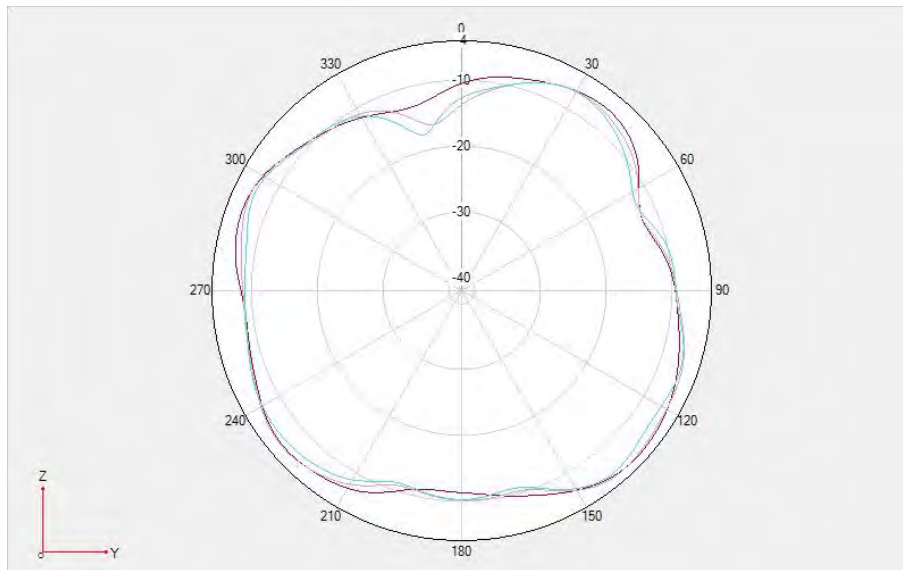

Unfold- NR n1 DRX phi=90

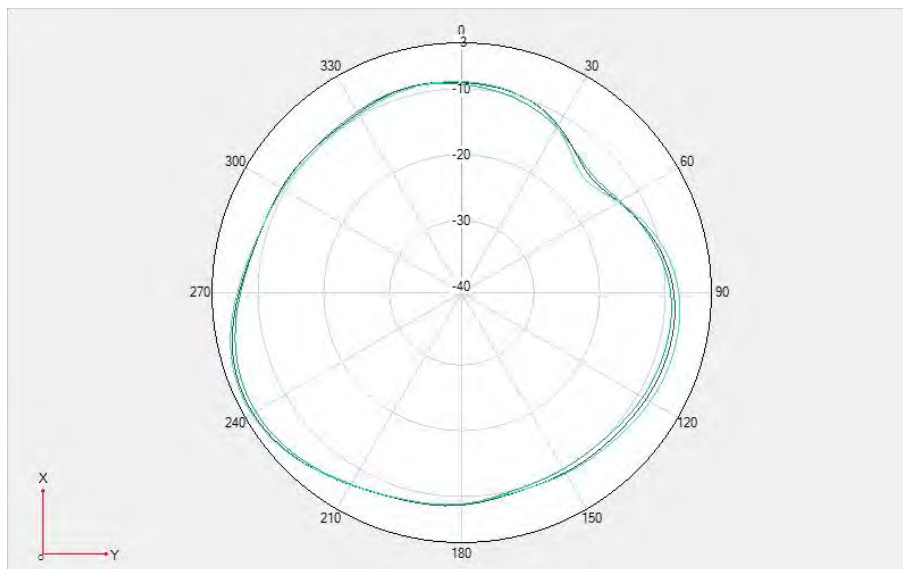

Fold- NR n1 DRX theta =90

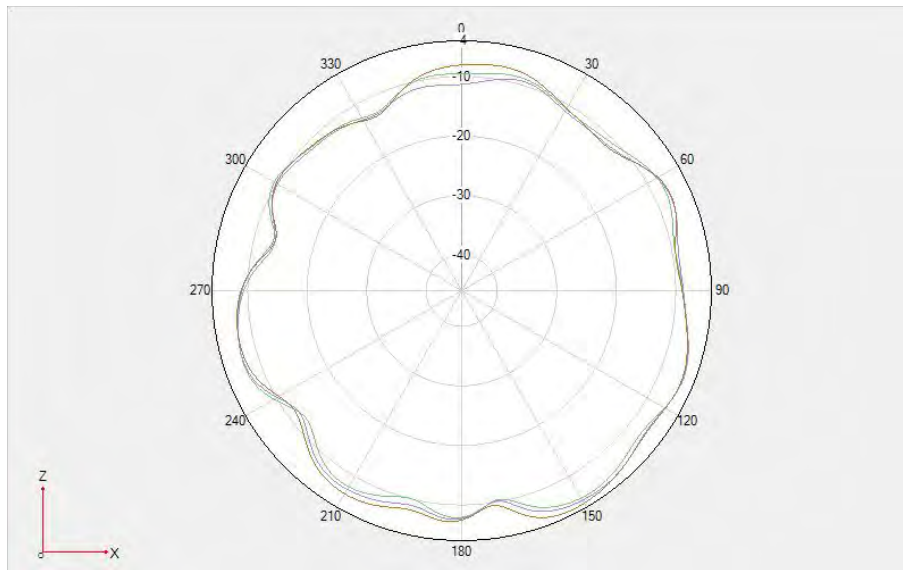

Fold- NR n1 DRX $\phi=0$

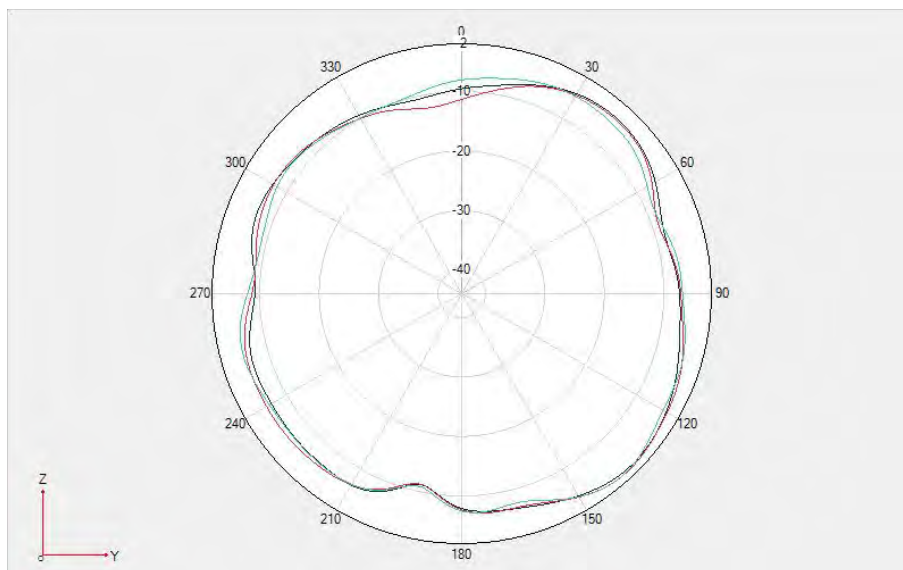

Fold- NR n1 DRX $\phi=90$

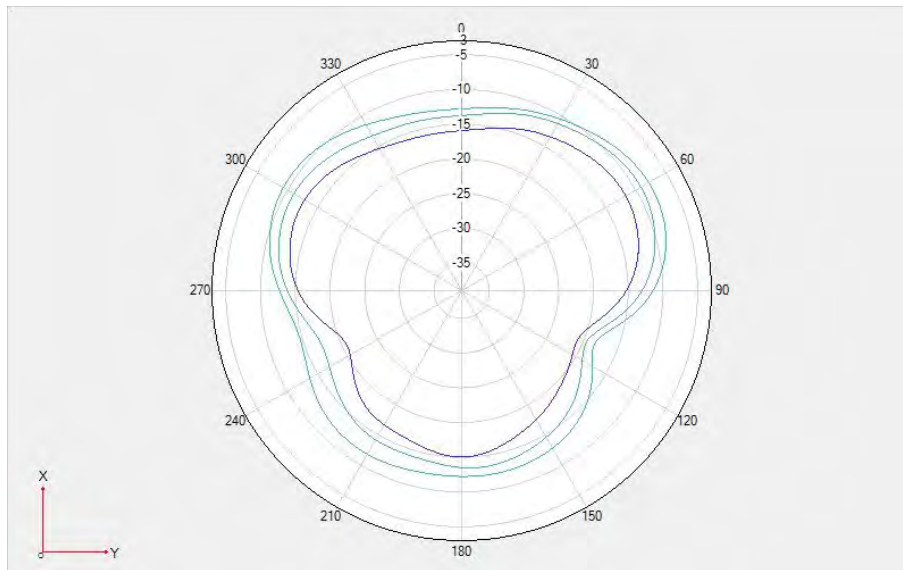

Unfold- NR n3/N66 DRX $\theta = 90$

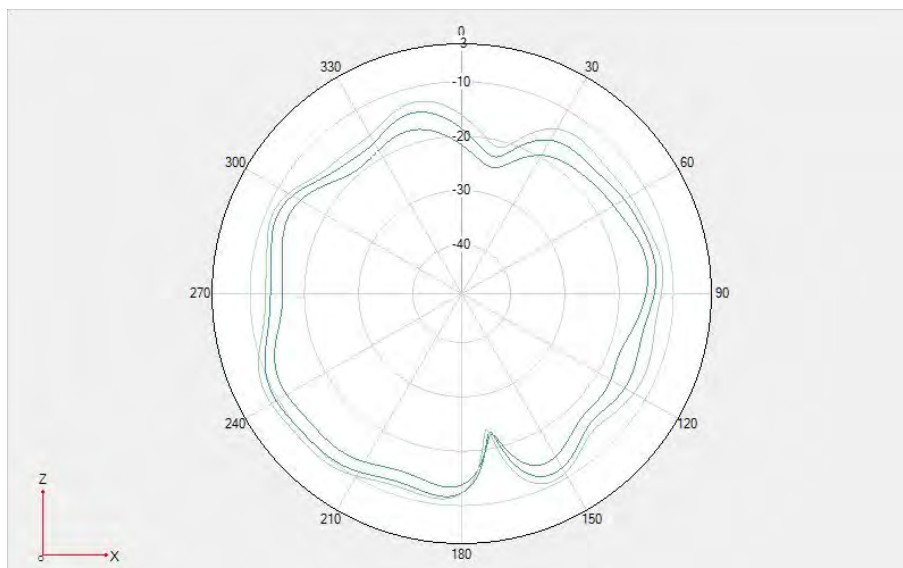

Unfold- NR n3/N66 DRX $\phi = 0$

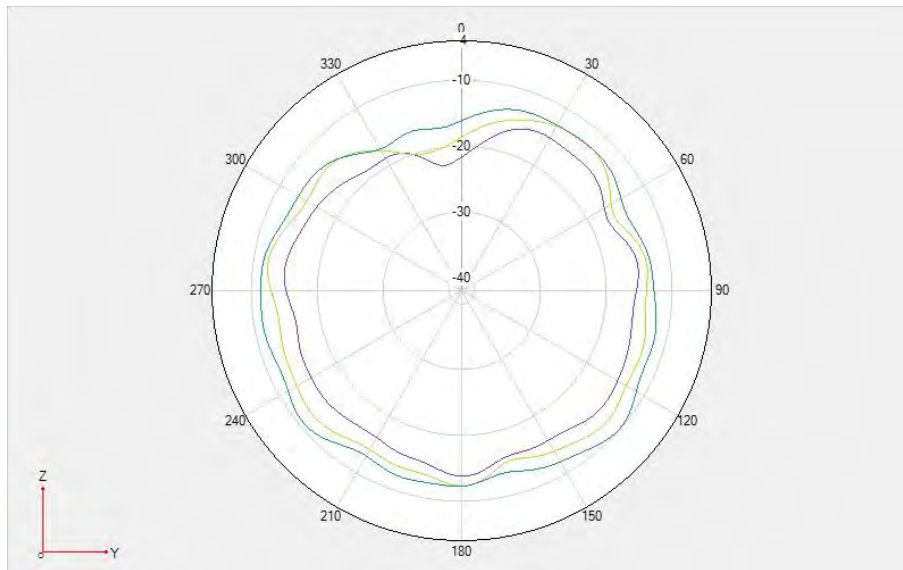

Unfold- NR n3/N66 DRX $\phi=90$

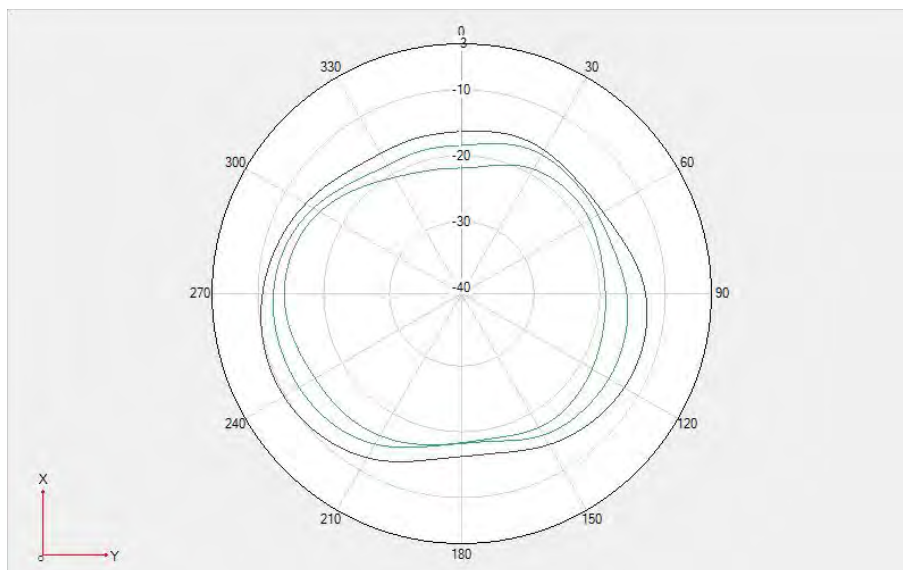

Fold- NR n3/N66 DRX $\theta=90$

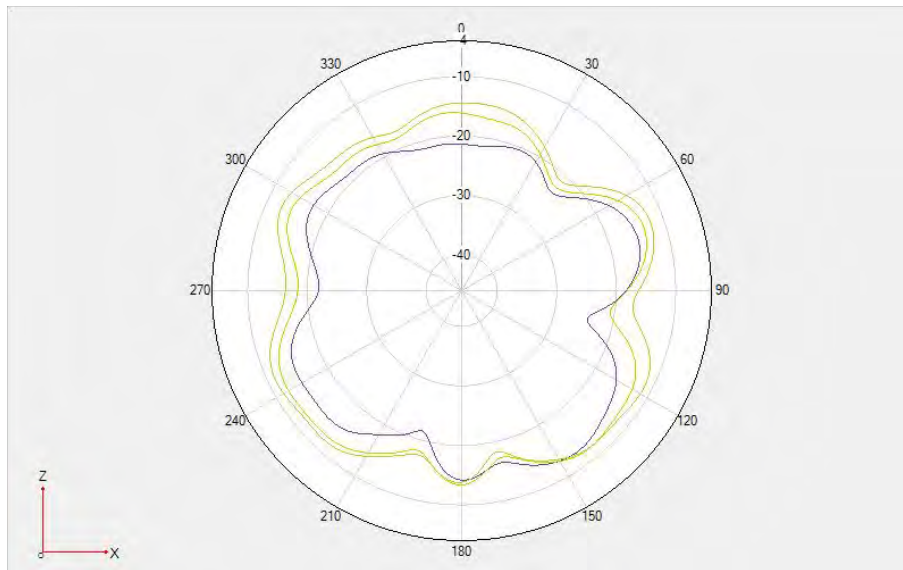

Fold- NR n3/N66 DRX $\phi=0$

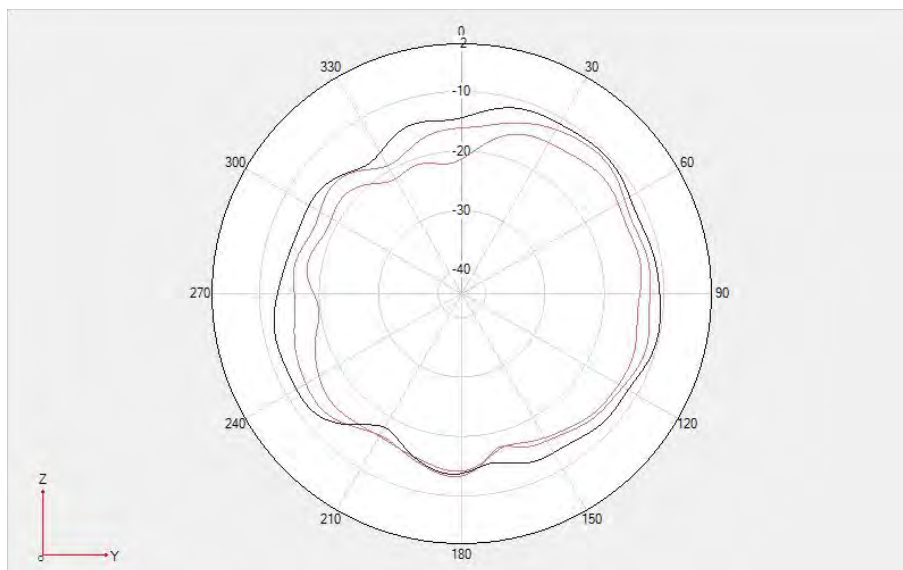

Fold- NR n3/N66 DRX $\phi=90$

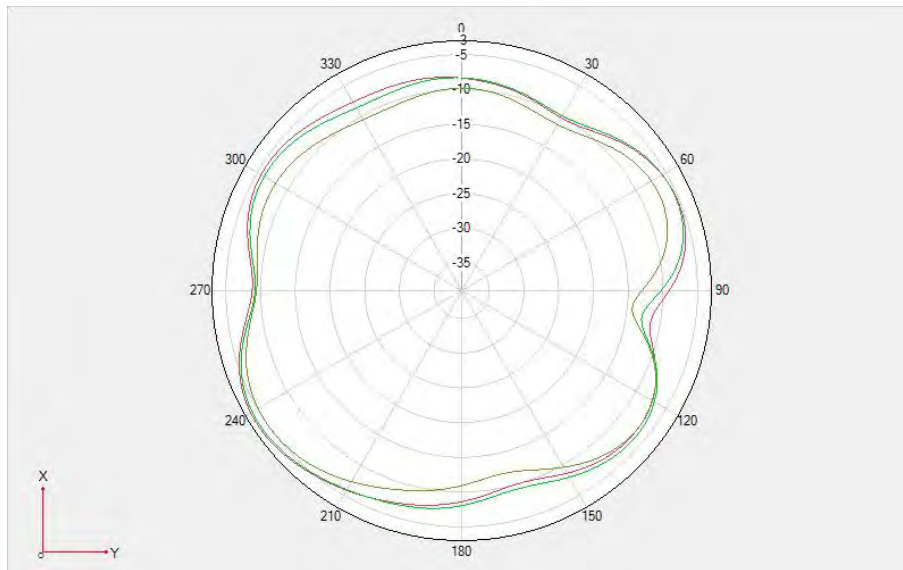

Unfold- NR n40 DRX3 $\theta = 90$

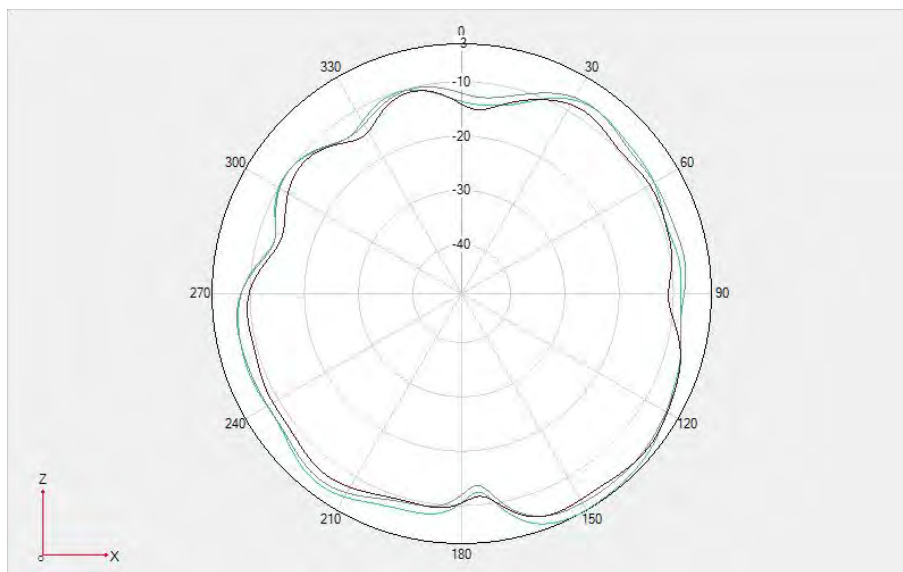

Unfold- NR n40 DRX3 $\phi = 0$

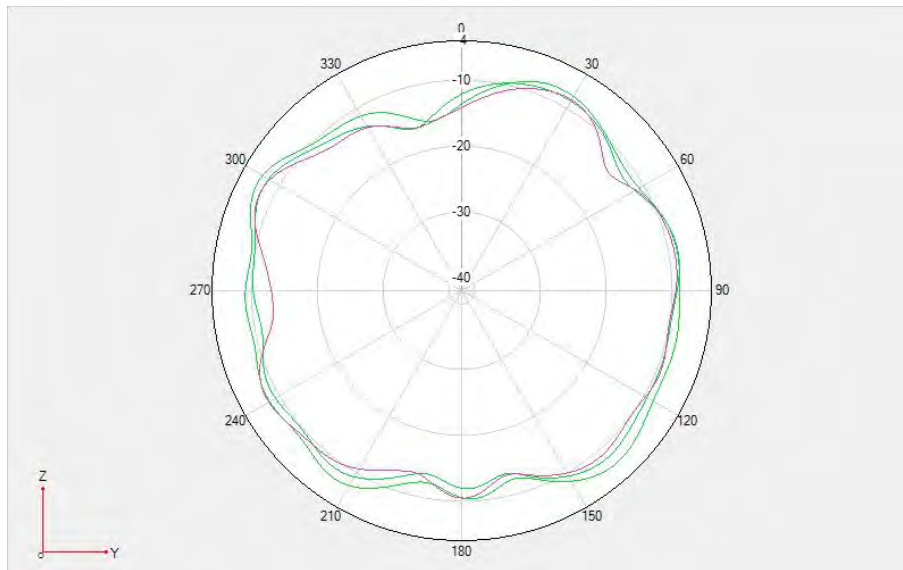

Unfold- NR n40DRX3 $\phi=90$

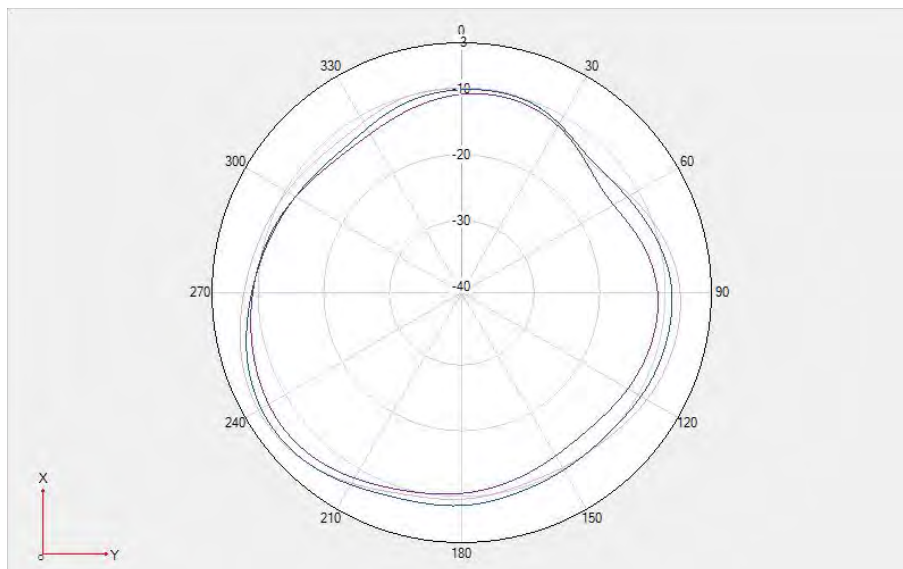

Fold- NR n40 DRX3 $\theta=90$

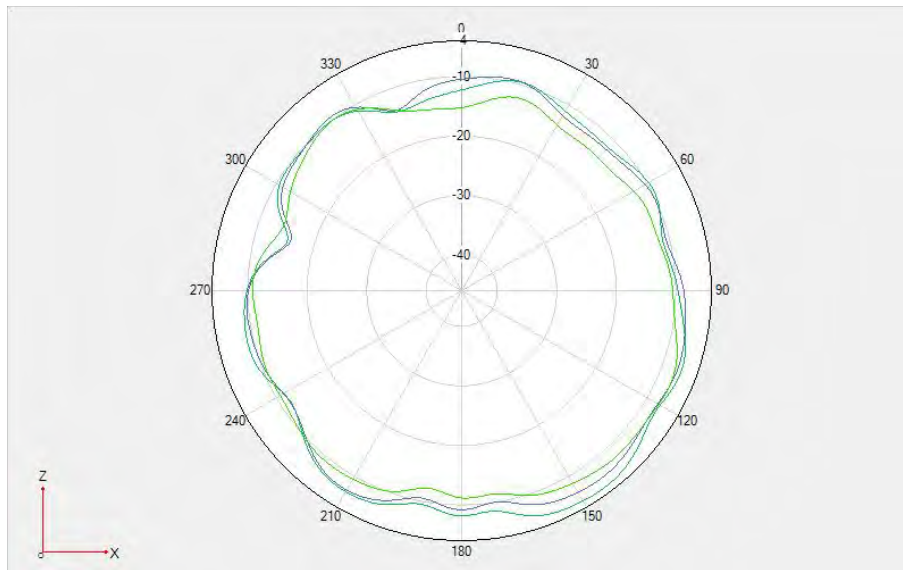

Fold- NR n40 DRX3 $\phi=0$

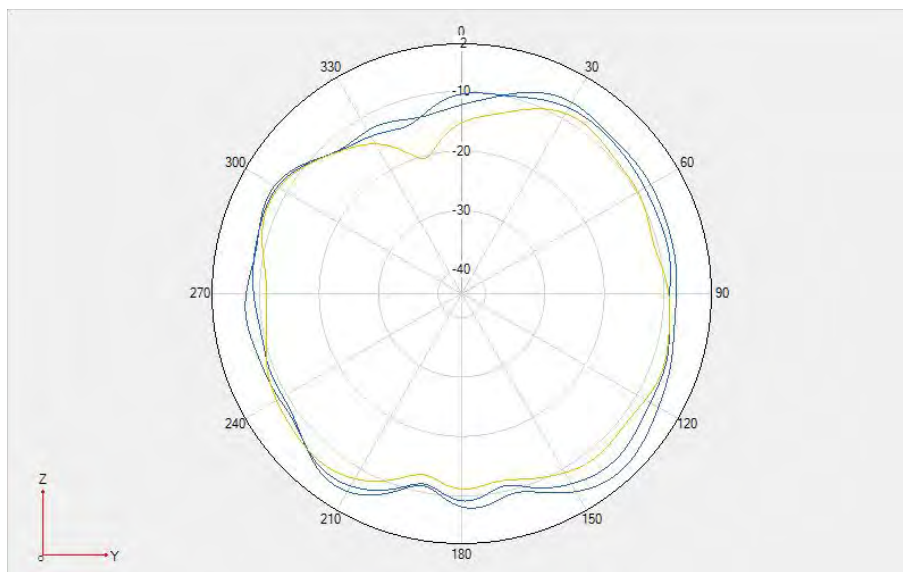

Fold- NR n40DRX3 $\phi=90$

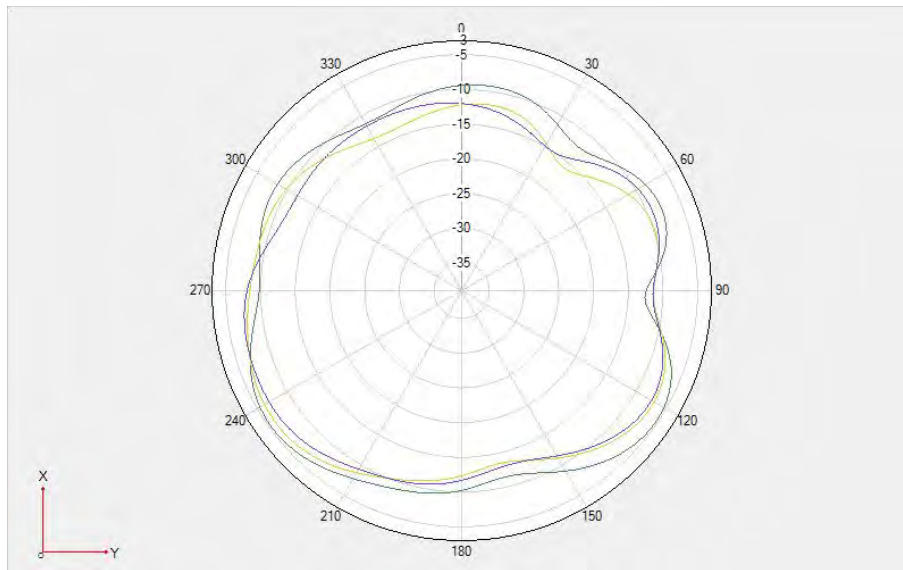

Unfold- NR n38/41 DRX3 $\theta = 90$

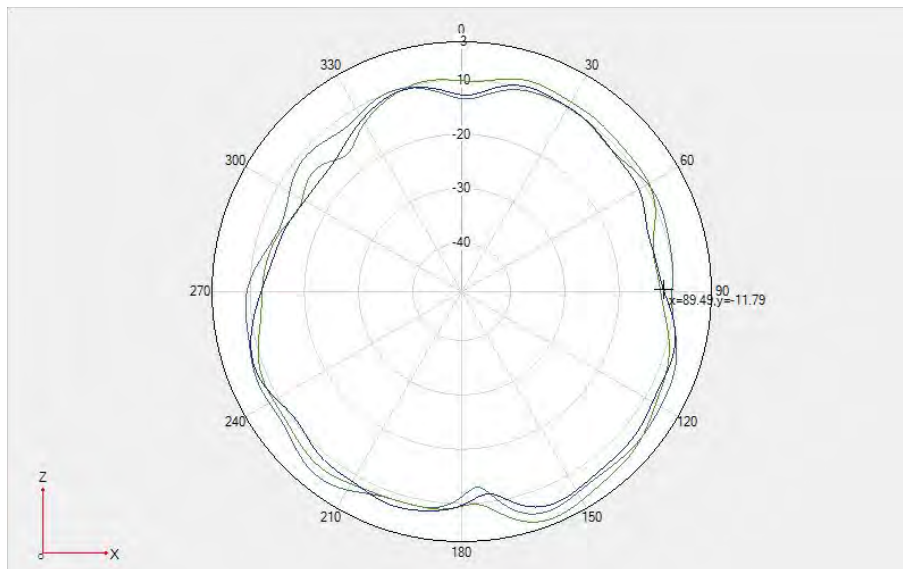

Unfold- NR NR n38/41 DRX3 $\phi = 0$

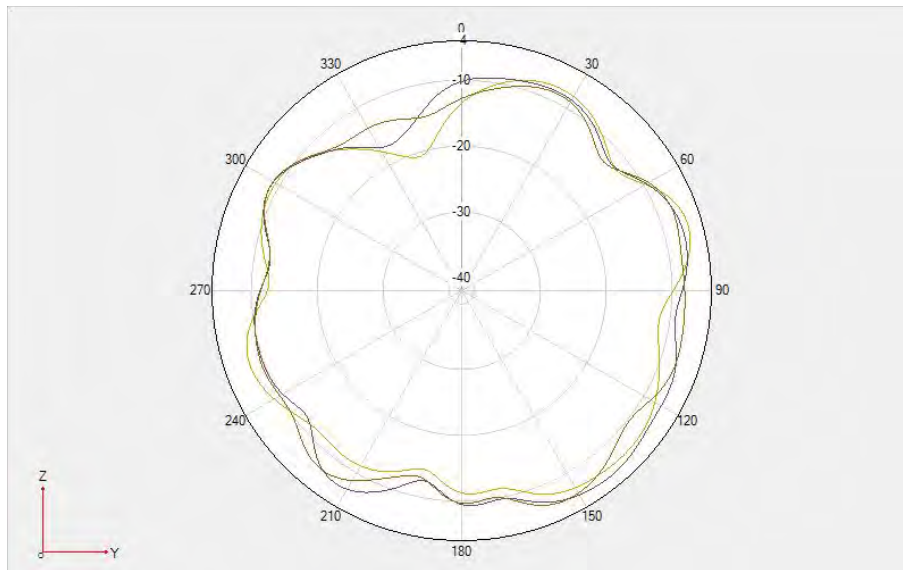

Unfold- NR n38/41 DRX3 $\phi=90$

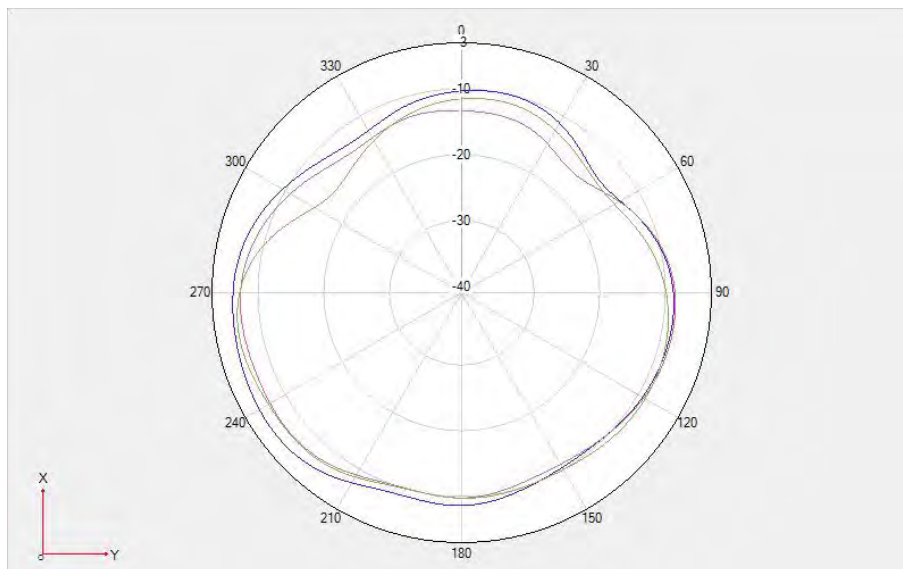

Fold- NRn38/41 DRX3 $\theta=90$

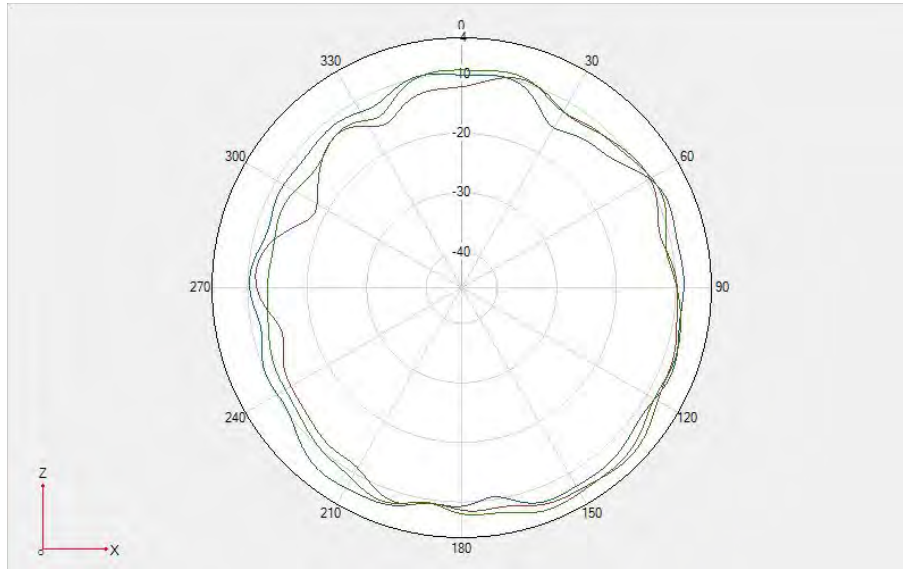

Fold- NR n38/41 DRX3 $\phi=0$

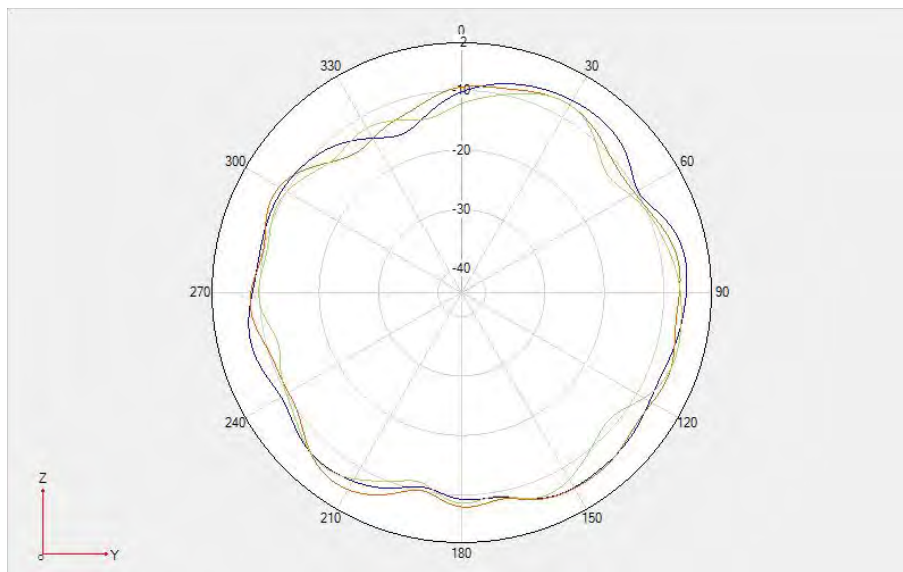

Fold- NR n38/41 DRX3 $\phi=90$

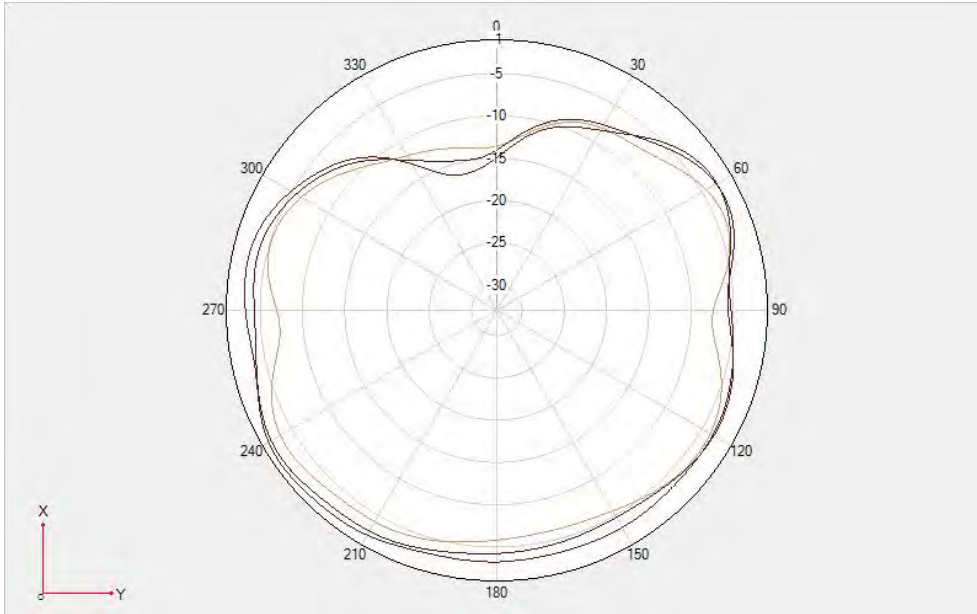

Unfold-Wifi Miomo 1-2.4G Theta=90deg

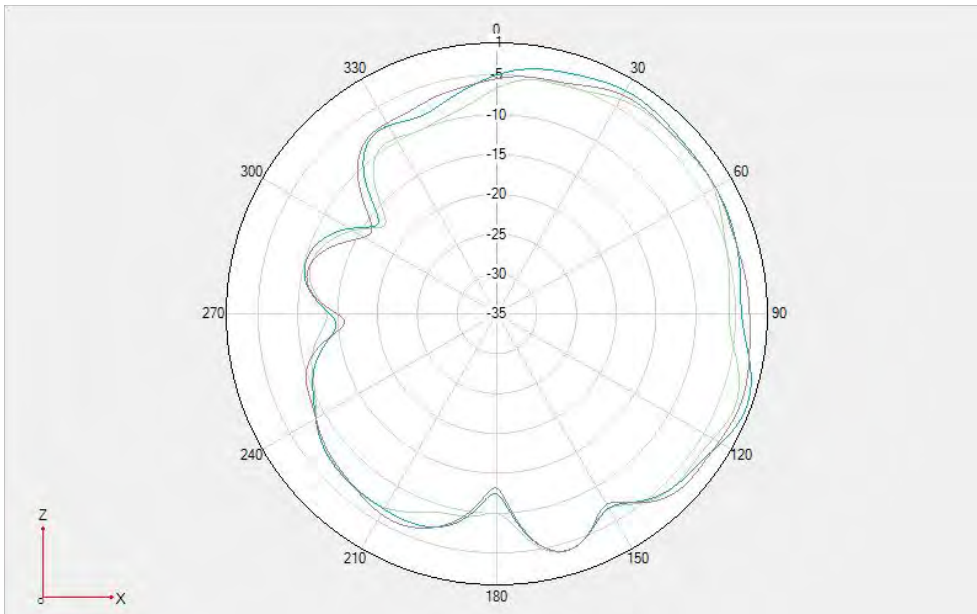

Unfold-Wifi Miomo 1-2.4G Phi=0deg

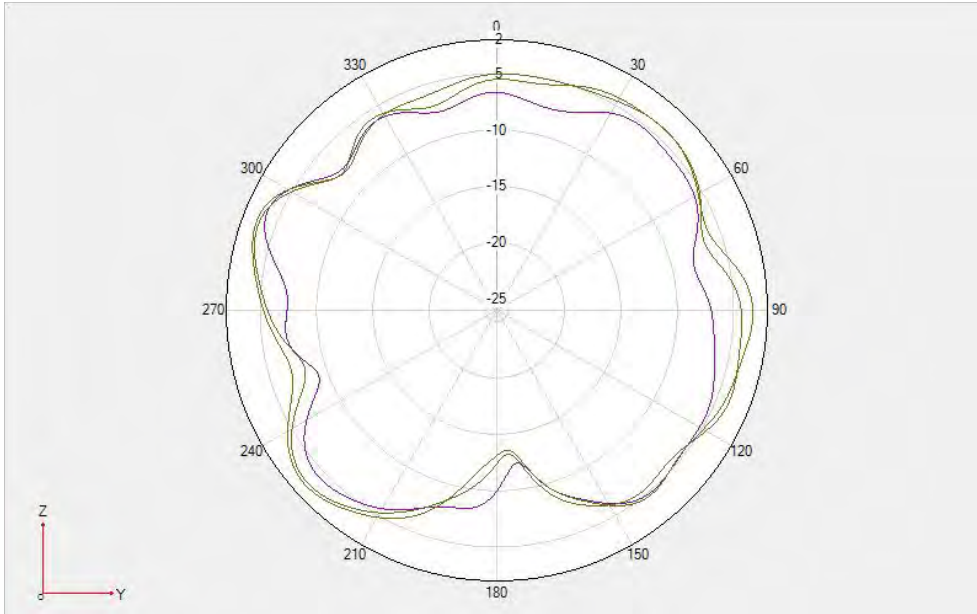

Unfold-Wifi Miomo1-2.4G $\Phi=90^\circ$

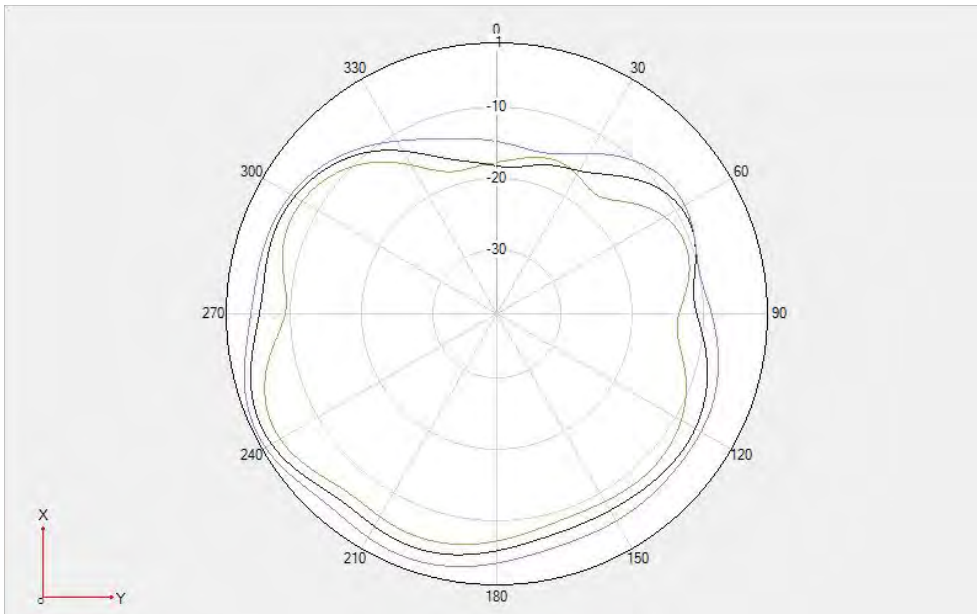

Fold-Wifi Miomo1-2.4G $\Theta=90^\circ$

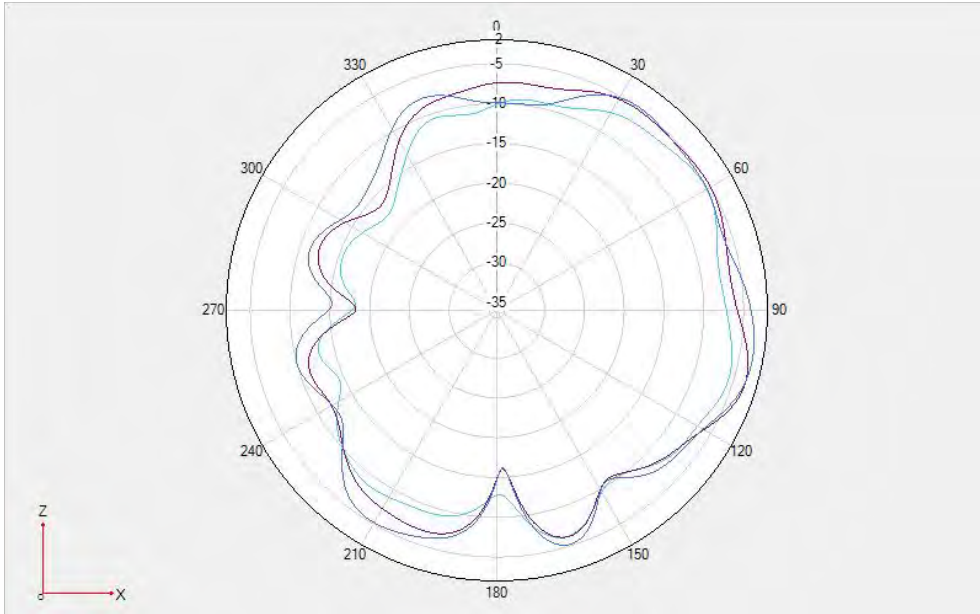

Fold-Wifi Miomol-2.4G $\Phi = 0^\circ$

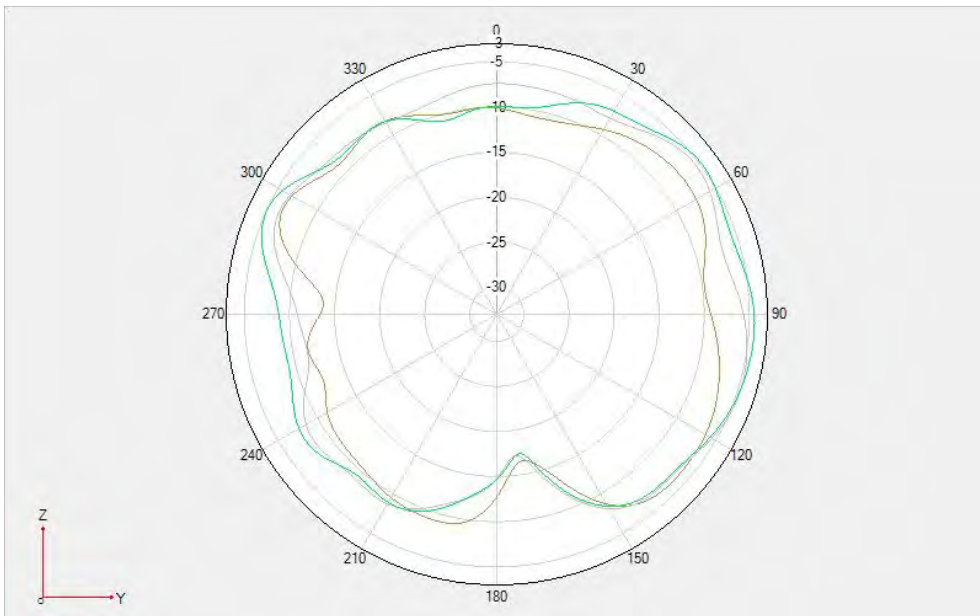

Fold-Wifi Miomol-2.4G $\Phi = 90^\circ$

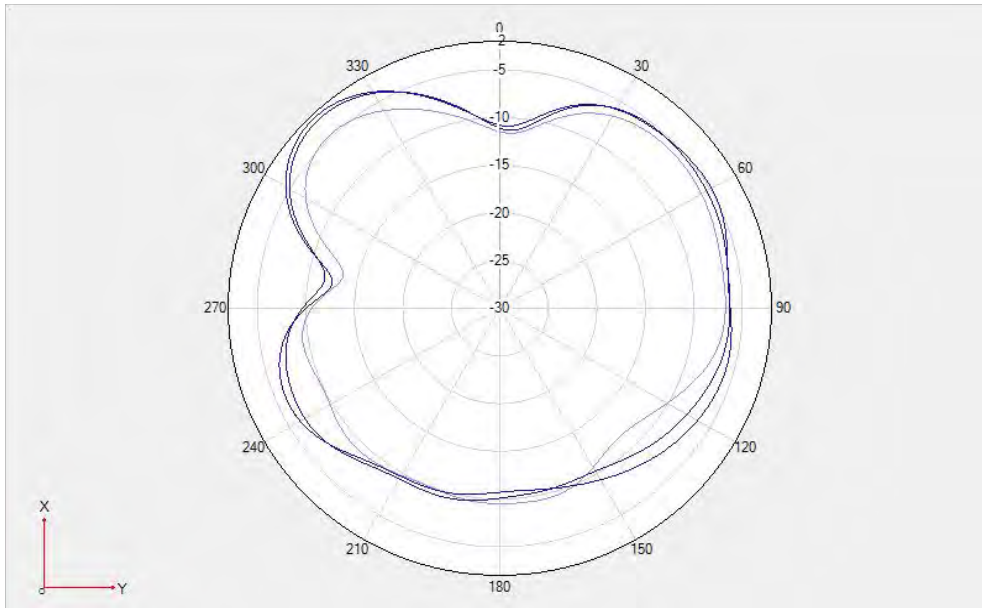

Unfold-Wifi MIMO 0-2.4G $\Theta=90\text{deg}$

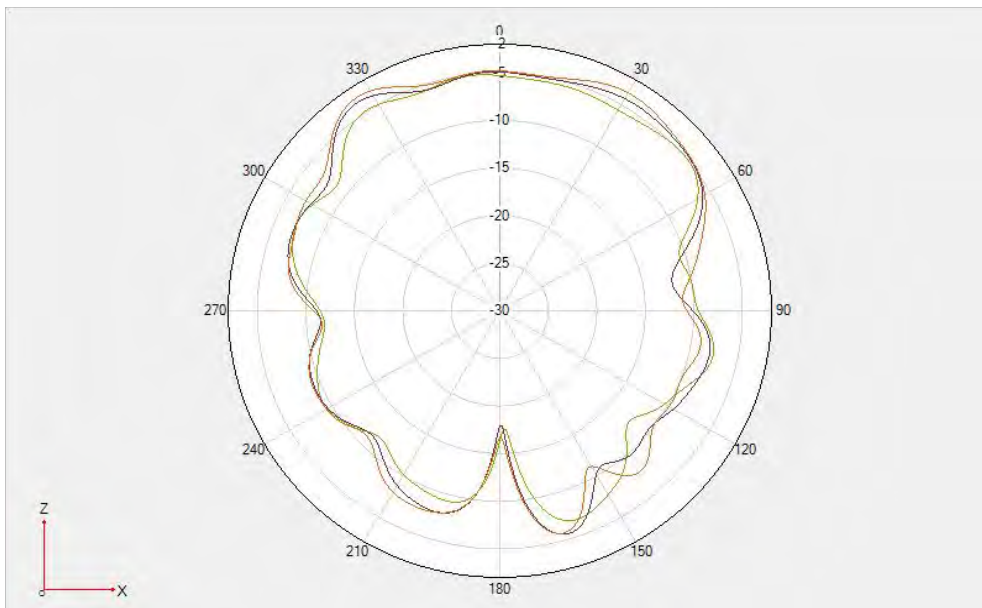

Unfold-Wifi MIMO 0-2.4G $\Phi=0\text{deg}$

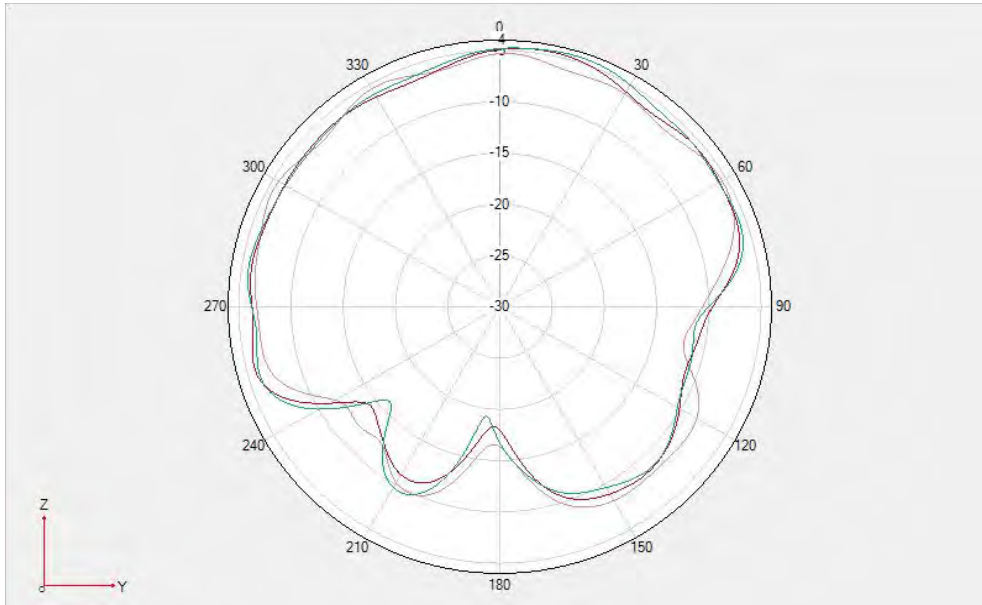

Unfold-Wifi MIMO 0-2.4G $\Phi=90^\circ$

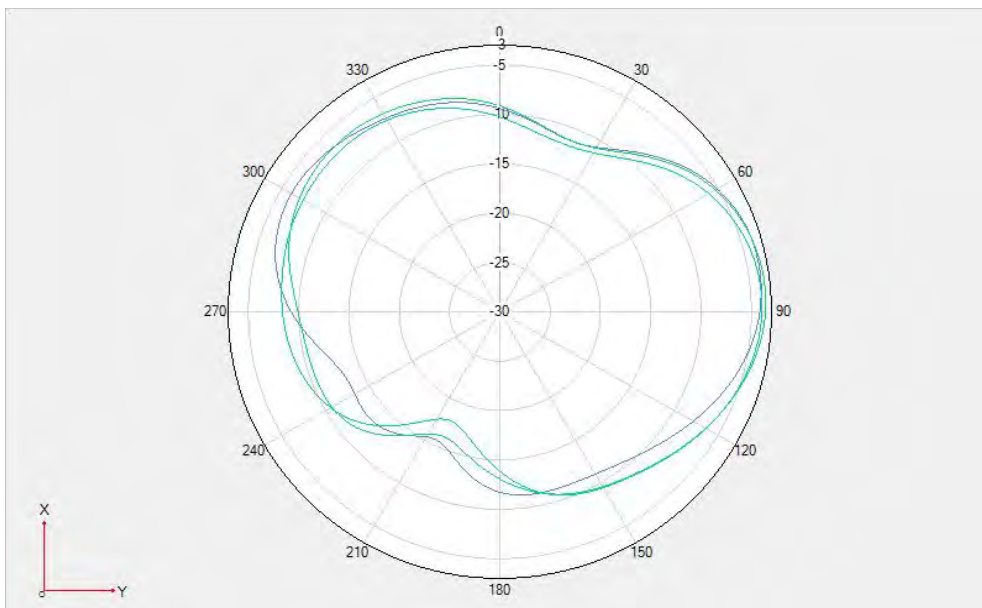

Fold-Wifi MIMO 0-2.4G $\Theta=90^\circ$

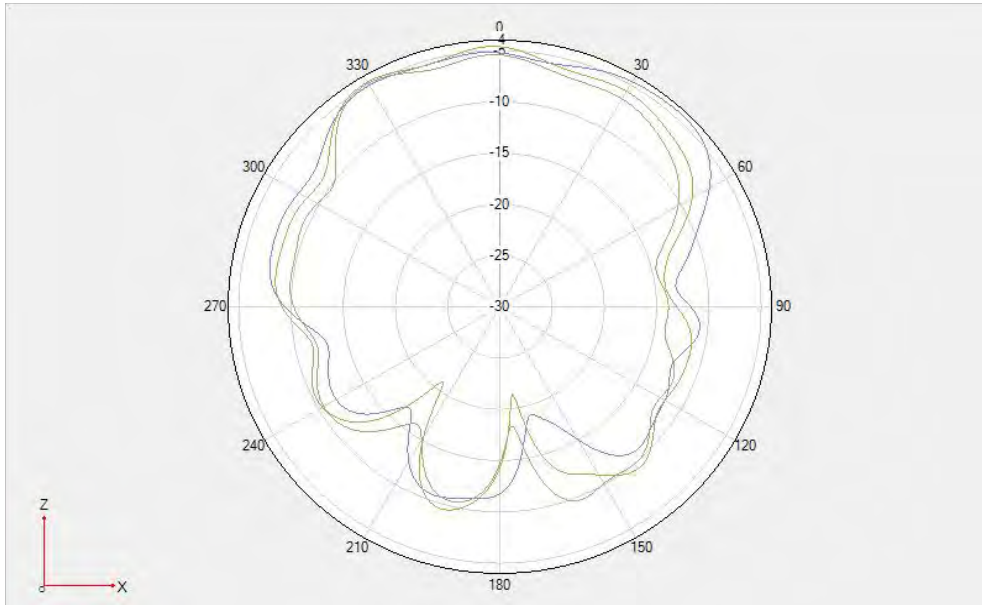

Fold-Wifi MIMO0-2.4G $\Phi=0^\circ$

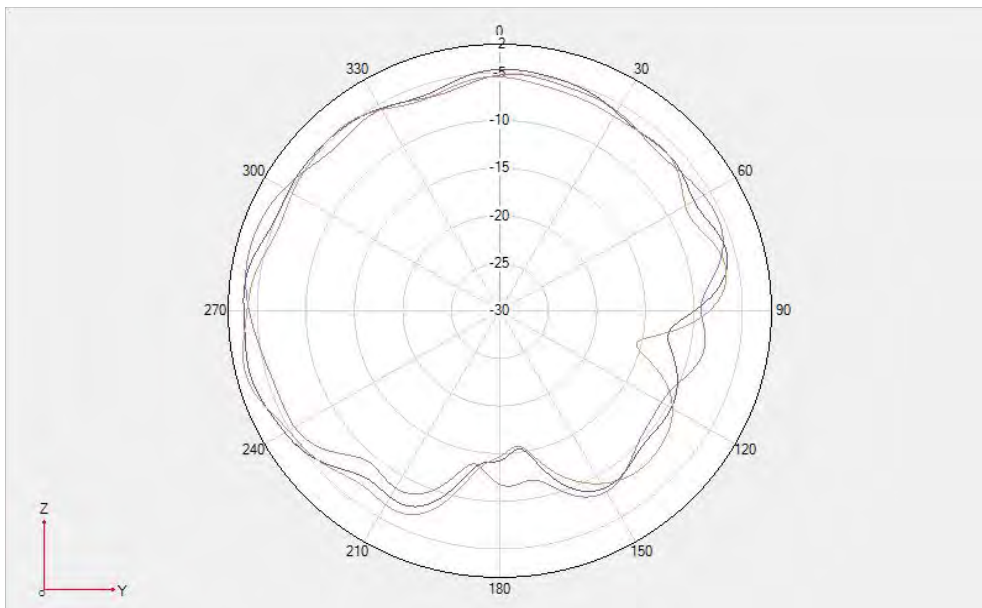

Fold-Wifi MIMO0-2.4G $\Phi=90^\circ$

LDS1- 5G WIFI MIMO0 Antenna fold&unfold

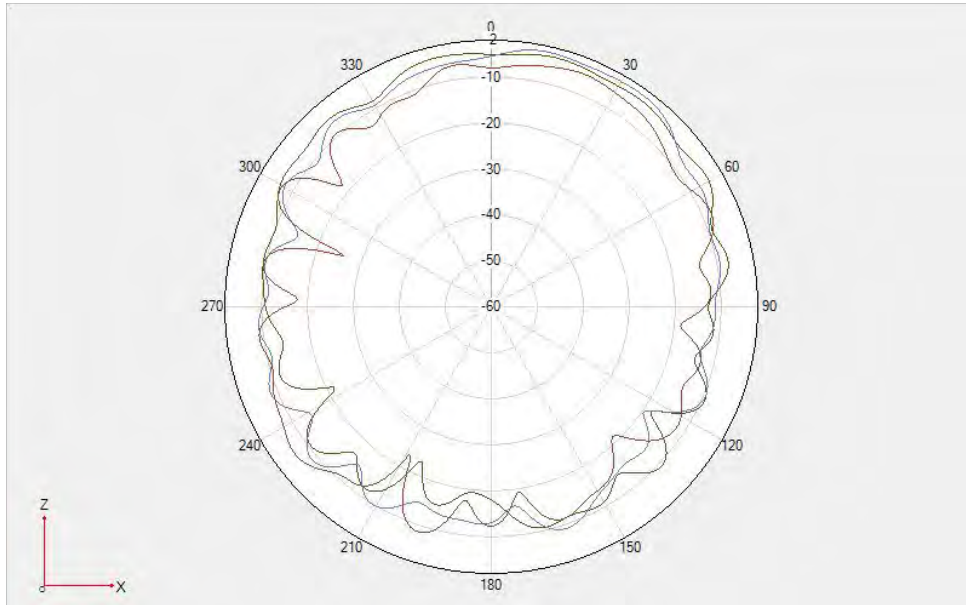

5G WIFI $\Phi=0^\circ$

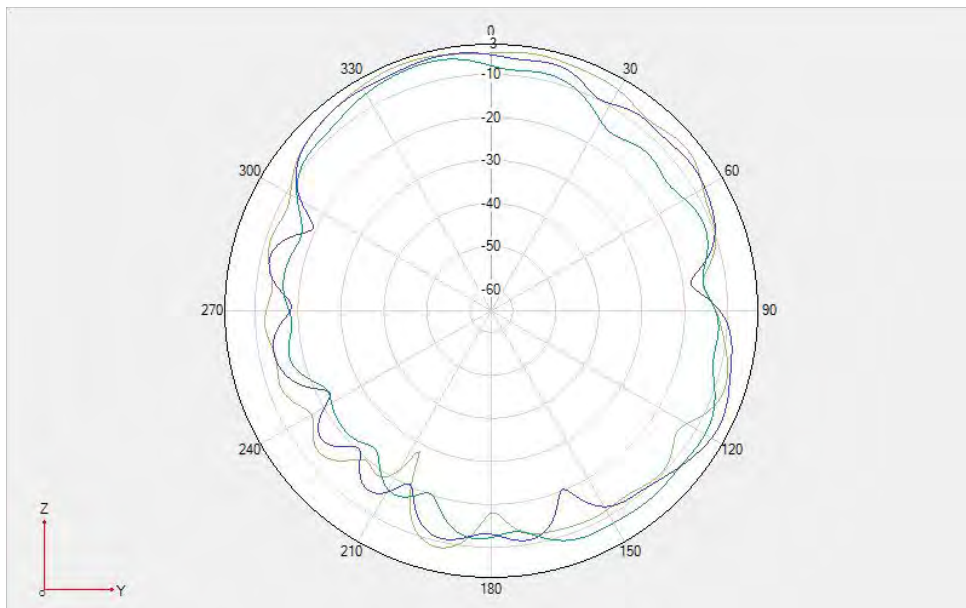

5G WIFI $\Phi=90^\circ$

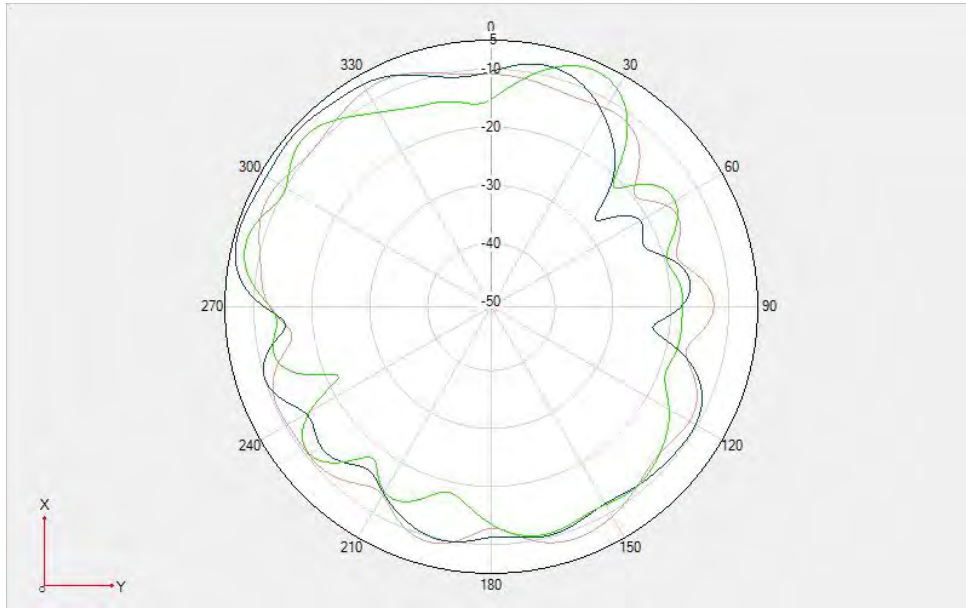

5G WIFI $\Theta = 90^\circ$

LDS2- 5G WIFI MIMO1 Antenna fold&unfold

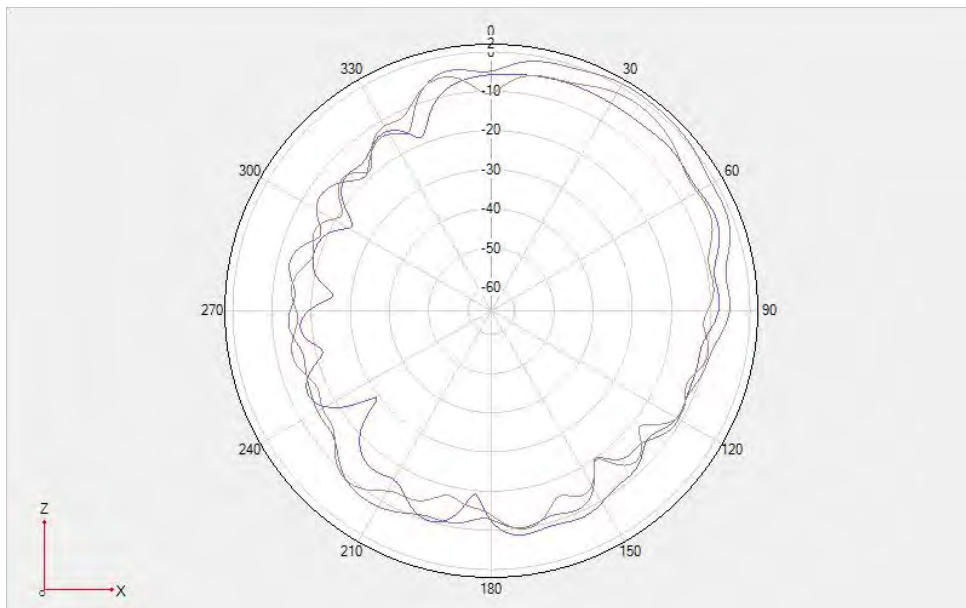

5G WIFI $\Phi = 0^\circ$

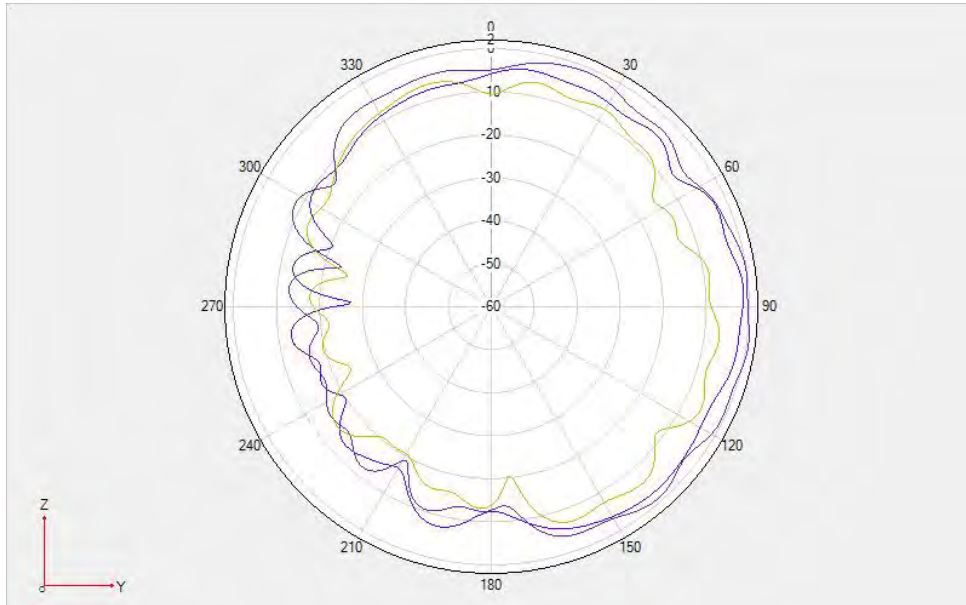

5G WIFI Phi=90deg

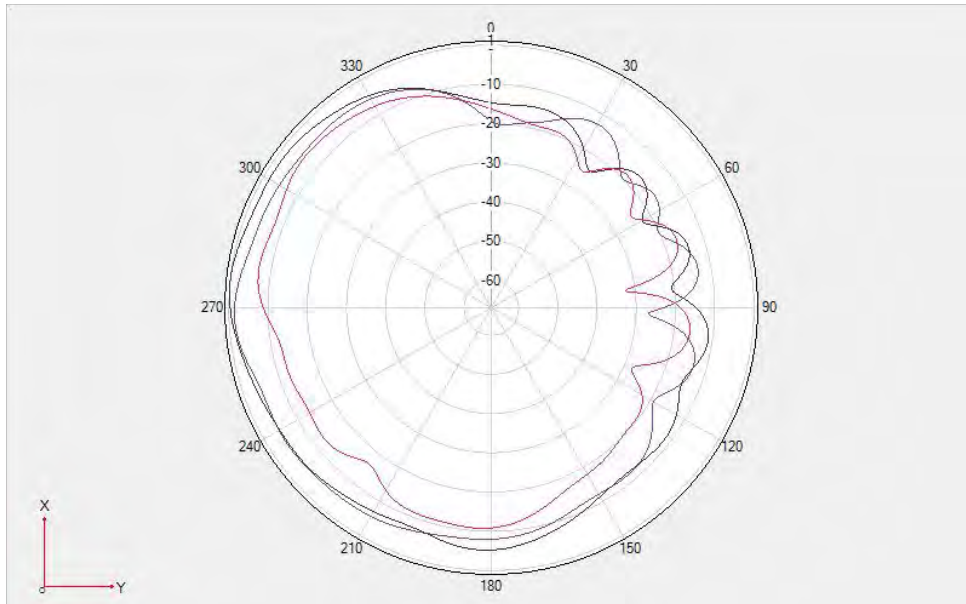

5G WIFI Theta=90deg

PREPARED BY	CHECKEDBY	APPROVAL BY	S.R.NO	
			DATE:	