

FCC C2PC Test Report

FCC ID : 2ADYF-AP20
Equipment : 802.11AC Wireless Internet Router
Model No. : AP20
Brand Name : Art2Wave
Applicant : Art2Wave Inc
Address : 1901 South Bascom Ave, Suite 1300,
Campbell, CA 95008, USA
Standard : 47 CFR FCC Part 15.407
Received Date : Mar. 19, 2015
Tested Date : Apr. 20 ~ Sep. 16, 2015

We, International Certification Corp., would like to declare that the tested sample has been evaluated and in compliance with the requirement of the above standards. The test results contained in this report refer exclusively to the product. It may be duplicated completely for legal use with the approval of the applicant. It shall not be reproduced except in full without the written approval of our laboratory.

Approved & Reviewed by:



Gary Chang / Manager



Table of Contents

1	GENERAL DESCRIPTION	5
1.1	Information.....	5
1.2	Local Support Equipment List	9
1.3	Test Setup Chart	9
1.4	The Equipment List	10
1.5	Testing Applied Standards	11
1.6	Measurement Uncertainty	11
2	TEST CONFIGURATION	12
2.1	Testing Condition	12
2.2	The Worst Test Modes and Channel Details	13
3	TRANSMITTER TEST RESULTS.....	14
3.1	Conducted Emissions.....	14
3.2	Emission Bandwidth	23
3.3	RF Output Power	29
3.4	Peak Power Spectral Density	34
3.5	Transmitter Radiated and Band Edge Emissions	39
3.6	Frequency Stability.....	128
4	TEST LABORATORY INFORMATION	130

Release Record

Report No.	Version	Description	Issued Date
FR582101-01	Rev. 01	Initial issue	Sep. 30, 2015

Summary of Test Results

FCC Rules	Test Items	Measured	Result
15.207	Conducted Emissions	[dBuV]: 0.433MHz 41.61 (Margin -5.58dB) - AV	Pass
15.407(b) 15.209	Radiated Emissions	[dBuV/m at 3m]: 5725.00MHz 53.90 (Margin -0.10dB) - AV	Pass
15.407(a)	Emission Bandwidth	Meet the requirement of limit	Pass
15.407(a)	RF Output Power	Max Power [dBm]: Non-beamforming mode 5250~5350MHz: 23.70 5470~5725MHz: 23.83 Beamforming mode 5250~5350MHz: 22.01 5470~5725MHz: 21.48	Pass
15.407(a)	Peak Power Spectral Density	Meet the requirement of limit	Pass
15.407(g)	Frequency Stability	Meet the requirement of limit	Pass
15.203	Antenna Requirement	Meet the requirement of limit	Pass

1 General Description

1.1 Information

This report is issued as a FCC Class II Permissive Change. The modification is only concerned with adding 5250~5350MHz and 5470~5725 MHz band by software setting.

1.1.1 Specification of the Equipment under Test (EUT)

RF General Information					
Frequency Range (MHz)	IEEE Std. 802.11	Ch. Freq. (MHz)	Channel Number	Transmit Chains (N _{TX})	Data Rate / MCS
5250-5350 5470-5725	a	5260-5320 5500-5720	52-64 [4] 100-144 [9]	1	6-54 Mbps
5250-5350 5470-5725	n (HT20)	5260-5320 5500-5720	52-64 [4] 100-144 [9]	2	MCS 0-15
5250-5350 5470-5725	n (HT40)	5270-5310 5510-5710	54-62 [2] 102-142 [4]	2	MCS 0-15
5250-5350 5470-5725	ac (VHT20)	5260-5320 5500-5720	52-64 [4] 100-144 [9]	2	MCS 0-9
5250-5350 5470-5725	ac (VHT40)	5270-5310 5510-5710	54-62 [2] 102-142 [4]	2	MCS 0-9
5250-5350 5470-5725	ac (VHT80)	5290 5530~5690	58 [1] 106-138 [2]	2	MCS 0-9

Note 1: RF output power specifies that Maximum Conducted Output Power.
 Note 2: 802.11 a/n/ac uses a combination of OFDM-BPSK, QPSK, 16QAM, 64QAM, 256QAM modulation.
 Note 3: 802.11a is transmitting signal through chain 0 only.
 Note 4: 802.11n/ac supports beamforming mode.
 Note 5: The device has disabled the 5600-5650MHz band by S/W setting.

1.1.2 Antenna Details

Ant. No.	Model	Type	Connector	Antenna Gain (dBi)	
				5250~5350 MHz	5470~5725 MHz
1	ANT 3 (for 5G)	PIFA	UFL	4.17	5.38
2	ANT 4 (for 5G)	PIFA	UFL	4.92	5.36

1.1.3 Power Supply Type of Equipment under Test (EUT)

Power Supply Type 1	12Vdc from AC adapter
Power Supply Type 2 (support unit only)	56Vdc from POE Brand: CISCO Model: AIR-PWRINJ1500-2 Power Rating: I/P: 100-240Vac, 50/60Hz, 1.5A O/P: 56Vdc, 1.43A

1.1.4 Accessories

Accessories		
No.	Equipment	Description
1	AC Adapter	Brand Name: DVE Model Name: DSA-20CA-12 Power Rating: I/P: 100-240Vac, 50/60Hz, 0.8A O/P: 12Vdc, 1.5A Power Line: 1.5m non-shielded cable w/o core
2	RJ45 cable	1.5m non-shielded cable without core

1.1.5 Channel List

802.11 a / HT20 / VHT20		HT40 / VHT40	
Channel	Frequency(MHz)	Channel	Frequency(MHz)
52	5260	54	5270
56	5280	62	5310
60	5300	102	5510
64	5320	110	5550
100	5500	134	5670
104	5520	142	5710
108	5540	VHT80	
112	5560	58	5290
116	5580	106	5530
132	5660	138	5690
136	5680	---	---
140	5700	---	---
144	5720	---	---

1.1.6 Test Tool and Duty Cycle

Test Tool	MTool, Version: 2.0.1.0				
Duty Cycle and Duty Factor	Mode	Non-Beamforming		Beamforming	
		Duty cycle (%)	Duty factor (dB)	Duty cycle (%)	Duty factor (dB)
	11a	99.29%	0.03	---	---
	VHT20	99.26%	0.03	98.10%	0.08
	VHT40	98.23%	0.08	98.47%	0.07
VHT80	95.27%	0.21	98.07%	0.08	

1.1.7 Power Setting

For Frequency band 5250~5350 MHz			
Modulation Mode	Test Frequency (MHz)	Power Set	
		Non-Beamforming	Beamforming
11a	5260	92	---
11a	5300	92	---
11a	5320	77	---
HT20	5260	74	70
HT20	5300	74	74
HT20	5320	74	74
HT40	5270	85	78
HT40	5310	62	62
VHT20	5260	74	70
VHT20	5300	74	74
VHT20	5320	74	74
VHT40	5270	85	78
VHT40	5310	62	62
VHT80	5290	51	51

For Frequency band 5470~5725 MHz			
Modulation Mode	Test Frequency (MHz)	Power Set	
		Non-Beamforming	Beamforming
11a	5500	76	---
11a	5580	92	---
11a	5700	70	---
HT20	5500	70	70
HT20	5580	70	70
HT20	5700	64	64
HT40	5510	58	58
HT40	5550	84	76
HT40	5670	76	74
VHT20	5500	70	70
VHT20	5580	70	70
VHT20	5700	64	64
VHT40	5510	58	58
VHT40	5550	84	76
VHT40	5670	76	74
VHT80	5530	56	56

Channel that extends across the 5.725 GHz boundary

For Frequency band 5470~5725 MHz			
Modulation Mode	Test Frequency (MHz)	Power Set	
		Non-Beamforming	Beamforming
11a	5720	84	---
HT20	5720	70	70
HT40	5710	84	78
VHT20	5720	70	70
VHT40	5710	84	78
VHT80	5690	80	78

1.2 Local Support Equipment List

Support Equipment List					
No.	Equipment	Brand	Model	FCC ID	Signal cable / Length (m)
1	Notebook	DELL	Latitude E5420	DoC	RJ45, 8m non-shielded.
2	POE	CISCO	AIR-PWRINJ1500-2	---	RJ45, 8m non-shielded.

Note: POE is provided by applicant.

1.3 Test Setup Chart

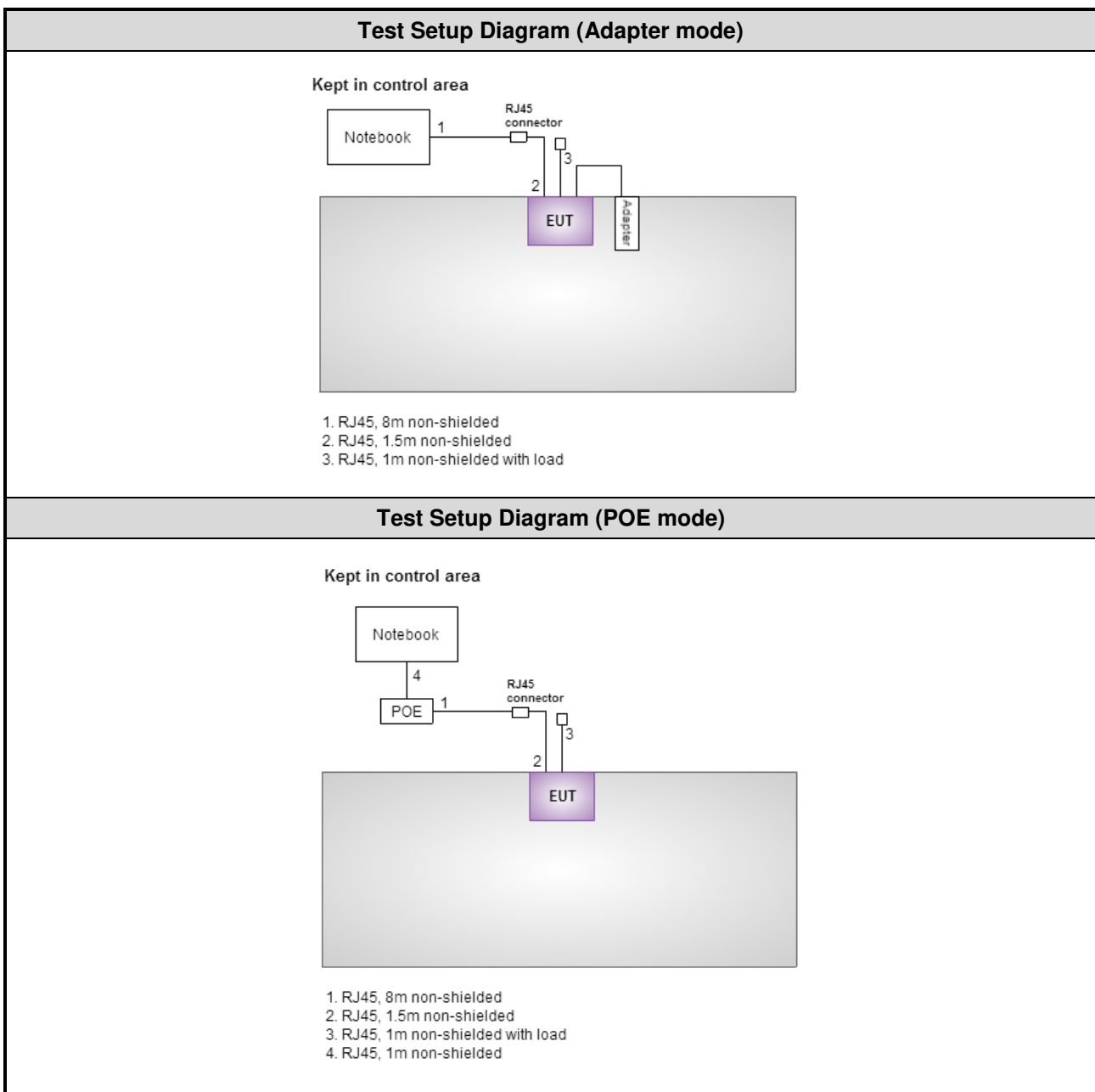

1.4 The Equipment List

Test Item	Conducted Emission				
Test Site	Conduction room 1 / (CO01-WS)				
Tested Date	Apr. 20, 2015				
Instrument	Manufacturer	Model No.	Serial No.	Calibration Date	Calibration Until
EMC Receiver	R&S	ESCS 30	100169	Oct. 17, 2014	Oct. 16, 2015
LISN	SCHWARZBECK	Schwarzbeck 8127	8127-667	Nov. 17, 2014	Nov. 16, 2015
RF Cable-CON	Woken	CFD200-NL	CFD200-NL-001	Dec. 31, 2014	Dec. 30, 2015
Measurement Software	AUDIX	e3	6.120210k	NA	NA
Note: Calibration Interval of instruments listed above is one year.					

Test Item	Radiated Emission				
Test Site	966 chamber 3 / (03CH03-WS)				
Tested Date	May 05 ~ Aug. 24, 2015				
Instrument	Manufacturer	Model No.	Serial No.	Calibration Date	Calibration Until
Spectrum Analyzer	Agilent	N9010A	MY53400091	Sep. 16, 2014	Sep. 15, 2015
Receiver	Agilent	N9038A	MY53290044	Oct. 21, 2014	Oct. 20, 2015
Bilog Antenna	SCHWARZBECK	VULB9168	VULB9168-562	Jan. 19, 2015	Jan. 18, 2016
Horn Antenna 1G-18G	SCHWARZBECK	BBHA 9120 D	BBHA 9120 D 1206	Feb. 03, 2015	Feb. 02, 2016
Horn Antenna 18G-40G	SCHWARZBECK	BBHA 9170	BBHA 9170517	Nov. 10, 2014	Nov. 09, 2015
Loop Antenna	R&S	HFH2-Z2	11900	Nov. 10, 2014	Nov. 09, 2015
Preamplifier	EMC	EMC02325	980187	Sep. 26, 2014	Sep. 25, 2015
Preamplifier	Agilent	83017A	MY53270014	Sep. 17, 2014	Sep. 16, 2015
Preamplifier	EMC	EMC184045B	980192	Aug. 26, 2014	Aug. 25, 2015
RF cable-3M	HUBER+SUHNER	SUCOFLEX104	MY22620/4	Feb. 09, 2015	Feb. 08, 2016
RF cable-8M	HUBER+SUHNER	SUCOFLEX104	MY22601/4	Feb. 09, 2015	Feb. 08, 2016
RF cable-1M	HUBER+SUHNER	SUCOFLEX104	MY22624/4	Feb. 09, 2015	Feb. 08, 2016
LF cable-0.8M	EMC	EMC8D-NM-NM-800	EMC8D-NM-NM-800-001	Feb. 09, 2015	Feb. 08, 2016
LF cable-3M	EMC	EMC8D-NM-NM-3000	131103	Feb. 09, 2015	Feb. 08, 2016
LF cable-13M	EMC	EMC8D-NM-NM-13000	131104	Feb. 09, 2015	Feb. 08, 2016
Measurement Software	AUDIX	e3	6.120210g	NA	NA
Note: Calibration Interval of instruments listed above is one year.					

Test Item	RF Conducted				
Test Site	(TH01-WS)				
Tested Date	Sep. 11 ~ Sep. 16, 2015				
Instrument	Manufacturer	Model No.	Serial No.	Calibration Date	Calibration Until
Spectrum Analyzer	R&S	FSV40	101063	Feb. 03, 2015	Feb. 02, 2016
TEMP&HUMIDITY CHAMBER	GIANT FORCE	GCT-225-40-SP-SD	MAF1212-002	Dec. 03, 2014	Dec. 02, 2015
Power Meter	Anritsu	ML2495A	1241002	Sep. 29, 2014	Sep. 28, 2015
Power Sensor	Anritsu	MA2411B	1207366	Sep. 29, 2014	Sep. 28, 2015
Measurement Software	Sporton	Sporton_1	1.3.30	NA	NA
Note: Calibration Interval of instruments listed above is one year.					

1.5 Testing Applied Standards

According to the specification of EUT, the EUT must comply with following standards and KDB documents.

47 CFR FCC Part 15.407

ANSI C63.10-2013

FCC KDB 789033 D02 General UNII Test Procedures New Rules v01

FCC KDB 644545 D03 Guidance for IEEE 802.11ac New Rules v01

FCC KDB 662911 D01 Multiple Transmitter Output v02r01

FCC KDB 412172 D01 Determining ERP and EIRP v01r01

1.6 Measurement Uncertainty

ISO/IEC 17025 requires that an estimate of the measurement uncertainties associated with the emissions test results be included in the report. The measurement uncertainties given below are based on a 95% confidence level (based on a coverage factor (k=2))

Measurement Uncertainty	
Parameters	Uncertainty
Bandwidth	±34.134 Hz
Conducted power	±0.808 dB
Frequency error	±34.134 Hz
Power density	±0.463 dB
Conducted emission	±2.670 dB
AC conducted emission	±2.92 dB
Radiated emission ≤ 1GHz	±3.99 dB
Radiated emission > 1GHz	±5.52 dB
Time	±0.1%
Temperature	±0.6 °C

2 Test Configuration

2.1 Testing Condition

Test Item	Test Site	Ambient Condition	Tested By
AC Conduction	CO01-WS	20°C / 66%	Kevin Ma
Radiated Emissions	03CH03-WS	21°C / 62-66%	Warren Lee Brad Wu
RF Conducted	TH01-WS	23°C / 62%	Felix Sung

➤ FCC site registration No.: 390588

➤ IC site registration No.: 10807C-1

2.2 The Worst Test Modes and Channel Details

For Frequency band 5250-5350 MHz, 5470-5725 MHz				
Test item	Modulation Mode	Test Frequency (MHz)	Data Rate	Test Configuration
Conducted Emissions	VHT40	5550	MCS 0	1, 2
	VHT40	5270	MCS 0	3, 4
Radiated Emissions \leq 1GHz	VHT40	5550	MCS 0	1, 2
	VHT40	5270	MCS 0	3, 4
RF Output Power	11a	5260 / 5300 / 5320 5500 / 5580 / 5700 / 5720	6 Mbps	1, 3
	HT20	5260 / 5300 / 5320 5500 / 5580 / 5700 / 5720	MCS 0	
	HT40	5270 / 5310 5510 / 5550 / 5670 / 5710	MCS 0	
	VHT20	5260 / 5300 / 5320 5500 / 5580 / 5700 / 5720	MCS 0	
	VHT40	5270 / 5310 5510 / 5550 / 5670 / 5710	MCS 0	
	VHT80	5290 / 5530 / 5690	MCS 0	
Radiated Emissions >1GHz Emission Bandwidth Peak Power Spectral Density	11a	5260 / 5300 / 5320 5500 / 5580 / 5700 / 5720	6 Mbps	1
	VHT20	5260 / 5300 / 5320 5500 / 5580 / 5700 / 5720	MCS 0	
	VHT40	5270 / 5310 5510 / 5550 / 5670 / 5710	MCS 0	
	VHT80	5290 / 5530 / 5690	MCS 0	
Radiated Emissions >1GHz Emission Bandwidth Peak Power Spectral Density	VHT20	5260 / 5300 / 5320 5500 / 5580 / 5700 / 5720	MCS 0	3
	VHT40	5270 / 5310 5510 / 5550 / 5670 / 5710	MCS 0	
	VHT80	5290 / 5530 / 5690	MCS 0	
Frequency Stability	Un-modulation	5300	---	1
NOTE:				
1. The EUT was pretested with 3 orientations placed on the table for the radiated emission measurement – X, Y, and Z-plane. The X-plane results were found as the worst case and were shown in this report.				
2. Test configurations are listed as below:				
1) Configuration 1: Non-beamforming mode, Adapter mode				
2) Configuration 2: Non-beamforming mode, PoE mode				
3) Configuration 3: Beamforming mode, Adapter mode				
4) Configuration 4: Beamforming mode, PoE mode				

3 Transmitter Test Results

3.1 Conducted Emissions

3.1.1 Limit of Conducted Emissions

Conducted Emissions Limit		
Frequency Emission (MHz)	Quasi-Peak	Average
0.15-0.5	66 - 56 *	56 - 46 *
0.5-5	56	46
5-30	60	50

Note 1: * Decreases with the logarithm of the frequency.

3.1.2 Test Procedures

1. The device is placed on a test table, raised 80 cm above the reference ground plane. The vertical conducting plane is located 40 cm to the rear of the device.
2. The device is connected to line impedance stabilization network (LISN) and other accessories are connected to other LISN. Measured levels of AC power line conducted emission are across the 50 Ω LISN port.
3. AC conducted emission measurements is made over frequency range from 150 kHz to 30 MHz.
4. This measurement was performed with AC 120V/60Hz

3.1.3 Test Setup

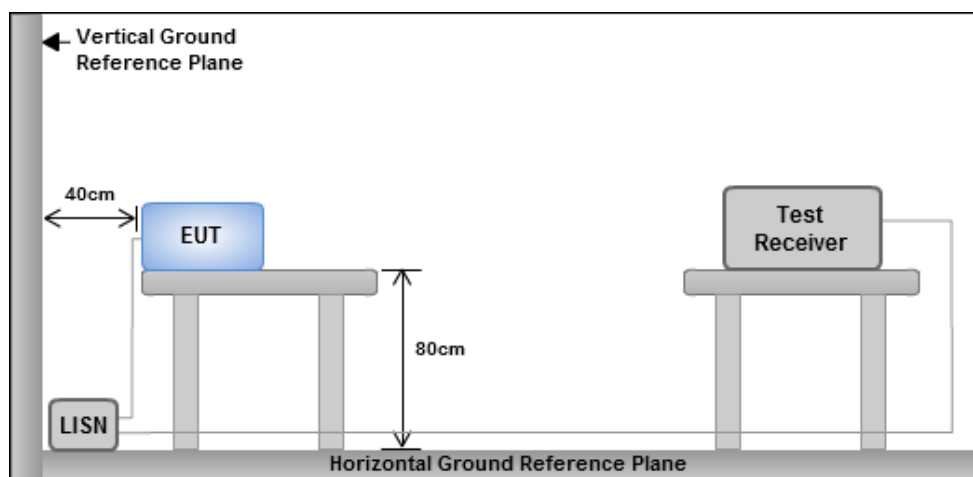

Note: 1. Support units were connected to second LISN.

2. Both of LISNs (AMN) are 80 cm from EUT and at least 80 cm from other units and other metal planes

3.1.4 Test Result of Conducted Emissions

Non- beamforming mode

Modulation	VHT40	Test Freq. (MHz)	5550
Power Phase	Line	Configuration	1

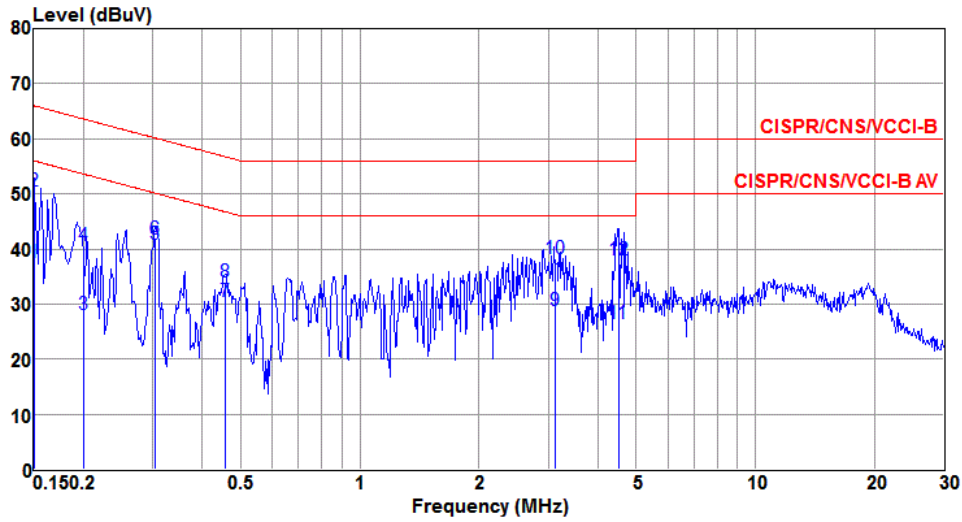

	Freq	Level	Limit	Over	Read	LISN	cable	
	MHz	dBuV	Line	Limit	Level	factor	loss	Remark
			dBuV	dB	dBuV	dB	dB	
1	0.150	37.48	56.00	-18.52	36.48	0.92	0.08	Average
2	0.150	50.58	66.00	-15.42	49.58	0.92	0.08	QP
3	0.201	28.04	53.58	-25.54	27.70	0.25	0.09	Average
4	0.201	40.67	63.58	-22.91	40.33	0.25	0.09	QP
5*	0.303	40.84	50.15	-9.31	40.53	0.21	0.10	Average
6	0.303	41.78	60.15	-18.37	41.47	0.21	0.10	QP
7	0.456	30.56	46.76	-16.20	30.27	0.17	0.12	Average
8	0.456	33.90	56.76	-22.86	33.61	0.17	0.12	QP
9	3.109	28.85	46.00	-17.15	28.18	0.39	0.28	Average
10	3.109	38.26	56.00	-17.74	37.59	0.39	0.28	QP
11	4.501	26.35	46.00	-19.65	25.73	0.31	0.31	Average
12	4.501	38.08	56.00	-17.92	37.46	0.31	0.31	QP

Note 1: Level (dBUV) = Read Level (dBUV) + LISN Factor (dB) + Cable Loss (dB).

Note 2: Over Limit (dB) = Level (dBUV) – Limit Line (dBUV).

Modulation	VHT40	Test Freq. (MHz)	5550
Power Phase	Neutral	Configuration	1

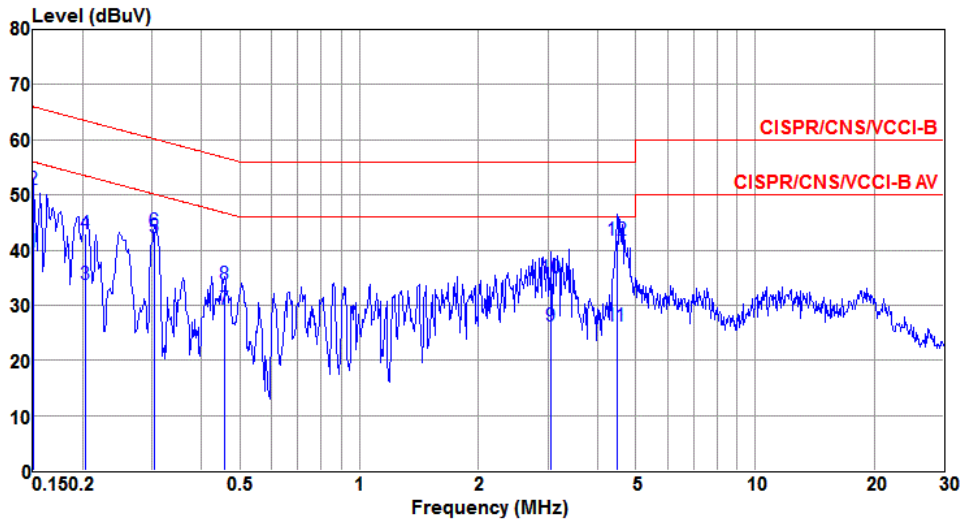

	Freq MHz	Level dBuV	Limit Line dBuV	Over Limit dB	Read Level dBuV	LISN factor dB	cable loss dB	Remark
1	0.150	39.55	56.00	-16.45	38.62	0.85	0.08	Average
2	0.150	50.93	66.00	-15.07	50.00	0.85	0.08	QP
3	0.203	33.79	53.50	-19.71	33.46	0.24	0.09	Average
4	0.203	43.07	63.50	-20.43	42.74	0.24	0.09	QP
5*	0.304	42.21	50.13	-7.92	41.94	0.17	0.10	Average
6	0.304	43.52	60.13	-16.61	43.25	0.17	0.10	QP
7	0.456	29.19	46.76	-17.57	28.92	0.15	0.12	Average
8	0.456	33.77	56.76	-22.99	33.50	0.15	0.12	QP
9	3.058	26.20	46.00	-19.80	25.39	0.53	0.28	Average
10	3.058	34.97	56.00	-21.03	34.16	0.53	0.28	QP
11	4.478	26.15	46.00	-19.85	25.13	0.71	0.31	Average
12	4.478	41.69	56.00	-14.31	40.67	0.71	0.31	QP

Note 1: Level (dBuV) = Read Level (dBuV) + LISN Factor (dB) + Cable Loss (dB).
 2: Over Limit (dB) = Level (dBuV) – Limit Line (dBuV).

Modulation	VHT40	Test Freq. (MHz)	5550
Power Phase	Line	Configuration	2

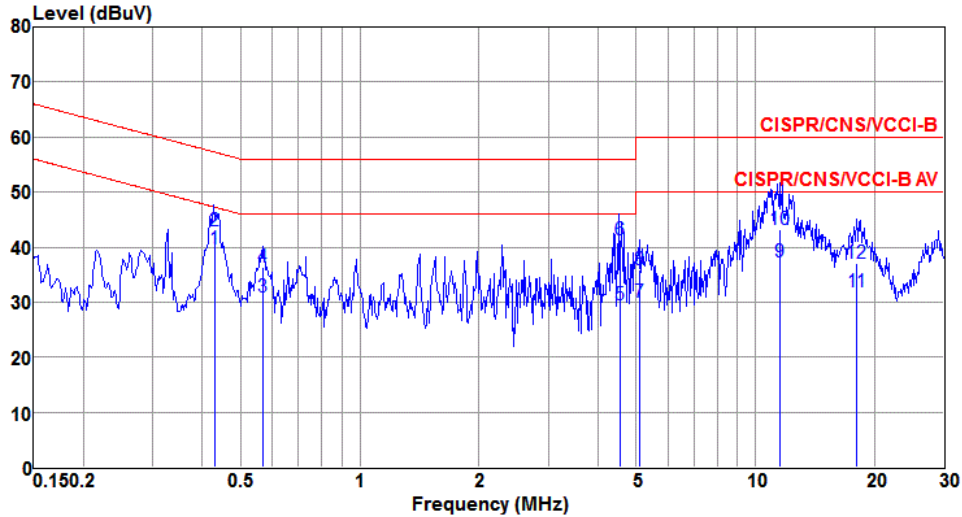

	Freq MHz	Level dBuV	Limit Line dBuV	Over Limit dB	Read Level dBuV	LISN factor dB	cable loss dB	Remark
1*	0.430	39.61	47.26	-7.65	39.43	0.07	0.11	Average
2	0.430	42.88	57.26	-14.38	42.70	0.07	0.11	QP
3	0.567	30.93	46.00	-15.07	30.73	0.07	0.13	Average
4	0.567	36.42	56.00	-19.58	36.22	0.07	0.13	QP
5	4.544	29.55	46.00	-16.45	29.11	0.13	0.31	Average
6	4.544	41.39	56.00	-14.61	40.95	0.13	0.31	QP
7	5.085	29.97	50.00	-20.03	29.52	0.14	0.31	Average
8	5.085	35.86	60.00	-24.14	35.41	0.14	0.31	QP
9	11.498	37.21	50.00	-12.79	36.71	0.23	0.27	Average
10	11.498	43.28	60.00	-16.72	42.78	0.23	0.27	QP
11	18.039	31.92	50.00	-18.08	31.53	0.30	0.09	Average
12	18.039	37.08	60.00	-22.92	36.69	0.30	0.09	QP

Note 1: Level (dBuV) = Read Level (dBuV) + LISN Factor (dB) + Cable Loss (dB).
 2: Over Limit (dB) = Level (dBuV) – Limit Line (dBuV).

Modulation	VHT40	Test Freq. (MHz)	5550
Power Phase	Neutral	Configuration	2

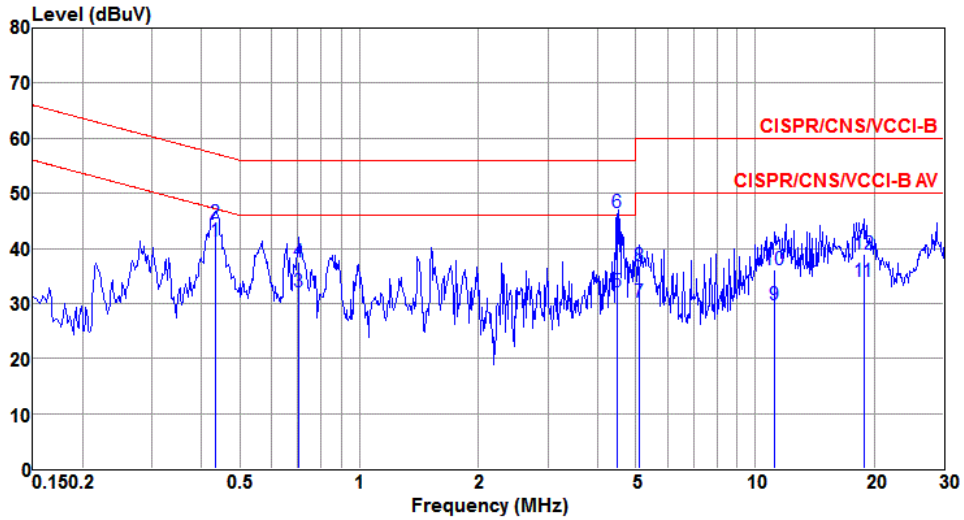

	Freq	Level	Limit	Over	Read	LISN	cable	Remark
	MHz	dBuV	Line	Limit	Level	factor	loss	
			dBuV	dB	dBuV	dB	dB	
1*	0.433	41.27	47.20	-5.93	41.09	0.07	0.11	Average
2	0.433	44.69	57.20	-12.51	44.51	0.07	0.11	QP
3	0.705	32.04	46.00	-13.96	31.82	0.08	0.14	Average
4	0.705	37.46	56.00	-18.54	37.24	0.08	0.14	QP
5	4.478	32.01	46.00	-13.99	31.56	0.14	0.31	Average
6	4.478	46.46	56.00	-9.54	46.01	0.14	0.31	QP
7	5.112	30.25	50.00	-19.75	29.78	0.16	0.31	Average
8	5.112	36.72	60.00	-23.28	36.25	0.16	0.31	QP
9	11.198	29.86	50.00	-20.14	29.34	0.25	0.27	Average
10	11.198	36.21	60.00	-23.79	35.69	0.25	0.27	QP
11	18.820	33.88	50.00	-16.12	33.49	0.33	0.06	Average
12	18.820	38.85	60.00	-21.15	38.46	0.33	0.06	QP

Note 1: Level (dBuV) = Read Level (dBuV) + LISN Factor (dB) + Cable Loss (dB).
 Note 2: Over Limit (dB) = Level (dBuV) – Limit Line (dBuV).

Beamforming mode

Modulation	VHT40	Test Freq. (MHz)	5270
Power Phase	Line	Configuration	3

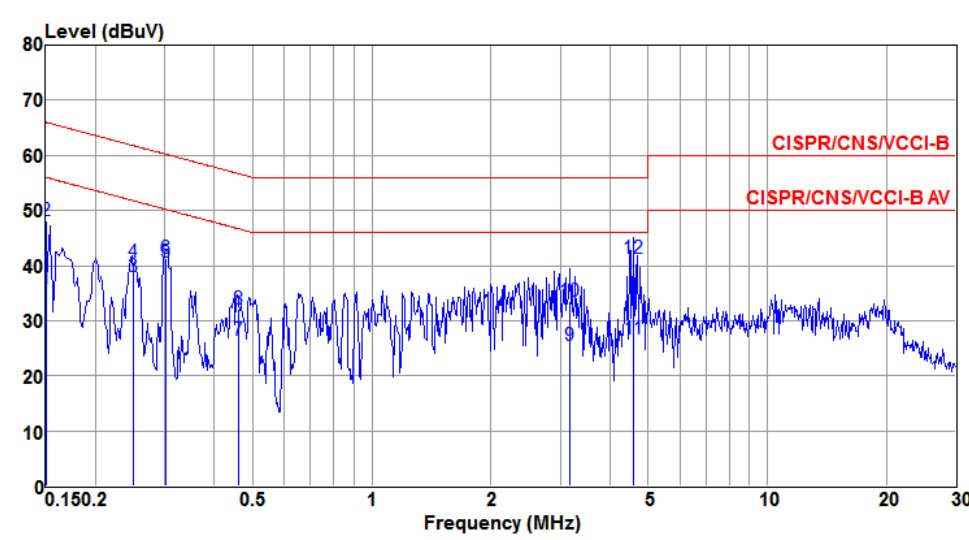

The plot shows a blue signal line representing the measured spectrum. Two red lines represent the limits: CISPR/CNS/VCCI-B (upper) and CISPR/CNS/VCCI-B AV (lower). The x-axis is logarithmic from 0.150.2 to 30 MHz. The y-axis is linear from 0 to 80 dBuV. Several peaks are marked with numbers 1 through 12.

	Freq MHz	Level dBuV	Limit Line dBuV	Over Limit dB	Read Level dBuV	LISN factor dB	cable loss dB	Remark
1	0.150	35.81	56.00	-20.19	34.81	0.92	0.08	Average
2	0.150	48.24	66.00	-17.76	47.24	0.92	0.08	QP
3	0.250	37.96	51.77	-13.81	37.63	0.23	0.10	Average
4	0.250	40.71	61.77	-21.06	40.38	0.23	0.10	QP
5*	0.302	40.61	50.18	-9.57	40.30	0.21	0.10	Average
6	0.302	41.31	60.18	-18.87	41.00	0.21	0.10	QP
7	0.459	26.55	46.71	-20.16	26.26	0.17	0.12	Average
8	0.459	32.11	56.71	-24.60	31.82	0.17	0.12	QP
9	3.156	25.40	46.00	-20.60	24.72	0.39	0.29	Average
10	3.156	33.60	56.00	-22.40	32.92	0.39	0.29	QP
11	4.598	26.77	46.00	-19.23	26.14	0.32	0.31	Average
12	4.598	41.35	56.00	-14.65	40.72	0.32	0.31	QP

Note 1: Level (dBuV) = Read Level (dBuV) + LISN Factor (dB) + Cable Loss (dB).
 Note 2: Over Limit (dB) = Level (dBuV) – Limit Line (dBuV).

Modulation	VHT40	Test Freq. (MHz)	5270
Power Phase	Neutral	Configuration	3

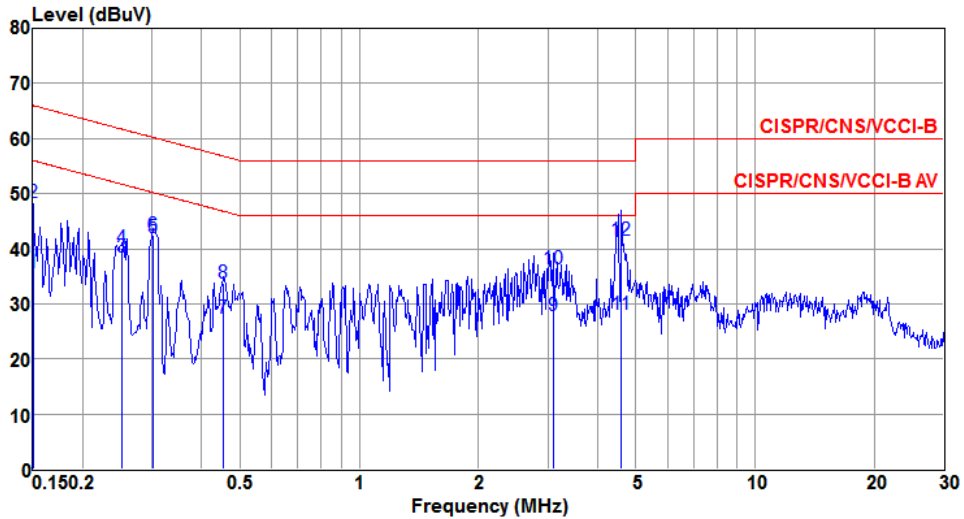

	Freq	Level	Limit	Over	Read	LISN	cable	
	MHz	dBuV	Line	Limit	Level	factor	loss	Remark
			dBuV	dB	dBuV	dB	dB	
1	0.150	35.58	56.00	-20.42	34.65	0.85	0.08	Average
2	0.150	48.47	66.00	-17.53	47.54	0.85	0.08	QP
3	0.251	38.38	51.72	-13.34	38.08	0.20	0.10	Average
4	0.251	40.23	61.72	-21.49	39.93	0.20	0.10	QP
5*	0.301	42.09	50.20	-8.11	41.82	0.17	0.10	Average
6	0.301	42.60	60.20	-17.60	42.33	0.17	0.10	QP
7	0.454	27.46	46.80	-19.34	27.19	0.15	0.12	Average
8	0.454	33.75	56.80	-23.05	33.48	0.15	0.12	QP
9	3.090	27.97	46.00	-18.03	27.14	0.55	0.28	Average
10	3.090	36.46	56.00	-19.54	35.63	0.55	0.28	QP
11	4.598	27.99	46.00	-18.01	26.97	0.71	0.31	Average
12	4.598	41.58	56.00	-14.42	40.56	0.71	0.31	QP

Note 1: Level (dBuV) = Read Level (dBuV) + LISN Factor (dB) + Cable Loss (dB).
 2: Over Limit (dB) = Level (dBuV) – Limit Line (dBuV).

Modulation	VHT40	Test Freq. (MHz)	5270
Power Phase	Line	Configuration	4

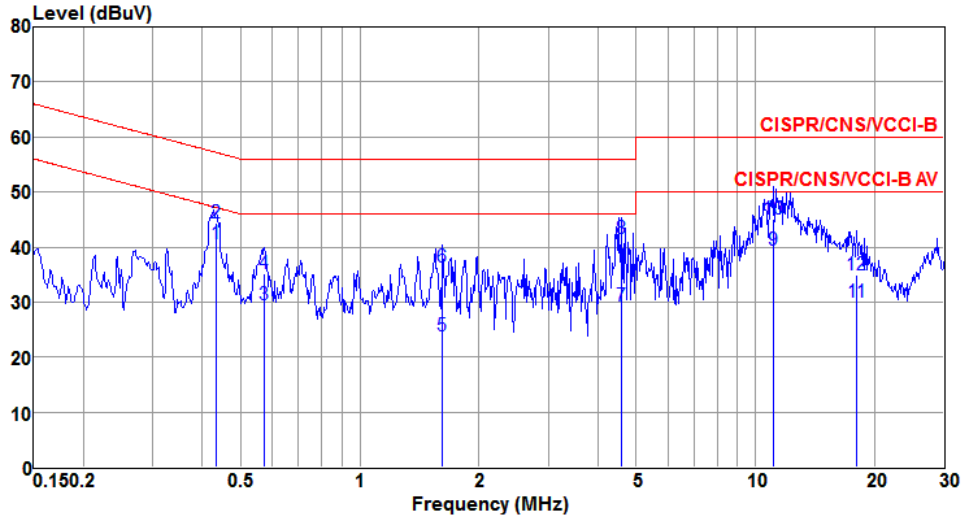

	Freq MHz	Level dBuV	Limit Line dBuV	Over Limit dB	Read Level dBuV	LISN factor dB	cable loss dB	Remark
1*	0.433	40.72	47.20	-6.48	40.54	0.07	0.11	Average
2	0.433	44.46	57.20	-12.74	44.28	0.07	0.11	QP
3	0.573	29.55	46.00	-16.45	29.35	0.07	0.13	Average
4	0.573	35.11	56.00	-20.89	34.91	0.07	0.13	QP
5	1.619	23.94	46.00	-22.06	23.63	0.09	0.22	Average
6	1.619	36.40	56.00	-19.60	36.09	0.09	0.22	QP
7	4.598	29.39	46.00	-16.61	28.95	0.13	0.31	Average
8	4.598	41.47	56.00	-14.53	41.03	0.13	0.31	QP
9	11.139	39.40	50.00	-10.60	38.90	0.23	0.27	Average
10	11.139	45.05	60.00	-14.95	44.55	0.23	0.27	QP
11	18.039	29.87	50.00	-20.13	29.48	0.30	0.09	Average
12	18.039	34.92	60.00	-25.08	34.53	0.30	0.09	QP

Note 1: Level (dBuV) = Read Level (dBuV) + LISN Factor (dB) + Cable Loss (dB).
 Note 2: Over Limit (dB) = Level (dBuV) – Limit Line (dBuV).

Modulation	VHT40	Test Freq. (MHz)	5270
Power Phase	Neutral	Configuration	4

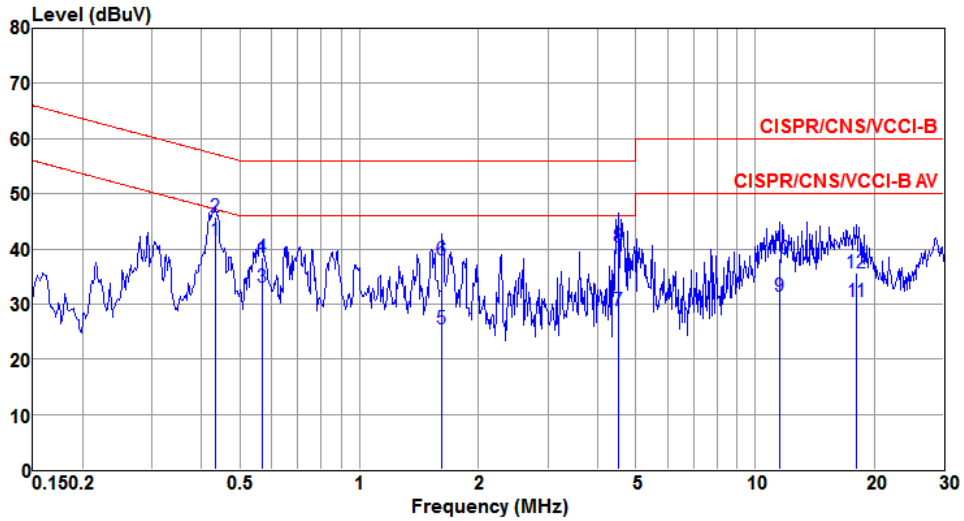

	Freq MHz	Level dBuV	Limit Line dBuV	Over Limit dB	Read Level dBuV	LISN factor dB	cable loss dB	Remark
1*	0.433	41.61	47.19	-5.58	41.43	0.07	0.11	Average
2	0.433	45.83	57.19	-11.36	45.65	0.07	0.11	QP
3	0.567	33.09	46.00	-12.91	32.89	0.07	0.13	Average
4	0.567	38.38	56.00	-17.62	38.18	0.07	0.13	QP
5	1.619	25.38	46.00	-20.62	25.07	0.09	0.22	Average
6	1.619	38.01	56.00	-17.99	37.70	0.09	0.22	QP
7	4.501	28.91	46.00	-17.09	28.46	0.14	0.31	Average
8	4.501	40.25	56.00	-15.75	39.80	0.14	0.31	QP
9	11.498	31.47	50.00	-18.53	30.95	0.25	0.27	Average
10	11.498	38.16	60.00	-21.84	37.64	0.25	0.27	QP
11	18.039	30.43	50.00	-19.57	30.02	0.32	0.09	Average
12	18.039	35.53	60.00	-24.47	35.12	0.32	0.09	QP

Note 1: Level (dBuV) = Read Level (dBuV) + LISN Factor (dB) + Cable Loss (dB).
 2: Over Limit (dB) = Level (dBuV) – Limit Line (dBuV).

3.2 Emission Bandwidth

3.2.1 Test Procedures

26dB Bandwidth

1. Set RBW = approximately 1% of the emission bandwidth.
2. Set the VBW > RBW, Detector = Peak.
3. Trace mode = max hold.
4. Measure the maximum width of the emission that is 26 dB down from the peak of the emission.

Occupied Bandwidth

1. Set RBW = 1 % to 5 % of the OBW
2. Set VBW \geq 3 RBW
3. Sample detection and single sweep mode shall be used
4. Use the 99 % power bandwidth function of the instrument

3.2.2 Test Setup

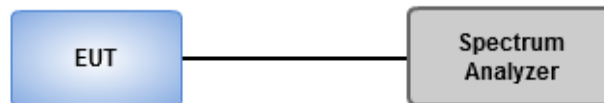

3.2.3 Test Result of Emission Bandwidth

Non-beamforming mode - Test Configuration 1

Emission Bandwidth									
Mode	N _{TX}	Freq. (MHz)	26dB Bandwidth (MHz)			99% Bandwidth (MHz)			Power Limit (dBm)
			Chain 0	Chain 1	Chain 2	Chain 0	Chain 1	Chain 2	
11a	1	5260	43.30	---	---	19.45	---	---	24.00
11a	1	5300	43.74	---	---	19.31	---	---	24.00
11a	1	5320	36.96	---	---	17.43	---	---	24.00
VHT20	2	5260	39.48	35.13	---	18.07	17.97	---	24.00
VHT20	2	5300	40.26	32.61	---	18.07	17.97	---	24.00
VHT20	2	5320	39.13	32.32	---	18.05	17.97	---	24.00
VHT40	2	5270	69.57	77.57	---	38.22	38.08	---	24.00
VHT40	2	5310	45.22	41.39	---	36.60	36.54	---	24.00
VHT80	2	5290	82.09	83.48	---	76.16	76.08	---	24.00
11a	1	5500	33.77	---	---	17.12	---	---	24.00
11a	1	5580	51.25	---	---	18.96	---	---	24.00
11a	1	5700	28.87	---	---	17.02	---	---	24.00
VHT20	2	5500	26.78	24.06	---	17.96	17.85	---	24.00
VHT20	2	5580	28.17	25.22	---	17.96	17.84	---	24.00
VHT20	2	5700	24.00	22.26	---	17.93	17.82	---	24.00
VHT40	2	5510	41.04	40.93	---	36.50	36.46	---	24.00
VHT40	2	5550	69.33	73.97	---	37.48	37.48	---	24.00
VHT40	2	5670	82.61	76.67	---	36.86	36.70	---	24.00
VHT80	2	5530	83.01	83.01	---	76.24	76.16	---	24.00

Worst Plot of 26dB Bandwidth

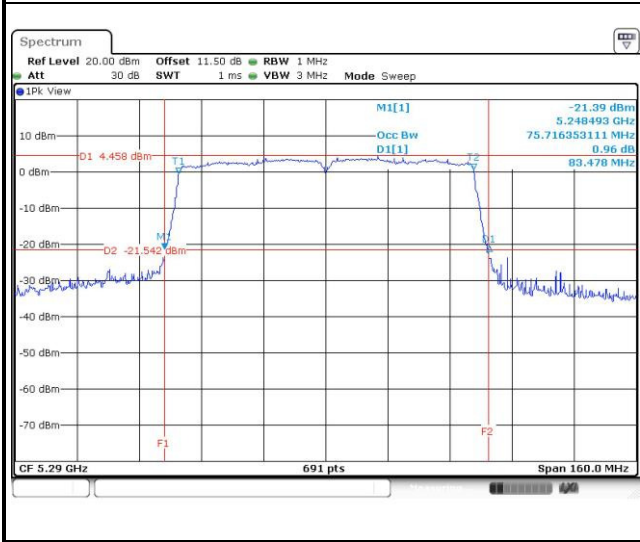

Worst Plot of 99% Bandwidth

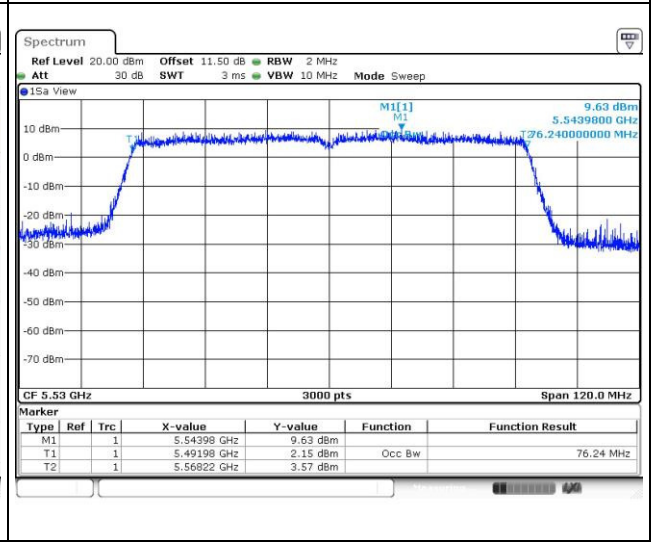

Channel that extends across the 5.725 GHz boundary

UNII Emission Bandwidth Result (Within 5470-5725MHz band)									
Mode	N _{TX}	Freq. (MHz)	26dB Bandwidth (MHz)			99% Bandwidth (MHz)			Power Limit (dBm)
			Chain 0	Chain 1	Chain 2	Chain 0	Chain 1	Chain 2	
11a	1	5720	25.87	---	---	15.84	---	---	24.00
VHT20	2	5720	19.96	19.09	---	13.99	13.92	---	23.81
VHT40	2	5710	64.62	63.41	---	33.95	33.55	---	24.00
VHT80	2	5690	121.96	116.09	---	73.50	73.34	---	24.00

UNII Emission Bandwidth Result (Extends across 5725MHz band)									
Mode	N _{TX}	Freq. (MHz)	26dB Bandwidth (MHz)			99% Bandwidth (MHz)			
			Chain 0	Chain 1	Chain 2	Chain 0	Chain 1	Chain 2	
11a	1	5720	17.10	---	---	5.88	---	---	
VHT20	2	5720	12.24	11.89	---	4.03	3.98	---	
VHT40	2	5710	36.23	35.48	---	4.45	3.91	---	
VHT80	2	5690	75.13	68.06	---	3.86	3.62	---	

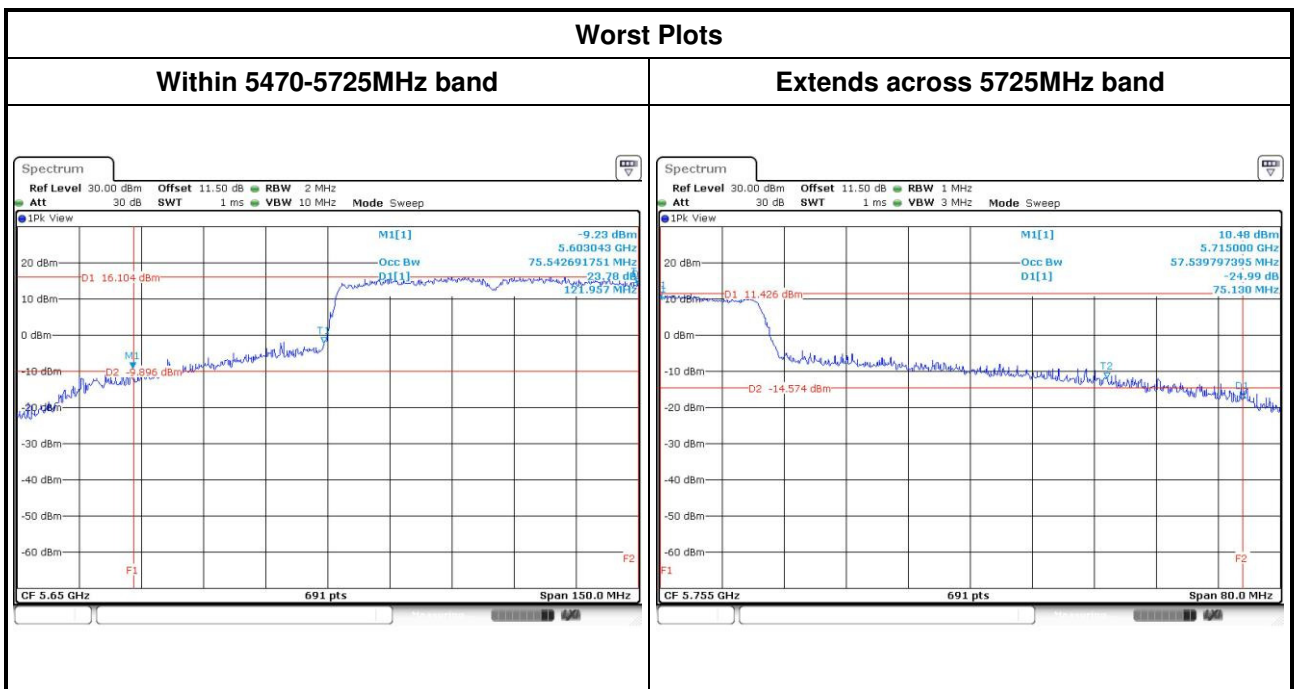

Beamforming mode - Test Configuration 3

Emission Bandwidth									
Mode	N _{TX}	Freq. (MHz)	26dB Bandwidth (MHz)			99% Bandwidth (MHz)			Power Limit (dBm)
			Chain 0	Chain 1	Chain 2	Chain 0	Chain 1	Chain 2	
VHT20	2	5260	25.62	25.62	---	17.94	17.82	---	24.00
VHT20	2	5300	35.22	30.52	---	17.99	17.92	---	24.00
VHT20	2	5320	34.86	30.43	---	18.01	17.90	---	24.00
VHT40	2	5270	78.84	75.13	---	37.04	36.78	---	24.00
VHT40	2	5310	41.16	40.58	---	36.60	36.56	---	24.00
VHT80	2	5290	80.93	81.62	---	76.08	76.00	---	24.00
VHT20	2	5500	21.45	21.51	---	17.91	17.79	---	24.00
VHT20	2	5580	23.42	21.10	---	17.91	17.82	---	24.00
VHT20	2	5700	20.52	20.93	---	17.89	17.78	---	24.00
VHT40	2	5510	41.16	40.46	---	36.60	36.52	---	24.00
VHT40	2	5550	70.15	60.99	---	36.78	36.70	---	24.00
VHT40	2	5670	74.20	63.30	---	36.80	36.78	---	24.00
VHT80	2	5530	80.93	81.62	---	76.24	76.00	---	24.00

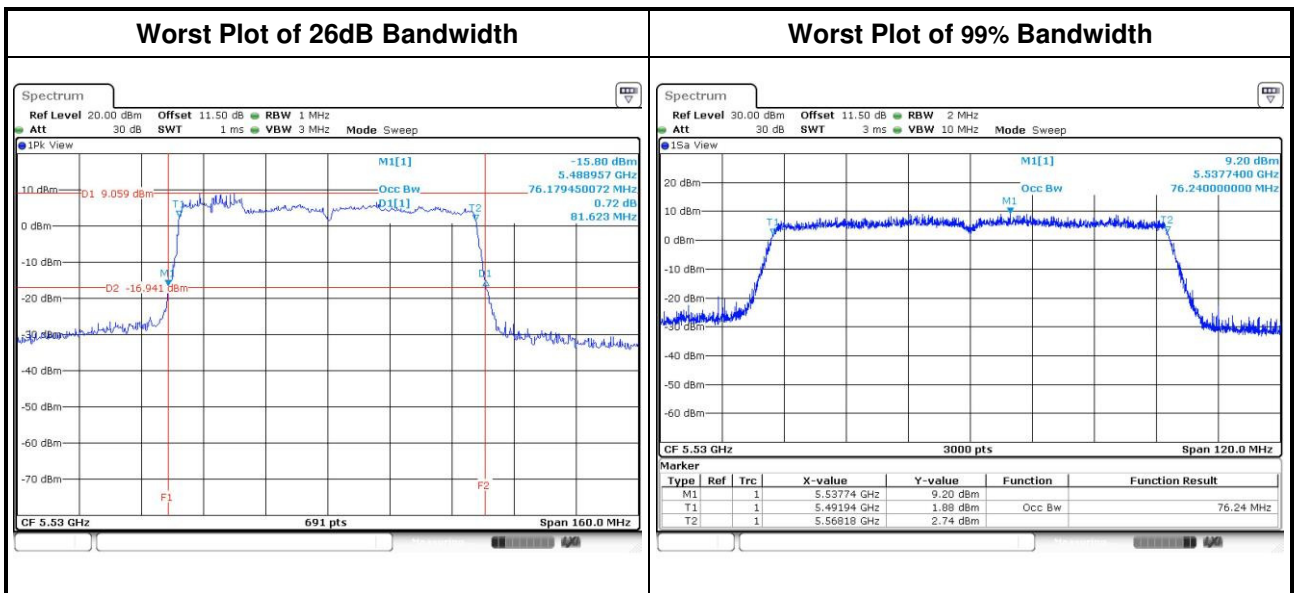

Channel that extends across the 5.725 GHz boundary

UNII Emission Bandwidth Result (Within 5470-5725MHz band)									
Mode	N _{TX}	Freq. (MHz)	26dB Bandwidth (MHz)			99% Bandwidth (MHz)			Power Limit (dBm)
			Chain 0	Chain 1	Chain 2	Chain 0	Chain 1	Chain 2	
VHT20	2	5720	17.49	16.94	---	13.98	13.92	---	23.29
VHT40	2	5710	52.04	51.94	---	33.37	33.35	---	24.00
VHT80	2	5690	103.91	114.78	---	73.26	73.18	---	24.00

UNII Emission Bandwidth Result (Extends across 5725MHz band)									
Mode	N _{TX}	Freq. (MHz)	26dB Bandwidth (MHz)			99% Bandwidth (MHz)			Power Limit (dBm)
			Chain 0	Chain 1	Chain 2	Chain 0	Chain 1	Chain 2	
VHT20	2	5720	11.15	9.87	---	4.01	3.94	---	23.29
VHT40	2	5710	29.22	29.04	---	3.45	3.41	---	24.00
VHT80	2	5690	58.35	58.00	---	3.54	3.38	---	24.00

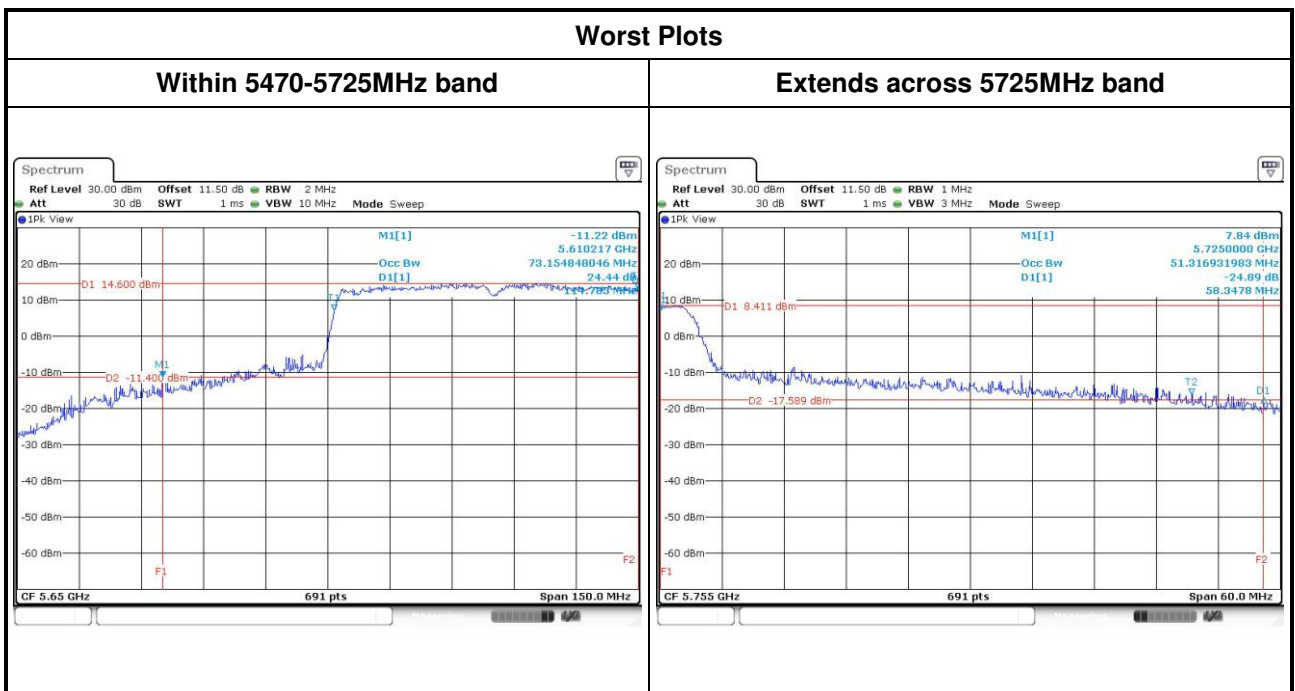

3.3 RF Output Power

3.3.1 Limit of RF Output Power

Frequency Band (MHz)	Limit
<input checked="" type="checkbox"/> 5250 ~ 5350	250mW or 11dBm+10 log B
<input checked="" type="checkbox"/> 5470 ~ 5725	250mW or 11dBm+10 log B

Note: "B" is the 26dB emission bandwidth in MHz.

3.3.2 Test Procedures

- Power meter (For channel that does not extends across the 5.725 GHz boundary)
 - Measurements is performed using a wideband gated RF power meter provided that the gate parameters are adjusted such that the power is measured only when the EUT is transmitting at its maximum power control level. Since the measurement is made only during the ON time of the transmitter, no duty cycle correction factor is required
- Spectrum analyzer (For channel that extends across the 5.725 GHz boundary)
 1. Set RBW=1MHz, VBW=3MHz , Sweep time= Auto, Detector = RMS
 2. Trace average at least 100 traces in power averaging mode
 3. Compute power by integrating the spectrum across the 26 dB EBW
 4. Add 10 log(1/X, X:duty cycle) if duty cycle is <98%

3.3.3 Test Setup

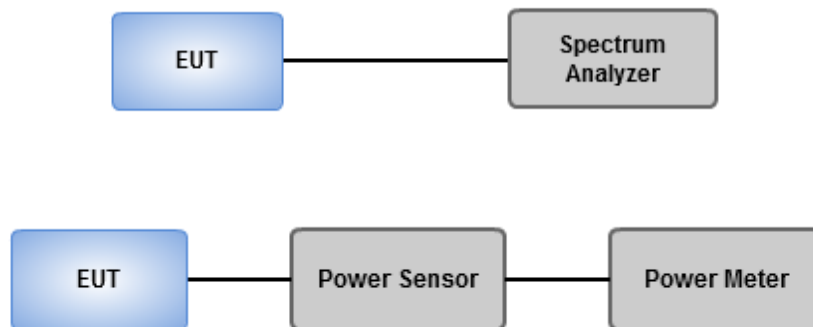

3.3.4 Test Result of Maximum Conducted Output Power

Non-beamforming mode - Test Configuration 1

Mode	N _{TX}	Freq. (MHz)	Conducted Power (dBm)				Total Power (mW)	Total Power (dBm)	Limit (dBm)
			Chain 0	Chain 1	Chain 2	Chain 3			
11a	1	5260	21.53	---	---	---	142.233	21.53	24.00
11a	1	5300	21.46	---	---	---	139.959	21.46	24.00
11a	1	5320	19.21	---	---	---	83.368	19.21	24.00
HT20	2	5260	18.43	18.16	---	---	135.126	21.31	24.00
HT20	2	5300	18.65	18.43	---	---	142.945	21.55	24.00
HT20	2	5320	18.63	18.36	---	---	141.495	21.51	24.00
HT40	2	5270	20.73	20.46	---	---	229.477	23.61	24.00
HT40	2	5310	15.73	15.41	---	---	72.165	18.58	24.00
VHT20	2	5260	18.51	18.22	---	---	137.332	21.38	24.00
VHT20	2	5300	18.72	18.51	---	---	145.431	21.63	24.00
VHT20	2	5320	18.72	18.49	---	---	145.105	21.62	24.00
VHT40	2	5270	20.82	20.55	---	---	234.282	23.70	24.00
VHT40	2	5310	15.76	15.45	---	---	72.746	18.62	24.00
VHT80	2	5290	13.21	13.19	---	---	41.786	16.21	24.00
11a	1	5500	19.67	---	---	---	92.683	19.67	24.00
11a	1	5580	22.31	---	---	---	170.216	22.31	24.00
11a	1	5700	18.42	---	---	---	69.502	18.42	24.00
HT20	2	5500	18.06	17.82	---	---	124.508	20.95	24.00
HT20	2	5580	17.96	17.65	---	---	120.728	20.82	24.00
HT20	2	5700	17.06	17.0	---	---	100.935	20.04	24.00
HT40	2	5510	15.07	14.94	---	---	63.326	18.02	24.00
HT40	2	5550	20.88	20.56	---	---	236.224	23.73	24.00
HT40	2	5670	19.04	19.01	---	---	159.784	22.04	24.00
VHT20	2	5500	18.15	17.89	---	---	126.831	21.03	24.00
VHT20	2	5580	18.03	17.72	---	---	122.689	20.89	24.00
VHT20	2	5700	17.13	17.01	---	---	101.876	20.08	24.00
VHT40	2	5510	15.12	15.03	---	---	64.351	18.09	24.00
VHT40	2	5550	20.95	20.69	---	---	241.671	23.83	24.00
VHT40	2	5670	19.09	19.03	---	---	161.080	22.07	24.00
VHT80	2	5530	14.66	14.49	---	---	57.361	17.59	24.00

Channel that extends across the 5.725 GHz boundary

Maximum Conducted Output Power (Within 5470-5725MHz band)											
Mode	N _{Tx}	Freq. (MHz)	Conducted Power without duty factor					Duty factor (dB)	Total Power (mW)	Total Power (dBm)	Limit (dBm)
			Chain 0	Chain 1	Chain 2	Chain 3	Total Power (dBm)				
11a	1	5720	22.11	---	---	---	22.11	0.00	162.555	22.11	24.00
HT20	2	5720	16.99	16.35	---	---	19.69	0.00	93.155	19.69	23.81
HT40	2	5710	20.30	19.66	---	---	23.00	0.00	199.622	23.00	24.00
VHT20	2	5720	17.05	16.38	---	---	19.74	0.00	94.150	19.74	23.81
VHT40	2	5710	20.35	19.66	---	---	23.03	0.00	200.863	23.03	24.00
VHT80	2	5690	19.67	19.14	---	---	22.42	0.21	183.374	22.63	24.00

Maximum Conducted Output Power (Extends across 5725MHz band)											
Mode	N _{Tx}	Freq. (MHz)	Conducted Power without duty factor					Duty factor (dB)	Total Power (mW)	Total Power (dBm)	Limit (dBm)
			Chain 0	Chain 1	Chain 2	Chain 3	Total Power (dBm)				
11a	1	5720	16.17	---	---	---	16.17	0.00	41.400	16.17	30.00
HT20	2	5720	11.38	10.71	---	---	14.07	0.00	25.516	14.07	30.00
HT40	2	5710	10.18	9.46	---	---	12.85	0.00	19.254	12.85	30.00
VHT20	2	5720	11.47	10.73	---	---	14.13	0.00	25.859	14.13	30.00
VHT40	2	5710	10.23	9.47	---	---	12.88	0.00	19.395	12.88	30.00
VHT80	2	5690	5.83	5.45	---	---	8.65	0.21	7.699	8.86	30.00

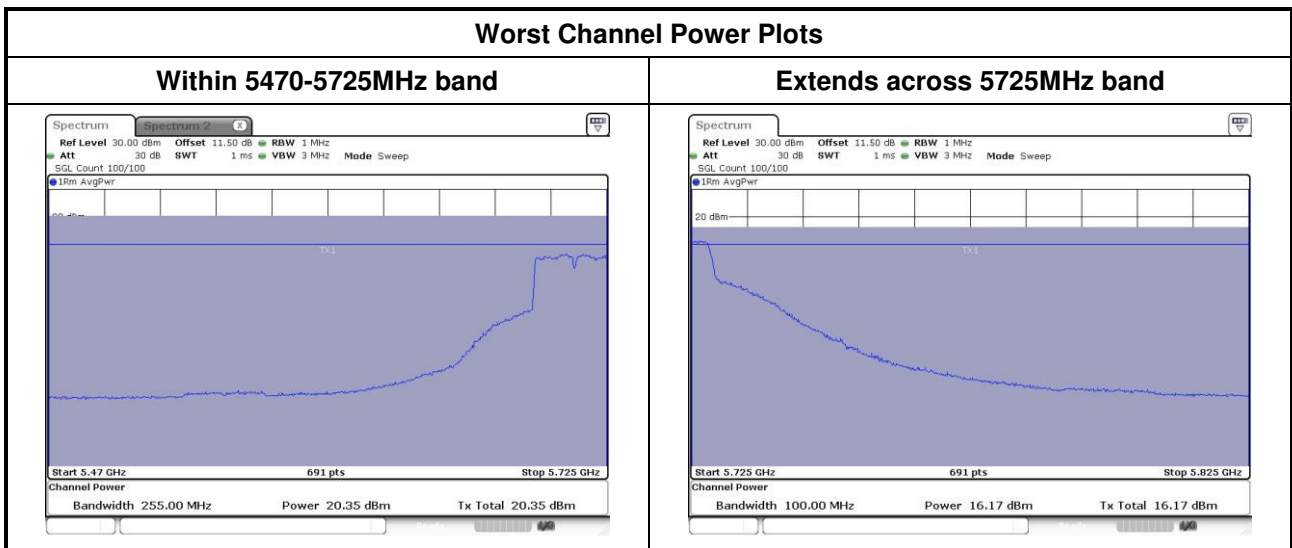

Beamforming mode - Test Configuration 3

Mode	N _{TX}	Freq. (MHz)	Conducted Power (dBm)				Total Power (mW)	Total Power (dBm)	Limit (dBm)
			Chain 0	Chain 1	Chain 2	Chain 3			
HT20	2	5260	17.55	17.51	---	---	113.249	20.54	22.44
HT20	2	5300	18.48	18.41	---	---	139.812	21.46	22.44
HT20	2	5320	18.51	18.44	---	---	140.781	21.49	22.44
HT40	2	5270	19.06	18.78	---	---	156.047	21.93	22.44
HT40	2	5310	15.34	15.09	---	---	66.483	18.23	22.44
VHT20	2	5260	17.61	17.56	---	---	114.693	20.60	22.44
VHT20	2	5300	18.52	18.53	---	---	142.407	21.54	22.44
VHT20	2	5320	18.59	18.55	---	---	143.891	21.58	22.44
VHT40	2	5270	19.16	18.83	---	---	158.797	22.01	22.44
VHT40	2	5310	15.46	15.17	---	---	68.041	18.33	22.44
VHT80	2	5290	12.83	12.56	---	---	37.217	15.71	22.44
HT20	2	5500	17.56	17.55	---	---	113.902	20.57	21.62
HT20	2	5580	17.62	17.44	---	---	113.272	20.54	21.62
HT20	2	5700	16.68	16.49	---	---	91.124	19.60	21.62
HT40	2	5510	14.38	14.06	---	---	52.884	17.23	21.62
HT40	2	5550	18.51	18.25	---	---	137.792	21.39	21.62
HT40	2	5670	18.06	17.88	---	---	125.350	20.98	21.62
VHT20	2	5500	17.72	17.65	---	---	117.366	20.70	21.62
VHT20	2	5580	17.66	17.52	---	---	114.838	20.60	21.62
VHT20	2	5700	16.75	16.59	---	---	92.919	19.68	21.62
VHT40	2	5510	14.43	14.11	---	---	53.496	17.28	21.62
VHT40	2	5550	18.62	18.31	---	---	140.542	21.48	21.62
VHT40	2	5670	18.15	18.01	---	---	128.554	21.09	21.62
VHT80	2	5530	14.21	14.06	---	---	51.832	17.15	21.62

Note:

- For 5250 ~ 5350 MHz band
 Directional gain = $10 * \log((10^{4.17/20} + 10^{4.92/20})^2 / 2) = 7.56 \text{ dBi} > 6 \text{ dBi}$
 Limit shall be reduced to $24 \text{ dBm} - (7.56 \text{ dBi} - 6 \text{ dBi}) = 22.44 \text{ dBm}$
 For 5470 ~ 5725MHz band
 Directional gain = $10 * \log((10^{5.38/20} + 10^{5.36/20})^2 / 2) = 8.38 \text{ dBi} > 6 \text{ dBi}$
 Limit shall be reduced to $24 \text{ dBm} - (8.38 \text{ dBi} - 6 \text{ dBi}) = 21.62 \text{ dBm}$

Channel that extends across the 5.725 GHz boundary

Maximum Conducted Output Power (Within 5470-5725MHz band)											
Mode	N _{TX}	Freq. (MHz)	Conducted Power without duty factor					Duty factor (dB)	Total Power (mW)	Total Power (dBm)	Limit (dBm)
			Chain 0	Chain 1	Chain 2	Chain 3	Total Power (dBm)				
HT20	2	5720	16.42	16.29	---	---	19.37	0.00	86.413	19.37	20.91
HT40	2	5710	18.41	18.08	---	---	21.26	0.00	133.611	21.26	21.62
VHT20	2	5720	16.54	16.34	---	---	19.45	0.00	88.134	19.45	20.91
VHT40	2	5710	18.54	18.08	---	---	21.33	0.00	135.718	21.33	21.62
VHT80	2	5690	18.75	18.35	---	---	21.56	0.00	143.381	21.56	21.62

Maximum Conducted Output Power (Extends across 5725MHz band)											
Mode	N _{TX}	Freq. (MHz)	Conducted Power without duty factor					Duty factor (dB)	Total Power (mW)	Total Power (dBm)	Limit (dBm)
			Chain 0	Chain 1	Chain 2	Chain 3	Total Power (dBm)				
HT20	2	5720	10.76	10.47	---	---	13.63	0.00	23.055	13.63	27.80
HT40	2	5710	7.91	7.62	---	---	10.78	0.00	11.961	10.78	27.80
VHT20	2	5720	10.86	10.52	---	---	13.70	0.00	23.462	13.70	27.80
VHT40	2	5710	8.06	7.75	---	---	10.92	0.00	12.354	10.92	27.80
VHT80	2	5690	5.00	4.49	---	---	7.76	0.00	5.974	7.76	27.80

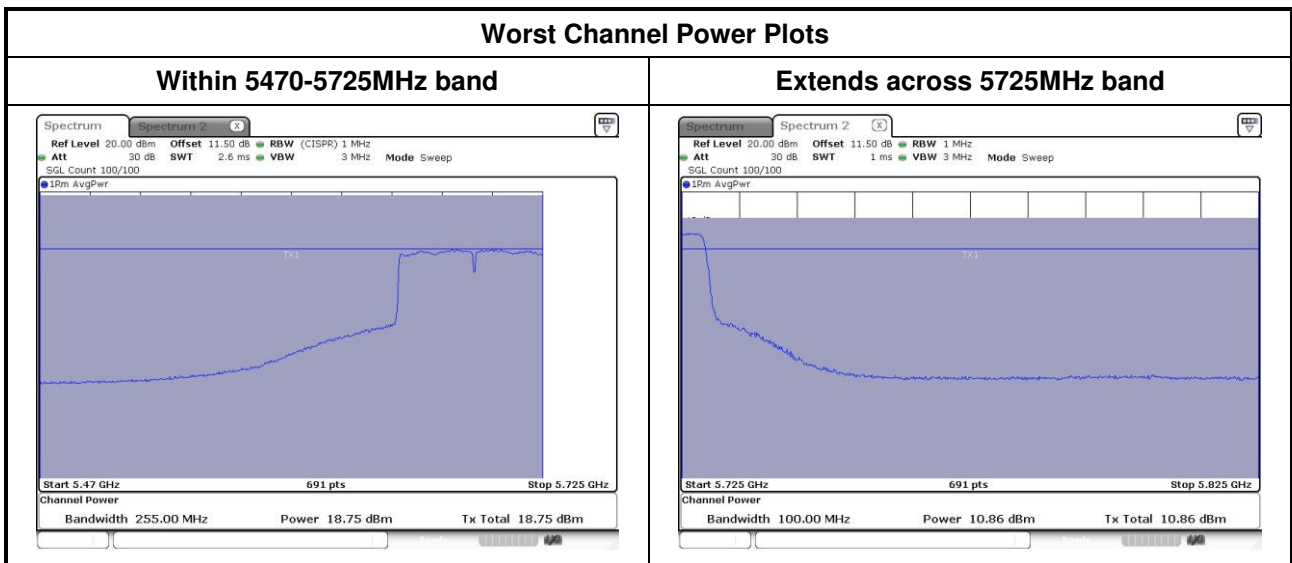

3.4 Peak Power Spectral Density

3.4.1 Limit of Peak Power Spectral Density

Frequency Band (MHz)		Limit
<input checked="" type="checkbox"/>	5250 ~ 5350	11 dBm / MHz
<input checked="" type="checkbox"/>	5470 ~ 5725	11 dBm / MHz

3.4.2 Test Procedures

- Method SA-1 (Non beamforming: 11a / 11ac VHT20 / 11ac VHT40, Beamforming mode)
 1. Set RBW = 1 MHz, VBW = 3 MHz, Sweep time = auto, Detector = RMS.
 2. Trace average 100 traces.
 3. Use the peak marker function to determine the maximum amplitude level.
- Method SA-2 Alternative (Non beamforming: 11ac VHT80)
 1. Set RBW = 1 MHz, VBW = 3 MHz, Detector = RMS.
 2. Set sweep time $\geq 10 * (\text{number of points in sweep}) * (\text{total on/off period of the transmitted signal})$.
 3. Perform a single sweep.
 4. Use the peak marker function to determine the maximum amplitude level.
 5. Add $10 \log(1/x)$, where x is the duty cycle if duty cycle < 98%

3.4.3 Test Setup

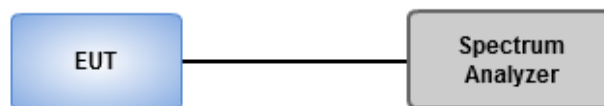

3.4.4 Test Result of Peak Power Spectral Density

Non-beamforming mode - Test Configuration 1

Condition			Peak Power Spectral Density (dBm/MHz)			
Mode	N _{TX}	Freq. (MHz)	PPSD w/o D.F (dBm/MHz)	Duty Factor (dB)	PPSD with D.F (dBm/MHz)	PPSD Limit (dBm/MHz)
11a	1	5260	9.17	0.00	9.17	11
11a	1	5300	9.52	0.00	9.52	11
11a	1	5320	7.38	0.00	7.38	11
VHT20	2	5260	9.22	0.00	9.22	9.44
VHT20	2	5300	9.32	0.00	9.32	9.44
VHT20	2	5320	9.36	0.00	9.36	9.44
VHT40	2	5270	8.07	0.00	8.07	9.44
VHT40	2	5310	2.57	0.00	2.57	9.44
VHT80	2	5290	-3.27	0.21	-3.06	9.44
11a	1	5500	7.22	0.00	7.22	11
11a	1	5580	10.48	0.00	10.48	11
11a	1	5700	6.19	0.00	6.19	11
11a	1	5720	9.16	0.00	9.16	11
VHT20	2	5500	8.46	0.00	8.46	8.62
VHT20	2	5580	8.40	0.00	8.40	8.62
VHT20	2	5700	6.68	0.00	6.68	8.62
VHT20	2	5720	8.38	0.00	8.38	8.62
VHT40	2	5510	1.42	0.00	1.42	8.62
VHT40	2	5550	7.67	0.00	7.67	8.62
VHT40	2	5670	6.04	0.00	6.04	8.62
VHT40	2	5710	8.09	0.00	8.09	8.62
VHT80	2	5530	-2.29	0.21	-2.08	8.62
VHT80	2	5690	3.81	0.21	4.02	8.62

Note:

1. D.F is duty factor.
2. Test results of VHT20/VHT40/VHT80 are bin-by-bin summing measured value of each TX port.
3. For 5250 ~ 5350 MHz band
 2TX mode, Directional gain = $10 * \log((10^{4.17/20} + 10^{4.92/20})^2 / 2) = 7.56 \text{ dBi} > 6 \text{ dBi}$
 Limit shall be reduced to $11 \text{ dBm} - (7.56 \text{ dBi} - 6 \text{ dBi}) = 9.44 \text{ dBm}$.
 For 5470 ~ 5725MHz band
 2TX mode, Directional gain = $10 * \log((10^{5.38/20} + 10^{5.36/20})^2 / 2) = 8.38 \text{ dBi} > 6 \text{ dBi}$
 Limit shall be reduced to $11 \text{ dBm} - (8.38 \text{ dBi} - 6 \text{ dBi}) = 8.62 \text{ dBm}$.

Worst Plots

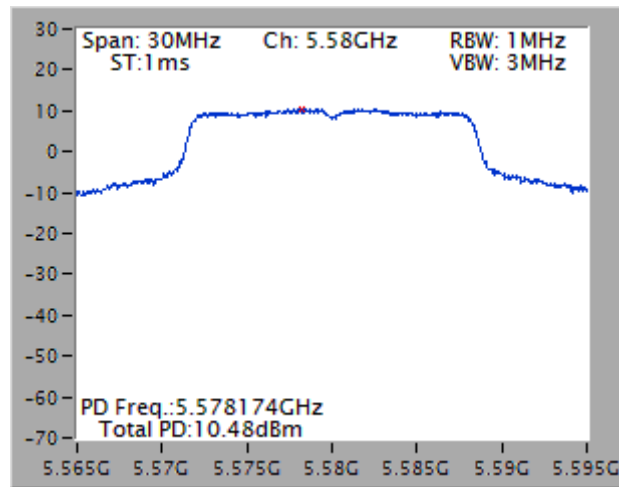

Beamforming mode - Test Configuration 3

Condition			Peak Power Spectral Density (dBm/MHz)			
Mode	N _{TX}	Freq. (MHz)	PPSD w/o D.F (dBm/MHz)	Duty Factor (dB)	PPSD with D.F (dBm/MHz)	PPSD Limit (dBm/MHz)
VHT20	2	5260	7.77	0.00	7.77	9.44
VHT20	2	5300	8.85	0.00	8.85	9.44
VHT20	2	5320	8.23	0.00	8.23	9.44
VHT40	2	5270	5.51	0.00	5.51	9.44
VHT40	2	5310	2.41	0.00	2.41	9.44
VHT80	2	5290	-3.05	0.00	-3.05	9.44
VHT20	2	5500	7.08	0.00	7.08	8.62
VHT20	2	5580	7.54	0.00	7.54	8.62
VHT20	2	5700	6.15	0.00	6.15	8.62
VHT20	2	5720	7.76	0.00	7.76	8.62
VHT40	2	5510	1.10	0.00	1.10	8.62
VHT40	2	5550	5.16	0.00	5.16	8.62
VHT40	2	5670	5.05	0.00	5.05	8.62
VHT40	2	5710	5.96	0.00	5.96	8.62
VHT80	2	5530	-2.49	0.00	-2.49	8.62
VHT80	2	5690	3.16	0.00	3.16	8.62

Note:

- D.F is duty factor.
- Test results are bin-by-bin summing measured value of each TX port.
- For 5250 ~ 5350 MHz band
 $\text{Directional gain} = 10 * \log((10^{4.17/20} + 10^{4.92/20})^2 / 2) = 7.56 \text{ dBi} > 6 \text{ dBi}$
 Limit shall be reduced to $11 \text{ dBm} - (7.56 \text{ dBi} - 6 \text{ dBi}) = 9.44 \text{ dBm}$.
 For 5470 ~ 5725MHz band
 $\text{Directional gain} = 10 * \log((10^{5.38/20} + 10^{5.36/20})^2 / 2) = 8.38 \text{ dBi} > 6 \text{ dBi}$
 Limit shall be reduced to $11 \text{ dBm} - (8.38 \text{ dBi} - 6 \text{ dBi}) = 8.62 \text{ dBm}$.

Worst Plots

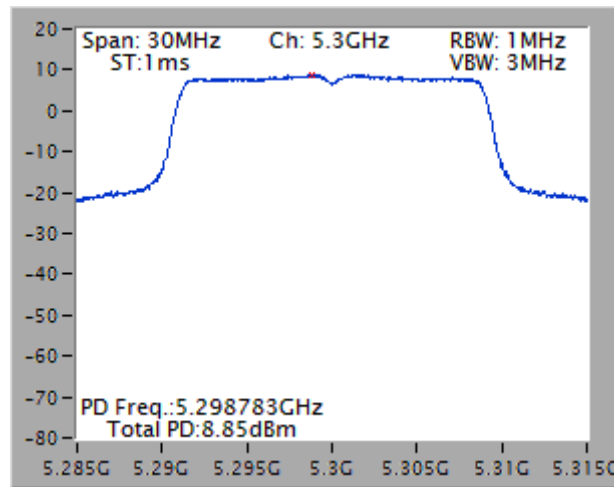

3.5 Transmitter Radiated and Band Edge Emissions

3.5.1 Limit of Transmitter Radiated and Band Edge Emissions

Restricted Band Emissions Limit			
Frequency Range (MHz)	Field Strength (uV/m)	Field Strength (dBuV/m)	Measure Distance (m)
0.009~0.490	2400/F(kHz)	48.5 - 13.8	300
0.490~1.705	24000/F(kHz)	33.8 - 23	30
1.705~30.0	30	29	30
30~88	100	40	3
88~216	150	43.5	3
216~960	200	46	3
Above 960	500	54	3

Note 1:
Qusai-Peak value is measured for frequency below 1GHz except for 9–90 kHz, 110–490 kHz frequency band. Peak and average value are measured for frequency above 1GHz. The limit on average radio frequency emission is as above table. The limit on peak radio frequency emissions is 20 dB above the maximum permitted average emission limit

Note 2:
Measurements may be performed at a distance other than what is specified provided. When performing measurements at a distance other than that specified, the results shall be extrapolated to the specified distance using an extrapolation factor as below, Frequency at or above 30 MHz: 20 dB/decade Frequency below 30 MHz: 40 dB/decade.

Un-restricted band emissions above 1GHz Limit	
Operating Band	Limit
5.15 - 5.25 GHz	e.i.r.p. -27 dBm [68.2 dBuV/m@3m]
5.25 - 5.35 GHz	e.i.r.p. -27 dBm [68.2 dBuV/m@3m]
5.47 - 5.725 GHz	e.i.r.p. -27 dBm [68.2 dBuV/m@3m]
5.725 - 5.850 GHz	5.715 5.725 GHz: e.i.r.p. -17 dBm [78.2 dBuV/m@3m] 5.85 5.86 GHz: e.i.r.p. -17 dBm [78.2 dBuV/m@3m] Other un-restricted band: e.i.r.p. -27 dBm [68.2 dBuV/m@3m]

Note 1: Measurements may be performed at a distance other than the limit distance provided they are not performed in the near field and the emissions to be measured can be detected by the measurement equipment. When performing measurements at a distance other than that specified, the results shall be extrapolated to the specified distance using an extrapolation factor of 20 dB/decade (inverse of linear distance for field-strength measurements, inverse of linear distance-squared for power-density measurements).

3.5.2 Test Procedures

1. Measurement is made at a semi-anechoic chamber that incorporates a turntable allowing a EUT rotation of 360°. A continuously-rotating, remotely-controlled turntable is installed at the test site to support the EUT and facilitate determination of the direction of maximum radiation for each EUT emission frequency. The EUT is placed at test table. For emissions testing at or below 1 GHz, the table height is 80 cm above the reference ground plane. For emission measurements above 1 GHz, the table height is 1.5 m
2. Measurement is made with the antenna positioned in both the horizontal and vertical planes of polarization. The measurement antenna is varied in height (1 m ~ 4m) above the reference ground plane to obtain the maximum signal strength. Distance between EUT and antenna is 3 m.
3. This investigation is performed with the EUT rotated 360°, the antenna height scanned between 1 m and 4 m, and the antenna rotated to repeat the measurements for both the horizontal and vertical antenna polarizations.

Note:

1. 120kHz measurement bandwidth of test receiver and Quasi-peak detector is for radiated emission below 1GHz.
2. RBW=1MHz, VBW=3MHz and Peak detector is for peak measured value of radiated emission above 1GHz.
3. RBW=1MHz, VBW=1/T and Peak detector is for average measured value of radiated emission above 1GHz.

3.5.3 Test Setup

Radiated Emissions below 1 GHz

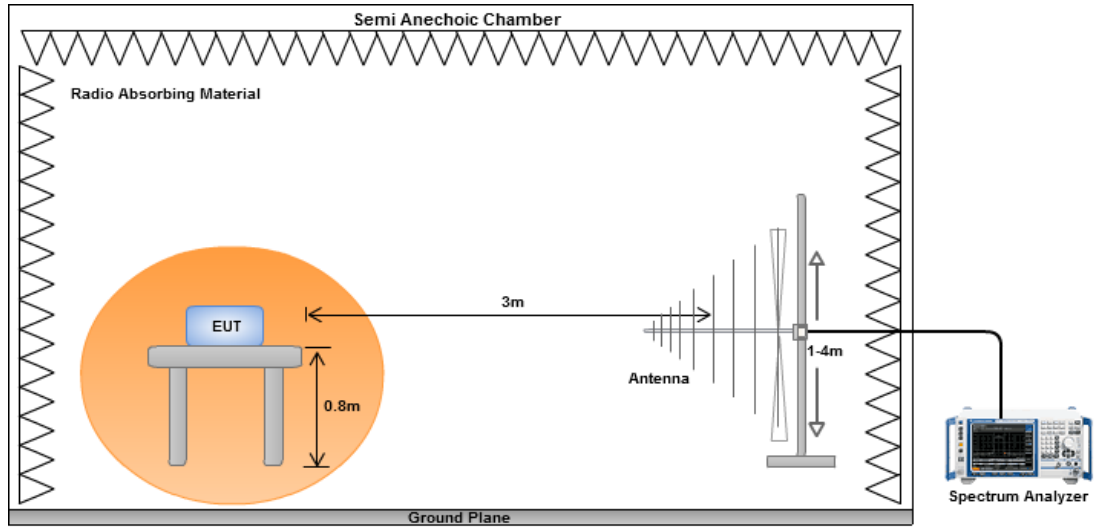

Radiated Emissions above 1 GHz

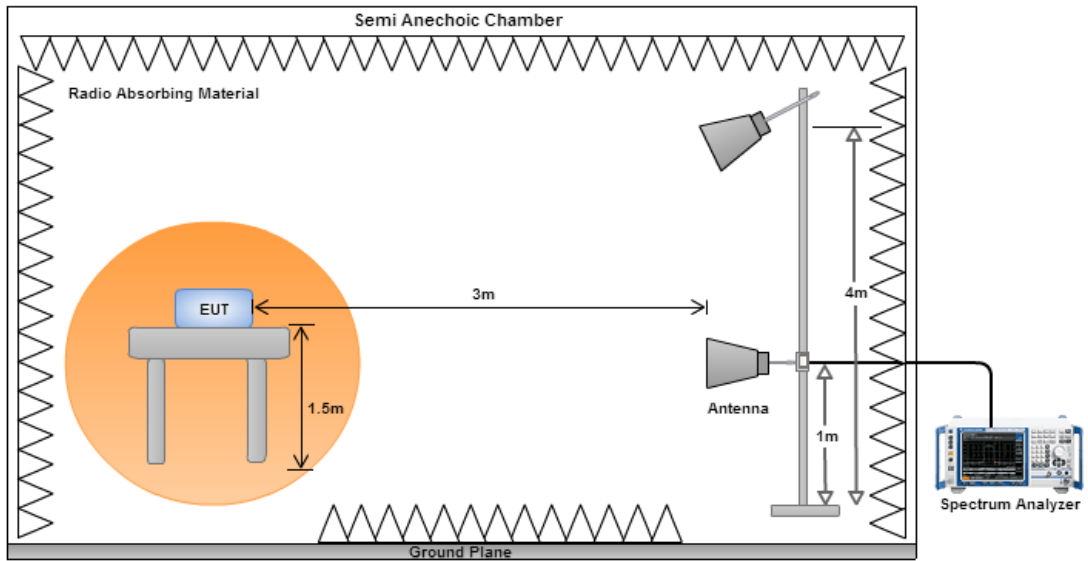

Non- beamforming mode

3.5.4 Transmitter Radiated Unwanted Emissions (Below 1GHz)

Modulation	VHT40	Test Freq. (MHz)	5550
Polarization	Horizontal	Test Configuration	1

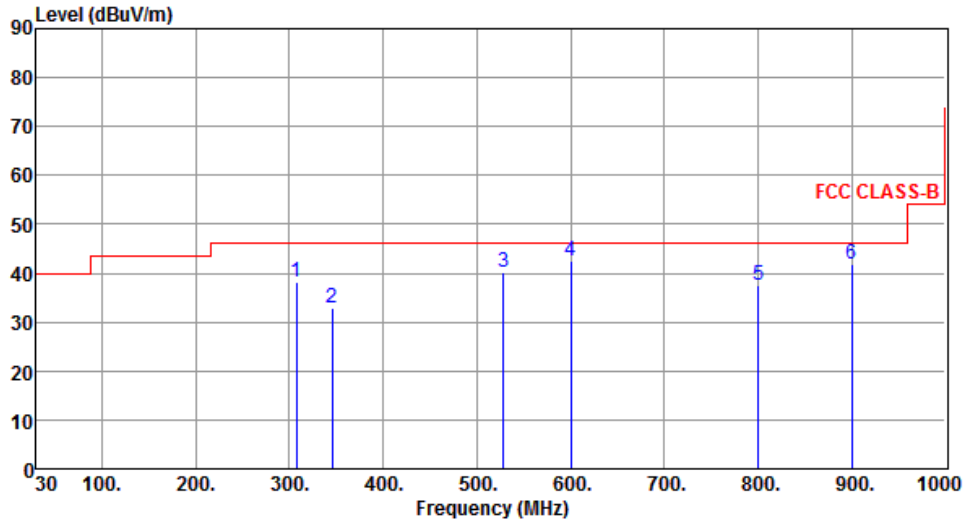

	Freq. MHz	Emission level dBuV/m	Limit dBuV/m	Margin dB	SA reading dBuV	Factor dB	Remark	ANT High cm	Turn Table deg
1	307.53	38.16	46.00	-7.84	50.61	-12.45	Peak	---	---
2	345.68	32.97	46.00	-13.03	44.53	-11.56	Peak	---	---
3	528.41	40.17	46.00	-5.83	47.49	-7.32	Peak	---	---
4	600.53	42.53	46.00	-3.47	48.24	-5.71	Peak	---	---
5	800.06	37.66	46.00	-8.34	40.22	-2.56	Peak	---	---
6	900.13	41.94	46.00	-4.06	42.61	-0.67	Peak	---	---

Note 1: Emission Level (dBuV/m) = SA Reading (dBuV/m) + Factor* (dB)

*Factor includes antenna factor , cable loss and amplifier gain

Note 2: Margin (dB) = Emission level (dBuV/m) – Limit (dBuV/m).

Note 3: All spurious emissions below 30MHz are more than 20 dB below the limit.

Modulation	VHT40	Test Freq. (MHz)	5550
Polarization	Vertical	Test Configuration	1

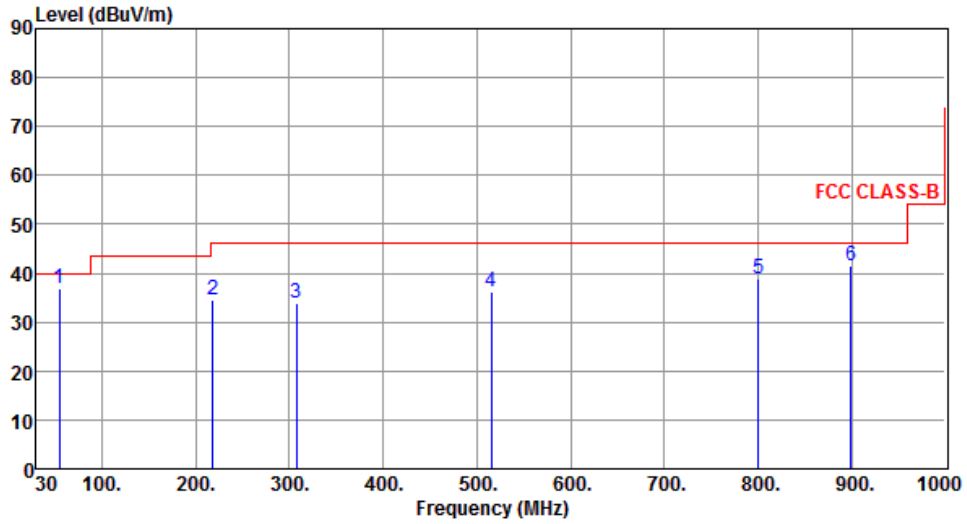

	Freq. MHz	Emission level dBuV/m	Limit dBuV/m	Margin dB	SA reading dBuV	Factor dB	Remark	ANT High cm	Turn Table deg
1	54.33	36.75	40.00	-3.25	50.28	-13.53	QP	---	---
2	218.52	34.44	46.00	-11.56	50.48	-16.04	Peak	---	---
3	307.41	33.97	46.00	-12.03	46.43	-12.46	Peak	---	---
4	515.42	36.22	46.00	-9.78	43.68	-7.46	Peak	---	---
5	800.18	38.87	46.00	-7.13	41.43	-2.56	Peak	---	---
6	899.35	41.53	46.00	-4.47	42.21	-0.68	Peak	---	---

Note 1: Emission Level (dBuV/m) = SA Reading (dBuV/m) + Factor* (dB)

*Factor includes antenna factor , cable loss and amplifier gain

Note 2: Margin (dB) = Emission level (dBuV/m) – Limit (dBuV/m).

Note 3: All spurious emissions below 30MHz are more than 20 dB below the limit.

Modulation	VHT40	Test Freq. (MHz)	5550
Polarization	Horizontal	Test Configuration	2

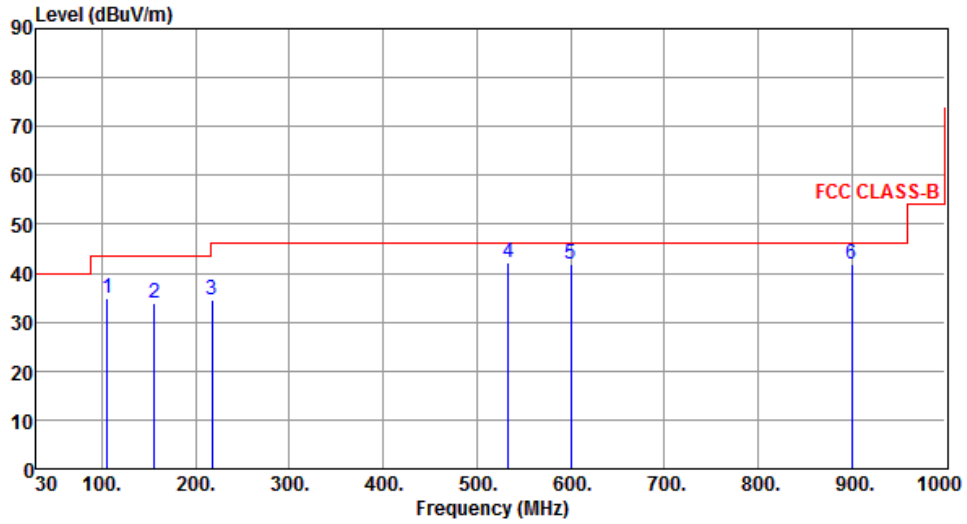

	Freq. MHz	Emission level dBuV/m	Limit dBuV/m	Margin dB	SA reading dBuV	Factor dB	Remark	ANT High cm	Turn Table deg
1	105.43	35.00	43.50	-8.50	52.44	-17.44	Peak	---	---
2	155.83	33.94	43.50	-9.56	47.48	-13.54	Peak	---	---
3	217.52	34.57	46.00	-11.43	50.66	-16.09	Peak	---	---
4	533.42	42.06	46.00	-3.94	49.32	-7.26	Peak	---	---
5	600.52	41.80	46.00	-4.20	47.51	-5.71	Peak	---	---
6	900.18	41.77	46.00	-4.23	42.44	-0.67	Peak	---	---

Note 1: Emission Level (dBuV/m) = SA Reading (dBuV/m) + Factor* (dB)

*Factor includes antenna factor , cable loss and amplifier gain

Note 2: Margin (dB) = Emission level (dBuV/m) – Limit (dBuV/m).

Note 3: All spurious emissions below 30MHz are more than 20 dB below the limit.

Modulation	VHT40	Test Freq. (MHz)	5550
Polarization	Vertical	Test Configuration	2

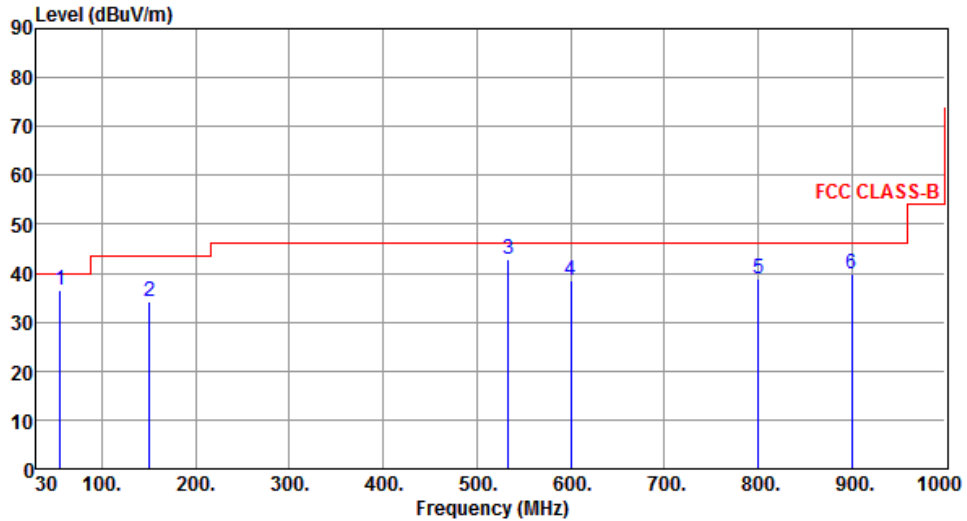

	Freq. MHz	Emission level dBuV/m	Limit dBuV/m	Margin dB	SA reading dBuV	Factor dB	Remark	ANT High cm	Turn Table deg
1	55.41	36.68	40.00	-3.32	50.35	-13.67	QP	---	---
2	150.42	34.08	43.50	-9.42	47.51	-13.43	Peak	---	---
3	533.28	42.90	46.00	-3.10	50.16	-7.26	QP	---	---
4	600.24	38.63	46.00	-7.37	44.35	-5.72	Peak	---	---
5	800.18	38.86	46.00	-7.14	41.42	-2.56	Peak	---	---
6	900.13	39.81	46.00	-6.19	40.48	-0.67	Peak	---	---

Note 1: Emission Level (dBuV/m) = SA Reading (dBuV/m) + Factor* (dB)

*Factor includes antenna factor , cable loss and amplifier gain

Note 2: Margin (dB) = Emission level (dBuV/m) – Limit (dBuV/m).

Note 3: All spurious emissions below 30MHz are more than 20 dB below the limit.

3.5.5 Transmitter Radiated Unwanted Emissions (Above 1GHz) for 11a

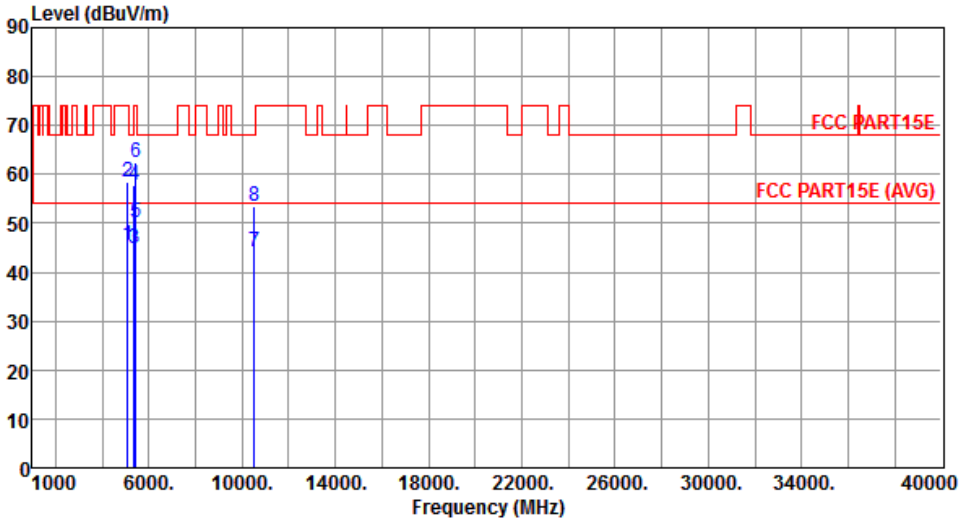
Modulation	11a	Test Freq. (MHz)	5260																																																																																																			
Polarization	Horizontal	Test Configuration	1																																																																																																			
																																																																																																						
	<table border="1"> <thead> <tr> <th>Freq.</th> <th>Emission level</th> <th>Limit</th> <th>Margin</th> <th>SA reading</th> <th>Factor</th> <th>Remark</th> <th>ANT High</th> <th>Turn Table</th> </tr> <tr> <th>MHz</th> <th>dBuV/m</th> <th>dBuV/m</th> <th>dB</th> <th>dBuV</th> <th>dB</th> <th></th> <th>cm</th> <th>deg</th> </tr> </thead> <tbody> <tr> <td>1</td> <td>5100.00</td> <td>45.43</td> <td>54.00</td> <td>-8.57</td> <td>39.32</td> <td>6.11</td> <td>Average</td> <td>284</td> <td>97</td> </tr> <tr> <td>2</td> <td>5100.00</td> <td>58.50</td> <td>74.00</td> <td>-15.50</td> <td>52.39</td> <td>6.11</td> <td>Peak</td> <td>284</td> <td>97</td> </tr> <tr> <td>3</td> <td>5350.00</td> <td>44.80</td> <td>54.00</td> <td>-9.20</td> <td>38.29</td> <td>6.51</td> <td>Average</td> <td>284</td> <td>97</td> </tr> <tr> <td>4</td> <td>5350.00</td> <td>57.65</td> <td>74.00</td> <td>-16.35</td> <td>51.14</td> <td>6.51</td> <td>Peak</td> <td>284</td> <td>97</td> </tr> <tr> <td>5</td> <td>5420.00</td> <td>50.03</td> <td>54.00</td> <td>-3.97</td> <td>43.43</td> <td>6.60</td> <td>Average</td> <td>284</td> <td>97</td> </tr> <tr> <td>6</td> <td>5420.00</td> <td>62.27</td> <td>74.00</td> <td>-11.73</td> <td>55.67</td> <td>6.60</td> <td>Peak</td> <td>284</td> <td>97</td> </tr> <tr> <td>7</td> <td>10520.00</td> <td>44.01</td> <td>54.00</td> <td>-9.99</td> <td>27.52</td> <td>16.49</td> <td>Average</td> <td>277</td> <td>157</td> </tr> <tr> <td>8</td> <td>10520.00</td> <td>53.45</td> <td>68.20</td> <td>-14.75</td> <td>36.96</td> <td>16.49</td> <td>Peak</td> <td>277</td> <td>157</td> </tr> </tbody> </table>	Freq.	Emission level	Limit	Margin	SA reading	Factor	Remark	ANT High	Turn Table	MHz	dBuV/m	dBuV/m	dB	dBuV	dB		cm	deg	1	5100.00	45.43	54.00	-8.57	39.32	6.11	Average	284	97	2	5100.00	58.50	74.00	-15.50	52.39	6.11	Peak	284	97	3	5350.00	44.80	54.00	-9.20	38.29	6.51	Average	284	97	4	5350.00	57.65	74.00	-16.35	51.14	6.51	Peak	284	97	5	5420.00	50.03	54.00	-3.97	43.43	6.60	Average	284	97	6	5420.00	62.27	74.00	-11.73	55.67	6.60	Peak	284	97	7	10520.00	44.01	54.00	-9.99	27.52	16.49	Average	277	157	8	10520.00	53.45	68.20	-14.75	36.96	16.49	Peak	277	157			
Freq.	Emission level	Limit	Margin	SA reading	Factor	Remark	ANT High	Turn Table																																																																																														
MHz	dBuV/m	dBuV/m	dB	dBuV	dB		cm	deg																																																																																														
1	5100.00	45.43	54.00	-8.57	39.32	6.11	Average	284	97																																																																																													
2	5100.00	58.50	74.00	-15.50	52.39	6.11	Peak	284	97																																																																																													
3	5350.00	44.80	54.00	-9.20	38.29	6.51	Average	284	97																																																																																													
4	5350.00	57.65	74.00	-16.35	51.14	6.51	Peak	284	97																																																																																													
5	5420.00	50.03	54.00	-3.97	43.43	6.60	Average	284	97																																																																																													
6	5420.00	62.27	74.00	-11.73	55.67	6.60	Peak	284	97																																																																																													
7	10520.00	44.01	54.00	-9.99	27.52	16.49	Average	277	157																																																																																													
8	10520.00	53.45	68.20	-14.75	36.96	16.49	Peak	277	157																																																																																													
<p>Note 1: Emission Level (dBuV/m) = SA Reading (dBuV/m) + Factor* (dB) *Factor includes antenna factor , cable loss and amplifier gain Note 2: Margin (dB) = Emission level (dBuV/m) – Limit (dBuV/m).</p>																																																																																																						

Modulation	11a	Test Freq. (MHz)	5260
Polarization	Vertical	Test Configuration	1

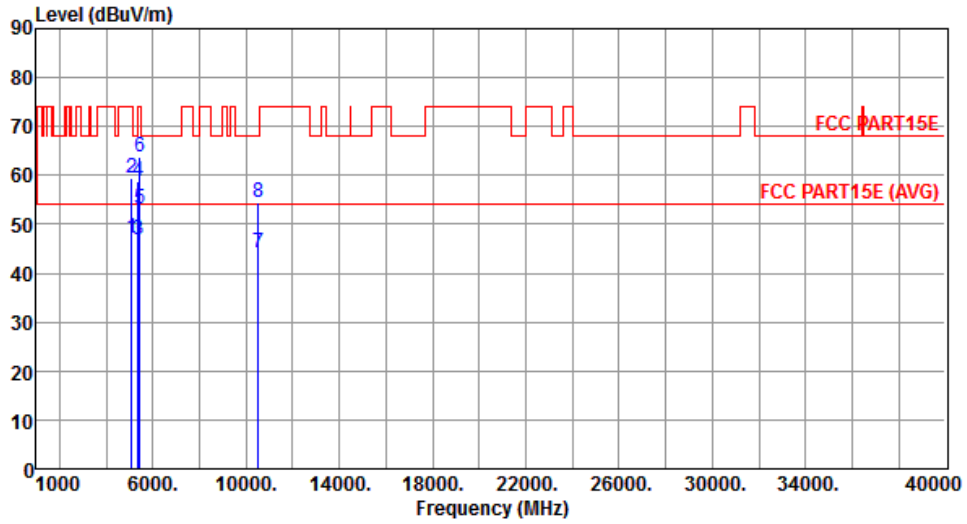

	Freq. MHz	Emission level dBuV/m	Limit dBuV/m	Margin dB	SA reading dBuV	Factor dB	Remark	ANT High cm	Turn Table deg
1	5100.00	47.09	54.00	-6.91	40.98	6.11	Average	250	284
2	5100.00	59.37	74.00	-14.63	53.26	6.11	Peak	250	284
3	5350.00	46.77	54.00	-7.23	40.26	6.51	Average	250	284
4	5350.00	58.77	74.00	-15.23	52.26	6.51	Peak	250	284
5	5420.00	52.99	54.00	-1.01	46.39	6.60	Average	250	284
6	5420.00	63.92	74.00	-10.08	57.32	6.60	Peak	250	284
7	10520.00	44.12	54.00	-9.88	27.63	16.49	Average	267	251
8	10520.00	54.44	68.20	-13.76	37.95	16.49	Peak	267	251

Note 1: Emission Level (dBuV/m) = SA Reading (dBuV/m) + Factor* (dB)

*Factor includes antenna factor , cable loss and amplifier gain

Note 2: Margin (dB) = Emission level (dBuV/m) – Limit (dBuV/m).

Modulation	11a	Test Freq. (MHz)	5300
Polarization	Horizontal	Test Configuration	1

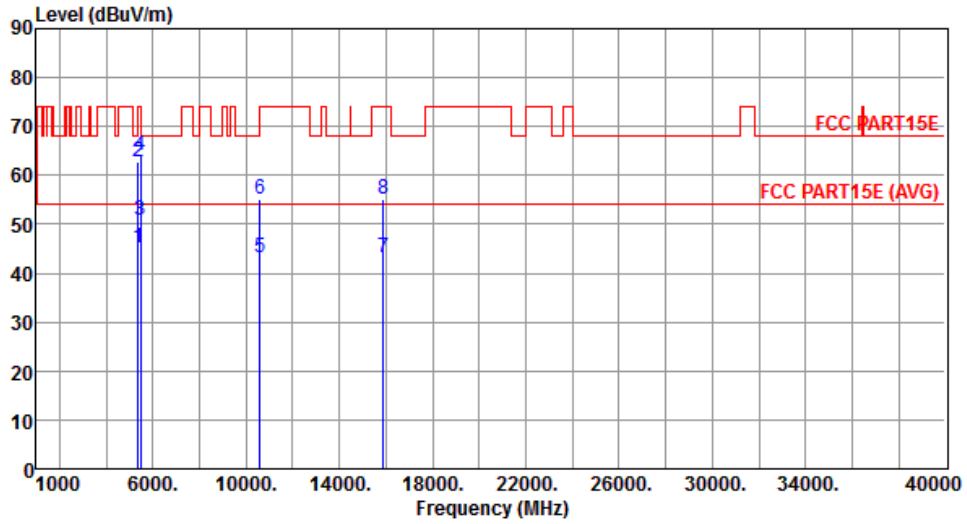

	Freq. MHz	Emission level dBuV/m	Limit dBuV/m	Margin dB	SA reading dBuV	Factor dB	Remark	ANT High cm	Turn Table deg
1	5350.00	45.31	54.00	-8.69	38.80	6.51	Average	314	237
2	5350.00	62.74	74.00	-11.26	56.23	6.51	Peak	314	237
3	5460.00	50.84	54.00	-3.16	44.20	6.64	Average	308	228
4	5460.00	63.94	74.00	-10.06	57.30	6.64	Peak	308	228
5	10600.00	43.13	54.00	-10.87	26.62	16.51	Average	265	157
6	10600.00	55.08	74.00	-18.92	38.57	16.51	Peak	265	157
7	15900.00	43.31	54.00	-10.69	26.60	16.71	Average	290	157
8	15900.00	55.06	74.00	-18.94	38.35	16.71	Peak	290	157

Note 1: Emission Level (dBuV/m) = SA Reading (dBuV/m) + Factor* (dB)

*Factor includes antenna factor , cable loss and amplifier gain

Note 2: Margin (dB) = Emission level (dBuV/m) – Limit (dBuV/m).

Modulation	11a	Test Freq. (MHz)	5300
Polarization	Vertical	Test Configuration	1

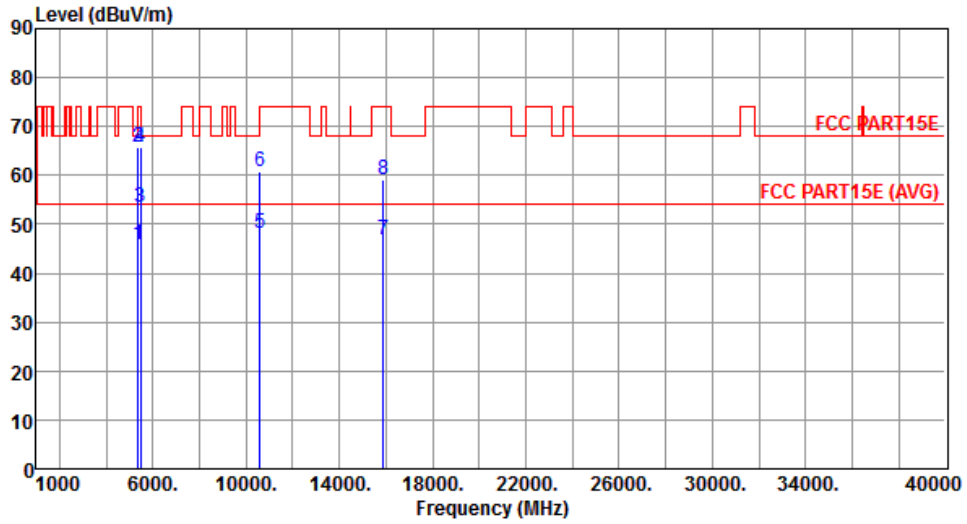

	Freq. MHz	Emission level dBuV/m	Limit dBuV/m	Margin dB	SA reading dBuV	Factor dB	Remark	ANT High cm	Turn Table deg
1	5350.00	45.89	54.00	-8.11	39.38	6.51	Average	231	277
2	5350.00	65.63	74.00	-8.37	59.12	6.51	Peak	231	277
3	5460.00	53.47	54.00	-0.53	46.83	6.64	Average	231	247
4	5460.00	65.79	74.00	-8.21	59.15	6.64	Peak	231	247
5	10600.00	48.00	54.00	-6.00	31.49	16.51	Average	208	281
6	10600.00	60.79	74.00	-13.21	44.28	16.51	Peak	208	281
7	15900.00	46.96	54.00	-7.04	30.25	16.71	Average	290	202
8	15900.00	59.28	74.00	-14.72	42.57	16.71	Peak	290	202

Note 1: Emission Level (dBuV/m) = SA Reading (dBuV/m) + Factor* (dB)

*Factor includes antenna factor , cable loss and amplifier gain

Note 2: Margin (dB) = Emission level (dBuV/m) – Limit (dBuV/m).

Modulation	11a	Test Freq. (MHz)	5320
Polarization	Horizontal	Test Configuration	1

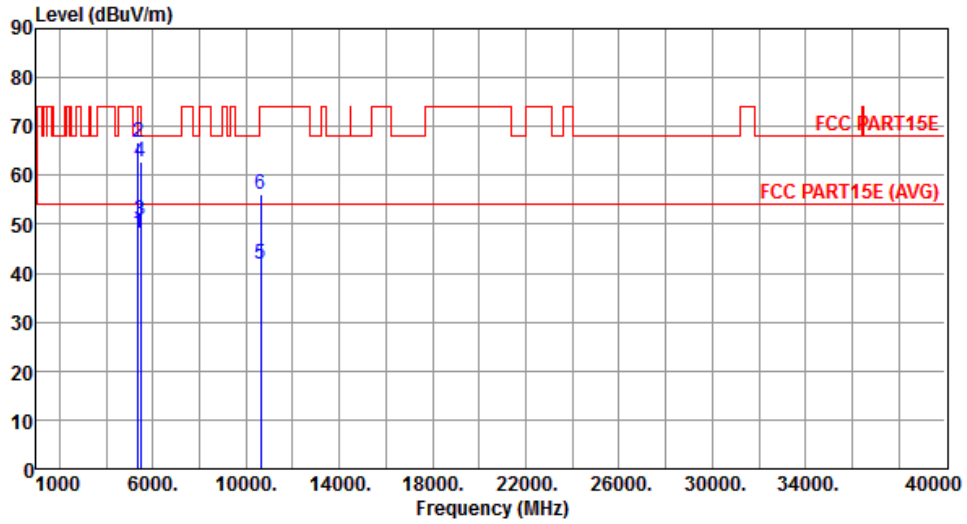

	Freq. MHz	Emission level dBuV/m	Limit dBuV/m	Margin dB	SA reading dBuV	Factor dB	Remark	ANT High cm	Turn Table deg
1	5350.00	48.29	54.00	-5.71	41.78	6.51	Average	265	78
2	5350.00	66.63	74.00	-7.37	60.12	6.51	Peak	265	78
3	5480.00	50.87	54.00	-3.13	44.22	6.65	Average	373	26
4	5480.00	62.69	68.20	-5.51	56.04	6.65	Peak	373	26
5	10640.00	41.80	54.00	-12.20	25.27	16.53	Average	265	78
6	10640.00	56.25	74.00	-17.75	39.72	16.53	Peak	265	78

Note 1: Emission Level (dBuV/m) = SA Reading (dBuV/m) + Factor* (dB)

*Factor includes antenna factor , cable loss and amplifier gain

Note 2: Margin (dB) = Emission level (dBuV/m) – Limit (dBuV/m).

Modulation	11a	Test Freq. (MHz)	5320
Polarization	Vertical	Test Configuration	1

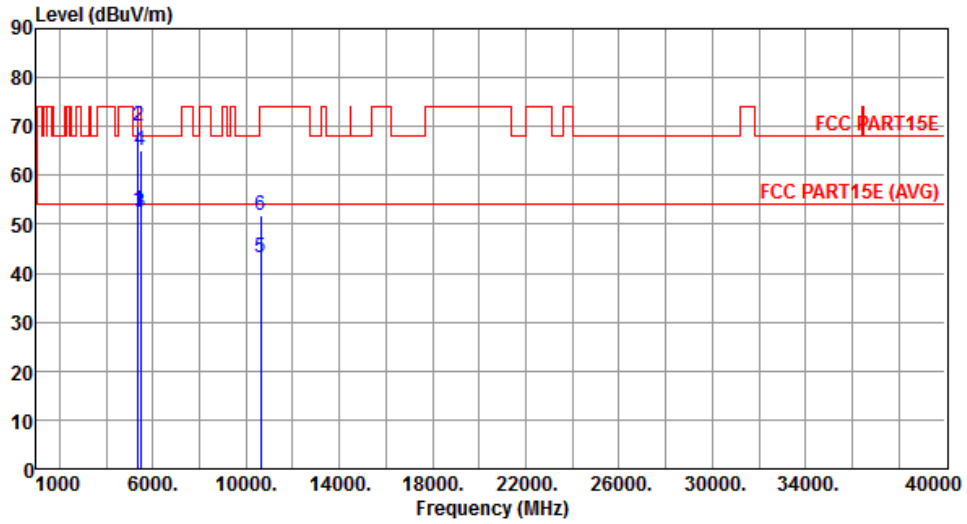

	Freq. MHz	Emission level dBuV/m	Limit dBuV/m	Margin dB	SA reading dBuV	Factor dB	Remark	ANT High cm	Turn Table deg
1	5350.00	52.91	54.00	-1.09	46.40	6.51	Average	241	283
2	5350.00	70.17	74.00	-3.83	63.66	6.51	Peak	241	283
3	5480.00	52.59	54.00	-1.41	45.94	6.65	Average	283	318
4	5480.00	65.08	68.20	-3.12	58.43	6.65	Peak	283	318
5	10640.00	43.16	54.00	-10.84	26.63	16.53	Average	331	35
6	10640.00	51.79	74.00	-22.21	35.26	16.53	Peak	331	35

Note 1: Emission Level (dBuV/m) = SA Reading (dBuV/m) + Factor* (dB)

*Factor includes antenna factor , cable loss and amplifier gain

Note 2: Margin (dB) = Emission level (dBuV/m) – Limit (dBuV/m).

Modulation	11a	Test Freq. (MHz)	5500
Polarization	Horizontal	Test Configuration	1

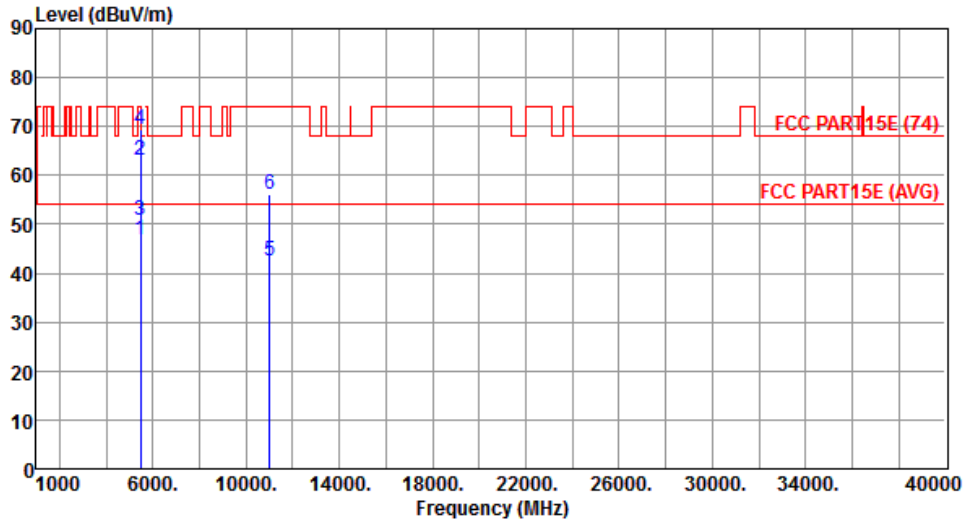

	Freq. MHz	Emission level dBuV/m	Limit dBuV/m	Margin dB	SA reading dBuV	Factor dB	Remark	ANT High cm	Turn Table deg
1	5460.00	46.84	54.00	-7.16	40.20	6.64	Average	334	29
2	5460.00	63.11	74.00	-10.89	56.47	6.64	Peak	334	29
3	5470.00	50.94	54.00	-3.06	44.29	6.65	Average	334	29
4	5470.00	69.51	74.00	-4.49	62.86	6.65	Peak	334	29
5	11000.00	42.51	54.00	-11.49	25.89	16.62	Average	315	267
6	11000.00	56.06	74.00	-17.94	39.44	16.62	Peak	315	267

Note 1: Emission Level (dBuV/m) = SA Reading (dBuV/m) + Factor* (dB)

*Factor includes antenna factor , cable loss and amplifier gain

Note 2: Margin (dB) = Emission level (dBuV/m) – Limit (dBuV/m).

Modulation	11a	Test Freq. (MHz)	5500
Polarization	Vertical	Test Configuration	1

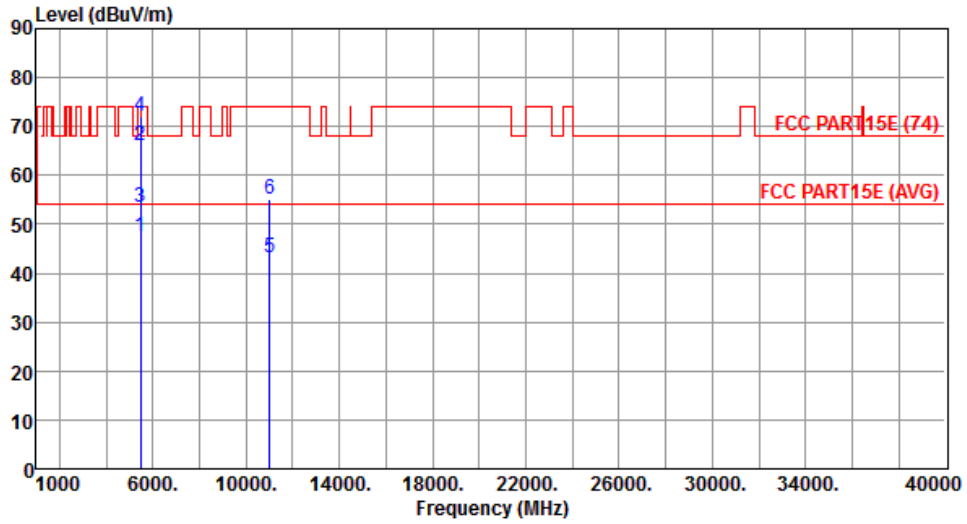

	Freq. MHz	Emission level dBuV/m	Limit dBuV/m	Margin dB	SA reading dBuV	Factor dB	Remark	ANT High cm	Turn Table deg
1	5460.00	47.42	54.00	-6.58	40.78	6.64	Average	248	252
2	5460.00	66.05	74.00	-7.95	59.41	6.64	Peak	248	252
3	5470.00	53.39	54.00	-0.61	46.74	6.65	Average	248	252
4	5470.00	72.20	74.00	-1.80	65.55	6.65	Peak	248	252
5	11000.00	43.12	54.00	-10.88	26.50	16.62	Average	267	221
6	11000.00	55.18	74.00	-18.82	38.56	16.62	Peak	267	221

Note 1: Emission Level (dBuV/m) = SA Reading (dBuV/m) + Factor* (dB)

*Factor includes antenna factor , cable loss and amplifier gain

Note 2: Margin (dB) = Emission level (dBuV/m) – Limit (dBuV/m).

Modulation	11a	Test Freq. (MHz)	5580
Polarization	Horizontal	Test Configuration	1

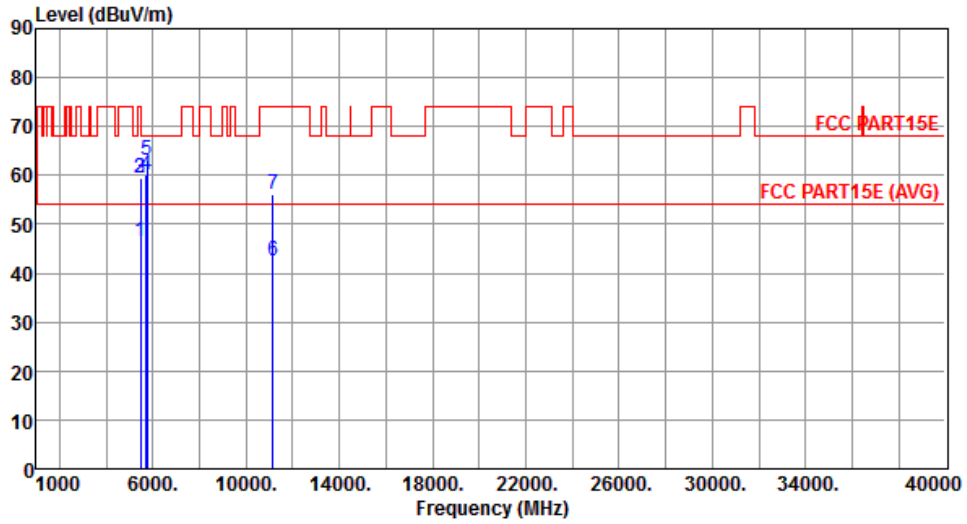

	Freq. MHz	Emission level dBuV/m	Limit dBuV/m	Margin dB	SA reading dBuV	Factor dB	Remark	ANT High cm	Turn Table deg
1	5460.00	46.40	54.00	-7.60	39.76	6.64	Average	326	26
2	5460.00	59.31	74.00	-14.69	52.67	6.64	Peak	326	26
3	5470.00	59.47	68.20	-8.73	52.82	6.65	Peak	326	26
4	5725.00	59.98	68.20	-8.22	52.85	7.13	Peak	385	147
5	5740.00	63.04	68.20	-5.16	55.88	7.16	Peak	326	26
6	11160.00	42.66	54.00	-11.34	25.97	16.69	Average	385	147
7	11160.00	56.01	74.00	-17.99	39.32	16.69	Peak	385	147

Note 1: Emission Level (dBuV/m) = SA Reading (dBuV/m) + Factor* (dB)

*Factor includes antenna factor , cable loss and amplifier gain

Note 2: Margin (dB) = Emission level (dBuV/m) – Limit (dBuV/m).

Modulation	11a	Test Freq. (MHz)	5580
Polarization	Vertical	Test Configuration	1

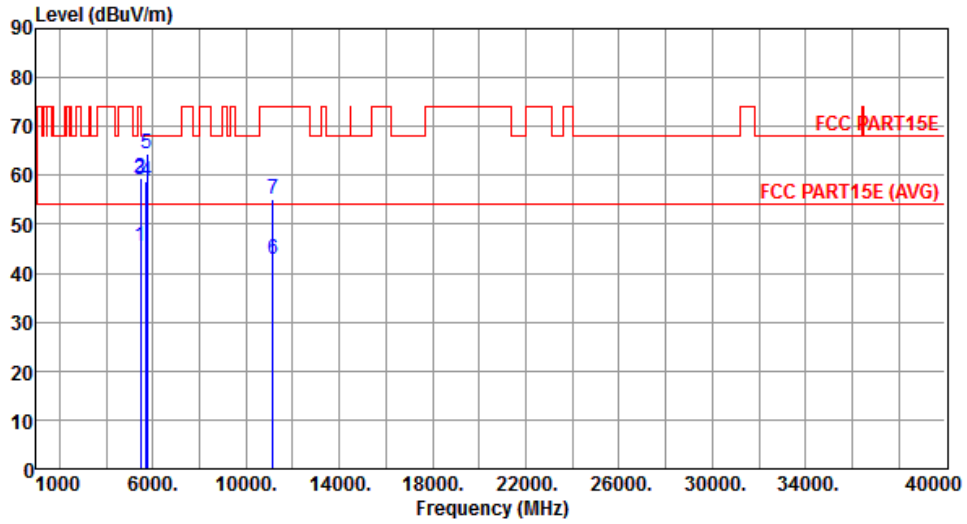

	Freq. MHz	Emission level dBuV/m	Limit dBuV/m	Margin dB	SA reading dBuV	Factor dB	Remark	ANT High cm	Turn Table deg
1	5460.00	45.47	54.00	-8.53	38.83	6.64	Average	232	258
2	5460.00	59.45	74.00	-14.55	52.81	6.64	Peak	232	258
3	5470.00	59.18	68.20	-9.02	52.53	6.65	Peak	232	258
4	5725.00	58.75	68.20	-9.45	51.62	7.13	Peak	232	258
5	5740.00	64.42	68.20	-3.78	57.26	7.16	Peak	232	258
6	11160.00	42.86	54.00	-11.14	26.17	16.69	Average	267	227
7	11160.00	55.20	74.00	-18.80	38.51	16.69	Peak	267	227

Note 1: Emission Level (dBuV/m) = SA Reading (dBuV/m) + Factor* (dB)

*Factor includes antenna factor , cable loss and amplifier gain

Note 2: Margin (dB) = Emission level (dBuV/m) – Limit (dBuV/m).

Modulation	11a	Test Freq. (MHz)	5700
Polarization	Horizontal	Test Configuration	1

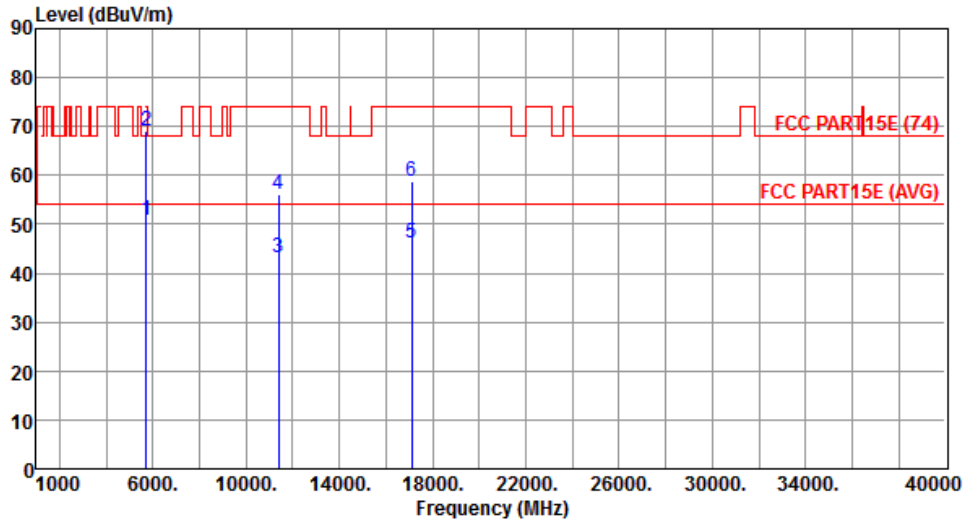

	Freq. MHz	Emission level dBuV/m	Limit dBuV/m	Margin dB	SA reading dBuV	Factor dB	Remark	ANT High cm	Turn Table deg
1	5725.00	50.66	54.00	-3.34	43.53	7.13	Average	350	22
2	5725.00	69.12	74.00	-4.88	61.99	7.13	Peak	350	22
3	11400.00	43.14	54.00	-10.86	26.37	16.77	Average	326	224
4	11400.00	55.97	74.00	-18.03	39.20	16.77	Peak	326	224
5	17100.00	46.21	54.00	-7.79	27.24	18.97	Average	188	51
6	17100.00	58.87	74.00	-15.13	39.90	18.97	Peak	188	51

Note 1: Emission Level (dBuV/m) = SA Reading (dBuV/m) + Factor* (dB)

*Factor includes antenna factor , cable loss and amplifier gain

Note 2: Margin (dB) = Emission level (dBuV/m) – Limit (dBuV/m).

Modulation	11a	Test Freq. (MHz)	5700
Polarization	Vertical	Test Configuration	1

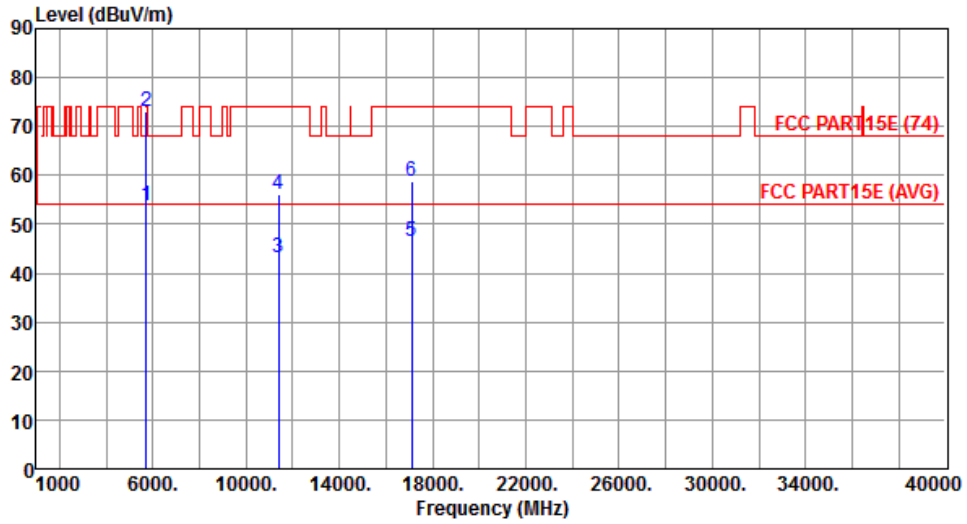

	Freq. MHz	Emission level dBuV/m	Limit dBuV/m	Margin dB	SA reading dBuV	Factor dB	Remark	ANT High cm	Turn Table deg
1	5725.00	53.78	54.00	-0.22	46.65	7.13	Average	233	256
2	5725.00	72.90	74.00	-1.10	65.77	7.13	Peak	233	256
3	11400.00	43.27	54.00	-10.73	26.50	16.77	Average	291	23
4	11400.00	56.11	74.00	-17.89	39.34	16.77	Peak	291	23
5	17100.00	46.43	54.00	-7.57	27.46	18.97	Average	278	198
6	17100.00	58.79	74.00	-15.21	39.82	18.97	Peak	278	198

Note 1: Emission Level (dBuV/m) = SA Reading (dBuV/m) + Factor* (dB)

*Factor includes antenna factor , cable loss and amplifier gain

Note 2: Margin (dB) = Emission level (dBuV/m) – Limit (dBuV/m).

Modulation	11a	Test Freq. (MHz)	5720
Polarization	Horizontal	Test Configuration	1

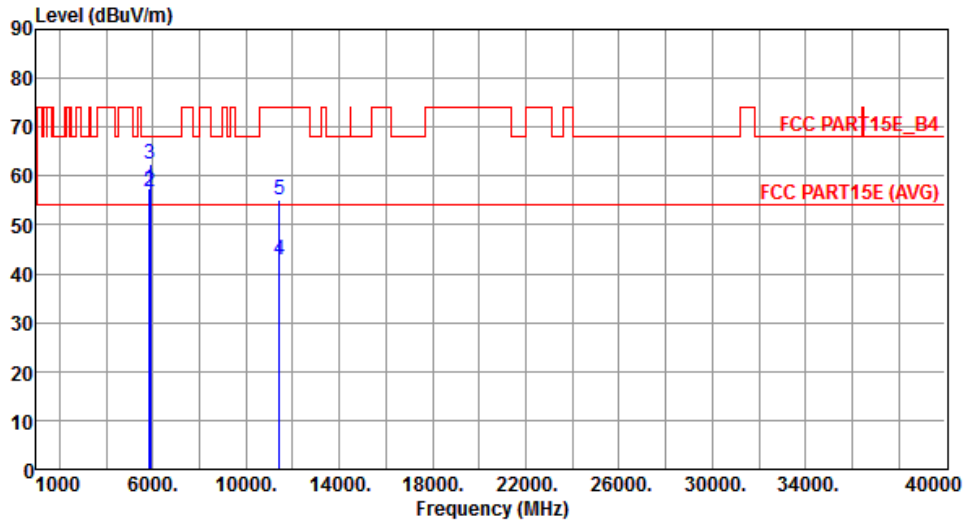

	Freq. MHz	Emission level dBUV/m	Limit dBUV/m	Margin dB	SA reading dBUV	Factor dB	Remark	ANT High cm	Turn Table deg
1	5850.00	57.50	78.20	-20.70	50.11	7.39	Peak	318	30
2	5860.00	56.80	68.20	-11.40	49.40	7.40	Peak	318	30
3	5880.00	62.45	68.20	-5.75	55.01	7.44	Peak	318	30
4	11440.00	42.89	54.00	-11.11	26.10	16.79	Average	217	333
5	11440.00	55.10	74.00	-18.90	38.31	16.79	Peak	217	333

Note 1: Emission Level (dBUV/m) = SA Reading (dBUV/m) + Factor* (dB)

*Factor includes antenna factor , cable loss and amplifier gain

Note 2: Margin (dB) = Emission level (dBUV/m) – Limit (dBUV/m).

Modulation	11a	Test Freq. (MHz)	5720
Polarization	Vertical	Test Configuration	1

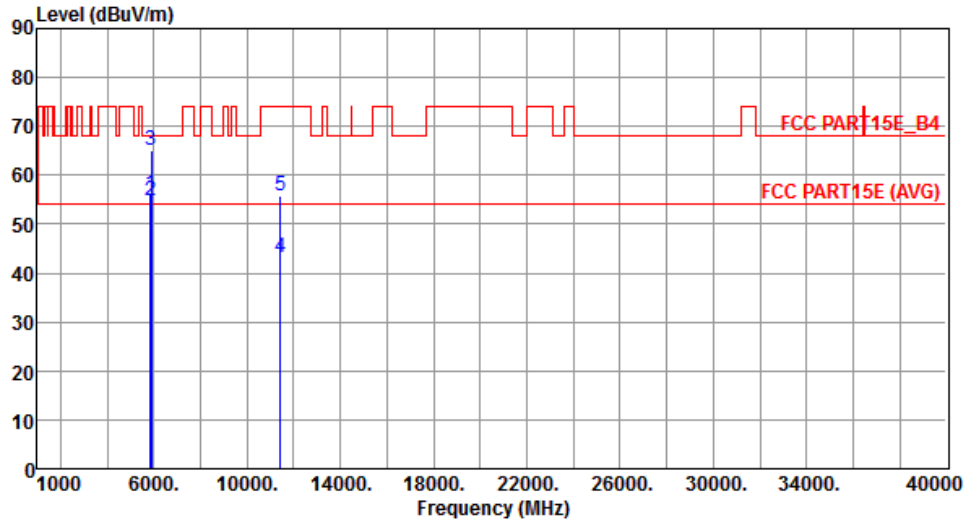

	Freq. MHz	Emission level dBuV/m	Limit dBuV/m	Margin dB	SA reading dBuV	Factor dB	Remark	ANT High cm	Turn Table deg
1	5850.00	56.19	78.20	-22.01	48.80	7.39	Peak	308	322
2	5860.00	54.76	68.20	-13.44	47.36	7.40	Peak	308	322
3	5880.00	65.10	68.20	-3.10	57.66	7.44	Peak	308	322
4	11440.00	43.11	54.00	-10.89	26.32	16.79	Average	297	103
5	11440.00	55.70	74.00	-18.30	38.91	16.79	Peak	297	103

Note 1: Emission Level (dBuV/m) = SA Reading (dBuV/m) + Factor* (dB)

*Factor includes antenna factor, cable loss and amplifier gain

Note 2: Margin (dB) = Emission level (dBuV/m) – Limit (dBuV/m).

3.5.6 Transmitter Radiated Unwanted Emissions (Above 1GHz) for VHT20

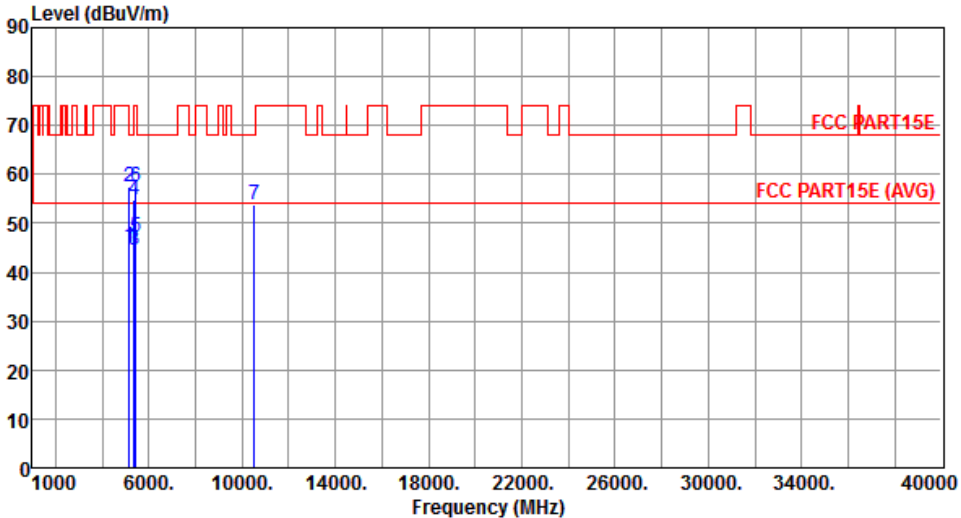
Modulation	VHT20	Test Freq. (MHz)	5260																																																																																									
Polarization	Horizontal	Test Configuration	1																																																																																									
																																																																																												
	<table border="1"> <thead> <tr> <th>Freq.</th> <th>Emission level</th> <th>Limit</th> <th>Margin</th> <th>SA reading</th> <th>Factor</th> <th>Remark</th> <th>ANT High</th> <th>Turn Table</th> </tr> <tr> <th>MHz</th> <th>dBuV/m</th> <th>dBuV/m</th> <th>dB</th> <th>dBuV</th> <th>dB</th> <th></th> <th>cm</th> <th>deg</th> </tr> </thead> <tbody> <tr> <td>1</td> <td>5150.00</td> <td>45.04</td> <td>54.00</td> <td>-8.96</td> <td>38.85</td> <td>6.19</td> <td>Average</td> <td>235</td> <td>30</td> </tr> <tr> <td>2</td> <td>5150.00</td> <td>57.49</td> <td>74.00</td> <td>-16.51</td> <td>51.30</td> <td>6.19</td> <td>Peak</td> <td>235</td> <td>30</td> </tr> <tr> <td>3</td> <td>5350.00</td> <td>44.48</td> <td>54.00</td> <td>-9.52</td> <td>37.97</td> <td>6.51</td> <td>Average</td> <td>235</td> <td>30</td> </tr> <tr> <td>4</td> <td>5350.00</td> <td>54.94</td> <td>74.00</td> <td>-19.06</td> <td>48.43</td> <td>6.51</td> <td>Peak</td> <td>235</td> <td>30</td> </tr> <tr> <td>5</td> <td>5420.00</td> <td>47.00</td> <td>54.00</td> <td>-7.00</td> <td>40.40</td> <td>6.60</td> <td>Average</td> <td>273</td> <td>35</td> </tr> <tr> <td>6</td> <td>5420.00</td> <td>57.44</td> <td>74.00</td> <td>-16.56</td> <td>50.84</td> <td>6.60</td> <td>Peak</td> <td>273</td> <td>35</td> </tr> <tr> <td>7</td> <td>10520.00</td> <td>53.85</td> <td>68.20</td> <td>-14.35</td> <td>37.36</td> <td>16.49</td> <td>Peak</td> <td>271</td> <td>355</td> </tr> </tbody> </table>	Freq.	Emission level	Limit	Margin	SA reading	Factor	Remark	ANT High	Turn Table	MHz	dBuV/m	dBuV/m	dB	dBuV	dB		cm	deg	1	5150.00	45.04	54.00	-8.96	38.85	6.19	Average	235	30	2	5150.00	57.49	74.00	-16.51	51.30	6.19	Peak	235	30	3	5350.00	44.48	54.00	-9.52	37.97	6.51	Average	235	30	4	5350.00	54.94	74.00	-19.06	48.43	6.51	Peak	235	30	5	5420.00	47.00	54.00	-7.00	40.40	6.60	Average	273	35	6	5420.00	57.44	74.00	-16.56	50.84	6.60	Peak	273	35	7	10520.00	53.85	68.20	-14.35	37.36	16.49	Peak	271	355			
Freq.	Emission level	Limit	Margin	SA reading	Factor	Remark	ANT High	Turn Table																																																																																				
MHz	dBuV/m	dBuV/m	dB	dBuV	dB		cm	deg																																																																																				
1	5150.00	45.04	54.00	-8.96	38.85	6.19	Average	235	30																																																																																			
2	5150.00	57.49	74.00	-16.51	51.30	6.19	Peak	235	30																																																																																			
3	5350.00	44.48	54.00	-9.52	37.97	6.51	Average	235	30																																																																																			
4	5350.00	54.94	74.00	-19.06	48.43	6.51	Peak	235	30																																																																																			
5	5420.00	47.00	54.00	-7.00	40.40	6.60	Average	273	35																																																																																			
6	5420.00	57.44	74.00	-16.56	50.84	6.60	Peak	273	35																																																																																			
7	10520.00	53.85	68.20	-14.35	37.36	16.49	Peak	271	355																																																																																			
<p>Note 1: Emission Level (dBuV/m) = SA Reading (dBuV/m) + Factor* (dB) *Factor includes antenna factor , cable loss and amplifier gain Note 2: Margin (dB) = Emission level (dBuV/m) – Limit (dBuV/m).</p>																																																																																												

Modulation	VHT20	Test Freq. (MHz)	5260
Polarization	Vertical	Test Configuration	1

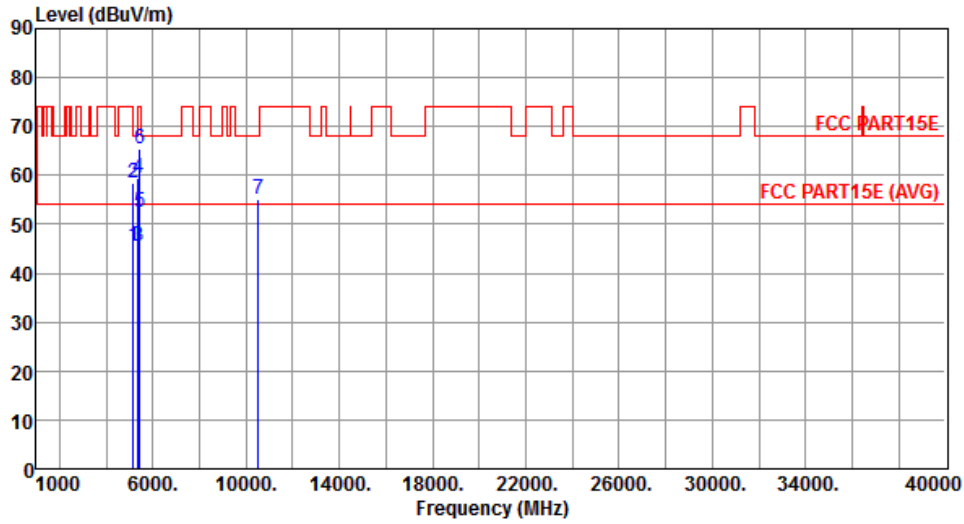

	Freq. MHz	Emission level dBuV/m	Limit dBuV/m	Margin dB	SA reading dBuV	Factor dB	Remark	ANT High cm	Turn Table deg
1	5150.00	45.43	54.00	-8.57	39.24	6.19	Average	249	280
2	5150.00	58.45	74.00	-15.55	52.26	6.19	Peak	249	280
3	5350.00	45.64	54.00	-8.36	39.13	6.51	Average	240	281
4	5350.00	59.33	74.00	-14.67	52.82	6.51	Peak	240	281
5	5420.00	52.35	54.00	-1.65	45.75	6.60	Average	240	281
6	5420.00	65.44	74.00	-8.56	58.84	6.60	Peak	240	281
7	10520.00	55.12	68.20	-13.08	38.63	16.49	Peak	237	33

Note 1: Emission Level (dBuV/m) = SA Reading (dBuV/m) + Factor* (dB)

*Factor includes antenna factor , cable loss and amplifier gain

Note 2: Margin (dB) = Emission level (dBuV/m) – Limit (dBuV/m).

Modulation	VHT20	Test Freq. (MHz)	5300
Polarization	Horizontal	Test Configuration	1

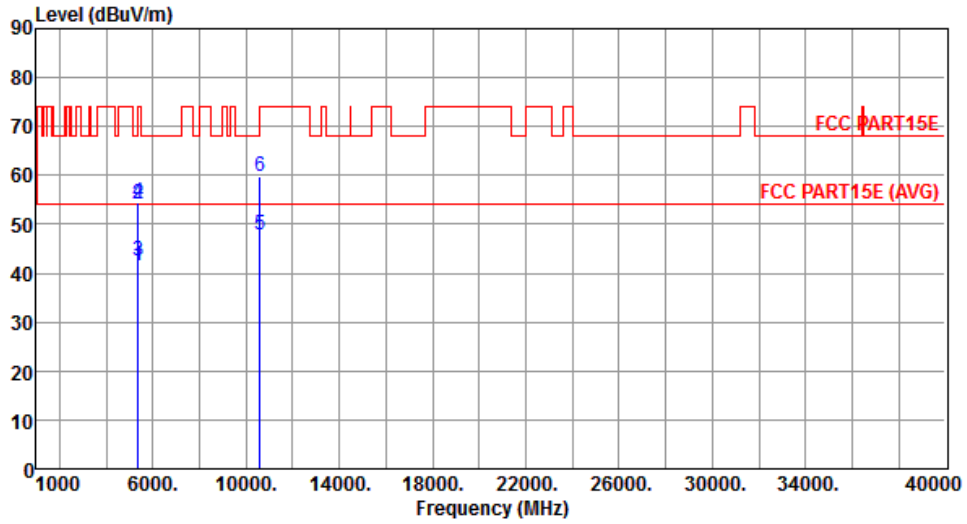

	Freq. MHz	Emission level dBuV/m	Limit dBuV/m	Margin dB	SA reading dBuV	Factor dB	Remark	ANT High cm	Turn Table deg
1	5350.00	41.63	54.00	-12.37	35.12	6.51	Average	313	28
2	5350.00	54.11	74.00	-19.89	47.60	6.51	Peak	313	28
3	5380.00	42.62	54.00	-11.38	36.08	6.54	Average	235	26
4	5380.00	54.33	74.00	-19.67	47.79	6.54	Peak	235	26
5	10600.00	47.97	54.00	-6.03	31.46	16.51	Average	275	226
6	10600.00	59.89	74.00	-14.11	43.38	16.51	Peak	275	226

Note 1: Emission Level (dBuV/m) = SA Reading (dBuV/m) + Factor* (dB)

*Factor includes antenna factor , cable loss and amplifier gain

Note 2: Margin (dB) = Emission level (dBuV/m) – Limit (dBuV/m).

Modulation	VHT20	Test Freq. (MHz)	5300
Polarization	Vertical	Test Configuration	1

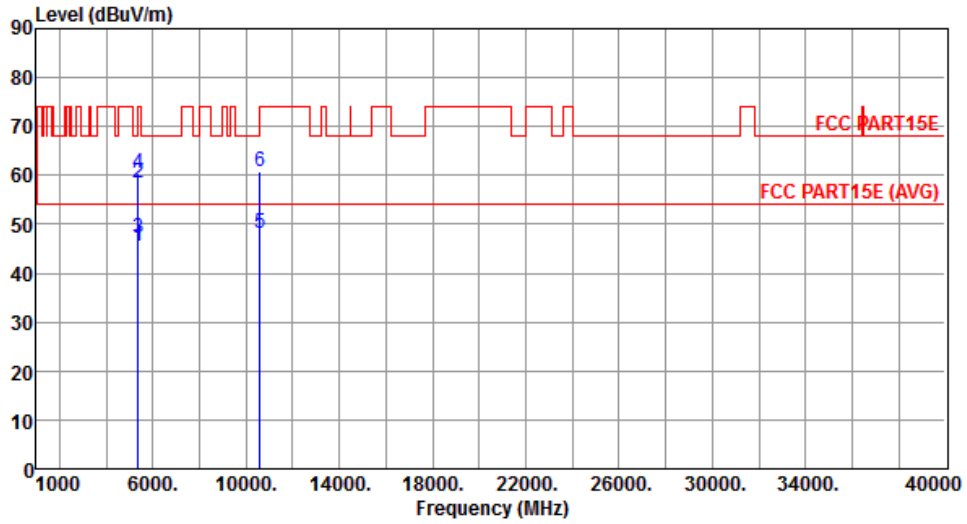

	Freq. MHz	Emission level dBuV/m	Limit dBuV/m	Margin dB	SA reading dBuV	Factor dB	Remark	ANT High cm	Turn Table deg
1	5350.00	45.50	54.00	-8.50	38.99	6.51	Average	245	291
2	5350.00	58.36	74.00	-15.64	51.85	6.51	Peak	245	291
3	5380.00	47.04	54.00	-6.96	40.50	6.54	Average	240	286
4	5380.00	60.39	74.00	-13.61	53.85	6.54	Peak	240	286
5	10600.00	48.06	54.00	-5.94	31.55	16.51	Average	259	285
6	10600.00	60.83	74.00	-13.17	44.32	16.51	Peak	259	285

Note 1: Emission Level (dBuV/m) = SA Reading (dBuV/m) + Factor* (dB)

*Factor includes antenna factor , cable loss and amplifier gain

Note 2: Margin (dB) = Emission level (dBuV/m) – Limit (dBuV/m).

Modulation	VHT20	Test Freq. (MHz)	5320
Polarization	Horizontal	Test Configuration	1

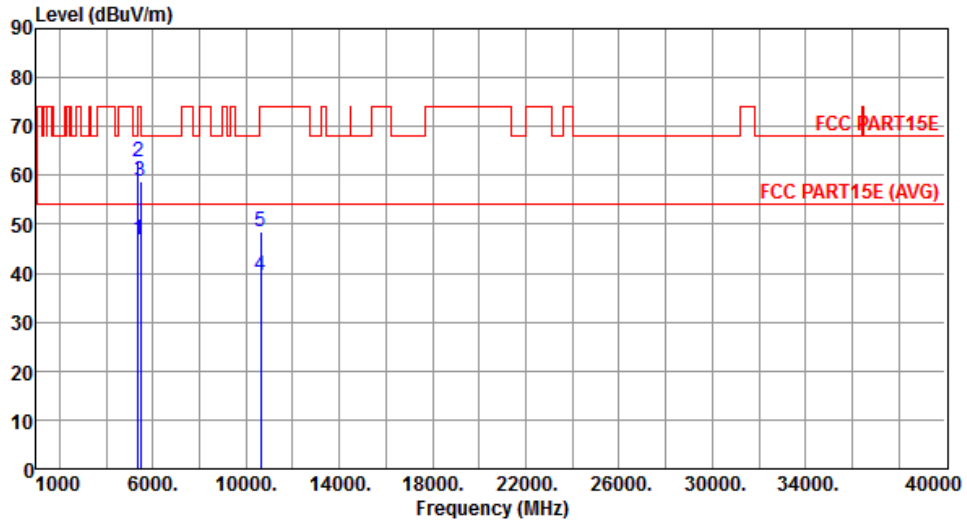

	Freq. MHz	Emission level dBuV/m	Limit dBuV/m	Margin dB	SA reading dBuV	Factor dB	Remark	ANT High cm	Turn Table deg
1	5350.00	46.74	54.00	-7.26	40.23	6.51	Average	243	31
2	5350.00	62.77	74.00	-11.23	56.26	6.51	Peak	243	31
3	5480.00	58.65	68.20	-9.55	52.00	6.65	Peak	305	32
4	10640.00	39.56	54.00	-14.44	23.03	16.53	Average	275	221
5	10640.00	48.41	74.00	-25.59	31.88	16.53	Peak	275	221

Note 1: Emission Level (dBuV/m) = SA Reading (dBuV/m) + Factor* (dB)

*Factor includes antenna factor , cable loss and amplifier gain

Note 2: Margin (dB) = Emission level (dBuV/m) – Limit (dBuV/m).

Modulation	VHT20	Test Freq. (MHz)	5320
Polarization	Vertical	Test Configuration	1

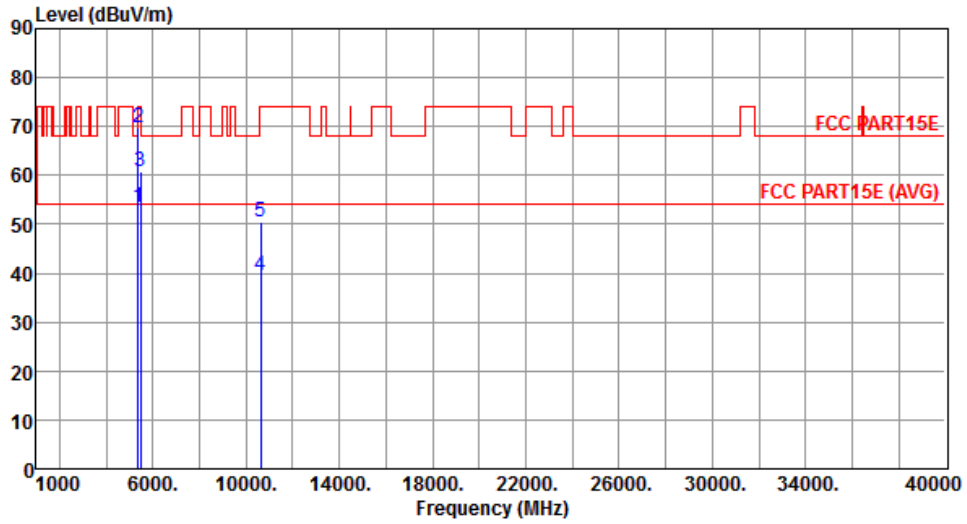

	Freq. MHz	Emission level dBuV/m	Limit dBuV/m	Margin dB	SA reading dBuV	Factor dB	Remark	ANT High cm	Turn Table deg
1	5350.00	53.36	54.00	-0.64	46.85	6.51	Average	238	278
2	5350.00	69.67	74.00	-4.33	63.16	6.51	Peak	238	278
3	5480.00	60.77	68.20	-7.43	54.12	6.65	Peak	309	318
4	10640.00	39.65	54.00	-14.35	23.12	16.53	Average	314	56
5	10640.00	50.42	74.00	-23.58	33.89	16.53	Peak	314	56

Note 1: Emission Level (dBuV/m) = SA Reading (dBuV/m) + Factor* (dB)

*Factor includes antenna factor , cable loss and amplifier gain

Note 2: Margin (dB) = Emission level (dBuV/m) – Limit (dBuV/m).

Modulation	VHT20	Test Freq. (MHz)	5500
Polarization	Horizontal	Test Configuration	1

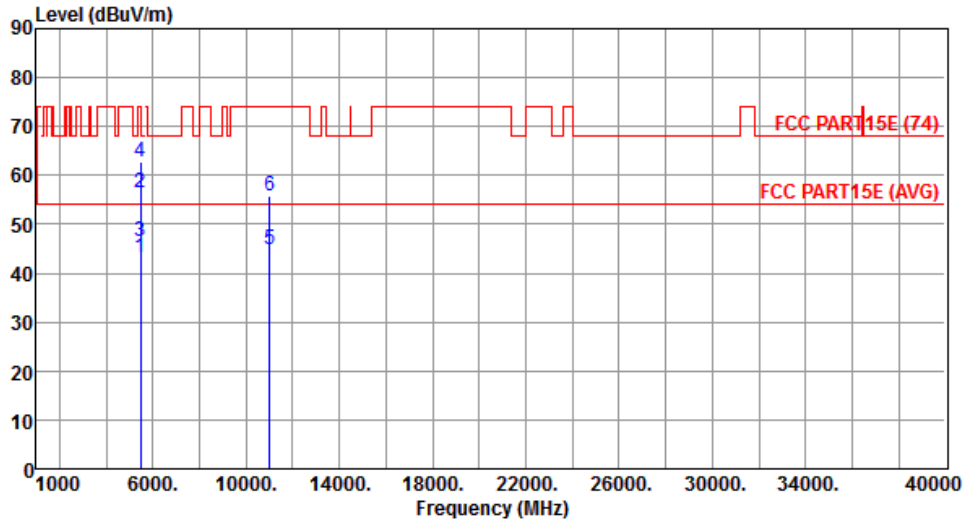

	Freq. MHz	Emission level dBuV/m	Limit dBuV/m	Margin dB	SA reading dBuV	Factor dB	Remark	ANT High cm	Turn Table deg
1	5460.00	43.04	54.00	-10.96	36.40	6.64	Average	295	34
2	5460.00	56.62	74.00	-17.38	49.98	6.64	Peak	295	34
3	5470.00	46.46	54.00	-7.54	39.81	6.65	Average	295	34
4	5470.00	62.76	74.00	-11.24	56.11	6.65	Peak	295	34
5	11000.00	44.68	54.00	-9.32	28.06	16.62	Average	213	178
6	11000.00	55.79	74.00	-18.21	39.17	16.62	Peak	213	178

Note 1: Emission Level (dBuV/m) = SA Reading (dBuV/m) + Factor* (dB)

*Factor includes antenna factor , cable loss and amplifier gain

Note 2: Margin (dB) = Emission level (dBuV/m) – Limit (dBuV/m).

Modulation	VHT20	Test Freq. (MHz)	5500
Polarization	Vertical	Test Configuration	1

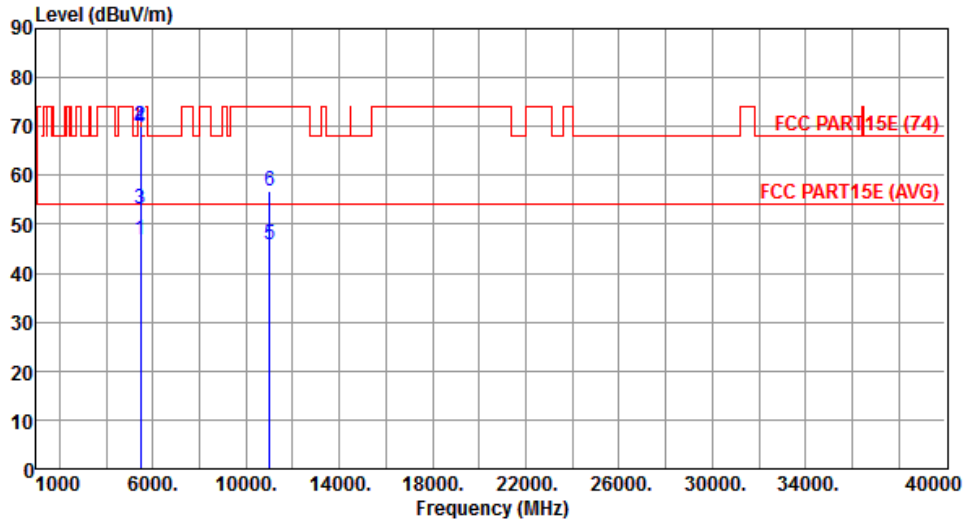

	Freq. MHz	Emission level dBuV/m	Limit dBuV/m	Margin dB	SA reading dBuV	Factor dB	Remark	ANT High cm	Turn Table deg
1	5460.00	46.84	54.00	-7.16	40.20	6.64	Average	234	250
2	5460.00	70.18	74.00	-3.82	63.54	6.64	Peak	234	250
3	5470.00	53.01	54.00	-0.99	46.36	6.65	Average	234	250
4	5470.00	69.63	74.00	-4.37	62.98	6.65	Peak	234	250
5	11000.00	45.77	54.00	-8.23	29.15	16.62	Average	260	279
6	11000.00	56.88	74.00	-17.12	40.26	16.62	Peak	260	279

Note 1: Emission Level (dBuV/m) = SA Reading (dBuV/m) + Factor* (dB)

*Factor includes antenna factor , cable loss and amplifier gain

Note 2: Margin (dB) = Emission level (dBuV/m) – Limit (dBuV/m).

Modulation	VHT20	Test Freq. (MHz)	5580
Polarization	Horizontal	Test Configuration	1

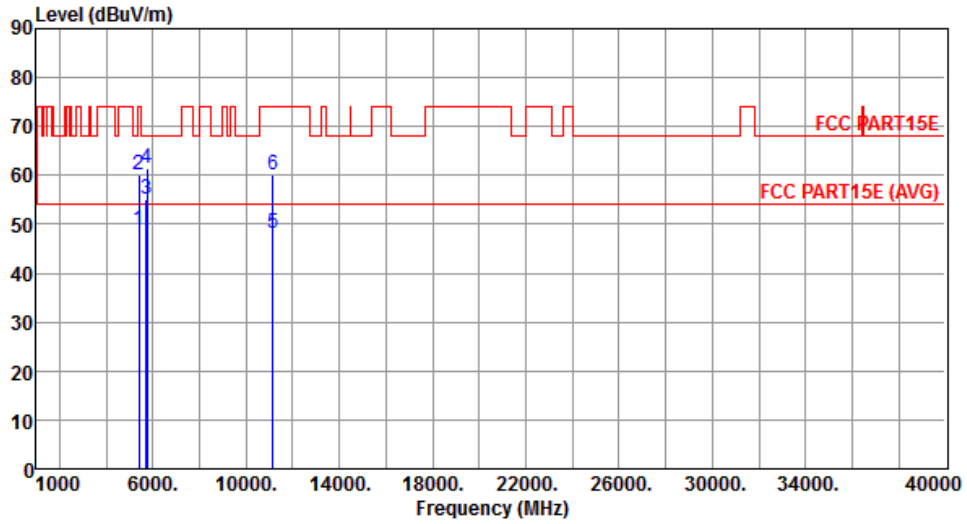

	Freq. MHz	Emission level dBuV/m	Limit dBuV/m	Margin dB	SA reading dBuV	Factor dB	Remark	ANT High cm	Turn Table deg
1	5418.00	48.71	54.00	-5.29	42.12	6.59	Average	263	78
2	5418.00	60.12	74.00	-13.88	53.53	6.59	Peak	263	78
3	5725.00	54.98	68.20	-13.22	47.85	7.13	Peak	263	78
4	5739.00	61.38	68.20	-6.82	54.22	7.16	Peak	263	78
5	11160.00	48.26	54.00	-5.74	31.57	16.69	Average	205	222
6	11160.00	60.25	74.00	-13.75	43.56	16.69	Peak	205	222

Note 1: Emission Level (dBuV/m) = SA Reading (dBuV/m) + Factor* (dB)

*Factor includes antenna factor , cable loss and amplifier gain

Note 2: Margin (dB) = Emission level (dBuV/m) – Limit (dBuV/m).

Modulation	VHT20	Test Freq. (MHz)	5580
Polarization	Vertical	Test Configuration	1

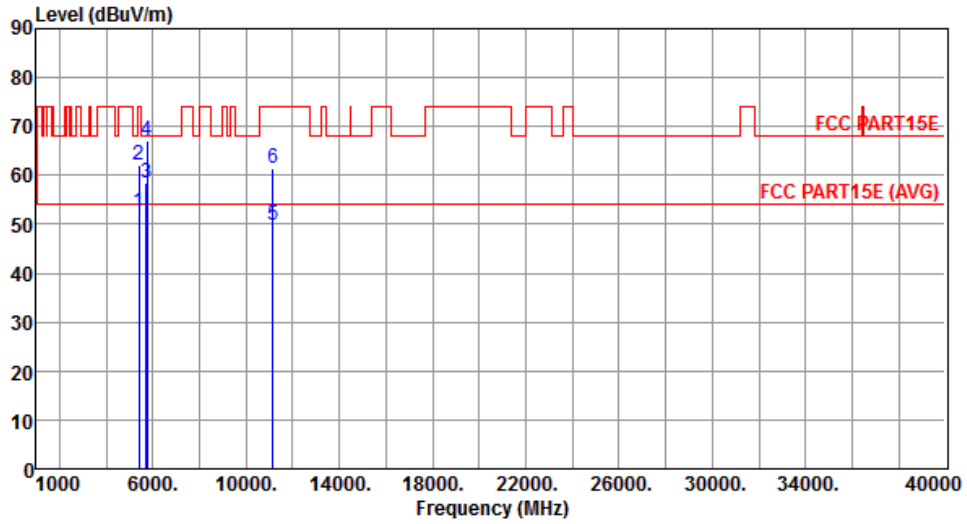

	Freq. MHz	Emission level dBuV/m	Limit dBuV/m	Margin dB	SA reading dBuV	Factor dB	Remark	ANT High cm	Turn Table deg
1	5418.00	52.63	54.00	-1.37	46.04	6.59	Average	231	283
2	5418.00	62.02	74.00	-11.98	55.43	6.59	Peak	231	283
3	5725.00	58.46	68.20	-9.74	51.33	7.13	Peak	236	251
4	5739.00	67.07	68.20	-1.13	59.91	7.16	Peak	245	254
5	11160.00	49.79	54.00	-4.21	33.10	16.69	Average	252	276
6	11160.00	61.49	74.00	-12.51	44.80	16.69	Peak	252	276

Note 1: Emission Level (dBuV/m) = SA Reading (dBuV/m) + Factor* (dB)

*Factor includes antenna factor , cable loss and amplifier gain

Note 2: Margin (dB) = Emission level (dBuV/m) – Limit (dBuV/m).

Modulation	VHT20	Test Freq. (MHz)	5700
Polarization	Horizontal	Test Configuration	1

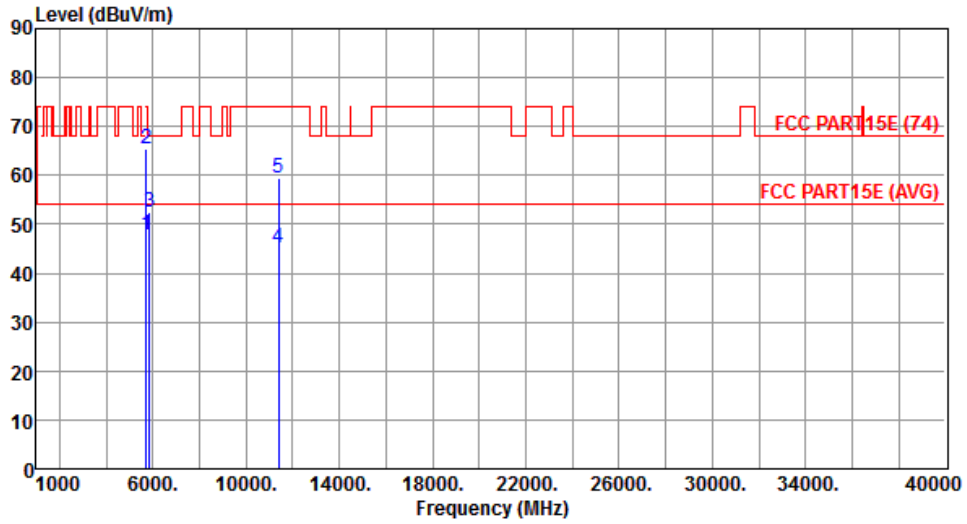

	Freq. MHz	Emission level dBuV/m	Limit dBuV/m	Margin dB	SA reading dBuV	Factor dB	Remark	ANT High cm	Turn Table deg
1	5725.00	47.71	54.00	-6.29	40.58	7.13	Average	286	30
2	5725.00	65.38	74.00	-8.62	58.25	7.13	Peak	286	30
3	5860.00	52.51	68.20	-15.69	45.11	7.40	Peak	260	38
4	11400.00	45.12	54.00	-8.88	28.35	16.77	Average	217	305
5	11400.00	59.32	74.00	-14.68	42.55	16.77	Peak	217	305

Note 1: Emission Level (dBuV/m) = SA Reading (dBuV/m) + Factor* (dB)

*Factor includes antenna factor , cable loss and amplifier gain

Note 2: Margin (dB) = Emission level (dBuV/m) – Limit (dBuV/m).

Modulation	VHT20	Test Freq. (MHz)	5700
Polarization	Vertical	Test Configuration	1

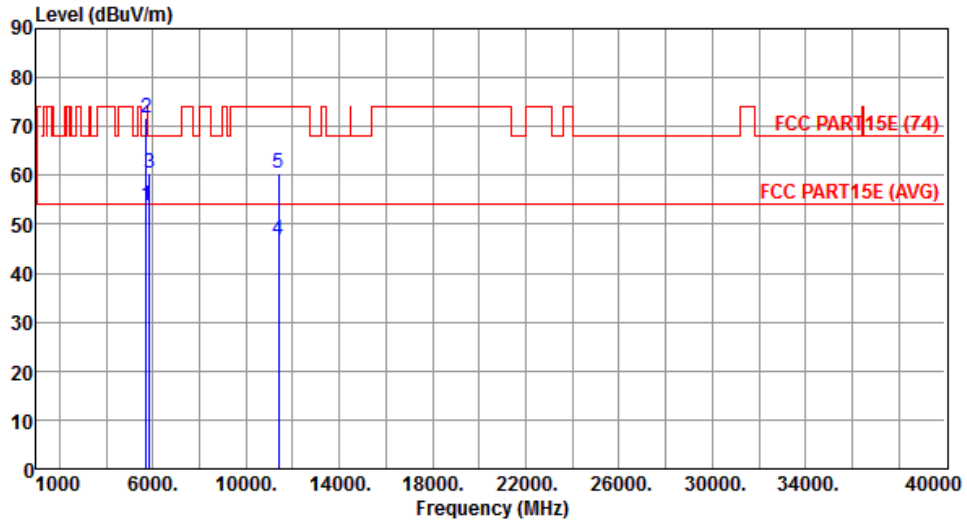

	Freq. MHz	Emission level dBuV/m	Limit dBuV/m	Margin dB	SA reading dBuV	Factor dB	Remark	ANT High cm	Turn Table deg
1	5725.00	53.68	54.00	-0.32	46.55	7.13	Average	233	254
2	5725.00	71.70	74.00	-2.30	64.57	7.13	Peak	233	254
3	5860.00	60.53	68.20	-7.67	53.13	7.40	Peak	265	277
4	11400.00	46.89	54.00	-7.11	30.12	16.77	Average	251	5
5	11400.00	60.33	74.00	-13.67	43.56	16.77	Peak	251	5

Note 1: Emission Level (dBuV/m) = SA Reading (dBuV/m) + Factor* (dB)

*Factor includes antenna factor , cable loss and amplifier gain

Note 2: Margin (dB) = Emission level (dBuV/m) – Limit (dBuV/m).

Modulation	VHT20	Test Freq. (MHz)	5720
Polarization	Horizontal	Test Configuration	1

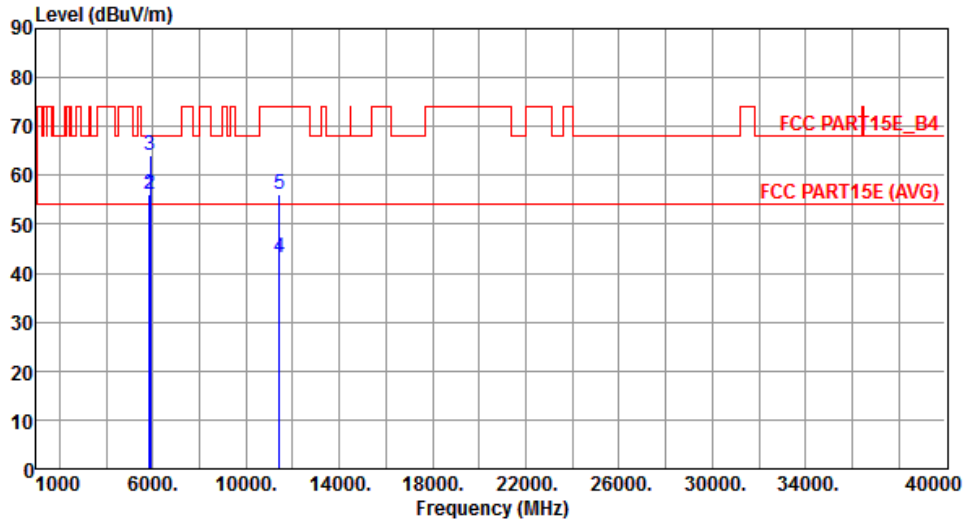

	Freq. MHz	Emission level dBuV/m	Limit dBuV/m	Margin dB	SA reading dBuV	Factor dB	Remark	ANT High cm	Turn Table deg
1	5850.00	56.14	78.20	-22.06	48.75	7.39	Peak	320	31
2	5860.00	55.97	68.20	-12.23	48.57	7.40	Peak	320	31
3	5880.00	64.22	68.20	-3.98	56.78	7.44	Peak	320	31
4	11440.00	43.26	54.00	-10.74	26.47	16.79	Average	227	156
5	11440.00	56.26	74.00	-17.74	39.47	16.79	Peak	227	156

Note 1: Emission Level (dBuV/m) = SA Reading (dBuV/m) + Factor* (dB)

*Factor includes antenna factor, cable loss and amplifier gain

Note 2: Margin (dB) = Emission level (dBuV/m) – Limit (dBuV/m).

Modulation	VHT20	Test Freq. (MHz)	5720
Polarization	Vertical	Test Configuration	1

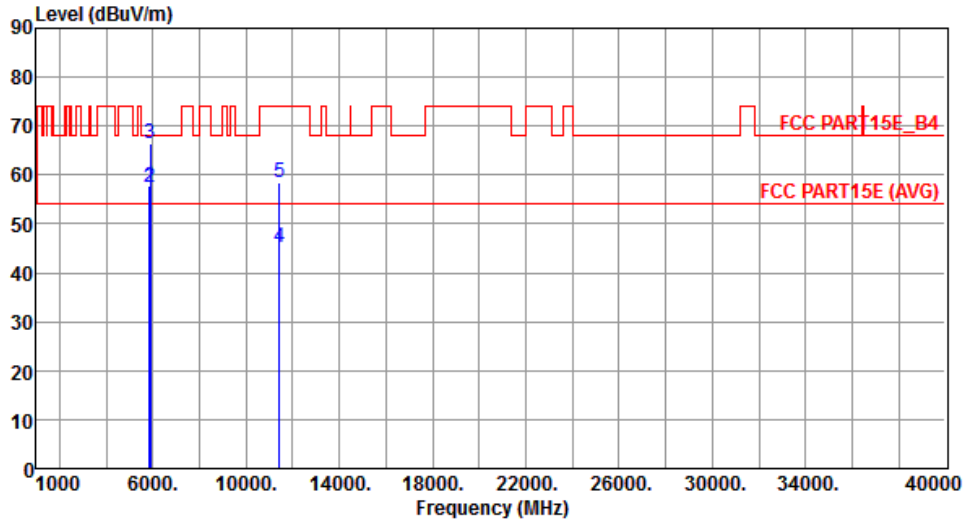

	Freq. MHz	Emission level dBuV/m	Limit dBuV/m	Margin dB	SA reading dBuV	Factor dB	Remark	ANT High cm	Turn Table deg
1	5850.00	57.71	78.20	-20.49	50.32	7.39	Peak	264	91
2	5860.00	57.52	68.20	-10.68	50.12	7.40	Peak	264	91
3	5880.00	66.41	68.20	-1.79	58.97	7.44	Peak	264	91
4	11440.00	45.03	54.00	-8.97	28.24	16.79	Average	179	311
5	11440.00	58.30	74.00	-15.70	41.51	16.79	Peak	179	311

Note 1: Emission Level (dBuV/m) = SA Reading (dBuV/m) + Factor* (dB)

*Factor includes antenna factor , cable loss and amplifier gain

Note 2: Margin (dB) = Emission level (dBuV/m) – Limit (dBuV/m).

3.5.7 Transmitter Radiated Unwanted Emissions (Above 1GHz) for VHT40

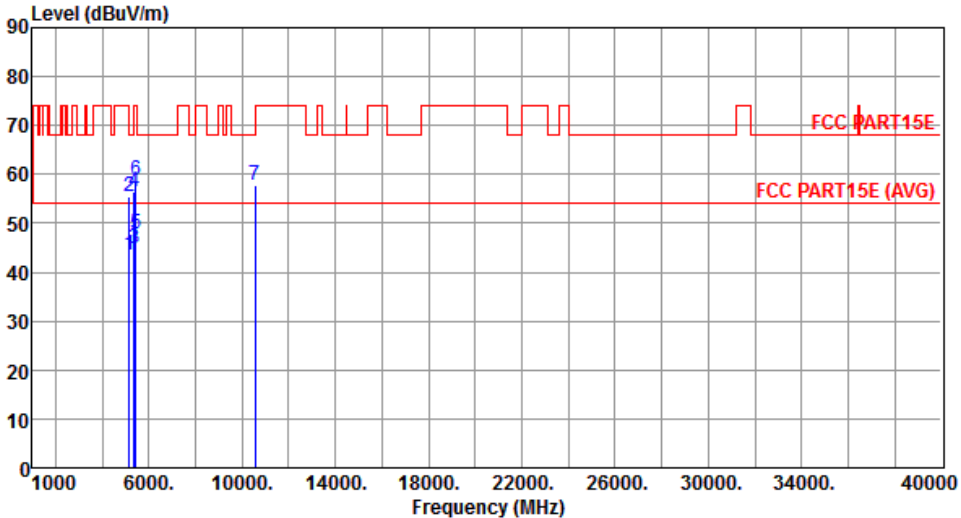
Modulation	VHT40	Test Freq. (MHz)	5270																																																																																									
Polarization	Horizontal	Test Configuration	1																																																																																									
																																																																																												
	<table border="1"> <thead> <tr> <th>Freq.</th> <th>Emission level</th> <th>Limit</th> <th>Margin</th> <th>SA reading</th> <th>Factor</th> <th>Remark</th> <th>ANT High</th> <th>Turn Table</th> </tr> <tr> <th>MHz</th> <th>dBUV/m</th> <th>dBUV/m</th> <th>dB</th> <th>dBuV</th> <th>dB</th> <th></th> <th>cm</th> <th>deg</th> </tr> </thead> <tbody> <tr> <td>1</td> <td>5150.00</td> <td>43.49</td> <td>54.00</td> <td>-10.51</td> <td>37.30</td> <td>6.19</td> <td>Average</td> <td>296</td> <td>35</td> </tr> <tr> <td>2</td> <td>5150.00</td> <td>55.39</td> <td>74.00</td> <td>-18.61</td> <td>49.20</td> <td>6.19</td> <td>Peak</td> <td>296</td> <td>35</td> </tr> <tr> <td>3</td> <td>5350.00</td> <td>44.71</td> <td>54.00</td> <td>-9.29</td> <td>38.20</td> <td>6.51</td> <td>Average</td> <td>296</td> <td>35</td> </tr> <tr> <td>4</td> <td>5350.00</td> <td>56.41</td> <td>74.00</td> <td>-17.59</td> <td>49.90</td> <td>6.51</td> <td>Peak</td> <td>296</td> <td>35</td> </tr> <tr> <td>5</td> <td>5430.00</td> <td>47.86</td> <td>54.00</td> <td>-6.14</td> <td>41.26</td> <td>6.60</td> <td>Average</td> <td>296</td> <td>35</td> </tr> <tr> <td>6</td> <td>5430.00</td> <td>58.87</td> <td>74.00</td> <td>-15.13</td> <td>52.27</td> <td>6.60</td> <td>Peak</td> <td>296</td> <td>35</td> </tr> <tr> <td>7</td> <td>10540.00</td> <td>57.89</td> <td>68.20</td> <td>-10.31</td> <td>41.40</td> <td>16.49</td> <td>Peak</td> <td>277</td> <td>183</td> </tr> </tbody> </table>	Freq.	Emission level	Limit	Margin	SA reading	Factor	Remark	ANT High	Turn Table	MHz	dBUV/m	dBUV/m	dB	dBuV	dB		cm	deg	1	5150.00	43.49	54.00	-10.51	37.30	6.19	Average	296	35	2	5150.00	55.39	74.00	-18.61	49.20	6.19	Peak	296	35	3	5350.00	44.71	54.00	-9.29	38.20	6.51	Average	296	35	4	5350.00	56.41	74.00	-17.59	49.90	6.51	Peak	296	35	5	5430.00	47.86	54.00	-6.14	41.26	6.60	Average	296	35	6	5430.00	58.87	74.00	-15.13	52.27	6.60	Peak	296	35	7	10540.00	57.89	68.20	-10.31	41.40	16.49	Peak	277	183			
Freq.	Emission level	Limit	Margin	SA reading	Factor	Remark	ANT High	Turn Table																																																																																				
MHz	dBUV/m	dBUV/m	dB	dBuV	dB		cm	deg																																																																																				
1	5150.00	43.49	54.00	-10.51	37.30	6.19	Average	296	35																																																																																			
2	5150.00	55.39	74.00	-18.61	49.20	6.19	Peak	296	35																																																																																			
3	5350.00	44.71	54.00	-9.29	38.20	6.51	Average	296	35																																																																																			
4	5350.00	56.41	74.00	-17.59	49.90	6.51	Peak	296	35																																																																																			
5	5430.00	47.86	54.00	-6.14	41.26	6.60	Average	296	35																																																																																			
6	5430.00	58.87	74.00	-15.13	52.27	6.60	Peak	296	35																																																																																			
7	10540.00	57.89	68.20	-10.31	41.40	16.49	Peak	277	183																																																																																			
<p>Note 1: Emission Level (dBUV/m) = SA Reading (dBUV/m) + Factor* (dB) *Factor includes antenna factor , cable loss and amplifier gain Note 2: Margin (dB) = Emission level (dBUV/m) – Limit (dBUV/m).</p>																																																																																												

Modulation	VHT40	Test Freq. (MHz)	5270
Polarization	Vertical	Test Configuration	1

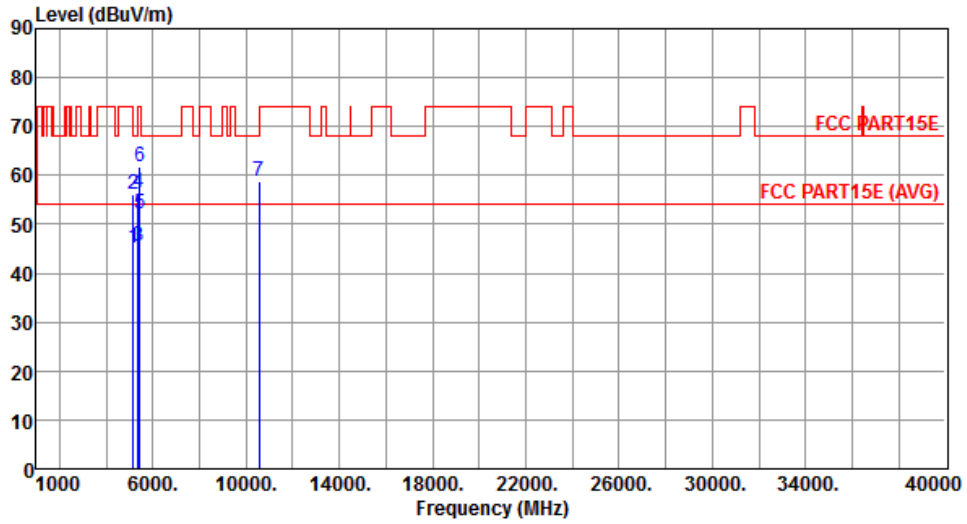

	Freq. MHz	Emission level dBuV/m	Limit dBuV/m	Margin dB	SA reading dBuV	Factor dB	Remark	ANT High cm	Turn Table deg
1	5150.00	45.27	54.00	-8.73	38.69	6.58	Average	246	269
2	5150.00	56.09	74.00	-17.91	49.51	6.58	Peak	246	269
3	5350.00	45.54	54.00	-8.46	38.51	7.03	Average	246	269
4	5350.00	56.53	74.00	-17.47	49.50	7.03	Peak	246	269
5	5430.00	52.26	54.00	-1.74	45.12	7.14	Average	246	269
6	5430.00	61.69	74.00	-12.31	54.55	7.14	Peak	246	269
7	10540.00	58.92	68.20	-9.28	42.43	16.49	Peak	245	134

Note 1: Emission Level (dBuV/m) = SA Reading (dBuV/m) + Factor* (dB)

*Factor includes antenna factor , cable loss and amplifier gain

Note 2: Margin (dB) = Emission level (dBuV/m) – Limit (dBuV/m).

Modulation	VHT40	Test Freq. (MHz)	5310
Polarization	Horizontal	Test Configuration	1

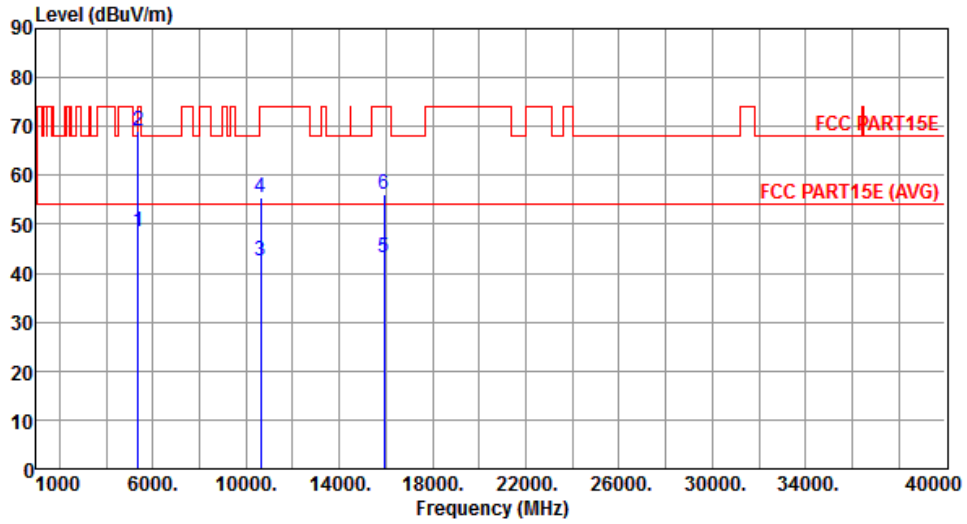

	Freq. MHz	Emission level dBuV/m	Limit dBuV/m	Margin dB	SA reading dBuV	Factor dB	Remark	ANT High cm	Turn Table deg
1	5350.00	48.34	54.00	-5.66	41.83	6.51	Average	350	225
2	5350.00	68.92	74.00	-5.08	62.41	6.51	Peak	350	225
3	10620.00	42.46	54.00	-11.54	25.95	16.51	Average	305	21
4	10620.00	55.59	74.00	-18.41	39.08	16.51	Peak	305	21
5	15930.00	43.04	54.00	-10.96	26.38	16.66	Average	291	157
6	15930.00	56.00	74.00	-18.00	39.34	16.66	Peak	291	157

Note 1: Emission Level (dBuV/m) = SA Reading (dBuV/m) + Factor* (dB)

*Factor includes antenna factor , cable loss and amplifier gain

Note 2: Margin (dB) = Emission level (dBuV/m) – Limit (dBuV/m).

Modulation	VHT40	Test Freq. (MHz)	5310
Polarization	Vertical	Test Configuration	1

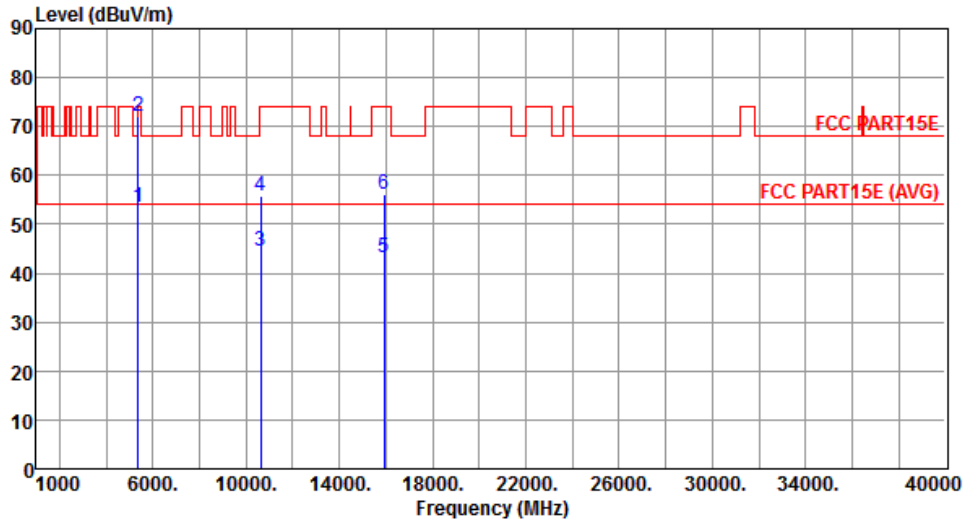

	Freq. MHz	Emission level dBuV/m	Limit dBuV/m	Margin dB	SA reading dBuV	Factor dB	Remark	ANT High cm	Turn Table deg
1	5350.00	53.42	54.00	-0.58	46.91	6.51	Average	254	248
2	5350.00	72.21	74.00	-1.79	65.70	6.51	Peak	254	248
3	10620.00	44.47	54.00	-9.53	27.96	16.51	Average	211	208
4	10620.00	55.82	74.00	-18.18	39.31	16.51	Peak	211	208
5	15930.00	43.19	54.00	-10.81	26.53	16.66	Average	233	295
6	15930.00	56.19	74.00	-17.81	39.53	16.66	Peak	233	295

Note 1: Emission Level (dBuV/m) = SA Reading (dBuV/m) + Factor* (dB)

*Factor includes antenna factor , cable loss and amplifier gain

Note 2: Margin (dB) = Emission level (dBuV/m) – Limit (dBuV/m).

Modulation	VHT40	Test Freq. (MHz)	5510
Polarization	Horizontal	Test Configuration	1

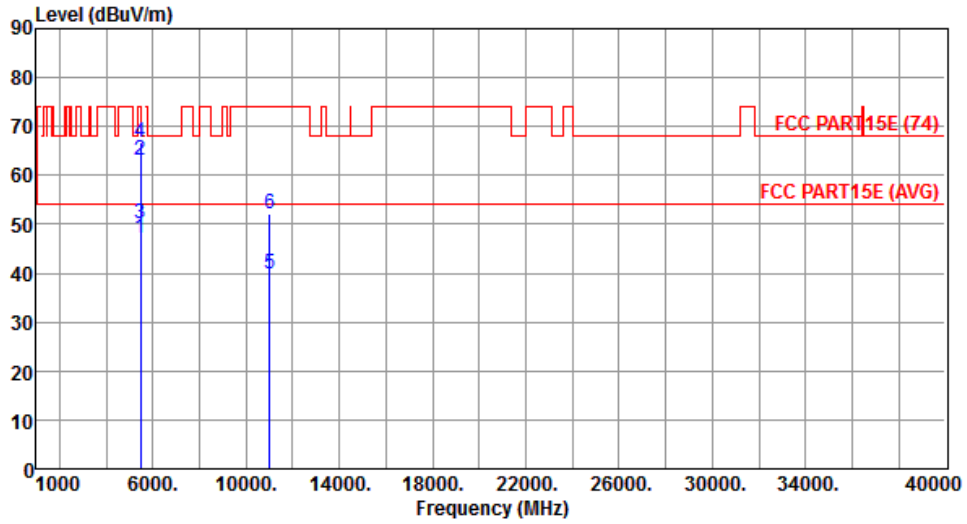

	Freq. MHz	Emission level dBuV/m	Limit dBuV/m	Margin dB	SA reading dBuV	Factor dB	Remark	ANT High cm	Turn Table deg
1	5460.00	47.18	54.00	-6.82	40.54	6.64	Average	256	33
2	5460.00	63.14	74.00	-10.86	56.50	6.64	Peak	256	33
3	5470.00	50.14	54.00	-3.86	43.49	6.65	Average	256	33
4	5470.00	66.63	74.00	-7.37	59.98	6.65	Peak	256	33
5	11020.00	39.95	54.00	-14.05	23.32	16.63	Average	268	155
6	11020.00	52.16	74.00	-21.84	35.53	16.63	Peak	268	155

Note 1: Emission Level (dBuV/m) = SA Reading (dBuV/m) + Factor* (dB)

*Factor includes antenna factor , cable loss and amplifier gain

Note 2: Margin (dB) = Emission level (dBuV/m) – Limit (dBuV/m).

Modulation	VHT40	Test Freq. (MHz)	5510
Polarization	Vertical	Test Configuration	1

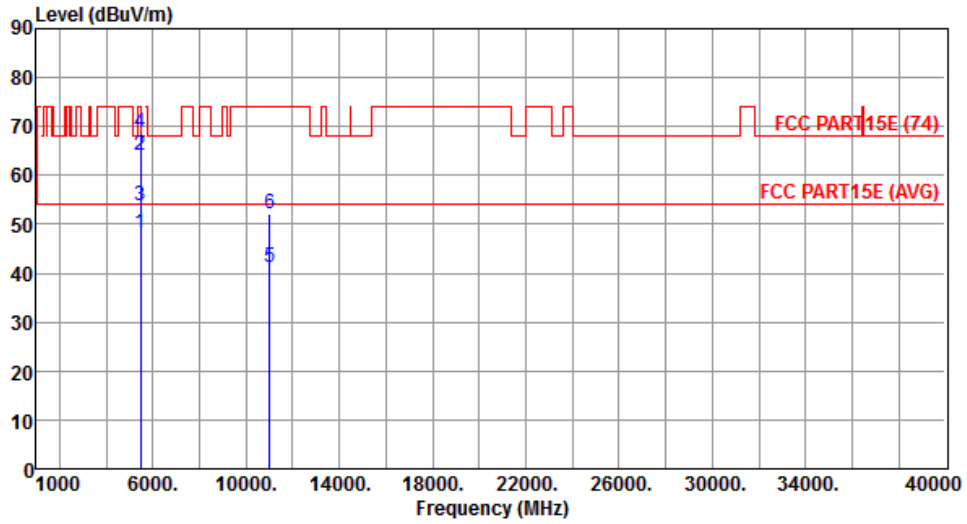

	Freq. MHz	Emission level dBuV/m	Limit dBuV/m	Margin dB	SA reading dBuV	Factor dB	Remark	ANT High cm	Turn Table deg
1	5460.00	48.04	54.00	-5.96	41.40	6.64	Average	258	256
2	5460.00	64.08	74.00	-9.92	57.44	6.64	Peak	258	256
3	5470.00	53.80	54.00	-0.20	47.15	6.65	Average	249	248
4	5470.00	68.75	74.00	-5.25	62.10	6.65	Peak	249	248
5	11020.00	41.11	54.00	-12.89	24.48	16.63	Average	271	319
6	11020.00	52.30	74.00	-21.70	35.67	16.63	Peak	271	319

Note 1: Emission Level (dBuV/m) = SA Reading (dBuV/m) + Factor* (dB)

*Factor includes antenna factor , cable loss and amplifier gain

Note 2: Margin (dB) = Emission level (dBuV/m) – Limit (dBuV/m).

Modulation	VHT40	Test Freq. (MHz)	5550
Polarization	Horizontal	Test Configuration	1

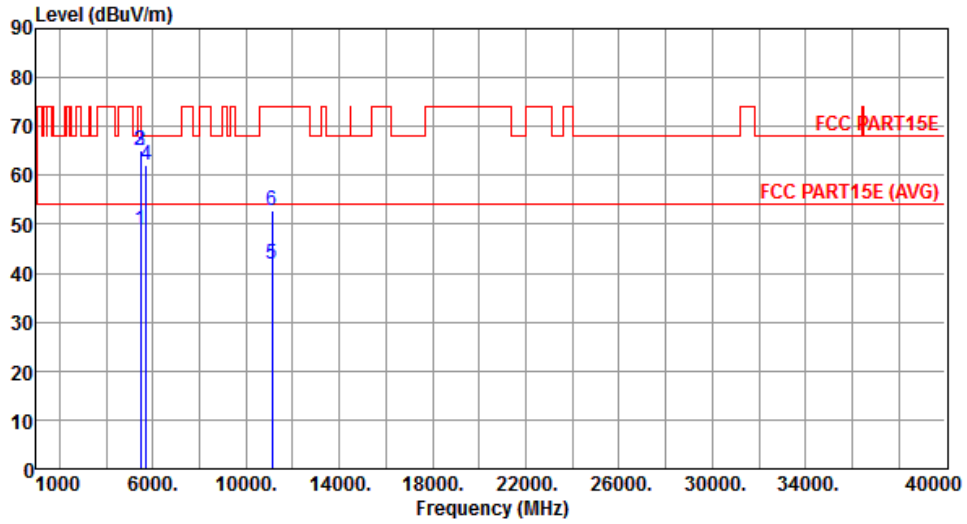

	Freq. MHz	Emission level dBuV/m	Limit dBuV/m	Margin dB	SA reading dBuV	Factor dB	Remark	ANT High cm	Turn Table deg
1	5460.00	48.74	54.00	-5.26	42.10	6.64	Average	274	31
2	5460.00	65.04	74.00	-8.96	58.40	6.64	Peak	274	31
3	5470.00	65.07	68.20	-3.13	58.42	6.65	Peak	274	31
4	5725.00	62.02	68.20	-6.18	54.89	7.13	Peak	274	31
5	11100.00	41.90	54.00	-12.10	25.24	16.66	Average	204	359
6	11100.00	52.67	74.00	-21.33	36.01	16.66	Peak	204	359

Note 1: Emission Level (dBuV/m) = SA Reading (dBuV/m) + Factor* (dB)

*Factor includes antenna factor , cable loss and amplifier gain

Note 2: Margin (dB) = Emission level (dBuV/m) – Limit (dBuV/m).

Modulation	VHT40	Test Freq. (MHz)	5550
Polarization	Vertical	Test Configuration	1

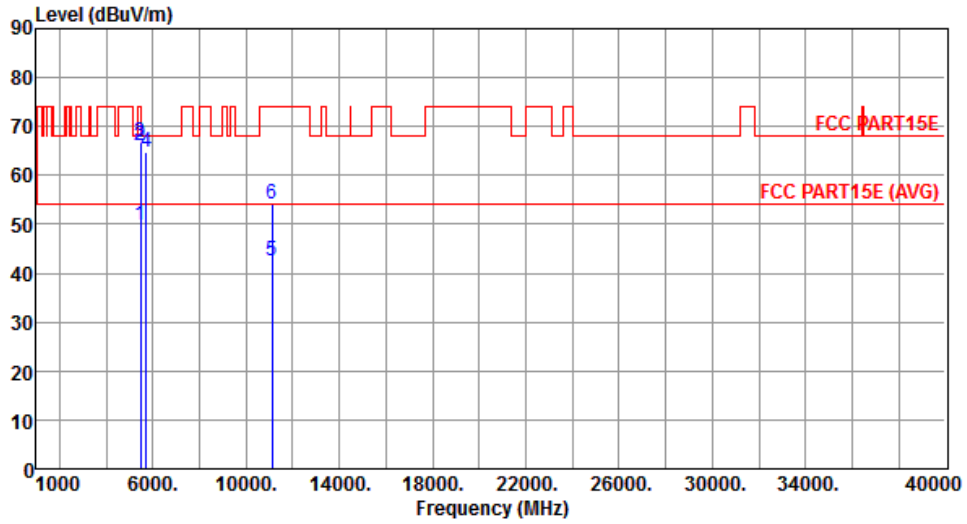

	Freq. MHz	Emission level dBuV/m	Limit dBuV/m	Margin dB	SA reading dBuV	Factor dB	Remark	ANT High cm	Turn Table deg
1	5460.00	49.84	54.00	-4.16	43.20	6.64	Average	238	256
2	5460.00	66.14	74.00	-7.86	59.50	6.64	Peak	238	256
3	5470.00	66.92	68.20	-1.28	60.27	6.65	Peak	238	256
4	5725.00	64.80	68.20	-3.40	57.67	7.13	Peak	231	259
5	11100.00	42.36	54.00	-11.64	25.70	16.66	Average	241	320
6	11100.00	54.24	74.00	-19.76	37.58	16.66	Peak	241	320

Note 1: Emission Level (dBuV/m) = SA Reading (dBuV/m) + Factor* (dB)

*Factor includes antenna factor , cable loss and amplifier gain

Note 2: Margin (dB) = Emission level (dBuV/m) – Limit (dBuV/m).

Modulation	VHT40	Test Freq. (MHz)	5670
Polarization	Horizontal	Test Configuration	1

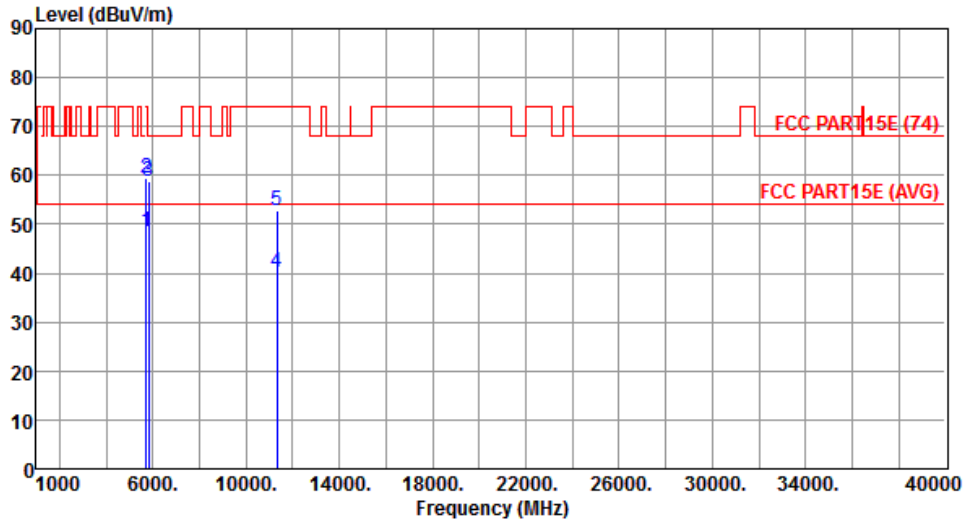

	Freq. MHz	Emission level dBuV/m	Limit dBuV/m	Margin dB	SA reading dBuV	Factor dB	Remark	ANT High cm	Turn Table deg
1	5725.00	48.47	54.00	-5.53	41.34	7.13	Average	311	25
2	5725.00	59.45	74.00	-14.55	52.32	7.13	Peak	311	25
3	5830.00	58.62	68.20	-9.58	51.25	7.37	Peak	309	251
4	11340.00	40.34	54.00	-13.66	23.60	16.74	Average	2241	159
5	11340.00	52.66	74.00	-21.34	35.92	16.74	Peak	2241	159

Note 1: Emission Level (dBuV/m) = SA Reading (dBuV/m) + Factor* (dB)

*Factor includes antenna factor , cable loss and amplifier gain

Note 2: Margin (dB) = Emission level (dBuV/m) – Limit (dBuV/m).

Modulation	VHT40	Test Freq. (MHz)	5670
Polarization	Vertical	Test Configuration	1

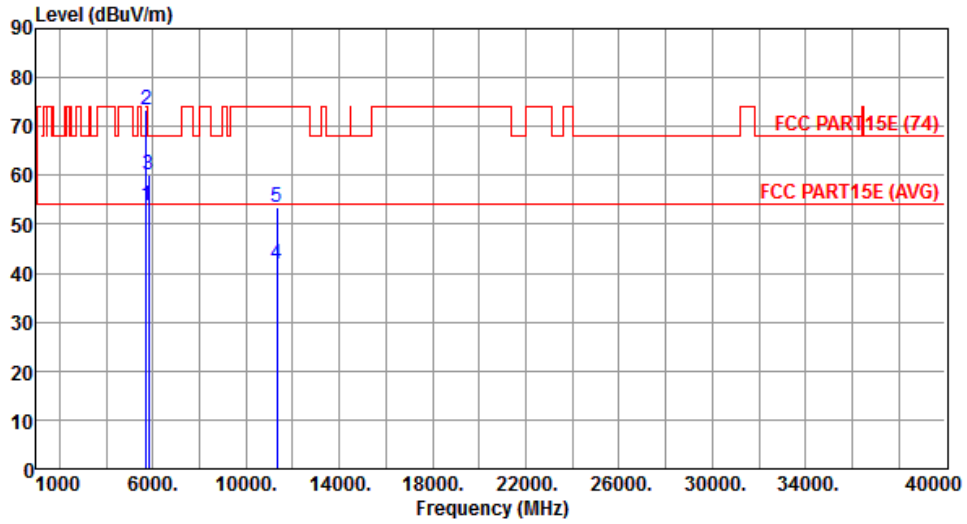

	Freq. MHz	Emission level dBuV/m	Limit dBuV/m	Margin dB	SA reading dBuV	Factor dB	Remark	ANT High cm	Turn Table deg
1	5725.00	53.90	54.00	-0.10	46.77	7.13	Average	274	249
2	5725.00	73.41	74.00	-0.59	66.28	7.13	Peak	274	249
3	5830.00	60.26	68.20	-7.94	52.89	7.37	Peak	229	252
4	11340.00	41.89	54.00	-12.11	25.15	16.74	Average	267	266
5	11340.00	53.45	74.00	-20.55	36.71	16.74	Peak	267	266

Note 1: Emission Level (dBuV/m) = SA Reading (dBuV/m) + Factor* (dB)

*Factor includes antenna factor , cable loss and amplifier gain

Note 2: Margin (dB) = Emission level (dBuV/m) – Limit (dBuV/m).

Modulation	VHT40	Test Freq. (MHz)	5710
Polarization	Horizontal	Test Configuration	1

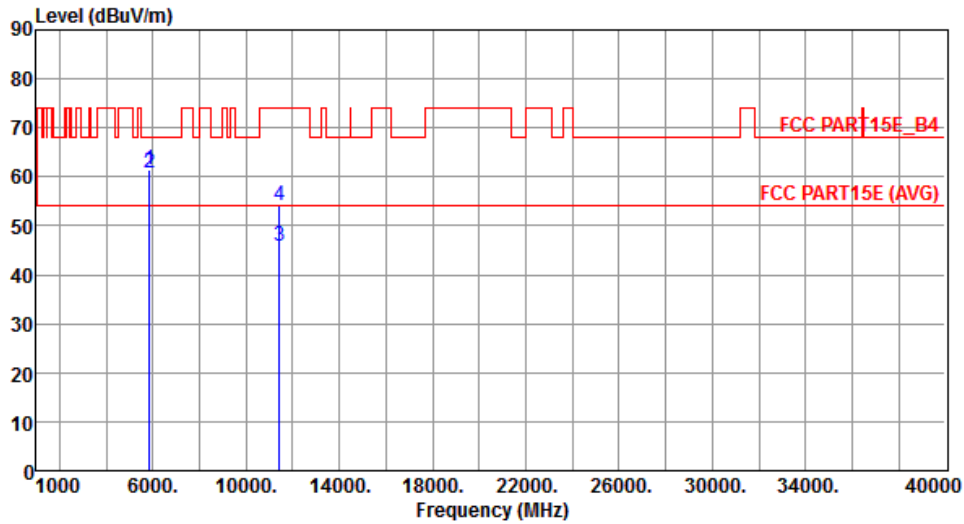

	Freq. MHz	Emission level dBuV/m	Limit dBuV/m	Margin dB	SA reading dBuV	Factor dB	Remark	ANT High cm	Turn Table deg
1	5850.00	61.50	78.20	-16.70	54.11	7.39	Peak	322	26
2	5860.00	60.89	68.20	-7.31	53.49	7.40	Peak	322	26
3	11420.00	45.76	54.00	-8.24	28.98	16.78	Average	240	217
4	11420.00	54.12	74.00	-19.88	37.34	16.78	Peak	240	217

Note 1: Emission Level (dBuV/m) = SA Reading (dBuV/m) + Factor* (dB)

*Factor includes antenna factor, cable loss and amplifier gain

Note 2: Margin (dB) = Emission level (dBuV/m) – Limit (dBuV/m).

Modulation	VHT40	Test Freq. (MHz)	5710
Polarization	Vertical	Test Configuration	1

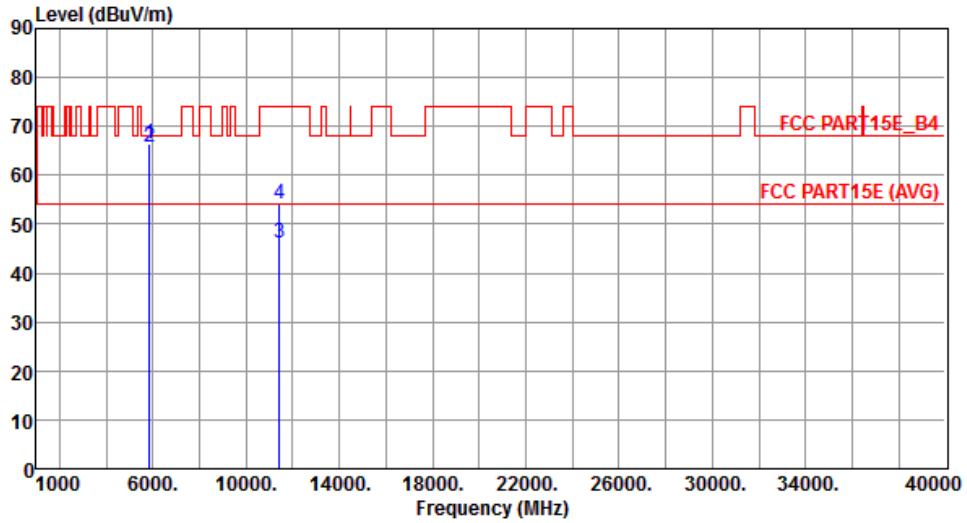

	Freq. MHz	Emission level dBuV/m	Limit dBuV/m	Margin dB	SA reading dBuV	Factor dB	Remark	ANT High cm	Turn Table deg
1	5850.00	66.38	78.20	-11.82	58.99	7.39	Peak	266	266
2	5860.00	65.63	68.20	-2.57	58.23	7.40	Peak	266	266
3	11420.00	46.18	54.00	-7.82	29.40	16.78	Average	219	327
4	11420.00	54.16	74.00	-19.84	37.38	16.78	Peak	219	327

Note 1: Emission Level (dBuV/m) = SA Reading (dBuV/m) + Factor* (dB)

*Factor includes antenna factor , cable loss and amplifier gain

Note 2: Margin (dB) = Emission level (dBuV/m) – Limit (dBuV/m).

3.5.8 Transmitter Radiated Unwanted Emissions (Above 1GHz) for VHT80

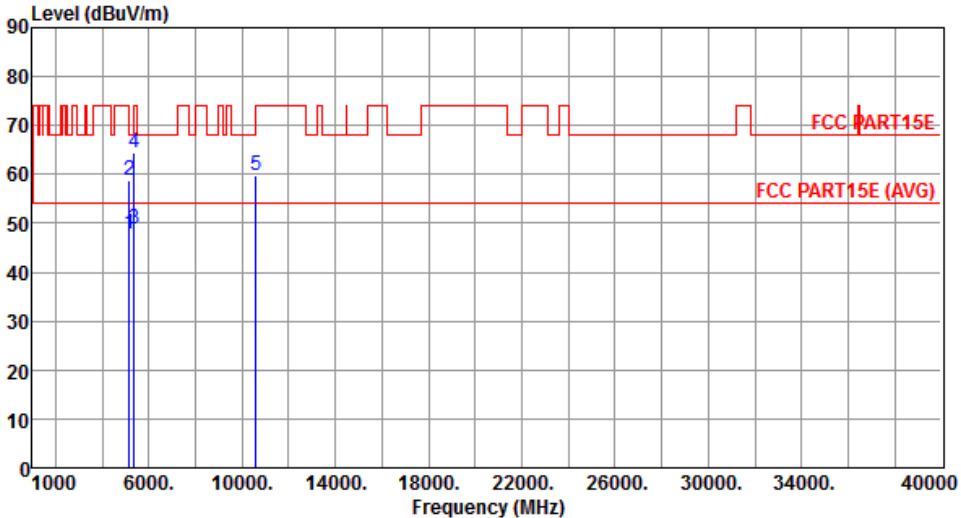
Modulation	VHT80	Test Freq. (MHz)	5290																																																																					
Polarization	Horizontal	Test Configuration	1																																																																					
																																																																								
	<table border="1"> <thead> <tr> <th>Freq.</th> <th>Emission level</th> <th>Limit</th> <th>Margin</th> <th>SA reading</th> <th>Factor</th> <th>Remark</th> <th>ANT High</th> <th>Turn Table</th> </tr> <tr> <th>MHz</th> <th>dBuV/m</th> <th>dBuV/m</th> <th>dB</th> <th>dBuV</th> <th>dB</th> <th></th> <th>cm</th> <th>deg</th> </tr> </thead> <tbody> <tr> <td>1</td> <td>5150.00</td> <td>47.79</td> <td>54.00</td> <td>-6.21</td> <td>41.60</td> <td>6.19</td> <td>Average</td> <td>236</td> <td>278</td> </tr> <tr> <td>2</td> <td>5150.00</td> <td>58.76</td> <td>74.00</td> <td>-15.24</td> <td>52.57</td> <td>6.19</td> <td>Peak</td> <td>236</td> <td>278</td> </tr> <tr> <td>3</td> <td>5350.00</td> <td>48.95</td> <td>54.00</td> <td>-5.05</td> <td>42.44</td> <td>6.51</td> <td>Average</td> <td>246</td> <td>18</td> </tr> <tr> <td>4</td> <td>5350.00</td> <td>64.44</td> <td>74.00</td> <td>-9.56</td> <td>57.93</td> <td>6.51</td> <td>Peak</td> <td>246</td> <td>18</td> </tr> <tr> <td>5</td> <td>10580.00</td> <td>59.93</td> <td>68.20</td> <td>-8.27</td> <td>43.42</td> <td>16.51</td> <td>Peak</td> <td>189</td> <td>56</td> </tr> </tbody> </table>	Freq.	Emission level	Limit	Margin	SA reading	Factor	Remark	ANT High	Turn Table	MHz	dBuV/m	dBuV/m	dB	dBuV	dB		cm	deg	1	5150.00	47.79	54.00	-6.21	41.60	6.19	Average	236	278	2	5150.00	58.76	74.00	-15.24	52.57	6.19	Peak	236	278	3	5350.00	48.95	54.00	-5.05	42.44	6.51	Average	246	18	4	5350.00	64.44	74.00	-9.56	57.93	6.51	Peak	246	18	5	10580.00	59.93	68.20	-8.27	43.42	16.51	Peak	189	56			
Freq.	Emission level	Limit	Margin	SA reading	Factor	Remark	ANT High	Turn Table																																																																
MHz	dBuV/m	dBuV/m	dB	dBuV	dB		cm	deg																																																																
1	5150.00	47.79	54.00	-6.21	41.60	6.19	Average	236	278																																																															
2	5150.00	58.76	74.00	-15.24	52.57	6.19	Peak	236	278																																																															
3	5350.00	48.95	54.00	-5.05	42.44	6.51	Average	246	18																																																															
4	5350.00	64.44	74.00	-9.56	57.93	6.51	Peak	246	18																																																															
5	10580.00	59.93	68.20	-8.27	43.42	16.51	Peak	189	56																																																															
<p>Note 1: Emission Level (dBuV/m) = SA Reading (dBuV/m) + Factor* (dB) *Factor includes antenna factor , cable loss and amplifier gain Note 2: Margin (dB) = Emission level (dBuV/m) – Limit (dBuV/m).</p>																																																																								

Modulation	VHT80	Test Freq. (MHz)	5290
Polarization	Vertical	Test Configuration	1

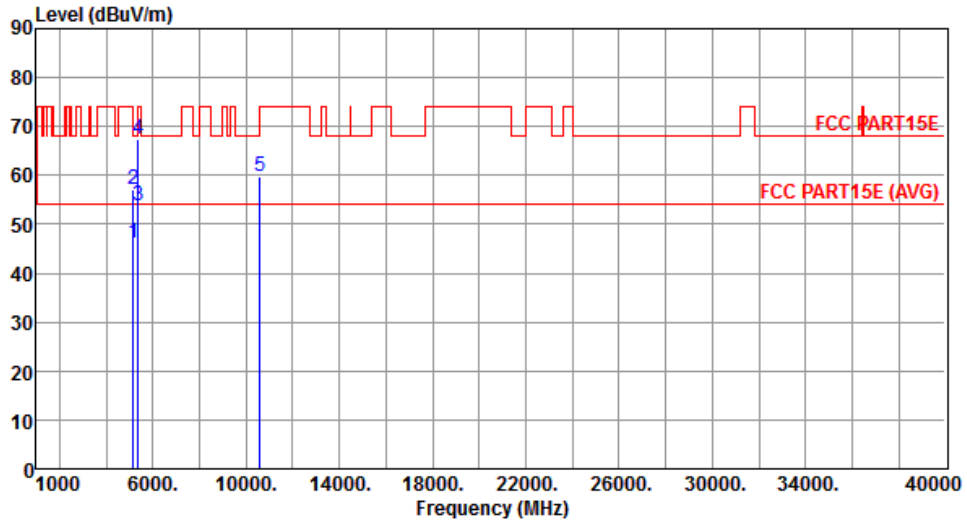

	Freq. MHz	Emission level dBuV/m	Limit dBuV/m	Margin dB	SA reading dBuV	Factor dB	Remark	ANT High cm	Turn Table deg
1	5150.00	46.05	54.00	-7.95	39.86	6.19	Average	235	237
2	5150.00	57.19	74.00	-16.81	51.00	6.19	Peak	235	237
3	5350.00	53.64	54.00	-0.36	47.13	6.51	Average	212	278
4	5350.00	67.49	74.00	-6.51	60.98	6.51	Peak	212	278
5	10580.00	59.64	68.20	-8.56	43.13	16.51	Peak	305	183

Note 1: Emission Level (dBuV/m) = SA Reading (dBuV/m) + Factor* (dB)

*Factor includes antenna factor , cable loss and amplifier gain

Note 2: Margin (dB) = Emission level (dBuV/m) – Limit (dBuV/m).

Modulation	VHT80	Test Freq. (MHz)	5530
Polarization	Horizontal	Test Configuration	1

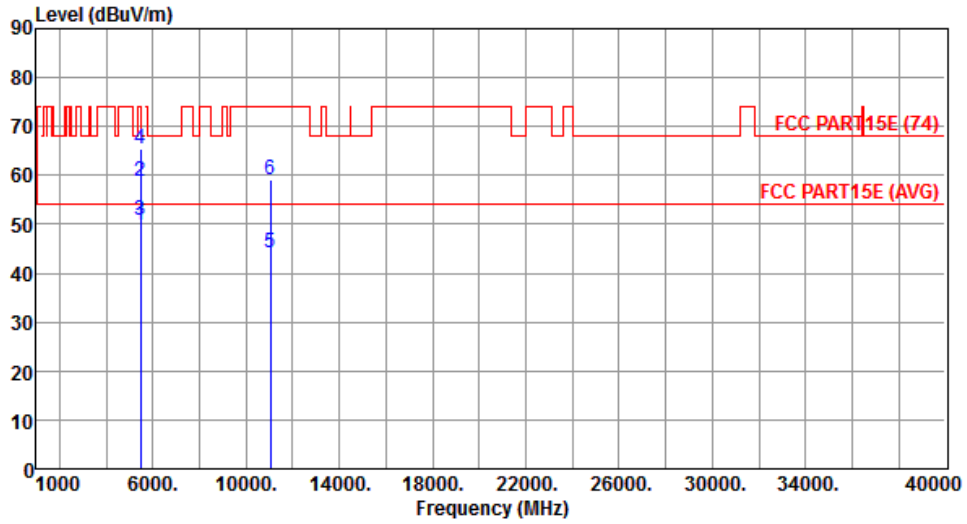

	Freq. MHz	Emission level dBuV/m	Limit dBuV/m	Margin dB	SA reading dBuV	Factor dB	Remark	ANT High cm	Turn Table deg
1	5460.00	49.94	54.00	-4.06	43.30	6.64	Average	235	196
2	5460.00	58.62	74.00	-15.38	51.98	6.64	Peak	235	196
3	5470.00	50.90	54.00	-3.10	44.25	6.65	Average	235	196
4	5470.00	65.52	74.00	-8.48	58.87	6.65	Peak	235	196
5	11060.00	44.24	54.00	-9.76	27.60	16.64	Average	278	145
6	11060.00	59.01	74.00	-14.99	42.37	16.64	Peak	278	145

Note 1: Emission Level (dBuV/m) = SA Reading (dBuV/m) + Factor* (dB)

*Factor includes antenna factor , cable loss and amplifier gain

Note 2: Margin (dB) = Emission level (dBuV/m) – Limit (dBuV/m).

Modulation	VHT80	Test Freq. (MHz)	5530
Polarization	Vertical	Test Configuration	1

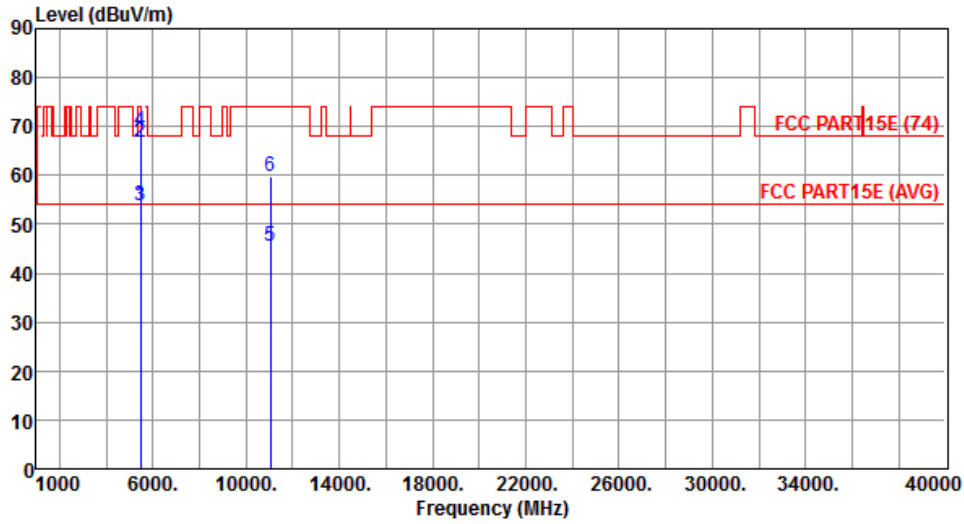

	Freq. MHz	Emission level dBuV/m	Limit dBuV/m	Margin dB	SA reading dBuV	Factor dB	Remark	ANT High cm	Turn Table deg
1	5460.00	53.86	54.00	-0.14	47.22	6.64	Average	246	249
2	5460.00	66.67	74.00	-7.33	60.03	6.64	Peak	246	249
3	5470.00	53.70	54.00	-0.30	47.05	6.65	Average	246	249
4	5470.00	69.02	74.00	-4.98	62.37	6.65	Peak	246	249
5	11060.00	45.54	54.00	-8.46	28.90	16.64	Average	246	265
6	11060.00	59.78	74.00	-14.22	43.14	16.64	Peak	246	265

Note 1: Emission Level (dBuV/m) = SA Reading (dBuV/m) + Factor* (dB)

*Factor includes antenna factor , cable loss and amplifier gain

Note 2: Margin (dB) = Emission level (dBuV/m) – Limit (dBuV/m).

Modulation	VHT80	Test Freq. (MHz)	5690
Polarization	Horizontal	Test Configuration	1

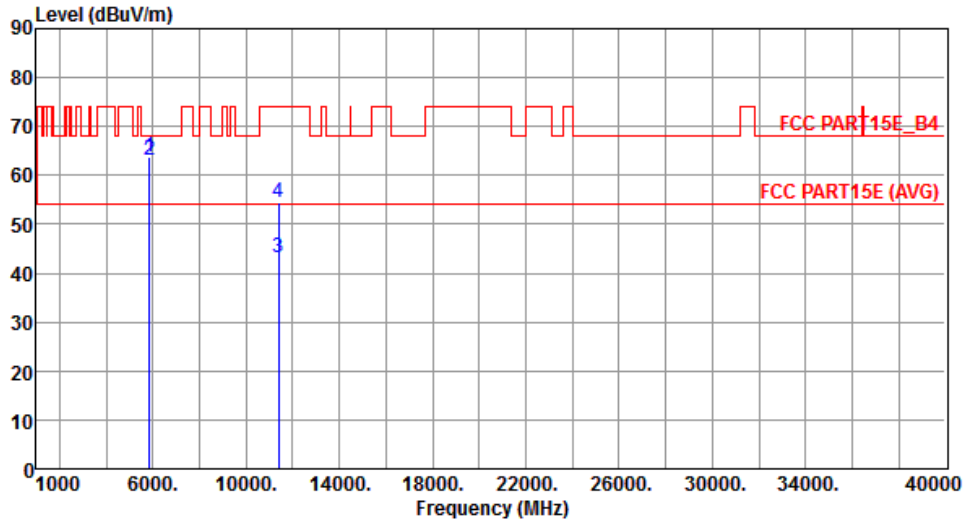

	Freq. MHz	Emission level dBuV/m	Limit dBuV/m	Margin dB	SA reading dBuV	Factor dB	Remark	ANT High cm	Turn Table deg
1	5850.00	63.62	78.20	-14.58	56.23	7.39	Peak	316	27
2	5860.00	62.96	68.20	-5.24	55.56	7.40	Peak	316	27
3	11380.00	43.26	54.00	-10.74	26.50	16.76	Average	200	147
4	11380.00	54.37	74.00	-19.63	37.61	16.76	Peak	200	147

Note 1: Emission Level (dBuV/m) = SA Reading (dBuV/m) + Factor* (dB)

*Factor includes antenna factor , cable loss and amplifier gain

Note 2: Margin (dB) = Emission level (dBuV/m) – Limit (dBuV/m).

Modulation	VHT80	Test Freq. (MHz)	5690
Polarization	Vertical	Test Configuration	1

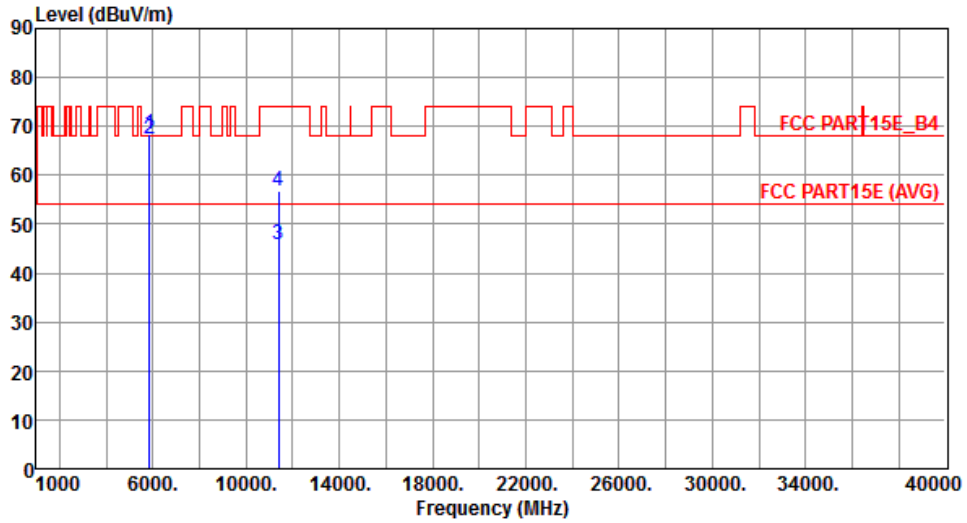

	Freq. MHz	Emission level dBuV/m	Limit dBuV/m	Margin dB	SA reading dBuV	Factor dB	Remark	ANT High cm	Turn Table deg
1	5850.00	68.55	78.20	-9.65	61.16	7.39	Peak	226	259
2	5860.00	67.53	68.20	-0.67	60.13	7.40	Peak	226	259
3	11380.00	45.67	54.00	-8.33	28.91	16.76	Average	319	257
4	11380.00	56.71	74.00	-17.29	39.95	16.76	Peak	319	257

Note 1: Emission Level (dBuV/m) = SA Reading (dBuV/m) + Factor* (dB)

*Factor includes antenna factor , cable loss and amplifier gain

Note 2: Margin (dB) = Emission level (dBuV/m) – Limit (dBuV/m).

Beamforming mode

3.5.9 Transmitter Radiated Unwanted Emissions (Below 1GHz)

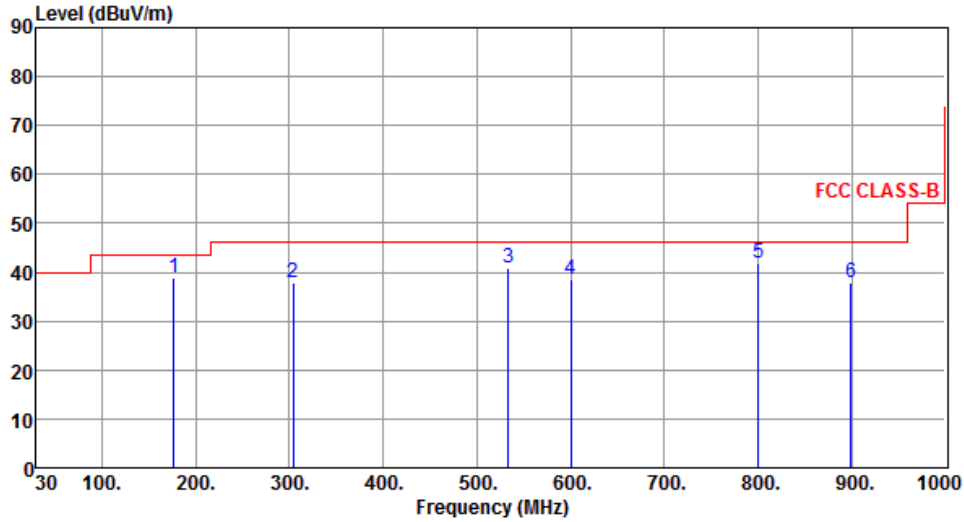
Modulation	VHT40	Test Freq. (MHz)	5270																																																															
Polarization	Horizontal	Test Configuration	3																																																															
 <p>The graph plots Level (dBuV/m) on the y-axis (0 to 90) against Frequency (MHz) on the x-axis (30 to 1000). A red line represents the FCC CLASS-B limit, which is 40 dBuV/m from 30 to 100 MHz, 45 dBuV/m from 100 to 300 MHz, 50 dBuV/m from 300 to 900 MHz, and 55 dBuV/m from 900 to 1000 MHz. Six blue vertical lines indicate emission peaks labeled 1 through 6, with their corresponding data listed in the table below.</p>																																																																		
	<table border="1"> <thead> <tr> <th>Freq. MHz</th> <th>Emission level dBuV/m</th> <th>Limit dBuV/m</th> <th>Margin dB</th> <th>SA reading dBuV</th> <th>Factor dB</th> <th>Remark</th> <th>ANT High cm</th> <th>Turn Table deg</th> </tr> </thead> <tbody> <tr> <td>1</td> <td>176.35</td> <td>38.77</td> <td>43.50</td> <td>-4.73</td> <td>53.61</td> <td>-14.84</td> <td>Peak</td> <td>---</td> </tr> <tr> <td>2</td> <td>304.28</td> <td>37.90</td> <td>46.00</td> <td>-8.10</td> <td>50.44</td> <td>-12.54</td> <td>Peak</td> <td>---</td> </tr> <tr> <td>3</td> <td>533.27</td> <td>40.99</td> <td>46.00</td> <td>-5.01</td> <td>48.25</td> <td>-7.26</td> <td>Peak</td> <td>---</td> </tr> <tr> <td>4</td> <td>600.26</td> <td>38.63</td> <td>46.00</td> <td>-7.37</td> <td>44.35</td> <td>-5.72</td> <td>Peak</td> <td>---</td> </tr> <tr> <td>5</td> <td>800.18</td> <td>41.77</td> <td>46.00</td> <td>-4.23</td> <td>44.33</td> <td>-2.56</td> <td>Peak</td> <td>---</td> </tr> <tr> <td>6</td> <td>899.57</td> <td>37.97</td> <td>46.00</td> <td>-8.03</td> <td>38.65</td> <td>-0.68</td> <td>Peak</td> <td>---</td> </tr> </tbody> </table>	Freq. MHz	Emission level dBuV/m	Limit dBuV/m	Margin dB	SA reading dBuV	Factor dB	Remark	ANT High cm	Turn Table deg	1	176.35	38.77	43.50	-4.73	53.61	-14.84	Peak	---	2	304.28	37.90	46.00	-8.10	50.44	-12.54	Peak	---	3	533.27	40.99	46.00	-5.01	48.25	-7.26	Peak	---	4	600.26	38.63	46.00	-7.37	44.35	-5.72	Peak	---	5	800.18	41.77	46.00	-4.23	44.33	-2.56	Peak	---	6	899.57	37.97	46.00	-8.03	38.65	-0.68	Peak	---		
Freq. MHz	Emission level dBuV/m	Limit dBuV/m	Margin dB	SA reading dBuV	Factor dB	Remark	ANT High cm	Turn Table deg																																																										
1	176.35	38.77	43.50	-4.73	53.61	-14.84	Peak	---																																																										
2	304.28	37.90	46.00	-8.10	50.44	-12.54	Peak	---																																																										
3	533.27	40.99	46.00	-5.01	48.25	-7.26	Peak	---																																																										
4	600.26	38.63	46.00	-7.37	44.35	-5.72	Peak	---																																																										
5	800.18	41.77	46.00	-4.23	44.33	-2.56	Peak	---																																																										
6	899.57	37.97	46.00	-8.03	38.65	-0.68	Peak	---																																																										
<p>Note 1: Emission Level (dBuV/m) = SA Reading (dBuV/m) + Factor* (dB) *Factor includes antenna factor , cable loss and amplifier gain Note 2: Margin (dB) = Emission level (dBuV/m) – Limit (dBuV/m). Note 3: All spurious emissions below 30MHz are more than 20 dB below the limit.</p>																																																																		

Modulation	VHT40	Test Freq. (MHz)	5270
Polarization	Vertical	Test Configuration	3

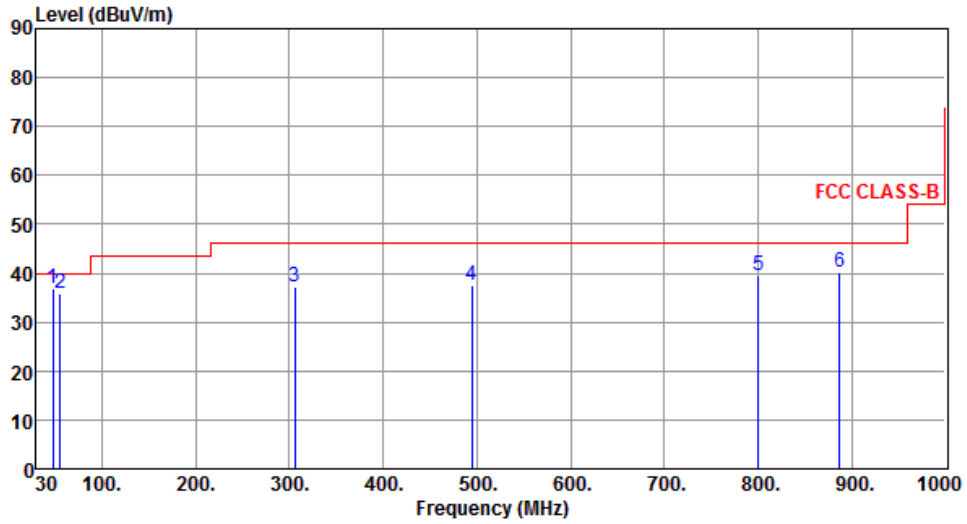

	Freq. MHz	Emission level dBuV/m	Limit dBuV/m	Margin dB	SA reading dBuV	Factor dB	Remark	ANT High cm	Turn Table deg
1	47.64	36.77	40.00	-3.23	49.66	-12.89	QP	---	---
2	55.42	36.00	40.00	-4.00	49.67	-13.67	QP	---	---
3	305.41	37.14	46.00	-8.86	49.65	-12.51	Peak	---	---
4	494.96	37.47	46.00	-8.53	45.23	-7.76	Peak	---	---
5	800.18	39.65	46.00	-6.35	42.21	-2.56	Peak	---	---
6	886.75	40.21	46.00	-5.79	41.16	-0.95	Peak	---	---

Note 1: Emission Level (dBuV/m) = SA Reading (dBuV/m) + Factor* (dB)

*Factor includes antenna factor , cable loss and amplifier gain

Note 2: Margin (dB) = Emission level (dBuV/m) – Limit (dBuV/m).

Note 3: All spurious emissions below 30MHz are more than 20 dB below the limit.

Modulation	VHT40	Test Freq. (MHz)	5270
Polarization	Horizontal	Test Configuration	4

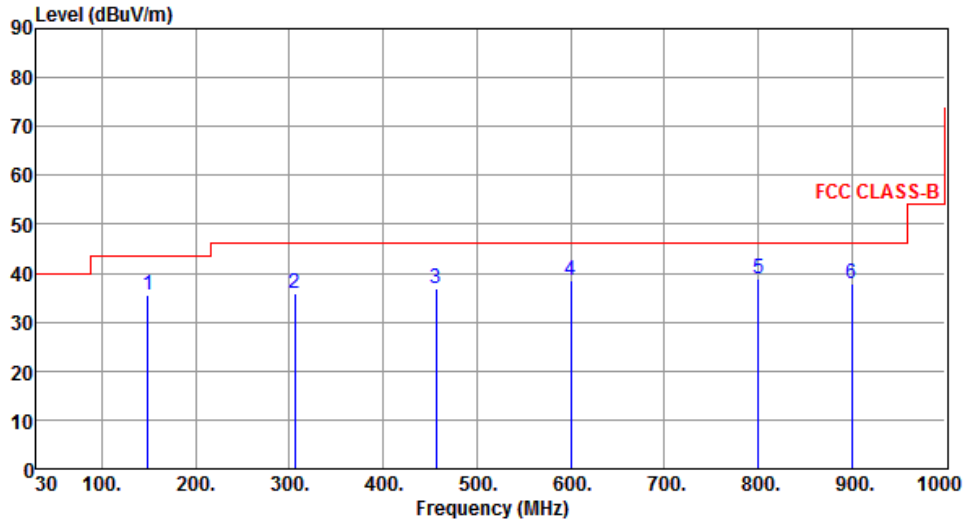

	Freq. MHz	Emission level dBuV/m	Limit dBuV/m	Margin dB	SA reading dBuV	Factor dB	Remark	ANT High cm	Turn Table deg
1	148.65	35.46	43.50	-8.04	48.92	-13.46	Peak	---	---
2	305.42	35.71	46.00	-10.29	48.22	-12.51	Peak	---	---
3	456.25	36.85	46.00	-9.15	45.48	-8.63	Peak	---	---
4	600.18	38.59	46.00	-7.41	44.31	-5.72	Peak	---	---
5	800.18	38.86	46.00	-7.14	41.42	-2.56	Peak	---	---
6	899.93	37.80	46.00	-8.20	38.47	-0.67	Peak	---	---

Note 1: Emission Level (dBuV/m) = SA Reading (dBuV/m) + Factor* (dB)

*Factor includes antenna factor , cable loss and amplifier gain

Note 2: Margin (dB) = Emission level (dBuV/m) – Limit (dBuV/m).

Note 3: All spurious emissions below 30MHz are more than 20 dB below the limit.

Modulation	VHT40	Test Freq. (MHz)	5270
Polarization	Vertical	Test Configuration	4

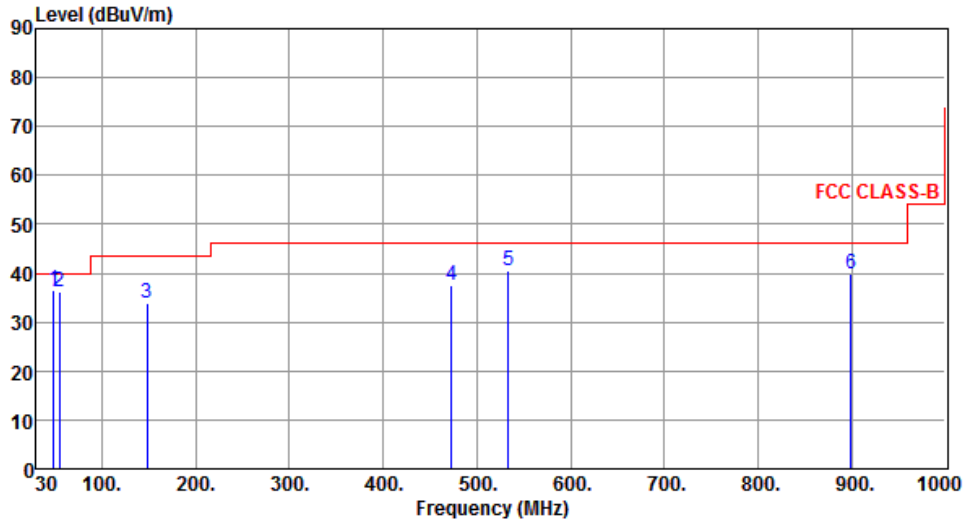

	Freq. MHz	Emission level dBuV/m	Limit dBuV/m	Margin dB	SA reading dBuV	Factor dB	Remark	ANT High cm	Turn Table deg
1	48.65	36.41	40.00	-3.59	49.33	-12.92	QP	---	---
2	54.42	36.10	40.00	-3.90	49.64	-13.54	QP	---	---
3	148.25	33.97	43.50	-9.53	47.44	-13.47	Peak	---	---
4	473.38	37.42	46.00	-8.58	45.66	-8.24	Peak	---	---
5	533.48	40.37	46.00	-5.63	47.63	-7.26	Peak	---	---
6	899.38	39.80	46.00	-6.20	40.48	-0.68	Peak	---	---

Note 1: Emission Level (dBuV/m) = SA Reading (dBuV/m) + Factor* (dB)

*Factor includes antenna factor , cable loss and amplifier gain

Note 2: Margin (dB) = Emission level (dBuV/m) – Limit (dBuV/m).

Note 3: All spurious emissions below 30MHz are more than 20 dB below the limit.

3.5.10 Transmitter Radiated Unwanted Emissions (Above 1GHz) for VHT20

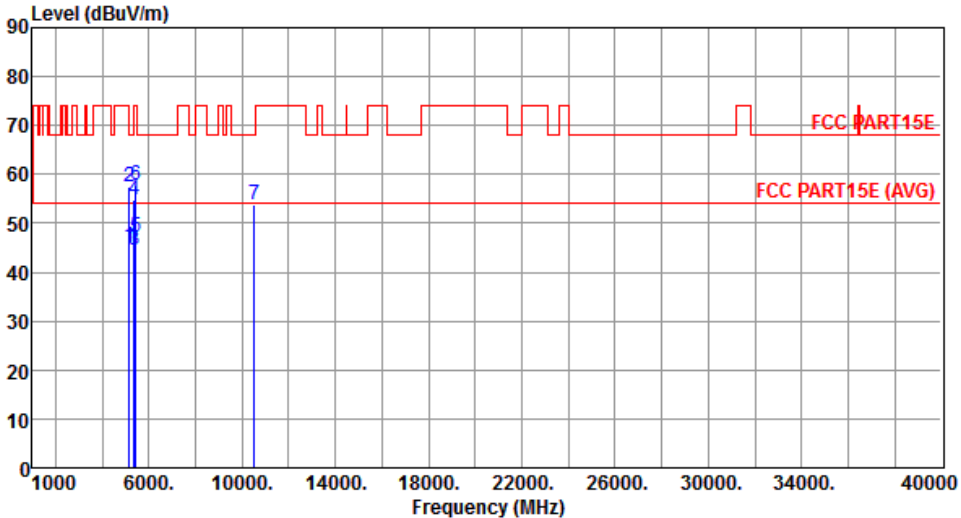
Modulation	VHT20	Test Freq. (MHz)	5260																																																																																									
Polarization	Horizontal	Test Configuration	3																																																																																									
																																																																																												
	<table border="1"> <thead> <tr> <th>Freq.</th> <th>Emission level</th> <th>Limit</th> <th>Margin</th> <th>SA reading</th> <th>Factor</th> <th>Remark</th> <th>ANT High</th> <th>Turn Table</th> </tr> <tr> <th>MHz</th> <th>dBuV/m</th> <th>dBuV/m</th> <th>dB</th> <th>dBuV</th> <th>dB</th> <th></th> <th>cm</th> <th>deg</th> </tr> </thead> <tbody> <tr> <td>1</td> <td>5150.00</td> <td>45.16</td> <td>54.00</td> <td>-8.84</td> <td>38.58</td> <td>6.58</td> <td>Average</td> <td>236</td> <td>41</td> </tr> <tr> <td>2</td> <td>5150.00</td> <td>57.56</td> <td>74.00</td> <td>-16.44</td> <td>50.98</td> <td>6.58</td> <td>Peak</td> <td>236</td> <td>41</td> </tr> <tr> <td>3</td> <td>5350.00</td> <td>44.36</td> <td>54.00</td> <td>-9.64</td> <td>37.33</td> <td>7.03</td> <td>Average</td> <td>238</td> <td>41</td> </tr> <tr> <td>4</td> <td>5350.00</td> <td>54.81</td> <td>74.00</td> <td>-19.19</td> <td>47.78</td> <td>7.03</td> <td>Peak</td> <td>238</td> <td>41</td> </tr> <tr> <td>5</td> <td>5420.00</td> <td>47.22</td> <td>54.00</td> <td>-6.78</td> <td>40.08</td> <td>7.14</td> <td>Average</td> <td>280</td> <td>44</td> </tr> <tr> <td>6</td> <td>5420.00</td> <td>57.65</td> <td>74.00</td> <td>-16.35</td> <td>50.51</td> <td>7.14</td> <td>Peak</td> <td>280</td> <td>44</td> </tr> <tr> <td>7</td> <td>10520.00</td> <td>53.92</td> <td>68.20</td> <td>-14.28</td> <td>37.20</td> <td>16.72</td> <td>Peak</td> <td>256</td> <td>302</td> </tr> </tbody> </table>	Freq.	Emission level	Limit	Margin	SA reading	Factor	Remark	ANT High	Turn Table	MHz	dBuV/m	dBuV/m	dB	dBuV	dB		cm	deg	1	5150.00	45.16	54.00	-8.84	38.58	6.58	Average	236	41	2	5150.00	57.56	74.00	-16.44	50.98	6.58	Peak	236	41	3	5350.00	44.36	54.00	-9.64	37.33	7.03	Average	238	41	4	5350.00	54.81	74.00	-19.19	47.78	7.03	Peak	238	41	5	5420.00	47.22	54.00	-6.78	40.08	7.14	Average	280	44	6	5420.00	57.65	74.00	-16.35	50.51	7.14	Peak	280	44	7	10520.00	53.92	68.20	-14.28	37.20	16.72	Peak	256	302			
Freq.	Emission level	Limit	Margin	SA reading	Factor	Remark	ANT High	Turn Table																																																																																				
MHz	dBuV/m	dBuV/m	dB	dBuV	dB		cm	deg																																																																																				
1	5150.00	45.16	54.00	-8.84	38.58	6.58	Average	236	41																																																																																			
2	5150.00	57.56	74.00	-16.44	50.98	6.58	Peak	236	41																																																																																			
3	5350.00	44.36	54.00	-9.64	37.33	7.03	Average	238	41																																																																																			
4	5350.00	54.81	74.00	-19.19	47.78	7.03	Peak	238	41																																																																																			
5	5420.00	47.22	54.00	-6.78	40.08	7.14	Average	280	44																																																																																			
6	5420.00	57.65	74.00	-16.35	50.51	7.14	Peak	280	44																																																																																			
7	10520.00	53.92	68.20	-14.28	37.20	16.72	Peak	256	302																																																																																			
<p>Note 1: Emission Level (dBuV/m) = SA Reading (dBuV/m) + Factor* (dB) *Factor includes antenna factor , cable loss and amplifier gain Note 2: Margin (dB) = Emission level (dBuV/m) – Limit (dBuV/m).</p>																																																																																												

Modulation	VHT20	Test Freq. (MHz)	5260
Polarization	Vertical	Test Configuration	3

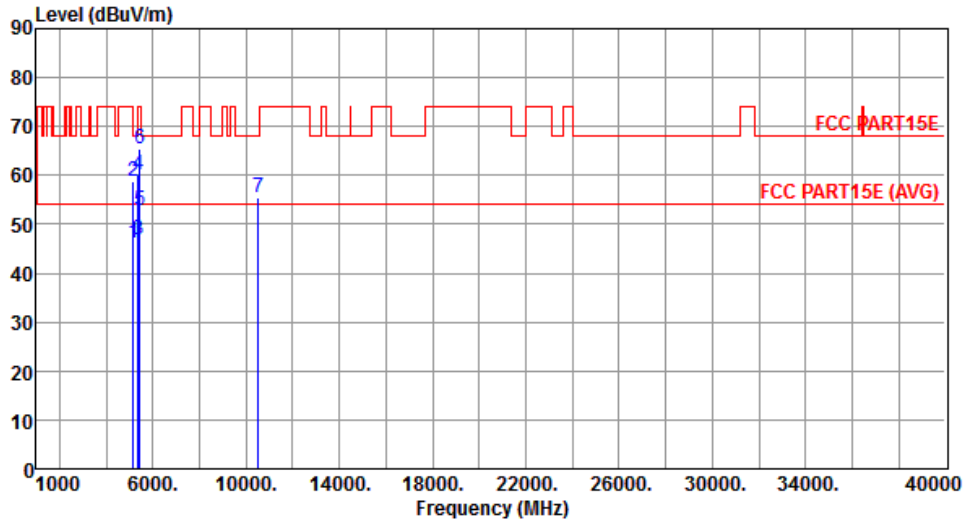

	Freq. MHz	Emission level dBuV/m	Limit dBuV/m	Margin dB	SA reading dBuV	Factor dB	Remark	ANT High cm	Turn Table deg
1	5150.00	46.04	54.00	-7.96	39.46	6.58	Average	274	283
2	5150.00	58.95	74.00	-15.05	52.37	6.58	Peak	274	283
3	5350.00	46.79	54.00	-7.21	39.76	7.03	Average	275	288
4	5350.00	59.99	74.00	-14.01	52.96	7.03	Peak	275	288
5	5420.00	52.96	54.00	-1.04	45.82	7.14	Average	245	284
6	5420.00	65.46	74.00	-8.54	58.32	7.14	Peak	245	284
7	10520.00	55.39	68.20	-12.81	38.67	16.72	Peak	169	158

Note 1: Emission Level (dBuV/m) = SA Reading (dBuV/m) + Factor* (dB)

*Factor includes antenna factor , cable loss and amplifier gain

Note 2: Margin (dB) = Emission level (dBuV/m) – Limit (dBuV/m).

Modulation	VHT20	Test Freq. (MHz)	5300
Polarization	Horizontal	Test Configuration	3

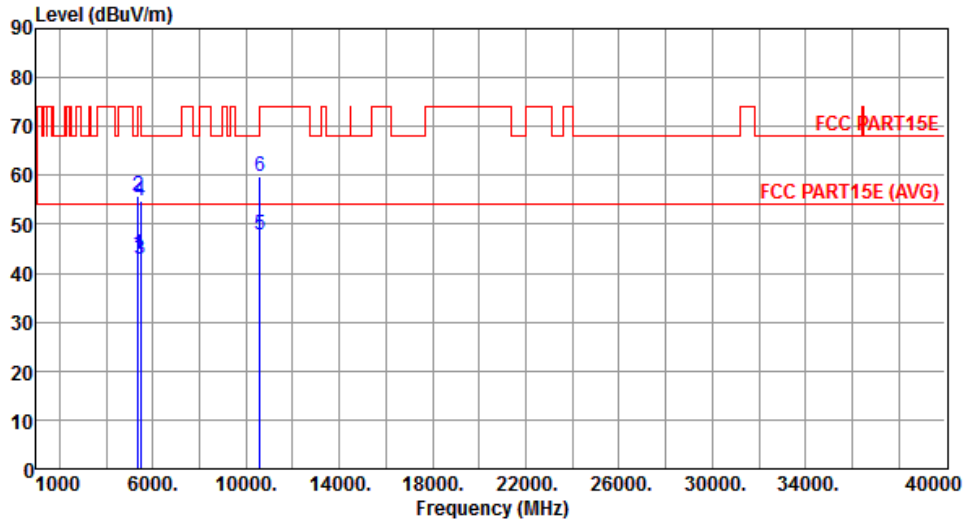

	Freq. MHz	Emission level dBuV/m	Limit dBuV/m	Margin dB	SA reading dBuV	Factor dB	Remark	ANT High cm	Turn Table deg
1	5350.00	43.85	54.00	-10.15	36.82	7.03	Average	235	36
2	5350.00	55.86	74.00	-18.14	48.83	7.03	Peak	235	36
3	5460.00	42.96	54.00	-11.04	35.82	7.14	Average	240	25
4	5460.00	54.88	74.00	-19.12	47.74	7.14	Peak	240	25
5	10600.00	47.81	54.00	-6.19	31.02	16.79	Average	276	225
6	10600.00	59.69	74.00	-14.31	42.90	16.79	Peak	276	225

Note 1: Emission Level (dBuV/m) = SA Reading (dBuV/m) + Factor* (dB)

*Factor includes antenna factor , cable loss and amplifier gain

Note 2: Margin (dB) = Emission level (dBuV/m) – Limit (dBuV/m).

Modulation	VHT20	Test Freq. (MHz)	5300
Polarization	Vertical	Test Configuration	3

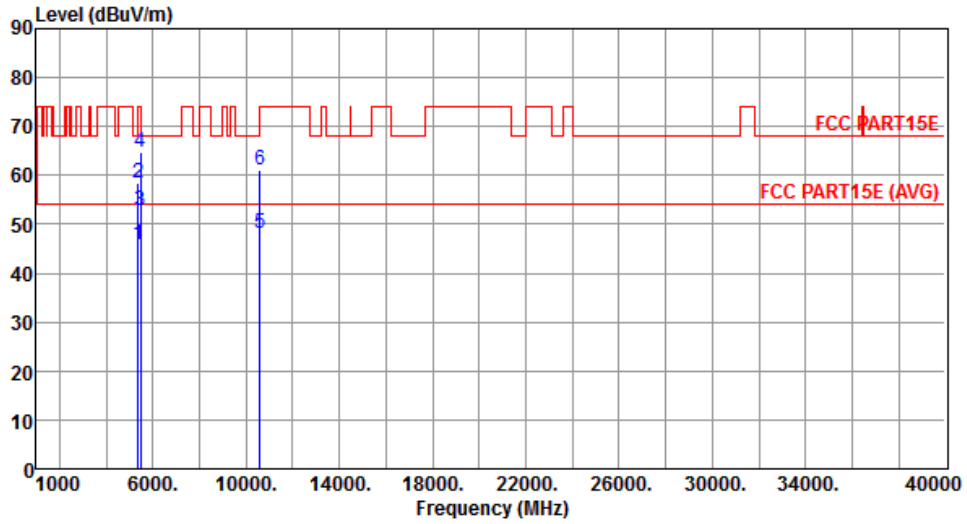

	Freq. MHz	Emission level dBuV/m	Limit dBuV/m	Margin dB	SA reading dBuV	Factor dB	Remark	ANT High cm	Turn Table deg
1	5350.00	45.69	54.00	-8.31	38.66	7.03	Average	241	285
2	5350.00	58.44	74.00	-15.56	51.41	7.03	Peak	241	285
3	5460.00	52.94	54.00	-1.06	45.80	7.14	Average	241	285
4	5460.00	64.79	74.00	-9.21	57.65	7.14	Peak	241	285
5	10600.00	48.14	54.00	-5.86	31.35	16.79	Average	262	291
6	10600.00	60.95	74.00	-13.05	44.16	16.79	Peak	262	291

Note 1: Emission Level (dBuV/m) = SA Reading (dBuV/m) + Factor* (dB)

*Factor includes antenna factor , cable loss and amplifier gain

Note 2: Margin (dB) = Emission level (dBuV/m) – Limit (dBuV/m).

Modulation	VHT20	Test Freq. (MHz)	5320
Polarization	Horizontal	Test Configuration	3

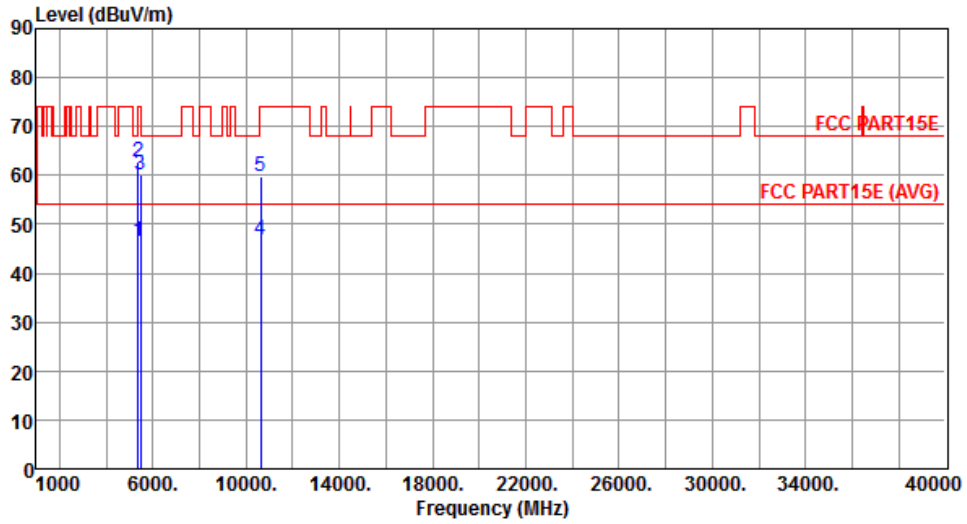

	Freq. MHz	Emission level dBuV/m	Limit dBuV/m	Margin dB	SA reading dBuV	Factor dB	Remark	ANT High cm	Turn Table deg
1	5350.00	46.65	54.00	-7.35	39.62	7.03	Average	235	52
2	5350.00	62.81	74.00	-11.19	55.78	7.03	Peak	235	52
3	5480.00	60.24	68.20	-7.96	53.10	7.14	Peak	239	88
4	10640.00	46.84	54.00	-7.16	30.02	16.82	Average	255	321
5	10640.00	59.85	74.00	-14.15	43.03	16.82	Peak	255	321

Note 1: Emission Level (dBuV/m) = SA Reading (dBuV/m) + Factor* (dB)

*Factor includes antenna factor , cable loss and amplifier gain

Note 2: Margin (dB) = Emission level (dBuV/m) – Limit (dBuV/m).

Modulation	VHT20	Test Freq. (MHz)	5320
Polarization	Vertical	Test Configuration	3

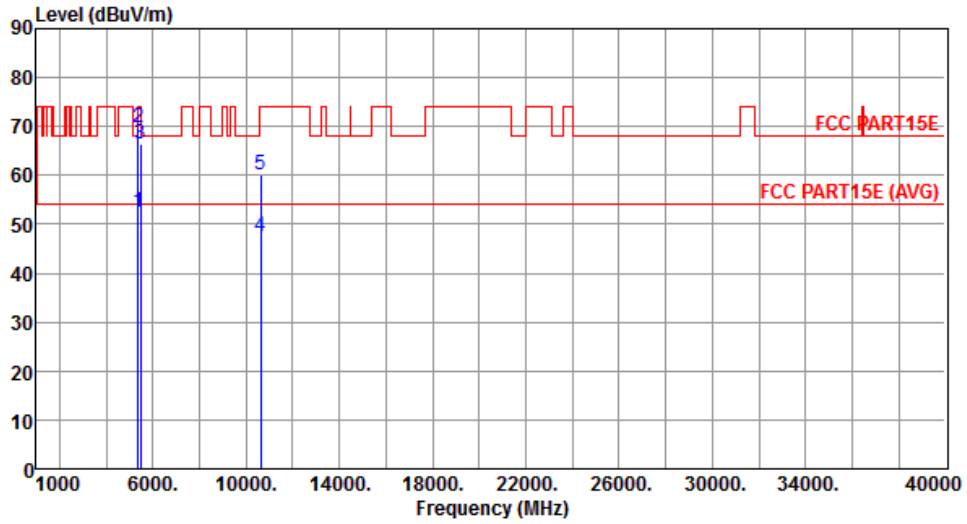

	Freq. MHz	Emission level dBuV/m	Limit dBuV/m	Margin dB	SA reading dBuV	Factor dB	Remark	ANT High cm	Turn Table deg
1	5350.00	52.54	54.00	-1.46	45.51	7.03	Average	232	278
2	5350.00	69.68	74.00	-4.32	62.65	7.03	Peak	232	278
3	5480.00	66.26	68.20	-1.94	59.12	7.14	Peak	256	288
4	10640.00	47.45	54.00	-6.55	30.63	16.82	Average	286	129
5	10640.00	60.22	74.00	-13.78	43.40	16.82	Peak	286	129

Note 1: Emission Level (dBuV/m) = SA Reading (dBuV/m) + Factor* (dB)

*Factor includes antenna factor , cable loss and amplifier gain

Note 2: Margin (dB) = Emission level (dBuV/m) – Limit (dBuV/m).

Modulation	VHT20	Test Freq. (MHz)	5500
Polarization	Horizontal	Test Configuration	3

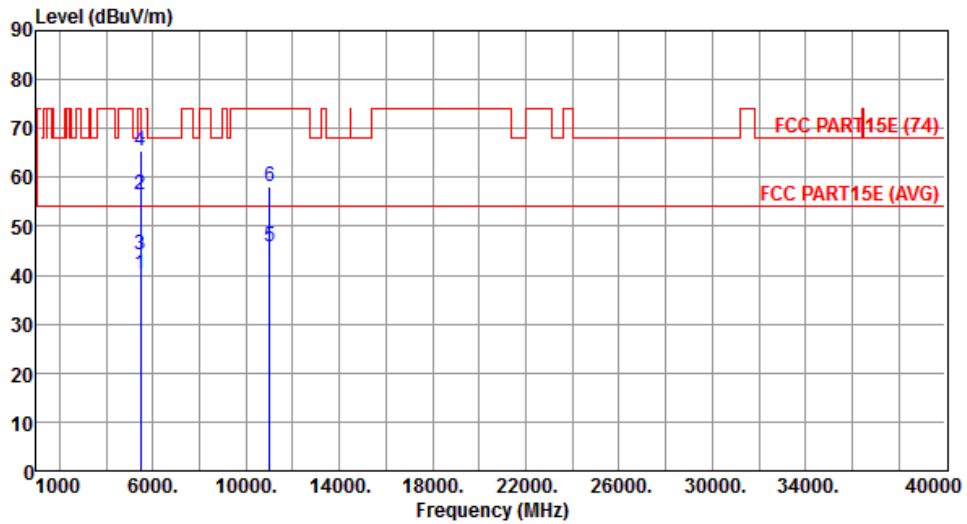

	Freq. MHz	Emission level dBuV/m	Limit dBuV/m	Margin dB	SA reading dBuV	Factor dB	Remark	ANT High cm	Turn Table deg
1	5460.00	40.25	54.00	-13.75	33.11	7.14	Average	236	50
2	5460.00	56.52	74.00	-17.48	49.38	7.14	Peak	236	50
3	5470.00	44.26	54.00	-9.74	37.11	7.15	Average	236	50
4	5470.00	65.31	74.00	-8.69	58.16	7.15	Peak	236	50
5	11000.00	45.96	54.00	-8.04	28.85	17.11	Average	220	195
6	11000.00	58.04	74.00	-15.96	40.93	17.11	Peak	220	195

Note 1: Emission Level (dBuV/m) = SA Reading (dBuV/m) + Factor* (dB)

*Factor includes antenna factor, cable loss and amplifier gain

Note 2: Margin (dB) = Emission level (dBuV/m) – Limit (dBuV/m).

Modulation	VHT20	Test Freq. (MHz)	5500
Polarization	Vertical	Test Configuration	3

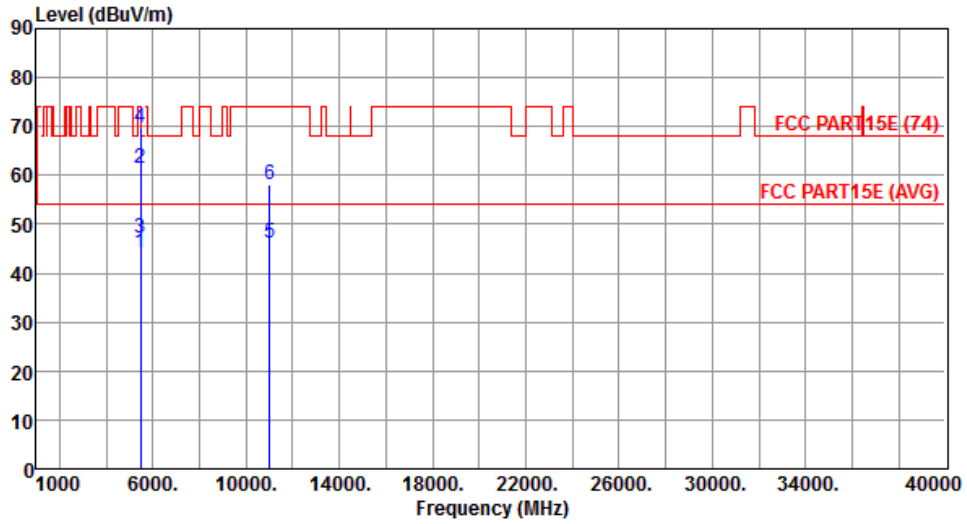

	Freq. MHz	Emission level dBuV/m	Limit dBuV/m	Margin dB	SA reading dBuV	Factor dB	Remark	ANT High cm	Turn Table deg
1	5460.00	44.08	54.00	-9.92	36.94	7.14	Average	245	274
2	5460.00	61.36	74.00	-12.64	54.22	7.14	Peak	245	274
3	5470.00	47.22	54.00	-6.78	40.07	7.15	Average	243	275
4	5470.00	69.83	74.00	-4.17	62.68	7.15	Peak	243	275
5	11000.00	46.25	54.00	-7.75	29.14	17.11	Average	235	249
6	11000.00	58.21	74.00	-15.79	41.10	17.11	Peak	235	249

Note 1: Emission Level (dBuV/m) = SA Reading (dBuV/m) + Factor* (dB)

*Factor includes antenna factor , cable loss and amplifier gain

Note 2: Margin (dB) = Emission level (dBuV/m) – Limit (dBuV/m).

Modulation	VHT20	Test Freq. (MHz)	5580
Polarization	Horizontal	Test Configuration	3

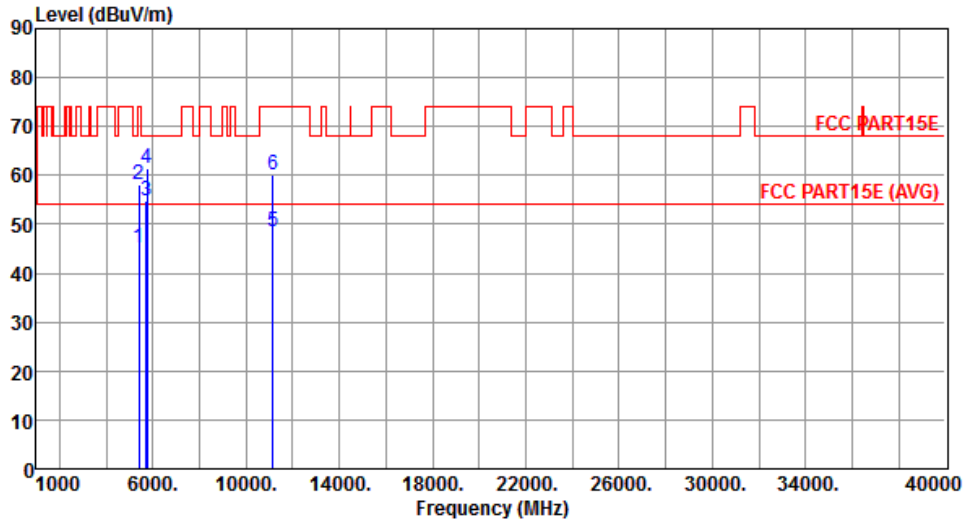

	Freq. MHz	Emission level dBuV/m	Limit dBuV/m	Margin dB	SA reading dBuV	Factor dB	Remark	ANT High cm	Turn Table deg
1	5418.00	45.02	54.00	-8.98	37.88	7.14	Average	225	38
2	5418.00	58.26	74.00	-15.74	51.12	7.14	Peak	225	38
3	5725.00	54.85	68.20	-13.35	47.28	7.57	Peak	225	38
4	5740.00	61.45	68.20	-6.75	53.84	7.61	Peak	256	81
5	11160.00	48.36	54.00	-5.64	31.19	17.17	Average	186	95
6	11160.00	60.21	74.00	-13.79	43.04	17.17	Peak	186	95

Note 1: Emission Level (dBuV/m) = SA Reading (dBuV/m) + Factor* (dB)

*Factor includes antenna factor , cable loss and amplifier gain

Note 2: Margin (dB) = Emission level (dBuV/m) – Limit (dBuV/m).

Modulation	VHT20	Test Freq. (MHz)	5580
Polarization	Vertical	Test Configuration	3

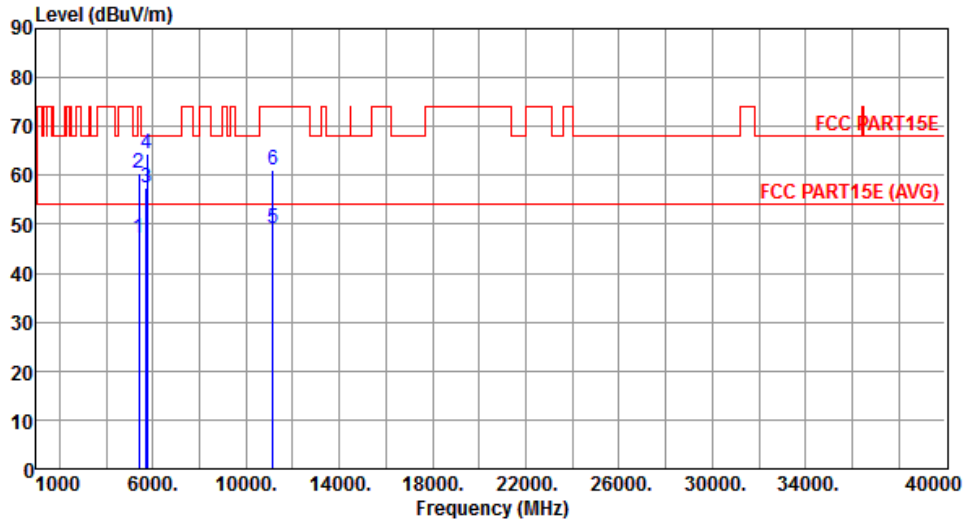

	Freq. MHz	Emission level dBuV/m	Limit dBuV/m	Margin dB	SA reading dBuV	Factor dB	Remark	ANT High cm	Turn Table deg
1	5418.00	47.21	54.00	-6.79	40.07	7.14	Average	251	249
2	5418.00	60.32	74.00	-13.68	53.18	7.14	Peak	251	249
3	5725.00	57.44	68.20	-10.76	49.87	7.57	Peak	251	249
4	5740.00	64.38	68.20	-3.82	56.77	7.61	Peak	242	250
5	11160.00	49.25	54.00	-4.75	32.08	17.17	Average	235	261
6	11160.00	61.14	74.00	-12.86	43.97	17.17	Peak	235	261

Note 1: Emission Level (dBuV/m) = SA Reading (dBuV/m) + Factor* (dB)

*Factor includes antenna factor , cable loss and amplifier gain

Note 2: Margin (dB) = Emission level (dBuV/m) – Limit (dBuV/m).

Modulation	VHT20	Test Freq. (MHz)	5700
Polarization	Horizontal	Test Configuration	3

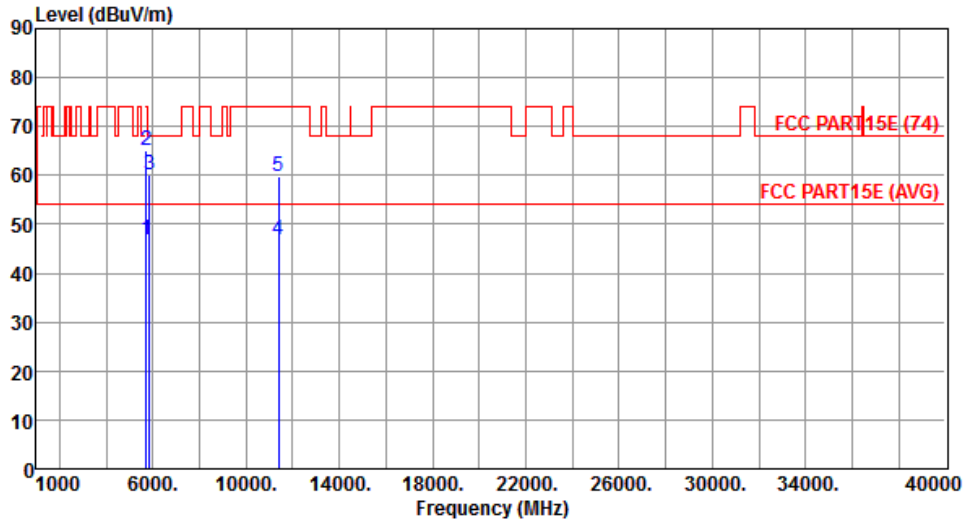

	Freq. MHz	Emission level dBuV/m	Limit dBuV/m	Margin dB	SA reading dBuV	Factor dB	Remark	ANT High cm	Turn Table deg
1	5725.00	46.89	54.00	-7.11	39.32	7.57	Average	236	50
2	5725.00	65.11	74.00	-8.89	57.54	7.57	Peak	236	50
3	5860.00	60.25	68.20	-7.95	52.34	7.91	Peak	234	85
4	11400.00	46.95	54.00	-7.05	29.71	17.24	Average	234	36
5	11400.00	59.62	74.00	-14.38	42.38	17.24	Peak	234	36

Note 1: Emission Level (dBuV/m) = SA Reading (dBuV/m) + Factor* (dB)

*Factor includes antenna factor , cable loss and amplifier gain

Note 2: Margin (dB) = Emission level (dBuV/m) – Limit (dBuV/m).

Modulation	VHT20	Test Freq. (MHz)	5700
Polarization	Vertical	Test Configuration	3

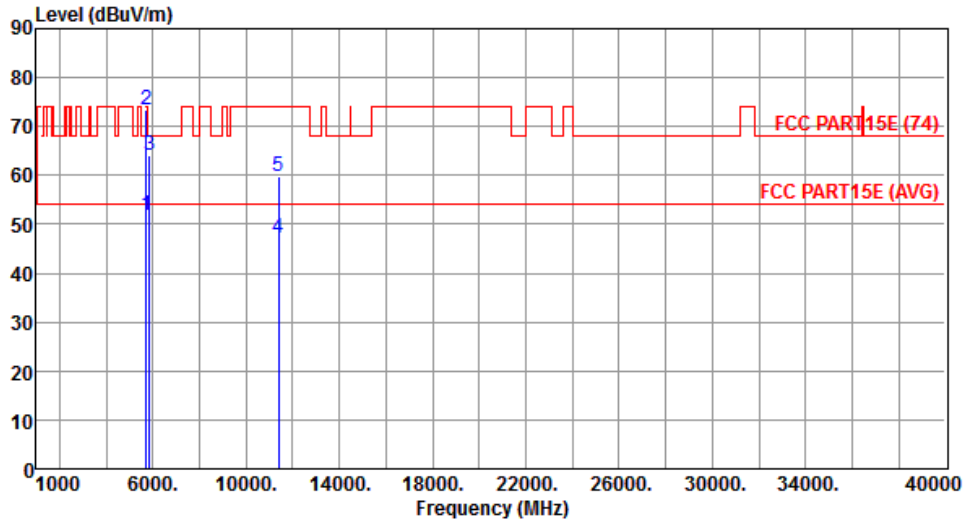

	Freq. MHz	Emission level dBuV/m	Limit dBuV/m	Margin dB	SA reading dBuV	Factor dB	Remark	ANT High cm	Turn Table deg
1	5725.00	51.75	54.00	-2.25	44.18	7.57	Average	238	241
2	5725.00	73.55	74.00	-0.45	66.42	7.13	Peak	238	241
3	5860.00	64.13	68.20	-4.07	56.22	7.91	Peak	238	269
4	11400.00	47.15	54.00	-6.85	29.91	17.24	Average	251	19
5	11400.00	59.86	74.00	-14.14	42.62	17.24	Peak	251	19

Note 1: Emission Level (dBuV/m) = SA Reading (dBuV/m) + Factor* (dB)

*Factor includes antenna factor , cable loss and amplifier gain

Note 2: Margin (dB) = Emission level (dBuV/m) – Limit (dBuV/m).

Modulation	VHT20	Test Freq. (MHz)	5720
Polarization	Horizontal	Test Configuration	3

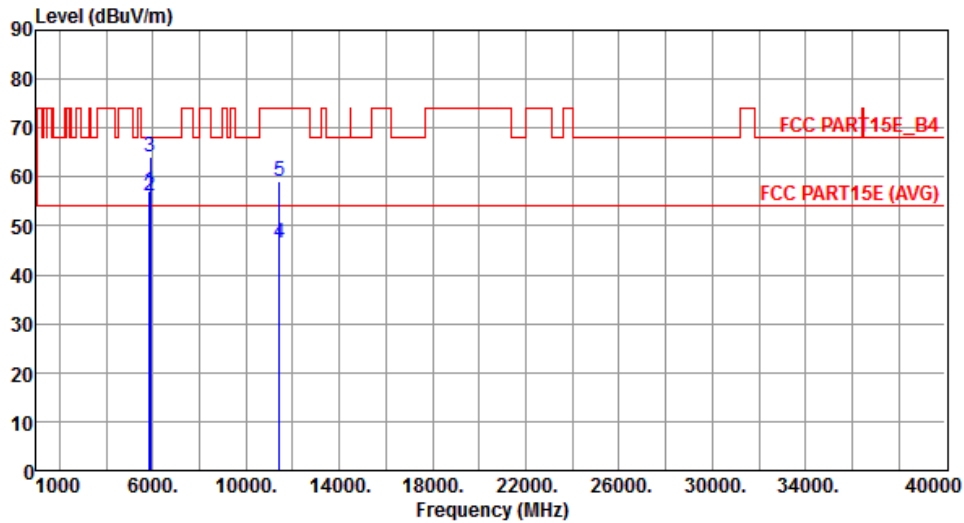

	Freq. MHz	Emission level dBuV/m	Limit dBuV/m	Margin dB	SA reading dBuV	Factor dB	Remark	ANT High cm	Turn Table deg
1	5850.00	57.21	78.20	-20.99	49.32	7.89	Peak	251	62
2	5860.00	56.24	68.20	-11.96	48.33	7.91	Peak	251	62
3	5880.00	64.02	68.20	-4.18	56.07	7.95	Peak	245	78
4	11440.00	46.54	54.00	-7.46	29.28	17.26	Average	195	81
5	11440.00	59.22	74.00	-14.78	41.96	17.26	Peak	195	81

Note 1: Emission Level (dBuV/m) = SA Reading (dBuV/m) + Factor* (dB)

*Factor includes antenna factor , cable loss and amplifier gain

Note 2: Margin (dB) = Emission level (dBuV/m) – Limit (dBuV/m).

Modulation	VHT20	Test Freq. (MHz)	5720
Polarization	Vertical	Test Configuration	3

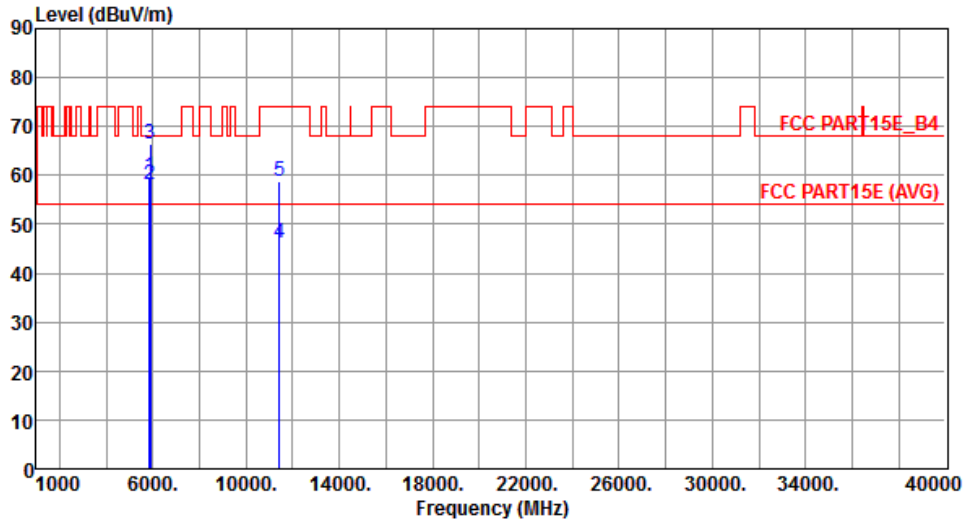

	Freq. MHz	Emission level dBuV/m	Limit dBuV/m	Margin dB	SA reading dBuV	Factor dB	Remark	ANT High cm	Turn Table deg
1	5850.00	59.94	78.20	-18.26	52.05	7.89	Peak	250	250
2	5860.00	58.12	68.20	-10.08	50.21	7.91	Peak	250	250
3	5880.00	66.31	68.20	-1.89	58.36	7.95	Peak	248	256
4	11440.00	46.02	54.00	-7.98	28.76	17.26	Average	242	259
5	11440.00	58.91	74.00	-15.09	41.65	17.26	Peak	242	259

Note 1: Emission Level (dBuV/m) = SA Reading (dBuV/m) + Factor* (dB)

*Factor includes antenna factor , cable loss and amplifier gain

Note 2: Margin (dB) = Emission level (dBuV/m) – Limit (dBuV/m).

3.5.11 Transmitter Radiated Unwanted Emissions (Above 1GHz) for VHT40

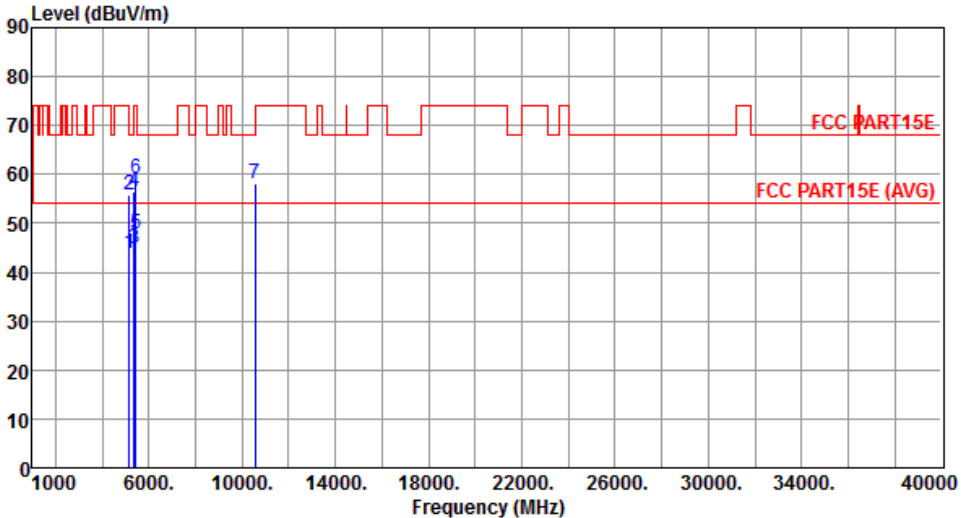
Modulation	VHT40	Test Freq. (MHz)	5270																																																																																									
Polarization	Horizontal	Test Configuration	3																																																																																									
																																																																																												
	<table border="1"> <thead> <tr> <th>Freq.</th> <th>Emission level</th> <th>Limit</th> <th>Margin</th> <th>SA reading</th> <th>Factor</th> <th>Remark</th> <th>ANT High</th> <th>Turn Table</th> </tr> <tr> <th>MHz</th> <th>dBuV/m</th> <th>dBuV/m</th> <th>dB</th> <th>dBuV</th> <th>dB</th> <th></th> <th>cm</th> <th>deg</th> </tr> </thead> <tbody> <tr> <td>1</td> <td>5150.00</td> <td>43.81</td> <td>54.00</td> <td>-10.19</td> <td>37.23</td> <td>6.58</td> <td>Average</td> <td>251</td> <td>65</td> </tr> <tr> <td>2</td> <td>5150.00</td> <td>55.65</td> <td>74.00</td> <td>-18.35</td> <td>49.07</td> <td>6.58</td> <td>Peak</td> <td>251</td> <td>65</td> </tr> <tr> <td>3</td> <td>5350.00</td> <td>44.84</td> <td>54.00</td> <td>-9.16</td> <td>37.81</td> <td>7.03</td> <td>Average</td> <td>251</td> <td>65</td> </tr> <tr> <td>4</td> <td>5350.00</td> <td>56.47</td> <td>74.00</td> <td>-17.53</td> <td>49.44</td> <td>7.03</td> <td>Peak</td> <td>251</td> <td>65</td> </tr> <tr> <td>5</td> <td>5430.00</td> <td>47.95</td> <td>54.00</td> <td>-6.05</td> <td>40.81</td> <td>7.14</td> <td>Average</td> <td>264</td> <td>51</td> </tr> <tr> <td>6</td> <td>5430.00</td> <td>59.02</td> <td>74.00</td> <td>-14.98</td> <td>51.88</td> <td>7.14</td> <td>Peak</td> <td>264</td> <td>51</td> </tr> <tr> <td>7</td> <td>10540.00</td> <td>58.03</td> <td>68.20</td> <td>-10.17</td> <td>41.29</td> <td>16.74</td> <td>Peak</td> <td>254</td> <td>186</td> </tr> </tbody> </table>	Freq.	Emission level	Limit	Margin	SA reading	Factor	Remark	ANT High	Turn Table	MHz	dBuV/m	dBuV/m	dB	dBuV	dB		cm	deg	1	5150.00	43.81	54.00	-10.19	37.23	6.58	Average	251	65	2	5150.00	55.65	74.00	-18.35	49.07	6.58	Peak	251	65	3	5350.00	44.84	54.00	-9.16	37.81	7.03	Average	251	65	4	5350.00	56.47	74.00	-17.53	49.44	7.03	Peak	251	65	5	5430.00	47.95	54.00	-6.05	40.81	7.14	Average	264	51	6	5430.00	59.02	74.00	-14.98	51.88	7.14	Peak	264	51	7	10540.00	58.03	68.20	-10.17	41.29	16.74	Peak	254	186			
Freq.	Emission level	Limit	Margin	SA reading	Factor	Remark	ANT High	Turn Table																																																																																				
MHz	dBuV/m	dBuV/m	dB	dBuV	dB		cm	deg																																																																																				
1	5150.00	43.81	54.00	-10.19	37.23	6.58	Average	251	65																																																																																			
2	5150.00	55.65	74.00	-18.35	49.07	6.58	Peak	251	65																																																																																			
3	5350.00	44.84	54.00	-9.16	37.81	7.03	Average	251	65																																																																																			
4	5350.00	56.47	74.00	-17.53	49.44	7.03	Peak	251	65																																																																																			
5	5430.00	47.95	54.00	-6.05	40.81	7.14	Average	264	51																																																																																			
6	5430.00	59.02	74.00	-14.98	51.88	7.14	Peak	264	51																																																																																			
7	10540.00	58.03	68.20	-10.17	41.29	16.74	Peak	254	186																																																																																			
<p>Note 1: Emission Level (dBuV/m) = SA Reading (dBuV/m) + Factor* (dB) *Factor includes antenna factor , cable loss and amplifier gain Note 2: Margin (dB) = Emission level (dBuV/m) – Limit (dBuV/m).</p>																																																																																												

Modulation	VHT40	Test Freq. (MHz)	5270
Polarization	Vertical	Test Configuration	3

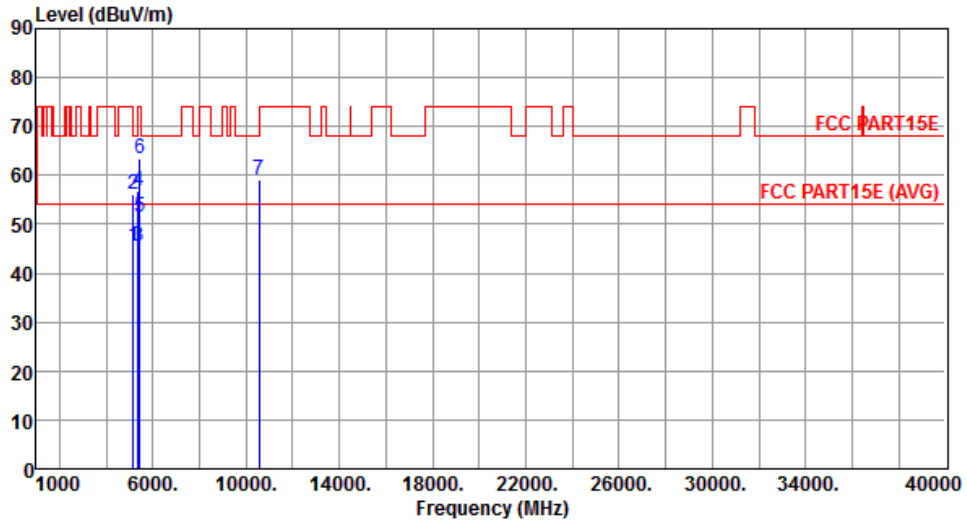

	Freq. MHz	Emission level dBuV/m	Limit dBuV/m	Margin dB	SA reading dBuV	Factor dB	Remark	ANT High cm	Turn Table deg
1	5150.00	45.39	54.00	-8.61	38.81	6.58	Average	229	254
2	5150.00	56.21	74.00	-17.79	49.63	6.58	Peak	229	254
3	5350.00	45.62	54.00	-8.38	38.59	7.03	Average	229	254
4	5350.00	56.65	74.00	-17.35	49.62	7.03	Peak	229	254
5	5430.00	51.42	54.00	-2.58	44.28	7.14	Average	239	252
6	5430.00	63.42	74.00	-10.58	56.28	7.14	Peak	239	252
7	10540.00	58.95	68.20	-9.25	42.21	16.74	Peak	242	198

Note 1: Emission Level (dBuV/m) = SA Reading (dBuV/m) + Factor* (dB)

*Factor includes antenna factor , cable loss and amplifier gain

Note 2: Margin (dB) = Emission level (dBuV/m) – Limit (dBuV/m).

Modulation	VHT40	Test Freq. (MHz)	5310
Polarization	Horizontal	Test Configuration	3

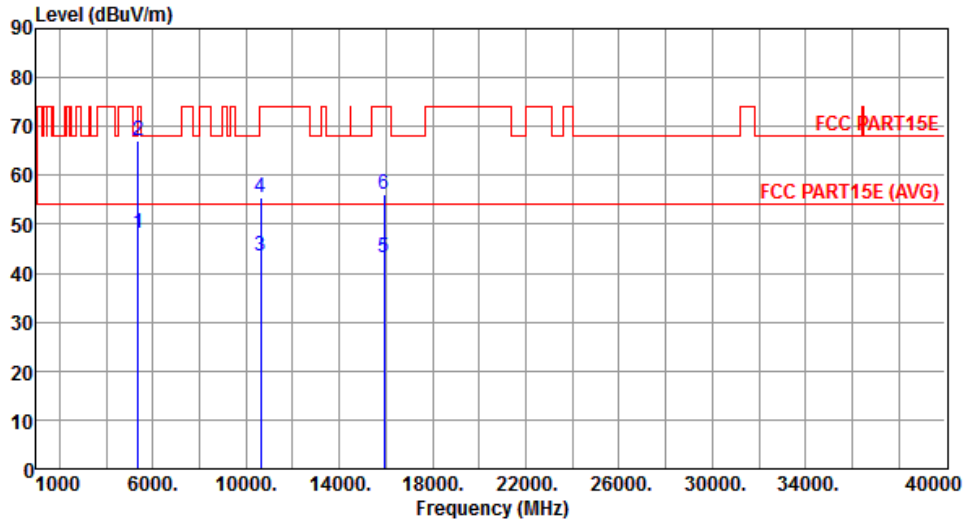

	Freq. MHz	Emission level dBuV/m	Limit dBuV/m	Margin dB	SA reading dBuV	Factor dB	Remark	ANT High cm	Turn Table deg
1	5350.00	48.21	54.00	-5.79	41.18	7.03	Average	256	38
2	5350.00	66.94	74.00	-7.06	59.91	7.03	Peak	256	38
3	10620.00	43.35	54.00	-10.65	26.55	16.80	Average	245	41
4	10620.00	55.43	74.00	-18.57	38.63	16.80	Peak	245	41
5	15930.00	43.15	54.00	-10.85	26.41	16.74	Average	264	58
6	15930.00	56.24	74.00	-17.76	39.50	16.74	Peak	264	58

Note 1: Emission Level (dBuV/m) = SA Reading (dBuV/m) + Factor* (dB)

*Factor includes antenna factor , cable loss and amplifier gain

Note 2: Margin (dB) = Emission level (dBuV/m) – Limit (dBuV/m).

Modulation	VHT40	Test Freq. (MHz)	5310
Polarization	Vertical	Test Configuration	3

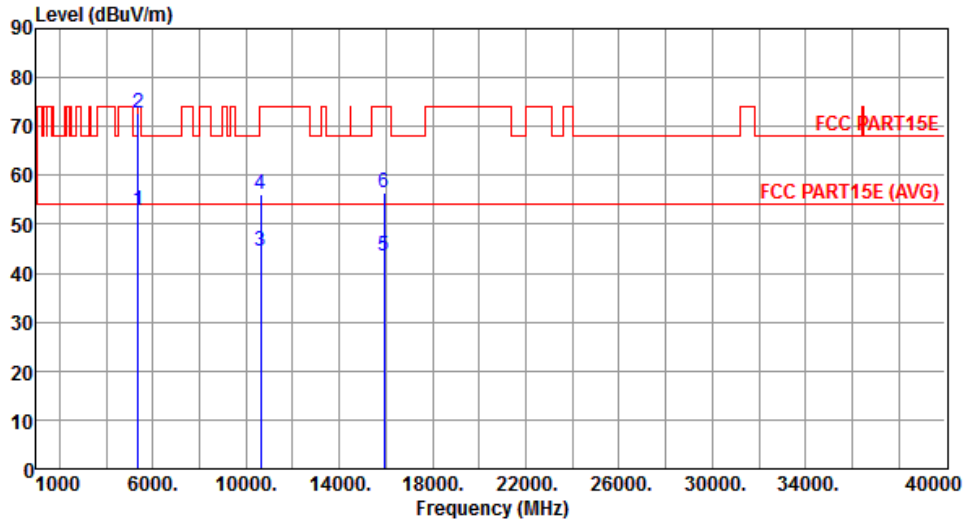

	Freq. MHz	Emission level dBuV/m	Limit dBuV/m	Margin dB	SA reading dBuV	Factor dB	Remark	ANT High cm	Turn Table deg
1	5350.00	52.92	54.00	-1.08	45.89	7.03	Average	256	245
2	5350.00	72.87	74.00	-1.13	65.84	7.03	Peak	256	245
3	10620.00	44.51	54.00	-9.49	27.71	16.80	Average	215	224
4	10620.00	55.96	74.00	-18.04	39.16	16.80	Peak	215	224
5	15930.00	43.35	54.00	-10.65	26.61	16.74	Average	220	215
6	15930.00	56.41	74.00	-17.59	39.67	16.74	Peak	220	215

Note 1: Emission Level (dBuV/m) = SA Reading (dBuV/m) + Factor* (dB)

*Factor includes antenna factor , cable loss and amplifier gain

Note 2: Margin (dB) = Emission level (dBuV/m) – Limit (dBuV/m).

Modulation	VHT40	Test Freq. (MHz)	5510
Polarization	Horizontal	Test Configuration	3

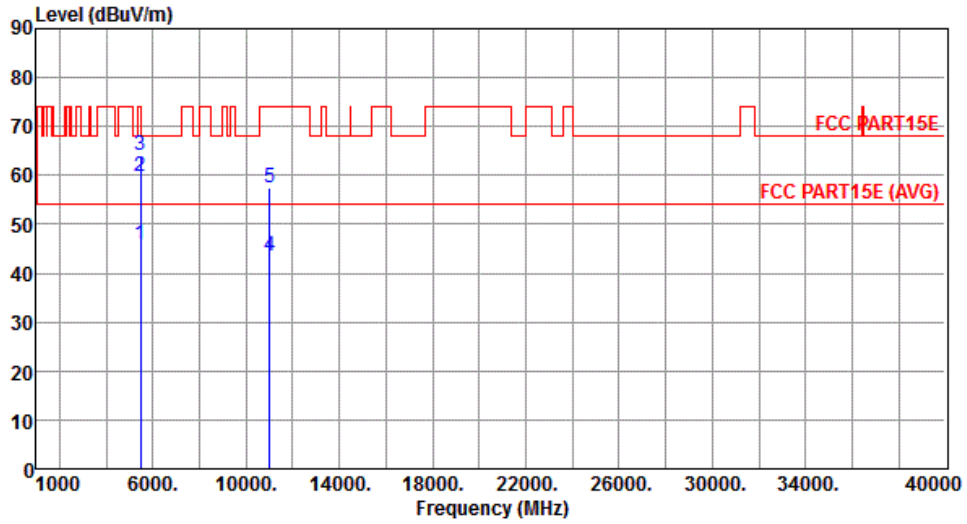

	Freq. MHz	Emission level dBuV/m	Limit dBuV/m	Margin dB	SA reading dBuV	Factor dB	Remark	ANT High cm	Turn Table deg
1	5460.00	45.67	54.00	-8.33	38.53	7.14	Average	244	194
2	5460.00	59.73	74.00	-14.27	52.59	7.14	Peak	244	194
3	5470.00	64.15	68.20	-4.05	57.00	7.15	Peak	244	194
4	11020.00	43.47	54.00	-10.53	26.35	17.12	Average	228	174
5	11020.00	57.54	74.00	-16.46	40.42	17.12	Peak	228	174

Note 1: Emission Level (dBuV/m) = SA Reading (dBuV/m) + Factor* (dB)

*Factor includes antenna factor , cable loss and amplifier gain

Note 2: Margin (dB) = Emission level (dBuV/m) – Limit (dBuV/m).

Modulation	VHT40	Test Freq. (MHz)	5510
Polarization	Vertical	Test Configuration	3

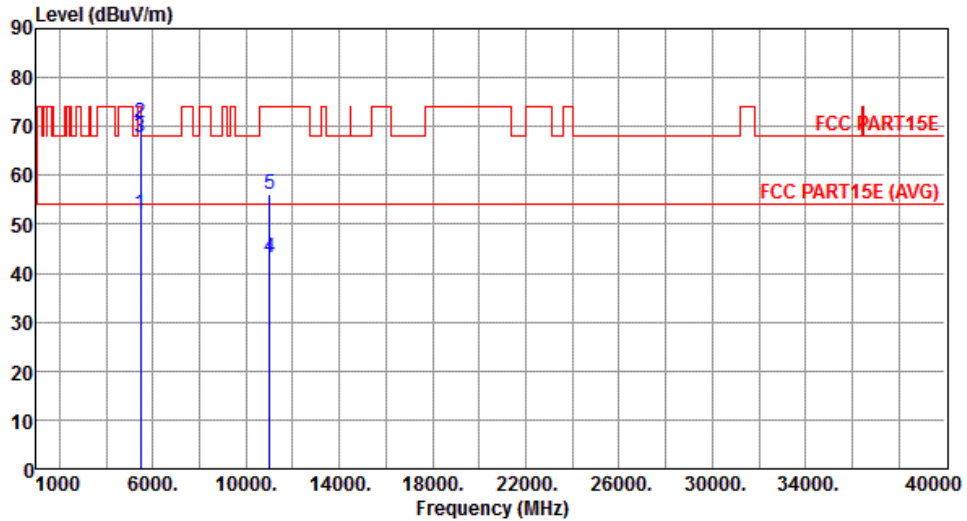

	Freq. MHz	Emission level dBuV/m	Limit dBuV/m	Margin dB	SA reading dBuV	Factor dB	Remark	ANT High cm	Turn Table deg
1	5460.00	52.24	54.00	-1.76	45.10	7.14	Average	186	77
2	5460.00	70.81	74.00	-3.19	63.67	7.14	Peak	186	77
3	5470.00	67.77	68.20	-0.43	60.62	7.15	Peak	219	279
4	11020.00	43.20	54.00	-10.80	26.08	17.12	Average	271	209
5	11020.00	56.28	74.00	-17.72	39.16	17.12	Peak	271	209

Note 1: Emission Level (dBuV/m) = SA Reading (dBuV/m) + Factor* (dB)

*Factor includes antenna factor , cable loss and amplifier gain

Note 2: Margin (dB) = Emission level (dBuV/m) – Limit (dBuV/m).

Modulation	VHT40	Test Freq. (MHz)	5550
Polarization	Horizontal	Test Configuration	3

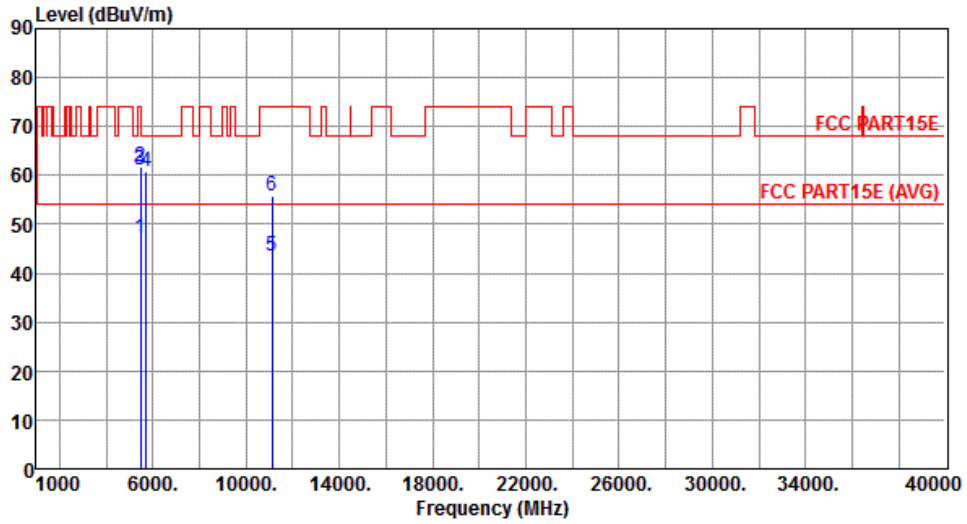

	Freq. MHz	Emission level dBuV/m	Limit dBuV/m	Margin dB	SA reading dBuV	Factor dB	Remark	ANT High cm	Turn Table deg
1	5460.00	47.00	54.00	-7.00	39.86	7.14	Average	244	194
2	5460.00	61.64	74.00	-12.36	54.50	7.14	Peak	244	194
3	5470.00	61.15	68.20	-7.05	54.00	7.15	Peak	244	194
4	5725.00	60.66	68.20	-7.54	53.09	7.57	Peak	244	194
5	11100.00	43.45	54.00	-10.55	26.30	17.15	Average	249	52
6	11100.00	55.79	74.00	-18.21	38.64	17.15	Peak	249	52

Note 1: Emission Level (dBuV/m) = SA Reading (dBuV/m) + Factor* (dB)

*Factor includes antenna factor , cable loss and amplifier gain

Note 2: Margin (dB) = Emission level (dBuV/m) – Limit (dBuV/m).

Modulation	VHT40	Test Freq. (MHz)	5550
Polarization	Vertical	Test Configuration	3

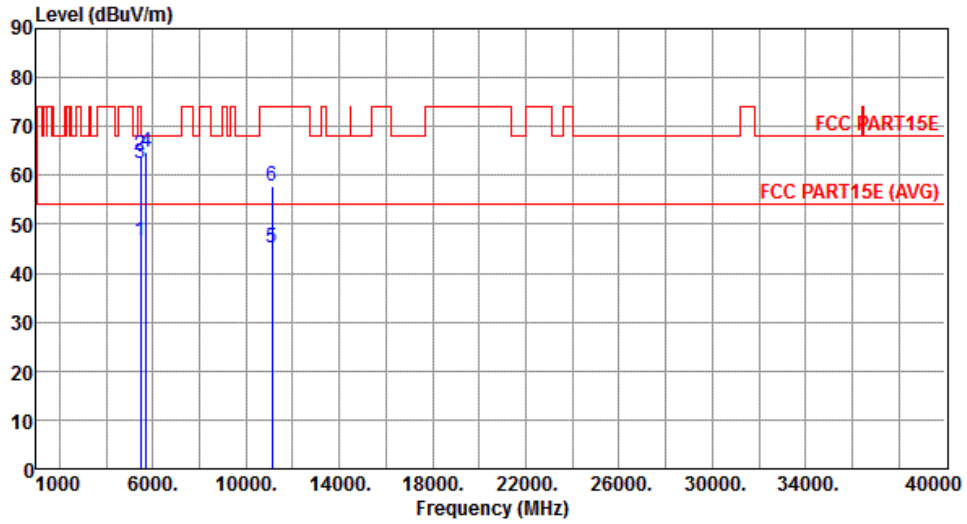

	Freq. MHz	Emission level dBuV/m	Limit dBuV/m	Margin dB	SA reading dBuV	Factor dB	Remark	ANT High cm	Turn Table deg
1	5460.00	46.58	54.00	-7.42	39.44	7.14	Average	244	253
2	5460.00	64.24	74.00	-9.76	57.10	7.14	Peak	244	253
3	5470.00	62.45	68.20	-5.75	55.30	7.15	Peak	244	253
4	5725.00	64.86	68.20	-3.34	57.29	7.57	Peak	244	253
5	11100.00	45.24	54.00	-8.76	28.09	17.15	Average	293	256
6	11100.00	57.84	74.00	-16.16	40.69	17.15	Peak	293	256

Note 1: Emission Level (dBuV/m) = SA Reading (dBuV/m) + Factor* (dB)

*Factor includes antenna factor , cable loss and amplifier gain

Note 2: Margin (dB) = Emission level (dBuV/m) – Limit (dBuV/m).

Modulation	VHT40	Test Freq. (MHz)	5670
Polarization	Horizontal	Test Configuration	3

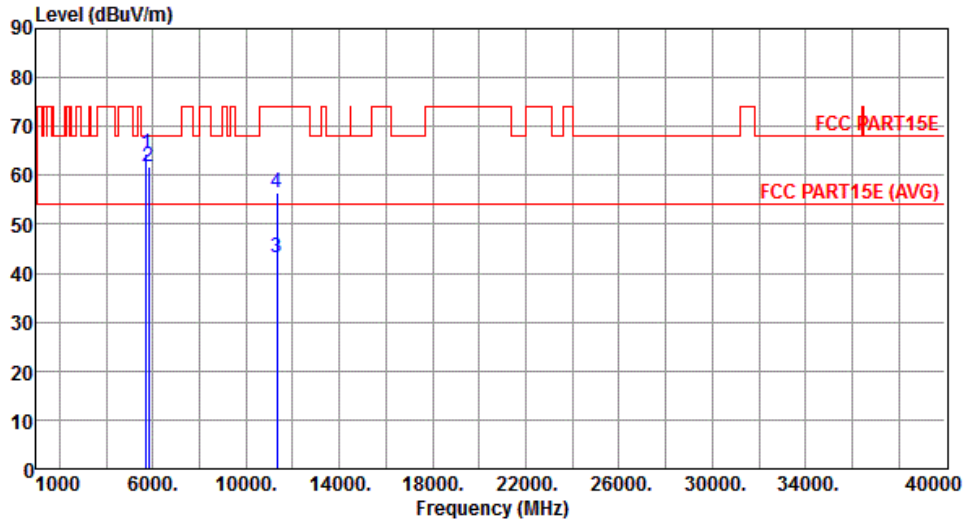

	Freq. MHz	Emission level dBuV/m	Limit dBuV/m	Margin dB	SA reading dBuV	Factor dB	Remark	ANT High cm	Turn Table deg
1	5725.00	64.32	68.20	-3.88	56.75	7.57	Peak	241	196
2	5830.00	61.76	68.20	-6.44	53.91	7.85	Peak	241	196
3	11340.00	43.18	54.00	-10.82	25.96	17.22	Average	208	226
4	11340.00	56.34	74.00	-17.66	39.12	17.22	Peak	208	226

Note 1: Emission Level (dBuV/m) = SA Reading (dBuV/m) + Factor* (dB)

*Factor includes antenna factor , cable loss and amplifier gain

Note 2: Margin (dB) = Emission level (dBuV/m) – Limit (dBuV/m).

Modulation	VHT40	Test Freq. (MHz)	5670
Polarization	Vertical	Test Configuration	3

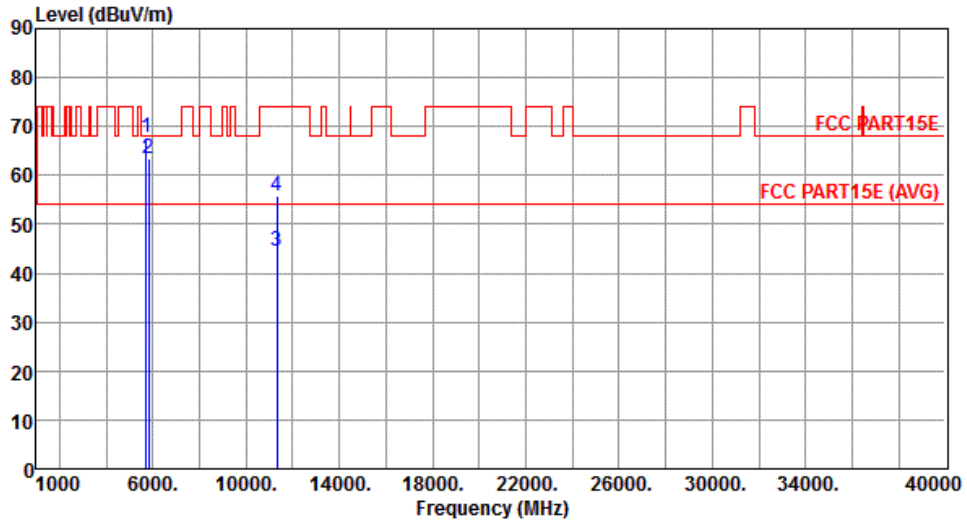

	Freq. MHz	Emission level dBuV/m	Limit dBuV/m	Margin dB	SA reading dBuV	Factor dB	Remark	ANT High cm	Turn Table deg
1	5725.00	67.82	68.20	-0.38	60.25	7.57	Peak	243	249
2	5830.00	63.52	68.20	-4.68	55.67	7.85	Peak	214	250
3	11340.00	44.37	54.00	-9.63	27.15	17.22	Average	275	267
4	11340.00	55.91	74.00	-18.09	38.69	17.22	Peak	275	267

Note 1: Emission Level (dBuV/m) = SA Reading (dBuV/m) + Factor* (dB)

*Factor includes antenna factor , cable loss and amplifier gain

Note 2: Margin (dB) = Emission level (dBuV/m) – Limit (dBuV/m).

Modulation	VHT40	Test Freq. (MHz)	5710
Polarization	Horizontal	Test Configuration	3

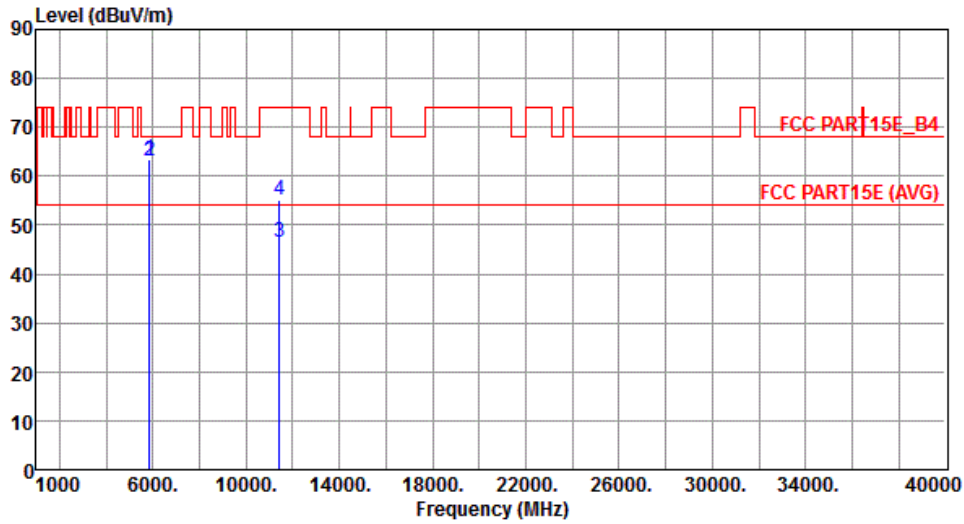

	Freq. MHz	Emission level dBuV/m	Limit dBuV/m	Margin dB	SA reading dBuV	Factor dB	Remark	ANT High cm	Turn Table deg
1	5850.00	63.35	78.20	-14.85	55.96	7.39	Peak	221	117
2	5860.00	63.18	68.20	-5.02	55.78	7.40	Peak	221	117
3	11420.00	46.40	54.00	-7.60	29.62	16.78	Average	257	142
4	11420.00	55.28	74.00	-18.72	38.50	16.78	Peak	257	142

Note 1: Emission Level (dBuV/m) = SA Reading (dBuV/m) + Factor* (dB)

*Factor includes antenna factor , cable loss and amplifier gain

Note 2: Margin (dB) = Emission level (dBuV/m) – Limit (dBuV/m).

Modulation	VHT40	Test Freq. (MHz)	5710
Polarization	Vertical	Test Configuration	3

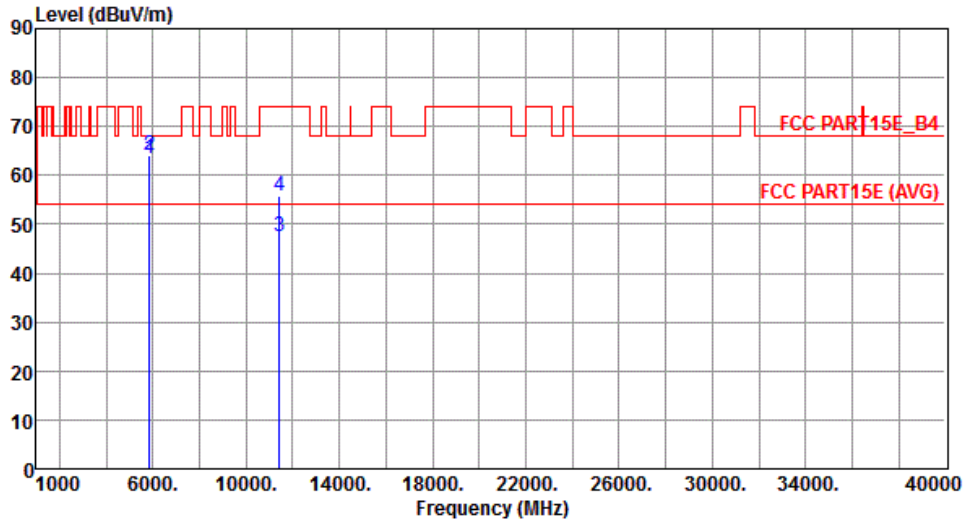

	Freq. MHz	Emission level dBuV/m	Limit dBuV/m	Margin dB	SA reading dBuV	Factor dB	Remark	ANT High cm	Turn Table deg
1	5850.00	63.39	78.20	-14.81	56.00	7.39	Peak	300	116
2	5860.00	63.95	68.20	-4.25	56.55	7.40	Peak	300	116
3	11420.00	47.53	54.00	-6.47	30.75	16.78	Average	217	319
4	11420.00	55.64	74.00	-18.36	38.86	16.78	Peak	217	319

Note 1: Emission Level (dBuV/m) = SA Reading (dBuV/m) + Factor* (dB)

*Factor includes antenna factor , cable loss and amplifier gain

Note 2: Margin (dB) = Emission level (dBuV/m) – Limit (dBuV/m).

3.5.12 Transmitter Radiated Unwanted Emissions (Above 1GHz) for VHT80

Modulation	VHT80	Test Freq. (MHz)	5290
Polarization	Horizontal	Test Configuration	3

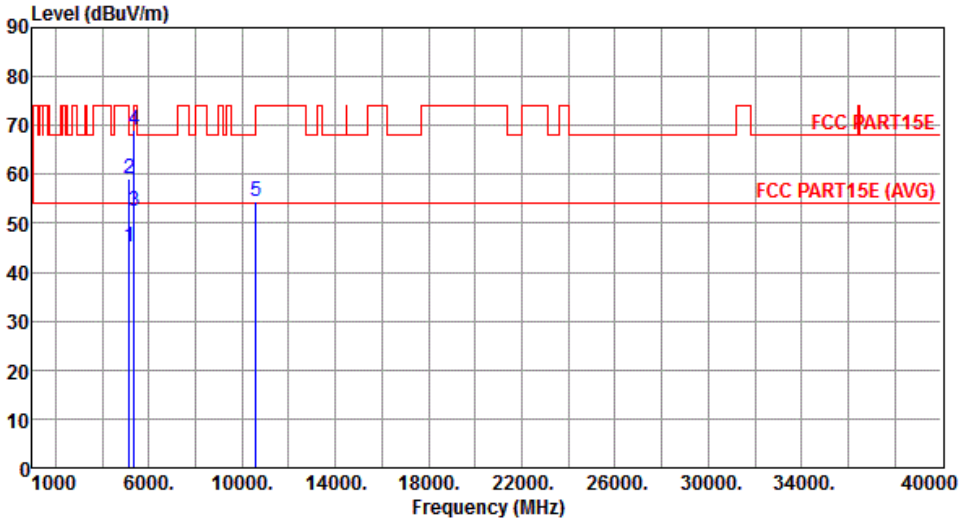

	Freq. MHz	Emission level dBuV/m	Limit dBuV/m	Margin dB	SA reading dBuV	Factor dB	Remark	ANT High cm	Turn Table deg
1	5150.00	45.25	54.00	-8.75	38.67	6.58	Average	251	258
2	5150.00	59.19	74.00	-14.81	52.61	6.58	Peak	251	258
3	5350.00	52.57	54.00	-1.43	45.54	7.03	Average	251	258
4	5350.00	69.04	74.00	-4.96	62.01	7.03	Peak	251	258
5	10580.00	54.39	68.20	-13.81	37.62	16.77	Peak	277	236

Note 1: Emission Level (dBuV/m) = SA Reading (dBuV/m) + Factor* (dB)
*Factor includes antenna factor , cable loss and amplifier gain
Note 2: Margin (dB) = Emission level (dBuV/m) – Limit (dBuV/m).

Modulation	VHT80	Test Freq. (MHz)	5290
Polarization	Vertical	Test Configuration	3

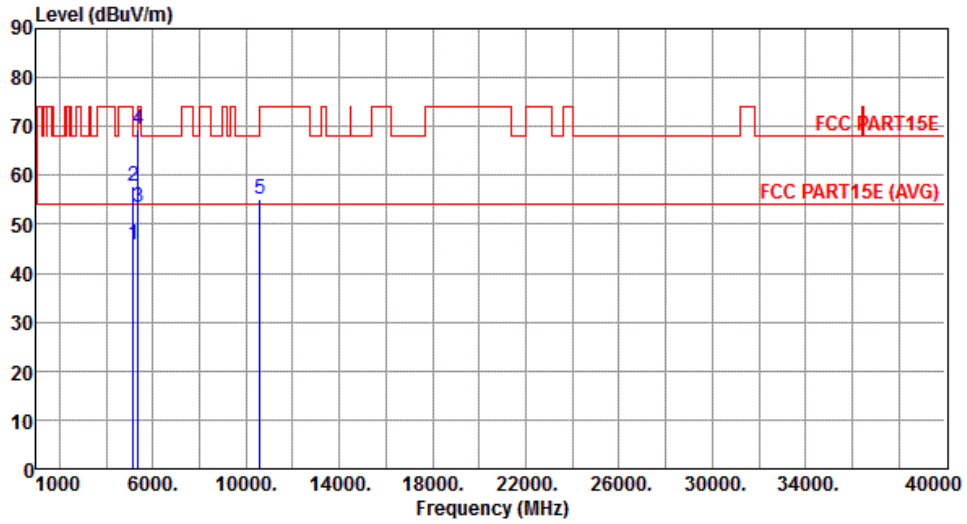

	Freq. MHz	Emission level dBuV/m	Limit dBuV/m	Margin dB	SA reading dBuV	Factor dB	Remark	ANT High cm	Turn Table deg
1	5150.00	45.77	54.00	-8.23	39.19	6.58	Average	242	279
2	5150.00	57.83	74.00	-16.17	51.25	6.58	Peak	242	279
3	5350.00	53.43	54.00	-0.57	46.40	7.03	Average	252	283
4	5350.00	69.53	74.00	-4.47	62.50	7.03	Peak	252	283
5	10580.00	55.07	68.20	-13.13	38.30	16.77	Peak	313	268

Note 1: Emission Level (dBuV/m) = SA Reading (dBuV/m) + Factor* (dB)

*Factor includes antenna factor , cable loss and amplifier gain

Note 2: Margin (dB) = Emission level (dBuV/m) – Limit (dBuV/m).

Modulation	VHT80	Test Freq. (MHz)	5530
Polarization	Horizontal	Test Configuration	3

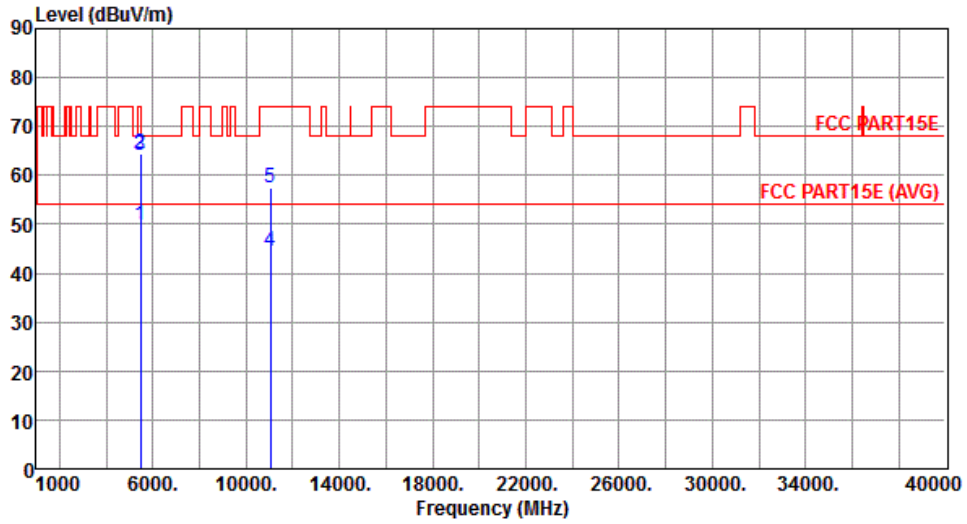

	Freq. MHz	Emission level dBuV/m	Limit dBuV/m	Margin dB	SA reading dBuV	Factor dB	Remark	ANT High cm	Turn Table deg
1	5460.00	49.94	54.00	-4.06	42.80	7.14	Average	250	51
2	5460.00	64.44	74.00	-9.56	57.30	7.14	Peak	250	51
3	5470.00	64.03	68.20	-4.17	56.88	7.15	Peak	250	51
4	11060.00	44.47	54.00	-9.53	27.34	17.13	Average	215	223
5	11060.00	57.39	74.00	-16.61	40.26	17.13	Peak	215	223

Note 1: Emission Level (dBuV/m) = SA Reading (dBuV/m) + Factor* (dB)

*Factor includes antenna factor , cable loss and amplifier gain

Note 2: Margin (dB) = Emission level (dBuV/m) – Limit (dBuV/m).

Modulation	VHT80	Test Freq. (MHz)	5530
Polarization	Vertical	Test Configuration	3

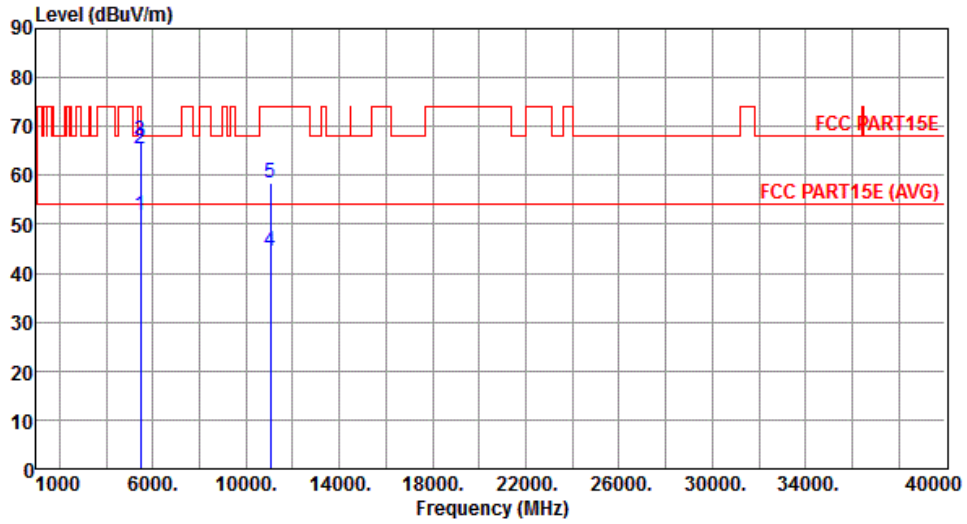

	Freq. MHz	Emission level dBuV/m	Limit dBuV/m	Margin dB	SA reading dBuV	Factor dB	Remark	ANT High cm	Turn Table deg
1	5460.00	51.93	54.00	-2.07	44.79	7.14	Average	246	71
2	5460.00	65.26	74.00	-8.74	58.12	7.14	Peak	246	71
3	5470.00	67.06	68.20	-1.14	59.91	7.15	Peak	246	71
4	11060.00	44.36	54.00	-9.64	27.23	17.13	Average	206	224
5	11060.00	58.39	74.00	-15.61	41.26	17.13	Peak	206	224

Note 1: Emission Level (dBuV/m) = SA Reading (dBuV/m) + Factor* (dB)

*Factor includes antenna factor , cable loss and amplifier gain

Note 2: Margin (dB) = Emission level (dBuV/m) – Limit (dBuV/m).

Modulation	VHT80	Test Freq. (MHz)	5690
Polarization	Horizontal	Test Configuration	3

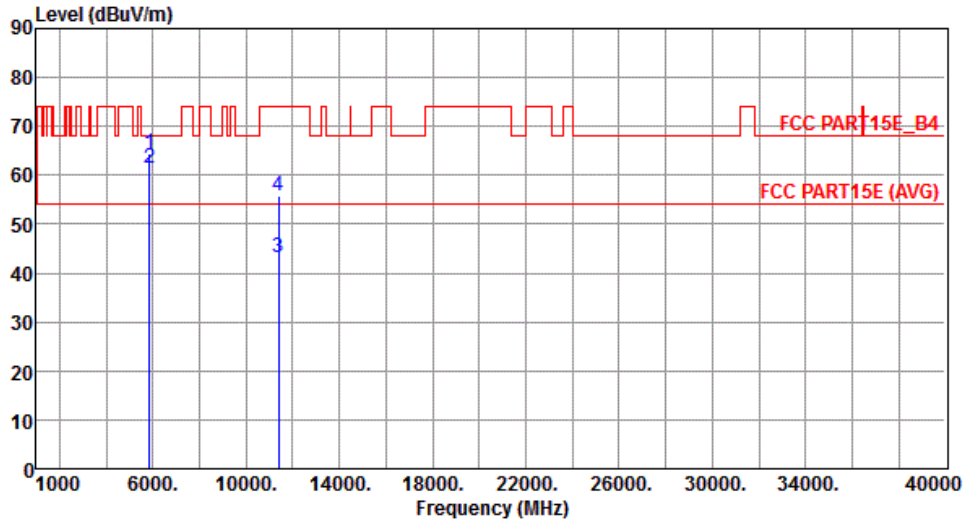

	Freq. MHz	Emission level dBuV/m	Limit dBuV/m	Margin dB	SA reading dBuV	Factor dB	Remark	ANT High cm	Turn Table deg
1	5850.00	64.44	78.20	-13.76	57.05	7.39	Peak	249	40
2	5860.00	61.45	68.20	-6.75	54.05	7.40	Peak	249	40
3	11380.00	43.11	54.00	-10.89	26.35	16.76	Average	177	199
4	11380.00	55.72	74.00	-18.28	38.96	16.76	Peak	177	199

Note 1: Emission Level (dBuV/m) = SA Reading (dBuV/m) + Factor* (dB)

*Factor includes antenna factor , cable loss and amplifier gain

Note 2: Margin (dB) = Emission level (dBuV/m) – Limit (dBuV/m).

Modulation	VHT80	Test Freq. (MHz)	5690
Polarization	Vertical	Test Configuration	3

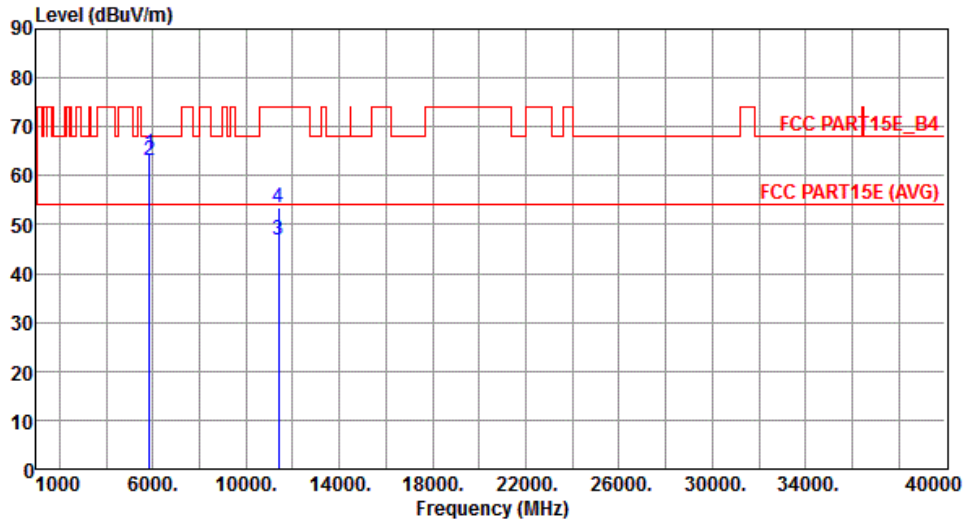

	Freq. MHz	Emission level dBuV/m	Limit dBuV/m	Margin dB	SA reading dBuV	Factor dB	Remark	ANT High cm	Turn Table deg
1	5850.00	64.49	78.20	-13.71	57.10	7.39	Peak	261	250
2	5860.00	63.21	68.20	-4.99	55.81	7.40	Peak	261	250
3	11380.00	46.99	54.00	-7.01	30.23	16.76	Average	166	127
4	11380.00	53.41	74.00	-20.59	36.65	16.76	Peak	166	127

Note 1: Emission Level (dBuV/m) = SA Reading (dBuV/m) + Factor* (dB)

*Factor includes antenna factor , cable loss and amplifier gain

Note 2: Margin (dB) = Emission level (dBuV/m) – Limit (dBuV/m).

3.6 Frequency Stability

3.6.1 Limit of Frequency Stability

Manufacturers of U-NII devices are responsible for ensuring frequency stability such that an emission is maintained within the band of operation under all conditions of normal operation as specified in the user's manual.

3.6.2 Test Procedures

1. The EUT is installed in an environment test chamber with external power source.
2. Set the chamber to operate at 50 centigrade and external power source to output at nominal voltage of EUT.
3. A sufficient stabilization period at each temperature is used prior to each frequency measurement.
4. When temperature is stabled, measure the frequency stability.
5. The test shall be performed under -30 to 50 centigrade and 85 to 115 percent of the nominal voltage. Change setting of chamber and external power source to complete all conditions.

3.6.3 Test Setup

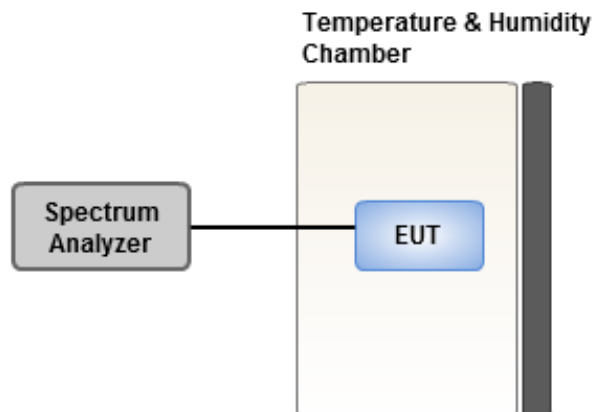

3.6.4 Test Result of Frequency Stability

Frequency: 5300 MHz	Frequency Drift (ppm)			
	0 minute	2 minutes	5 minutes	10 minutes
T20°CVmax	3.96	3.97	3.42	3.89
T20°CVmin	3.51	4.67	4.31	3.87
T50°CVnom	4.10	3.28	4.42	4.18
T40°CVnom	3.51	3.84	3.18	3.49
T30°CVnom	4.15	3.49	4.08	3.71
T20°CVnom	4.15	4.17	3.30	3.59
T10°CVnom	3.43	2.73	4.15	3.58
T0°CVnom	3.70	2.85	3.32	3.59
T-10°CVnom	3.30	2.50	4.10	3.91
T-20°CVnom	4.07	2.45	4.02	3.66
T-30°CVnom	4.26	1.50	3.97	4.19
Vnom [Vac]: 120		Vmax [Vac]: 138		Vmin [Vac]: 102
Tnom [°C]: 20		Tmax [°C]: 50		Tmin [°C]: -30

4 Test laboratory information

Established in 2012, ICC provides foremost EMC & RF Testing and advisory consultation services by our skilled engineers and technicians. Our services employ a wide variety of advanced edge test equipment and one of the widest certification extents in the business.

International Certification Corp, it is our definitive objective is to institute long term, trust-based associations with our clients. The expectation we set up with our clients is based on outstanding service, practical expertise and devotion to a certified value structure. Our passion is to grant our clients with best EMC / RF services by oriented knowledgeable and accommodating staff.

Our Test sites are located at Linkou District and Kwei Shan Hsiang. Location map can be found on our website <http://www.icertifi.com.tw>.

Linkou

Tel: 886-2-2601-1640

No. 30-2, Ding Fwu Tsuen, Lin Kou
District, New Taipei City, Taiwan,
R.O.C.

Kwei Shan

Tel: 886-3-271-8666

No. 3-1, Lane 6, Wen San 3rd
St., Kwei Shan Hsiang, Tao Yuan
Hsien 333, Taiwan, R.O.C.

Kwei Shan Site II

Tel: 886-3-271-8640

No. 14-1, Lane 19, Wen San 3rd
St., Kwei Shan Hsiang, Tao Yuan
Hsien 333, Taiwan, R.O.C.

If you have any suggestion, please feel free to contact us as below information

Tel: 886-3-271-8666

Fax: 886-3-318-0155

Email: ICC_Service@icertifi.com.tw

==END==