

Babytone®

# Baby Monitor

## User Manual

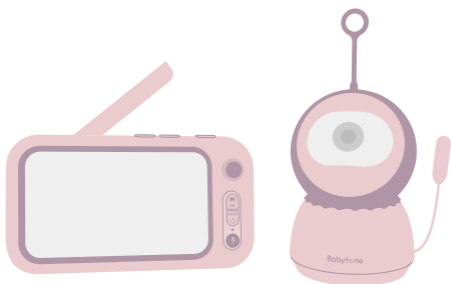

Contact us: [service@getbabytone.com](mailto:service@getbabytone.com)

Website: [www.getbabytone.com](http://www.getbabytone.com)

# Contents

<b>1. Introduction</b> .....	1
<b>2. Warnings</b> .....	1
<b>3. Packing List</b> .....	2
<b>4. Guide to Parts</b> .....	3
4.1. Overview of the Camera Unit.....	3
4.2. Overview of the Baby Monitor ...	4
<b>5. Activate the Device</b> .....	6
5.1. Camera Unit .....	6
5.2. Baby Monitor .....	6
5.3. Pairing .....	6
<b>6. Using the Device</b> .....	7
6.1. Setting up .....	7
6.2. Pan, tilt, and zoom .....	8
6.3. Screenshot (TF card required) ...	8
6.4. Night vision mode.....	9
6.5. Talk Mode.....	9
6.6. Video on/off.....	9
6.7. Volume.....	9
<b>7. Baby Monitor Menu Options</b> .....	9
7.1. Playback (TF card required) .....	10
7.2. Vox Monitoring.....	10
7.3. Music .....	10
7.4. Feeding Clock .....	11
7.5. Camera.....	11
7.6. Bluetooth .....	12
7.7. General settings .....	14
<b>8. Maintenance</b> .....	15
<b>9. Troubleshooting</b> .....	16
<b>10. Specifications</b> .....	18
<b>11. Symbols</b> .....	19
<b>12. FCC Statement</b> .....	20

## **1. Introduction**

It is intended to monitor infants or children when they are alone through real-time images captured by the camera and audio communication. Also, paired with the optional device Baby Sleep Monitor, data of oxygen level and heart rate can be tracked and displayed through the integrated communication module of the camera, ensuring your acknowledgement of the child's conditions.

## **2. Warnings**

This device is compliant with all relevant standards regarding electromagnetic fields and is, when handled as described in the User's Guide, safe to use. Therefore, always read the instructions in this User's Guide carefully before using the device.

- Adult assembly is required. Keep small parts away from children when assembling.
- This product is not a toy. Do not allow children to play with it.
- This product is not a substitute for responsible adult supervision.
- Keep this user's guide for future reference.
- Keep the cords out of the reach of children.

- Do not cover the product with a towel or blanket.
- Test this monitor and all its functions so that you are familiar with it prior to actual use.
- Do not use the product in damp areas or close to water.
- Do not install the product in extreme cold or heat, direct sunlight, or close to a heat source.
- Only use the chargers and power adapters provided. Do not use other chargers or power adapters as this may damage the device and battery pack.
- Do not touch the plug contacts with sharp or metal objects.
- Connect the power adapters to easily accessible electrical outlets.

### **3. Packing List**

- Baby Monitor (Display screen, Model:BM-1R)
- Camera Unit ( Model:BM-1T)
- Charging Plug and Power Cable for Baby Monitor
- Charging Plug and Power Cable for Camera Unit
- Bracket
- User Manual

## 4. Guide to Parts

### 4.1. Overview of the Camera Unit

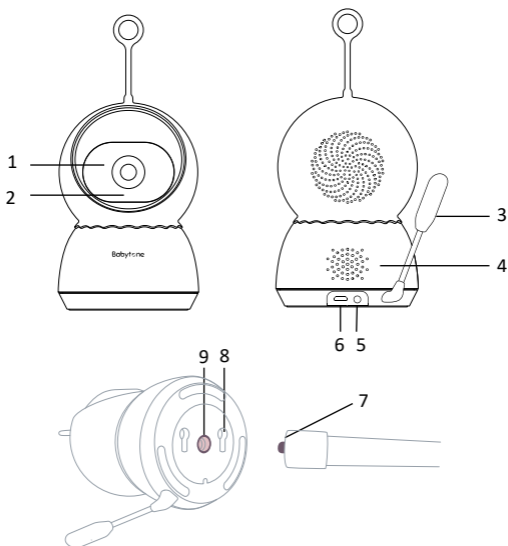

1. Camera Lens
2. Indicator LED
3. Temperature & Humidity Sensor
4. Speaker
5. Reset Key
6. Power Adapter Socket
7. Bracket
8. Screw Holes
9. Connection Hole

**Note:** You can either fix the camera to anywhere you need by adjusting the bracket or to the wall after inserting screws.

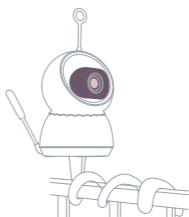

## 4.2. Overview of the Baby Monitor

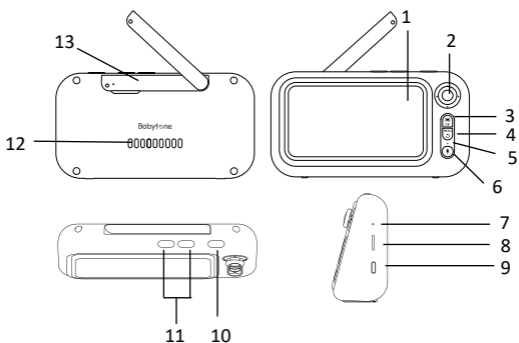

1. LCD Screen

2. Joystick

Camera mode: Tilt up or down, pan left or right.

Menu mode: Up, down, left, right.

3. OK Key

4. Menu/Exit Key

Press to open the Menu options or exit.

5. Indicator LED

Blue light: talking.

Green light: charging, it turns off when charging is complete.

6. Talk Key

Press to speak to your baby.

7. Microphone

8. TF Card Slot

9. Power Adapter Socket

10. Power Key

Long press to power on/off.

Short press to turn off/wake up screen.











11. Volume Key

12. Speaker

13. Antenna

Lift the antenna for optimal signal reception.

## Baby Monitor menu icons

Icon	Description
	Talk mode ON
	Recording
	Volume
	Ambient humidity
	Ambient temperature
	TF card full
	Vox monitor state
	Signal intensity
	Oxygen level (if paired with 'Baby Sleep Monitor')
	Heart rate(if paired with 'Baby Sleep Monitor')

\* The Baby Sleep Monitor is an optional device.

\* When the TF card is full, it will loop recording, please export the needed data (MENU>Camera>Record>Export) from the TF card before it is overwritten.

## 5. Activate the Device

### 5.1. Camera Unit

- a) Connect the micro USB interface of the power adapter to the Camera Unit, and the other end to the electrical outlet.

#### Note:

- Compatible power adapter output: DC 5V, 1A.

### 5.2. Baby Monitor

- a) Connect the Type C interface of the power adapter to the Baby Monitor and the other end to the electrical outlet for charging.
- b) Once the charging is finished. Press and hold the  Power key for 3 seconds to turn on the Baby Monitor.
- c) When the Camera Unit and Baby Monitor are all switched on, the pairing process will begin automatically.

#### Note:

- Compatible power adapter output: DC 5V, 2A.

### 5.3. Pairing

The Camera Unit has been paired with your Baby Monitor before delivery.

- a) Switch on the two units, the Baby Monitor will show a "No Camera" symbol .



- b) Wait patiently for automatic pairing, you can monitor the pairing process through the LED light on the camera.

Indicator	Status	Description
Purple, red, and blue light	30s alternating flashing	Power on, waiting for configuration
Red light	30s quick flashing	Unpaired, disconnected
Blue light	30s on then off	Paired, connected
	30s flashing then off	Paired, disconnected
	30s quick flashing then off	Configuring wireless network

If the Camera Unit lose its link with Baby Monitor or you need to pair with a new camera, follow the procedures below:

- a) Press the Menu Key on the Baby Monitor.
- b) Control the joystick to select Camera>Unbind to disconnect the current camera.

## 6. Using the Device

### 6.1. Setting up

- a) Place the Camera Unit in a convenient

location (e.g. on a table) and point the camera lens towards the area you want to monitor.

- b) Adjust the Camera Unit's angle by controlling the joystick to rotate the camera up, down, left and right until you are satisfied with the image in the Baby Monitor.

**Note:**

- Do not place the Camera Unit within baby's reach.
- If there is interference with the picture or sound, try moving the units to different locations, and ensure that they are not close to other electrical equipment.

## **6.2. Pan, tilt, and zoom**

The camera can be remotely controlled from the Baby Monitor.

- a) Manipulate the joystick to tilt upward or downward, or pan left or right.
- b) Double click the OK button to enter zoom mode, then press the volume -/+ button to select among 1X to 4X zoom.
- c) Press the Menu key to exit zoom mode.

## **6.3. Screenshot (TF card required)**



- a) Click the OK key during the monitoring to take a screenshot.

- b) Remove the TF card and check the pictures in your computer.

#### **6.4. Night vision mode**

The Camera Unit has high-intensity infrared LEDs for picking up clear images in the dark. When the built-in photo sensor detects a low level of ambient light, the LEDs will automatically activate and the screen on the Baby Monitor will display in black and white.

#### **6.5. Talk Mode**

Press the  TALK button on the Baby Monitor, and the icon  will be displayed at the top of the screen while the light is on. Then you can talk to your baby through the camera's loudspeaker.

#### **6.6. Video on/off**

Press the  Power key to turn the LCD display on or off. The monitor will enter sleep mode with audio on.

#### **6.7. Volume**

Press the + or - button to select the desired volume level from Level 0-4. (The default Volume level setting is Level 1.)

### **7. Baby Monitor Menu Options**

More functions can be accessed to by pressing the Menu key. Please control the joystick to select, press the OK key to

confirm, and press the Menu key to exit.

### **7.1. Playback (TF card required)**

This function is turned on by default (prompt the user to install TF card), you can activate it after inserting the TF card, please follow the procedures below:

- a) Press Menu>Playback, and select the record of a specific date.
- b) Press the OK key to stop or play the video.
- c) Control the joystick up or down to choose the desired speed.
- d) Control the joystick left or right to fast forward/backward with a step-size of 5 min (default)/30min/1h/2h.

### **7.2. Vox Monitoring**

- a) Press Menu>Vox.
- b) Select from options off, low, medium and high, and the icon  will be lightened at the top of the screen.
- c) Having set the sensitivity, the screen can be aroused from the sleep mode whenever the corresponding sound is detected.

### **7.3. Music**

- a) Press Menu>Music.
- b) Select your desired song from the 8 lullabies available, or turn on the loop option to play a single song

continuously or 8 songs in turn.

**Note:** The device cannot be muted in this page, the default volume is level 1. The volume can be changed in camera setting page, Menu>Setting>Camera.

#### 7.4. Feeding Clock

- a) Press Menu>Setting>Feeding Clock.
- b) Choose the desired duration and repeat or not. You will then be reminded by the clock.
- c) You can turn off the reminder in the message box.

#### 7.5. Camera

Press Menu>Setting>Camera to manage the camera.

- **Volume**

Choose the desired camera volume from the options.

- **Record**

- **Export:** export the needed video recordings to the TF card, then remove the card and check them in the computer.
- **Format:** clear the record data.
- **Record:** start/stop recording after inserting a TF card.

**Note:**

- The device features loop recording, please export the needed data from the TF card

before it is overwritten.

- One-eighth of the storage space is reserved for storing the exported video. It may need to be exported in stages when the video file is too large.
- Exporting will take more time when too many files are selected.
- No other operations are possible while the video is being exported.
- Taking out the TF card while recording will cause damage to it.
- **Upgrade**
  - 1) Download the latest firmware (if any) in the TF card.
  - 2) Choose Upgrade and press OK key to confirm.
  - 3) Wait few minutes to enjoy an updated camera, and restart the Baby monitor for the updated version.
- **Unbind**

Choose Unbind and press OK key to confirm.



## 7.6. Bluetooth

**Baby sleep monitor** is an optional device for monitoring the baby's heart rate and oxygen level.

## Pair with Baby Sleep Monitor (BBSM)

- a) If the monitor has never been paired with an BBSM, please press Menu>Setting>Bluetooth>Add device to start searching.
- b) Press and hold the Power key of BBSM to turn it on, and select its right name (BBSM S1+the last four number of SN) on the Monitor screen.
- c) If the devices are not successfully paired in 2 minutes, you can either return to last page or select 'Rescan'. If paired successfully, the device management page will be displayed.

### Note:

- The Baby Sleep Monitor will be automatically paired next time if it is not unbound. You could manage the BBSM in the Bluetooth page.
- The icon "--" and "--" will appear at the top of the screen when the BBSM is paired but no value is displayed yet.

## Manage the bluetooth device

- a) Press MENU>Setting>Bluetooth to start managing Reminder and Unbind.
- b) Modify reminder thresholds.

	Available Range	Step-size	Default value
Avg O <sub>2</sub> level	80-99	1	90
Heart rate (High)	110-200	10	130
Heart rate (Low)	40-100	10	70

Note:

- The reminders are off by default.
  - The reminder may pop up at any time accompanied by a notice when detecting a value out of the setting range. The notice will stop in 2 minutes after you press OK key.
- c) You can press Unbind to remove the current device.

## 7.7. General settings

Press Menu>Setting>General for the following settings.

- Display  
Select the desired display duration from the four options (1 minute, 10 minutes, 30 minutes, always).
- Brightness  
Select the desired brightness from the four options (40%,60%,80%,100%).



- **Date & Time**  
Select 12 Hour mode or 24 Hour mode. You can also press date or time to calibrate.
- **Language**  
Select the desired language from provided options.
- **Temperature**  
You can switch the temperature unit here.
- **System**  
Descriptions of both units are displayed. You can restore the default setting of the device by pressing the Default button, or unbind or upgrade (TF card required) the camera.

## **8. Maintenance**

Clean the device with a slightly damp cloth or with an anti-static cloth. Never use cleaning agents or abrasive solvents.

- Do not clean any part of the device with thinners or other solvents and chemicals - this may cause permanent damage to the product which is not covered by the warranty.
- Keep the device away from hot, humid areas or strong sunlight, and do not let it get wet.

- Every effort has been made to ensure high standards of reliability of the device. However, if something does go wrong, please do not try to repair it yourself - contact Customer Service for assistance.

**Note:**

Always power off and disconnect the power adapter before cleaning the device.

## **9. Troubleshooting**

If you experience difficulties in operating your device, refer to the troubleshooting guide below.

### **No display**

---

- Charge the device.
- Press and hold Power key on the Baby Monitor to turn it on.
- Press the reset on camera if no video in 30 seconds.

### **If the Camera Unit has lost its link with the Baby Monitor**

---

- Charge the device.
- Move the Camera Unit closer to the Baby Monitor.
- Reset the units by disconnecting them from the power supply. Wait

for about 15 seconds before reconnecting.

- See 5.3 Pairing, if there is a need to re-register the units.
- The reset key may be mistakenly pressed. Please unbind the Camera Unit from Baby Monitor, then wait for the automatic pairing with Camera Unit powered on.

### **Noise interference on your Baby Monitor**

- Make sure that there is at least 3 to 6 feet between the 2 units to avoid audio feedback.
- The Camera Unit may go out of range if it is too far away. Move the Camera Unit closer to the Baby Monitor.
- Make sure that the Baby and Baby Monitors are not near other electrical equipment, such as a television, computer or cordless/mobile telephone.
- Keep the device at least 5ft (1.5m) away from 2.4 GHz products or turn them off.
- If the signal is weak, try moving the Baby Monitor and/or Camera Unit to different positions in the rooms.

## 10. Specifications







### Baby Monitor

Frequency	2.4 GHz
Brightness control	4 steps
Volume control	4 steps
Resolution ratio	720P
Temperature	-10°C ~ 45°C (Operating) -30°C ~ 70°C (Storage)
Humidity	20% ~ 85% (Operating) 20% ~ 85% (Storage)
Battery	4400mAh rechargeable lithium-polymer battery
Adapter	5V/2A
Interface	Type-C

### Camera Unit

Frequency	2.4 GHz
Image sensor	GC2053 (1/2.9)
Resolution ratio	1080P
Lens	f 3.92mm
IR LED	940nm×4
Viewing angle	94.9°(D)/79.1° (H)
Temperature	-10°C ~ 45°C (Operating) -30°C ~ 70°C (Storage)
Humidity	20% ~ 85% (Operating) 20% ~ 85% (Storage)
Adapter	5V/1A
Interface	Type C

## 11. Symbols

Symbol	Description
	Manufacturer
	Date of manufacture
SN	Serial number
	Indicates a medical device that is not to be disposed of as unsorted municipal waste.
	Follow Instructions for Use.
FC	This product complies with the rules and regulations of the Federal Communication Commission.
	Non-ionizing radiation
CE	CE marking
	This product complies with verpackG

## 12. FCC Statement

FCC Warning:

FCC ID: 2AD XK-1662 (Model: BM-1T)

2AD XK-1663 (Model: BM-1R)

Any Changes or modifications not expressly approved by the party responsible for compliance could void the user's authority to operate the equipment. This device complies with part 15 of the FCC Rules. Operation is subject to the following two conditions:

- (1) This device may not cause harmful interference, and
- (2) this device must accept any interference received, including interference that may cause undesired operation.

Note: This equipment has been tested and found to comply with the limits for a Class B digital device, pursuant to part 15 of the FCC Rules. These limits are designed to provide reasonable protection against harmful interference in a residential installation. This equipment generates uses and can radiate radio frequency energy and, if not installed and used in accordance with the instructions, may cause harmful interference to radio communications. However, there is no guarantee that interference will not occur in a particular installation. If this equipment does cause harmful interference to radio or television reception, which can be determined by

turning the equipment off and on, the user is encouraged to try to correct the interference by one or more of the following measures:

- Reorient or relocate the receiving antenna.
- Increase the separation between the equipment and receiver.
- Connect the equipment into an outlet on a circuit different from that to which the receiver is connected.
- Consult the dealer or an experienced radio/TV technician for help.

The device has been evaluated to meet general RF exposure requirement.

The following Warning only applies to model BM-1T:

To maintain compliance with FCC's RF exposure guidelines, the distance must be at least 20 cm between the radiator and your body, and fully supported by the operating and installation configurations of the transmitter and its antenna(s).



**Shenzhen Viatom Technology Co., Ltd**

4E, Building 3, Tingwei Industrial Park  
No. 6 Liufang Road, Block 67 Xin'an  
Street, Baoan District, Shenzhen,  
518101, Guangdong, China



Product name: Baby Monitor

Model: BM-1T

Product name: Baby Monitor

Model: BM-1R

Version: A

Date: September 22, 2022