

S

T

S

L

A

B



FCC SAR TEST REPORT

Report No.: STS2211055H01

Issued for

Shenzhen Viatom Technology Co., Ltd.

4E, 3#, Tingwei Industrial Park, Honglang North 2nd Road,
Baoan District, Shenzhen, 518057, China

Product Name:	Baby Monitor
Brand Name:	N/A
Model Name:	BM-1R
Series Model:	N/A
FCC ID:	2ADXK-1663
Test Standard:	ANSI/IEEE Std. C95.1
	FCC 47 CFR Part 2 (2.1093)
	IEEE 1528: 2013
Max. Report SAR (1g):	Body: 0.675 W/kg

Any reproduction of this document must be done in full. No single part of this document may be reproduced without permission from STS, All Test Data Presented in this report is only applicable to presented Test sample.

ShenZhen STS Test Services Co.,Ltd.

A 1/F, Building B, Zhuoke Science Park, No.190 Chongqing Road, HepingShequ, Fuyong Sub-District, Bao'an District, Shenzhen, Guang Dong, China

TEL: +86-755 3688 6288 FAX: +86-755 3688 6277 E-mail:sts@stsapp.com

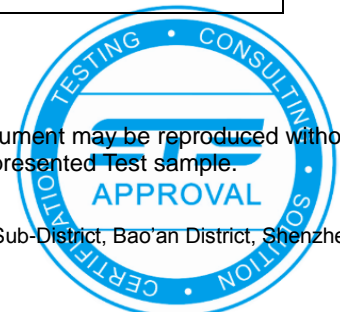



Test Report Certification

Applicant's name : Shenzhen Viatom Technology Co., Ltd.
Address : 4E, 3#, Tingwei Industrial Park, Honglang North 2nd Road, Baoan District, Shenzhen, 518057, China
Manufacturer's Name : Shenzhen Viatom Technology Co., Ltd.
Address : 4E, 3#, Tingwei Industrial Park, Honglang North 2nd Road, Baoan District, Shenzhen, 518057, China

Product description

Product name : Baby Monitor
Brand name : N/A
Model name : BM-1R
Series Model..... : N/A

Standards..... : ANSI/IEEE Std. C95.1-1992
 FCC 47 CFR Part 2 (2.1093)
 IEEE 1528: 2013

The device was tested by Shenzhen STS Test Services Co., Ltd. in accordance with the measurement methods and procedures specified in KDB 865664 The test results in this report apply only to the tested sample of the stated device/equipment. Other similar device/equipment will not necessarily produce the same results due to production tolerance and measurement uncertainties.

Date of Test..... :
Date (s) of performance of tests..... : 14 Nov. 2022
Date of Issue..... : 15 Nov. 2022
Test Result..... : **Pass**

Testing Engineer : Shi fan-long
 (Shifan. Long)

Technical Manager : Sean she
 (Sean she)

Authorized Signatory : Bovey Yang
 (Bovey Yang)





Table of Contents

1. General Information	5
1.1 EUT Description	5
1.2 Test Environment	6
1.3 Test Factory	6
2. Test Standards and Limits	7
3. SAR Measurement System	8
3.1 Definition of Specific Absorption Rate (SAR)	8
3.2 SAR System	8
4. Tissue Simulating Liquids	11
4.1 Simulating Liquids Parameter Check	11
5. SAR System Validation	13
5.1 Validation System	13
5.2 Validation Result	13
6. SAR Evaluation Procedures	14
7. EUT Antenna Location Sketch	15
7.1 SAR test exclusion consider table	16
8. EUT Test Position	19
8.1 Body-worn Position Conditions	19
9. Uncertainty	20
9.1 Measurement Uncertainty	20
10. Conducted Power Measurement	21
10.1 Test Result	21
11. EUT and Test Setup Photo	22
11.1 EUT Photo	22
11.2 Setup Photo	26
12. SAR Result Summary	29
12.1 Body-worn SAR	29
13. Equipment List	30
Appendix A. System Validation Plots	31
Appendix B. SAR Test Plots	33
Appendix C. Probe Calibration and Dipole Calibration Report	35

**Revision History**

Rev.	Issue Date	Report No.	Effect Page	Contents
00	15 Nov. 2022	STS2211055H01	ALL	Initial Issue





1. General Information

Environmental evaluation measurements of specific absorption rate (SAR) distributions in emulated human head and body tissues exposed to radio frequency (RF) radiation from wireless portable devices for compliance with the rules and regulations of the U.S. Federal Communications Commission (FCC).

1.1 EUT Description

Product Name	Baby Monitor		
Brand Name	N/A		
Model Name	BM-1R		
Series Model	N/A		
Model Difference	N/A		
Battery	Rated Voltage: DC 3.8V		
Device Category	Portable		
Product stage	Production unit		
RF Exposure Environment	General Population / Uncontrolled		
Hardware Version	V1.0		
Software Version	V1.0		
Frequency Range	WLAN802.11b/g/n20: 2412 MHz ~ 2462 MHz WLAN 802.11n40: 2422 MHz ~ 2452 MHz		
Max. Reported SAR(1g): (Limit:1.6W/kg)	Band	Mode	Body Worn (W/kg)
	DTS	2.4G WLAN 0degrees	0.647
	DTS	2.4G WLAN 90degrees	0.675
FCC Equipment Class	Digital Transmission System (DTS)		
Operating Mode:	2.4G WLAN : 802.11b(DSSS):CCK,DQPSK,DBPSK 802.11g(OFDM):BPSK,QPSK,16-QAM,64-QAM 802.11n(OFDM):BPSK,QPSK,16-QAM,64-QAM		
Antenna Specification:	External antenna		
DTM Mode	Not Support		
Note:	1. The EUT battery must be fully charged and checked periodically during the test to ascertain uniform power		



1.2 Test Environment

Ambient conditions in the SAR laboratory:

Items	Required
Temperature (°C)	18-25
Humidity (%RH)	30-70

1.3 Test Factory

ShenZhen STS Test Services Co.,Ltd.

A 1/F, Building B, Zhuoke Science Park, No.190 Chongqing Road, HepingShequ, Fuyong Sub-District, Bao'an District, Shenzhen, Guang Dong, China

FCC test Firm Registration No.: 625569

IC Registration No.: 12108A

A2LA Certificate No.: 4338.01





2. Test Standards and Limits

No.	Identity	Document Title
1	47 CFR Part 2	Frequency Allocations and Radio Treaty Matters; General Rules and Regulations
2	ANSI/IEEE Std. C95.1-1992	IEEE Standard for Safety Levels with Respect to Human Exposure to Radio Frequency Electromagnetic Fields, 3 kHz to 300 GHz
3	IEEE Std. 1528-2013	Recommended Practice for Determining the Peak Spatial-Average Specific Absorption Rate (SAR) in the Human Head from Wireless Communications Devices: Measurement Techniques
4	FCC KDB 447498 D04 v01	RF Exposure Procedures and Equipment Authorization Policies for Mobile and Portable Devices
5	FCC KDB 865664 D01 v01r04	SAR Measurement 100 MHz to 6 GHz
6	FCC KDB 865664 D02 v01r02	RF Exposure Reporting
7	FCC KDB 648474 D04 v01r03	SAR Evaluation Considerations for Wireless Handsets
8	FCC KDB 248227 D01 Wi-Fi SAR v02r02	SAR Considerations for 802.11 Devices

(A). Limits for Occupational/Controlled Exposure (W/kg)

Whole-Body	Partial-Body	Hands, Wrists, Feet and Ankles
0.4	8.0	20.0

(B). Limits for General Population/Uncontrolled Exposure (W/kg)

Whole-Body	Partial-Body	Hands, Wrists, Feet and Ankles
0.08	1.6	4.0

NOTE: Whole-Body SAR is averaged over the entire body, partial-body SAR is averaged over any 1 gram of tissue defined as a tissue volume in the shape of a cube. SAR for hands, wrists, feet and ankles is averaged over any 10 grams of tissue defined as a tissue volume in the shape of a cube.

Population/Uncontrolled Environments:

Are defined as locations where there is the exposure of individuals who have no knowledge or control of their exposure.

Occupational/Controlled Environments:

Are defined as locations where there is exposure that may be incurred by people who are aware of the potential for exposure, (i.e. as a result of employment or occupation).

NOTE

GENERAL POPULATION/UNCONTROLLED EXPOSURE

PARTIAL BODY LIMIT

1.6 W/kg

3. SAR Measurement System

3.1 Definition of Specific Absorption Rate (SAR)

SAR is related to the rate at which energy is absorbed per unit mass in an object exposed to a radio field. The SAR distribution in a biological body is complicated and is usually carried out by experimental techniques or numerical modeling. The standard recommends limits for two tiers of groups, occupational/controlled and general population/uncontrolled, based on a person's awareness and ability to exercise control over his or her exposure. In general, occupational/controlled exposure limits are higher than the limits for general population/uncontrolled.

The SAR definition is the time derivative (rate) of the incremental energy (dW) absorbed by (dissipated in) an incremental mass (dm) contained in a volume element (dv) of a given density (ρ). The equation description is as below:

$$SAR = \frac{d}{dt} \left(\frac{dW}{dm} \right) = \frac{d}{dt} \left(\frac{dW}{\rho dv} \right)$$

SAR is expressed in units of Watts per kilogram (W/kg) SAR measurement can be related to the electrical field in the tissue by

$$SAR = \frac{\sigma E^2}{\rho}$$

Where: σ is the conductivity of the tissue,
ρ is the mass density of the tissue and E is the RMS electrical field strength.

3.2 SAR System

MVG SAR System Diagram:

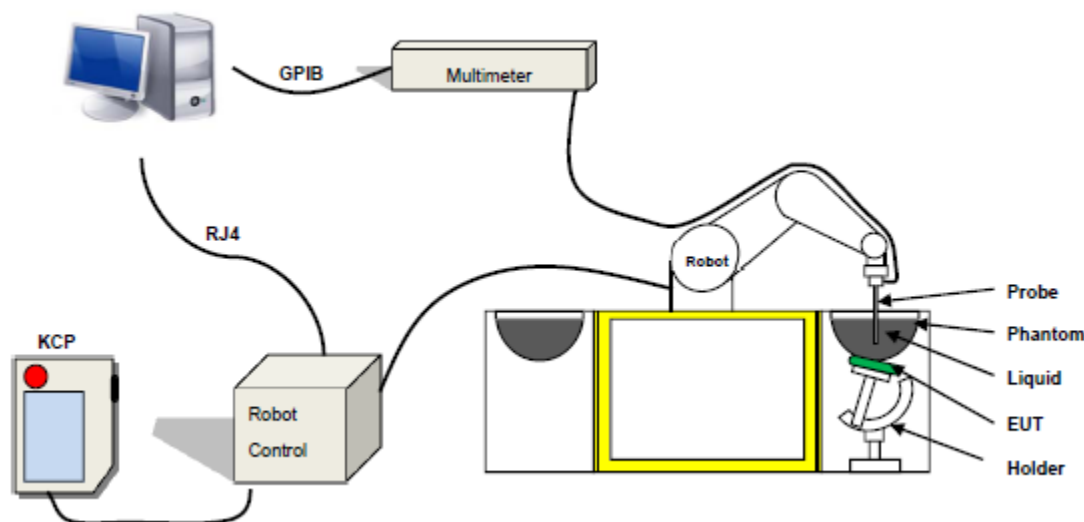

COMOSAR is a system that is able to determine the SAR distribution inside a phantom of human being according to different standards. The COMOSAR system consists of the following items:

- Main computer to control all the system
- 6 axis robot
- Data acquisition system
- Miniature E-field probe
- Phone holder
- Head simulating tissue

The following figure shows the system.



The EUT under test operating at the maximum power level is placed in the phone holder, under the phantom, which is filled with head simulating liquid. The E-Field probe measures the electric field inside the phantom. The Open SAR software computes the results to give a SAR value in a 1g or 10g mass.

3.2.1 Probe

For the measurements the Specific Dosimetric E-Field Probe SN 07/21 EPGO352 with following specifications is used

- Probe Length: 330 mm
- Length of Individual Dipoles: 2 mm
- Maximum external diameter: 8 mm
- Probe Tip External Diameter: 2.5 mm
- Distance between dipole/probe extremity: 1 mm
- Dynamic range: 0.01-100 W/kg
- Probe linearity: 3%
- Axial Isotropy: < 0.10 dB
- Spherical Isotropy: < 0.10 dB
- Calibration range: 150 MHz to 6 GHz for head & body simulating liquid.
- Angle between probe axis (evaluation axis) and surface normal line: less than 30°



Figure 1-MVG COMOSAR Dosimetric E field Dipole

3.2.2 Phantom

For the measurements the Specific Anthropomorphic Mannequin (SAM) defined by the IEEE SCC-34/SC2 group is used. The phantom is a polyurethane shell integrated in a wooden table. The thickness of the phantom amounts to 2mm +/- 0.2mm. It enables the dosimetric evaluation of left and right phone usage and includes an additional flat phantom part for the simplified performance check. The phantom set-up includes a cover, which prevents the evaporation of the liquid.

SN 32/14 SAM115



Figure-SN 21/21 ELLI48



3.2.3 Device Holder

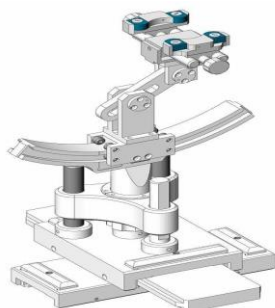

The SAR in the phantom is approximately inversely proportional to the square of the distance between the source and the liquid surface. For a source at 5 mm distance, a positioning uncertainty of ± 0.5 mm would produce a SAR uncertainty of ± 20 %. Accurate device positioning is therefore crucial for accurate and repeatable measurements. The positions in which the devices must be measured are defined by the standards.



4. Tissue Simulating Liquids

4.1 Simulating Liquids Parameter Check

The head tissue dielectric parameters recommended by the IEEE SCC-34/SC-2 in P1528 have been incorporated in the following table. These head parameters are derived from planar layer models simulating the highest expected SAR for the dielectric properties and tissue thickness variations in a human head. Other head and body tissue parameters that have not been specified in P1528 are derived from the tissue dielectric parameters computed from the 4-Cole-Cole equations described in Reference [12] and extrapolated according to the head parameters specified in P1528.

Head Tissue

Frequency (MHz)	cellulose	DGBE	HEC	NaCl	Preventol	Sugar	X100	Water	Conductivity	Permittivity
	%	%	%	%	%	%	%	%	σ	ϵ_r
750	0.2	/	/	1.4	0.2	57.0	/	41.1	0.89	41.9
835	0.2	/	/	1.4	0.2	57.9	/	40.3	0.90	41.5
900	0.2	/	/	1.4	0.2	57.9	/	40.3	0.97	41.5
1800	/	44.5	/	0.3	/	/	30.45	55.2	1.4	40.0
1900	/	44.5	/	0.3	/	/	30.45	55.2	1.4	40.0
2000	/	44.5	/	0.3	/	/	/	55.2	1.4	40.0
2450	/	44.9	/	0.1	/	/	/	55.0	1.80	39.2
2600	/	45.0	/	0.1	/	/	/	54.9	1.96	39.0

Body Tissue

Frequency (MHz)	cellulose	DGBE	HEC	NaCl	Preventol	Sugar	X100	Water	Conductivity	Permittivity
	%	%	%	%	%	%	%	%	σ	ϵ_r
750	0.2	/	/	0.9	0.1	47.2	/	51.7	0.96	55.5
835	0.2	/	/	0.9	0.1	48.2	/	50.8	0.97	55.2
900	0.2	/	/	0.9	0.1	48.2	/	50.8	1.05	55.0
1800	/	29.4	/	0.4	/	/	30.45	70.2	1.52	53.3
1900	/	29.4	/	0.4	/	/	30.45	70.2	1.52	53.3
2000	/	29.4	/	0.4	/	/	/	70.2	1.52	53.3
2450	/	31.3	/	0.1	/	/	/	68.6	1.95	52.7
2600	/	31.7	/	0.1	/	/	/	68.2	2.16	52.3

Tissue dielectric parameters for head and body phantoms

Frequency	ϵ_r		σ S/m	
	Head	Body	Head	Body
	300	45.3	58.2	0.87
450	43.5	56.7	0.87	0.94
900	41.5	55.0	0.97	1.05
1450	40.5	54.0	1.20	1.30
1800	40.0	53.3	1.40	1.52
2450	39.2	52.7	1.80	1.95
3000	38.5	52.0	2.40	2.73
5800	35.3	48.2	5.27	6.00

**LIQUID MEASUREMENT RESULTS**

Date	Ambient		Simulating Liquid		Parameters	Target	Measured	Deviation %	Limited %
	Temp. [°C]	Humidity %	Frequency (MHz)	Temp. [°C]					
2022-11-14	21.0	49	2412	20.7	Permittivity	39.27	40.62	3.44	±5
					Conductivity	1.77	1.71	-3.39	±5
2022-11-14	21.1	49	2437	20.8	Permittivity	39.22	39.90	1.73	±5
					Conductivity	1.79	1.77	-1.12	±5
2022-11-14	21.2	49	2450	21.0	Permittivity	39.20	39.95	1.91	±5
					Conductivity	1.80	1.76	-2.22	±5
2022-11-14	21.2	50	2462	20.9	Permittivity	39.18	40.52	3.42	±5
					Conductivity	1.81	1.76	-2.76	±5



5. SAR System Validation

5.1 Validation System

Each MVG system is equipped with one or more system validation kits. These units, together with the predefined measurement procedures within the MVG software, enable the user to conduct the system performance check and system validation. System kit includes a dipole, and dipole device holder. The system check verifies that the system operates within its specifications. It's performed daily or before every SAR measurement. The system check uses normal SAR measurement in the flat section of the phantom with a matched dipole at a specified distance. The system validation setup is shown as below.

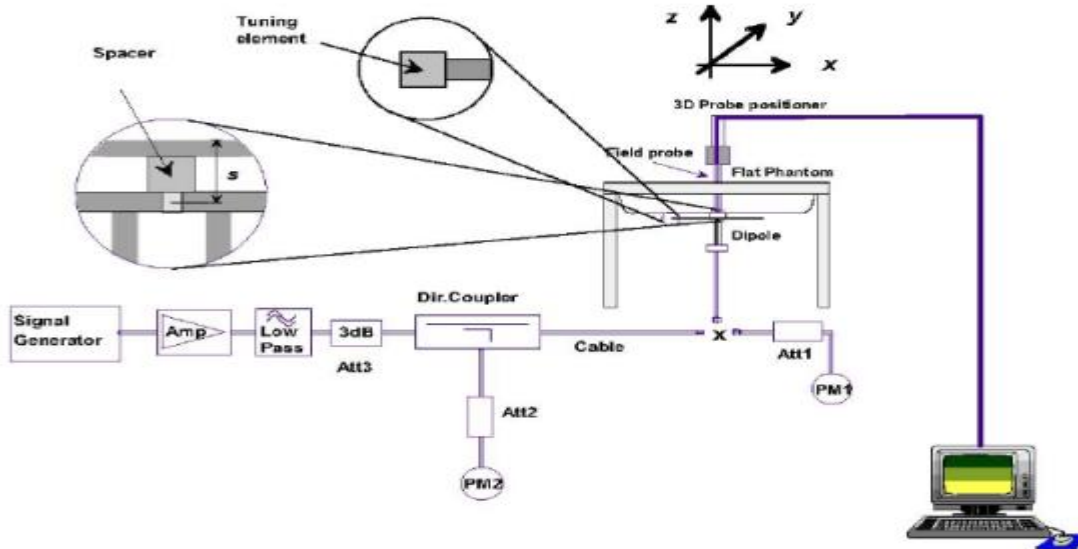

5.2 Validation Result

Comparing to the original SAR value provided by MVG, the validation data should be within its specification of 10 %.

Date	Freq.	Power	Tested Value	Normalized SAR	Target SAR	Tolerance	Limit
	(MHz)	(mW)	(W/Kg)	(W/kg)	1g(W/kg)	(%)	(%)
2022-11-14	2450	100	5.440	54.40	54.70	-0.55	10

Note:

1. The tolerance limit of System validation $\pm 10\%$.
2. The dipole input power (forward power) was 100 mW.
3. The results are normalized to 1 W input power.



6. SAR Evaluation Procedures

The procedure for assessing the average SAR value consists of the following steps:

The following steps are used for each test position

- Establish a call with the maximum output power with a base station simulator. The connection between the mobile and the base station simulator is established via air interface
- Measurement of the local E-field value at a fixed location. This value serves as a reference value for calculating a possible power drift.
- Measurement of the SAR distribution with a grid of 8 to 16mm * 8 to 16 mm and a constant distance to the inner surface of the phantom. Since the sensors cannot directly measure at the inner phantom surface, the values between the sensors and the inner phantom surface are extrapolated. With these values the area of the maximum SAR is calculated by an interpolation scheme.
- Around this point, a cube of 30 * 30 * 30 mm or 32 * 32 * 32 mm is assessed by measuring 5 or 8 * 5 or 8*4 or 5 mm. With these data, the peak spatial-average SAR value can be calculated.

➤ Area Scan& Zoom Scan

First Area Scan is used to locate the approximate location(s) of the local peak SAR value(s). The measurement grid within an Area Scan is defined by the grid extent, grid step size and grid offset. Next, in order to determine the EM field distribution in a three-dimensional spatial extension, Zoom Scan is required. The Zoom Scan is performed around the highest E-field value to determine the averaged SAR-distribution over 10 g. Area scan and zoom scan resolution setting follows KDB 865664 D01 quoted below.

When the 1-g SAR of the highest peak is within 2 dB of the SAR limit, additional zoom scans are required for other peaks within 2 dB of the highest peak that have not been included in any zoom scan to ensure there is no increase in SAR.

7. EUT Antenna Location Sketch

It is a Baby Monitor, support 2.4G WIFI mode.

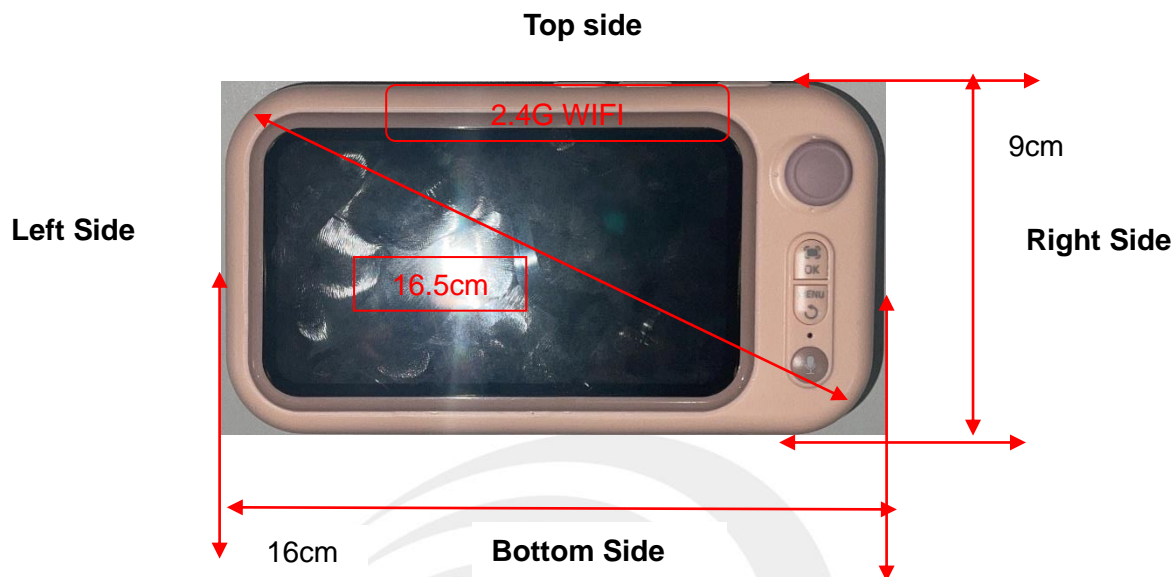

Antenna Separation Distance(cm)						
ANT	Back Side	Front Side	Left Side	Right Side	Top Side	Bottom Side
2.4G_0 degree	≤0.5	1.2	3.7	3.7	≤0.5	7.3
2.4G_90 degree	≤0.5	1.2	3.7	12	≤0.5	7.3

Note 1: The antenna information refer the manufacturer provide report, applicable only to the tested sample identified in the report.



7.1 SAR test exclusion consider table

The 2.4G SAR evaluation of Maximum power (dBm) summing tolerance.

Exposure Position	Wireless Interface	2.4G WLAN 0degrees	2.4G WLAN 90degrees
	Calculated Frequency(GHz)	2.462	2.462
	Maximum Turn-up power (dBm)	10	10
	Maximum rated power(mW)	10.00	10.00
Back Side	Separation distance (cm)	≤0.5	≤0.5
	exclusion threshold(mW)	2.73	2.73
	Testing required?	YES	YES
Front Side	Separation distance (cm)	1.2	1.2
	exclusion threshold(mW)	14.46	14.46
	Testing required?	NO	NO
Left Side	Separation distance (cm)	3.7	3.7
	exclusion threshold(mW)	123.31	123.31
	Testing required?	NO	NO
Right Side	Separation distance (cm)	3.7	12
	exclusion threshold(mW)	123.31	1157.43
	Testing required?	NO	NO
Top Side	Separation distance (cm)	≤0.5	≤0.5
	exclusion threshold(mW)	2.73	2.73
	Testing required?	YES	YES
Bottom Side	Separation distance (cm)	7.3	7.3
	exclusion threshold(mW)	449.44	449.44
	Testing required?	NO	NO

Note:

1. maximum power is the source-based time-average power and represents the maximum RF output power among production units.
2. Per KDB 447498 D04, for larger devices, the test separation distance of adjacent edge configuration is determined by the closest separation between the antenna and the user.

3. Per KDB 447498 D04, if the maximum time-averaged power available does not exceed 1 mW. This stand-alone SAR exemption test.
4. Per KDB 447498 D04, the available maximum time-averaged power or effective radiated power (ERP), whichever is greater, is less than or equal to the threshold P_{th} (mW) described in the following formula. This method shall only be used at separation distances (cm) from 0.5 centimeters to 40 centimeters and at frequencies from 0.3 GHz to 6 GHz (inclusive). P_{th} is given by:

$$P_{th} \text{ (mW)} = \begin{cases} ERP_{20 \text{ cm}} (d/20 \text{ cm})^x & d \leq 20 \text{ cm} \\ ERP_{20 \text{ cm}} & 20 \text{ cm} < d \leq 40 \text{ cm} \end{cases}$$

Where

$$x = -\log_{10} \left(\frac{60}{ERP_{20 \text{ cm}} \sqrt{f}} \right) \text{ and } f \text{ is in GHz;}$$

and

$$ERP_{20 \text{ cm}} \text{ (mW)} = \begin{cases} 2040f & 0.3 \text{ GHz} \leq f < 1.5 \text{ GHz} \\ 3060 & 1.5 \text{ GHz} \leq f \leq 6 \text{ GHz} \end{cases}$$

d = the separation distance (cm);

5. Per KDB 447498 D04, An alternative to the SAR-based exemption is using below table and the minimum separation distance (R in meters) from the body of a nearby person for the frequency (f in MHz) at which the source operates, the ERP (watts) is no more than the calculated value prescribed for that frequency. For the exemption in below table to apply, R must be at least $\lambda/2\pi$, where λ is the free-space operating wavelength in meters. If the ERP of a single RF source is not easily obtained, then the available maximum time-averaged power may be used in lieu of ERP if the physical dimensions of the radiating structure(s) do not exceed the electrical length of $\lambda/4$ or if the antenna gain is less than that of a half-wave dipole (1.64 linear value).

RF Source frequency (MHz)	Threshold ERP(watts)
0.3-1.34	1,920 R ² .
1.34-30	3,450 R ² /f ² .
30-300	3.83 R ² .
300-1,500	0.0128 R ² f.
1,500-100,000	19.2R ² .



6. Per KDB 248227 D01, choose the highest output power channel to test SAR and determine further SAR exclusion 8. for each frequency band, testing at higher data rates and higher order modulations is not required when the maximum average output power for each of each of these configurations is less than 1/4db higher than those measured at the lower data rate than 11b mode, thus the SAR can be excluded.
7. Per KDB 616217 D04, SAR evaluation for the front surface of tablet display screens are generally not necessary.



8. EUT Test Position

This EUT was tested in Back Side, and Top Side.

8.1 Body-worn Position Conditions

Body-worn Position Conditions:

Body-worn accessory exposure is typically related to voice mode operations when handsets are carried in body-worn accessories. The body-worn accessory procedures in KDB Publication 447498 D01 should be used to test for body-worn accessory SAR compliance, without a headset connected to it. When the same wireless transmission configuration is used for testing body-worn accessory and hotspot mode SAR, respectively, in voice and data mode, SAR results for the most conservative *test separation distance* configuration may be used to support both SAR conditions. When the *reported SAR* for a body-worn accessory, measured without a headset connected to the handset, is $> 1.2 \text{ W/kg}$, the highest *reported SAR* configuration for that wireless mode and frequency band should be repeated for the body-worn accessory with a headset attached to the handset.

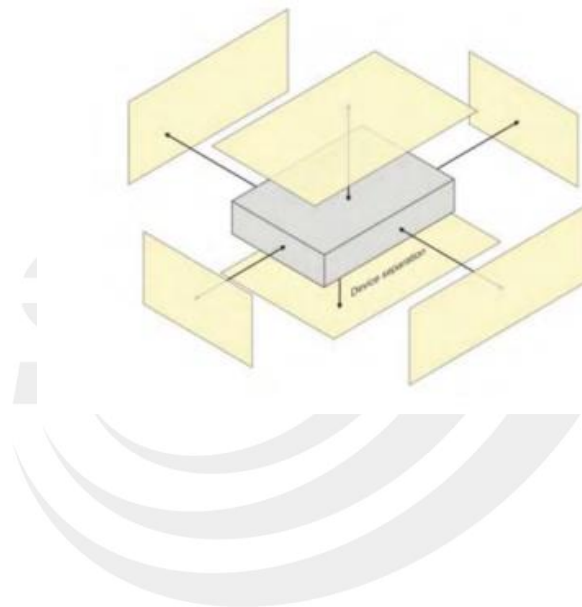



9. Uncertainty

9.1 Measurement Uncertainty

The following measurement uncertainty levels have been estimated for tests performed on the EUT as specified in IEEE 1528: 2013. This uncertainty represents an expanded uncertainty expressed at approximately the 95% confidence level using a coverage factor of k=2.

Uncertainty Component	Tol (+-%)	Prob. Dist.	Div.	Ci (1g)	Ci (10g)	1g Ui (+-%)	10g Ui (+-%)	vi
Measurement System								
Probe calibration	5.72	N	1	1	1	5.72	5.72	∞
Axial Isotropy	0.18	R	$\sqrt{3}$	$\sqrt{0.5}$	$\sqrt{0.5}$	0.07	0.07	∞
Hemispherical Isotropy	1.04	R	$\sqrt{3}$	$\sqrt{0.5}$	$\sqrt{0.5}$	0.42	0.42	∞
Boundary effect	0.8	R	$\sqrt{3}$	1	1	0.46	0.46	∞
Linearity	1.25	R	$\sqrt{3}$	1	1	0.72	0.72	∞
System detection limits	1.20	R	$\sqrt{3}$	1	1	0.69	0.69	∞
Modulation response	3.42	R	$\sqrt{3}$	1	1	3.42	3.42	∞
Readout Electronics	0.26	N	1	1	1	0.26	0.26	∞
Response Time	0.17	R	$\sqrt{3}$	1	1	0.10	0.10	∞
Integration Time	1.43	R	$\sqrt{3}$	1	1	0.83	0.83	∞
RF ambient conditions-Noise	3.51	R	$\sqrt{3}$	1	1	2.03	2.03	∞
RF ambient conditions-reflections	3.15	R	$\sqrt{3}$	1	1	1.82	1.82	∞
Probe positioner mechanical tolerance	1.2	R	$\sqrt{3}$	1	1	0.69	0.69	∞
Probe positioning with respect to phantom shell	1.4	R	$\sqrt{3}$	1	1	0.81	0.81	∞
Post-processing	2.1	R	$\sqrt{3}$	1	1	1.21	1.21	∞
Test sample Related								
Test sample positioning	3.1	N	1	1	1	3.10	3.10	∞
Device holder uncertainty	3.8	N	1	1	1	3.80	3.80	∞
SAR drift measurement	4.5	R	$\sqrt{3}$	1	1	2.60	2.60	∞
SAR scaling	1.8	R	$\sqrt{3}$	1	1	1.04	1.04	∞
Phantom and tissue parameters								
Phantom uncertainty (shape and thickness uncertainty)	3.7	R	$\sqrt{3}$	1	1	2.14	2.14	∞
Uncertainty in SAR correction for deviations in permittivity and conductivity	2.1	N	1	1	0.84	2.10	1.76	∞
Liquid conductivity (temperature uncertainty)	2.4	R	$\sqrt{3}$	0.78	0.71	1.87	1.70	∞
Liquid conductivity (measured)	4.1	N	1	0.78	0.71	0.94	1.07	M
Liquid permittivity (temperature uncertainty)	2.7	R	$\sqrt{3}$	0.23	0.26	2.11	1.92	∞
Liquid permittivity (measured)	4.8	N	1	0.23	0.26	1.10	1.25	M
Combined Standard Uncertainty		RSS				10.37	10.27	
Expanded Uncertainty (95% Confidence interval)		K=2				20.74	20.53	



10. Conducted Power Measurement

10.1 Test Result

2.4GWIFI				
Mode	Channel Number	Frequency (MHz)	Average Power (dBm)	Output Power (mW)
802.11b	1	2412	9.58	9.08
	7	2437	9.6	9.12
	11	2462	9.78	9.51
802.11g	1	2412	11.63	14.55
	7	2437	11.63	14.55
	11	2462	11.49	14.09
802.11 n-HT20	1	2412	11.35	13.65
	7	2437	11.43	13.90
	11	2462	11.35	13.65
802.11 n-HT40	3	2422	10.49	11.19
	6	2437	10.53	11.30
	9	2452	10.45	11.09

11. EUT and Test Setup Photo

11.1 EUT Photo

Front side 90 degree



Back side 90 degree



Top side 90 degree



Bottom side 90 degree

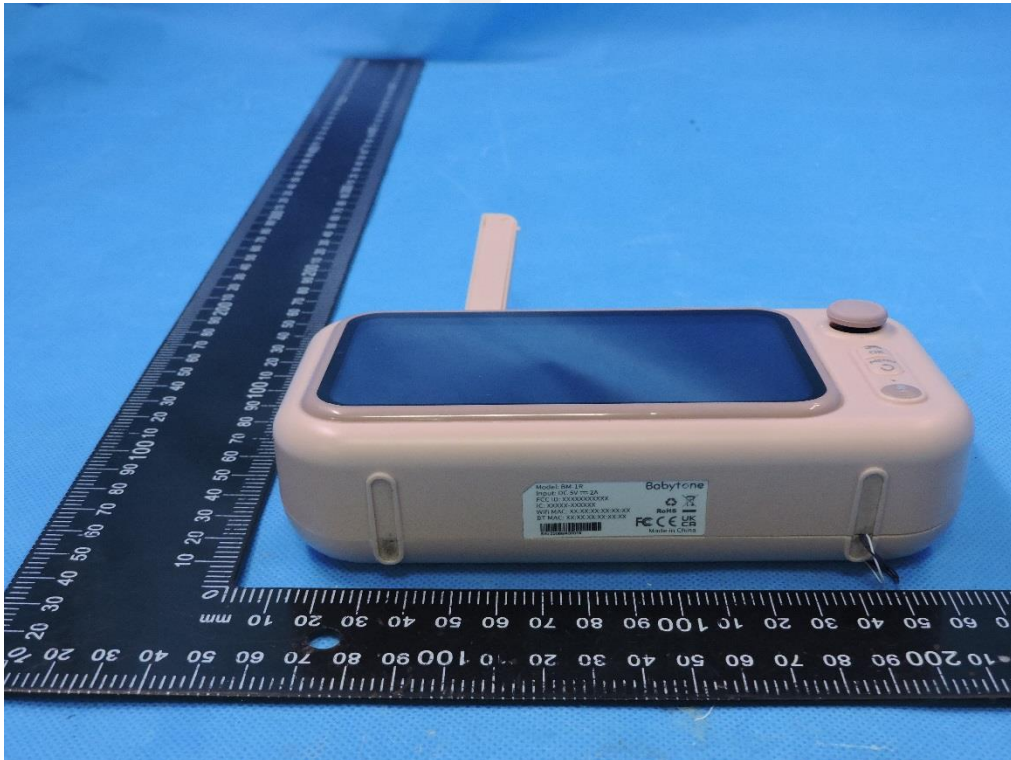

Left side 90 degree



Right side 90 degree



Front side 0degree



11.2 Setup Photo

Body Back side 0 degree (separation distance is 0mm)



Body Top side 0 degree (separation distance is 0mm)



Body Back side 90 degree (separation distance is 0mm)



Body Top side 90 degree (separation distance is 0mm)





Liquid depth (15 cm)

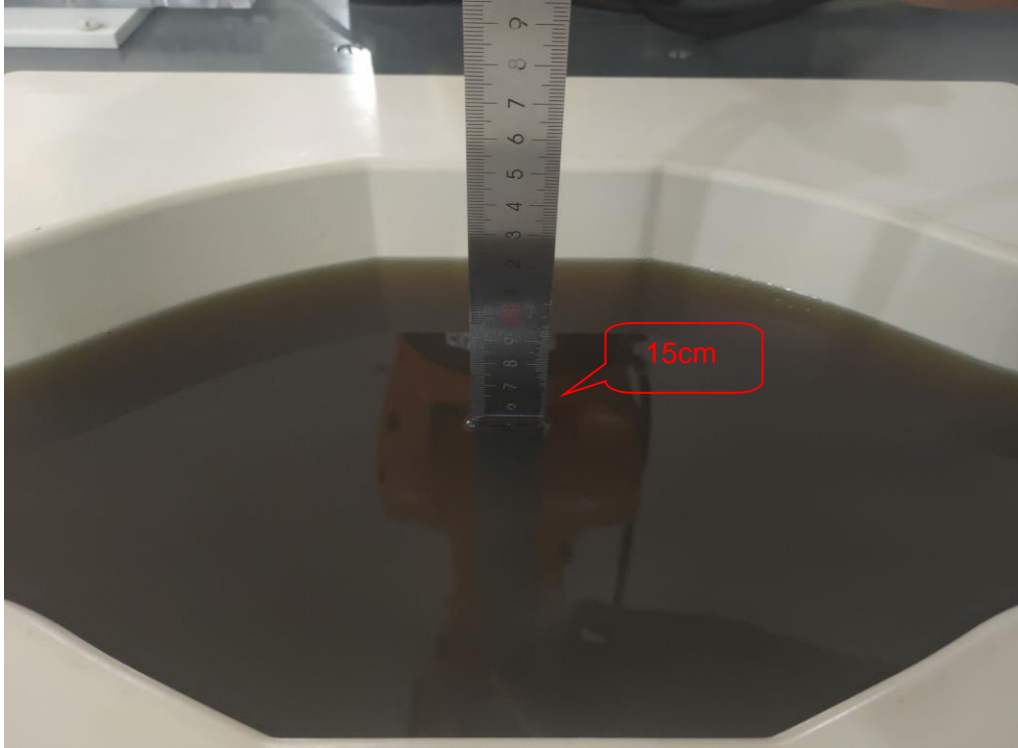



12. SAR Result Summary

12.1 Body-worn SAR

Band	Model	Test Position	Freq.	SAR (1g) (W/kg)	Power Drift(%)	Max.Turn-up Power(dBm)	Meas.Output Power(dBm)	Scaled SAR (W/Kg)	Meas.No.
2.4G WLAN 0degrees	802.11b	Back Side	2462	0.615	0.78	10.00	9.78	0.647	1
		Top Side	2462	0.366	0.97	10.00	9.78	0.385	/
2.4G WLAN 90degrees	802.11b	Back Side	2412	0.585	-1.55	10.00	9.58	0.644	/
		Back Side	2437	0.596	-2.24	10.00	9.6	0.654	/
		Back Side	2462	0.642	-1.98	10.00	9.78	0.675	2
		Top Side	2462	0.035	3.46	10.00	9.78	0.037	/

Note:

- The test separation of all above table is 0mm.
- Per KDB 447498 D04, the reported SAR is the measured SAR value adjusted for maximum tune-up tolerance.
 - Tune-up scaling Factor = tune-up limit power (mW) / EUT RF power (mW), where tune-up limit is the maximum rated power among all production units.
 - Scaled SAR(W/kg)= Measured SAR(W/kg)*Tune-up Scaling Factor
- Per KDB 248227- When the highest reported SAR for DSSS is adjusted by the ratio of OFDM to DSSS specified maximum output power and the adjusted SAR is ≤ 1.2 W/kg. (The highest reported SAR for DSSS is adjusted by the ratio of OFDM to DSSS specified maximum output power was **1.033** W/Kg for Body)
- Per KDB 865664 D01, Repeated measurement is not required when the original highest measured SAR is <0.80 W/kg



13. Equipment List

Kind of Equipment	Manufacturer	Type No.	Serial No.	Last Calibration	Calibrated Until
2450MHzDipole	MVG	SID2450	SN 30/14 DIP2G450-335	2020.07.14	2023.07.13
E-Field Probe	MVG	SSE2	SN 07/21 EPO352	2022.02.28	2023.02.27
Dielectric Probe Kit	MVG	SCLMP	SN 32/14 OCPG67	2021.11.23	2022.11.22
Antenna	MVG	ANTA3	SN 07/13 ZNTA52	N/A	N/A
Phantom1	MVG	SAM	SN 32/14 SAM115	N/A	N/A
Phantom3	MVG	SAM	SN 21/21 ELLI48	N/A	N/A
Phone holder	MVG	N/A	SN 32/14 MSH97	N/A	N/A
Laptop holder	MVG	N/A	SN 32/14 LSH29	N/A	N/A
Attenuator	Agilent	99899	DC-18GHz	N/A	N/A
Directional coupler	Narda	4226-20	3305	N/A	N/A
Network Analyzer	Agilent	8753ES	US38432810	2022.09.28	2023.09.27
Multi Meter	Keithley	Multi Meter 2000	4050073	2022.09.29	2023.09.28
Signal Generator	Agilent	N5182A	MY50140530	2022.09.28	2023.09.27
Wireless Communication Test Set	Agilent	8960-E5515C	MY48360751	2022.09.28	2023.09.27
Wireless Communication Test Set	R&S	CMW500	156324	2022.09.29	2023.09.28
Power Amplifier	DESAY	ZHL-42W	9638	2022.10.08	2023.10.07
Power Meter	R&S	NRP	100510	2022.09.28	2023.09.27
Power Sensor	R&S	NRP-Z11	101919	2022.09.28	2023.09.27
Power Sensor	Keysight	U2021XA	MY56280002	2022.09.29	2023.09.28
Temperature hygrometer	SuWei	SW-108	N/A	2022.09.30	2023.09.29

Note:

Per KDB 865664 D01, Dipole SAR Validation Verification, STS LAB has adopted 3 years calibration intervals. On annual basis, every measurement dipole has been evaluated and is in compliance with the following criteria:

1. There is no physical damage on the dipole
2. System validation with specific dipole is within 10% of calibrated value Return-loss in within 20% of calibrated measurement

Appendix A. System Validation Plots

System Performance Check Data (2450MHz)

Type: Phone measurement (Complete)

Area scan resolution: dx=8mm, dy=8mm

Zoom scan resolution: dx=8mm, dy=8mm, dz=5mm

Date of measurement: 2022-11-14

Experimental conditions.

Phantom	Validation plane
Device Position	-
Band	2450MHz
Channels	-
Signal	CW
Frequency (MHz)	2450MHz
Relative permittivity	39.95
Conductivity (S/m)	1.76
Probe	SN 07/21 EPGO352
ConvF	1.75
Crest factor:	1:1

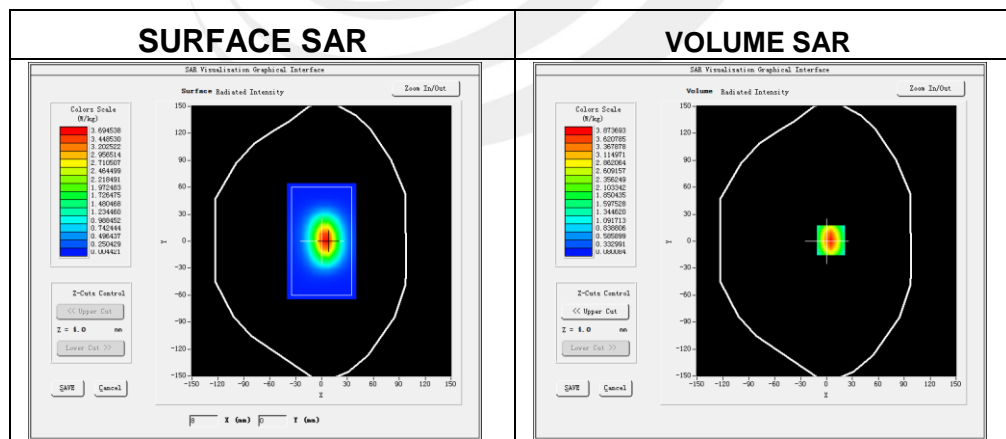

Maximum location: X=5.00, Y=1.00

SAR 10g (W/Kg)	2.413596
SAR 1g (W/Kg)	5.440149

Z Axis Scan

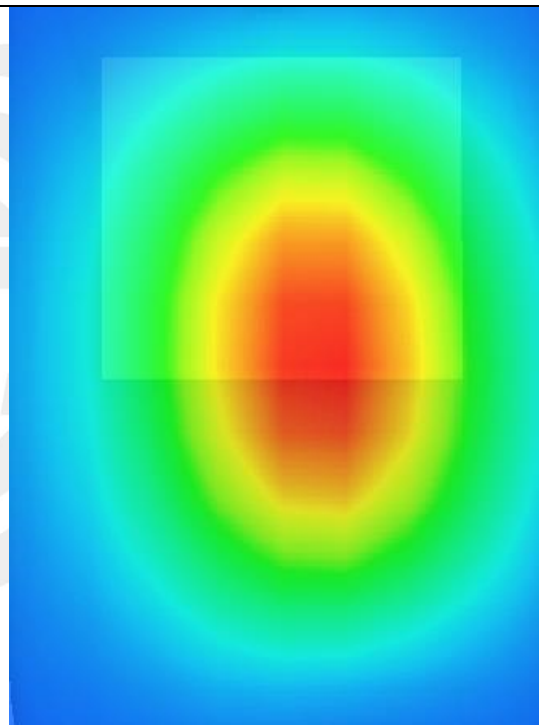
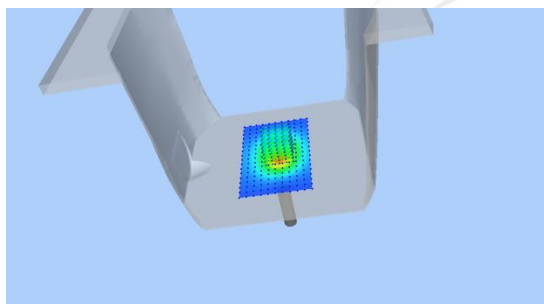
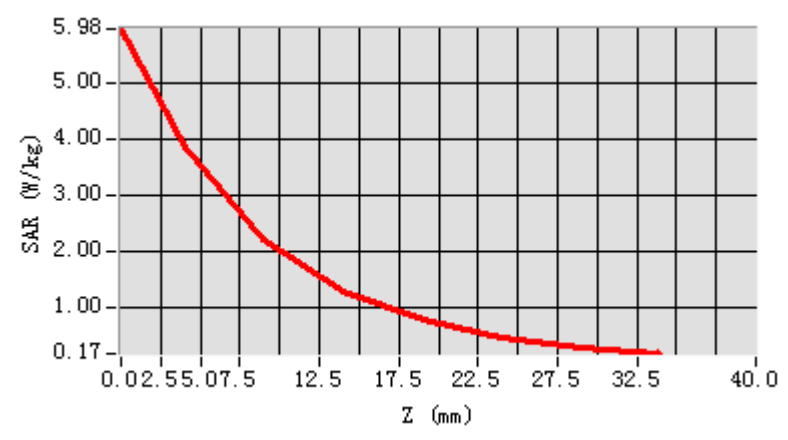

Appendix B. SAR Test Plots

Plot 1: DUT: Baby Monitor; EUT Model: BM-1R

Test Date	2022-11-14
Probe	SN 07/21 EPGO352
ConvF	1.75
Area Scan	dx=8mm, dy=8mm, h= 5.00 mm
Zoom Scan	5x5x7, dx=8mm, dy=8mm, dz=5mm, Complete/ndx=8mm, dy=8mm, h= 5.00 mm
Phantom	Validation plane
Device Position	Back Side
Band	2.4G WLAN 0degrees
Signal	IEEE802.b (Crest factor: 1.0)
Frequency (MHz)	2462
Relative permittivity (real part)	40.52
Conductivity (S/m)	1.76

Maximum location: X=-2.00, Y=-21.00

SAR Peak: 1.15 W/kg

SAR 10g (W/Kg)	0.269526
SAR 1g (W/Kg)	0.614574

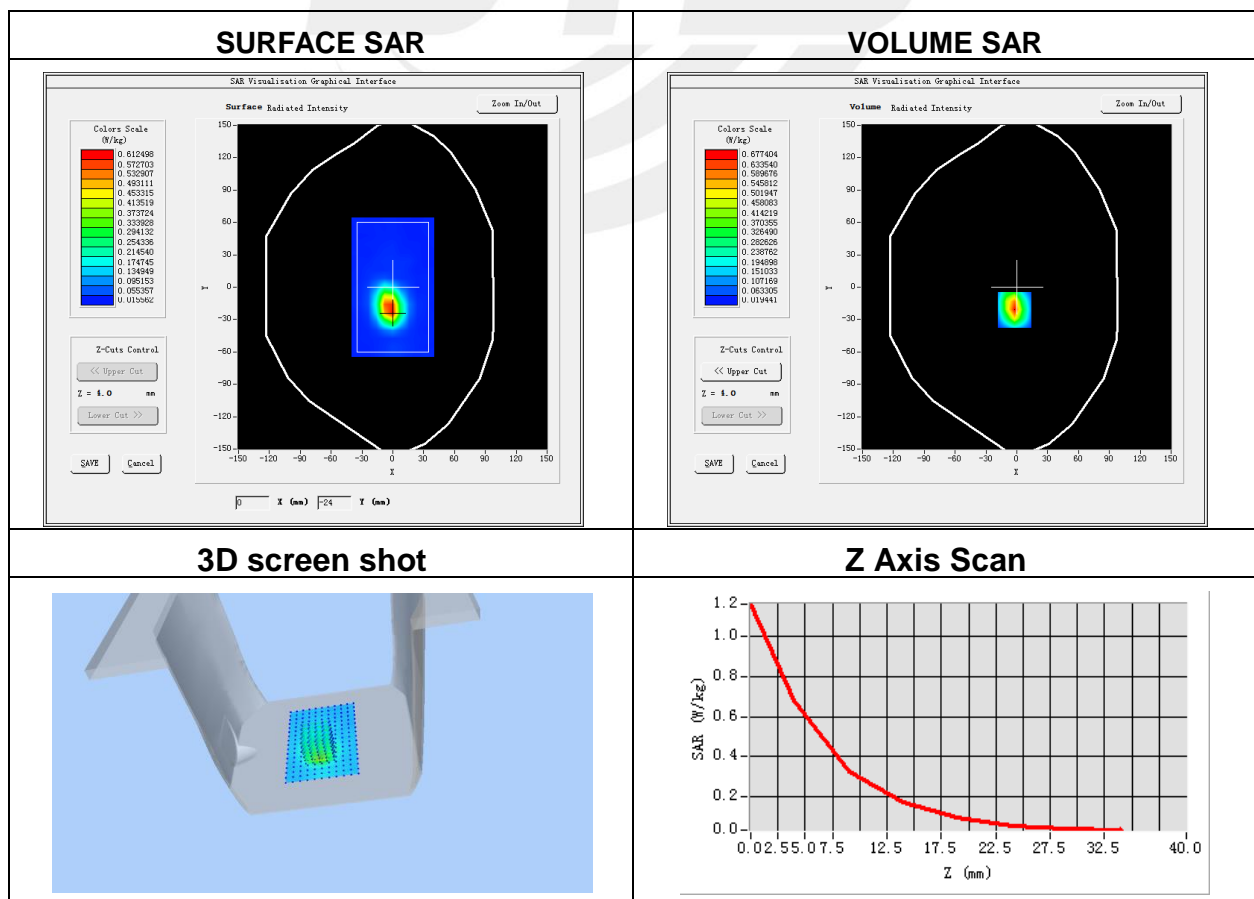

Plot 2: DUT: Baby Monitor; EUT Model: BM-1R

Test Date	2022-11-14
Probe	SN 07/21 EPGO352
ConvF	1.75
Area Scan	dx=8mm, dy=8mm, h= 5.00 mm
Zoom Scan	5x5x7, dx=8mm, dy=8mm, dz=5mm, Complete/ndx=8mm, dy=8mm, h= 5.00 mm
Phantom	Validation plane
Device Position	Back Side
Band	2.4G_90 degree
Signal	IEEE802.b (Crest factor: 1.0)
Frequency (MHz)	2462
Relative permittivity (real part)	40.52
Conductivity (S/m)	1.76

Maximum location: X=-17.00, Y=-1.00

SAR Peak: 1.19 W/kg

SAR 10g (W/Kg)	0.285324
SAR 1g (W/Kg)	0.641926

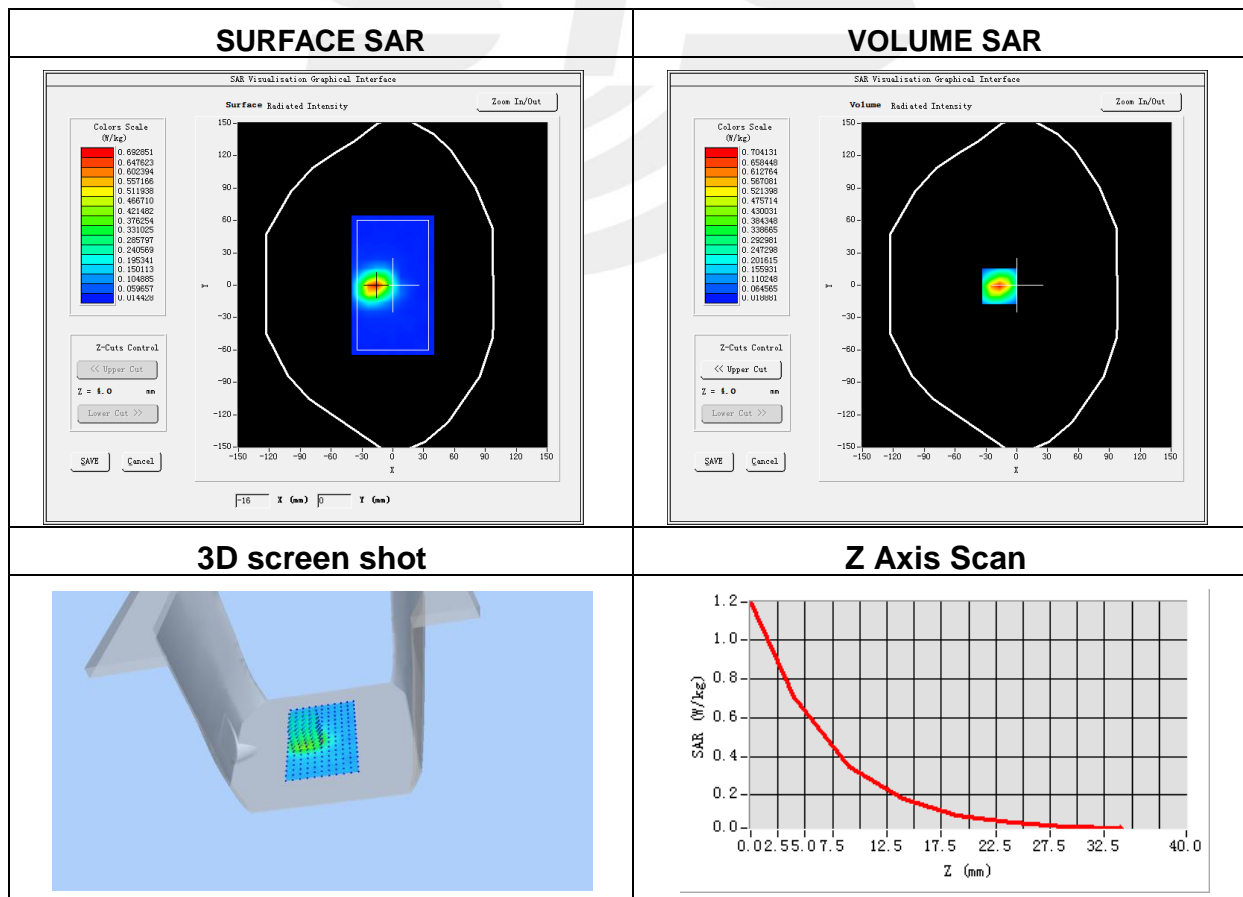



Appendix C. Probe Calibration and Dipole Calibration Report

Refer the appendix Calibration Report.

※※※※END OF THE REPORT※※※※

