

TEST REPORT

Product Name : SLIM LINE II
Model Number : ADC-VDB105X, ADC-VDB106X
FCC ID : 2ADX1-SBHD30

Prepared for : SKYBELL TECHNOLOGIES INC
Address : 1 JENNER STE 100, IRVINE CA 92618, USA

Prepared by : EMTEK (SHENZHEN) CO., LTD.
Address : Building 69, Majialong Industry Zone, Nanshan District,
Shenzhen, Guangdong, China

Tel: (0755) 26954280
Fax: (0755) 26954282

Report Number : ES201123021W02
Date(s) of Tests : August 20, 2020 to November 30, 2020
Date of issue : December 1, 2020

1 TEST RESULT CERTIFICATION

Applicant : SKYBELL TECHNOLOGIES INC
 Address : 1 JENNER STE 100, IRVINE CA 92618, USA
 Manufacturer : SKYBELL TECHNOLOGIES INC
 Address : 1 JENNER STE 100, IRVINE CA 92618, USA
 EUT : SLIM LINE II
 Model Name : ADC-VDB105X, ADC-VDB106X
 Trademark : SKYBELL

Measurement Procedure Used:

APPLICABLE STANDARDS	
STANDARD	TEST RESULT
FCC 47 CFR Part 2, Subpart J FCC 47 CFR Part 15, Subpart E	PASS

The above equipment was tested by EMTEK (SHENZHEN) CO., LTD. The test data, data evaluation, test procedures, and equipment configurations shown in this report were made in accordance with the procedures given in ANSI C63.10 (2013) and the energy emitted by the sample EUT tested as described in this report is in compliance with the requirements of FCC Rules Part 2 and Part 15.407

The test results of this report relate only to the tested sample identified in this report.

Date of Test : August 20, 2020 to November 30, 2020

Prepared by:

Sewen Guo /Editor

Reviewer:

Joe Xia /Supervisor

Approve & Authorized Signer :



Lisa Wang/Manager



TABLE OF CONTENTS

1	TEST RESULT CERTIFICATION	2
2	EUT TECHNICAL DESCRIPTION	4
3	SUMMARY OF TEST RESULT	7
4	TEST METHODOLOGY	8
4.1	GENERAL DESCRIPTION OF APPLIED STANDARDS	8
4.2	MEASUREMENT EQUIPMENT USED	8
4.3	DESCRIPTION OF TEST MODES	9
5	FACILITIES AND ACCREDITATIONS	13
5.1	FACILITIES.....	13
5.2	LABORATORY ACCREDITATIONS AND LISTINGS	13
6	TEST SYSTEM UNCERTAINTY	14
7	SETUP OF EQUIPMENT UNDER TEST	15
7.1	RADIO FREQUENCY TEST SETUP	15
7.2	RADIO FREQUENCY TEST SETUP	15
7.3	CONDUCTED EMISSION TEST SETUP	17
7.4	BLOCK DIAGRAM CONFIGURATION OF TEST SYSTEM.....	18
7.5	SUPPORT EQUIPMENT.....	18
8	TEST REQUIREMENTS	19
8.1	BANDWIDTH MEASUREMENT	19
8.2	MAXIMUM CONDUCTED OUTPUT POWER.....	67
8.3	MAXIMUM PEAK POWER DENSITY	81
8.4	FREQUENCY STABILITY	151
8.5	UNDESIRABLE RADIATED SPURIOUS EMISSION.....	160
8.6	POWER LINE CONDUCTED EMISSIONS.....	189
8.7	ANTENNA APPLICATION	192

2 EUT TECHNICAL DESCRIPTION

Characteristics	Description
Product:	SLIM LINE II
Model Number:	ADC-VDB105X, ADC-VDB106X (All models covered in this report are the same with each other, except for different model and appearance (for color, silk-screen only) for trading purpose. We choose ADC-VDB105X as the final test prototype)
Sample Number:	2#
Wifi Type:	<input checked="" type="checkbox"/> Wifi 5G with 5150MHz-5250MHz Band <input checked="" type="checkbox"/> Wifi 5G with 5250MHz-5350MHz Band <input checked="" type="checkbox"/> Wifi 5G with 5470MHz-5725MHz Band <input checked="" type="checkbox"/> Wifi 5G with 5725MHz-5850MHz Band
WLAN Supported:	<input checked="" type="checkbox"/> 802.11a <input checked="" type="checkbox"/> 802.11n(20MHz channel bandwidth) <input checked="" type="checkbox"/> 802.11n(40MHz channel bandwidth) <input checked="" type="checkbox"/> 802.11ac(20MHz channel bandwidth) <input checked="" type="checkbox"/> 802.11ac(40MHz channel bandwidth) <input checked="" type="checkbox"/> 802.11ac(80MHz channel bandwidth)
Data Rate :	802.11a:54/48/36/24/18/12/9/6Mbps 802.11n:up to 300 Mbps 802.11ac:up to 867Mbps
Modulation:	<input checked="" type="checkbox"/> OFDM with BPSK/QPSK/16QAM/64QAM for 802.11a/n; <input checked="" type="checkbox"/> OFDM with BPSK/QPSK/16QAM/64QAM/256QAM for 802.11ac;
Frequency Range:	<input checked="" type="checkbox"/> UNII-1: 5150MHz-5250MHz Band
	<input checked="" type="checkbox"/> 5180-5240MHz for 802.11a; <input checked="" type="checkbox"/> 5180-5240MHz for 802.11n(HT20); <input checked="" type="checkbox"/> 5180-5240MHz for 802.11ac(HT20);
	<input checked="" type="checkbox"/> 5190-5230MHz for 802.11n(HT40); <input checked="" type="checkbox"/> 5190-5230MHz for 802.11ac(HT40); <input checked="" type="checkbox"/> 5210MHz for 802.11ac(HT80);
	<input checked="" type="checkbox"/> UNII-2A: 5250MHz-5350MHz Band
	<input checked="" type="checkbox"/> 5260-5320MHz for 802.11a; <input checked="" type="checkbox"/> 5260-5320MHz for 802.11n(HT20); <input checked="" type="checkbox"/> 5260-5320MHz for 802.11ac(HT20);
	<input checked="" type="checkbox"/> 5270-5310MHz for 802.11n(HT40); <input checked="" type="checkbox"/> 5270-5310MHz for 802.11ac(HT40); <input checked="" type="checkbox"/> 5290MHz for 802.11ac(HT80);
	<input checked="" type="checkbox"/> UNII-2C: 5470MHz-5725MHz Band
	<input checked="" type="checkbox"/> 5500-5700MHz for 802.11a; <input checked="" type="checkbox"/> 5500-5700MHz for 802.11n(HT20); <input checked="" type="checkbox"/> 5500-5700MHz for 802.11ac(HT20);
<input checked="" type="checkbox"/> 5510-5670MHz for 802.11n(HT40); <input checked="" type="checkbox"/> 5510-5670MHz for 802.11ac(HT40); <input checked="" type="checkbox"/> 5530-5610MHz for 802.11ac(HT80);	
<input checked="" type="checkbox"/> UNII-3 with 5725MHz-5850MHz Band	
<input checked="" type="checkbox"/> 5745-5825MHz for 802.11a; <input checked="" type="checkbox"/> 5745-5825MHz for 802.11n(HT20); <input checked="" type="checkbox"/> 5745-5825MHz for 802.11ac(HT20);	
<input checked="" type="checkbox"/> 5755-5795MHz for 802.11n(HT40); <input checked="" type="checkbox"/> 5755-5795MHz for 802.11ac(HT40); <input checked="" type="checkbox"/> 5775MHz for 802.11ac(HT80);	
TPC Function:	<input type="checkbox"/> Applicable <input checked="" type="checkbox"/> Not Applicable

Antenna Port:	<input checked="" type="checkbox"/> Antenna port 1 <input checked="" type="checkbox"/> Antenna port 2	
Antenna Type:	<input checked="" type="checkbox"/> ANT 1: FPC Antenna <input checked="" type="checkbox"/> ANT 2: FPC Antenna	
Antenna Gain:	<input checked="" type="checkbox"/> ANT 1: 1.0 dBi <input checked="" type="checkbox"/> ANT 2: 0.2 dBi	
Transmit Power:	Output Power (Max.) for 5150MHz-5250MHz (1TX)	802.11a: 14.40 dBm 802.11n(20 MHz): 13.22dBm 802.11n(40 MHz): 9.60dBm 802.11ac(20 MHz): 13.12dBm 802.11ac (40 MHz): 10.34dBm 802.11ac (80 MHz): 9.02dBm
	Output Power (Max.) for 5250MHz-5350MHz (1TX)	802.11a: 13.88 dBm 802.11n(20 MHz): 12.62dBm 802.11n(40 MHz): 9.24dBm 802.11ac(20 MHz):12.48dBm 802.11ac(40 MHz):9.45dBm 802.11ac(80 MHz): 8.88dBm
	Output Power (Max.) for 5470MHz-5725MHz (1TX)	802.11a: 16.20dBm 802.11n(20 MHz): 15.19dBm 802.11n(40 MHz): 11.15dBm 802.11ac(20 MHz): 15.42dBm 802.11ac(40 MHz): 12.06dBm 802.11ac(80 MHz): 10.54dBm
	Output Power (Max.) for 5725MHz-5875MHz (1TX)	802.11a: 16.51dBm 802.11n(HT 20 MHz): 16.42dBm 802.11n(HT 40 MHz): 14.87dBm 802.11ac (HT 20 MHz): 16.34dBm 802.11ac (HT 40 MHz): 14.85dBm 802.11ac (HT 80 MHz): 13.86dBm
	Output Power (Max.) for 5150MHz-5250MHz (2TX)	802.11n(20 MHz): 15.72dBm 802.11n(40 MHz): 12.15dBm 802.11ac(20 MHz): 15.63dBm 802.11ac(40 MHz): 12.37dBm 802.11ac(80 MHz): 11.50dBm
	Output Power (Max.) for 5250MHz-5350MHz (2TX)	802.11n(20 MHz): 14.81dBm 802.11n(40 MHz): 11.58dBm 802.11ac(20 MHz): 15.03dBm 802.11ac(40 MHz):11.73dBm 802.11ac(80 MHz): 11.17dBm
	Output Power (Max.) for 5470MHz-5725MHz (2TX)	802.11n(20 MHz): 18.10dBm 802.11n(40 MHz):13.82dBm 802.11ac(20 MHz): 18.04dBm 802.11ac(40 MHz): 14.47dBm 802.11ac(80 MHz): 13.53dBm
	Output Power (Max.) for 5725MHz-5875MHz (2TX)	802.11n(HT 20 MHz): 19.41dBm 802.11n(HT 40 MHz): 17.85dBm 802.11ac (HT 20 MHz): 19.34dBm 802.11ac (HT 40 MHz): 17.78dBm 802.11ac (HT 80 MHz): 16.75dBm

Power Supply:	<input checked="" type="checkbox"/> AC10-30V,Max 0.5A, 50/60Hz <input checked="" type="checkbox"/> DC12V,0.5 to1.0A
Battery:	350mAh,DC3.7V
Date of Received:	August 18, 2020
Temperature Range:	-10°C ~ 55°C

Note: for more details, please refer to the User's manual of the EUT.



3 SUMMARY OF TEST RESULT

FCC Part Clause	Test Parameter	Verdict	Remark
15.407 (a) 15.407 (e)	99% , 6dB and 26dB Bandwidth	PASS	
15.407 (a)	Maximum Conducted Output Power	PASS	
15.407 (a)	Peak Power Spectral Density	PASS	
15.407 (b)	Radiated Spurious Emission	PASS	
15.407(g)	Frequency Stability	PASS	
15.407 (b)(6) 15.207	Power Line Conducted Emission	PASS	
15.407(a) 15.203	Antenna Application	PASS	

NOTE1: N/A (Not Applicable)

NOTE2: According to FCC OET KDB 789033 D2 General UNII Test Procedures New Rules v02r01, In addition, the radiated test is also performed to ensure the emissions emanating from the device cabinet also comply with the applicable limits.

RELATED SUBMITTAL(S) / GRANT(S):

This submittal(s) (test report) is intended for FCC ID: 2ADX1-SBHD30 filing to comply with Section 15.247 of the FCC Part 15, Subpart E Rules.

4 TEST METHODOLOGY

4.1 GENERAL DESCRIPTION OF APPLIED STANDARDS

According to its specifications, the EUT must comply with the requirements of the following standards:

FCC 47 CFR Part 2, Subpart J

FCC 47 CFR Part 15, Subpart E

FCC KDB 662911 D01 Multiple Transmitter Output v02r01

FCC KDB 789033 D2 General UNII Test Procedures New Rules v02r01

4.2 MEASUREMENT EQUIPMENT USED

4.2.1 Conducted Emission Test Equipment

EQUIPMENT TYPE	MFR	MODEL NUMBER	SERIAL NUMBER	LASTCAL.	DUE CAL.
Test Receiver	Rohde & Schwarz	ESCS30	828985/018	05/16/2020	05/15/2021
L.I.S.N.	Schwarzbeck	NNLK8129	8129203	05/16/2020	05/15/2021
50Ω Coaxial Switch	Anritsu	MP59B	M20531	05/16/2020	05/15/2021
Pulse Limiter	Rohde & Schwarz	ESH3-Z2	100006	05/16/2020	05/15/2021
Voltage Probe	Rohde & Schwarz	TK9416	N/A	05/16/2020	05/15/2021
I.S.N	Rohde & Schwarz	ENY22	1109.9508.02	05/16/2020	05/15/2021

4.2.2 Radiated Emission Test Equipment

EQUIPMENT TYPE	MFR	MODEL NUMBER	SERIAL NUMBER	LAST CAL.	DUE CAL.
EMI Test Receiver	Rohde & Schwarz	ESU	1302.6005.26	05/16/2020	05/15/2021
Pre-Amplifier	HP	8447D	2944A07999	05/16/2020	05/15/2021
Bilog Antenna	Schwarzbeck	VULB9163	142	05/16/2020	05/15/2021
Loop Antenna	ARA	PLA-1030/B	1029	05/16/2020	05/15/2021
Horn Antenna	Schwarzbeck	BBHA 9170	BBHA9170399	05/16/2020	05/15/2021
Horn Antenna	Schwarzbeck	BBHA 9120	D143	05/16/2020	05/15/2021
Cable	Schwarzbeck	AK9513	ACRX1	05/16/2020	05/15/2021
Cable	Rosenberger	N/A	FP2RX2	05/16/2020	05/15/2021
Cable	Schwarzbeck	AK9513	CRPX1	05/16/2020	05/15/2021
Cable	Schwarzbeck	AK9513	CRRX2	05/16/2020	05/15/2021

4.2.3 Radio Frequency Test Equipment

EQUIPMENT TYPE	MFR	MODEL NUMBER	SERIAL NUMBER	LASTCAL.	DUE CAL.
Spectrum Analyzer	Agilent	E4407B	88156318	05/16/2020	05/15/2021
Signal Analyzer	Agilent	N9010A	My53470879	05/16/2020	05/15/2021
Power meter	Anritsu	ML2495A	0824006	05/16/2020	05/15/2021
Power sensor	Anritsu	MA2411B	0738172	05/16/2020	05/15/2021
Temperature & Humidity Chamber	YINHE	SDH0525F	2003003	05/16/2020	05/15/2021

Remark: Each piece of equipment is scheduled for calibration once a year.

4.3 DESCRIPTION OF TEST MODES

The EUT has been tested under its typical operating condition.

The EUT configuration for testing is installed on RF field strength measurement to meet the Commissions requirement and operating in a manner which intends to maximize its emission characteristics in a continuous normal application.

The Transmitter was operated in the normal operating mode. The TX frequency was fixed which was for the purpose of the measurements.

Test of channel included the lowest and middle and highest frequency to perform the test, then record on this report.

Pre-defined engineering program for regulatory testing used to control the EUT for staying in continuous transmitting and receiving mode is programmed.

Wifi 5G with U-NII - 1

Frequency and Channel list for 802.11a/n (HT20)/802.11ac (HT20):

Channel	Frequency (MHz)	Channel	Frequency (MHz)	Channel	Frequency (MHz)
36	5180	44	5220		
40	5200	48	5240		

Frequency and Channel list for 802.11n (HT40)/ 802.11ac (HT40):

Channel	Frequency (MHz)	Channel	Frequency (MHz)	Channel	Frequency (MHz)
38	5190				
46	5230				

Frequency and Channel list for 802.11ac (HT80):

Channel	Frequency (MHz)	Channel	Frequency (MHz)	Channel	Frequency (MHz)
42	5210				

Test Frequency and Channel for 802.11a/n (HT20)/802.11ac (HT20):

Lowest Frequency		Middle Frequency		Highest Frequency	
Channel	Frequency (MHz)	Channel	Frequency (MHz)	Channel	Frequency (MHz)
36	5180	40	5200	48	5240

Test Frequency and channel for 802.11n (HT40)/ 802.11ac (HT40):

Lowest Frequency		Middle Frequency		Highest Frequency	
Channel	Frequency (MHz)	Channel	Frequency (MHz)	Channel	Frequency (MHz)
38	5190	N/A	N/A	46	5230

Test Frequency and channel for 802.11ac (HT80):

Lowest Frequency		Middle Frequency		Highest Frequency	
Channel	Frequency (MHz)	Channel	Frequency (MHz)	Channel	Frequency (MHz)
42	5210	N/A	N/A	N/A	N/A

Wifi 5G with U-NII -2A

Frequency and Channel list for 802.11a/n (HT20)/802.11ac (HT20):

Channel	Frequency (MHz)	Channel	Frequency (MHz)	Channel	Frequency (MHz)
52	5260	60	5300		
56	5280	64	5320		

Frequency and Channel list for 802.11n (HT40)/ 802.11ac (HT40):

Channel	Frequency (MHz)	Channel	Frequency (MHz)	Channel	Frequency (MHz)
54	5270				
62	5310				

Frequency and Channel list for 802.11ac (HT80):

Channel	Frequency (MHz)	Channel	Frequency (MHz)	Channel	Frequency (MHz)
58	5290				

Test Frequency and Channel for 802.11a/n (HT20)/802.11ac (HT20):

Lowest Frequency		Middle Frequency		Highest Frequency	
Channel	Frequency (MHz)	Channel	Frequency (MHz)	Channel	Frequency (MHz)
52	5260	56	5280	64	5320

Test Frequency and channel for 802.11n (HT40)/ 802.11ac (HT40):

Lowest Frequency		Middle Frequency		Highest Frequency	
Channel	Frequency (MHz)	Channel	Frequency (MHz)	Channel	Frequency (MHz)
54	5270	N/A	N/A	62	5310

Test Frequency and channel for 802.11ac (HT80):

Lowest Frequency		Middle Frequency		Highest Frequency	
Channel	Frequency (MHz)	Channel	Frequency (MHz)	Channel	Frequency (MHz)
58	5290				

Wifi 5G with U-NII -2C

Frequency and Channel list for 802.11a/n (HT20)/802.11ac (HT20):

Channel	Frequency (MHz)	Channel	Frequency (MHz)	Channel	Frequency (MHz)
100	5500	116	5580	132	5660
104	5520	120	5600	136	5680
108	5540	124	5620	140	5700
112	5560	128	5640		

Frequency and Channel list for 802.11n (HT40)/ 802.11ac (HT40):

Channel	Frequency (MHz)	Channel	Frequency (MHz)	Channel	Frequency (MHz)
102	5510	118	5590	134	5670
110	5550	126	5630		

Frequency and Channel list for 802.11ac (HT80):

Channel	Frequency (MHz)	Channel	Frequency (MHz)	Channel	Frequency (MHz)
106	5530	122	5610		

Test Frequency and Channel for 802.11a/n (HT20)/802.11ac (HT20):

Lowest Frequency		Middle Frequency		Highest Frequency	
Channel	Frequency (MHz)	Channel	Frequency (MHz)	Channel	Frequency (MHz)
100	5500	116	5580	140	5700

Test Frequency and channel for 802.11n (HT40)/ 802.11ac (HT40):

Lowest Frequency		Middle Frequency		Highest Frequency	
Channel	Frequency (MHz)	Channel	Frequency (MHz)	Channel	Frequency (MHz)
102	5510			134	5670

Test Frequency and channel for 802.11ac (HT80):

Lowest Frequency		Middle Frequency		Highest Frequency	
Channel	Frequency (MHz)	Channel	Frequency (MHz)	Channel	Frequency (MHz)
106	5530				

Wifi 5G with U-NII -3

Frequency and Channel list for 802.11a/n (HT20)/802.11ac (HT20):

Channel	Frequency (MHz)	Channel	Frequency (MHz)	Channel	Frequency (MHz)
149	5745	157	5785	165	5825
153	5765	161	5805		

Frequency and Channel list for 802.11n (HT40)/ 802.11ac (HT40):

Channel	Frequency (MHz)	Channel	Frequency (MHz)	Channel	Frequency (MHz)
151	5755	159	5795		

Frequency and Channel list for 802.11ac (HT80):

Channel	Frequency (MHz)	Channel	Frequency (MHz)	Channel	Frequency (MHz)
155	5775				

Test Frequency and Channel for 802.11a/n (HT20)/802.11ac (HT20):

Lowest Frequency		Middle Frequency		Highest Frequency	
Channel	Frequency (MHz)	Channel	Frequency (MHz)	Channel	Frequency (MHz)
149	5745	157	5785	165	5825

Test Frequency and channel for 802.11n (HT40)/ 802.11ac (HT40):

Lowest Frequency		Middle Frequency		Highest Frequency	
Channel	Frequency (MHz)	Channel	Frequency (MHz)	Channel	Frequency (MHz)
151	5755	N/A	N/A	159	5795

Test Frequency and channel for 802.11ac (HT80):

Lowest Frequency		Middle Frequency		Highest Frequency	
Channel	Frequency (MHz)	Channel	Frequency (MHz)	Channel	Frequency (MHz)
155	5775				

The 5G WIFI has two antennas and support Multiple Outputs for 802.11n/ac mode for this report; Antenna 1 Gain is 1.0dBi; Antenna 2 Gain is 0.2dBi; For this function is belong to Correlated Categorization equipment

According to KDB 662911, for Unequal antenna gains,

$$\text{Directional gain} = 10 \log[(10^{1/20} + 10^{0.2/20})^2/2] \text{ dBi} = 3.59 \text{ dBi}$$

5 FACILITIES AND ACCREDITATIONS

5.1 FACILITIES

All measurement facilities used to collect the measurement data are located at

Building 69, Majialong Industry Zone District, Nanshan District, Shenzhen, China

The sites are constructed in conformance with the requirements of ANSI C63.7, ANSI C63.10 and CISPR Publication 22.

5.2 LABORATORY ACCREDITATIONS AND LISTINGS

Site Description

EMC Lab.

: Accredited by CNAS, 2018.11.30

The certificate is valid until 2022.10.28

The Laboratory has been assessed and proved to be in compliance with CNAS-CL01:2006 (identical to ISO/IEC 17025:2017)

The Certificate Registration Number is L2291

Accredited by FCC,

Designation Number: CN1204

Test Firm Registration Number: 882943

Accredited by A2LA, August 25, 2020

The Certificate Registration Number is 4321.01

Accredited by Industry Canada, November 09, 2018

The Conformity Assessment Body Identifier is CN0008

Name of Firm

: EMTEK(SHENZHEN) CO., LTD.

Site Location

: Building 69, Majialong Industry Zone,
Nanshan District, Shenzhen, Guangdong, China

6 TEST SYSTEM UNCERTAINTY

The following measurement uncertainty levels have been estimated for tests performed on the apparatus:

Parameter	Uncertainty
Radio Frequency	$\pm 1 \times 10^{-5}$
Maximum Peak Output Power Test	$\pm 1.0\text{dB}$
Conducted Emissions Test	$\pm 2.0\text{dB}$
Radiated Emission Test	$\pm 2.0\text{dB}$
Power Density	$\pm 2.0\text{dB}$
Occupied Bandwidth Test	$\pm 1.0\text{dB}$
Band Edge Test	$\pm 3\text{ dB}$
All emission, radiated	$\pm 3\text{dB}$
Antenna Port Emission	$\pm 3\text{dB}$
Temperature	$\pm 0.5^\circ\text{C}$
Humidity	$\pm 3\%$

Measurement Uncertainty for a level of Confidence of 95%

7 SETUP OF EQUIPMENT UNDER TEST

7.1 RADIO FREQUENCY TEST SETUP

The WLAN component's antenna ports(s) of the EUT are connected to the measurement instrument per an appropriate attenuator. The EUT is controlled by PC/software to emit the specified signals for the purpose of measurements.

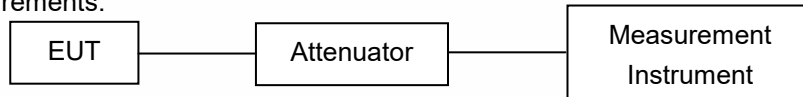

7.2 RADIO FREQUENCY TEST SETUP

The test site semi-anechoic chamber has met the requirement of NSA tolerance 4 dB according to the standards: ANSI C63.10. The test distance is 3m. The setup is according to the requirements in Section 13.1.4.1 of ANSI C63.10-2013 and CAN/CSA-CEI/IEC CISPR 22.

Below 30MHz:

The EUT is placed on a turntable 0.8 meters above the ground in the chamber, 3 meter away from the antenna (loop antenna). The Antenna should be positioned with its plane vertical at the specified distance from the EUT and rotated about its vertical axis for maximum response at each azimuth about the EUT. The center of the loop shall be 1 m above the ground. For certain applications, the loop antenna plane may also need to be positioned horizontally at the specified distance from the EUT.

Above 30MHz:

The EUT is placed on a turntable 0.8 meters above the ground in the chamber, 3 meter away from the antenna. The maximal emission value is acquired by adjusting the antenna height, polarisation and turntable azimuth. Normally, the height range of antenna is 1 m to 4 m, the azimuth range of turntable is 0° to 360°, and the receive antenna has two polarizations Vertical (V) and Horizontal (H).

Above 1GHz:

(Note: the FCC's permission to use 1.5m as an alternative per TCBC Conf call of Dec. 2, 2014.)

The EUT is placed on a turntable 1.5 meters above the ground in the chamber, 3 meter away from the antenna. The maximal emission value is acquired by adjusting the antenna height, polarisation and turntable azimuth. Normally, the height range of antenna is 1 m to 4 m, the azimuth range of turntable is 0° to 360°, and the receive antenna has two polarizations Vertical (V) and Horizontal (H).

(a) Radiated Emission Test Set-Up, Frequency Below 30MHz

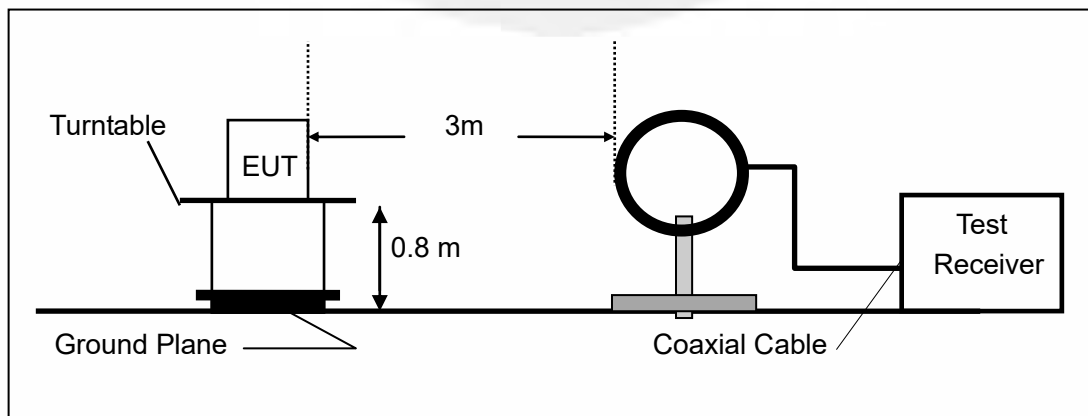

(b) Radiated Emission Test Set-Up, Frequency Below 1000MHz

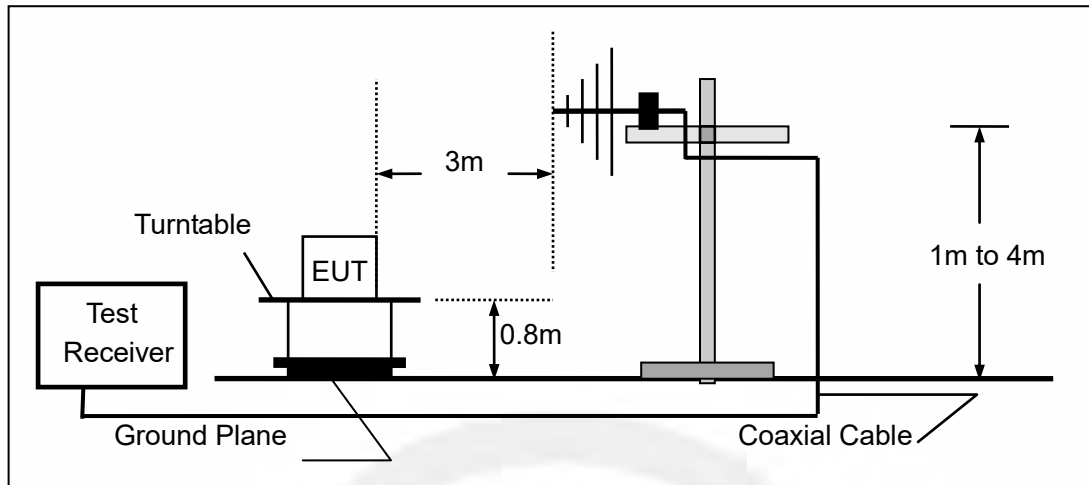

(c) Radiated Emission Test Set-Up, Frequency above 1000MHz

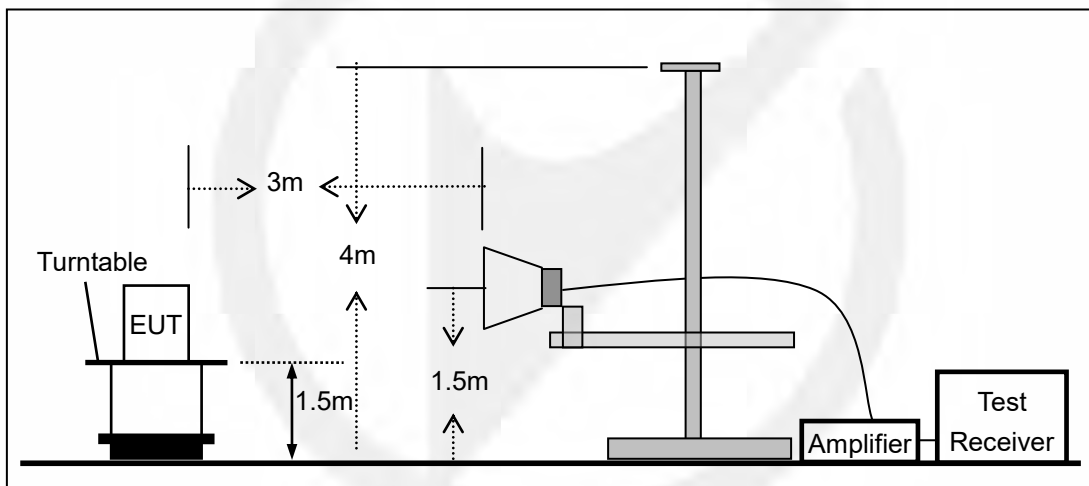

7.3 CONDUCTED EMISSION TEST SETUP

The mains cable of the EUT (maybe per AC/DC Adapter) must be connected to LISN. The LISN shall be placed 0.8 m from the boundary of EUT and bonded to a ground reference plane for LISN mounted on top of the ground reference plane. This distance is between the closest points of the LISN and the EUT. All other units of the EUT and associated equipment shall be at least 0.8m from the LISN.

Ground connections, where required for safety purposes, shall be connected to the reference ground point of the LISN and, where not otherwise provided or specified by the manufacturer, shall be of same length as the mains cable and run parallel to the mains connection at a separation distance of not more than 0.1 m.

According to the requirements in Section 13.1.4.1 of ANSI C63.10-2013 Conducted emissions from the EUT measured in the frequency range between 0.15 MHz and 30 MHz using CISPR Quasi-Peak and average detector mode.

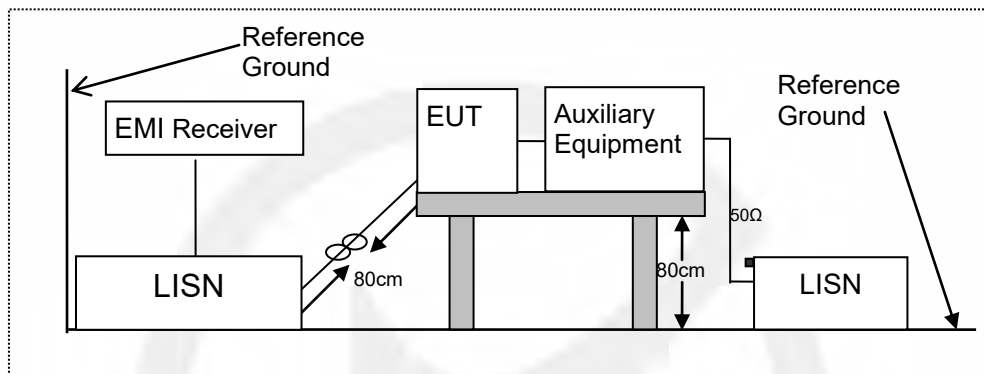

7.4 BLOCK DIAGRAM CONFIGURATION OF TEST SYSTEM

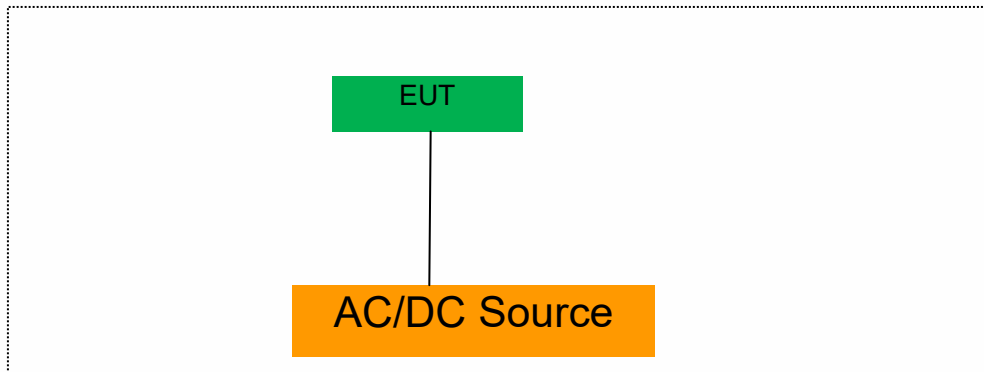

7.5 SUPPORT EQUIPMENT

EUT Cable List and Details			
Cable Description	Length (m)	Shielded/Unshielded	With / Without Ferrite
/	/	/	/

Auxiliary Cable List and Details			
Cable Description	Length (m)	Shielded/Unshielded	With / Without Ferrite
/	/	/	/

Auxiliary Equipment List and Details			
Description	Manufacturer	Model	Serial Number
Notebook	acer	ZR1	LXTECOCO76643158 372500

Notes:

1. All the equipment/cables were placed in the worst-case configuration to maximize the emission during the test.
2. Grounding was established in accordance with the manufacturer's requirements and conditions for the intended use.

8 TEST REQUIREMENTS

8.1 BANDWIDTH MEASUREMENT

8.1.1 Applicable Standard

According to FCC Part 15.407(a)(1) for UNII Band I
According to FCC Part 15.407(a)(2) for UNII Band II-A and UNII Band II-C
According to FCC Part 15.407(a)(3) for UNII Band III
According to FCC Part 15.407(e) for UNII Band III
According to 789033 D02 Section II(C)
According to 789033 D02 Section II(D)

8.1.2 Conformance Limit

(1) For the band 5.15-5.25 GHz.

(iv) For mobile and portable client devices in the 5.15-5.25 GHz band, the maximum conducted output power over the frequency band of operation shall not exceed 250 mW provided the maximum antenna gain does not exceed 6 dBi. In addition, the maximum power spectral density shall not exceed 11 dBm in any 1 megahertz band. If transmitting antennas of directional gain greater than 6 dBi are used, both the maximum conducted output power and the maximum power spectral density shall be reduced by the amount in dB that the directional gain of the antenna exceeds 6 dBi.

(2) For the 5.25-5.35 GHz and 5.47-5.725 GHz bands, the maximum conducted output power over the frequency bands of operation shall not exceed the lesser of 250 mW or 11 dBm + 10 log B, where B is the 26 dB emission bandwidth in megahertz. In addition, the maximum power spectral density shall not exceed 11 dBm in any 1 megahertz band. If transmitting antennas of directional gain greater than 6 dBi are used, both the maximum conducted output power and the maximum power spectral density shall be reduced by the amount in dB that the directional gain of the antenna exceeds 6 dBi.

(3) For the band 5.725-5.85 GHz, the maximum conducted output power over the frequency band of operation shall not exceed 1 W. In addition, the maximum power spectral density shall not exceed 30 dBm in any 500-kHz band. If transmitting antennas of directional gain greater than 6 dBi are used, both the maximum conducted output power and the maximum power spectral density shall be reduced by the amount in dB that the directional gain of the antenna exceeds 6 dBi. However, fixed point-to-point U-NII devices operating in this band may employ transmitting antennas with directional gain greater than 6 dBi without any corresponding reduction in transmitter conducted power. Fixed, point-to-point operations exclude the use of point-to-multipoint systems, omnidirectional applications, and multiple collocated transmitters transmitting the same information. The operator of the U-NII device, or if the equipment is professionally installed, the installer, is responsible for ensuring that systems employing high gain directional antennas are used exclusively for fixed, point-to-point operations.

(e) Within the 5.725-5.85 GHz band, the minimum 6 dB bandwidth of U-NII devices shall be at least 500 kHz.

8.1.3 Test Configuration

Test according to clause 6.1 radio frequency test setup

8.1.4 Test Procedure

According to 789033 D02 v02r01 section C&D, the following is the measurement procedure.

1. Emission Bandwidth (EBW)

- a) Set RBW = approximately 1% of the emission bandwidth.
- b) Set the VBW > RBW.
- c) Detector = Peak.
- d) Trace mode = max hold.
- e) Measure the maximum width of the emission that is 26 dB down from the maximum of the emission.

Compare this with the RBW setting of the analyzer. Readjust RBW and repeat measurement as needed until the RBW/EBW ratio is approximately 1%.

2. Minimum Emission Bandwidth for the band 5.725-5.85 GHz

Section 15.407(e) specifies the minimum 6 dB emission bandwidth of at least 500 KHz for the band 5.715-5.85 GHz. The following procedure shall be used for measuring this bandwidth:

- a) Set RBW = 100 kHz.
- b) Set the video bandwidth (VBW) $\geq 3 \times$ RBW.
- c) Detector = Peak.
- d) Trace mode = max hold.
- e) Sweep = auto couple.
- f) Allow the trace to stabilize.
- g) Measure the maximum width of the emission that is constrained by the frequencies associated with the two outermost amplitude points (upper and lower frequencies) that are attenuated by 6 dB relative to the maximum level measured in the fundamental emission.

Note: The automatic bandwidth measurement capability of a spectrum analyzer or EMI receiver may be employed if it implements the functionality described above.

D. 99 Percent Occupied Bandwidth

The 99-percent occupied bandwidth is the frequency bandwidth such that, below its lower and above its upper frequency limits, the mean powers are each equal to 0.5 % of the total mean power of the given emission. Measurement of the 99-percent occupied bandwidth is required only as a condition for using the optional band-edge measurement techniques described in section II.G.3.d). Measurements of 99-percent occupied bandwidth may also optionally be used in lieu of the EBW to 789033 D02 v01r02 General UNII Test Procedures New Rules v01 define the minimum frequency range over which the spectrum is integrated when measuring maximum conducted output power as described in section II.E. However, the EBW must be measured to determine bandwidth dependent limits on maximum conducted output power in accordance with 15.407(a).

The following procedure shall be used for measuring (99 %) power bandwidth:

1. Set center frequency to the nominal EUT channel center frequency.
2. Set span = 1.5 times to 5.0 times the OBW.
3. Set RBW = 1 % to 5 % of the OBW
4. Set VBW $\geq 3 \cdot$ RBW
5. Video averaging is not permitted. Where practical, a sample detection and single sweep mode shall be used. Otherwise, peak detection and max hold mode (until the trace stabilizes) shall be used.
6. Use the 99 % power bandwidth function of the instrument (if available).
7. If the instrument does not have a 99 % power bandwidth function, the trace data points are recovered and directly summed in power units. The recovered amplitude data points, beginning at the lowest frequency, are placed in a running sum until 0.5 % of the total is reached; that frequency is recorded as the lower frequency. The process is repeated until 99.5 % of the total is reached; that frequency is recorded as the upper frequency. The 99% occupied bandwidth is the difference between these two frequencies.

8.1.5 Test Results

5150-5250MHz

Test Mode	Test Channel MHz		26 dB Bandwidth MHz	99% Bandwidth MHz	Verdict
802.11a	CH36	5180	18.72	16.361	Pass
	CH40	5200	18.62	16.390	Pass
	CH48	5240	18.68	16.368	Pass
802.11n-HT20	CH36	5180	19.50	17.563	Pass
	CH40	5200	19.49	17.568	Pass
	CH48	5240	19.40	17.554	Pass
802.11ac(HT20)	CH36	5180	19.53	17.592	Pass
	CH40	5200	19.45	17.568	Pass
	CH48	5240	17.52	17.581	Pass
802.11n-HT40	CH38	5190	40.73	36.079	Pass
	CH46	5230	41.01	36.082	Pass
802.11ac(HT40)	CH38	5190	41.02	36.128	Pass
	CH46	5230	40.45	36.101	Pass
802.11ac(HT80)	CH42	5210	81.26	74.751	Pass

99%& 26dB Occupied Bandwidth
Test Model 802.11a

U-NII - 1
Frequency(MHz)

5180

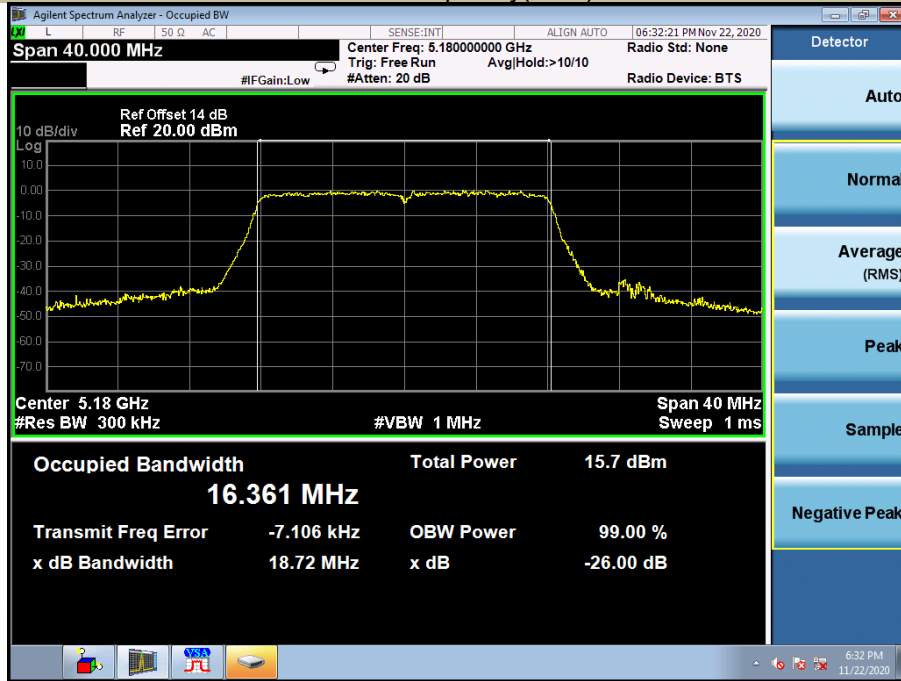

99%& 26dB Occupied Bandwidth
Test Model 802.11a

U-NII - 1
Frequency(MHz)

5200



99%& 26dB Occupied Bandwidth
Test Model 802.11a

U-NII - 1
Frequency(MHz)

5240

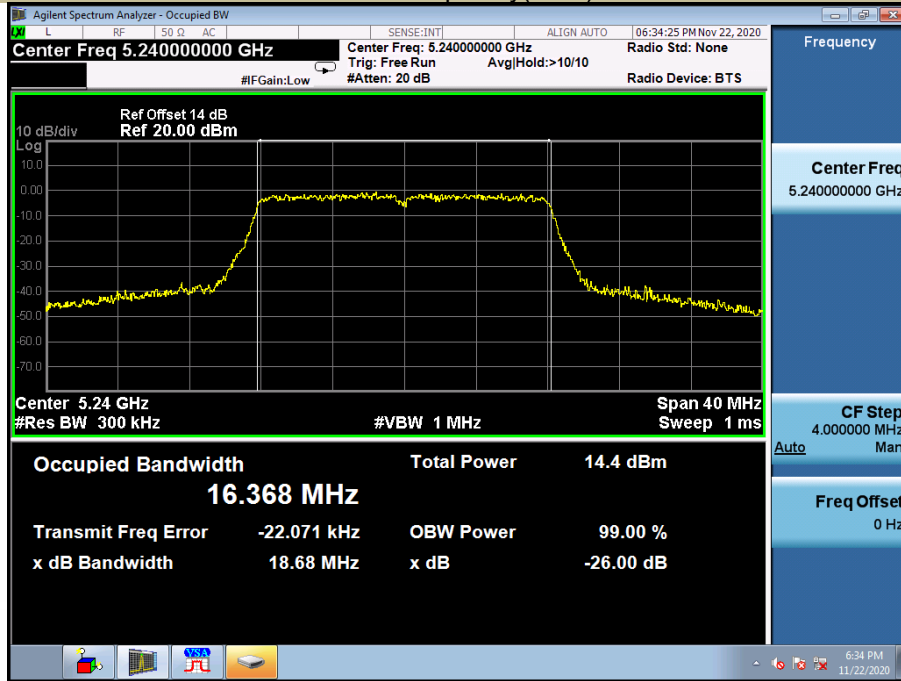

99%& 26dB Occupied Bandwidth
Test Model 802.11n-HT20

U-NII - 1
Frequency(MHz)

5180

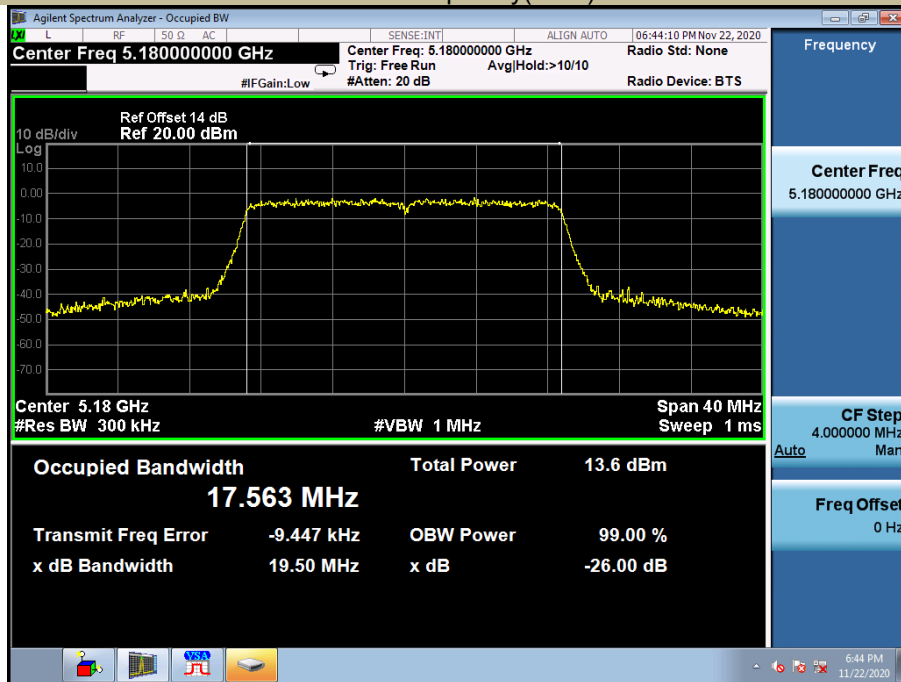

99%& 26dB Occupied Bandwidth
Test Model 802.11n-HT20

U-NII - 1
Frequency(MHz)

5200

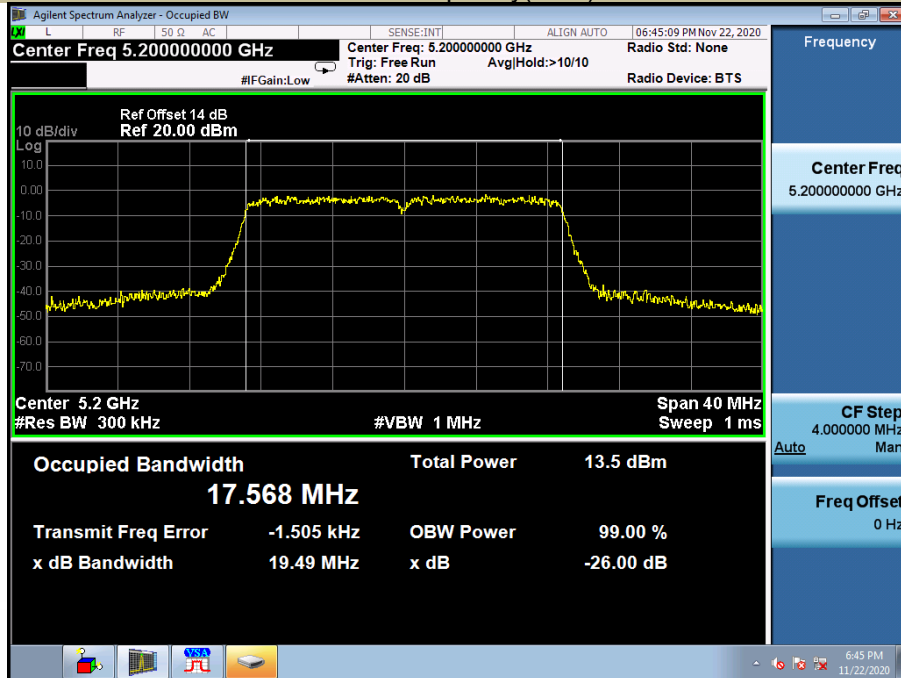

99%& 26dB Occupied Bandwidth
Test Model 802.11n-HT20

U-NII - 1
Frequency(MHz)

5240

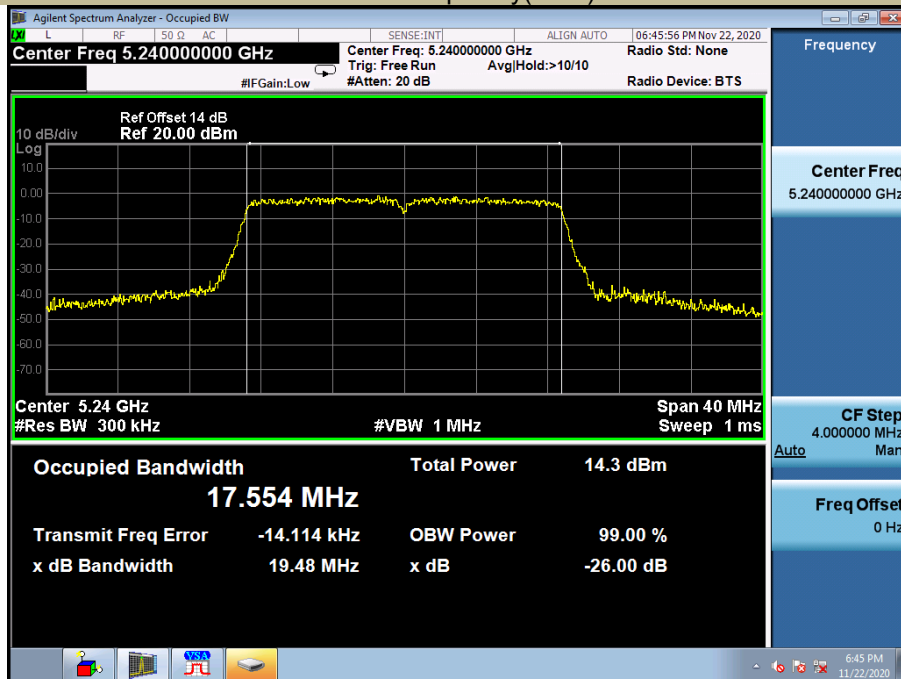

99%& 26dB Occupied Bandwidth
Test Model 802.11ac(HT20)

U-NII - 1
Frequency(MHz)

5180

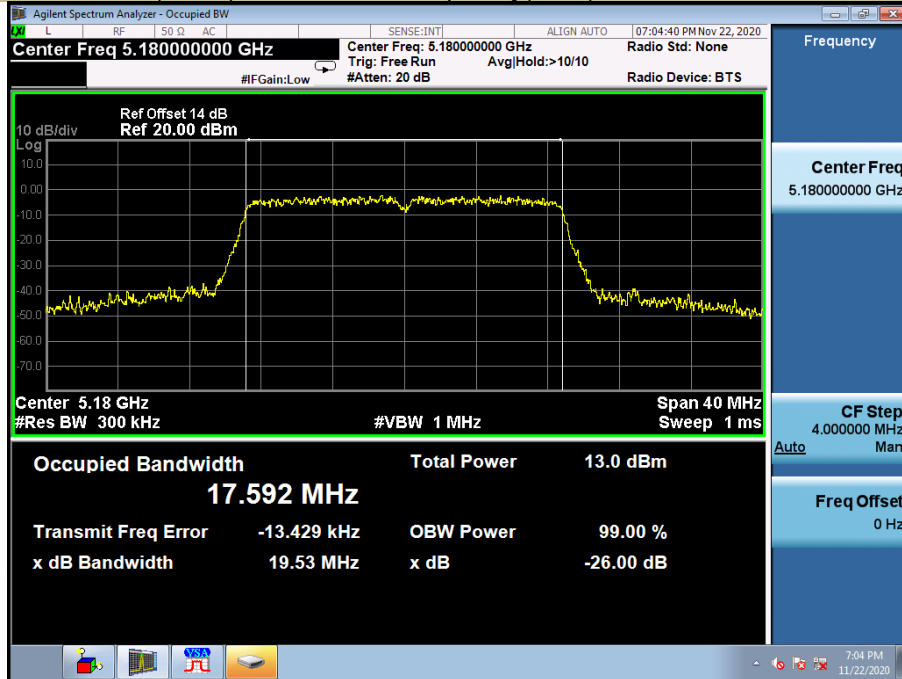

99%& 26dB Occupied Bandwidth
Test Model 802.11ac(HT20)

U-NII - 1
Frequency(MHz)

5200

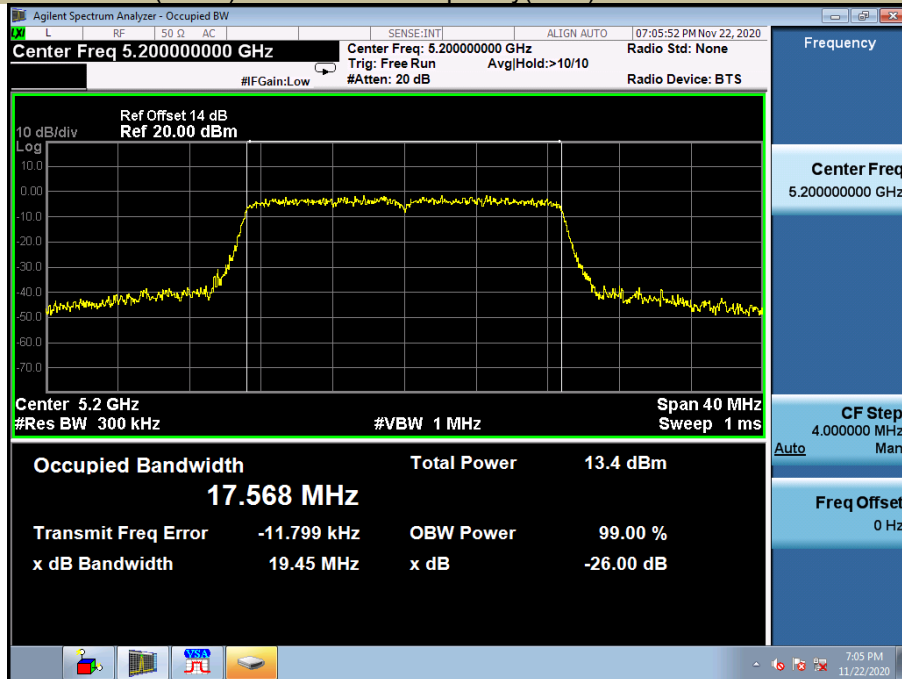

99%& 26dB Occupied Bandwidth
Test Model 802.11ac(HT20)

U-NII - 1
Frequency(MHz) 5240

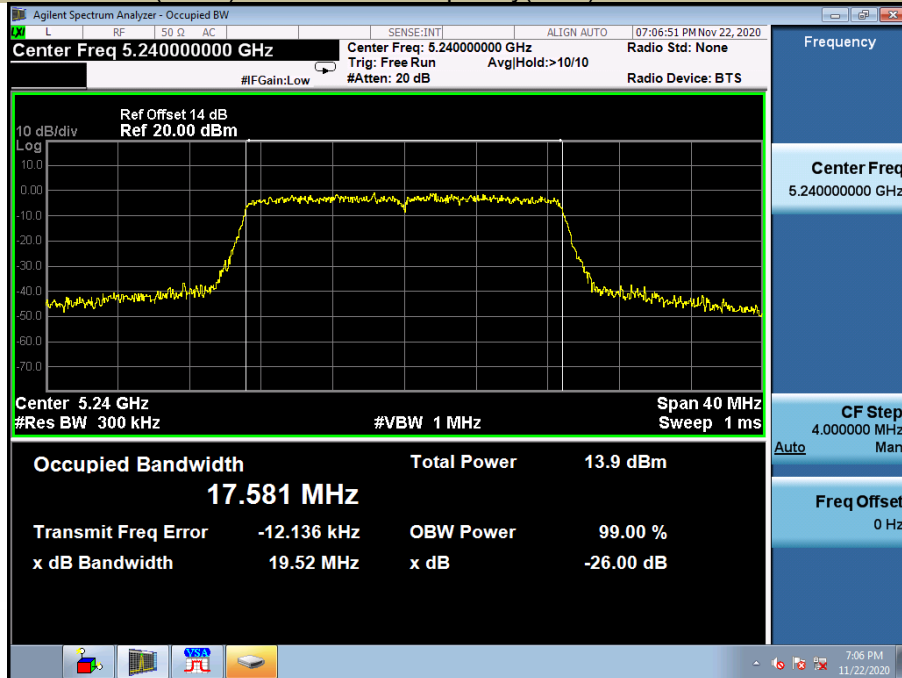

99%& 26dB Occupied Bandwidth
Test Model 802.11n-HT40

U-NII - 1
Frequency(MHz) 5190

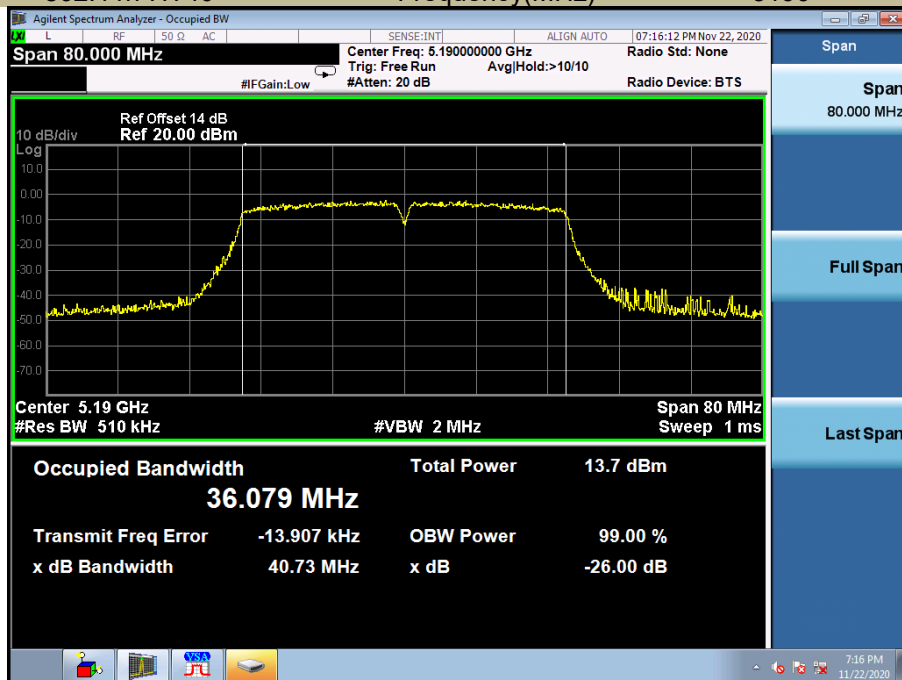

99%& 26dB Occupied Bandwidth
Test Model 802.11n-HT40

U-NII - 1
Frequency(MHz) 5230

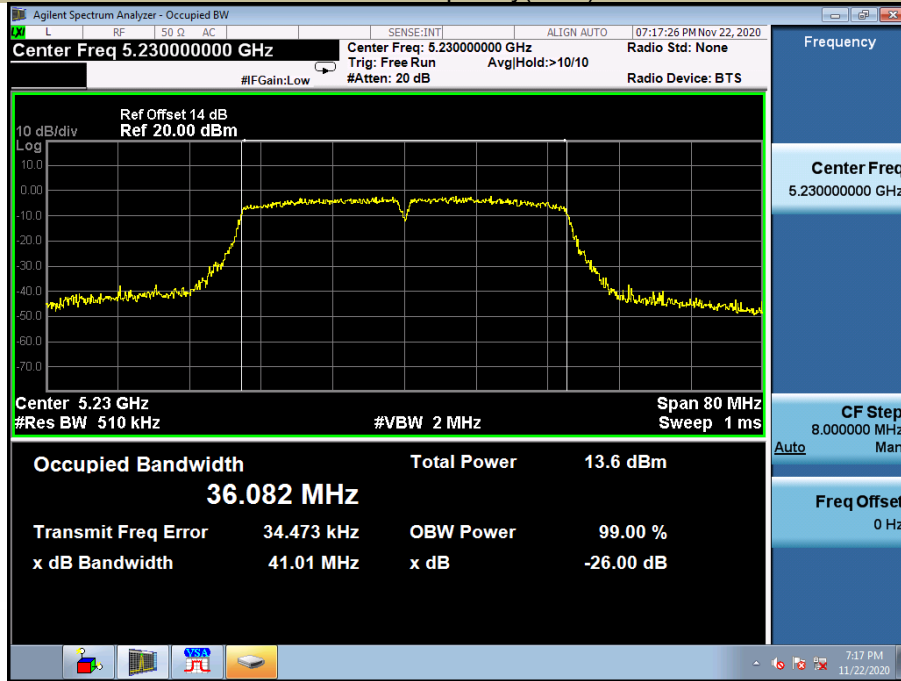

99%& 26dB Occupied Bandwidth
Test Model 802.11ac(HT40)

U-NII - 1
Frequency(MHz) 5190

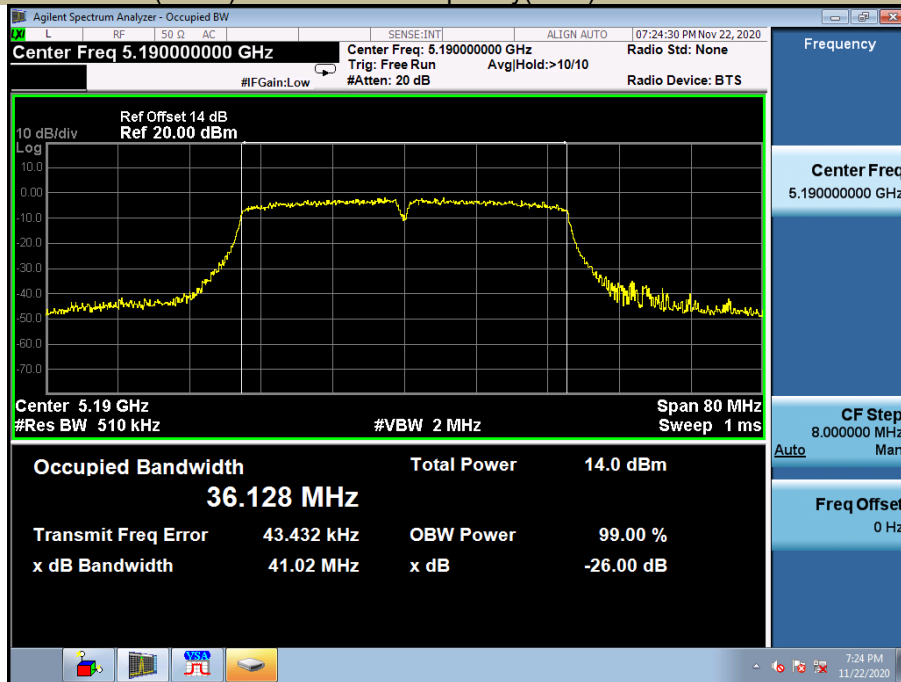

99%& 26dB Occupied Bandwidth
Test Model 802.11ac(HT40)

U-NII - 1
Frequency(MHz)

5230

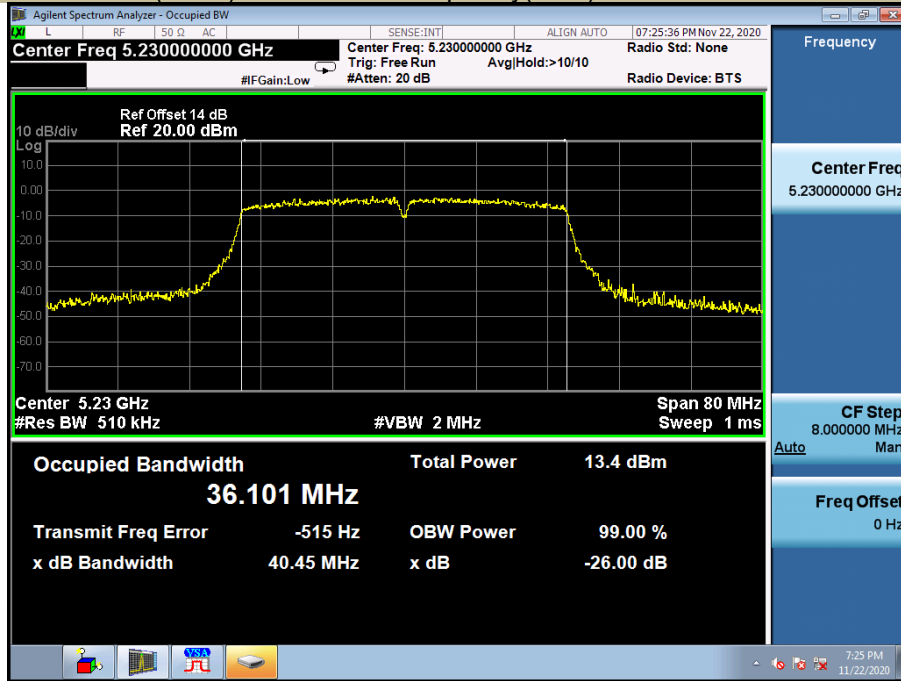

99%& 26dB Occupied Bandwidth
Test Model 802.11ac 80

U-NII - 1
Frequency(MHz)

5210

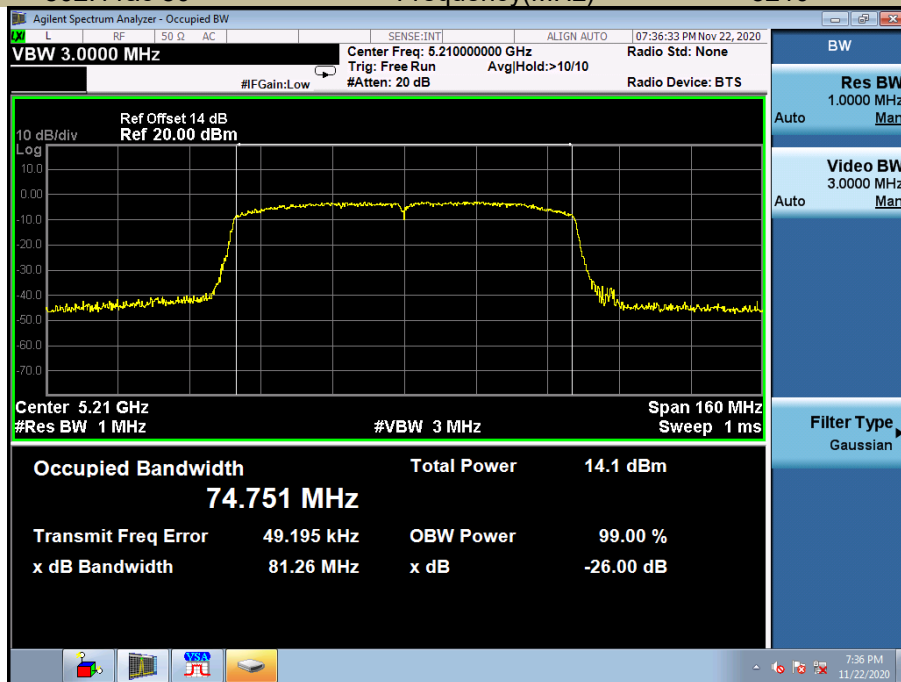

5250-5350MHz

Test Mode	Test Channel MHz		26 dB Bandwidth MHz	99% Bandwidth MHz	Verdict
802.11a	CH52	5260	18.76	16.395	Pass
	CH56	5280	18.64	16.375	Pass
	CH64	5320	18.55	16.355	Pass
802.11n-HT20	CH52	5260	18.59	17.577	Pass
	CH56	5280	19.76	17.575	Pass
	CH64	5320	19.57	17.550	Pass
802.11ac(HT20)	CH52	5260	19.50	17.550	Pass
	CH56	5280	19.50	17.565	Pass
	CH64	5320	19.40	17.564	Pass
802.11n-HT40	CH54	5270	40.96	36.140	Pass
	CH62	5310	40.95	36.110	Pass
802.11ac(HT40)	CH54	5270	40.73	36.116	Pass
	CH62	5310	41.20	36.108	Pass
802.11ac(HT80)	CH58	5290	80.53	74.859	Pass

99%& 26dB Occupied Bandwidth
Test Model 802.11a

U-NII – 2A
Frequency(MHz)

5260

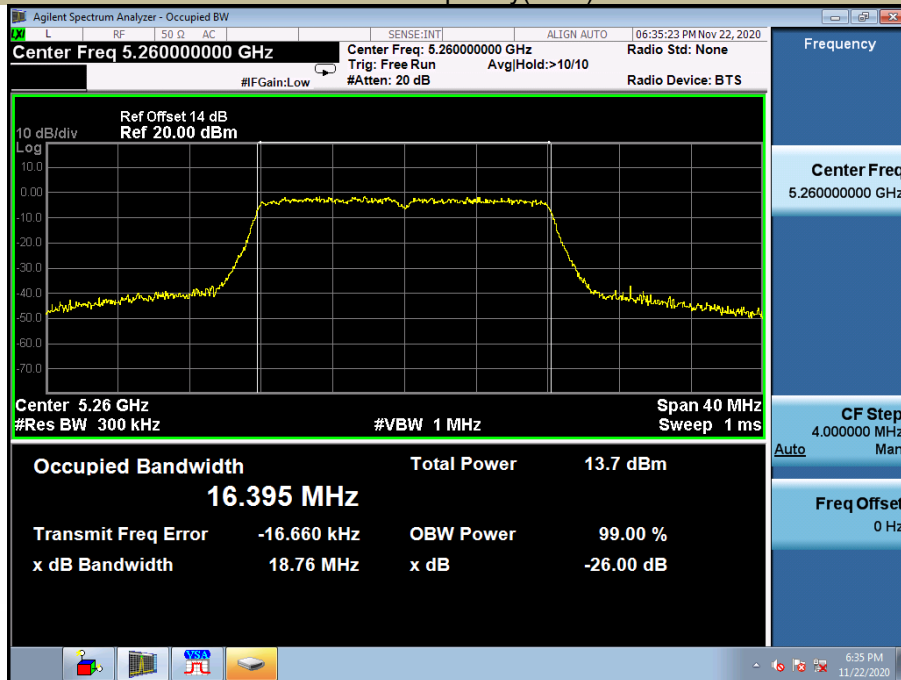

99%& 26dB Occupied Bandwidth
Test Model 802.11a

U-NII – 2A
Frequency(MHz)

5280

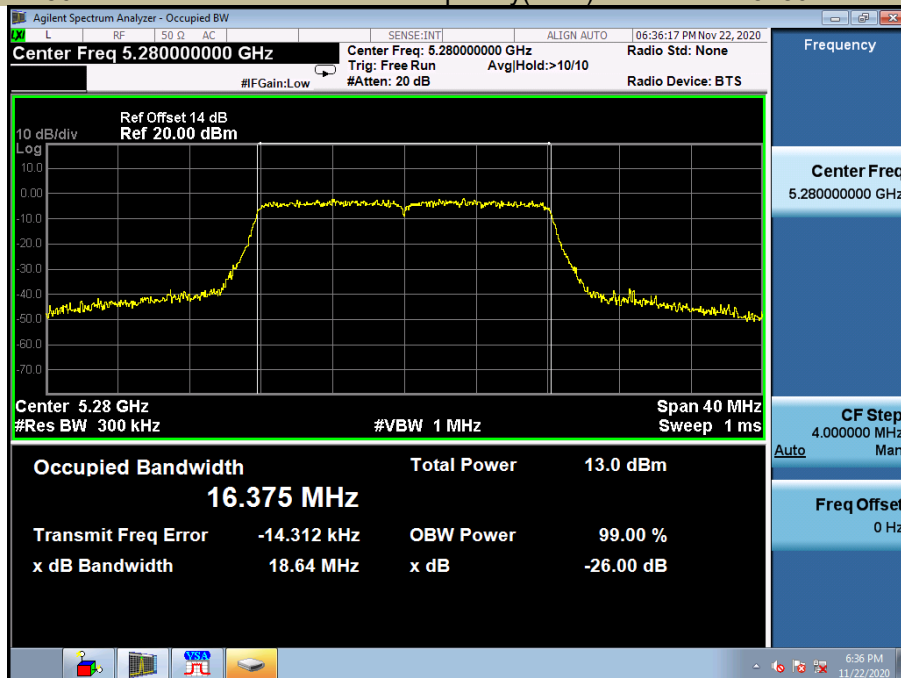

99%& 26dB Occupied Bandwidth
Test Model 802.11a

U-NII – 2A
Frequency(MHz)

5320

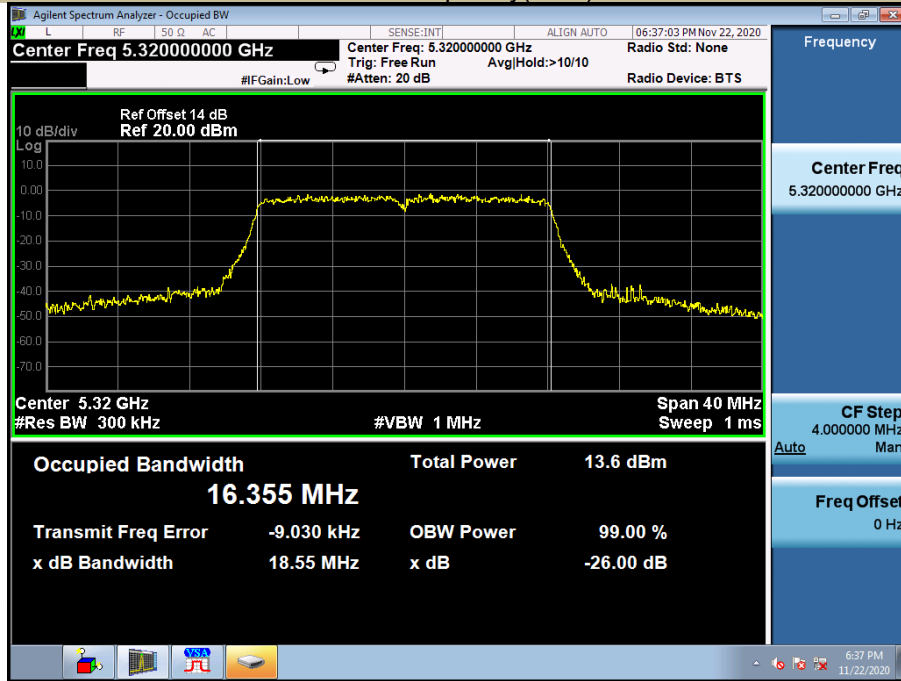

99%& 26dB Occupied Bandwidth
Test Model 802.11n-HT20

U-NII – 2A
Frequency(MHz)

5260

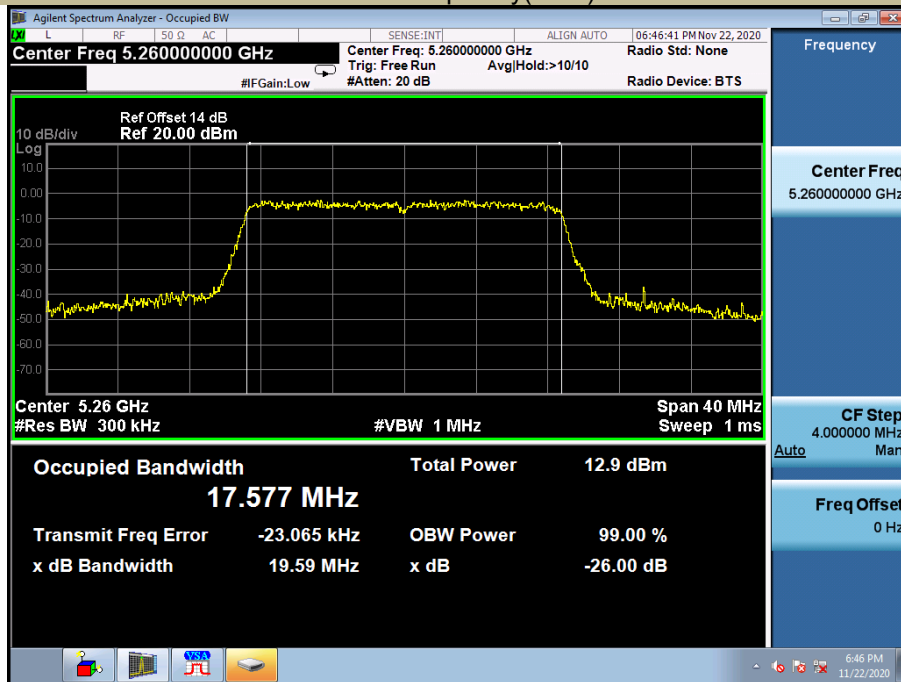

99%& 26dB Occupied Bandwidth
Test Model 802.11n-HT20

U-NII – 2A
Frequency(MHz) 5280

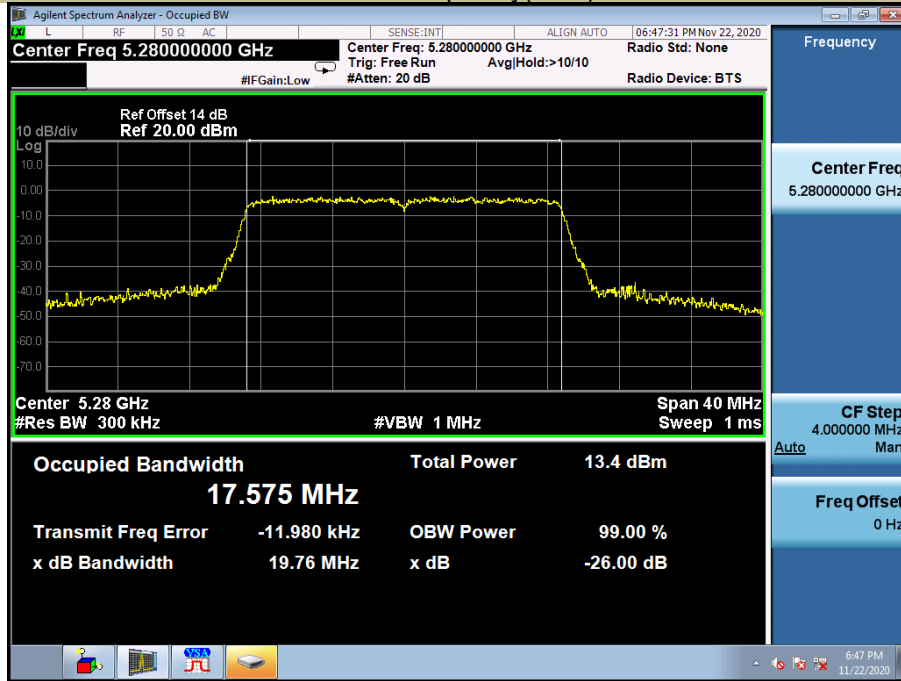

99%& 26dB Occupied Bandwidth
Test Model 802.11n-HT20

U-NII – 2A
Frequency(MHz) 5320

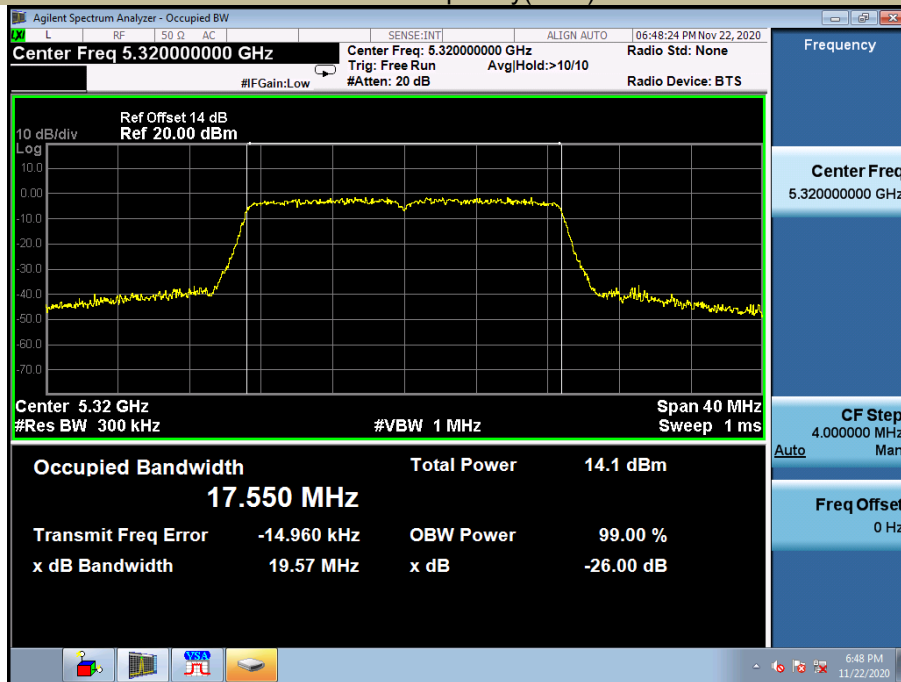

99%& 26dB Occupied Bandwidth
Test Model 802.11ac(HT20)

U-NII – 2A
Frequency(MHz) 5260

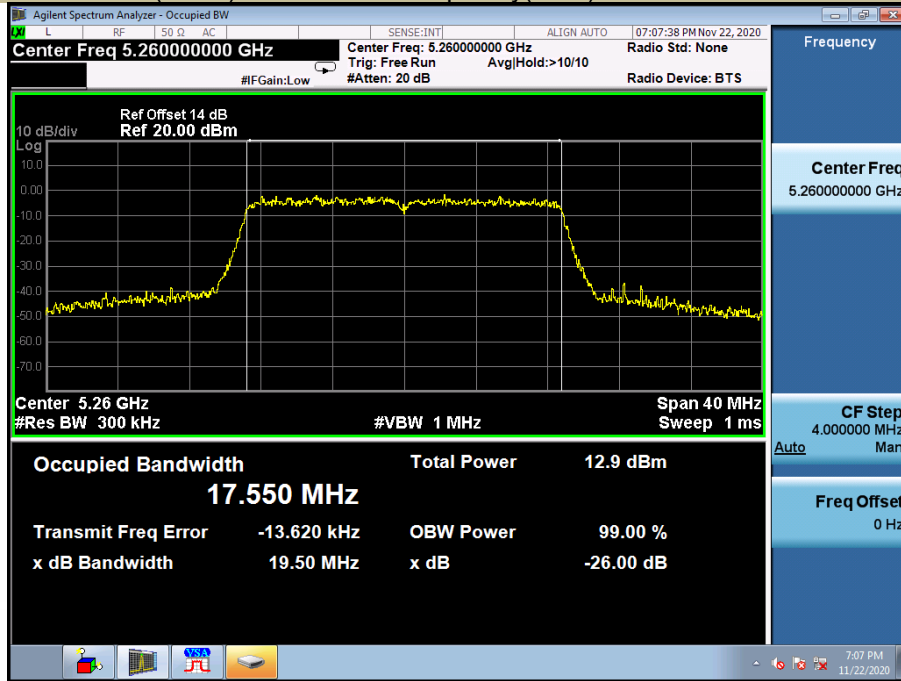

99%& 26dB Occupied Bandwidth
Test Model 802.11ac(HT20)

U-NII – 2A
Frequency(MHz) 5280

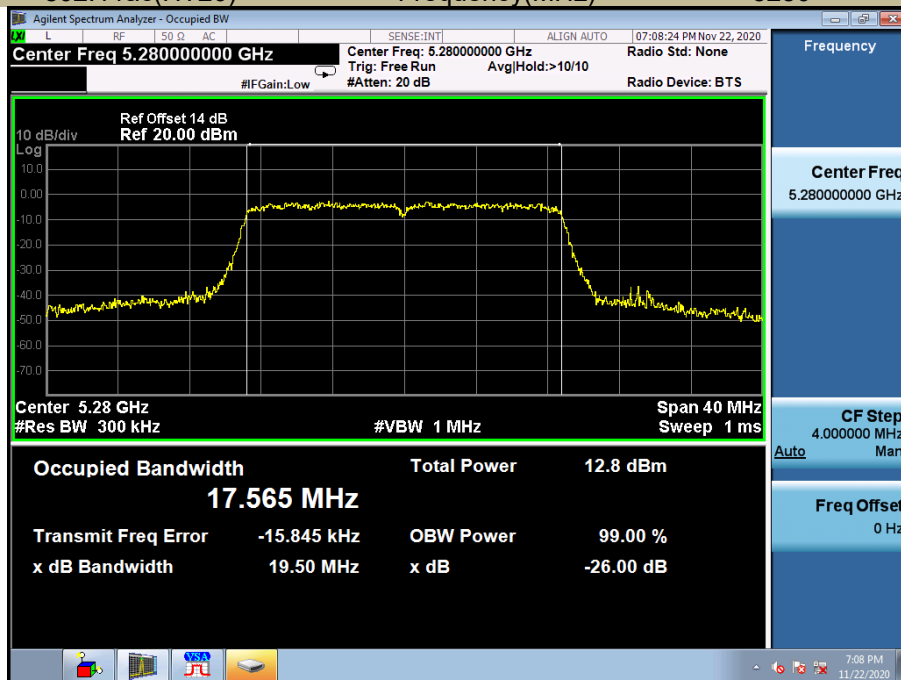

99%& 26dB Occupied Bandwidth
Test Model 802.11ac(HT20)

U-NII – 2A
Frequency(MHz) 5320

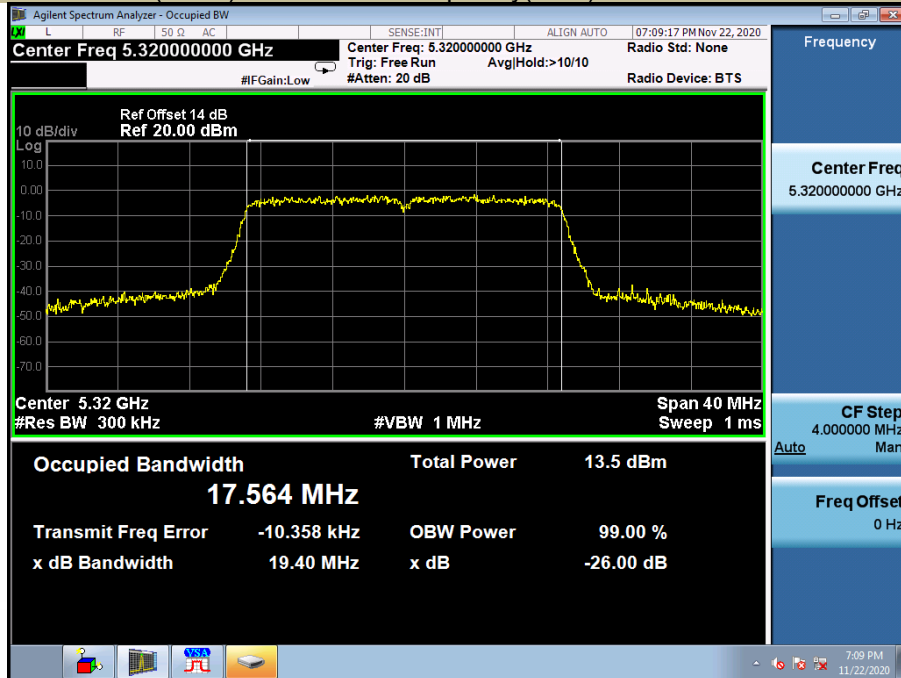

99%& 26dB Occupied Bandwidth
Test Model 802.11n-HT40

U-NII – 2A
Frequency(MHz) 5270

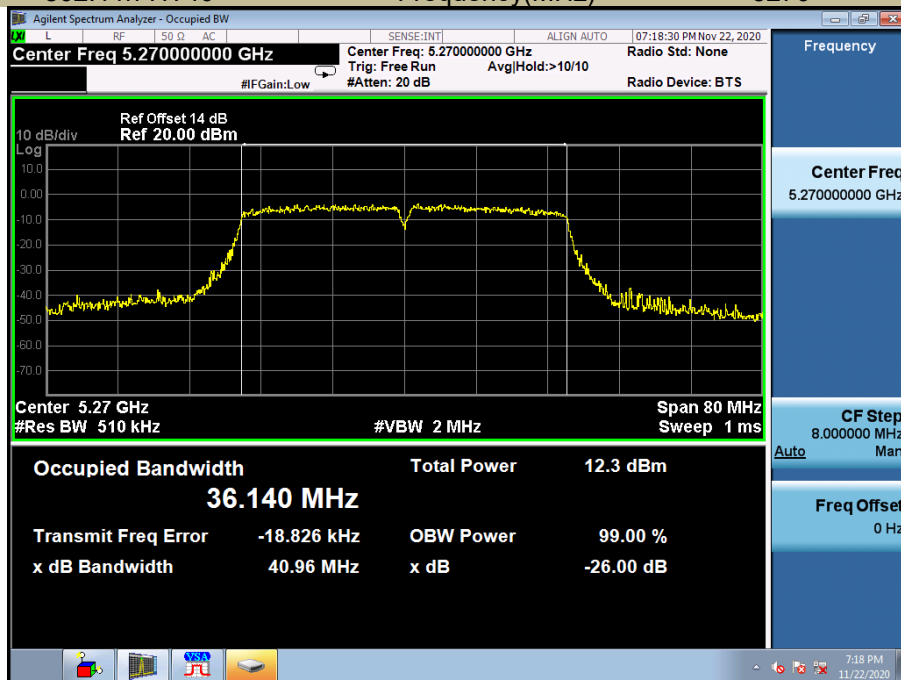

99%& 26dB Occupied Bandwidth
Test Model 802.11n-HT40

U-NII – 2A
Frequency(MHz) 5310



99%& 26dB Occupied Bandwidth
Test Model 802.11ac(HT40)

U-NII – 2A
Frequency(MHz) 5270

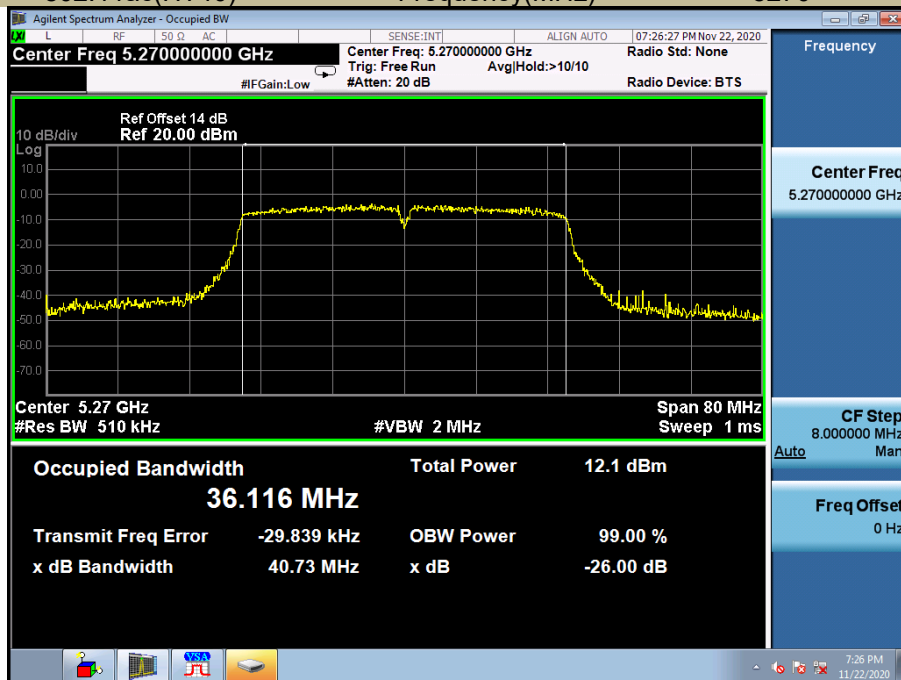

99%& 26dB Occupied Bandwidth
Test Model 802.11ac(HT40)

U-NII – 2A
Frequency(MHz) 5310

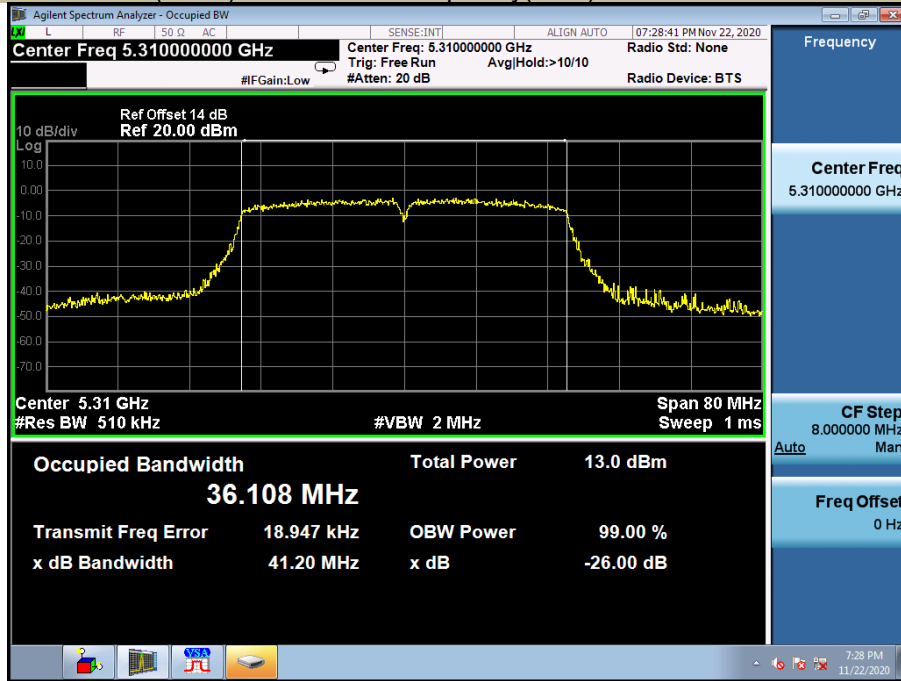

99%& 26dB Occupied Bandwidth
Test Model 802.11ac 80

U-NII – 2A
Frequency(MHz) 5290

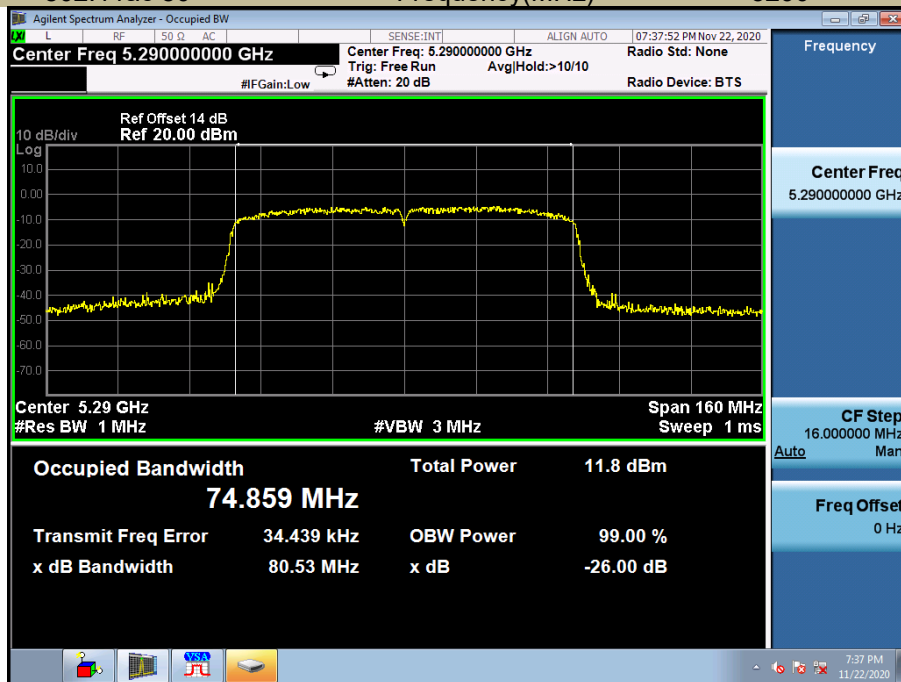

5470-5725MHz

Test Mode	Test Channel MHz		26dB Bandwidth MHz	99% Bandwidth MHz	Verdict
802.11a	CH100	5500	18.58	16.377	Pass
	CH116	5580	18.89	16.406	Pass
	CH140	5700	18.46	16.399	Pass
802.11n-HT20	CH100	5500	19.37	17.559	Pass
	CH116	5580	19.57	17.575	Pass
	CH140	5700	19.56	17.572	Pass
802.11ac(HT20)	CH100	5500	19.63	17.562	Pass
	CH116	5580	19.53	17.579	Pass
	CH140	5700	19.64	17.563	Pass
802.11n-HT40	CH102	5510	40.80	36.037	Pass
	CH134	5670	41.15	36.174	Pass
802.11ac(HT40)	CH102	5510	40.94	36.031	Pass
	CH134	5670	40.75	36.099	Pass
802.11ac(HT80)	CH106	5530	80.53	74.742	Pass

99%& 26dB Occupied Bandwidth
Test Model 802.11a

U-NII – 2C
Frequency(MHz)

5500



99%& 26dB Occupied Bandwidth
Test Model 802.11a

U-NII – 2C
Frequency(MHz)

5580

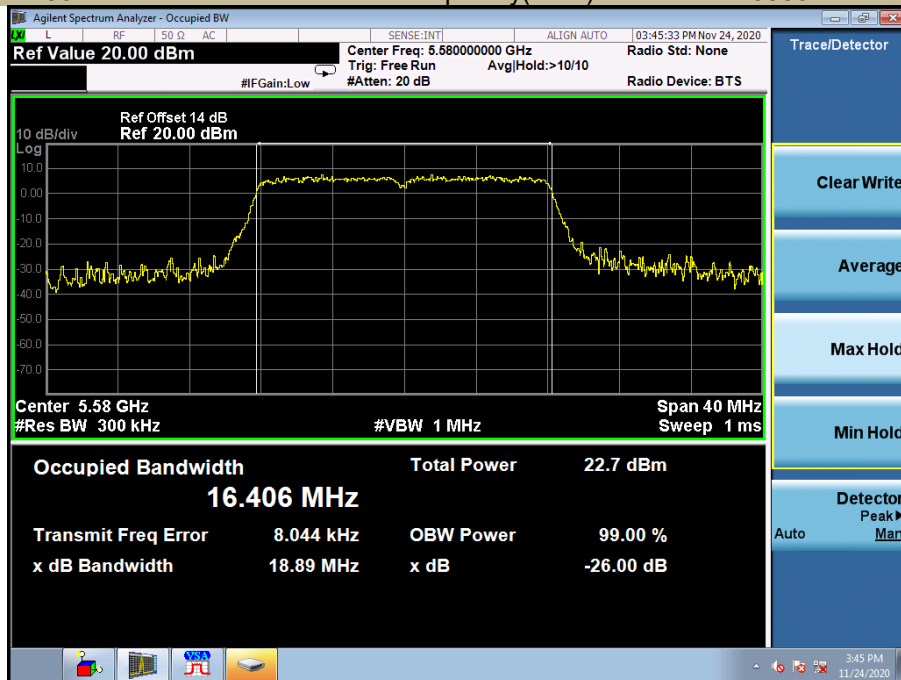

99%& 26dB Occupied Bandwidth
Test Model 802.11a

U-NII – 2C
Frequency(MHz) 5700

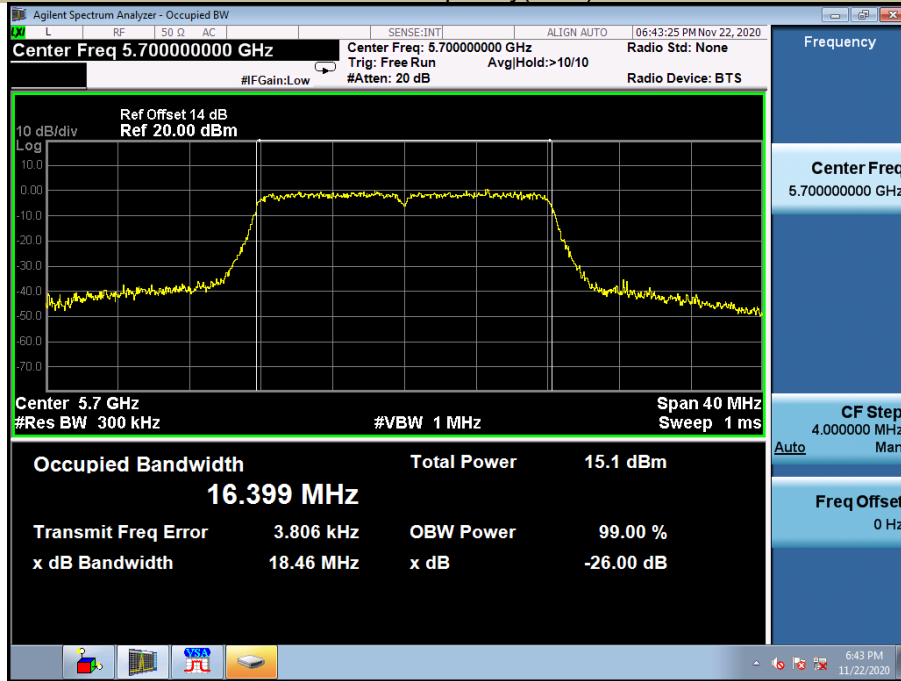

99%& 26dB Occupied Bandwidth
Test Model 802.11n-HT20

U-NII – 2C
Frequency(MHz) 5500

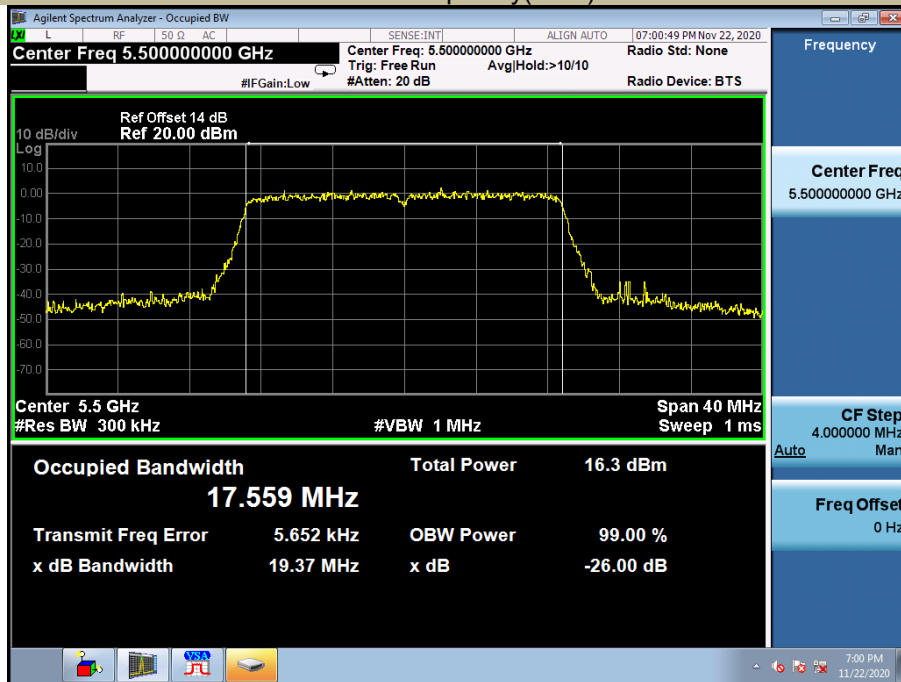

99%& 26dB Occupied Bandwidth
Test Model 802.11n-HT20

U-NII – 2C
Frequency(MHz) 5580

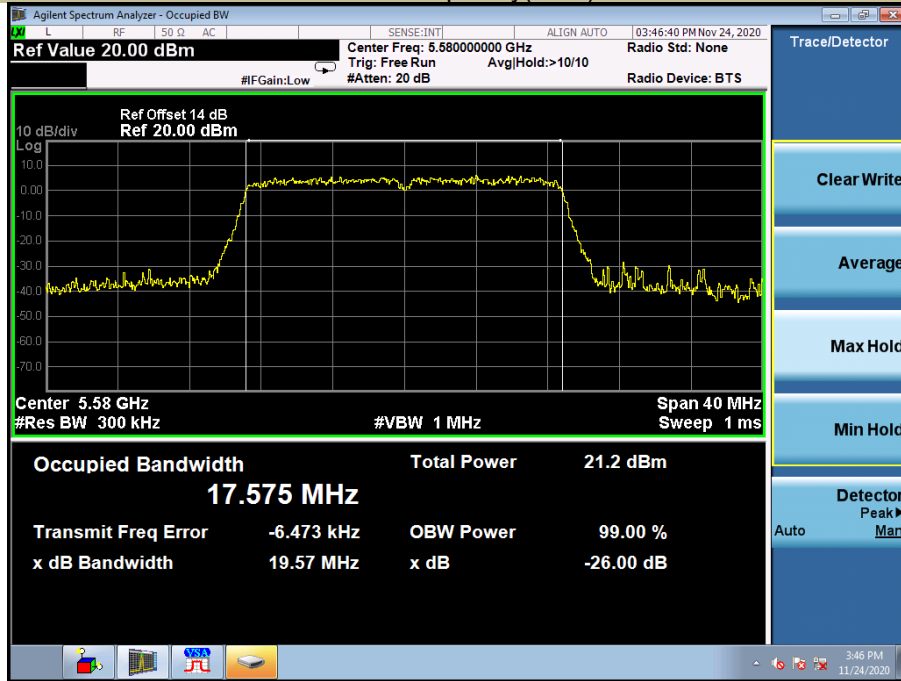

99%& 26dB Occupied Bandwidth
Test Model 802.11n-HT20

U-NII – 2C
Frequency(MHz) 5700

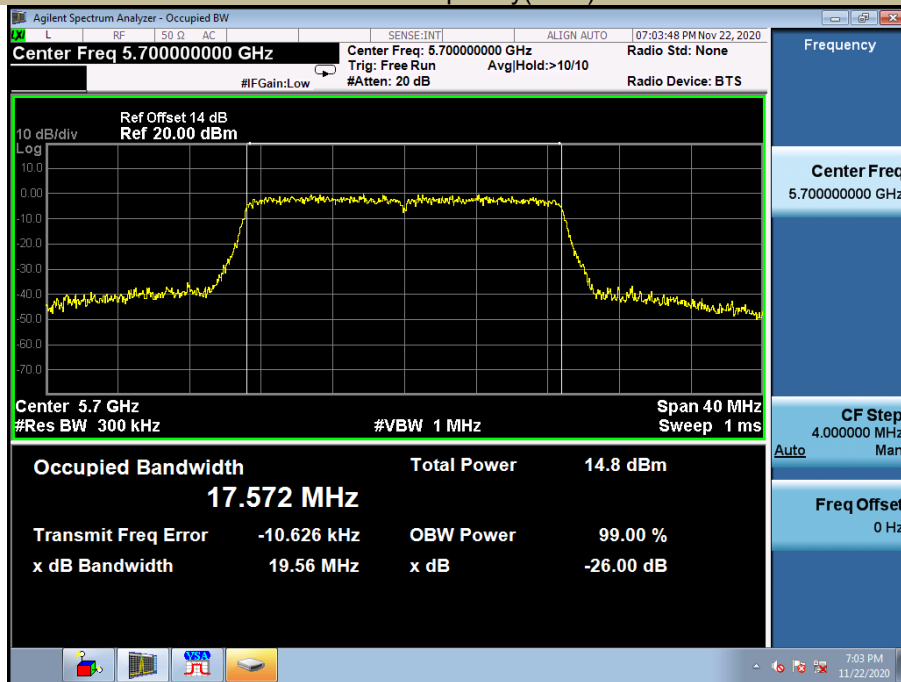

99%& 26dB Occupied Bandwidth
Test Model 802.11ac(HT20)

U-NII – 2C
Frequency(MHz)

5500



99%& 26dB Occupied Bandwidth
Test Model 802.11ac(HT20)

U-NII – 2C
Frequency(MHz)

5580

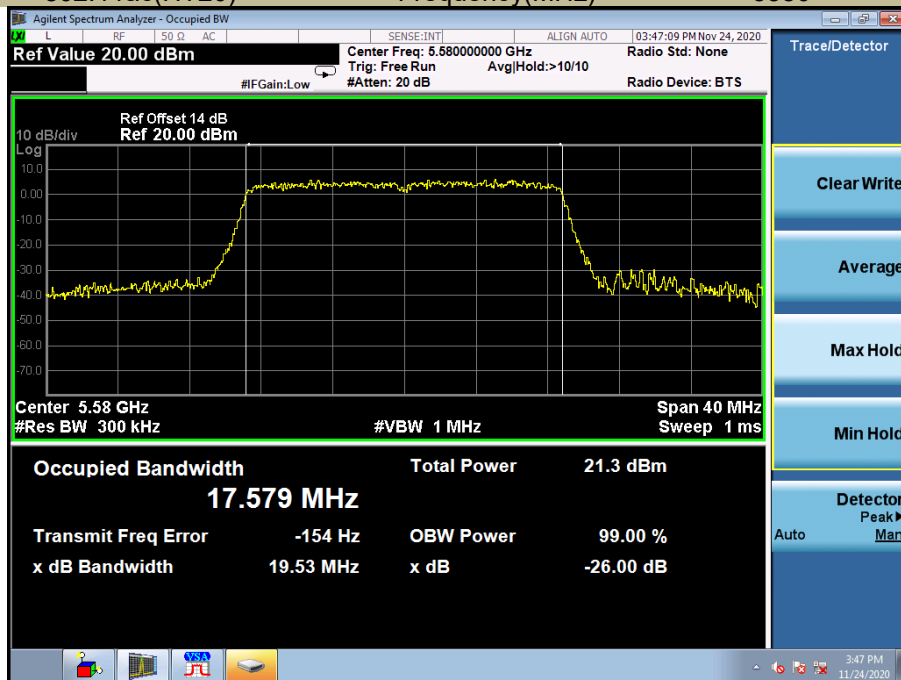

99%& 26dB Occupied Bandwidth
Test Model 802.11ac(HT20)

U-NII – 2C
Frequency(MHz) 5700

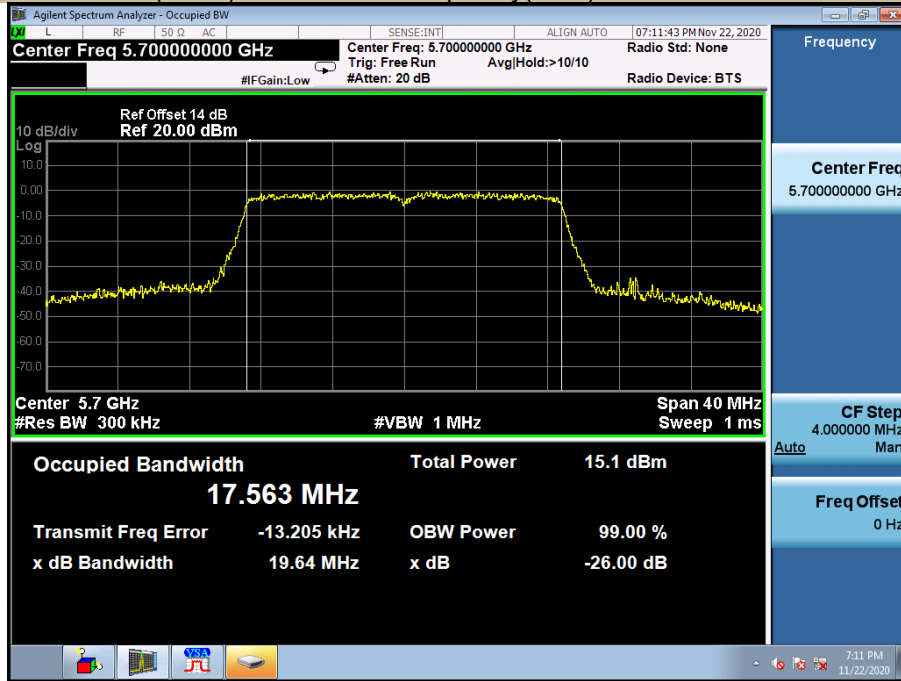

99%& 26dB Occupied Bandwidth
Test Model 802.11n-HT40

U-NII – 2C
Frequency(MHz) 5510

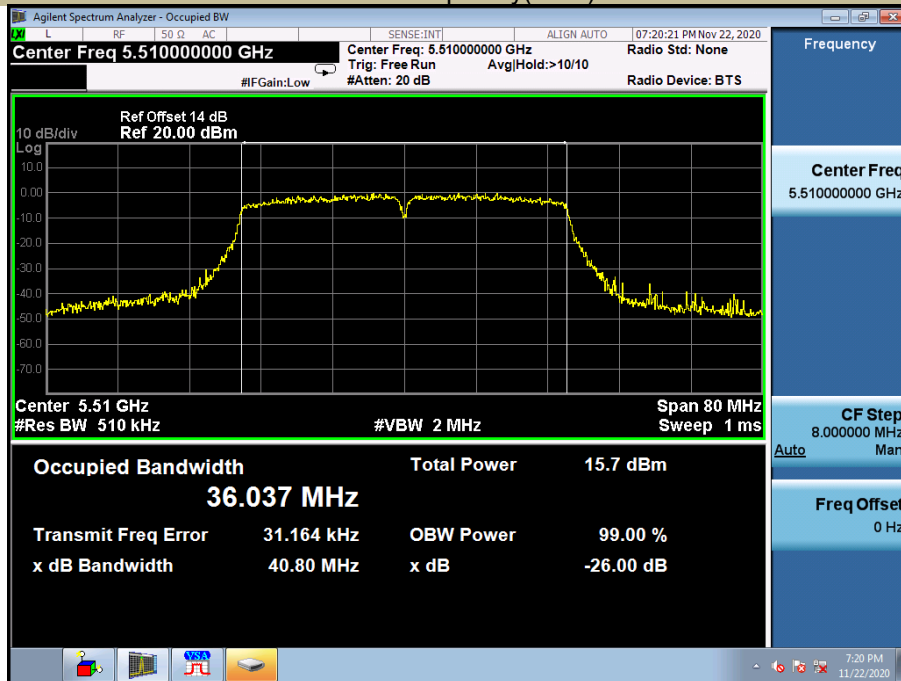

99%& 26dB Occupied Bandwidth
Test Model 802.11n-HT40

U-NII – 2C
Frequency(MHz) 5670

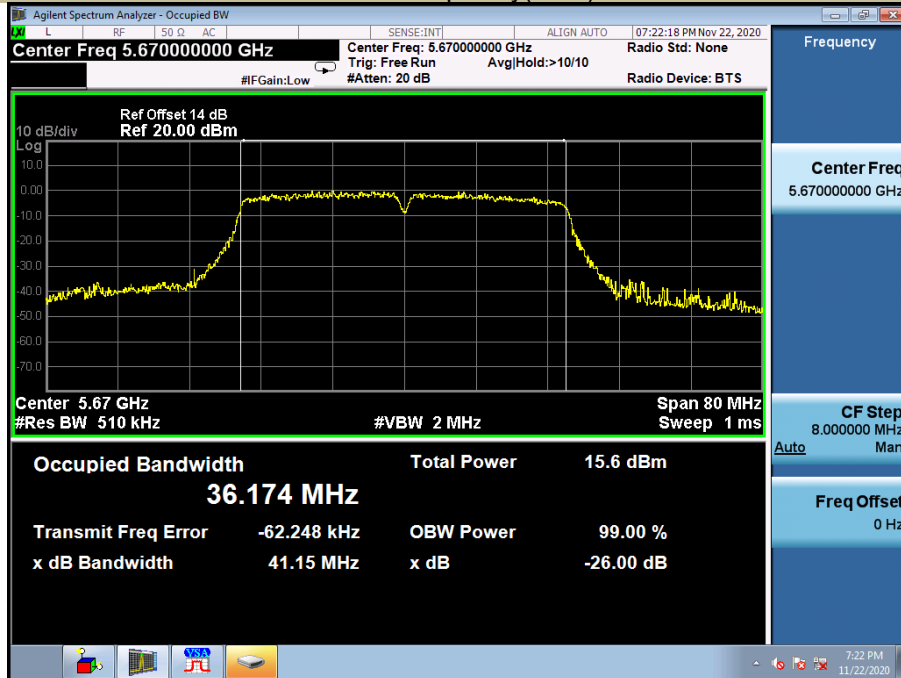

99%& 26dB Occupied Bandwidth
Test Model 802.11ac(HT40)

U-NII – 2C
Frequency(MHz) 5510

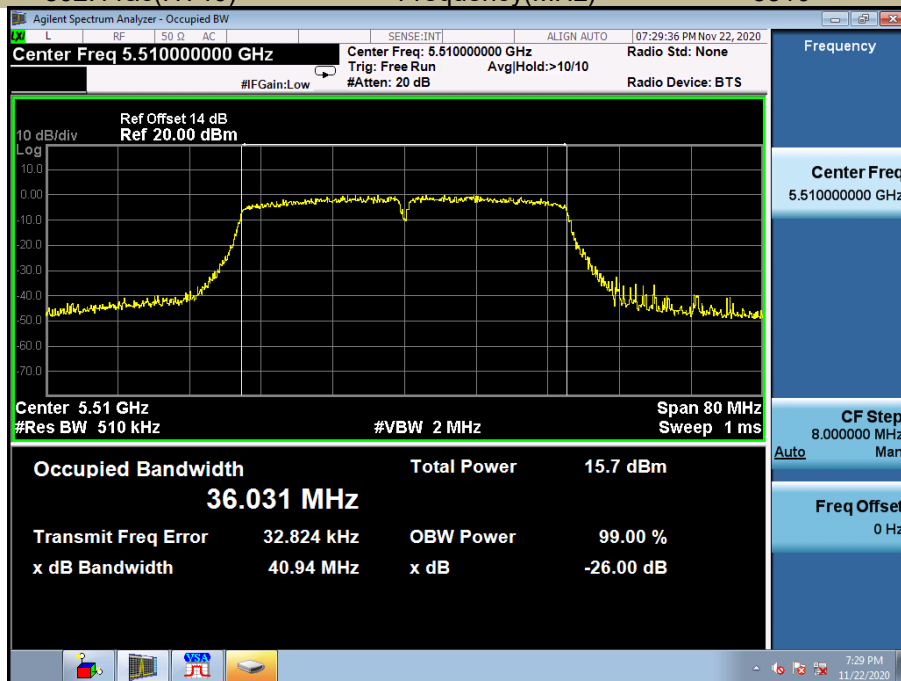

99%& 26dB Occupied Bandwidth
Test Model 802.11ac(HT40)

U-NII – 2C
Frequency(MHz) 5670



99%& 26dB Occupied Bandwidth
Test Model 802.11ac 80

U-NII – 2C
Frequency(MHz) 5530

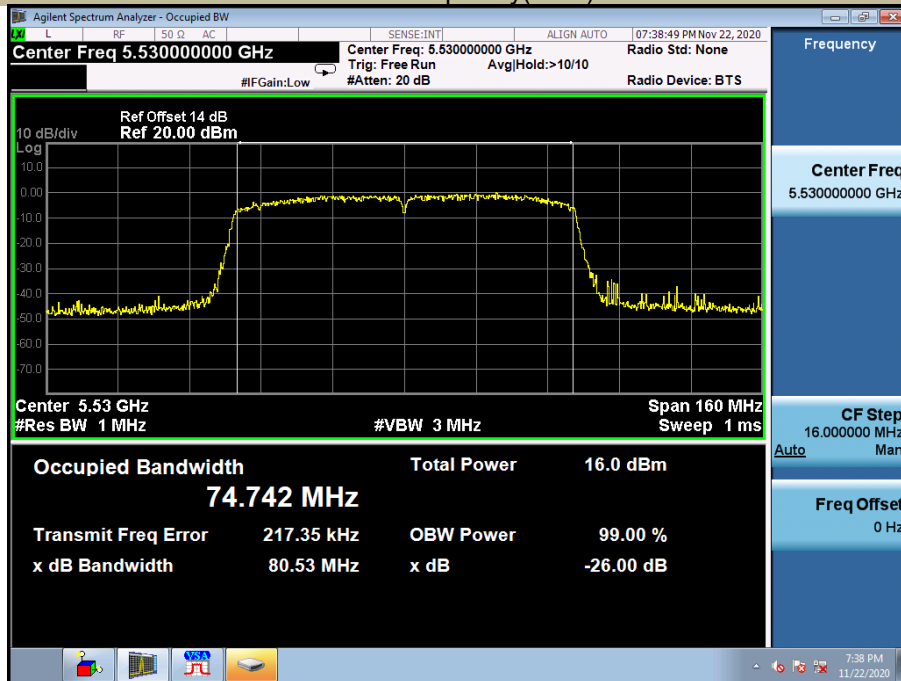

5725-5850MHz

Test Mode	Test Channel MHz		6 dB Bandwidth MHz	26dB Bandwidth MHz	99% Bandwidth MHz	Limit kHz
802.11a	CH149	5745	16.324	18.987	16.382	≥500
	CH157	5785	16.324	18.929	16.439	≥500
	CH165	5825	16.382	18.813	16.382	≥500
802.11n-HT20	CH149	5745	17.540	19.740	17.597	≥500
	CH157	5785	17.598	19.797	17.597	≥500
	CH165	5825	17.598	19.797	17.539	≥500
802.11ac(HT20)	CH149	5745	17.598	19.747	17.539	≥500
	CH157	5785	17.540	19.797	17.539	≥500
	CH165	5825	17.598	19.740	17.597	≥500
802.11n-HT40	CH151	5755	35.43	42.14	36.121	≥500
	CH159	5795	35.20	41.45	36.468	≥500
802.11ac(HT40)	CH151	5755	35.54	41.68	36.237	≥500
	CH159	5795	35.43	41.56	36.353	≥500
802.11ac(HT80)	CH155	5775	75.25	81.97	74.790	≥500

26dB Occupied Bandwidth
Test Model 802.11a

U-NII - 3
Frequency(MHz)

5745

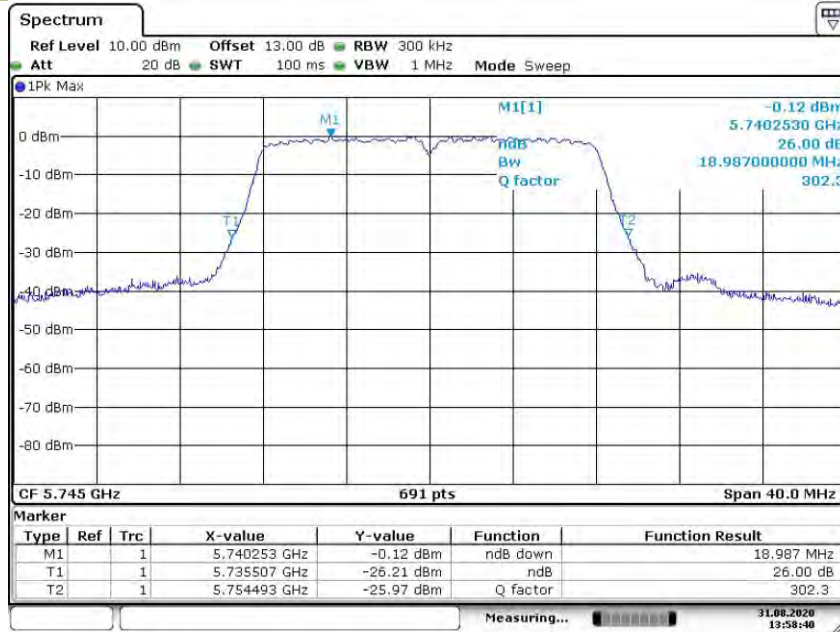

Date: 31.AUG.2020 13:58:40

26dB Occupied Bandwidth
Test Model 802.11a

U-NII - 3
Frequency(MHz)

5785

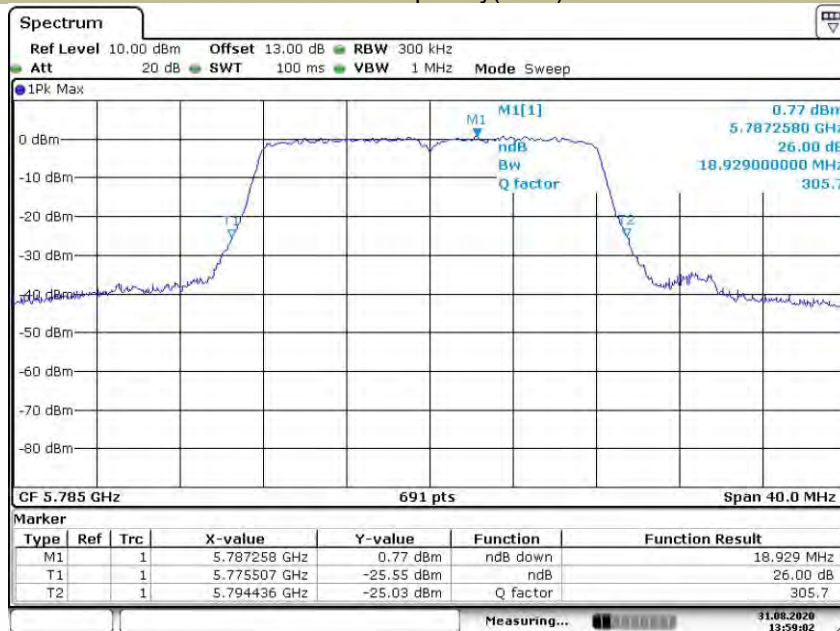

Date: 31.AUG.2020 13:59:02

26dB Occupied Bandwidth

U-NII - 3

Test Model 802.11a

Frequency(MHz)

5825

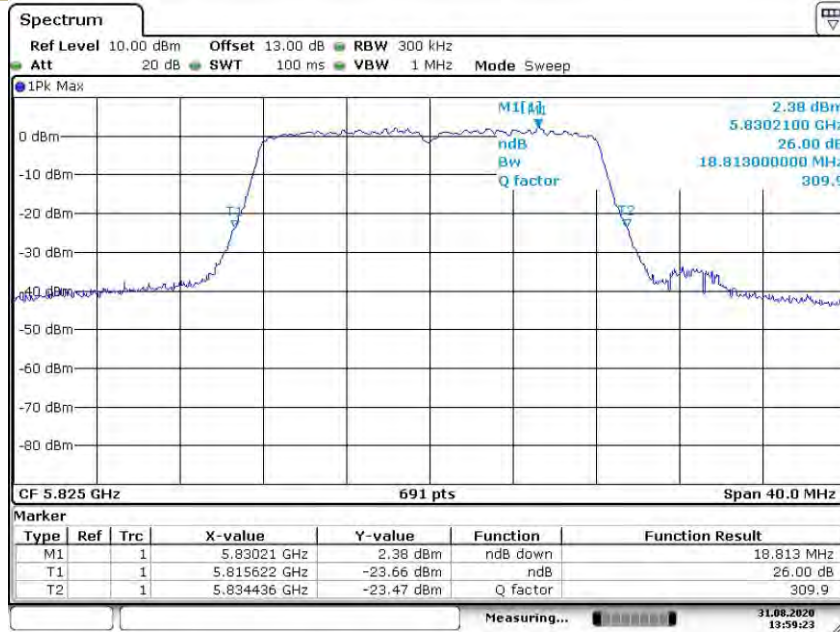

Date: 31 AUG 2020 13:59:23

26dB Occupied Bandwidth

U-NII - 3

Test Model 802.11n-HT20

Frequency(MHz)

5745

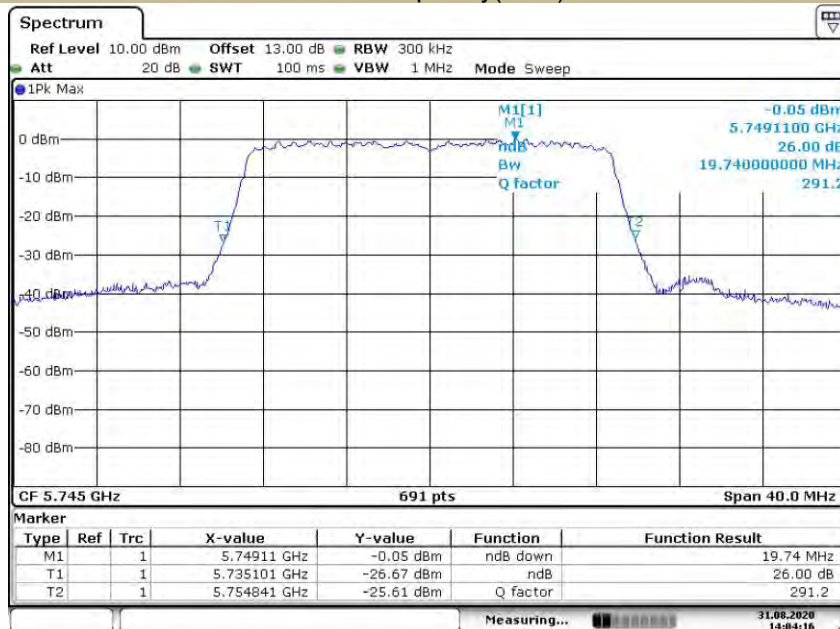

Date: 31 AUG 2020 14:04:17

26dB Occupied Bandwidth
Test Model 802.11n-HT20

U-NII - 3
Frequency(MHz)

5785

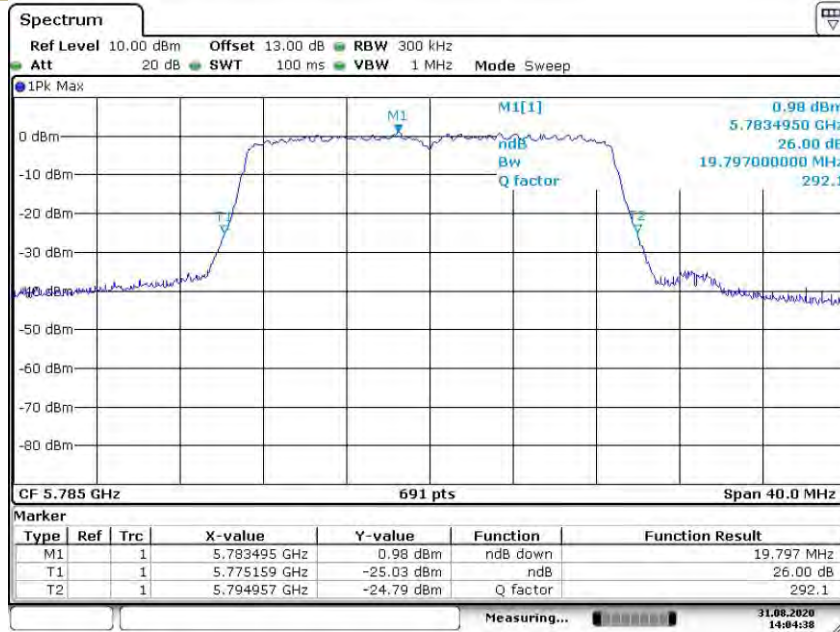

Date: 31 AUG 2020 14:04:38

26dB Occupied Bandwidth
Test Model 802.11n-HT20

U-NII - 3
Frequency(MHz)

5825

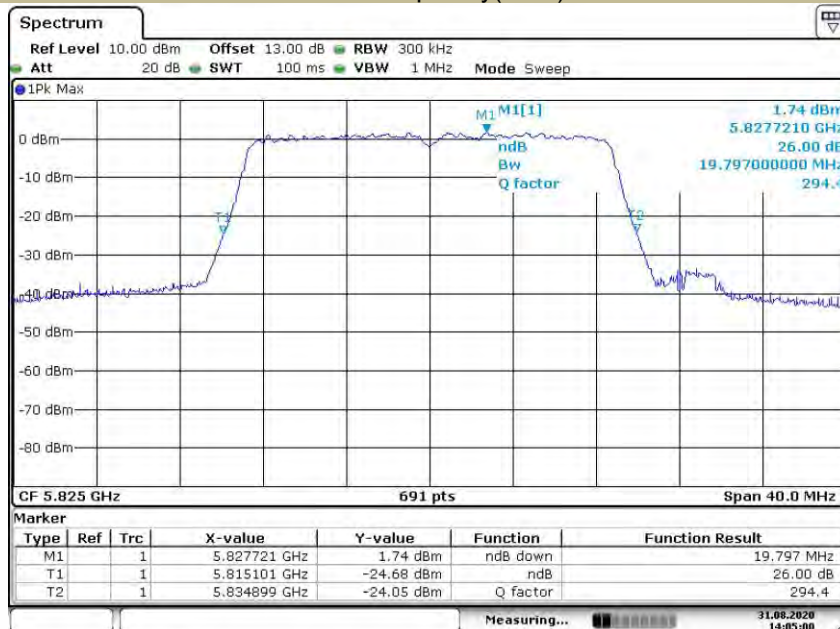

Date: 31 AUG 2020 14:05:00

26dB Occupied Bandwidth
Test Model 802.11ac(HT20)

U-NII - 3
Frequency(MHz)

5745

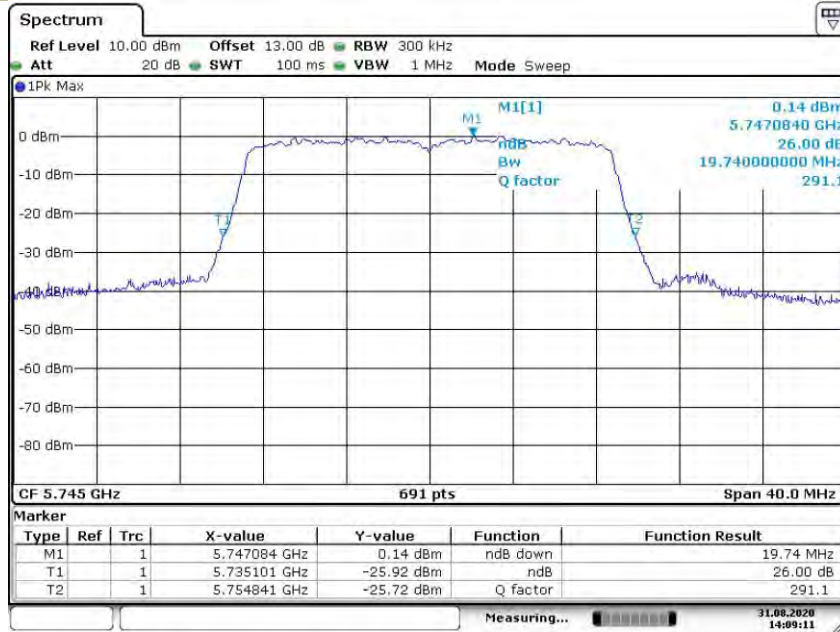

Date: 31 AUG 2020 14:09:10

26dB Occupied Bandwidth
Test Model 802.11ac(HT20)

U-NII - 3
Frequency(MHz)

5785

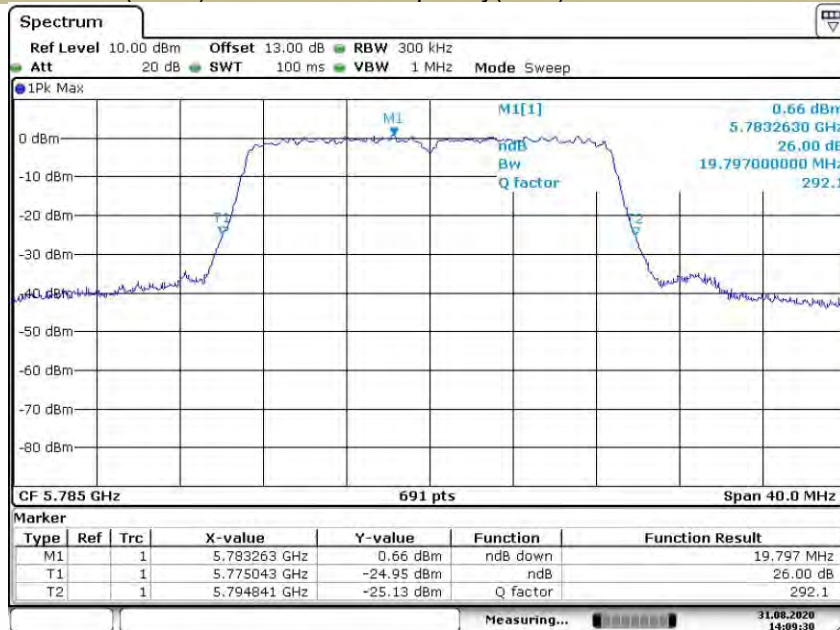

Date: 31 AUG 2020 14:09:29