

TEST REPORT

Report No.: BCTC2312391622-2E

Applicant: Telecell Mobile (H.K) Ltd.

Product Name: LTE Bar Phone

Test Model: FURY LTE T1

Tested Date: 2023-12-29 to 2024-01-11

Issued Date: 2024-01-11

Shenzhen BCTC Testing Co., Ltd.



FCC ID: 2ADX3T1

Product Name: LTE Bar Phone
Trademark: FIGO
Model/Type reference: FURY LTE T1
Prepared For: Telecell Mobile (H.K) Ltd.
Address: RM 801 Metro Ctr II, 21 Lam Hing Street Kln Bay, Hong Kong
Manufacturer: Telecell Mobile (H.K) Ltd.
Address: RM 801 Metro Ctr II, 21 Lam Hing Street Kln Bay, Hong Kong
Prepared By: Shenzhen BCTC Testing Co., Ltd.
Address: 1-2/F., Building B, Pengzhou Industrial Park, No.158, Fuyuan 1st Road, Zhancheng, Fuhai Subdistrict, Bao'an District, Shenzhen, Guangdong, China
Sample Received Date: 2023-12-29
Sample tested Date: 2023-12-29 to 2024-01-11
Issue Date: 2024-01-11
Report No.: BCTC2312391622-2E
FCC CFR Title 47 Part 2
FCC CFR Title 47 Part22 Subpart H
FCC CFR Title 47 Part24 Subpart E
ANSI/ TIA/ EIA-603-D-2010
FCC KDB 971168 D01 Power Meas. License Digital Systems v02v02
Test Standards:
Test Results: PASS
Remark: This is GSM & WCDMAradio test report.

Tested by:

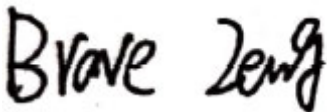

Brave Zeng/ Project Handler

Approved by:



Zero Zhou/Reviewer

The test report is effective only with both signature and specialized stamp. This result(s) shown in this report refer only to the sample(s) tested. Without written approval of Shenzhen BCTC Testing Co., Ltd, this report can't be reproduced except in full. The tested sample(s) and the sample information are provided by the client.

Table Of Content

	Page
Test Report Declaration	
1. Version	5
2. Test Summary	6
3. Measurement Uncertainty	7
4. Product Information And Test Setup	8
4.1 Product Information	8
4.2 Test Setup Configuration	9
4.3 Support Equipment	9
4.5 Test Mode	10
4.6 Test Environment	11
5. Test Facility And Test Instrument Used	12
5.1 Test Facility	12
5.2 Test Instrument Used	12
6. RF Output Power	13
6.1 Block Diagram Of Test Setup	13
6.2 Limit	14
6.3 Test procedure	15
6.4 Test Result	15
7. Peak-to-average Ratio(PAR) of Transmitter	21
7.1 Block Diagram Of Test Setup	21
7.2 Limit	21
7.3 Test procedure	21
7.4 Test Result	21
8. Emission Bandwidth	33
8.1 Block Diagram Of Test Setup	33
8.2 Limit	33
8.3 Test procedure	33
8.4 Test Result	33
9. Out of Band Emissions at Antenna Terminal	45
9.1 Block Diagram Of Test Setup	45
9.2 Limit	45
9.3 Test procedure	45
9.4 Test Result	45
10. Spurious Radiated Emissions	61
10.1 Block Diagram Of Test Setup	61
10.2 Limit	62
10.3 Test procedure	62
10.4 Test Result	63
11. Frequency Stability	65
11.1 Block Diagram Of Test Setup	65
11.2 Limit	65
11.3 Test procedure	65
11.4 Test Result	66
12. EUT Photographs	69
13. EUT Test Setup Photographs	70

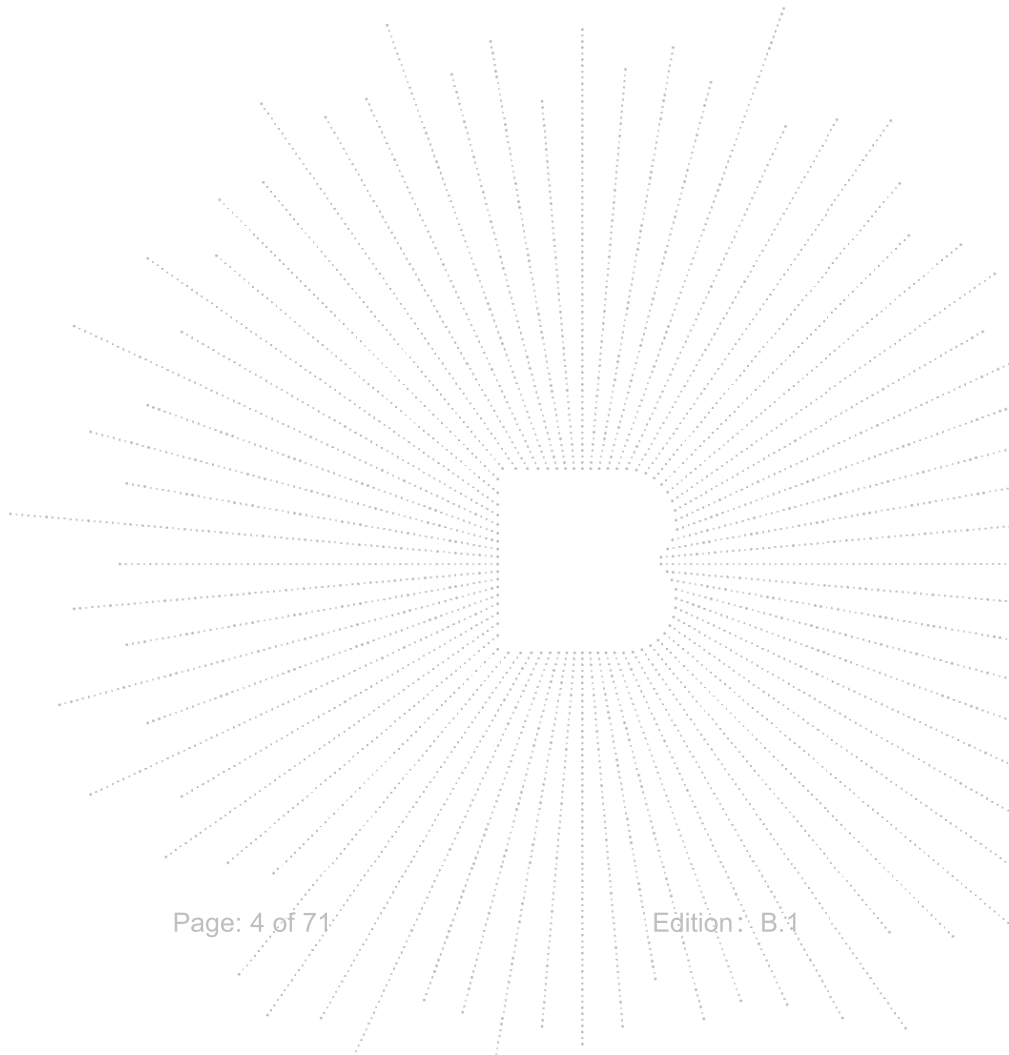

1. Version

Report No.	Issue Date	Description	Approved
BCTC2312391622-2E	2024-01-11	Original	Valid

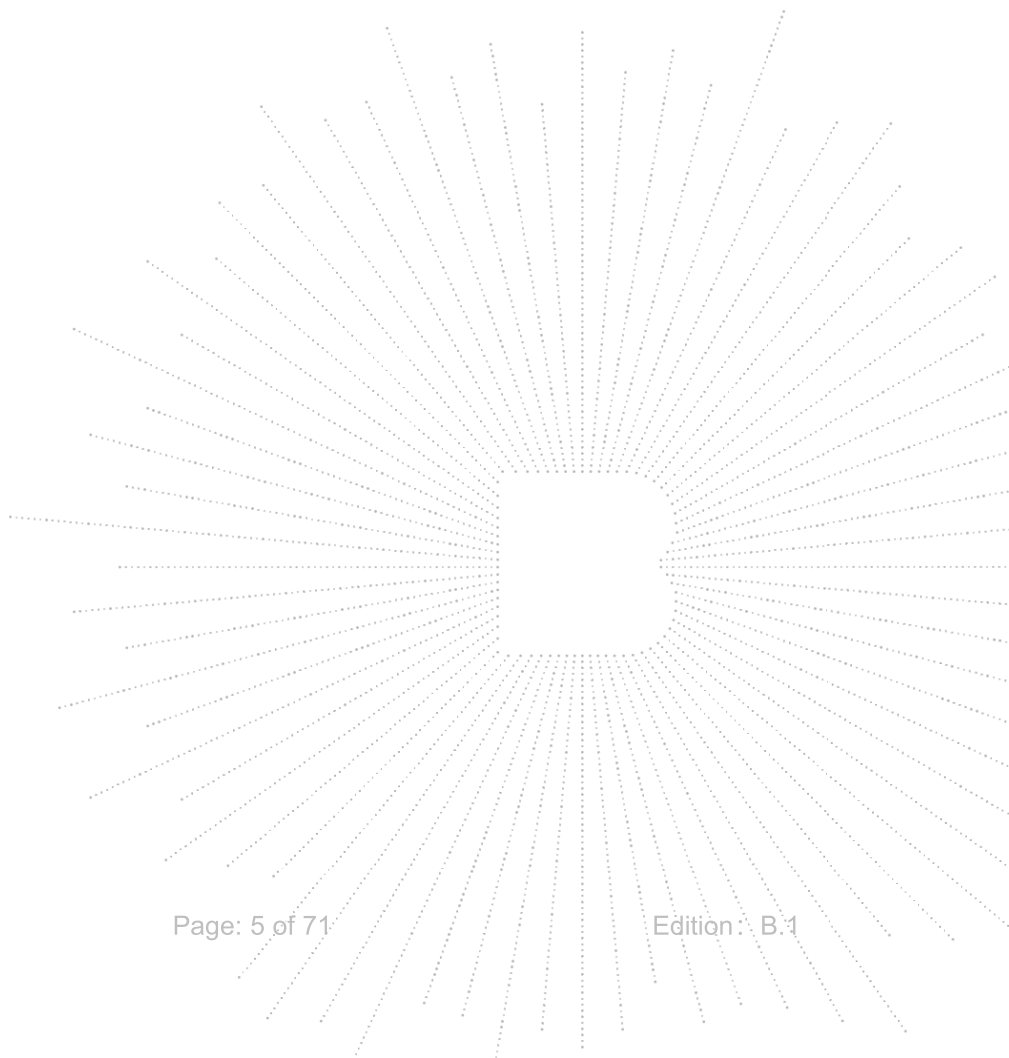

2. Test Summary

The Product has been tested according to the following specifications:

No.	Test Parameter	Clause No.	Results
1	RF Exposure	§1.1307, §2.1093	PASS
2	RF Output Power	§22.913 (a), §24.232 (c)	PASS
3	Peak-to-average Ratio(PAR) of Transmitter	§24.232(d), §22.913	PASS
4	Emission Bandwidth	§22.917 (b), §24.238(b)	PASS
5	Spurious Emissions at Antenna Terminal	§22.917 (a), §24.238 (a),	PASS
6	Spurious Radiation Emissions	§22.917 (a), §24.238 (a)	PASS
7	Out of Band Emissions	§22.917 (a), §24.238 (a)	PASS
8	Frequency Stability	§22.355, §24.235	PASS

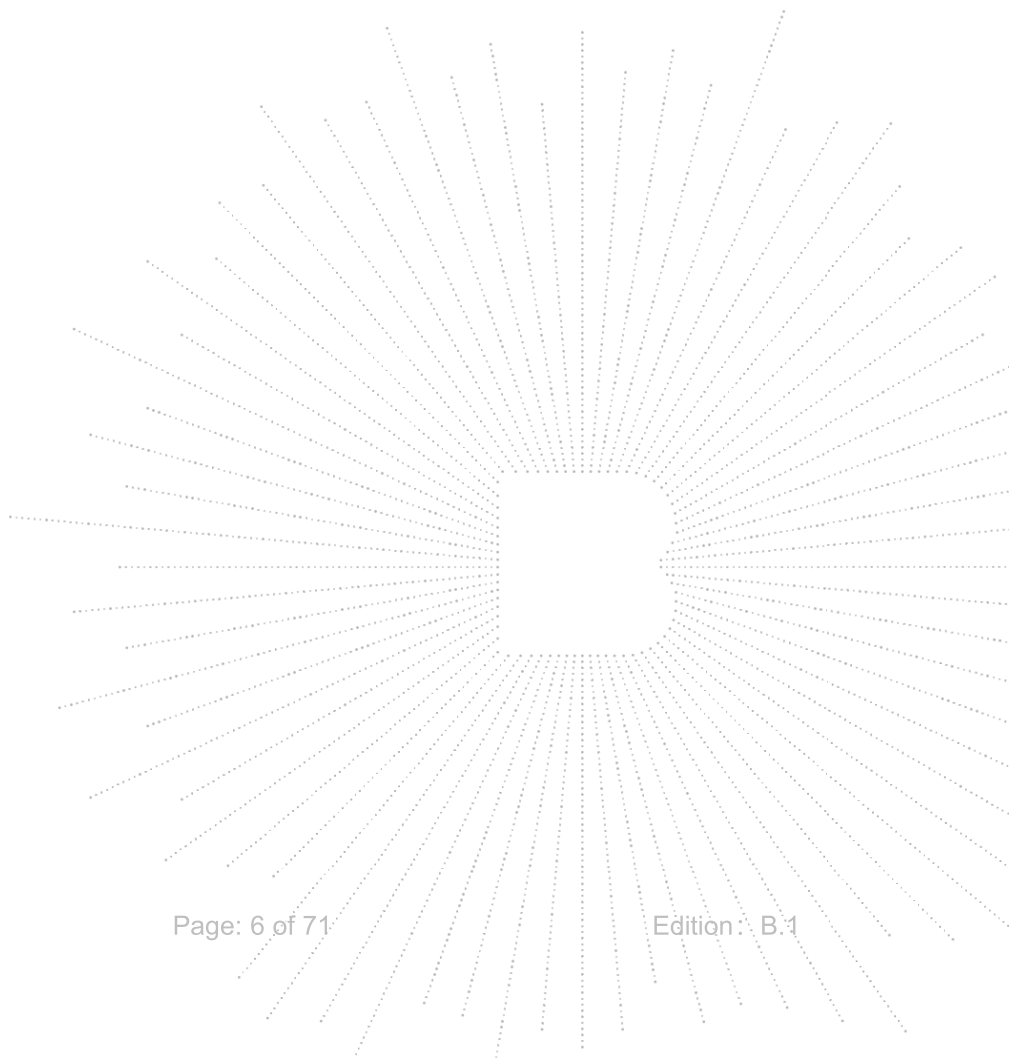

3. Measurement Uncertainty

Where relevant, the following measurement uncertainty levels have been estimated for tests performed on the Product as specified in CISPR 16-4-2. This uncertainty represents an expanded uncertainty expressed at approximately the 95% confidence level using a coverage factor of $k=2$.

No.	Item	Uncertainty
1	3m chamber Radiated spurious emission(30MHz-1GHz)	U=4.3dB
2	3m chamber Radiated spurious emission(9KHz-30MHz)	U=3.7dB
3	3m chamber Radiated spurious emission(1GHz-18GHz)	U=4.5dB
4	3m chamber Radiated spurious emission(18GHz-40GHz)	U=3.34dB
5	Conducted Emission (150kHz-30MHz)	U=3.20dB
6	Conducted Adjacent channel power	U=1.38dB
7	Conducted output power uncertainty Above 1G	U=1.576dB
8	Conducted output power uncertainty below 1G	U=1.28dB
9	humidity uncertainty	U=5.3%
10	Temperature uncertainty	U=0.59°C

4. Product Information And Test Setup

4.1 Product Information

Model/Type reference:	FURY LTE T1
Model differences:	N/A
Hardware Version:	N/A
Software Version:	N/A
Operation Frequency:	GSM/GPRS 850: TX: 824~849MHz; RX: 869~894MHz; GSM/GPRS 1900: TX:1850~1910MHz; RX:1930~1990MHz; WCDMA Band II: TX: 1852.40~1907.60MHz; Rx: 1932.60~1987.40MHz; WCDMA Band V: TX: 826.40~846.60MHz; RX: 871.40~ 891.60MHz;
GPRS Class:	Class 12
Max RF Output Power:	GSM/GPRS 850: 32.87 dBm, GSM/GPRS 1900: 29.33 dBm WCDMA Band II: 21.72 dBm WCDMA Band V: 22.42 dBm
Type of Modulation:	GSM with GMSK Modulation WCDMA Mode with BPSK Modulation HSDPA Mode with QPSK, 16QAM Modulation HSUPA Mode with QPSK, 16QAM Modulation
Type of Emission:	GSM/GPRS 850: 249KGXW GSM/GPRS 1900: 246KGXW WCDMA Band II: 4M16F9W WCDMA Band V: 4M17F9W
Antenna installation:	Internal antenna
Antenna Gain:	GSM850: -0.3 dBi GSM1900: 1.2 dBi WCDMA Band II: 1.2 dBi WCDMA Band V: -0.3 dBi
Connecting I/O Port(s)	Please refer to the User's Manual
Ratings:	DC 5V from adapter/DC 3.7V from battery
Battery:	DC 3.7V, 950mAh, 3.515Wh
Adapter Information:	Model:T1 Input: AC 100-240V 50/60Hz 0.2A Output: DC 5.0V 500mA

4.2 Test Setup Configuration

See test photographs attached in *EUT TEST SETUP PHOTOGRAPHS* for the actual connections between Product and support equipment.

4.3 Support Equipment

No.	Device Type	Brand	Model	Series No.	Note
E-1	LTE Bar Phone	FIGO	FURY LTE T1	N/A	EUT
E-2	Adapter	N/A	T1	N/A	Auxiliary

Item	Shielded Type	Ferrite Core	Length	Note
C-1	N/A	N/A	1M	DC cable unshielded

Notes:

1. All the equipment/cables were placed in the worst-case configuration to maximize the emission during the test.
2. Grounding was established in accordance with the manufacturer's requirements and conditions for the intended use.

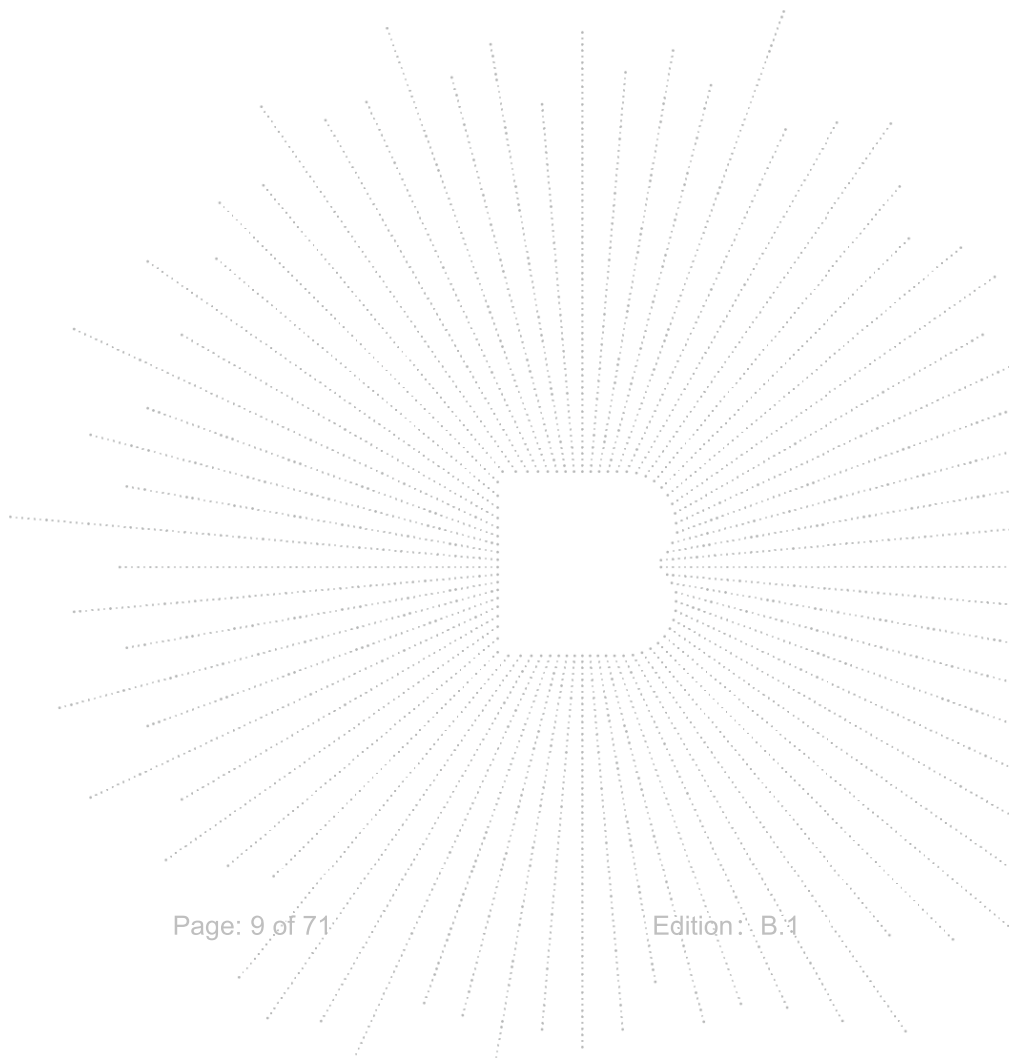

4.5 Test Mode

Testing Configure			
Support Band	Support Standard	Channel Frequency	Channel Number
GSM 850	GSM/GPRS	824.2 MHz	128
		836.6 MHz	190
		848.8 MHz	251
PCS 1900	GSM/GPRS	1850.2 MHz	512
		1880.0 MHz	661
		1909.8 MHz	810
WCDMA Band II	WCDMA/HSDPA/HSUPA	1852.4 MHz	9262
		1880.0 MHz	9400
		1907.6 MHz	9538
WCDMA Band V	WCDMA/HSDPA/HSUPA	826.4 MHz	4132
		836.4 MHz	4182
		846.6 MHz	4233

Note 1: the transmitter has been tested on the communications mode of WCDMA, HSDPA, HSUPA compliance test and record the worst case.
 Note 2: Both the SIM 1 and SIM 2 were tested, the worst mode is the SIM 1, the data recording in the report.

EUT Cable List and Details

Cable Description	Length (M)	Shielded/Unshielded	With Core/Without Core
/	/	/	/
/	/	/	/

Auxiliary Equipment List and Details

Description	Manufacturer	Model	Serial Number
/	/	/	/

Special Cable List and Details

Cable Description	Length (M)	Shielded/Unshielded	With Core/Without Core
/	/	/	/

4.6 Test Environment

1. Extreme Test Conditions:

For tests at extreme temperatures, measurements shall be made over the extremes of the operating temperature range as declared by the manufacturer.

For tests at extreme voltages, measurements shall be made over the extremes of the power source voltage range as declared by the manufacturer.

Test Conditions	VL	VH	VN
Test Voltage (DC)	3.33	4.07	3.7

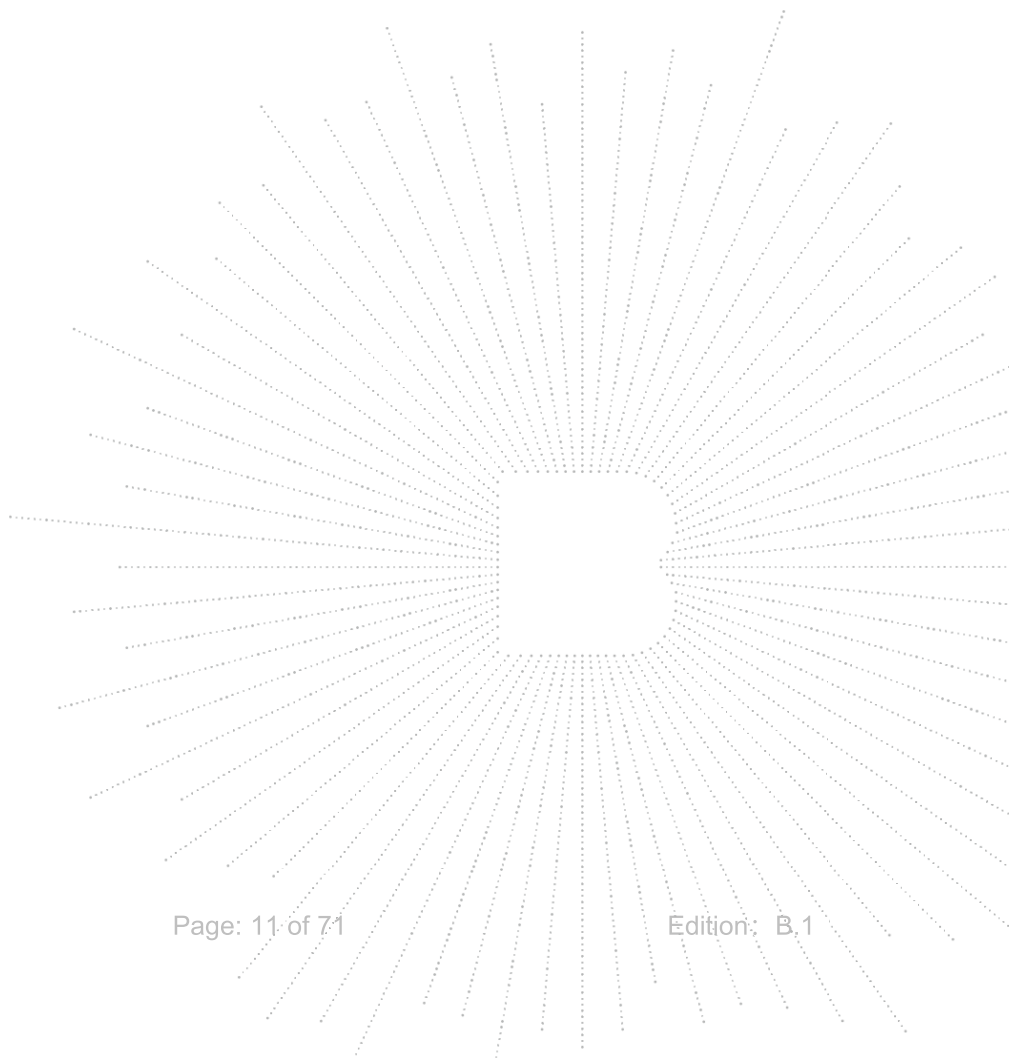

5. Test Facility And Test Instrument Used

5.1 Test Facility

All measurement facilities used to collect the measurement data are located at Shenzhen BCTC Testing Co., Ltd. Address:1-2/F., Building B, Pengzhou Industrial Park, No.158, Fuyuan 1st Road, Zhancheng, Fuhai Subdistrict, Bao'an District, Shenzhen, Guangdong, China. The site and apparatus are constructed in conformance with the requirements of ANSI C63.4 and CISPR 16-1-1 other equivalent standards.

FCC Test Firm Registration Number: 712850

A2LA certificate registration number is: CN1212

ISED Registered No.: 23583

ISED CAB identifier: CN0017

5.2 Test Instrument Used

Radiated Emissions Test (966 Chamber01)					
Equipment	Manufacturer	Model#	Serial#	Last Cal.	Next Cal.
966 chamber	ChengYu	966 Room	966	May 15, 2023	May 14, 2026
Receiver	R&S	ESR3	102075	May 15, 2023	May 14, 2024
Receiver	R&S	ESRP	101154	May 15, 2023	May 14, 2024
Amplifier	Schwarzbeck	BBV9744	9744-0037	May 15, 2023	May 14, 2024
TRILOG Broadband Antenna	Schwarzbeck	VULB9163	942	May 29, 2023	May 28, 2024
Loop Antenna(9KHz -30MHz)	Schwarzbeck	FMZB1519B	00014	May 31, 2023	May 30, 2024
Amplifier	SKET	LAPA_01G18 G-45dB	SK202104090 1	May 15, 2023	May 14, 2024
Horn Antenna	Schwarzbeck	BBHA9120D	1541	May 31, 2023	May 30, 2024
Amplifier(18G Hz-40GHz)	MITEQ	TTA1840-35-HG	2034381	May 15, 2023	May 14, 2024
Horn Antenna(18G Hz-40GHz)	Schwarzbeck	BBHA9170	00822	May 31, 2023	May 30, 2024
Spectrum Analyzer9kHz-40GHz	R&S	FSP40	100363	May 15, 2023	May 14, 2024
Communication test set	R&S	CMW500	126173	Nov. 13. 2023	Nov. 12, 2024
Software	Frad	EZ-EMC	FA-03A2 RE	\	\

6. RF Output Power

6.1 Block Diagram Of Test Setup

Conducted output power test method:

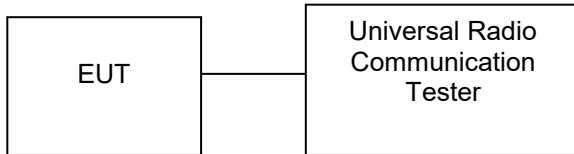

Radiated power test method:

(A) Radiated Emission Test-Up Frequency Below 30MHz

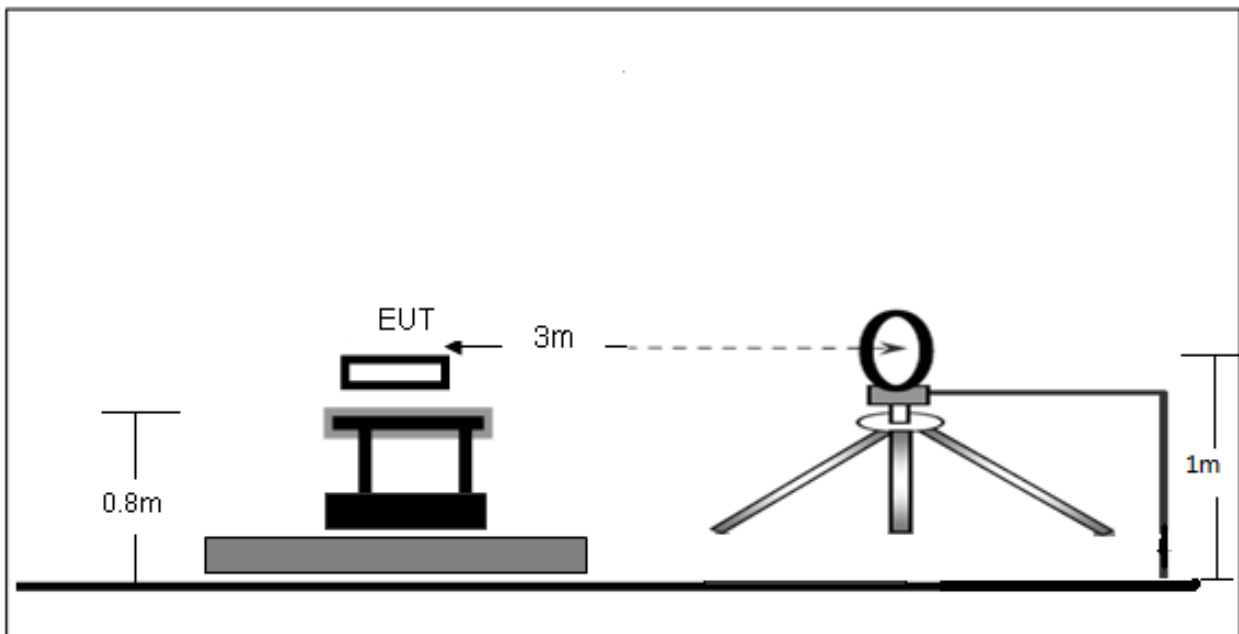

(B) Radiated Emission Test-Up Frequency 30MHz~1GHz

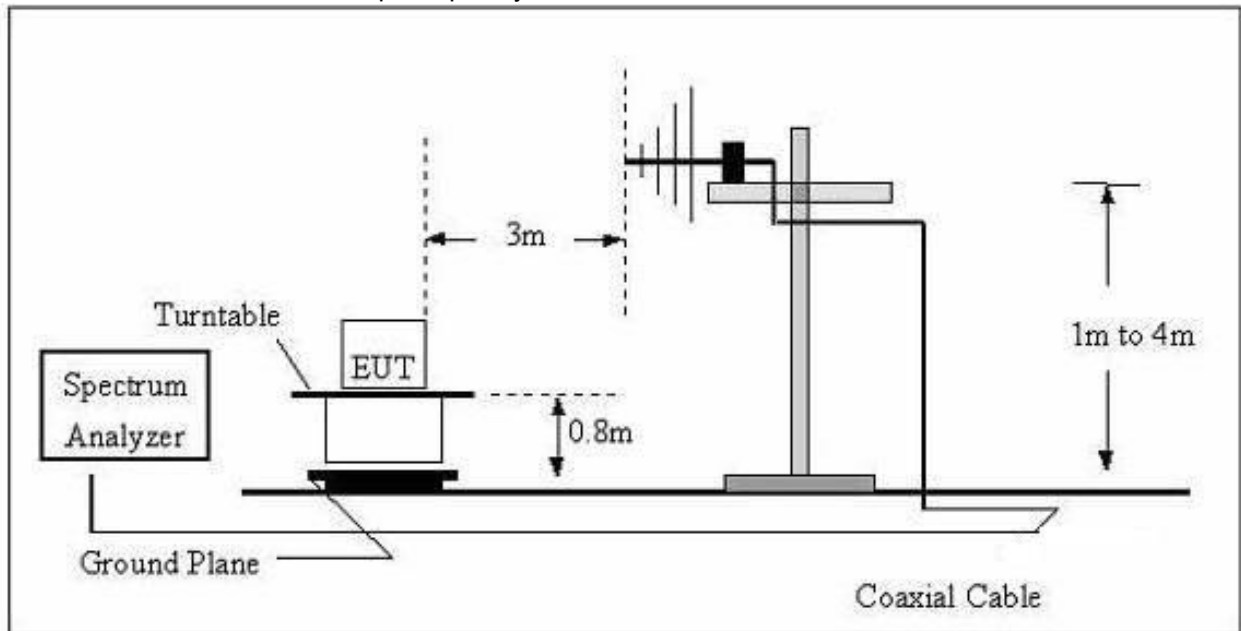

(C) Radiated Emission Test-Up Frequency Above 1GHz

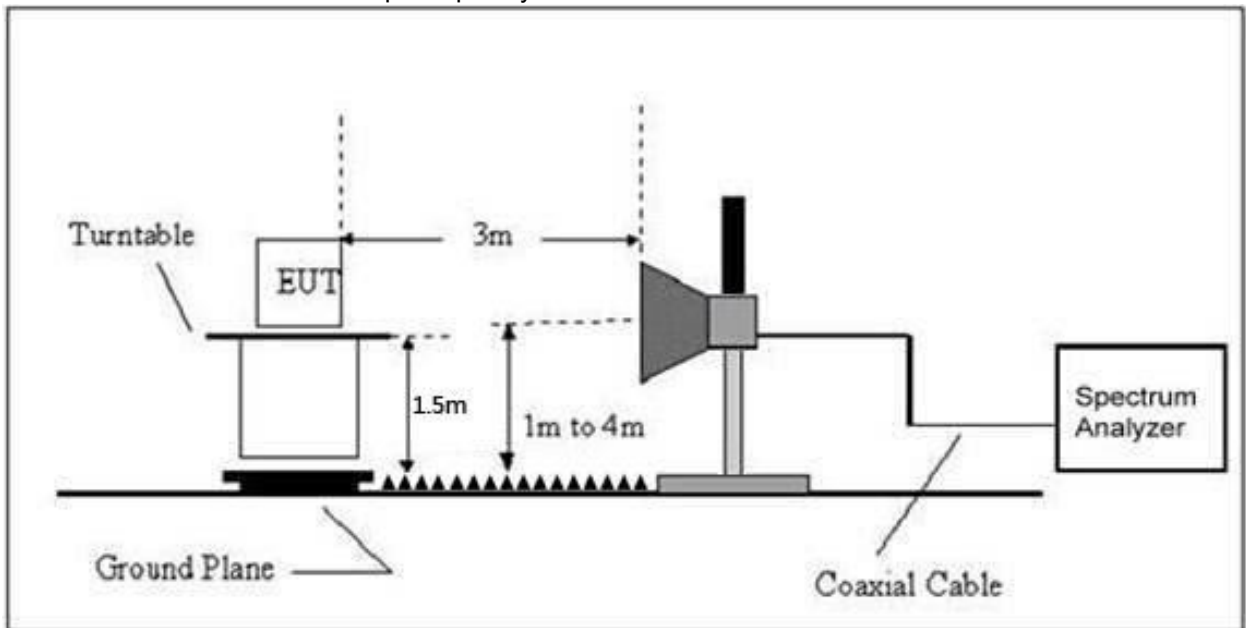

6.2 Limit

According to §22.913(a)(2), The ERP of mobile and portable stations transmitters and auxiliary test transmitters must not exceed 7 Watts.

According to §24.232 (c), Mobile and portable stations are limited to 2 watts EIRP and the equipment must employ a means for limiting power to the minimum necessary for successful communications.

According to §27.50(d)(4), Fixed, mobile, and portable (hand-held) stations operating in the 1710-1755 MHz band and mobile and portable stations operating in the 1695-1710 MHz and 1755-1780 MHz bands are limited to 1 watt EIRP.

6.3 Test procedure

Radiated power test method:

1. The setup of EUT is according with per ANSI/TIA Standard 603D and ANSI C63.4-2014 measurement procedure.
2. The measurement antenna was placed at a distance of 3 meters from the EUT. During the tests, the antenna height and polarization as well as EUT azimuth were varied in order to identify the maximum level of emissions from the EUT. The test was performed by placing the EUT on 3-orthogonal axis.
3. The frequency range up to tenth harmonic of the fundamental frequency was investigated.
4. Remove the EUT and replace it with substitution antenna. A signal generator was connected to the substitution antenna by a non-radiating cable. The absolute levels of the spurious emissions were measured by the substitution.

6.4 Test Result

ERP For GSM Mode GSM850

Frequency (MHz)	Polar (H/V)	Height (Meter)	Table (Degree)	Reading Level (dBm)	Correct Factor (dB)	Measurement (dBm)	FCC Part 22H Limits (dBm)	Result
Low Channel								
824.2	H	1.5	0	55.88	-26.29	29.59	38.45	PASS
824.2	V	1.5	0	55.26	-26.29	28.97	38.45	PASS
Middle Channel								
836.6	H	1.5	0	55.58	-26.35	29.23	38.45	PASS
836.6	V	1.5	0	54.98	-26.35	28.63	38.45	PASS
High Channel								
848.8	H	1.5	0	55.66	-26.42	29.24	38.45	PASS
848.8	V	1.5	0	55.89	-26.42	29.47	38.45	PASS

EIRP For GSM Mode PCS1900

Frequency (MHz)	Polar (H/V)	Height (Meter)	Table (Degree)	Reading Level (dBm)	Correct Factor (dB)	Measurement (dBm)	FCC Part 24E Limits (dBm)	Result
Low Channel								
1850.2	H	1.5	0	55.43	-26.93	28.50	33.00	PASS
1850.2	V	1.5	0	55.52	-26.93	28.59	33.00	PASS
Middle Channel								
1880	H	1.5	0	55.48	-26.86	28.62	33.00	PASS
1880	V	1.5	0	55.84	-26.86	28.98	33.00	PASS
High Channel								
1909.8	H	1.5	0	55.62	-26.80	28.82	33.00	PASS
1909.8	V	1.5	0	55.81	-26.80	29.01	33.00	PASS

ERP For GPRS Mode GSM850

Frequency (MHz)	Polar (H/V)	Height (Meter)	Table (Degree)	Reading Level (dBm)	Correct Factor (dB)	Measurement (dBm)	FCC Part 22H Limits (dBm)	Result
Low Channel								
824.2	H	1.5	0	56.84	-26.29	30.55	38.45	PASS
824.2	V	1.5	0	55.80	-26.29	29.51	38.45	PASS
Middle Channel								
836.6	H	1.5	0	55.65	-26.35	29.30	38.45	PASS
836.6	V	1.5	0	55.27	-26.35	28.92	38.45	PASS
High Channel								
848.8	H	1.5	0	55.96	-26.42	29.54	38.45	PASS
848.8	V	1.5	0	55.35	-26.42	28.93	38.45	PASS

EIRP For GPRS Mode PCS1900

Frequency (MHz)	Polar (H/V)	Height (Meter)	Table (Degree)	Reading Level (dBm)	Correct Factor (dB)	Measurement (dBm)	FCC Part 24E Limits (dBm)	Result
Low Channel								
1850.2	H	1.5	0	55.32	-26.93	28.39	33.00	PASS
1850.2	V	1.5	0	55.83	-26.93	28.90	33.00	PASS
Middle Channel								
1880	H	1.5	0	55.16	-26.86	28.30	33.00	PASS
1880	V	1.5	0	55.20	-26.86	28.34	33.00	PASS
High Channel								
1909.8	H	1.5	0	56.04	-26.80	29.24	33.00	PASS
1909.8	V	1.5	0	55.78	-26.80	28.98	33.00	PASS

EIRP For WCDMA Mode Band II

Frequency (MHz)	Polar (H/V)	Height (Meter)	Table (Degree)	Reading Level (dBm)	Correct Factor (dB)	Measurement (dBm)	FCC Part 24E Limits (dBm)	Result
Low Channel								
1852.4	H	1.5	0	49.19	-26.92	22.27	33.00	PASS
1852.4	V	1.5	0	48.65	-26.92	21.73	33.00	PASS
Middle Channel								
1880	H	1.5	0	49.90	-26.86	23.04	33.00	PASS
1880	V	1.5	0	48.32	-26.86	21.46	33.00	PASS
High Channel								
1907.6	H	1.5	0	49.23	-26.80	22.43	33.00	PASS
1907.6	V	1.5	0	48.35	-26.80	21.55	33.00	PASS

EIRP For HSDPA Mode Band II

Frequency (MHz)	Polar (H/V)	Height (Meter)	Table (Degree)	Reading Level (dBm)	Correct Factor (dB)	Measurement (dBm)	FCC Part 24E Limits (dBm)	Result
Low Channel								
1852.4	H	1.5	0	49.77	-26.92	22.85	33.00	PASS
1852.4	V	1.5	0	48.42	-26.92	21.50	33.00	PASS
Middle Channel								
1880	H	1.5	0	48.98	-26.86	22.12	33.00	PASS
1880	V	1.5	0	48.17	-26.86	21.31	33.00	PASS
High Channel								
1907.6	H	1.5	0	49.71	-26.80	22.91	33.00	PASS
1907.6	V	1.5	0	48.76	-26.80	21.96	33.00	PASS

EIRP For HSUPA Mode Band II

Frequency (MHz)	Polar (H/V)	Height (Meter)	Table (Degree)	Reading Level (dBm)	Correct Factor (dB)	Measurement (dBm)	FCC Part 24E Limits (dBm)	Result
Low Channel								
1852.4	H	1.5	0	49.04	-26.92	22.12	33.00	PASS
1852.4	V	1.5	0	48.53	-26.92	21.61	33.00	PASS
Middle Channel								
1880	H	1.5	0	49.27	-26.86	22.41	33.00	PASS
1880	V	1.5	0	48.64	-26.86	21.78	33.00	PASS
High Channel								
1907.6	H	1.5	0	49.37	-26.80	22.57	33.00	PASS
1907.6	V	1.5	0	48.81	-26.80	22.01	33.00	PASS

ERP For WCDMA Mode Band V

Frequency (MHz)	Polar (H/V)	Height (Meter)	Table (Degree)	Reading Level (dBm)	Correct Factor (dB)	Measurement (dBm)	FCC Part 22H Limits (dBm)	Result
Low Channel								
826.4	H	1.5	0	48.71	-26.29	22.42	30	PASS
826.4	V	1.5	0	48.42	-26.29	22.13	30	PASS
Middle Channel								
836.4	H	1.5	0	50.08	-26.35	23.73	30	PASS
836.4	V	1.5	0	48.57	-26.35	22.22	30	PASS
High Channel								
846.6	H	1.5	0	48.26	-26.42	21.84	30	PASS
846.6	V	1.5	0	48.35	-26.42	21.93	30	PASS

ERP For HSDPA Mode Band V

Frequency (MHz)	Polar (H/V)	Height (Meter)	Table (Degree)	Reading Level (dBm)	Correct Factor (dB)	Measurement (dBm)	FCC Part 22H Limits (dBm)	Result
Low Channel								
826.4	H	1.5	0	49.54	-26.29	23.25	30	PASS
826.4	V	1.5	0	48.48	-26.29	22.19	30	PASS
Middle Channel								
836.4	H	1.5	0	48.32	-26.35	21.97	30	PASS
836.4	V	1.5	0	48.14	-26.35	21.79	30	PASS
High Channel								
846.6	H	1.5	0	48.19	-26.42	21.77	30	PASS
846.6	V	1.5	0	49.12	-26.42	22.70	30	PASS

ERP For HSUPA Mode Band V

Frequency (MHz)	Polar (H/V)	Height (Meter)	Table (Degree)	Reading Level (dBm)	Correct Factor (dB)	Measurement (dBm)	FCC Part 22H Limits (dBm)	Result
Low Channel								
826.4	H	1.5	0	49.71	-26.29	23.42	30	PASS
826.4	V	1.5	0	48.32	-26.29	22.03	30	PASS
Middle Channel								
836.4	H	1.5	0	48.20	-26.35	21.85	30	PASS
836.4	V	1.5	0	48.79	-26.35	22.44	30	PASS
High Channel								
846.6	H	1.5	0	48.46	-26.42	22.04	30	PASS
846.6	V	1.5	0	48.54	-26.42	22.12	30	PASS

Correction Factor= S.G. Power - Cable loss + Antenna Gain- SPA. Reading

Max. Conducted Output Power

For Cellular Band (GSM850)

Band	GSM850			Limit (dBm)
Channel	128	190	251	
Frequency(MHz)	824.2	836.6	848.8	
GSM	32.58	32.87	32.64	33.0
GPRS Slot -1	32.49	32.75	32.5	33.0
GPRS Slot -2	30.26	30.67	30.5	33.0
GPRS Slot -3	28.36	28.84	28.66	33.0
GPRS Slot -4	26.4	26.91	26.69	33.0

For PCS Band (GSM1900)

Band	GSM1900			Limit (dBm)
Channel	512	661	810	
Frequency(MHz)	1850.2	1880	1909.8	
GSM	29.25	29.33	29.17	33.0
GPRS Slot -1	29.1	29.23	29.08	33.0
GPRS Slot -2	26.74	27.08	27.03	33.0
GPRS Slot -3	25.17	25.51	25.47	33.0
GPRS Slot -4	23.03	23.37	23.33	33.0

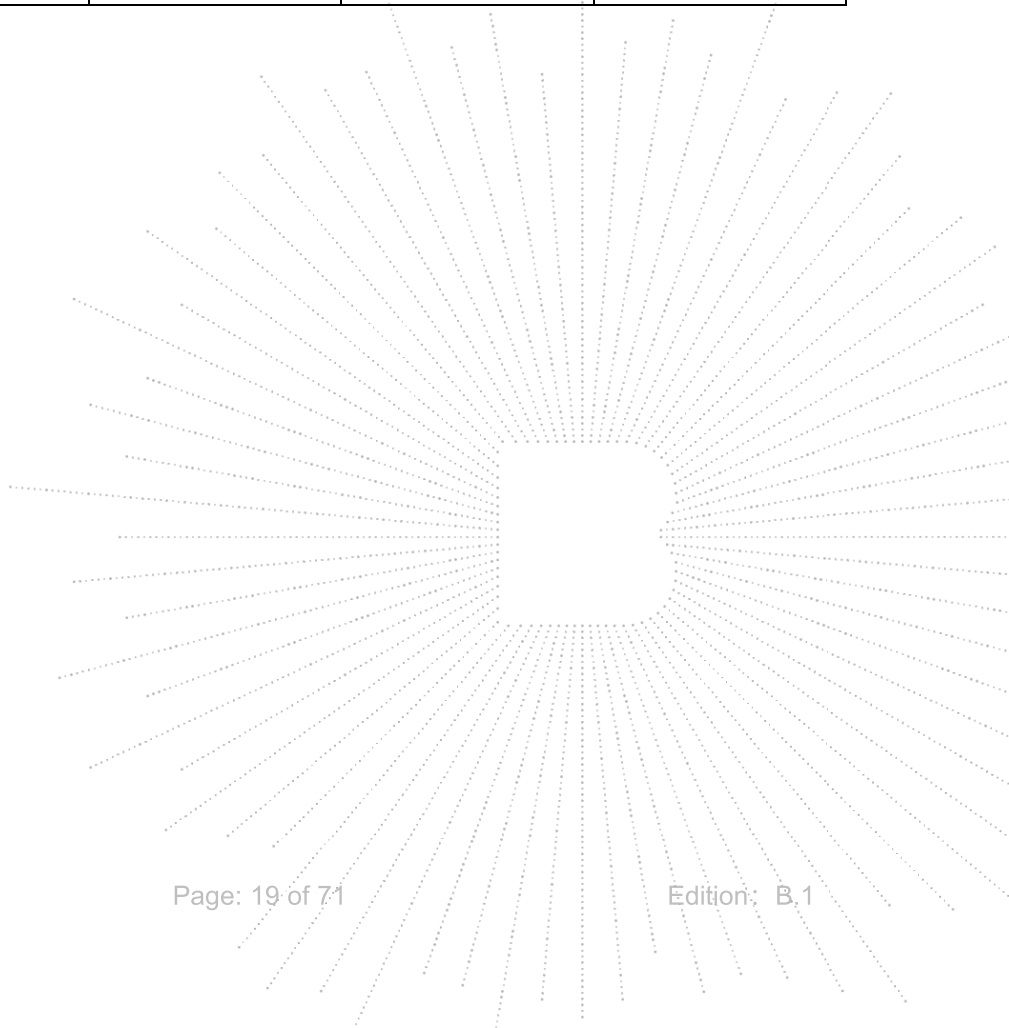

Band	WCDMA Band II		
Channel	9262	9400	9538
Frequency(MHz)	1852.4	1880.0	1907.6
WCDMA RMC 12.2K	21.72	21.63	21.52
HSDPA Subtest-1	21.27	20.97	20.75
HSDPA Subtest-2	20.98	20.69	20.42
HSDPA Subtest-3	20.6	20.57	20.22
HSDPA Subtest-4	20.45	20.1	19.96
HSUPA Subtest-1	21.15	20.91	20.72
HSUPA Subtest-2	21.17	21.01	20.70
HSUPA Subtest-3	20.99	20.90	20.29
HSUPA Subtest-4	21.02	20.98	20.65
HSUPA Subtest-5	20.94	20.82	20.48

Band	WCDMA Band V		
Channel	4132	4182	4233
Frequency(MHz)	826.4	836.4	846.6
WCDMA RMC 12.2K	22.42	22.27	22.16
HSDPA Subtest-1	22.21	22.06	22.31
HSDPA Subtest-2	21.86	21.76	22.04
HSDPA Subtest-3	21.71	21.66	21.69
HSDPA Subtest-4	21.30	21.47	21.68
HSUPA Subtest-1	22.17	21.95	22.21
HSUPA Subtest-2	22.10	22.03	22.32
HSUPA Subtest-3	21.65	21.96	22.21
HSUPA Subtest-4	22.07	22.01	22.28
HSUPA Subtest-5	22.01	21.81	22.19

7. Peak-to-average Ratio(PAR) of Transmitter

7.1 Block Diagram Of Test Setup

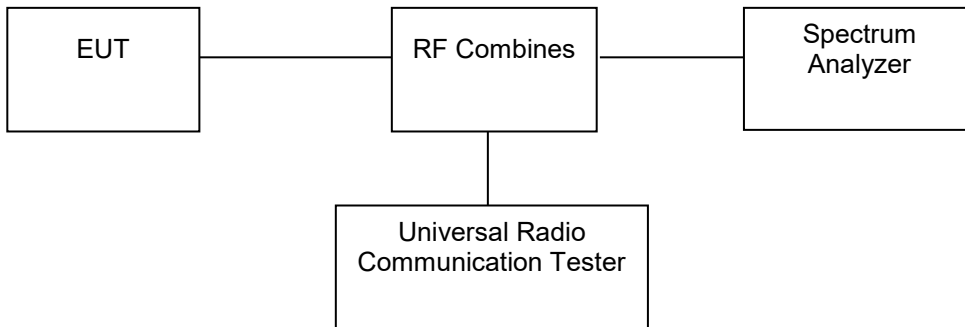

7.2 Limit

According to §24.232(d), Power measurements for transmissions by stations authorized under this section may be made either in accordance with a Commission-approved average power technique or in compliance with paragraph (e) of this section. In both instances, equipment employed must be authorized in accordance with the provisions of §24.51. In measuring transmissions in this band using an average power technique, the peak-to-average ratio (PAR) of the transmission may not exceed 13 dB.

According to §27.50(B), the peak-to-average power ratio (PAPR) of the transmitter output power must not exceed 13 dB. The PAPR measurements should be made using either an instrument with complementary cumulative distribution function (CCDF) capabilities to determine that PAPR will not exceed 13 dB for more than 0.1 percent of the time or other Commission approved procedure. The measurement must be performed using a signal corresponding to the highest PAPR expected during periods of continuous transmission.

7.3 Test procedure

The RF output terminal of the transmitter was connected to the input of the spectrum analyzer via a suitable attenuation. The RBW of the spectrum analyzer was set to 30kHz and the peak-to-average ratio (PAR) of the transmission was recorded. Record the maximum PAPR level associated with a probability of 0.1%.

7.4 Test Result

Band	Channel	Frequency (MHz)	Result (dB)	high Limit (dB)	Verdict
GSM850	128	824.2	2.62	13.00	PASS
GSM850	190	836.6	2.64	13.00	PASS
GSM850	251	848.8	2.62	13.00	PASS
GPRS850	128	824.2	2.62	13.00	PASS
GPRS850	190	836.6	2.65	13.00	PASS
GPRS850	251	848.8	2.63	13.00	PASS

GSM850 Channel=128

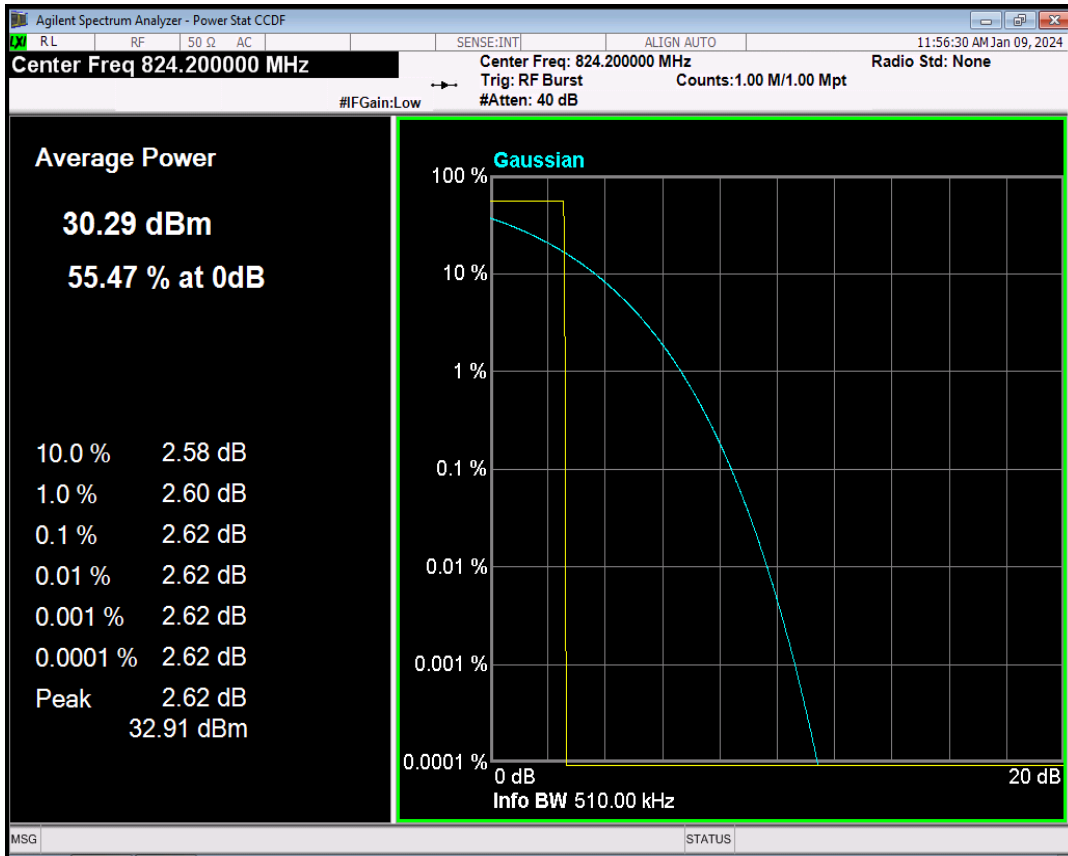

GSM850 Channel=190

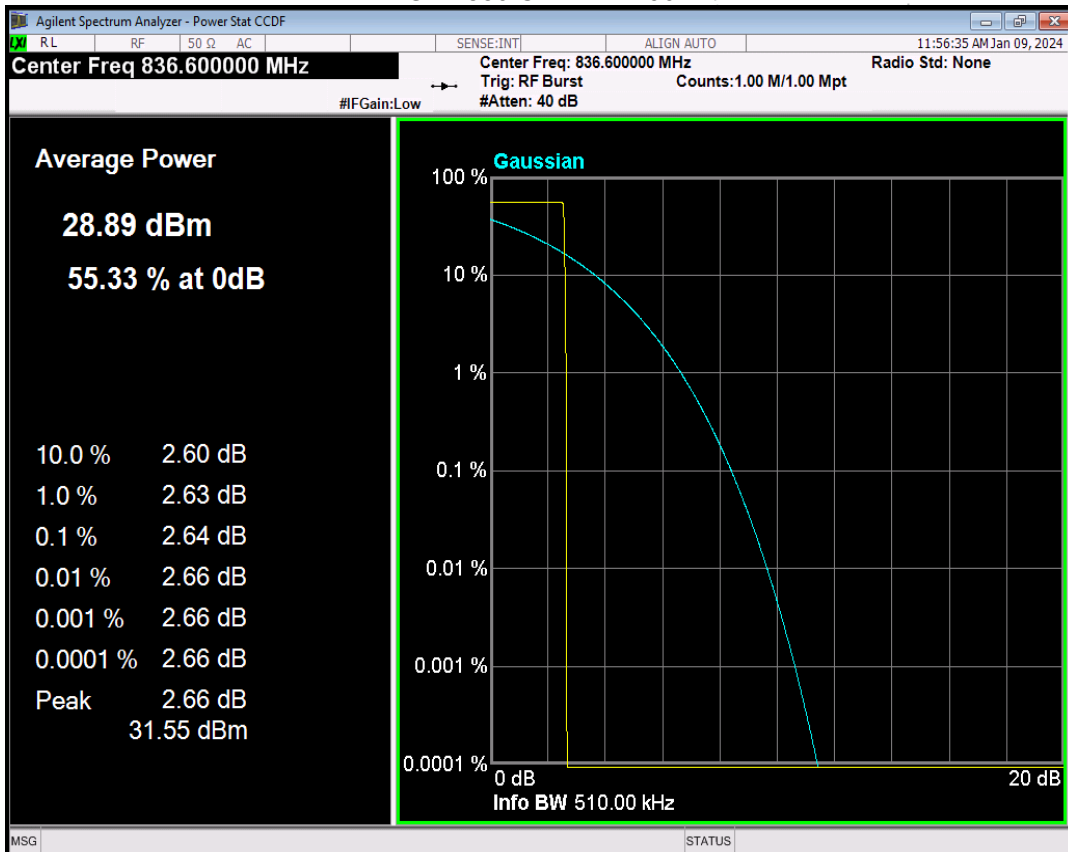

GSM850 Channel=251

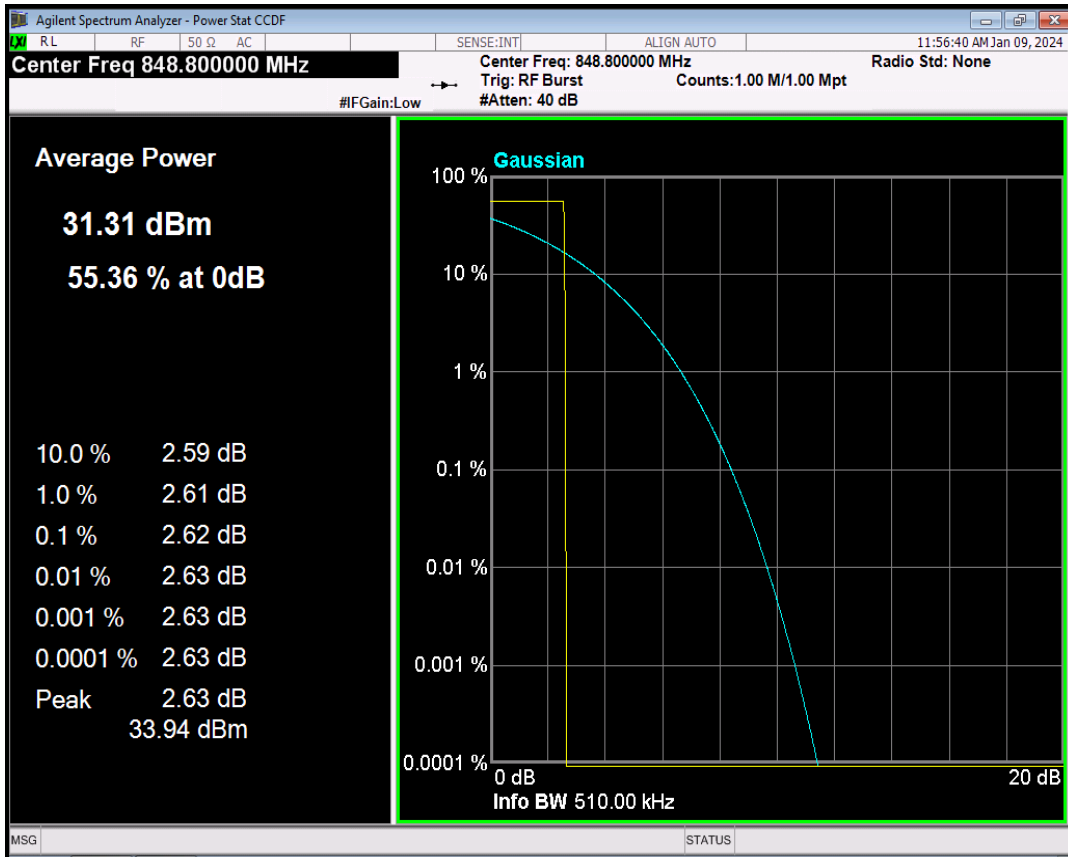

GPRS850 Channel=128

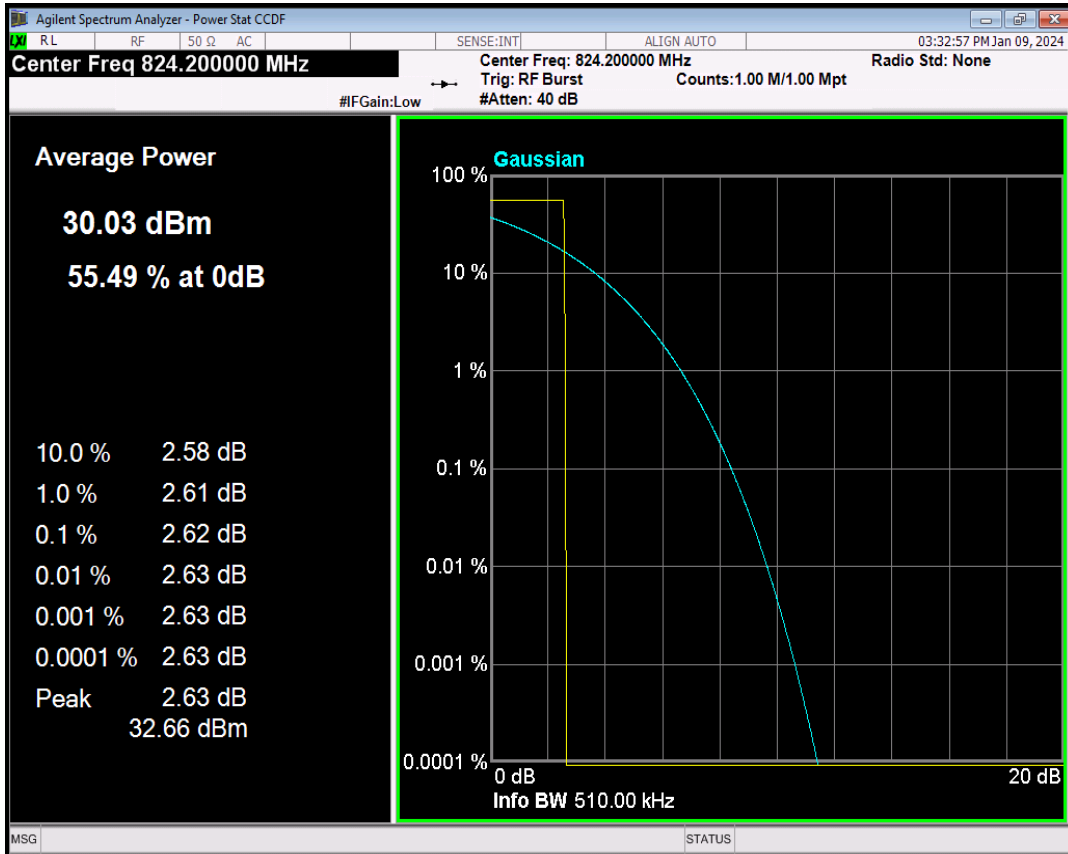

GPRS850 Channel=190

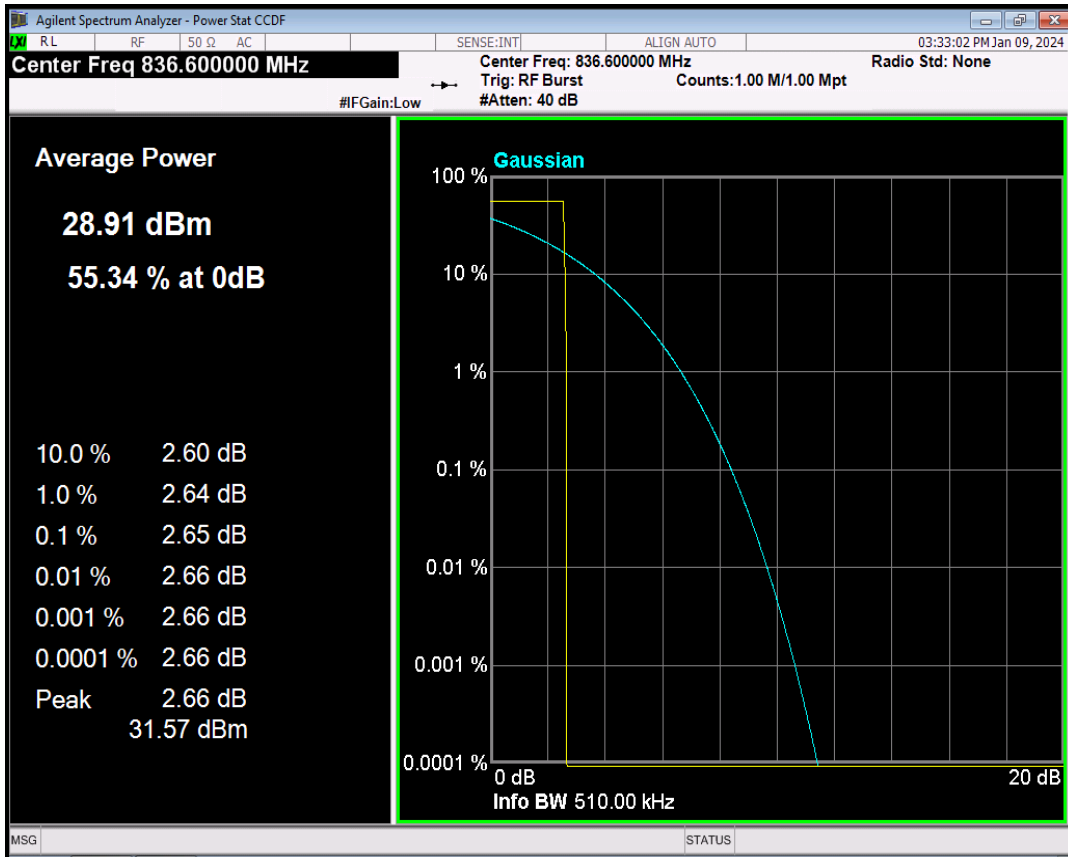

GPRS850 Channel=251

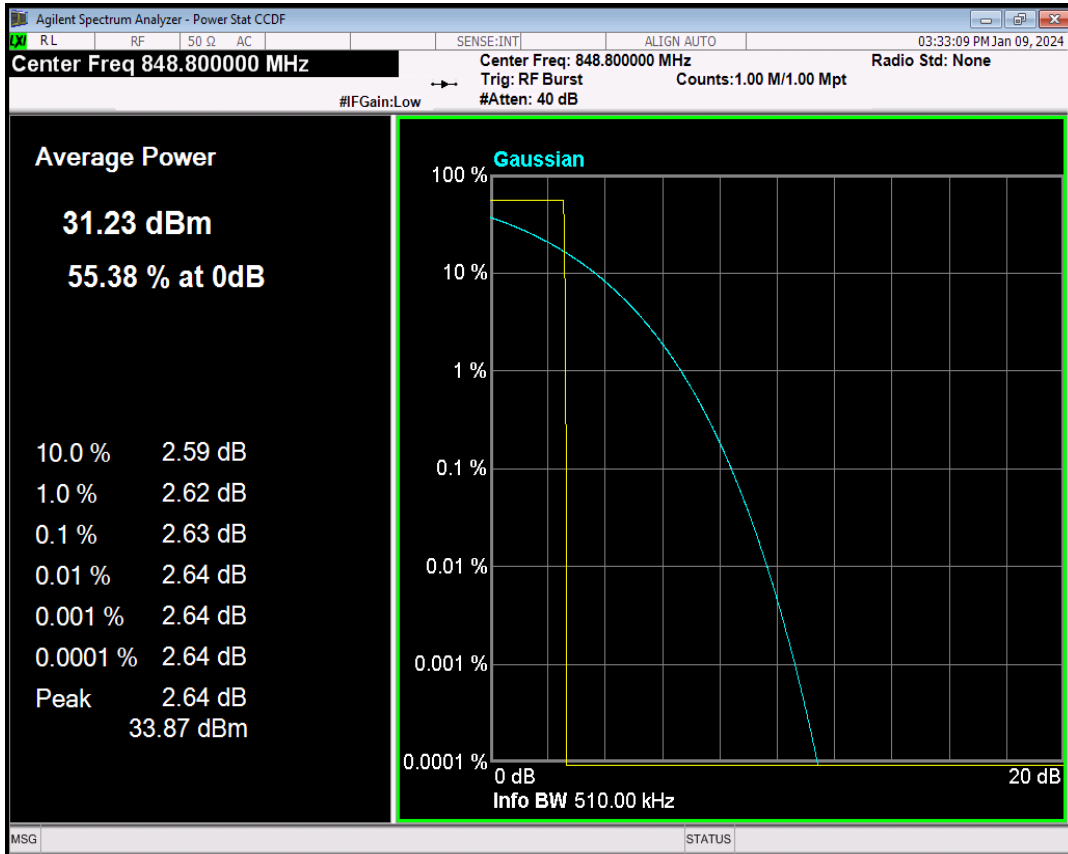

Band	Channel	Frequency (MHz)	Result (dB)	high Limit (dB)	Verdict
GSM1900	512	1850.2	2.64	13.00	PASS
GSM1900	661	1880	2.64	13.00	PASS
GSM1900	810	1909.8	2.62	13.00	PASS
GPRS1900	512	1850.2	2.68	13.00	PASS
GPRS1900	661	1880	2.68	13.00	PASS
GPRS1900	810	1909.8	2.66	13.00	PASS

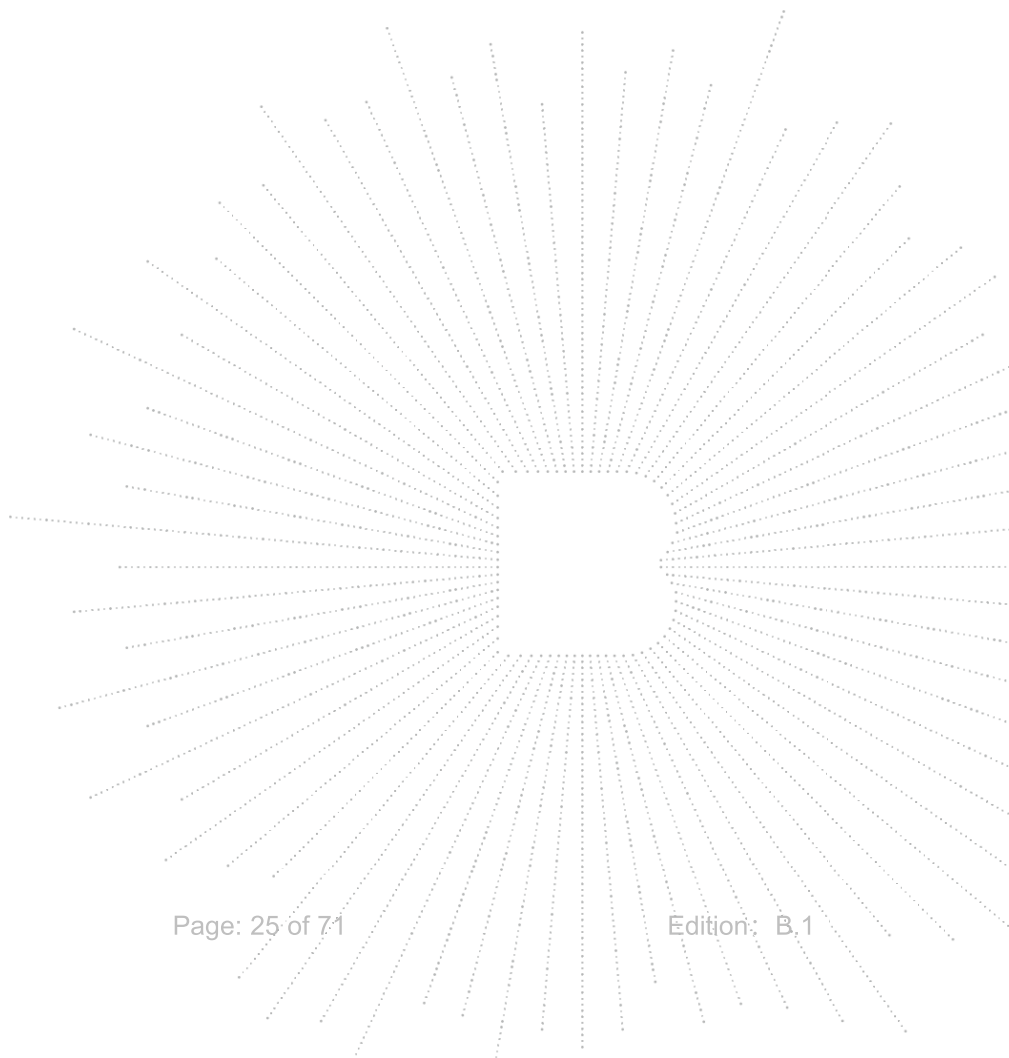

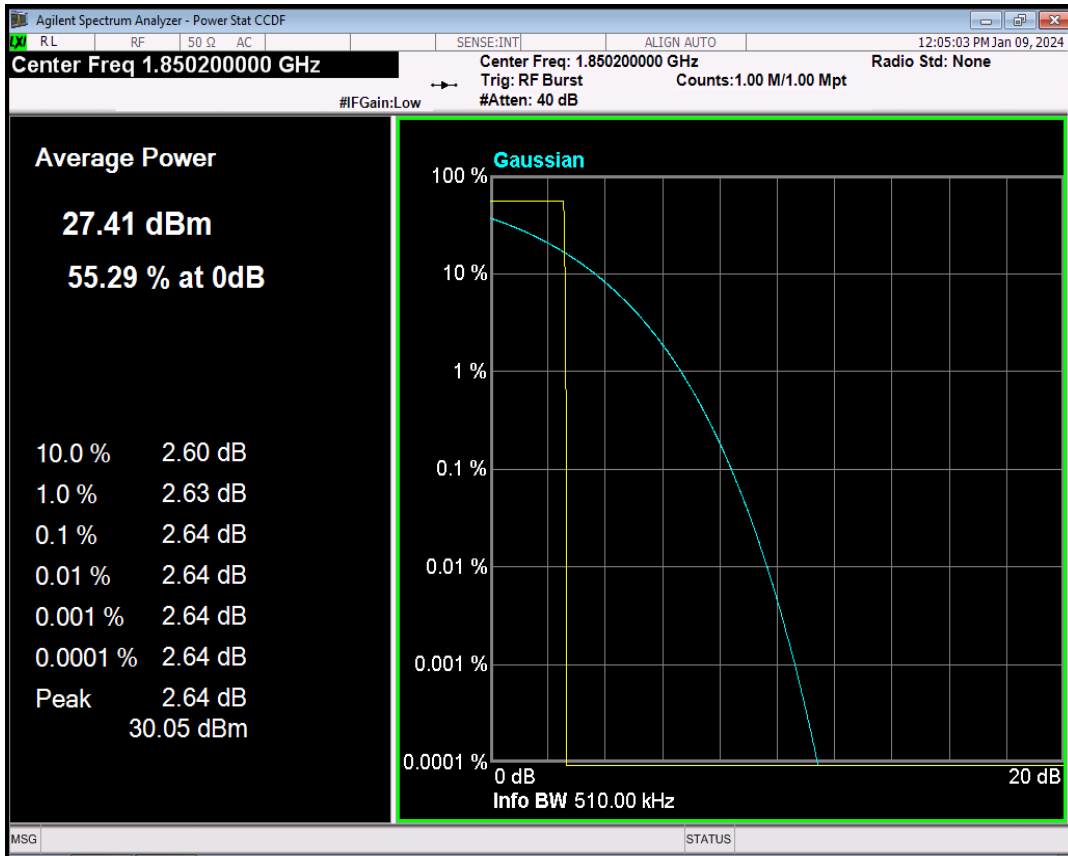
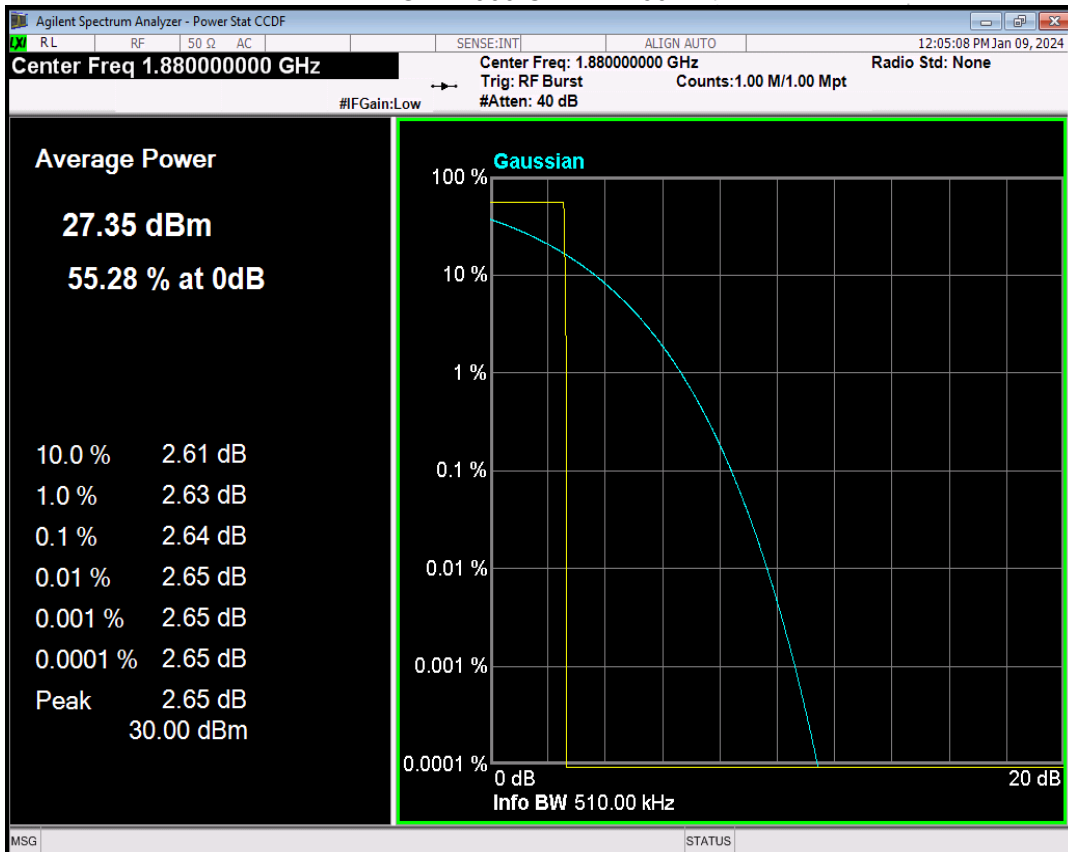
GSM1900 Channel=512

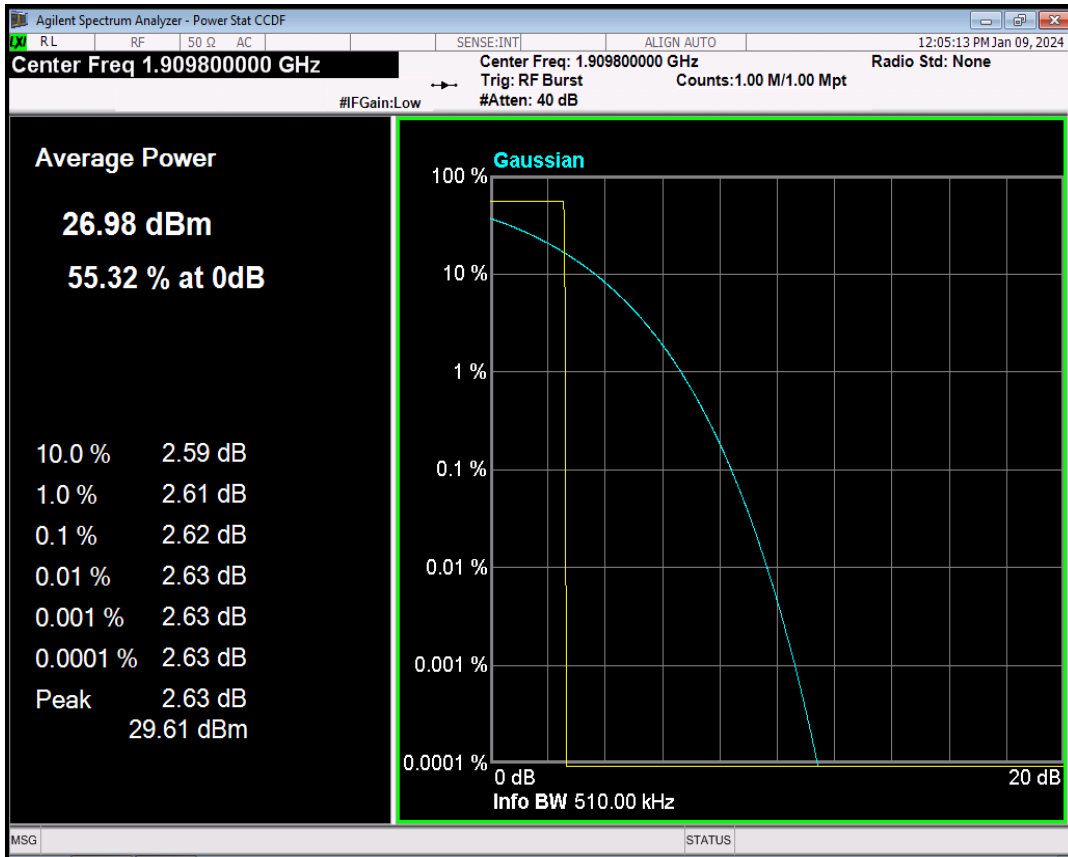
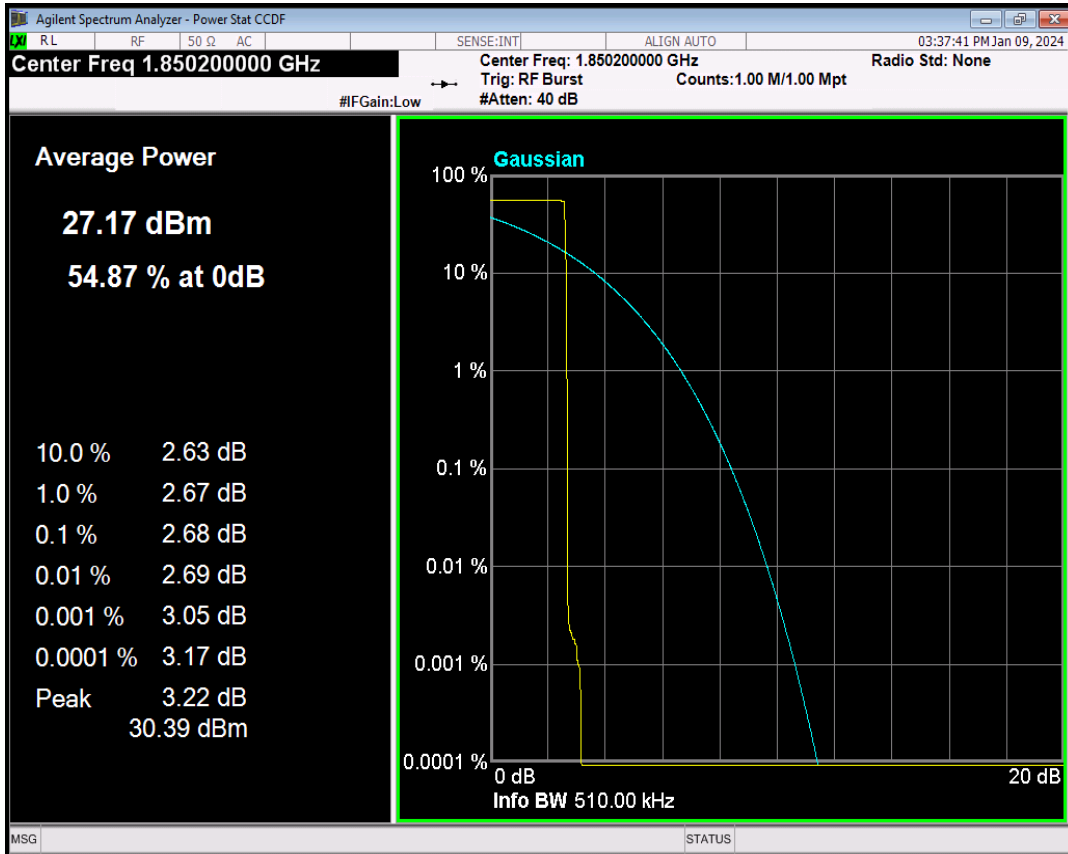
GSM1900 Channel=661

GSM1900 Channel=810

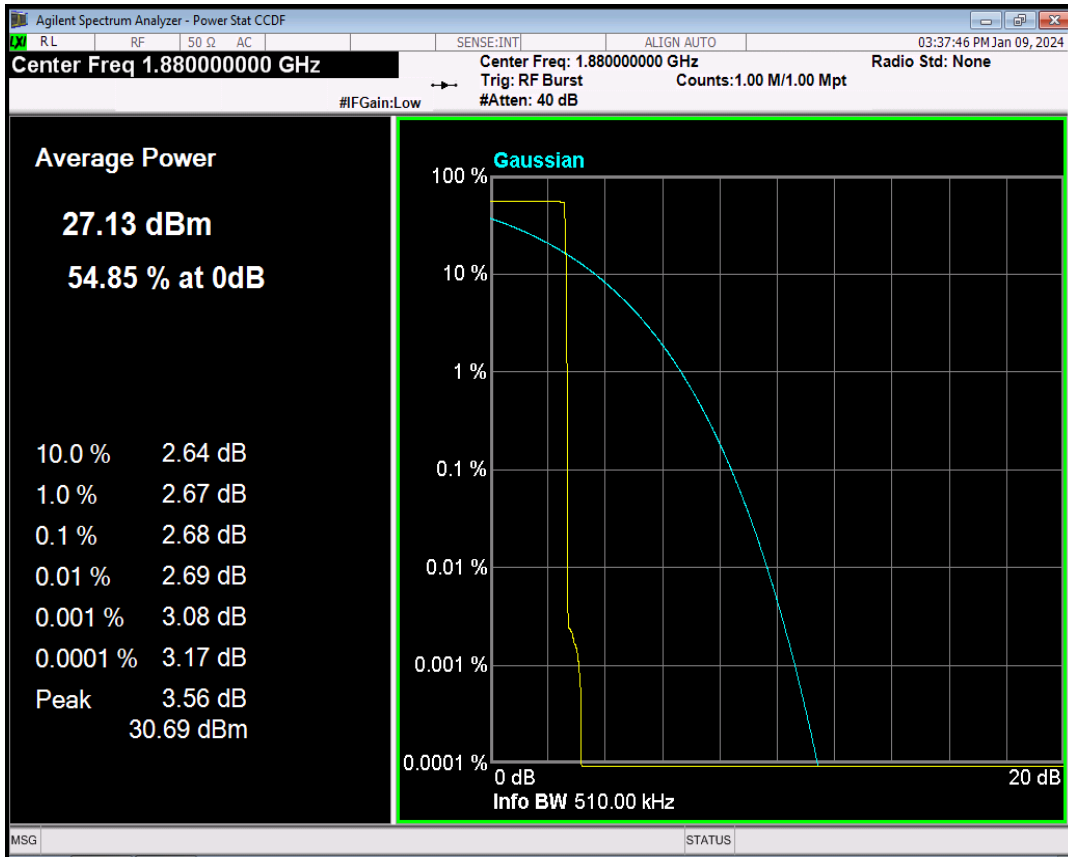
GPRS1900 Channel=512

GPRS1900 Channel=661

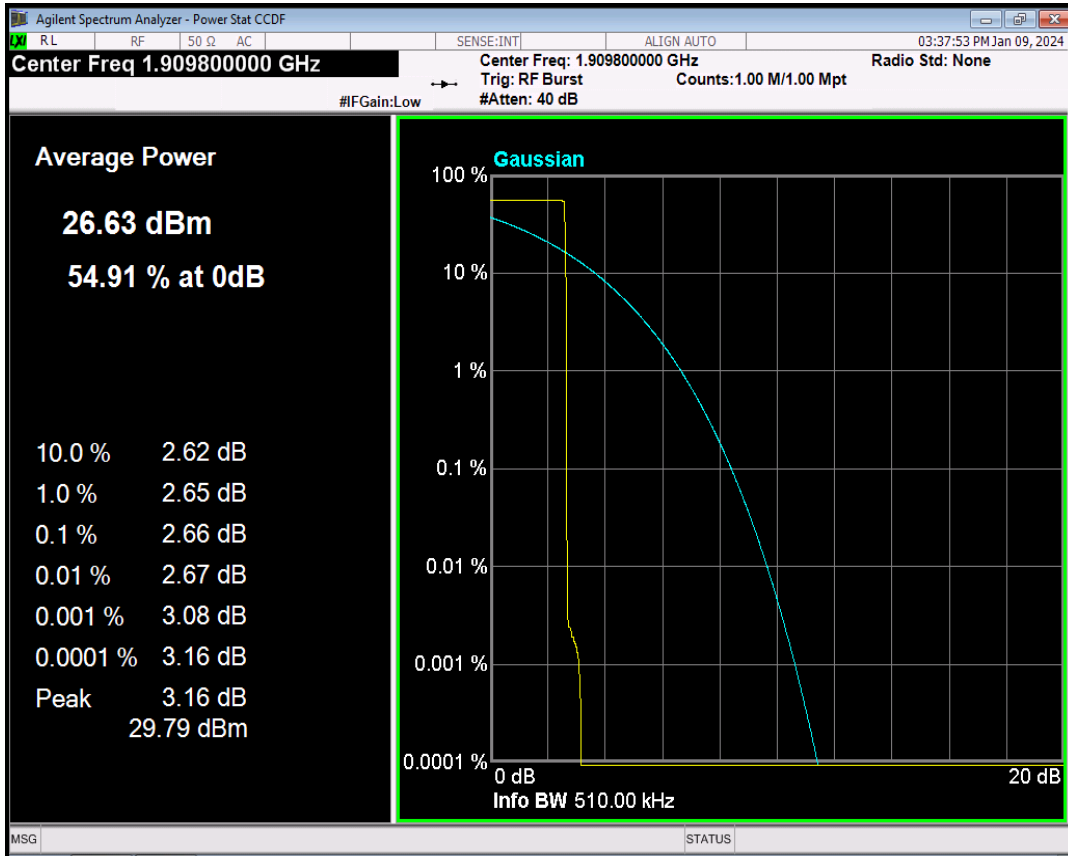

GPRS1900 Channel=810



Band	Channel	Frequency (MHz)	Result (dB)	high Limit (dB)	Verdict
WCDMA Band2	9262	1852.4	2.99	13	PASS
WCDMA Band2	9400	1880	3.00	13	PASS
WCDMA Band2	9538	1907.6	3.04	13	PASS
WCDMA Band5	4132	826.4	3.18	13	PASS
WCDMA Band5	4182	836.4	3.14	13	PASS
WCDMA Band5	4233	846.6	3.17	13	PASS

Note: In WCDMA, RMC, HSDPA and HSUPA all three tests only reflect the worst mode RMC.

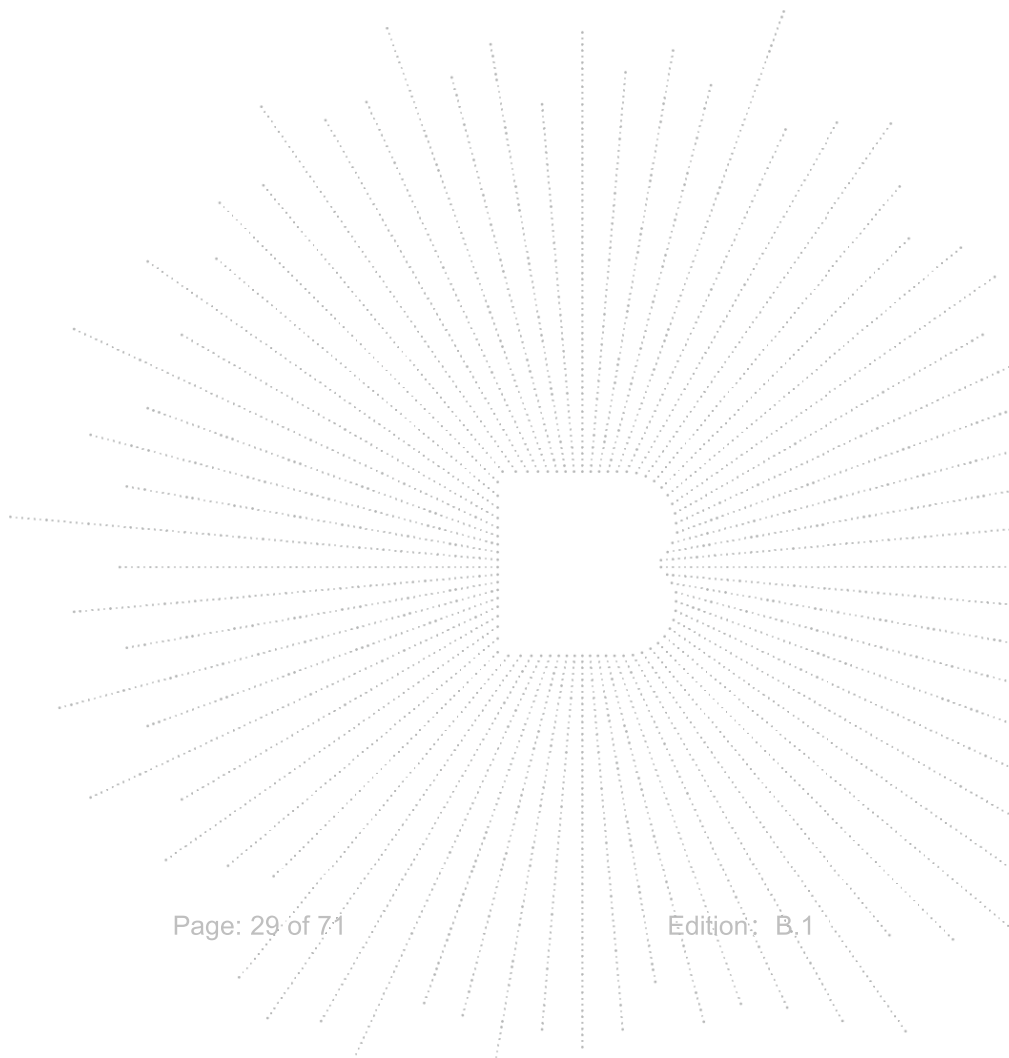

WCDMA Band2 Channel=9262

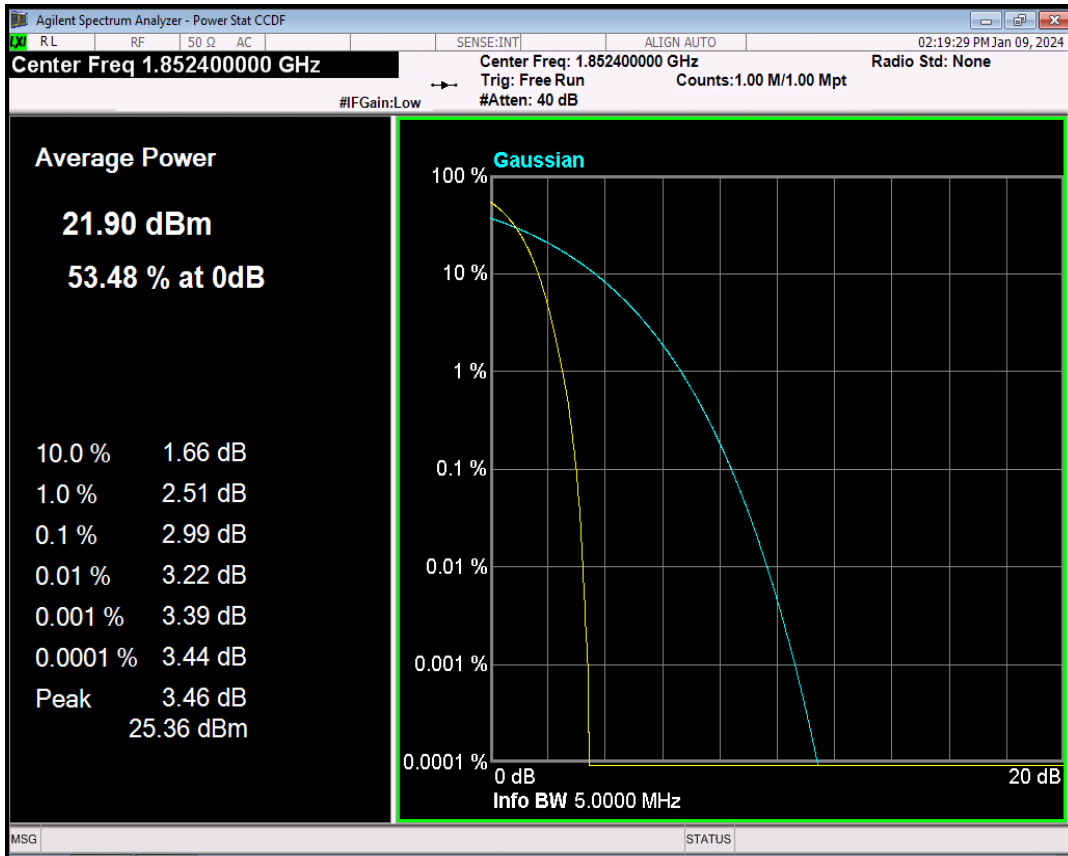

WCDMA Band2 Channel=9400

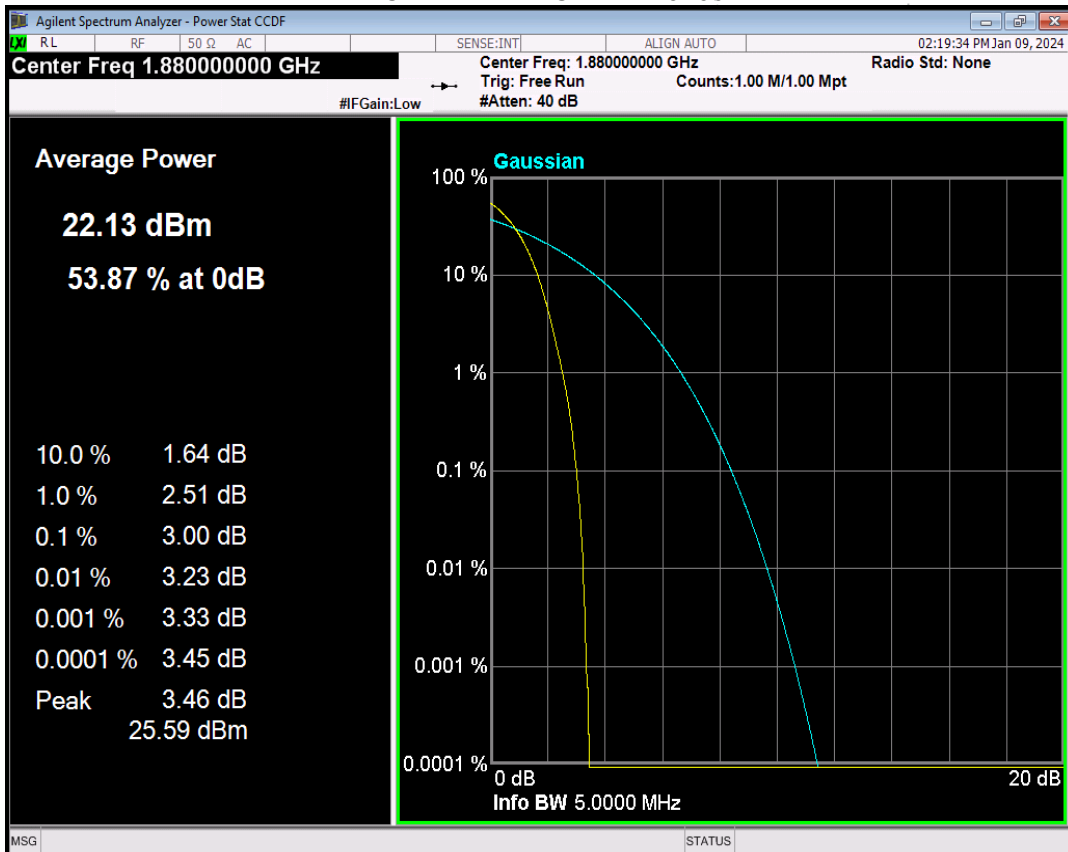

WCDMA Band2 Channel=9538

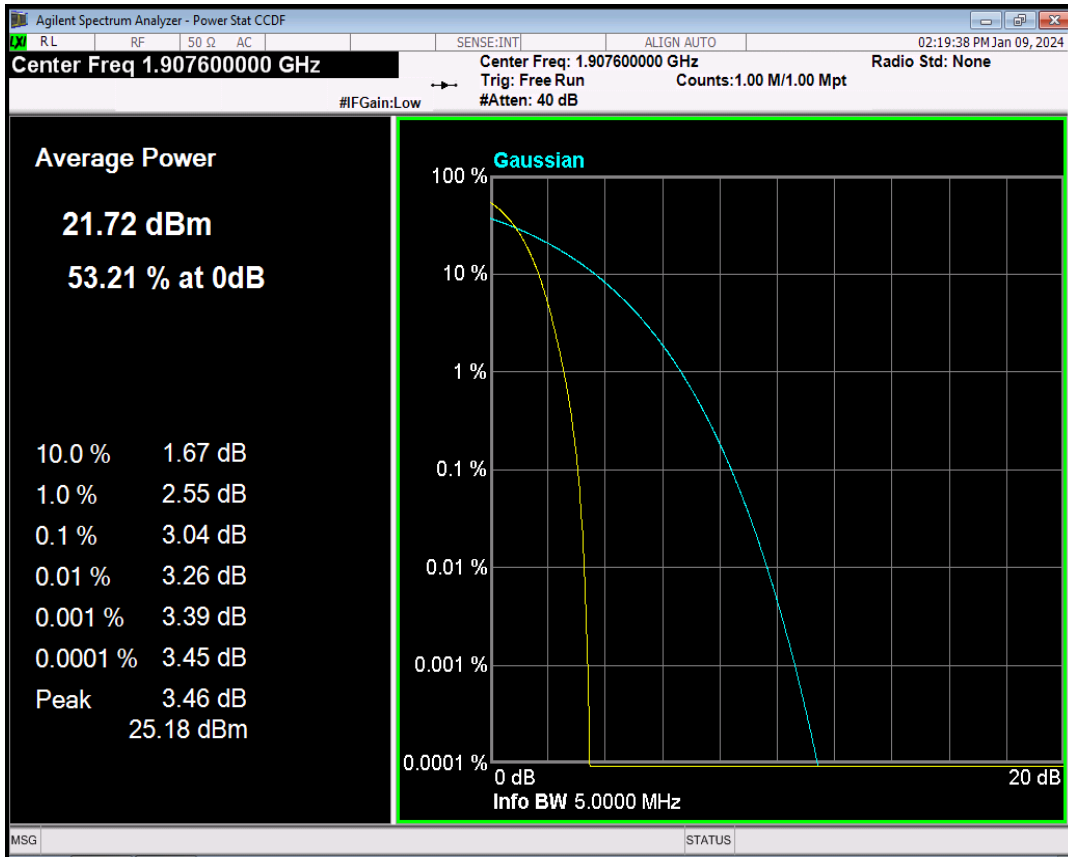

WCDMA Band5 Channel=4132

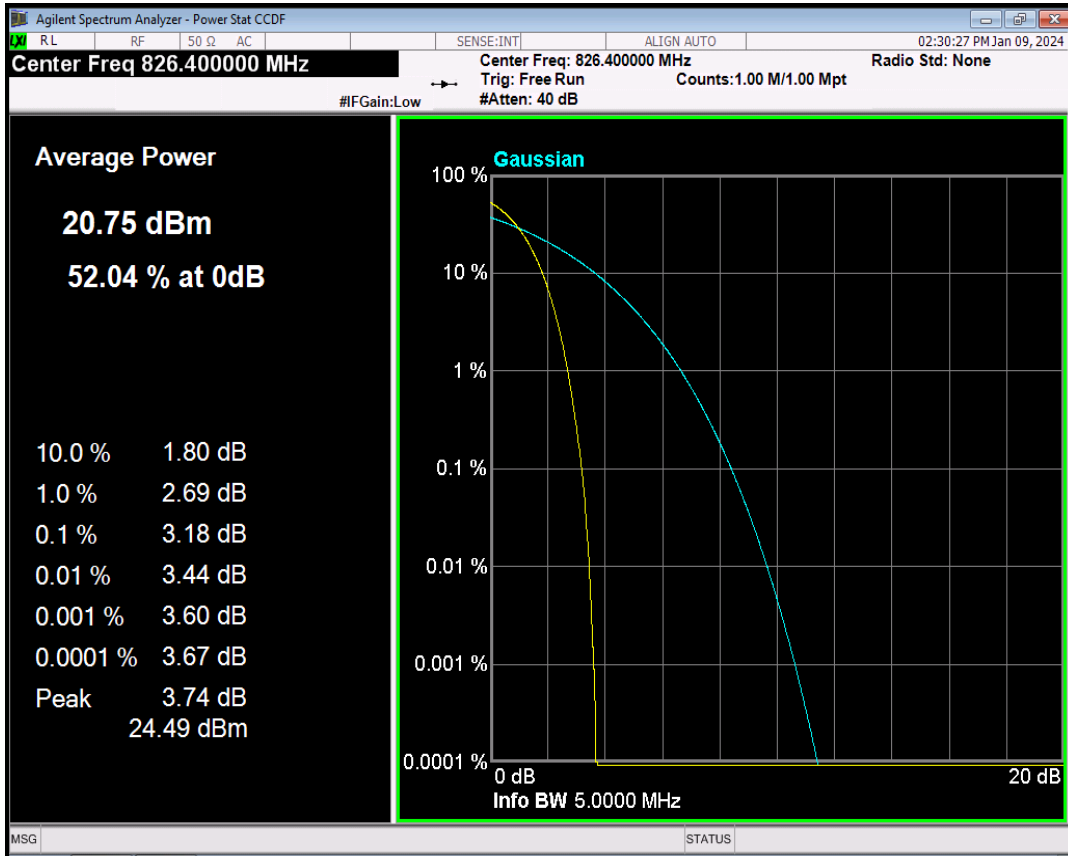

WCDMA Band5 Channel=4182

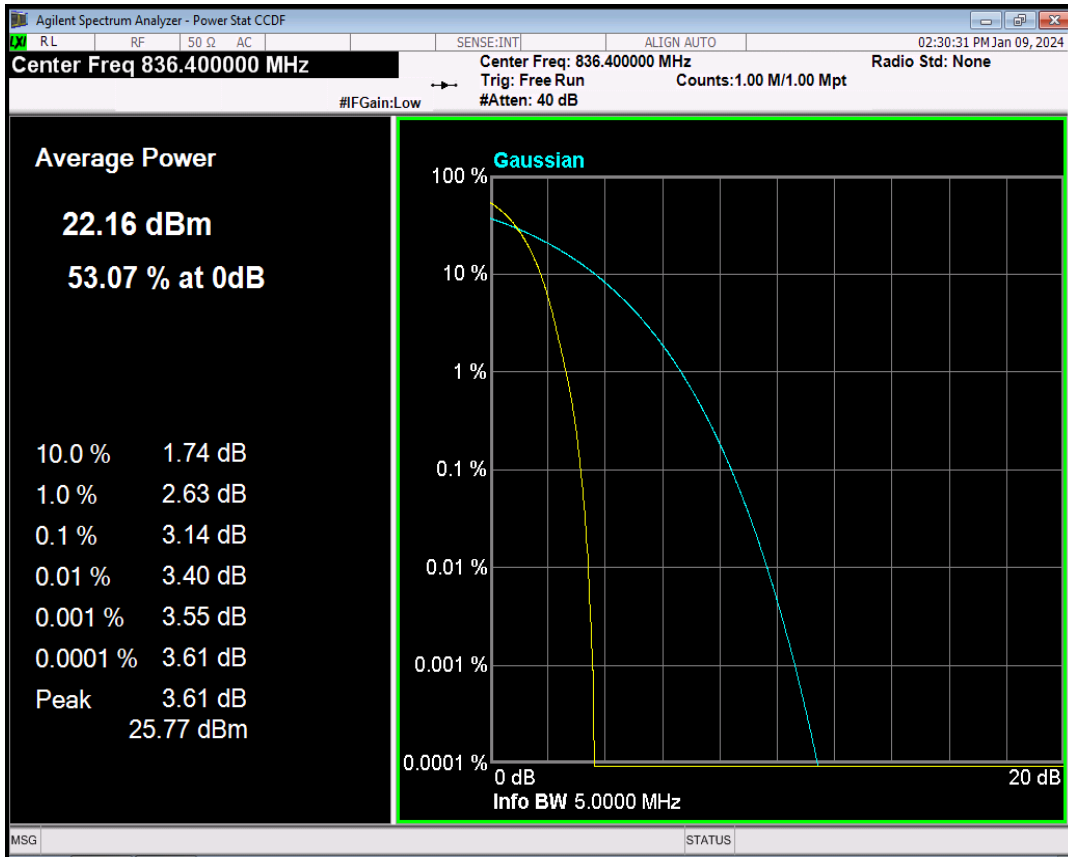

WCDMA Band5 Channel=4233

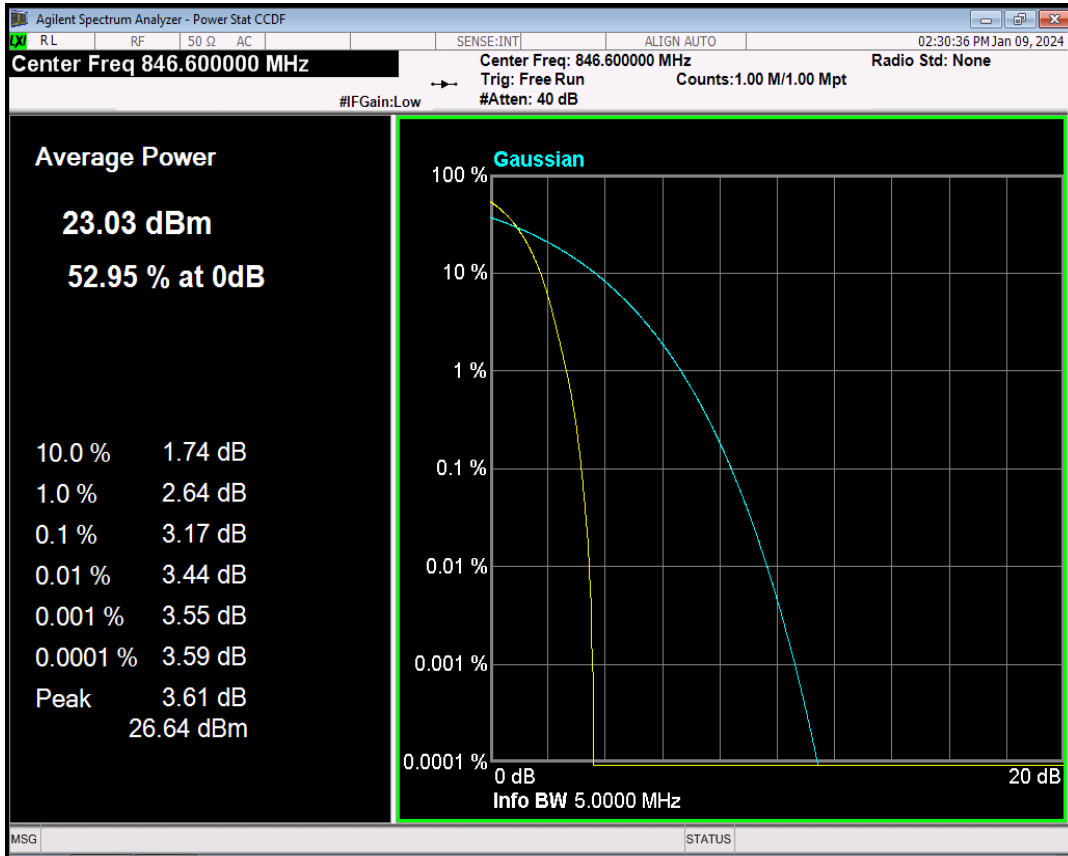

8. Emission Bandwidth

8.1 Block Diagram Of Test Setup

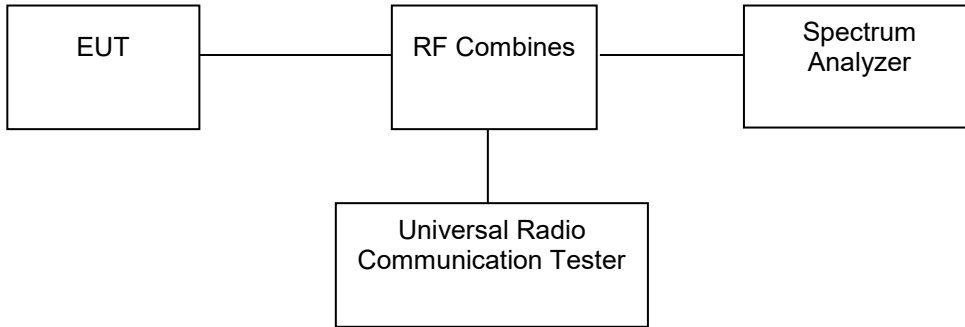

8.2 Limit

According to §22.917(b), The emission bandwidth is defined as the width of the signal between two points, one below the carrier center frequency and one above the carrier center frequency, outside of which all emissions are attenuated at least 26 dB below the transmitter power.

According to §24.238(b), The emission bandwidth is defined as the width of the signal between two points, one below the carrier center frequency and one above the carrier center frequency, outside of which all emissions are attenuated at least 26 dB below the transmitter power.

According to §27.53, The emission bandwidth is defined as the width of the signal between two points, one below the carrier center frequency and one above the carrier center frequency, outside of which all emissions are attenuated at least 26 dB below the transmitter power.

8.3 Test procedure

The RF output terminal of the transmitter was connected to the input of the spectrum analyzer via a suitable attenuation. The RBW of the spectrum analyzer was set to 10kHz for GSM mode and 100kHz for WCDMA mode, VBW shall be at least 3 times the RBW, and the 26dB bandwidth was recorded.

8.4 Test Result

Band	Channel	Frequency (MHz)	99% OBW (kHz)	-26dB EBW (kHz)	Verdict
GSM850	128	824.2	247.084	315.529	PASS
GSM850	190	836.6	239.326	301.826	PASS
GSM850	251	848.8	238.910	304.328	PASS
GPRS850	128	824.2	248.233	322.314	PASS
GPRS850	190	836.6	248.702	315.640	PASS
GPRS850	251	848.8	249.227	319.773	PASS

GSM850 Channel=128

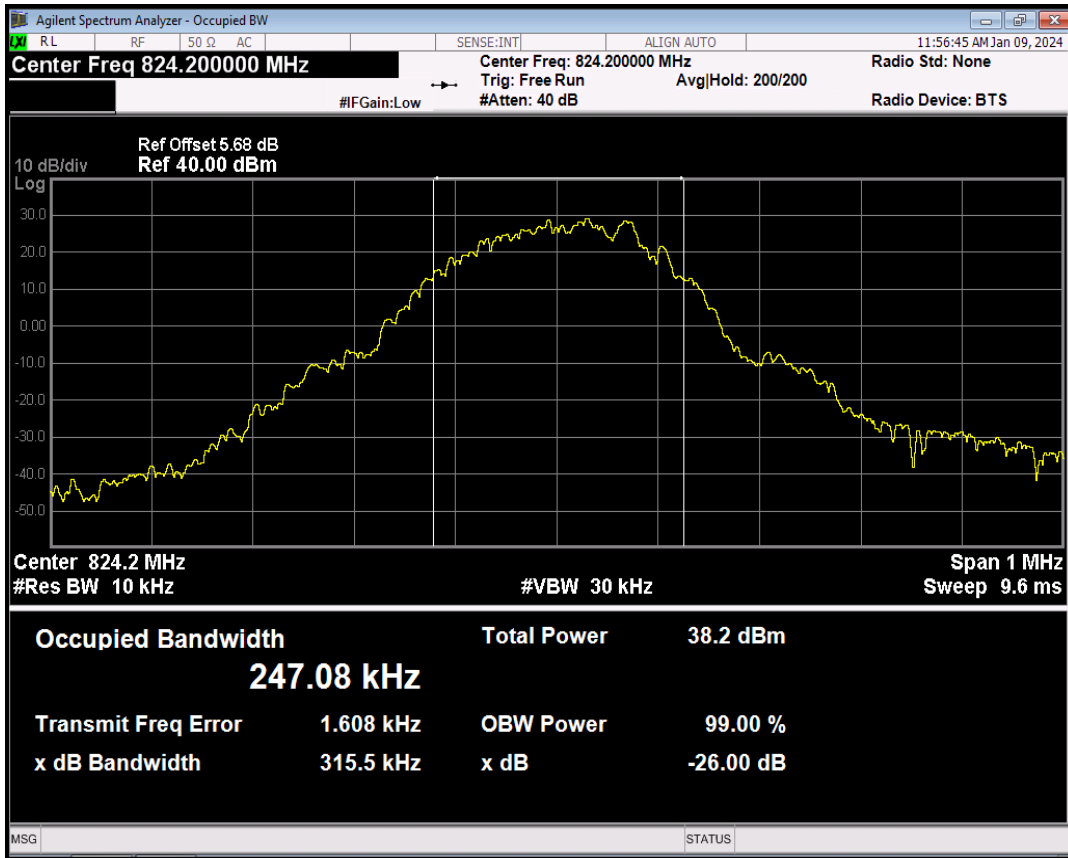

GSM850 Channel=190

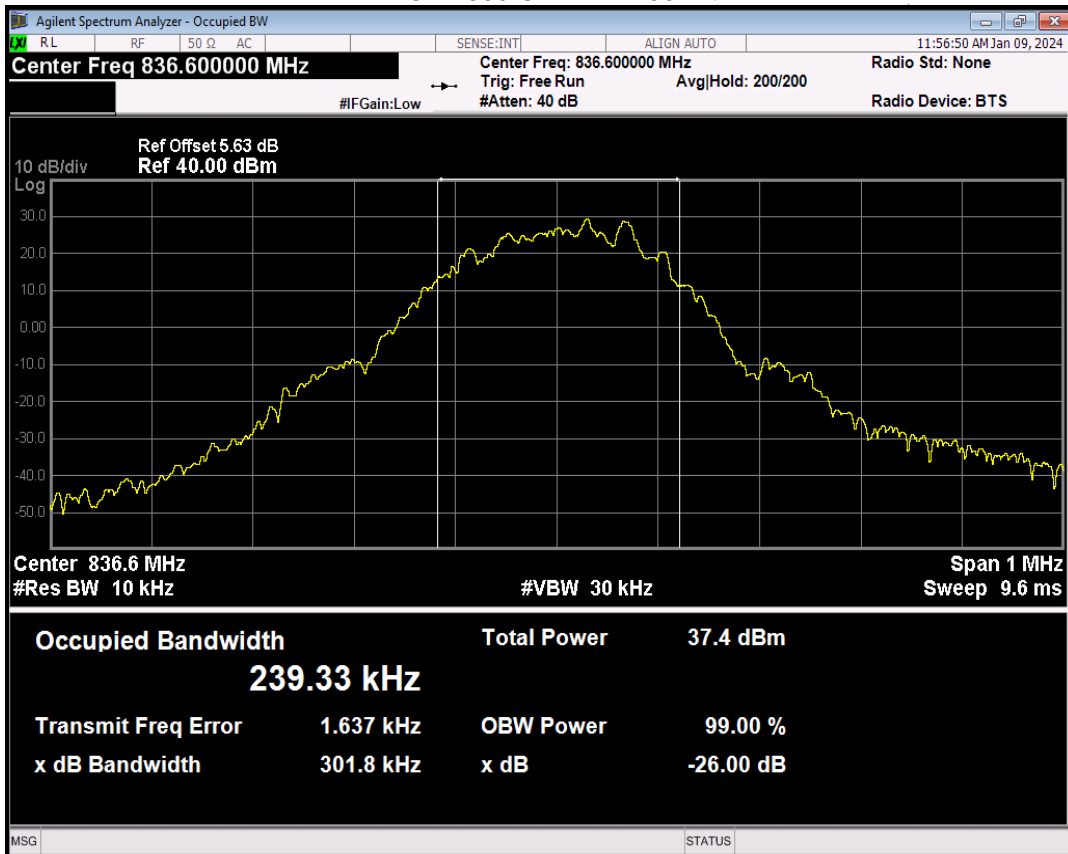

GSM850 Channel=251

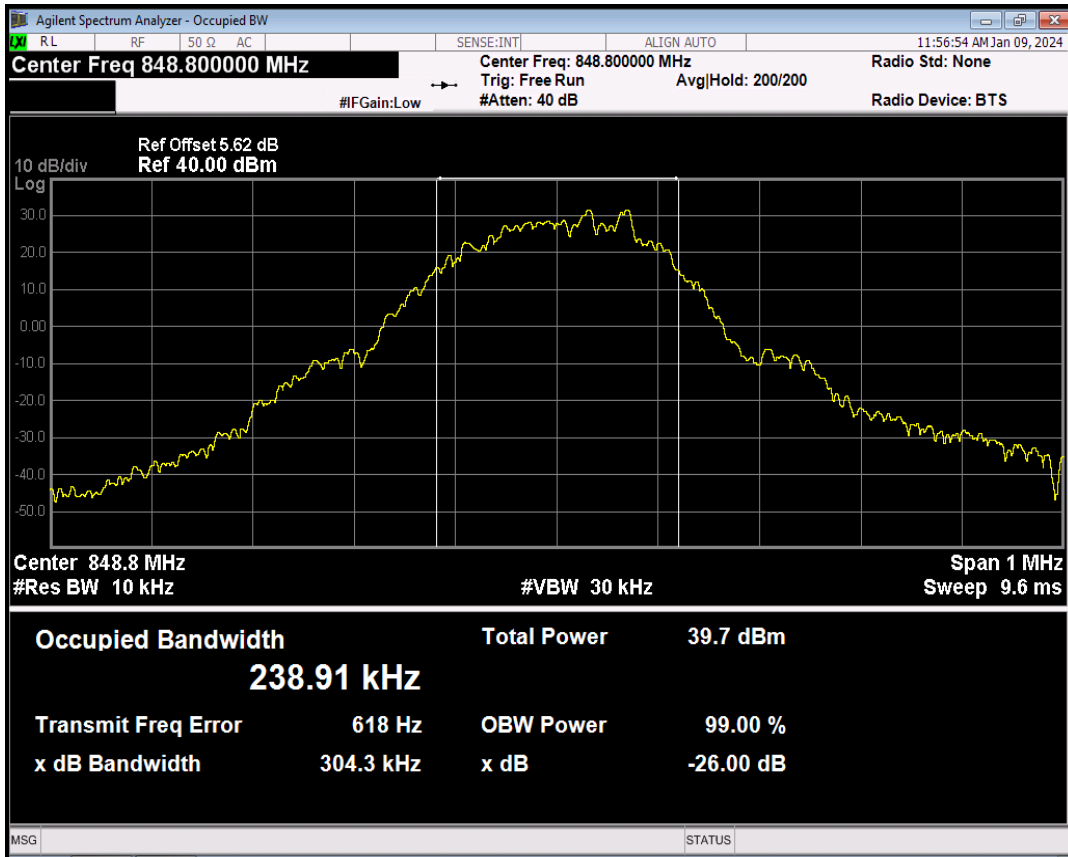

GPRS850 Channel=128

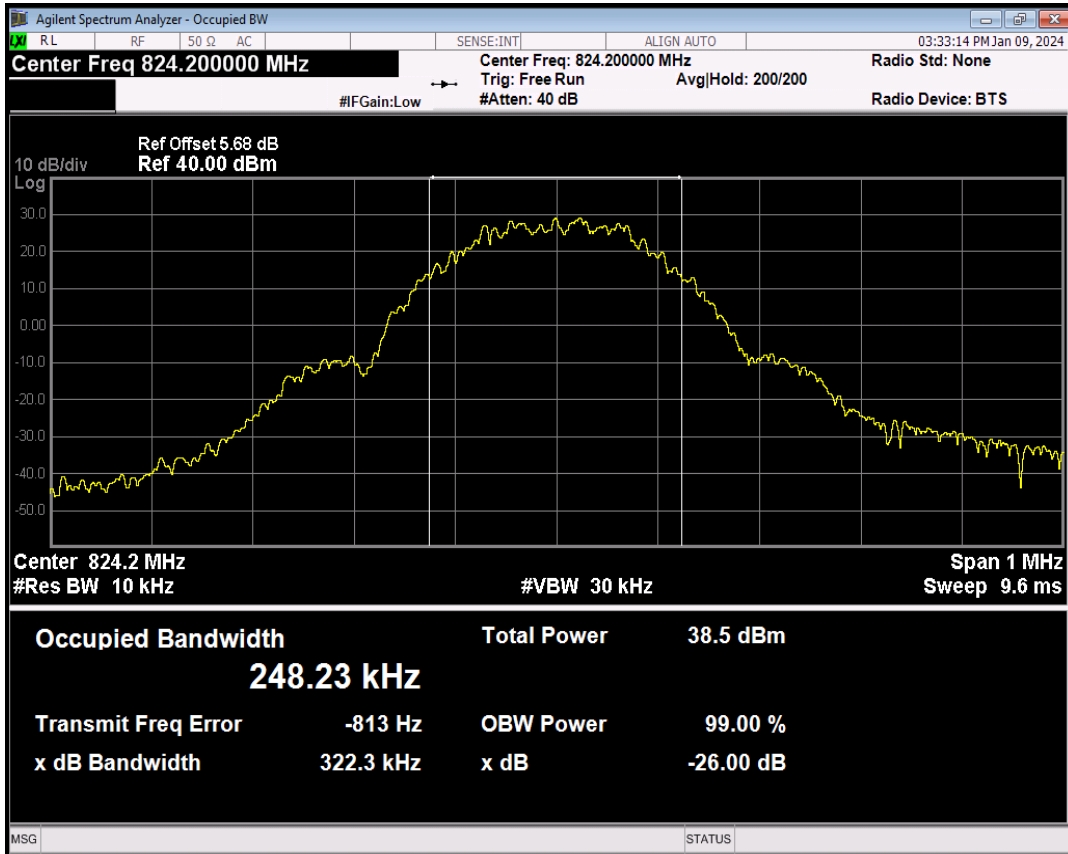

GPRS850 Channel=190

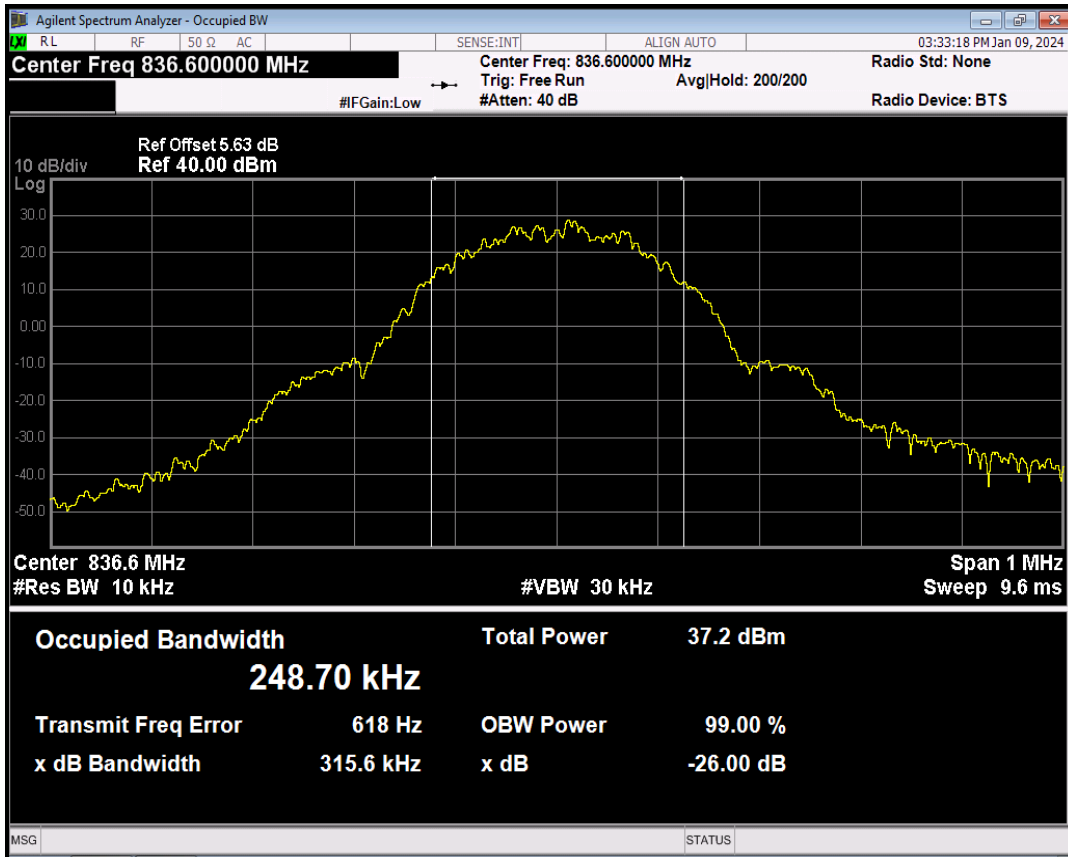

GPRS850 Channel=251

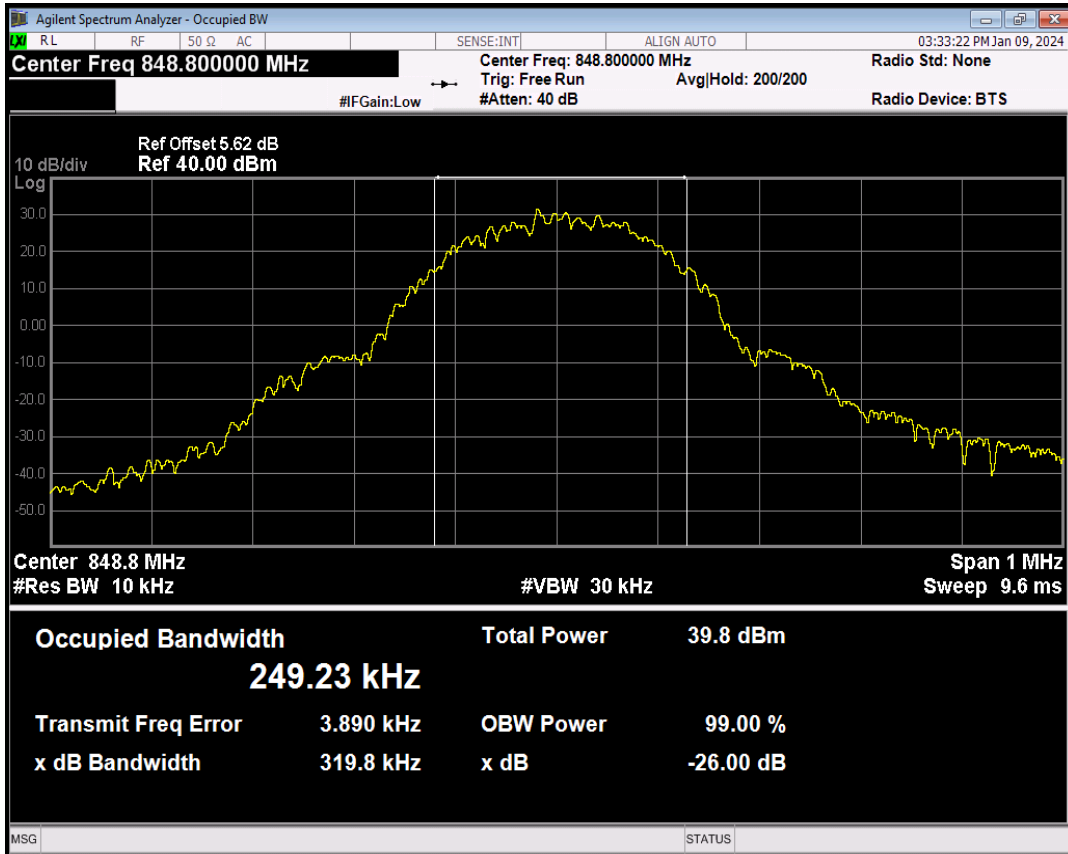

Band	Channel	Frequency (MHz)	99% OBW (kHz)	-26dB EBW (kHz)	Verdict
GSM1900	512	1850.2	246.350	300.324	PASS
GSM1900	661	1880	241.287	301.460	PASS
GSM1900	810	1909.8	242.969	306.543	PASS
GPRS1900	512	1850.2	243.402	320.177	PASS
GPRS1900	661	1880	245.401	311.932	PASS
GPRS1900	810	1909.8	244.741	319.520	PASS

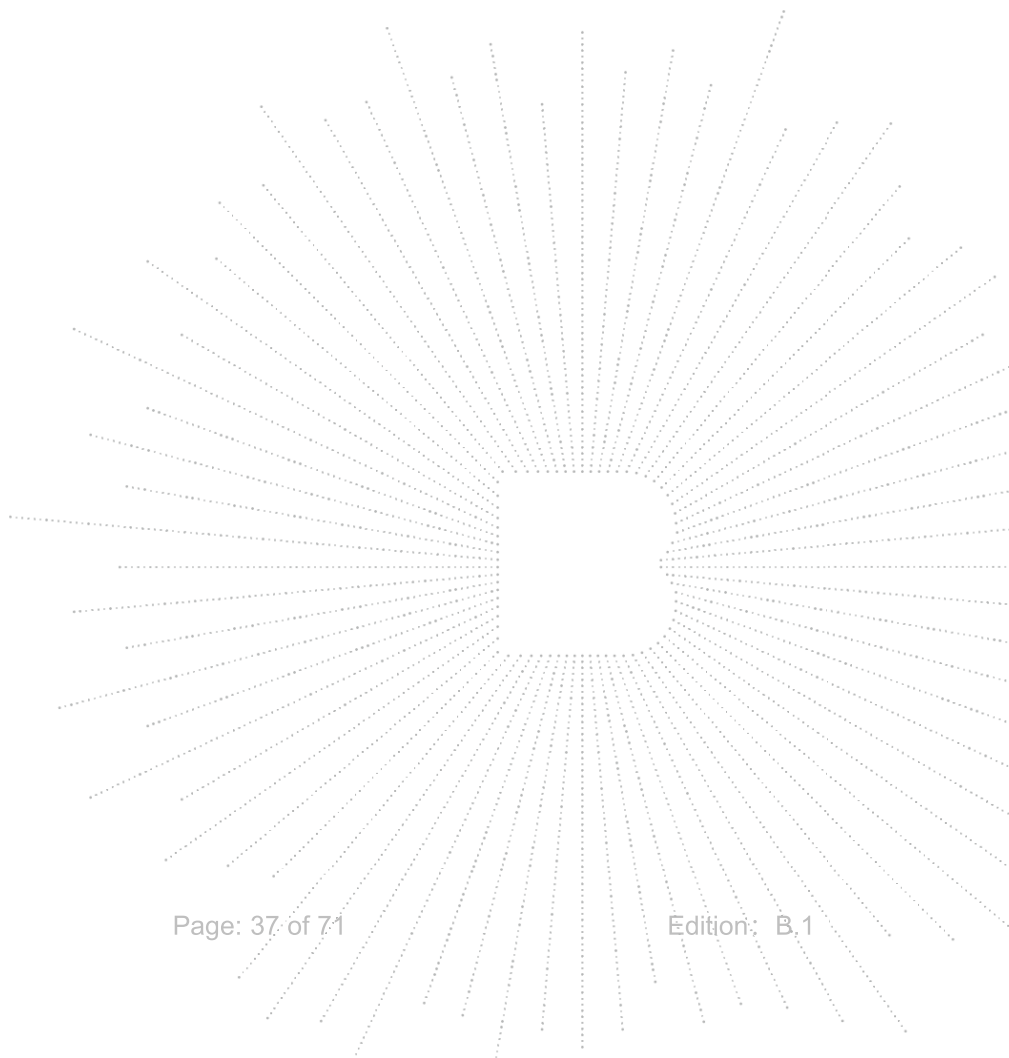

GSM1900 Channel=512

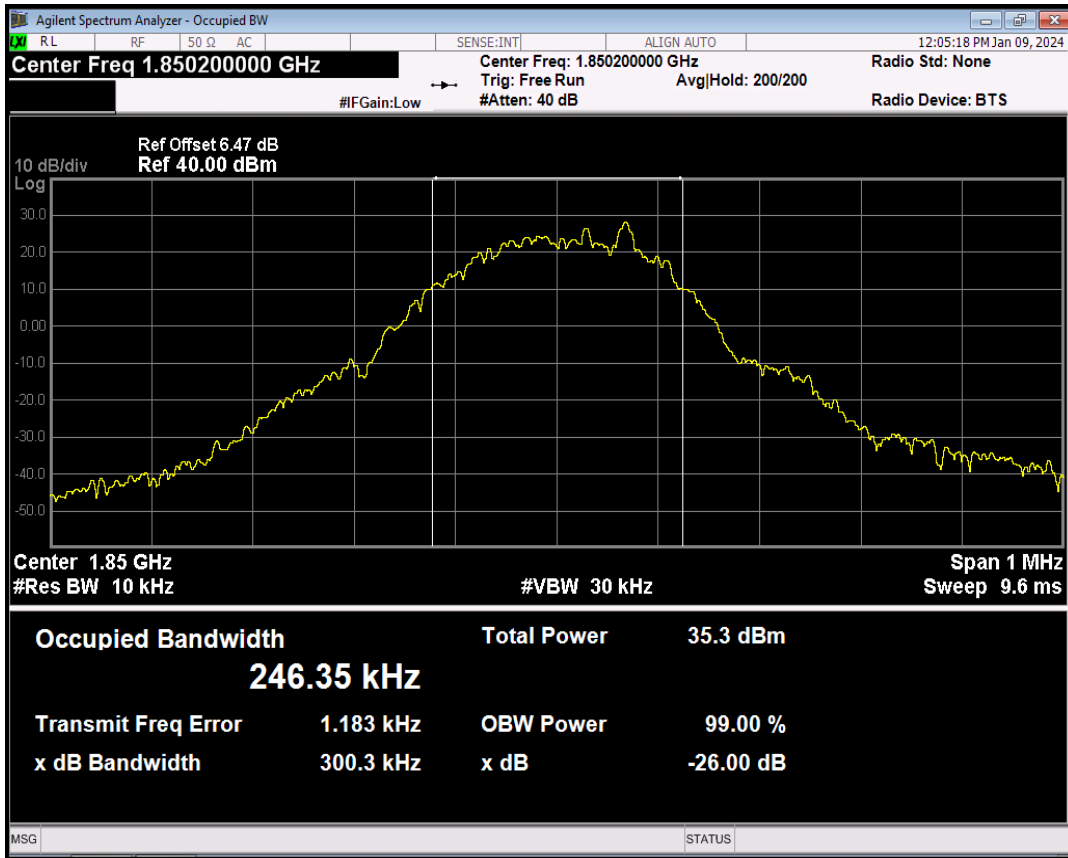

GSM1900 Channel=661

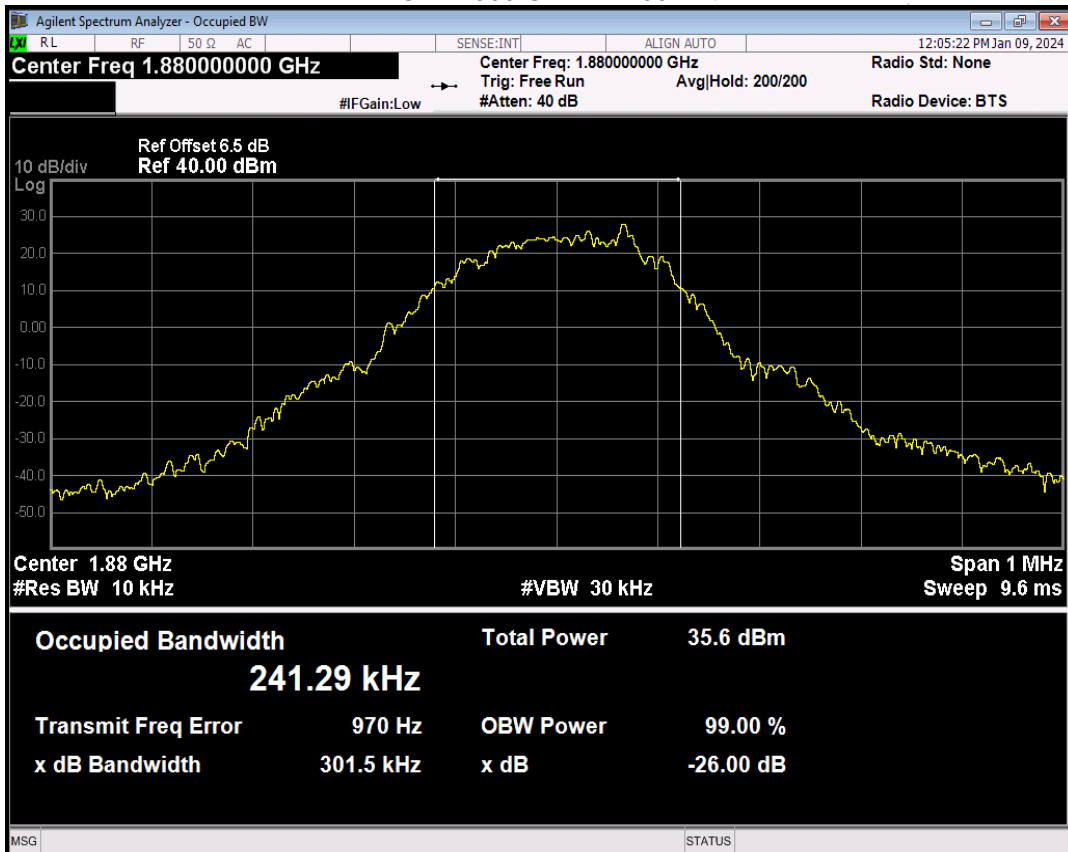

GSM1900 Channel=810

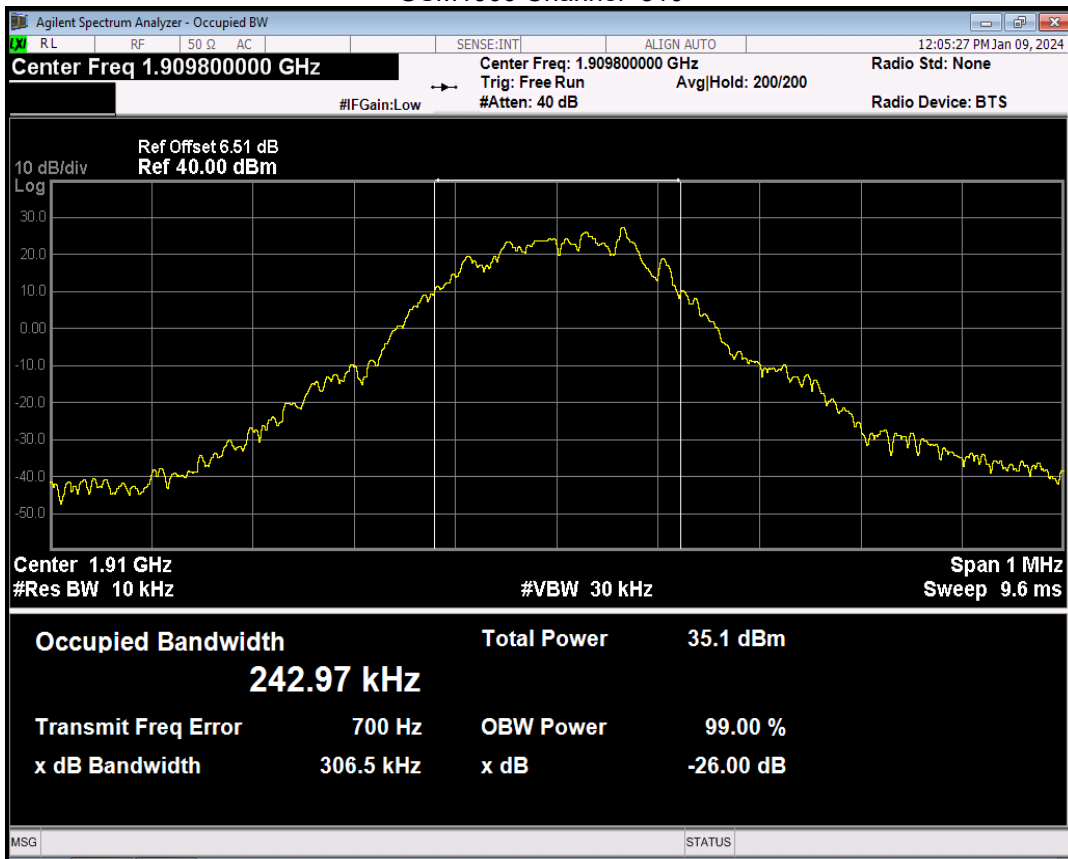

GPRS1900 Channel=512

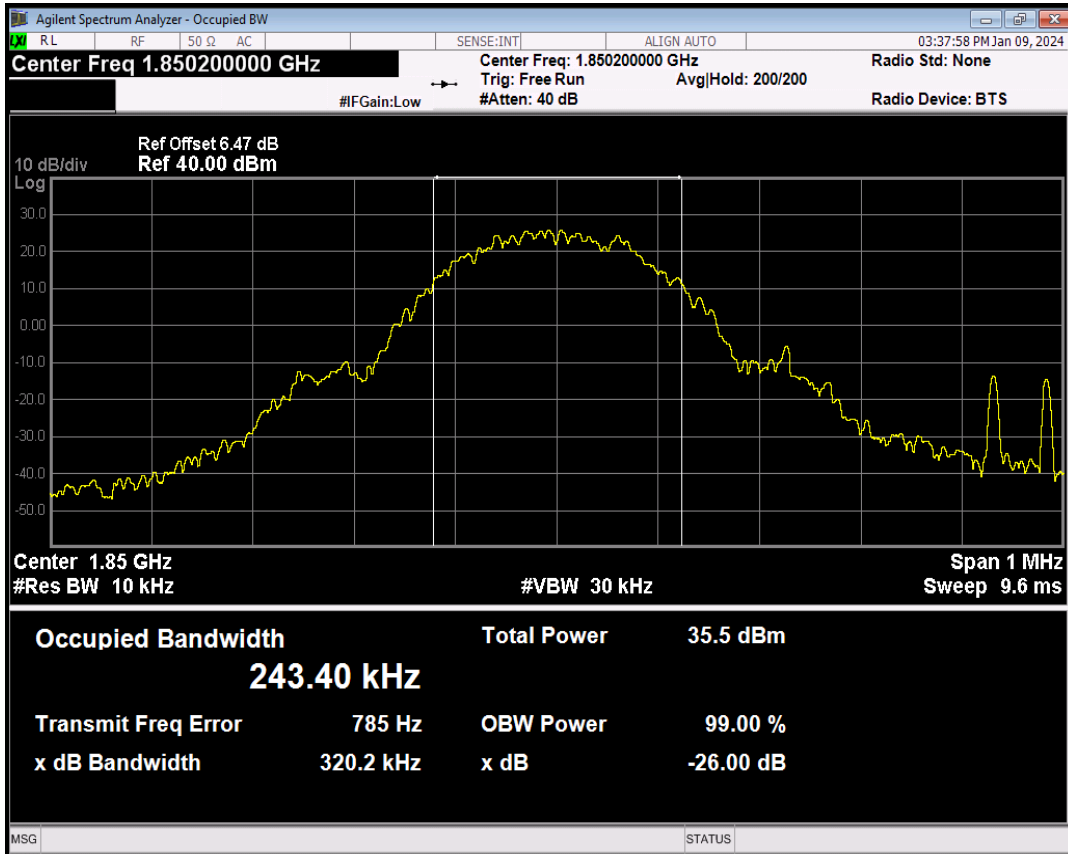

GPRS1900 Channel=661

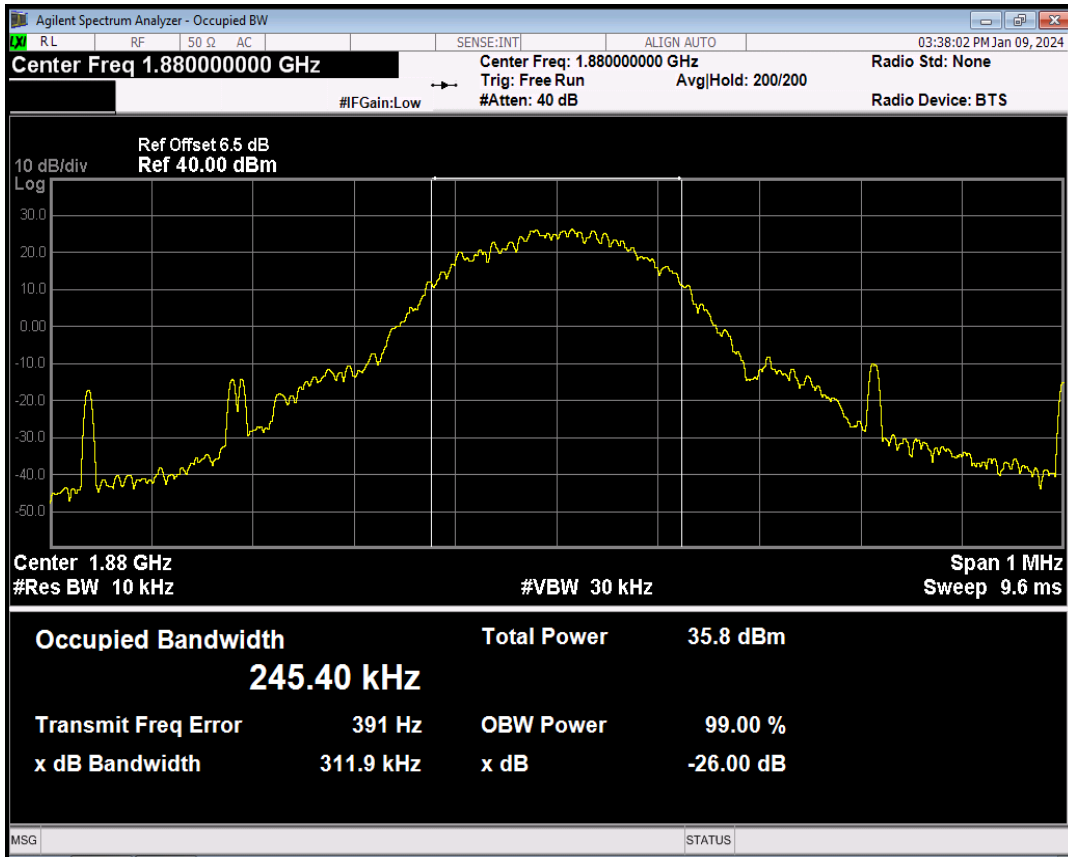

EGPRS1900 Channel=512

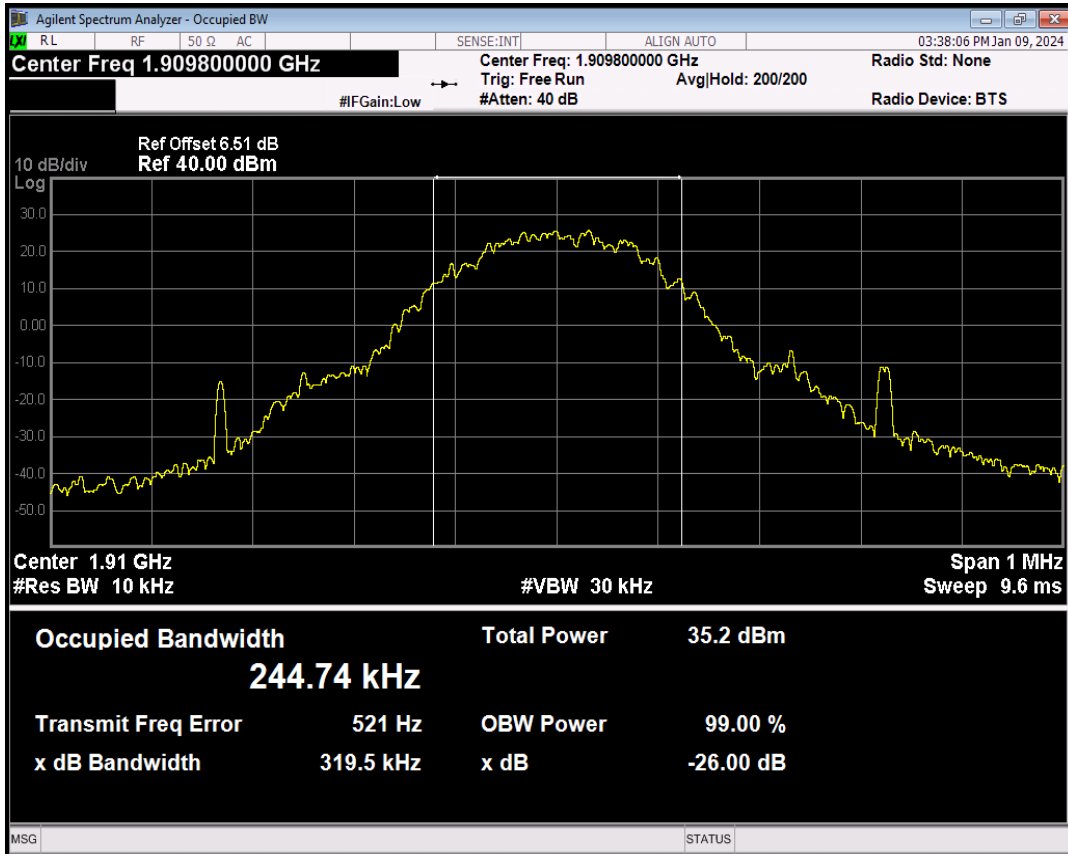

Band	Channel	Frequency (MHz)	99% OBW (kHz)	-26dB EBW (kHz)	Verdict
WCDMA Band2	9262	1852.4	4164.482	4661.248	PASS
WCDMA Band2	9400	1880	4146.987	4673.498	PASS
WCDMA Band2	9538	1907.6	4149.346	4662.823	PASS
WCDMA Band5	4132	826.4	4173.588	4671.949	PASS
WCDMA Band5	4182	836.4	4166.392	4697.671	PASS
WCDMA Band5	4233	846.6	4155.424	4670.337	PASS

Note: In WCDMA, RMC, HSDPA and HSUPA all three tests only reflect the worst mode RMC.

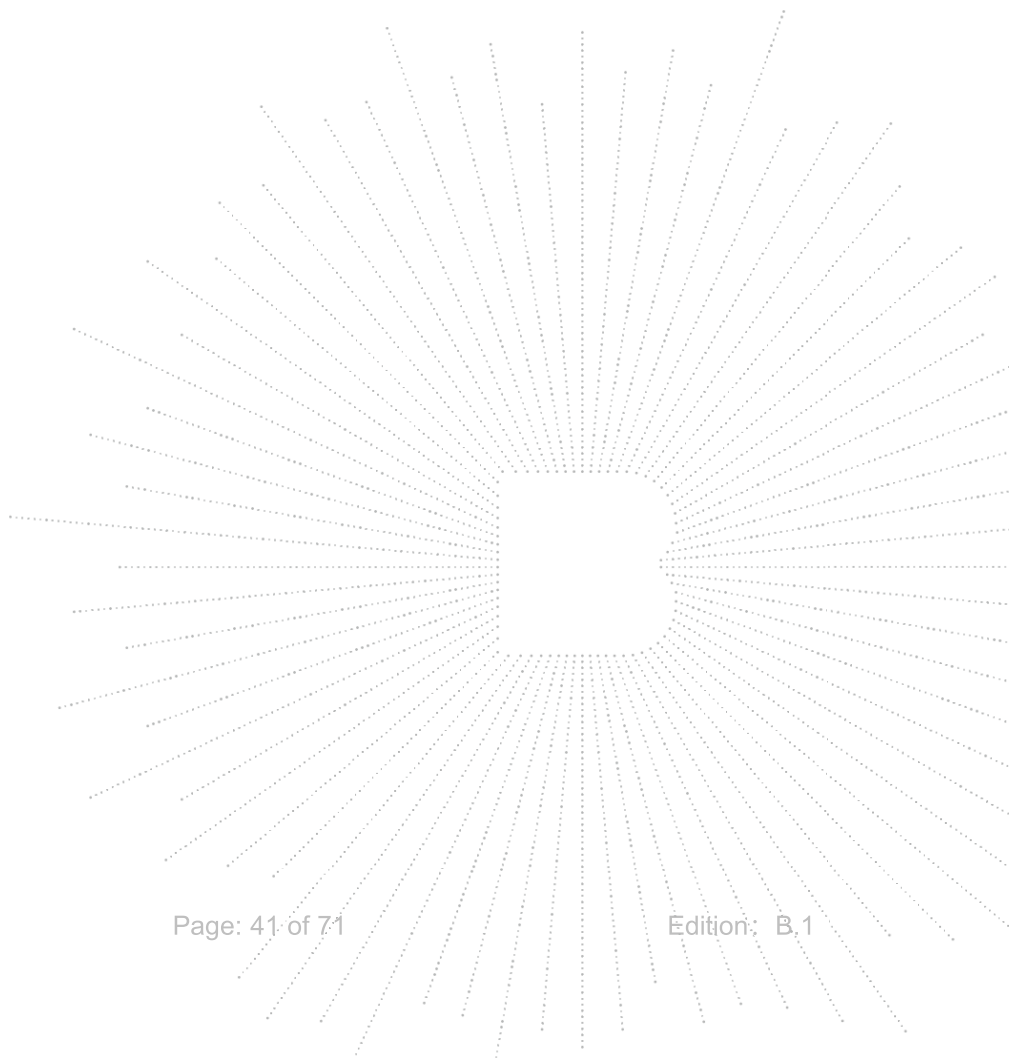

WCDMA Band2 Channel=9262

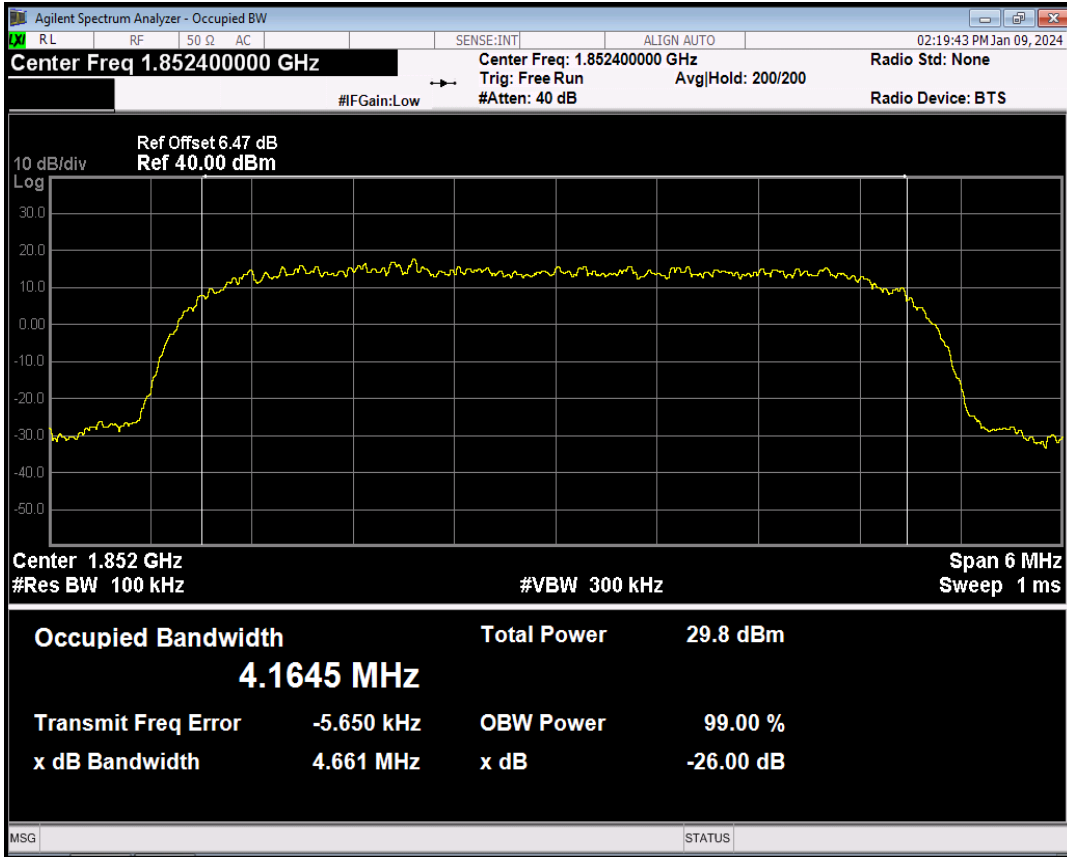

WCDMA Band2 Channel=9400

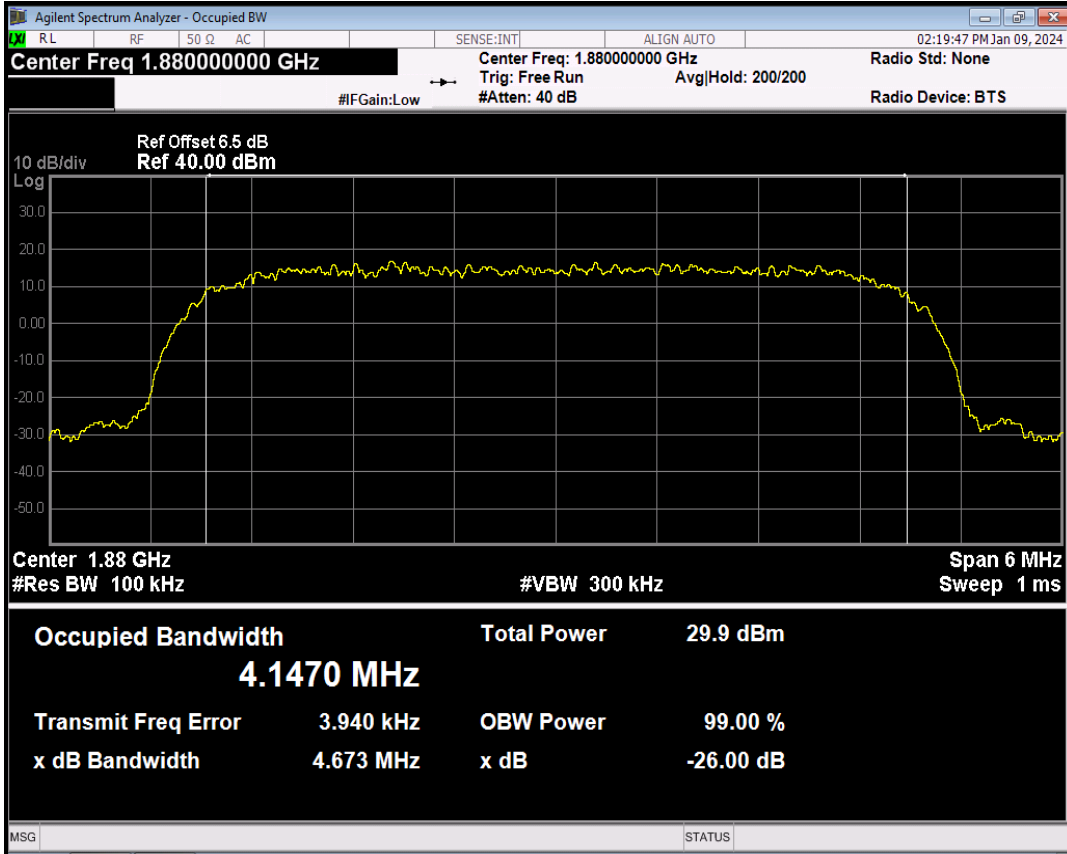

WCDMA Band2 Channel=9538

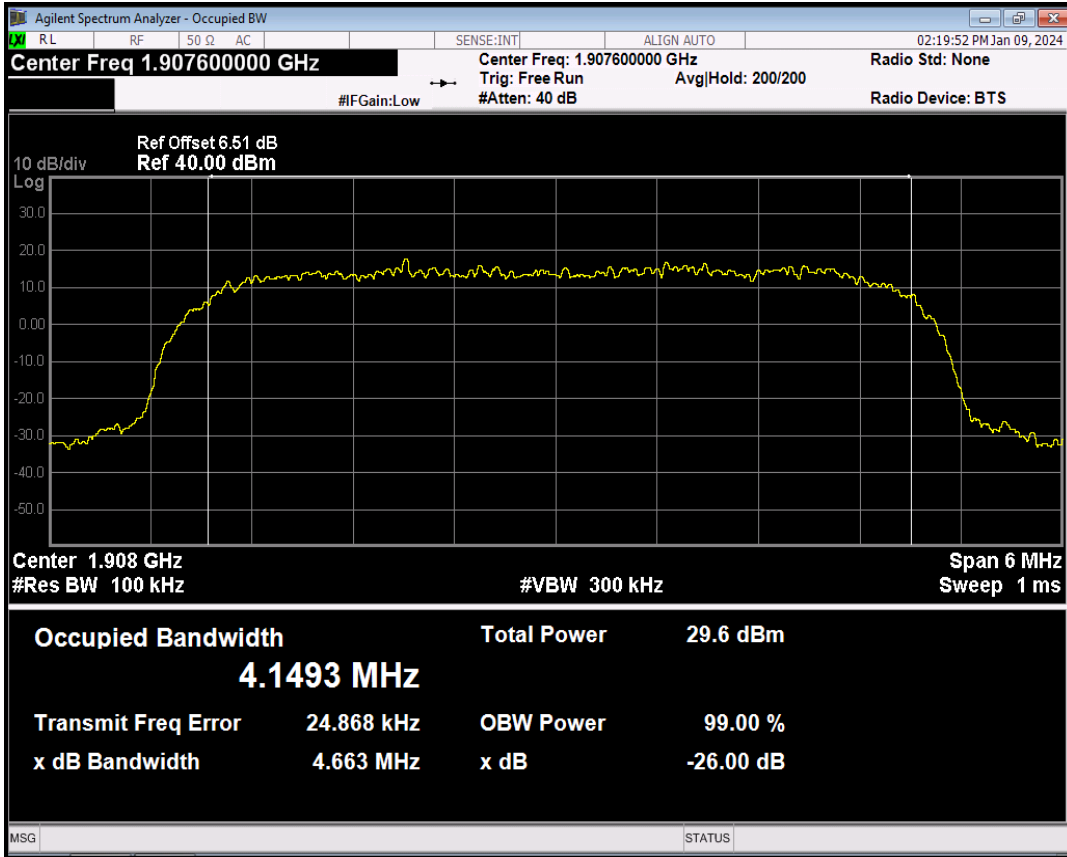

WCDMA Band5 Channel=4132

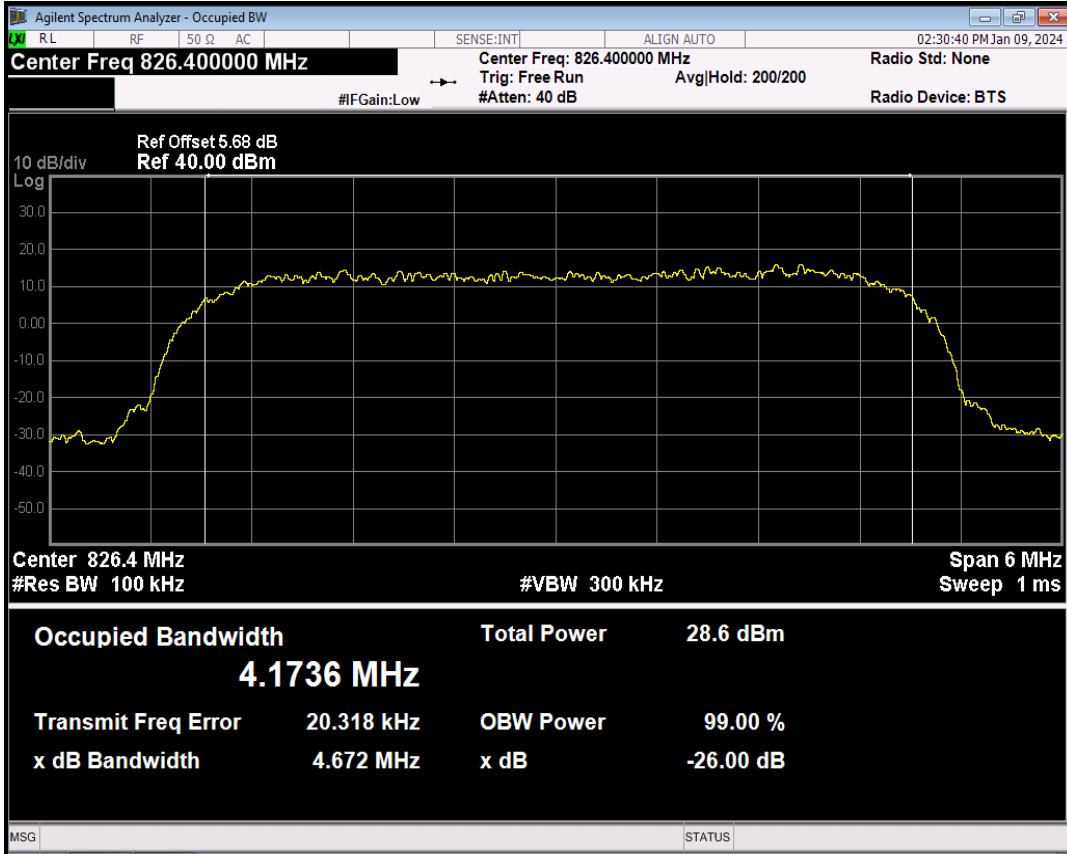

WCDMA Band5 Channel=4182

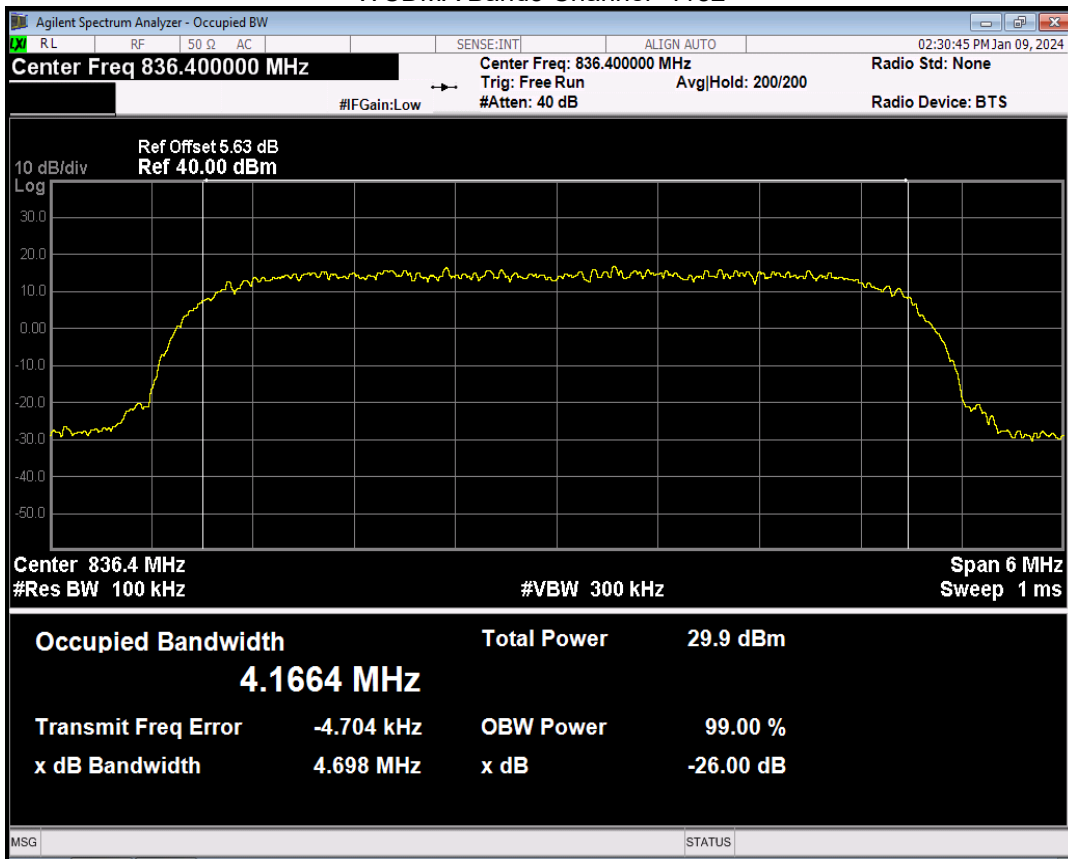

WCDMA Band5 Channel=4233

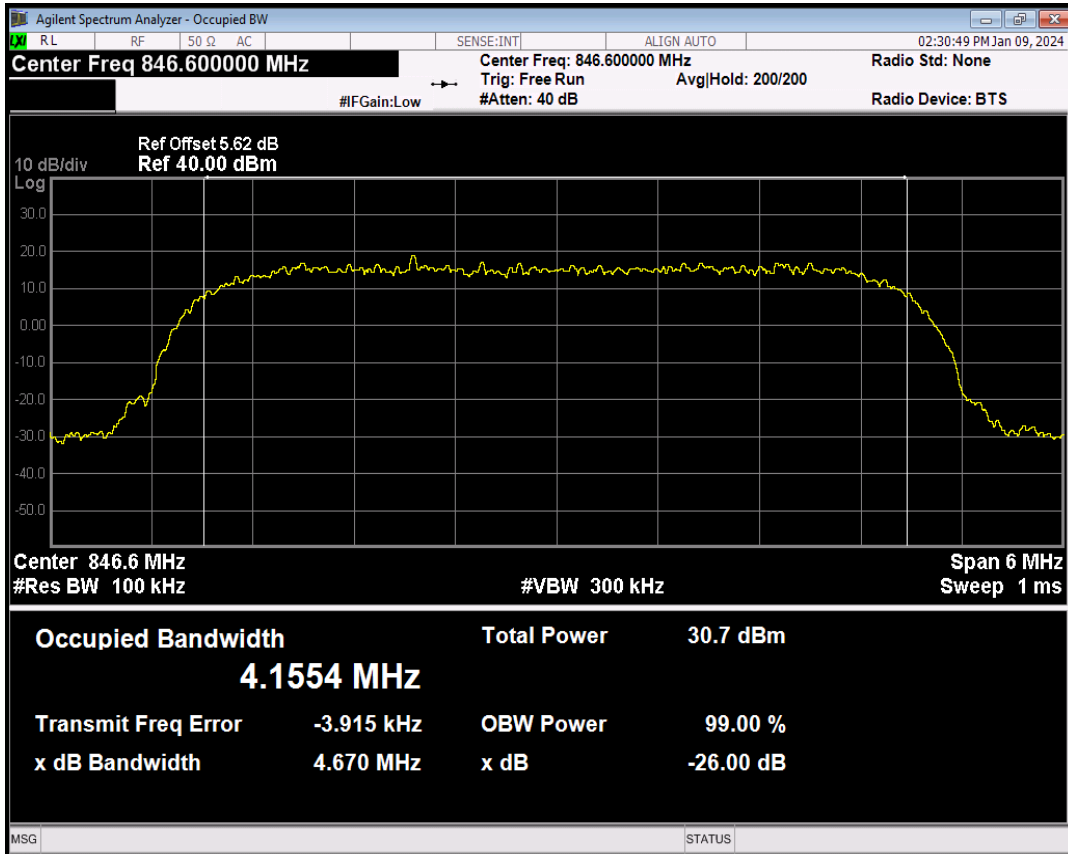

9. Out of Band Emissions at Antenna Terminal

9.1 Block Diagram Of Test Setup

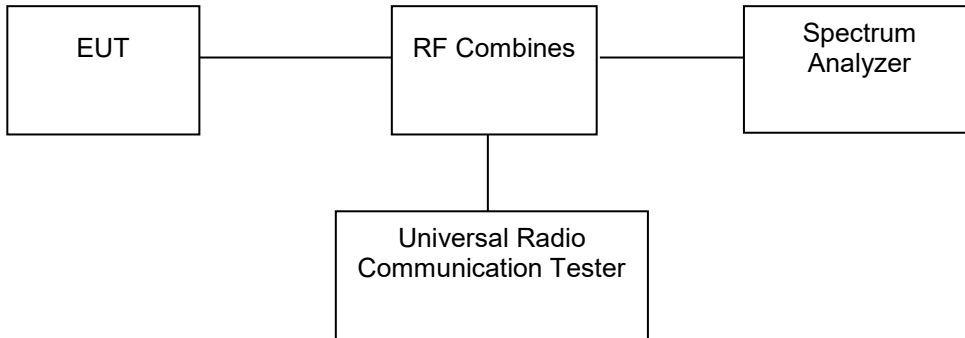

9.2 Limit

According to §22.917(a), the power of any emissions outside of the authorized operating frequency ranges must be attenuated below the transmitting power (P) by a factor of at least $43 + 10 \log(P)$ dB.

According to §24.238(a), the power of any emissions outside of the authorized operating frequency ranges must be attenuated below the transmitting power (P) by a factor of at least $43 + 10 \log(P)$ dB.

According to §27.53 (h), the power of any emission outside a licensee's frequency block shall be attenuated below the transmitter power (P) in watts by at least $43 + 10 \log_{10}(P)$ dB.

9.3 Test procedure

The RF output terminal of the transmitter was connected to the input of the spectrum analyzer via a suitable attenuation. The RBW of the spectrum analyzer was set to 100kHz and 1MHz for the scan frequency from 30MHz to 1GHz and the scan frequency from 1GHz to up to 10th harmonic. At the edge of the authorized Frequency block/band: RBW set 1%-5%OBW.

9.4 Test Result

GSM1900 Channel=512

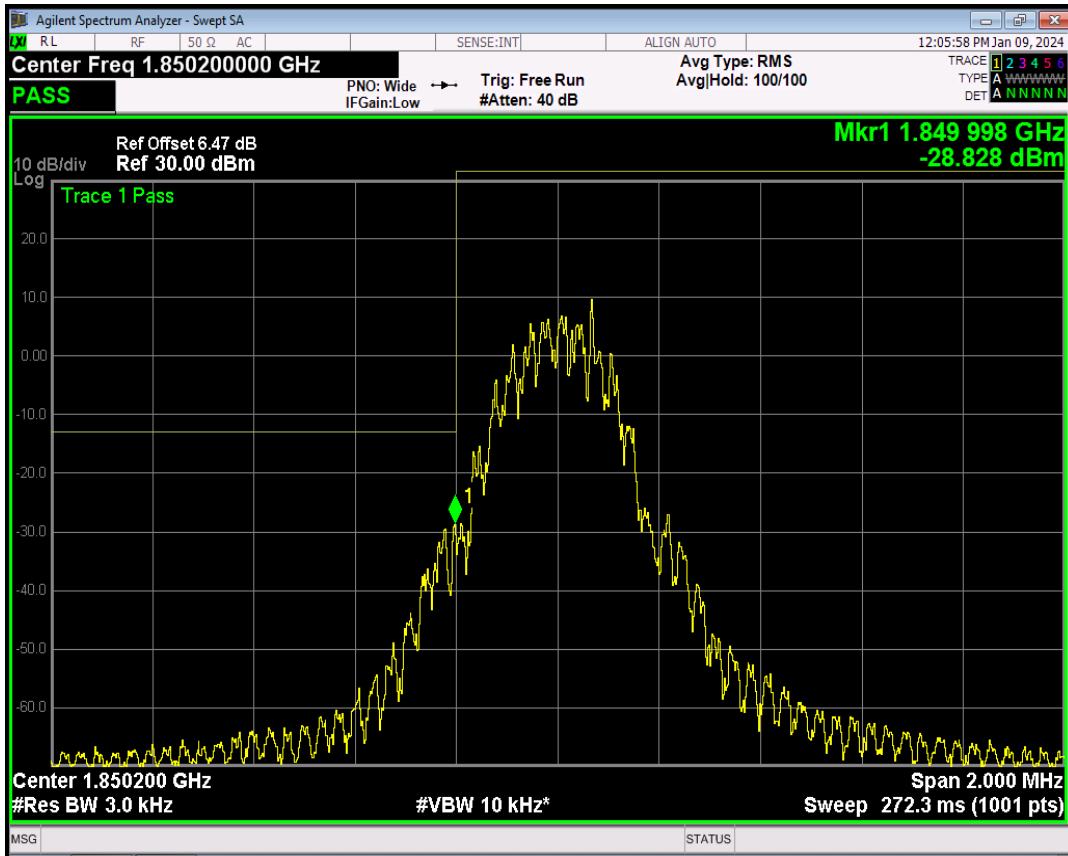

GSM1900 Channel=810

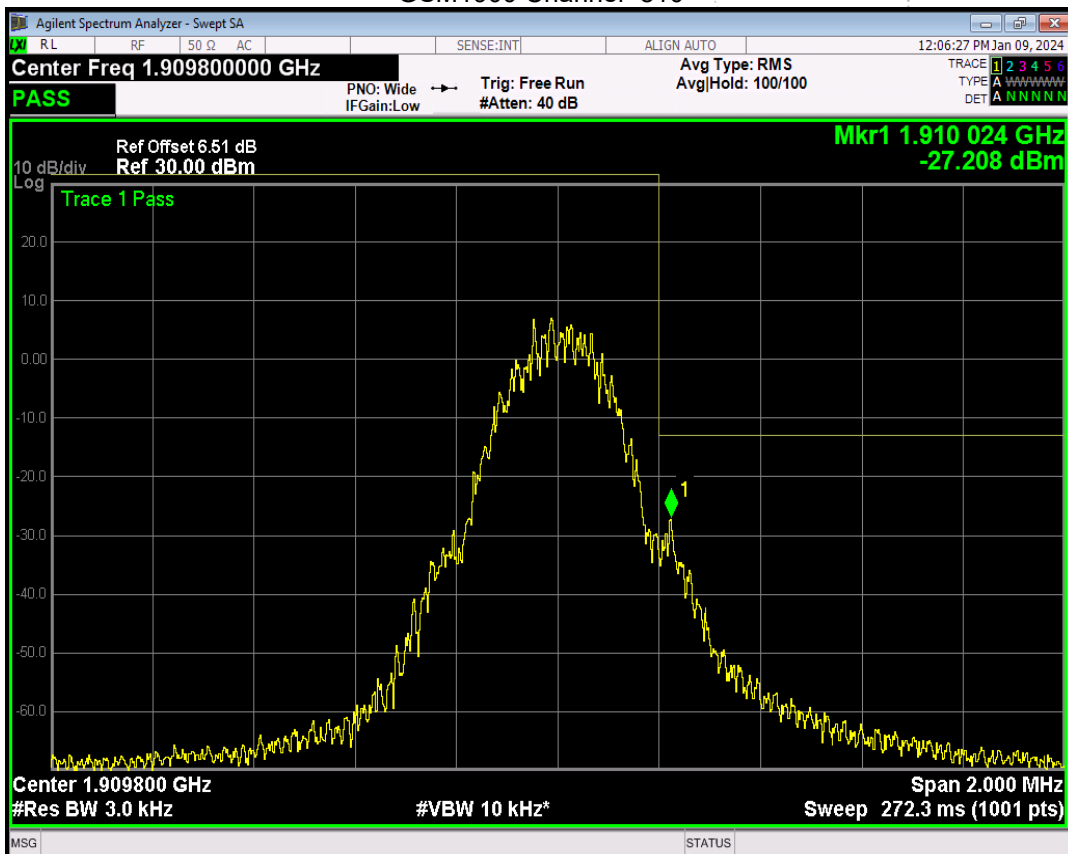

GSM850 Channel=128

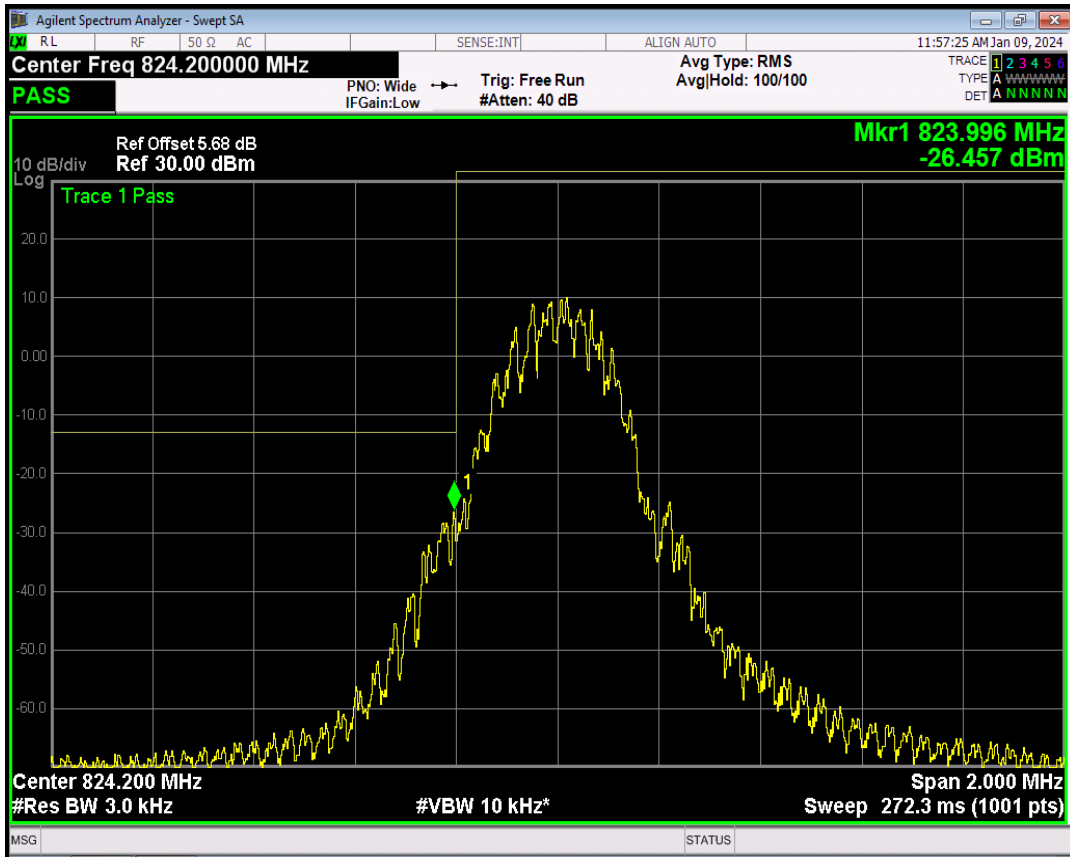

GSM850 Channel=251

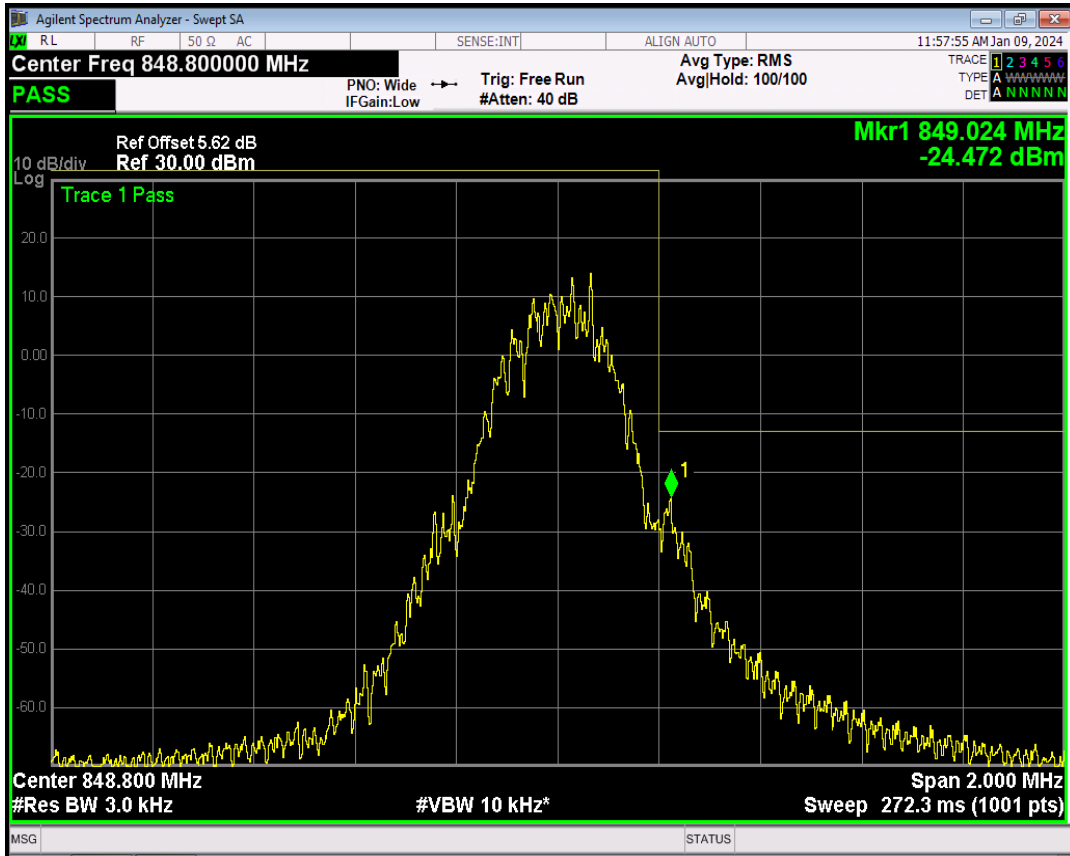

GSM1900 Channel=512

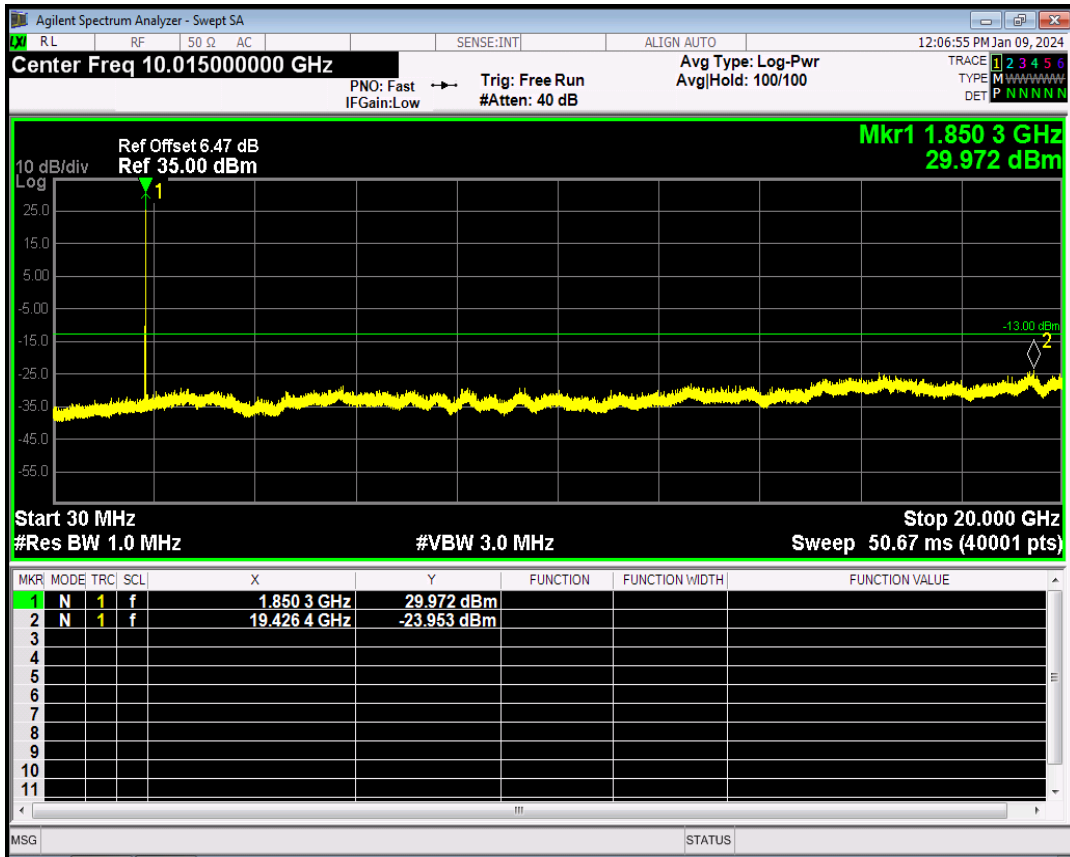

GSM1900 Channel=661

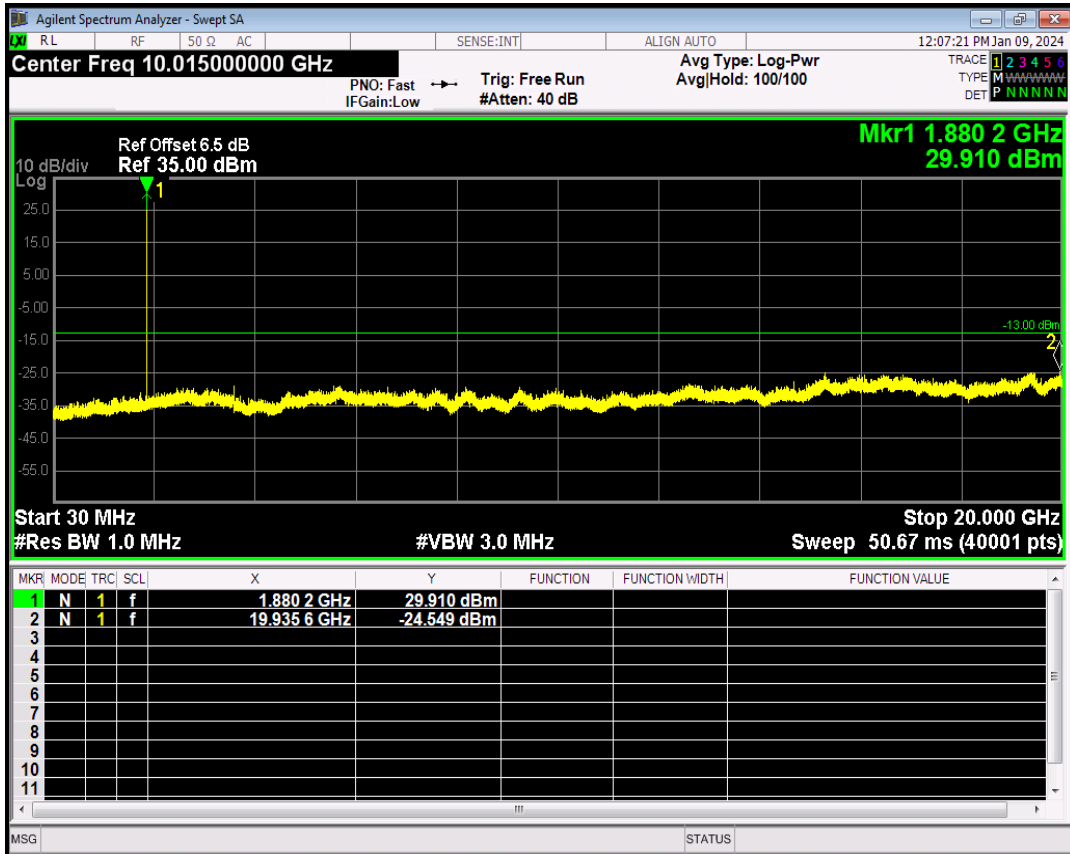

GSM1900 Channel=810

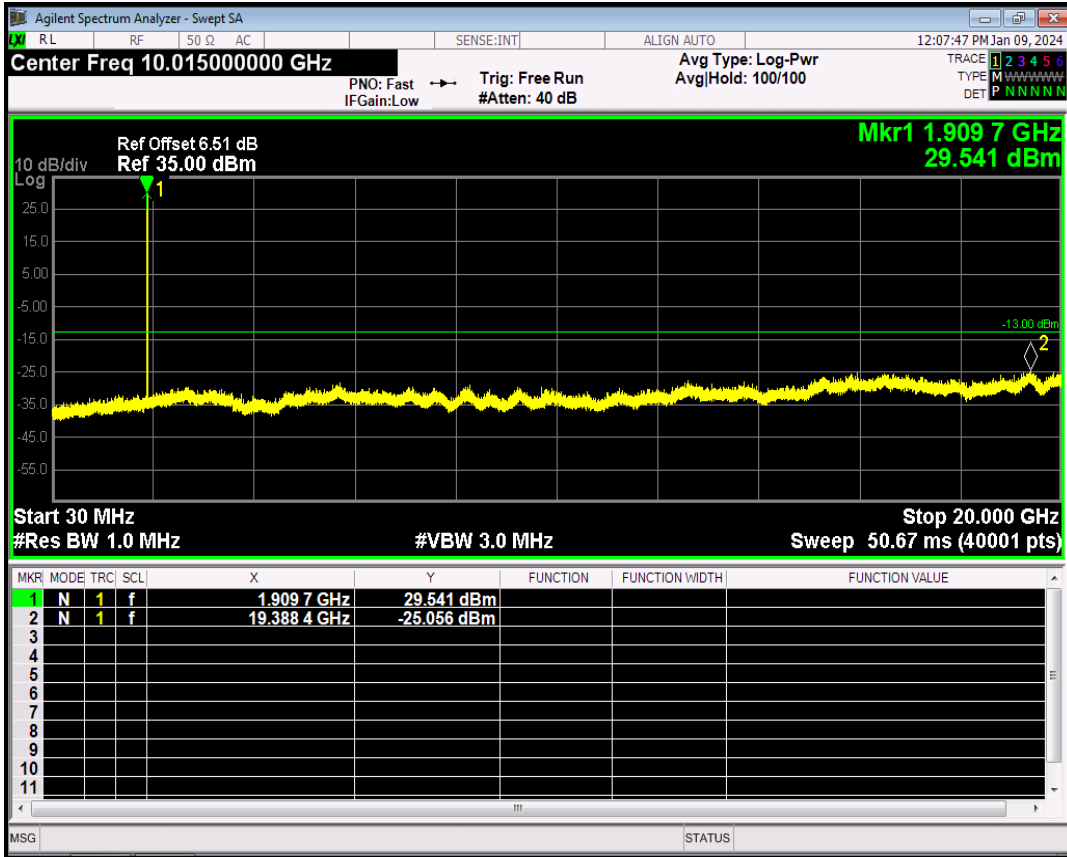

GSM850 Channel=128

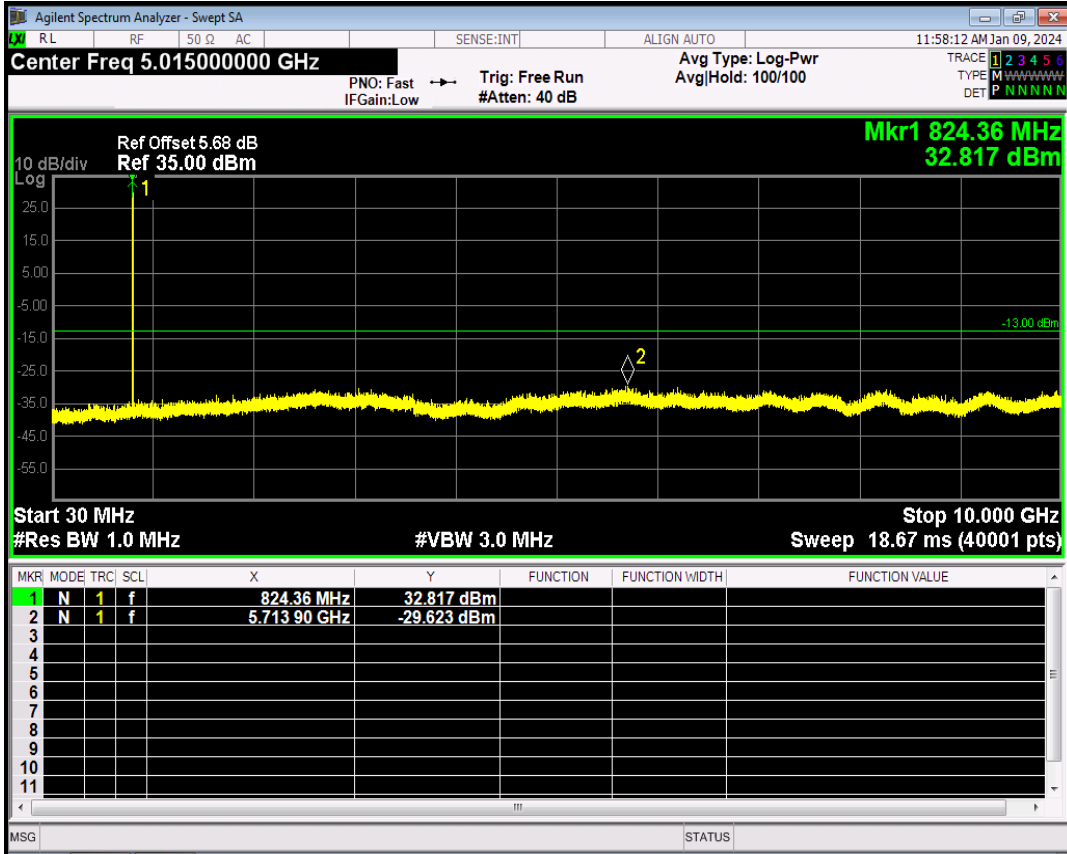

GSM850 Channel=190

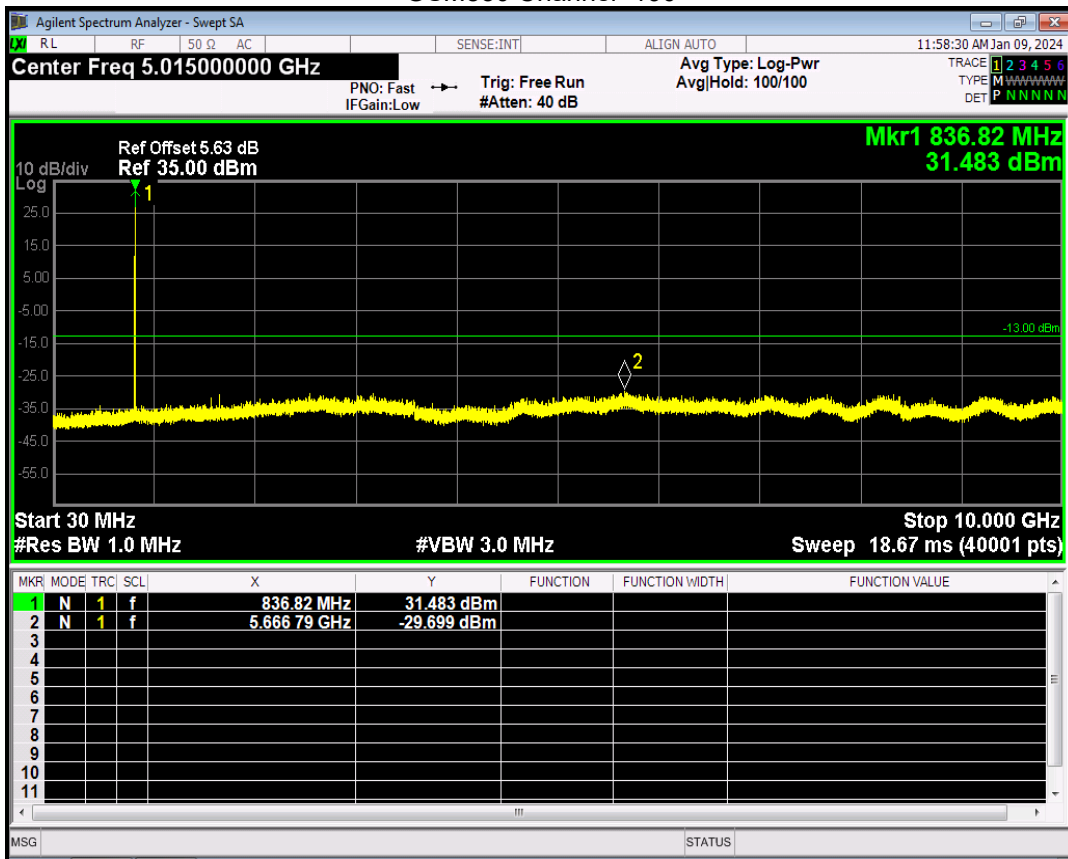

GSM850 Channel=251

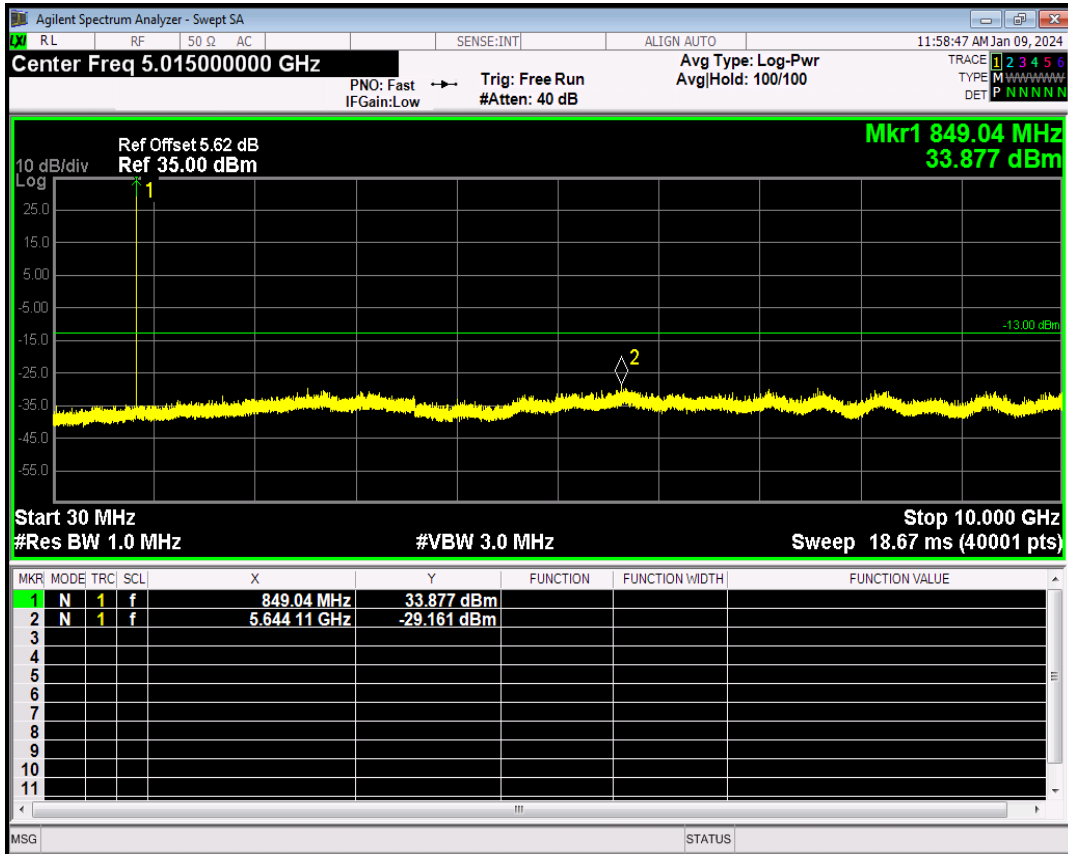

GPRS1900 Channel=512

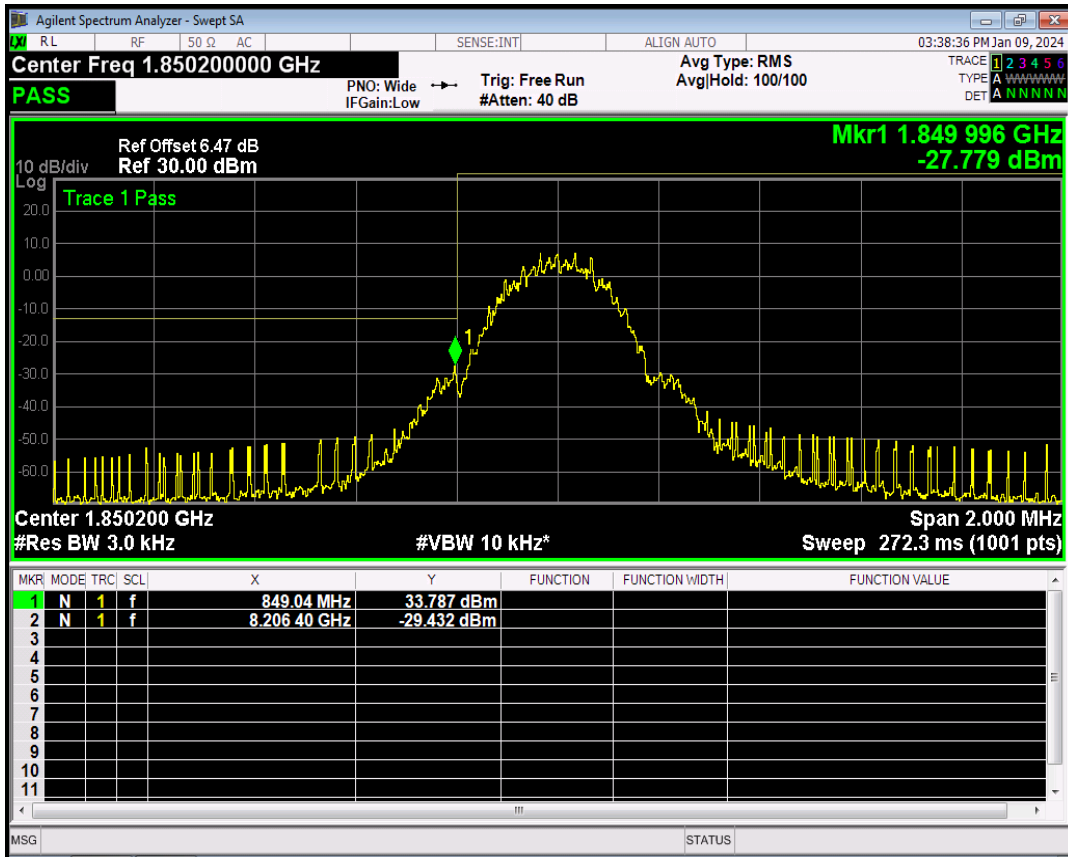

GPRS1900 Channel=810

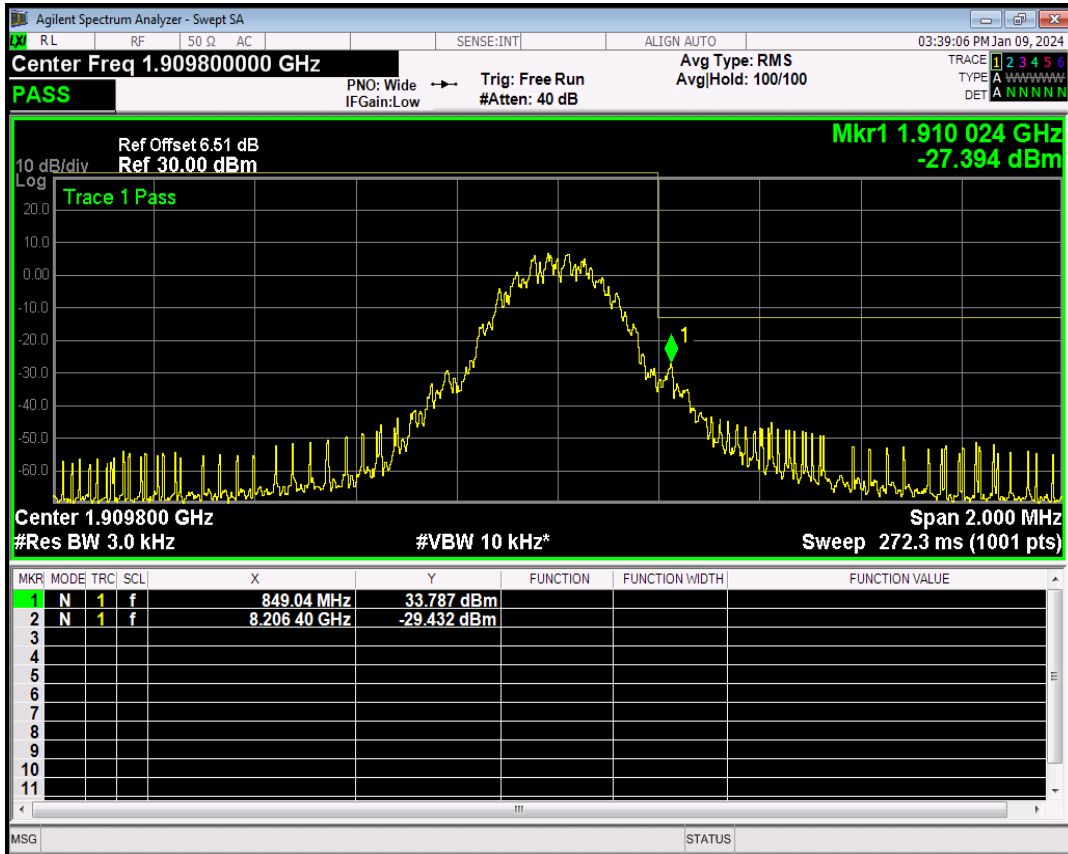

GPRS850 Channel=128

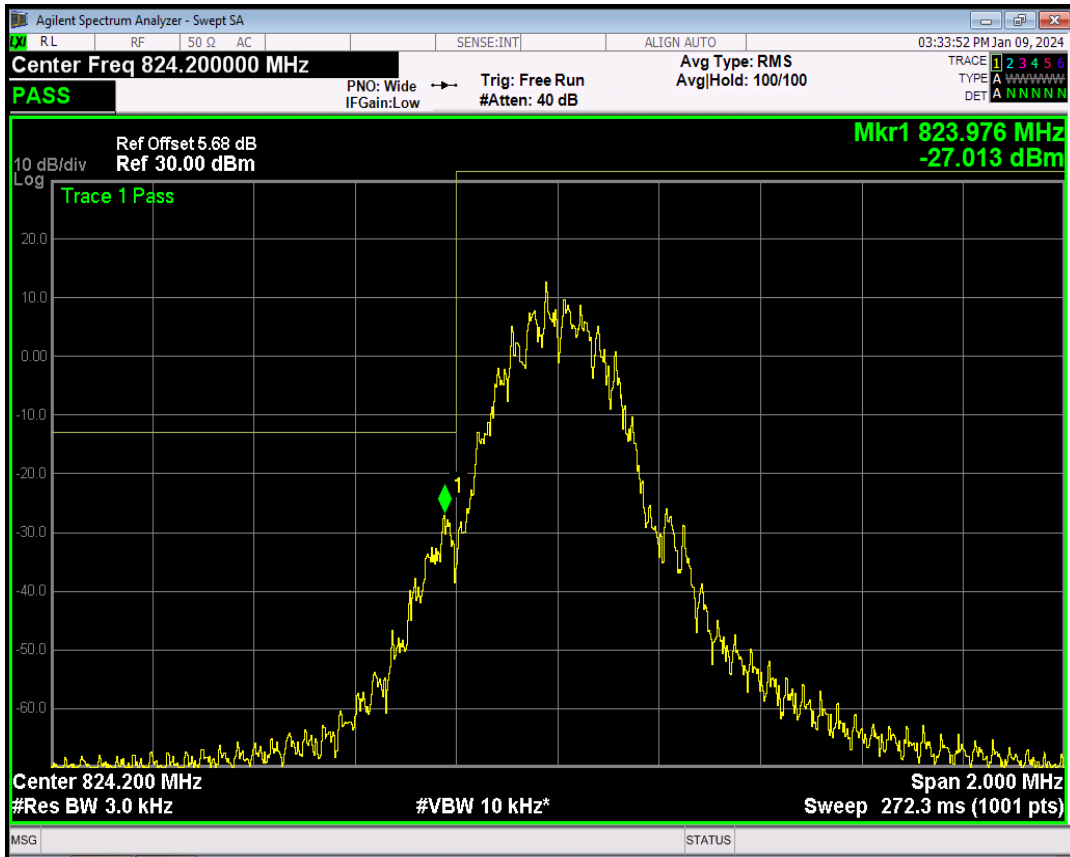

GPRS850 Channel=251

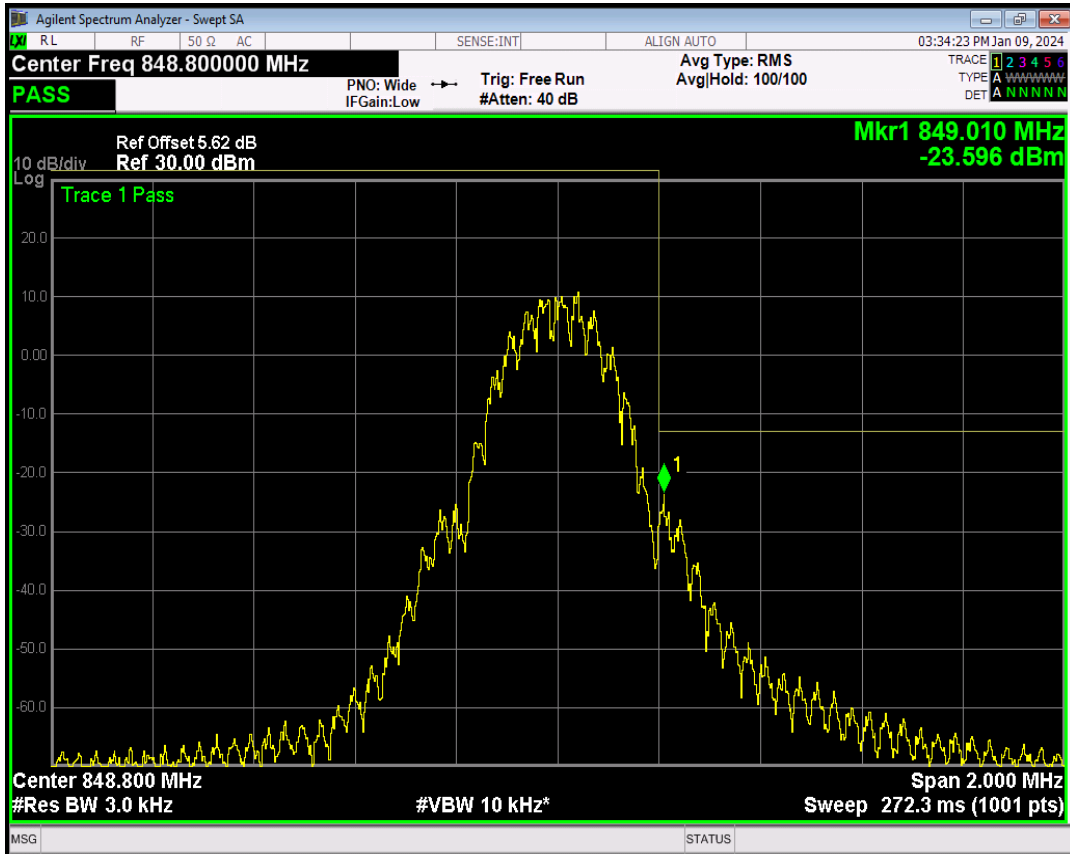

GPRS1900 Channel=512

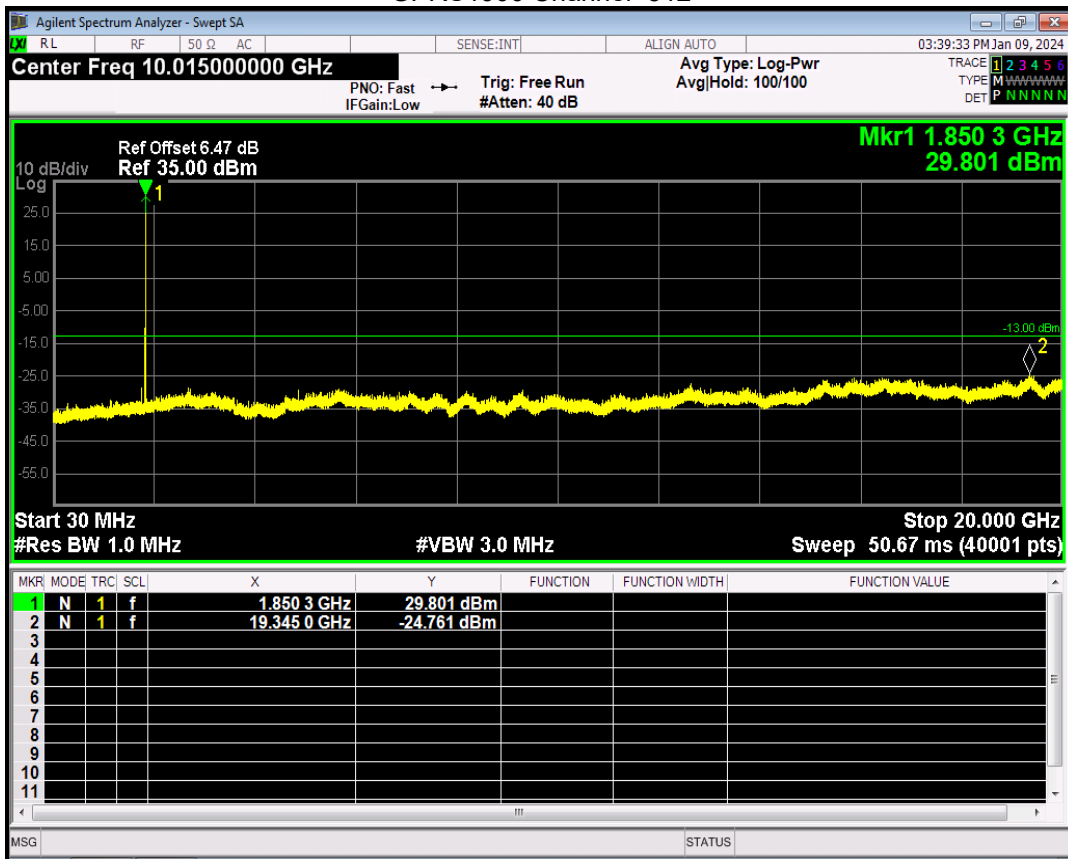

GPRS1900 Channel=661

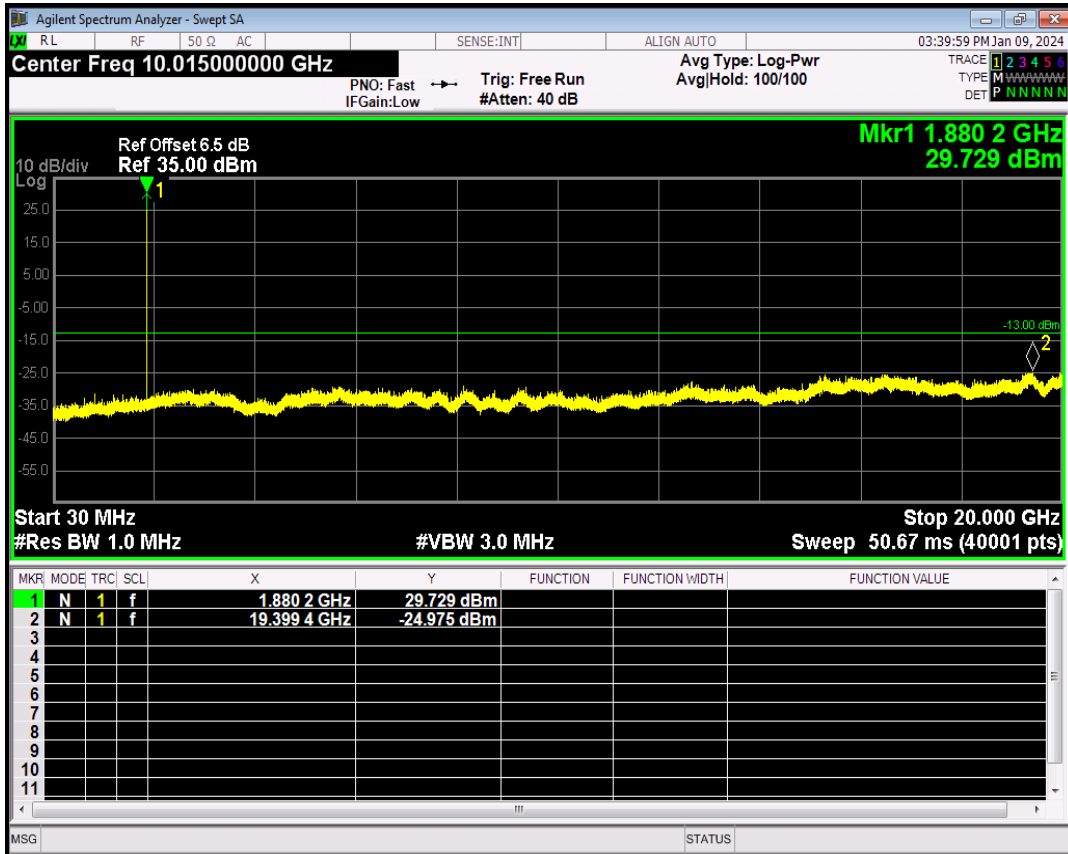

GPRS1900 Channel=810

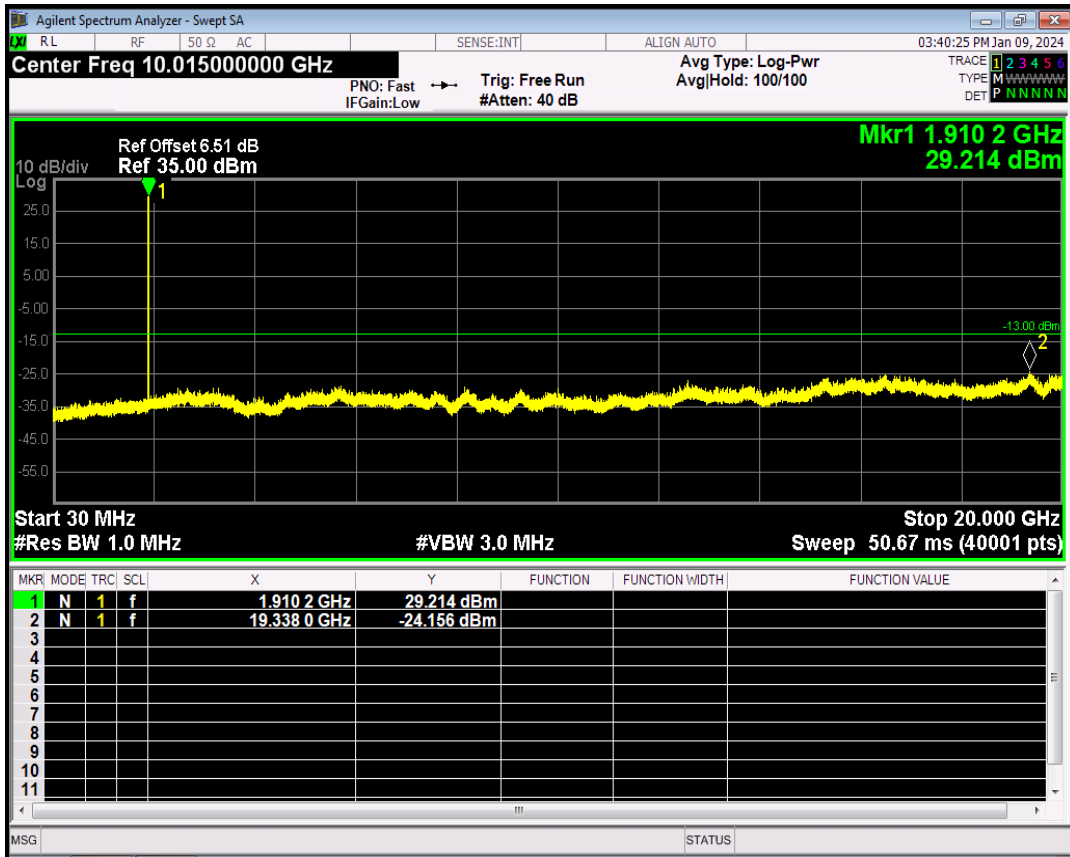

GPRS850 Channel=128

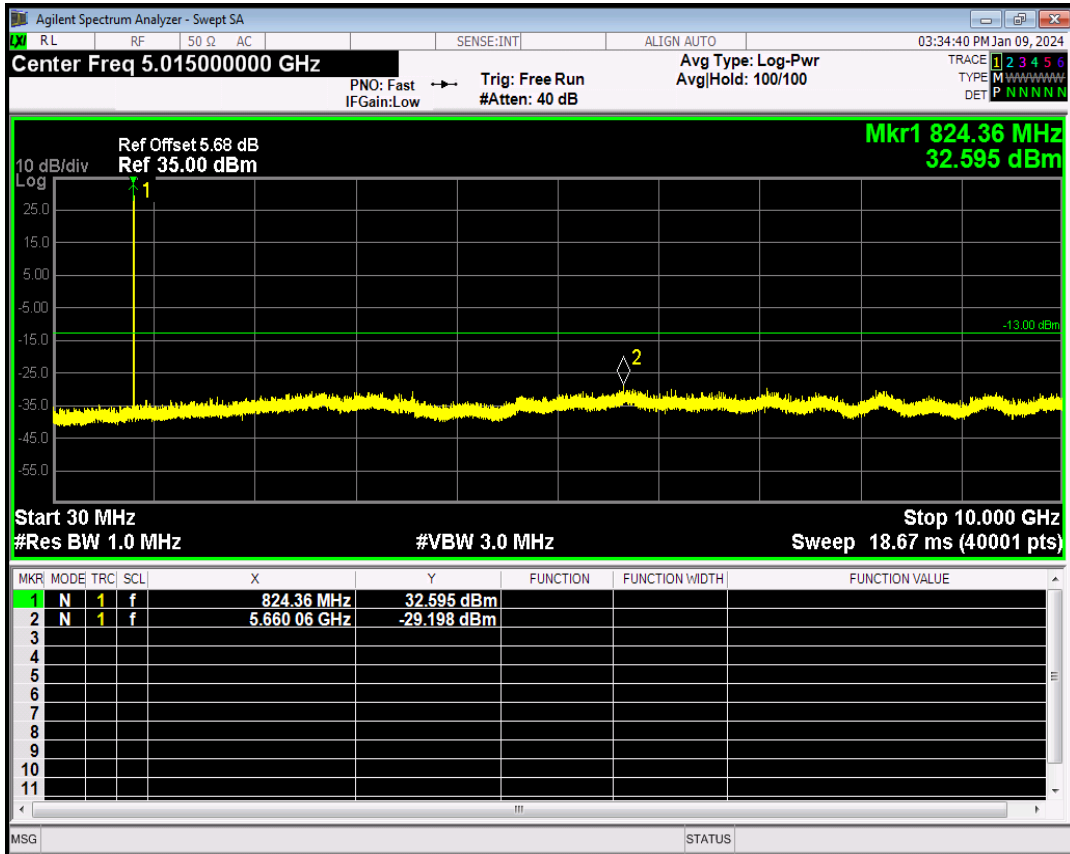

GPRS850 Channel=190

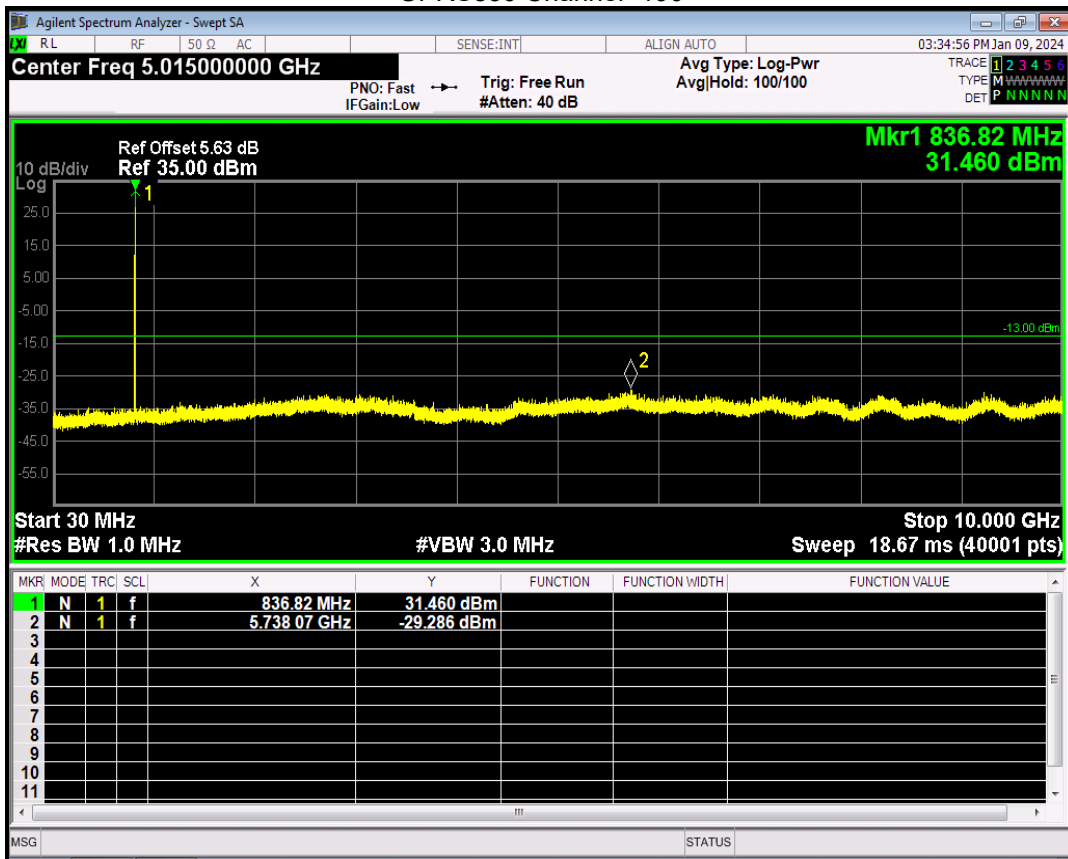

GPRS850 Channel=251

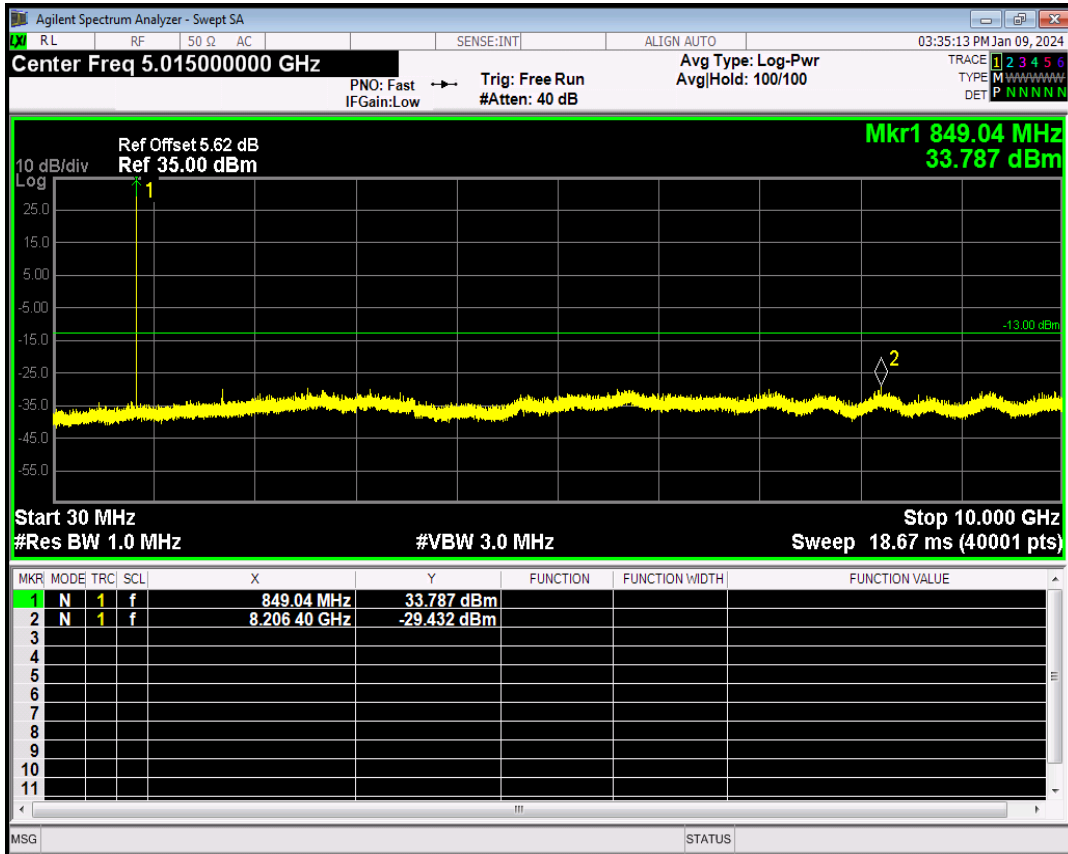

WCDMA Band2 Channel=9262

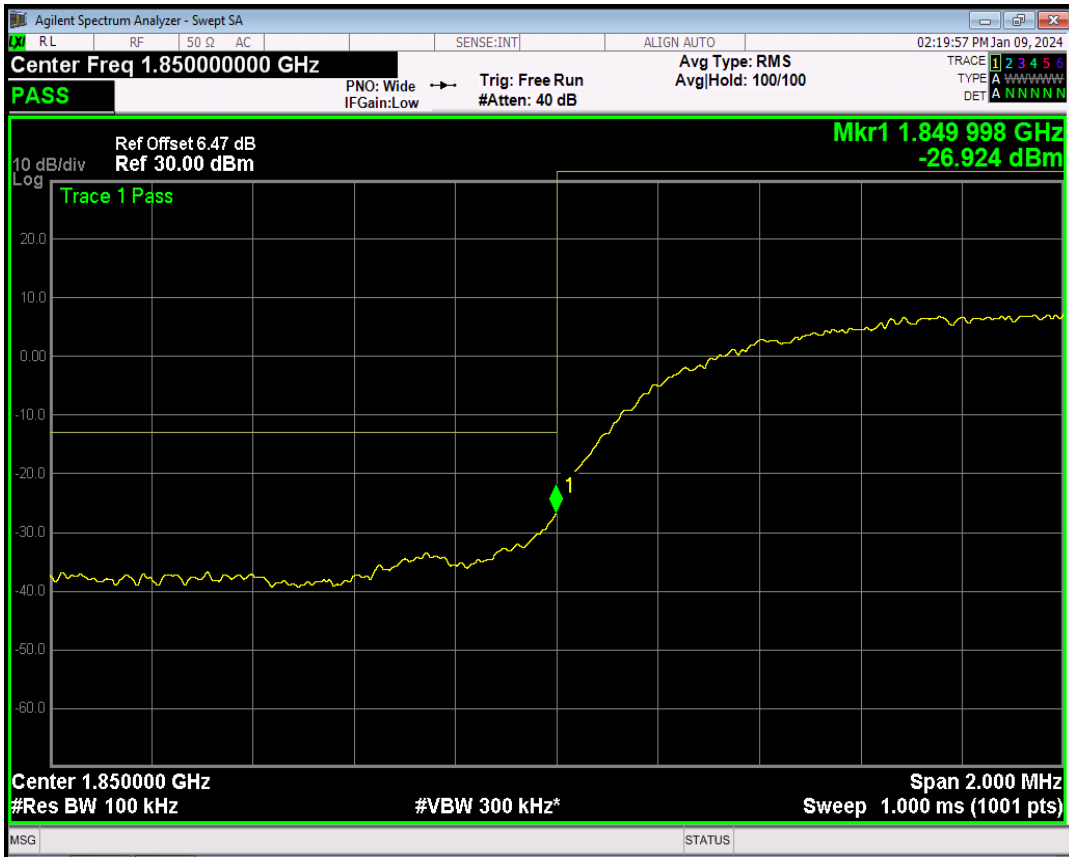

WCDMA Band2 Channel=9538



WCDMA Band5 Channel=4132

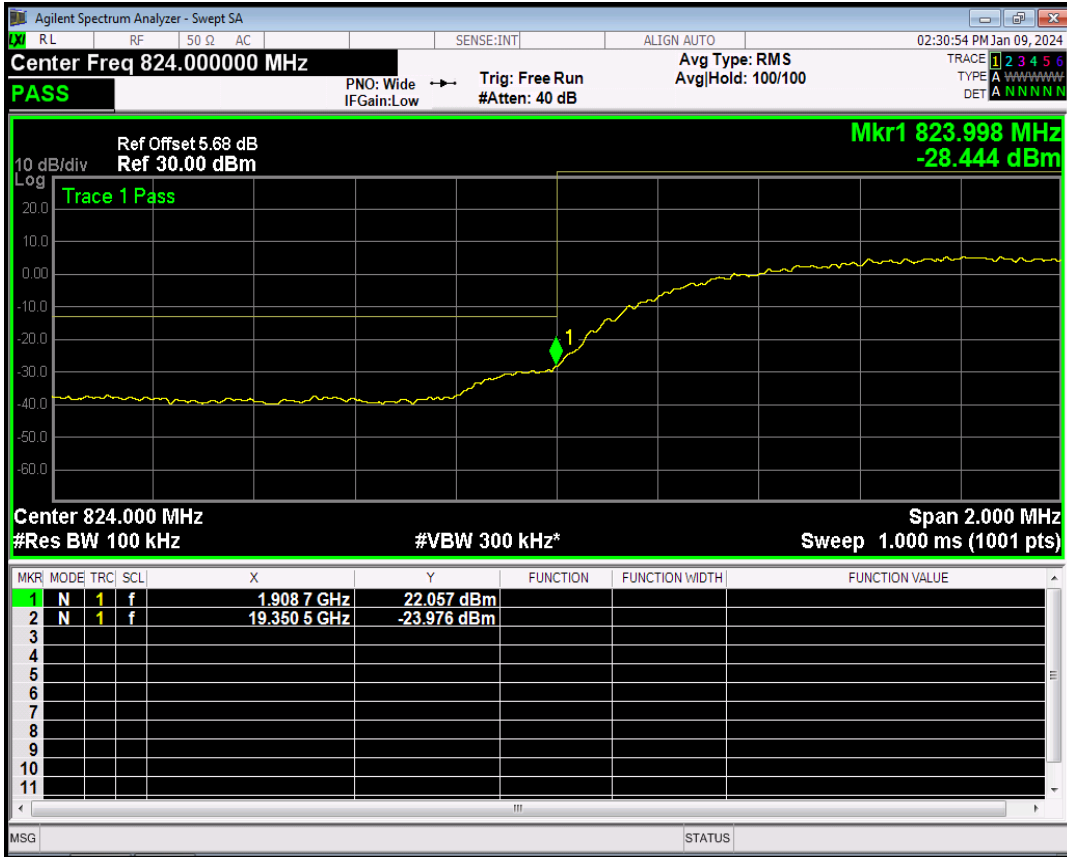

WCDMA Band5 Channel=4233

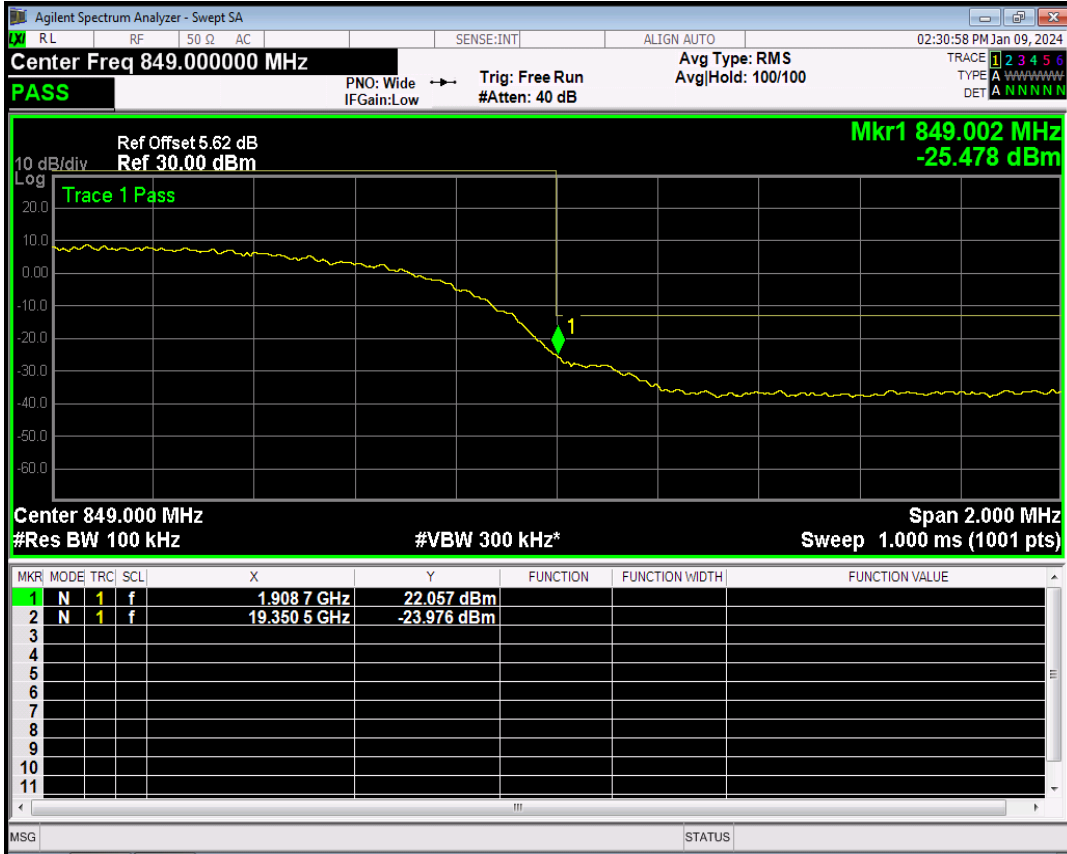

WCDMA Band2 Channel=9262

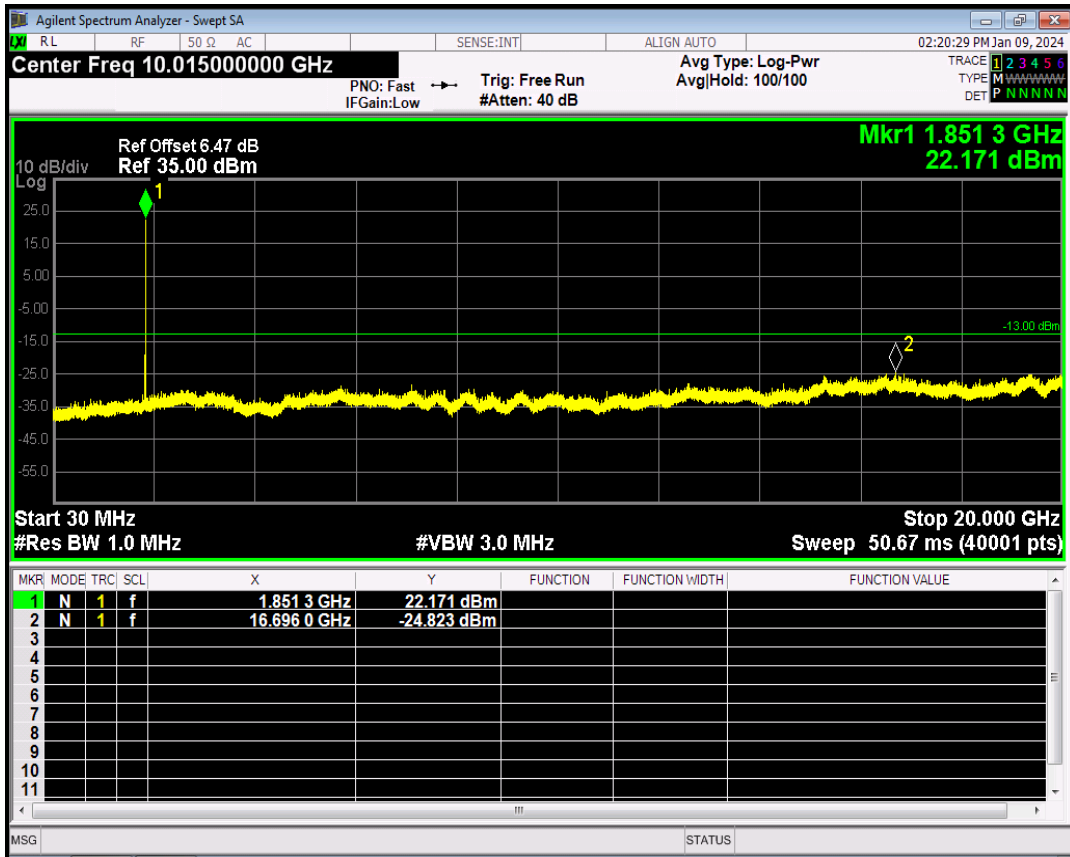

WCDMA Band2 Channel=9400

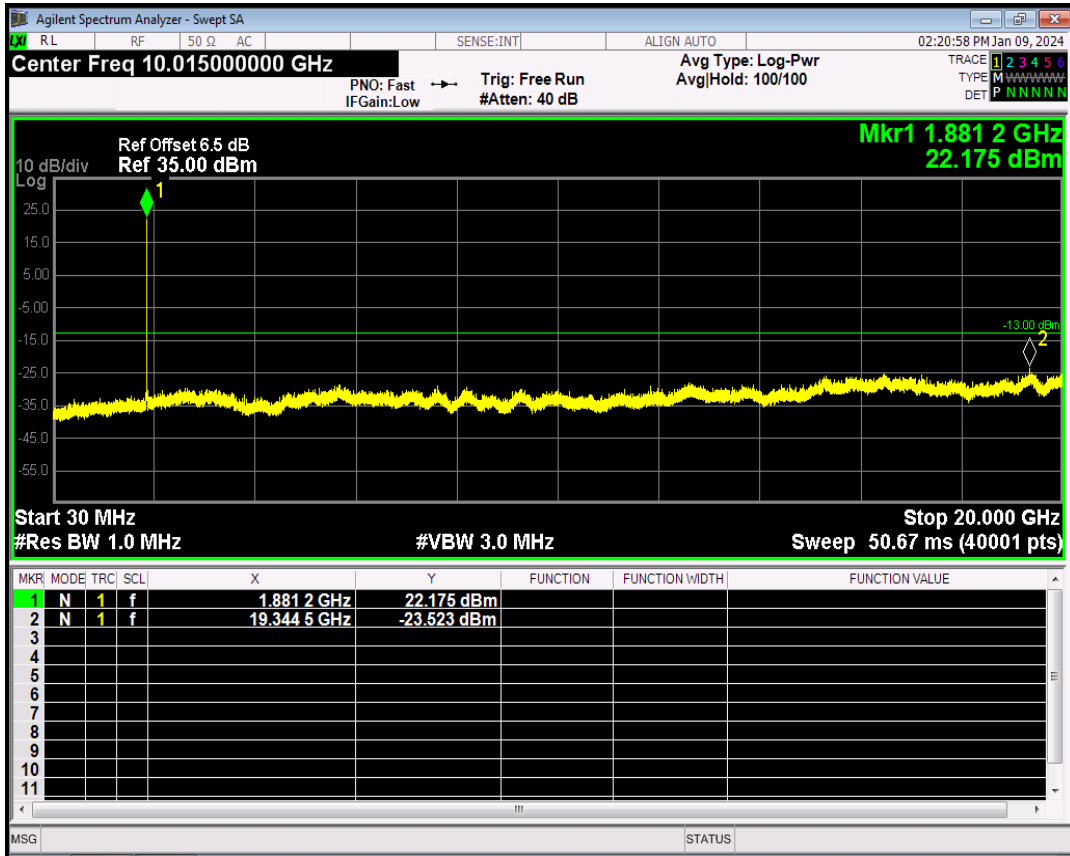

WCDMA Band2 Channel=9538

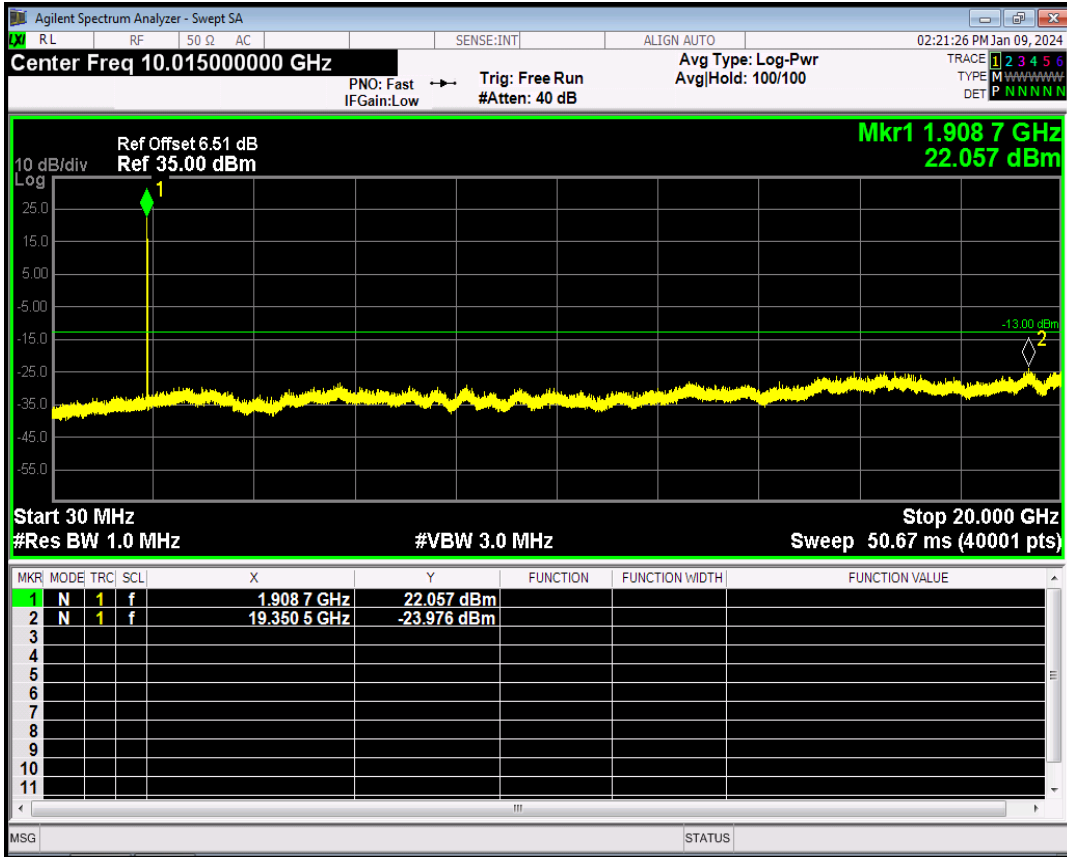

WCDMA Band5 Channel=4132

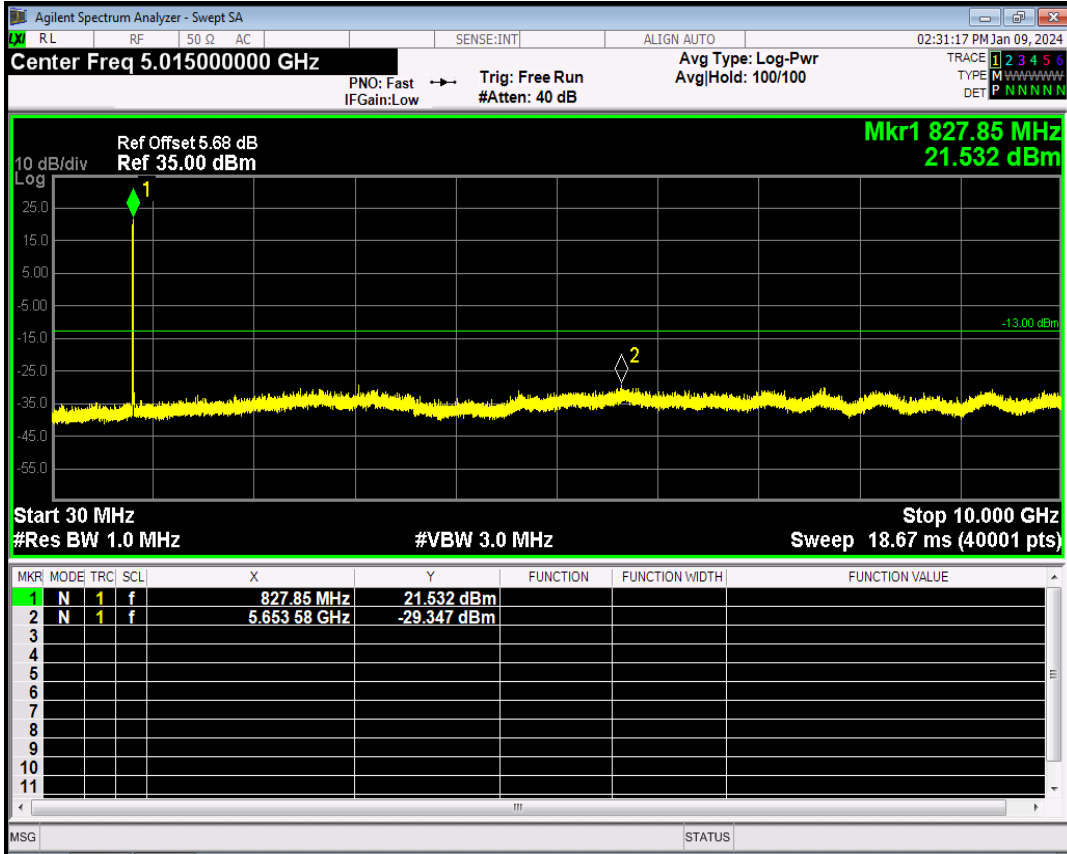

WCDMA Band5 Channel=4182

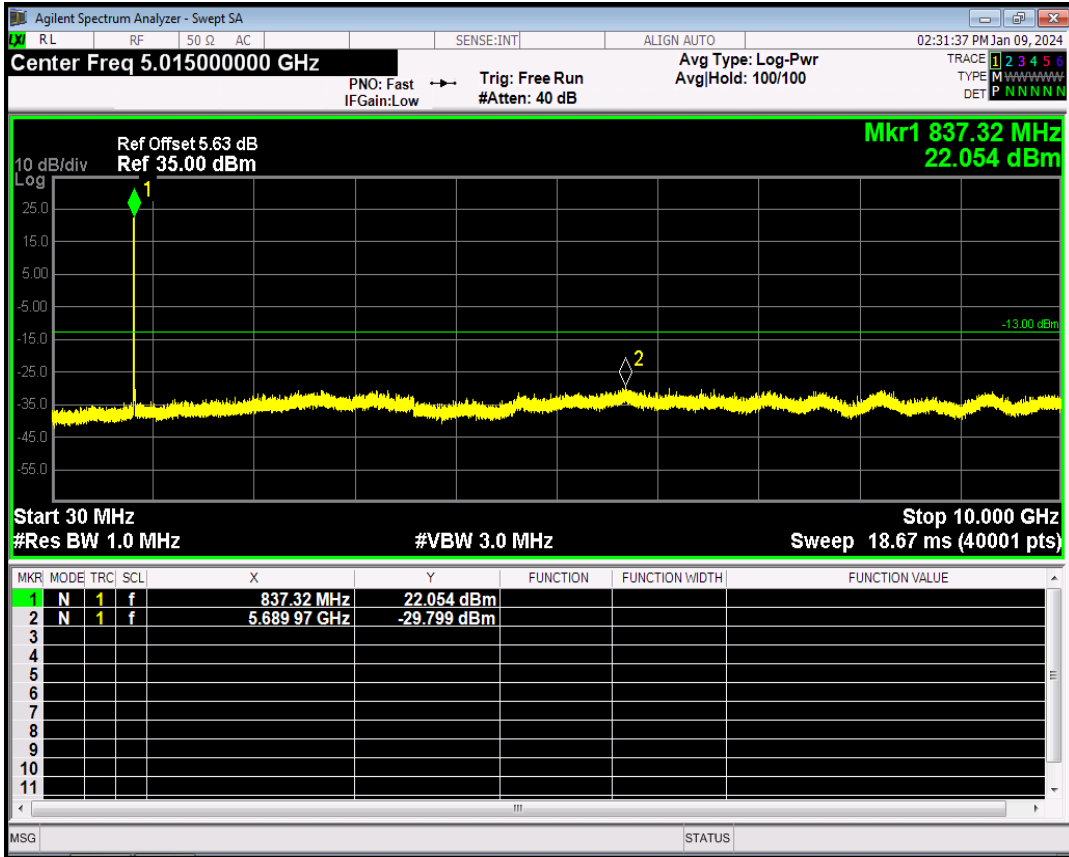

WCDMA Band5 Channel=4233

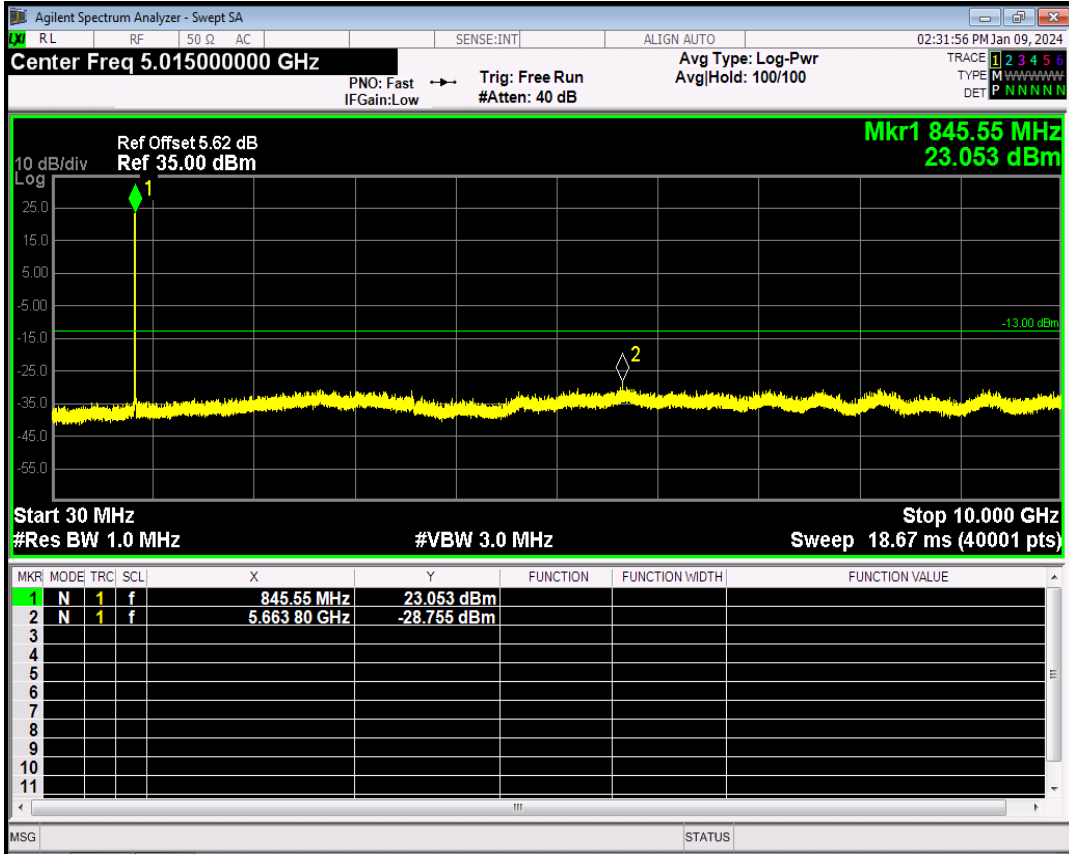

10. Spurious Radiated Emissions

10.1 Block Diagram Of Test Setup

(A) Radiated Emission Test-Up Frequency Below 30MHz

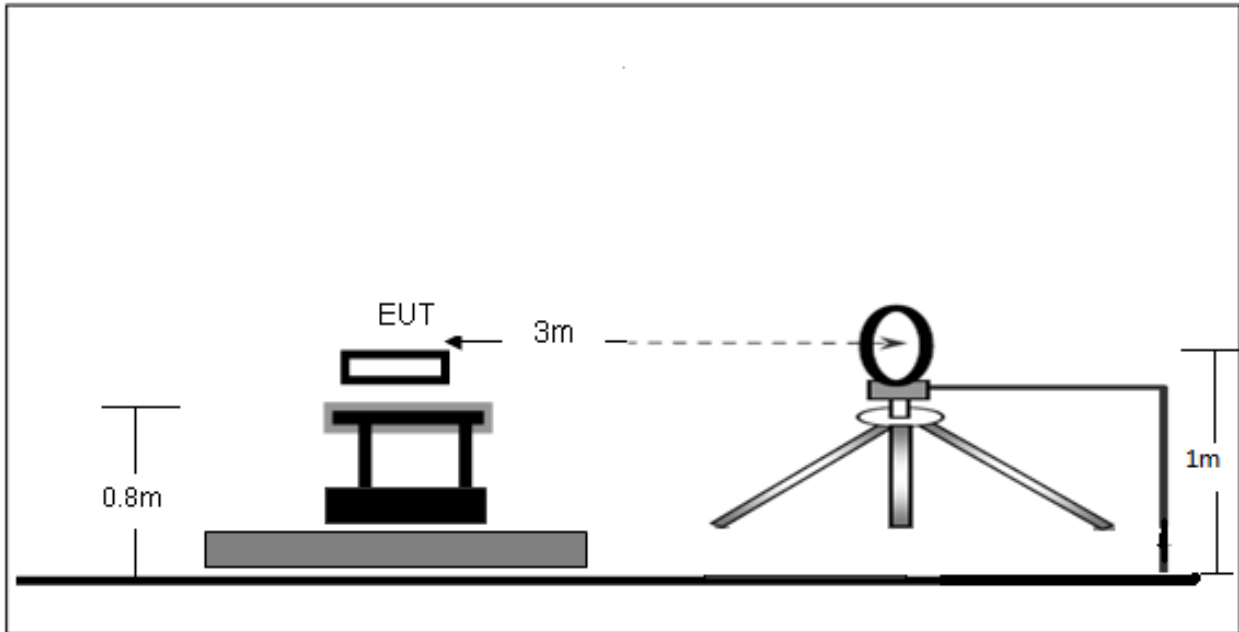

(B) Radiated Emission Test-Up Frequency 30MHz~1GHz

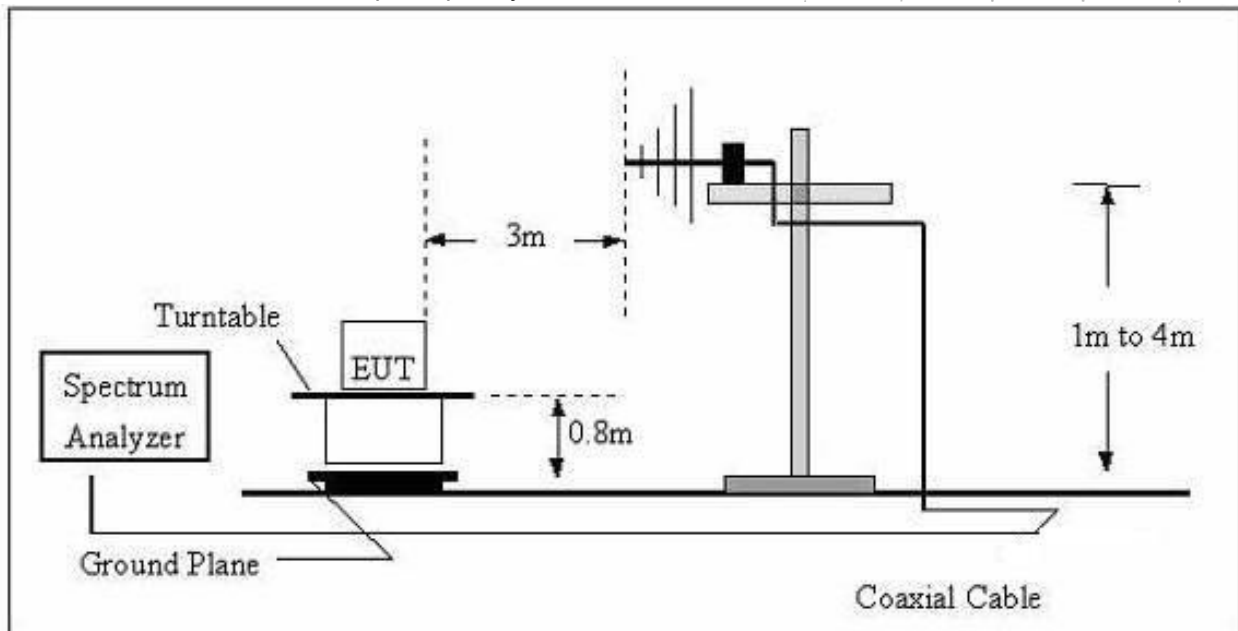

(C) Radiated Emission Test-Up Frequency Above 1GHz

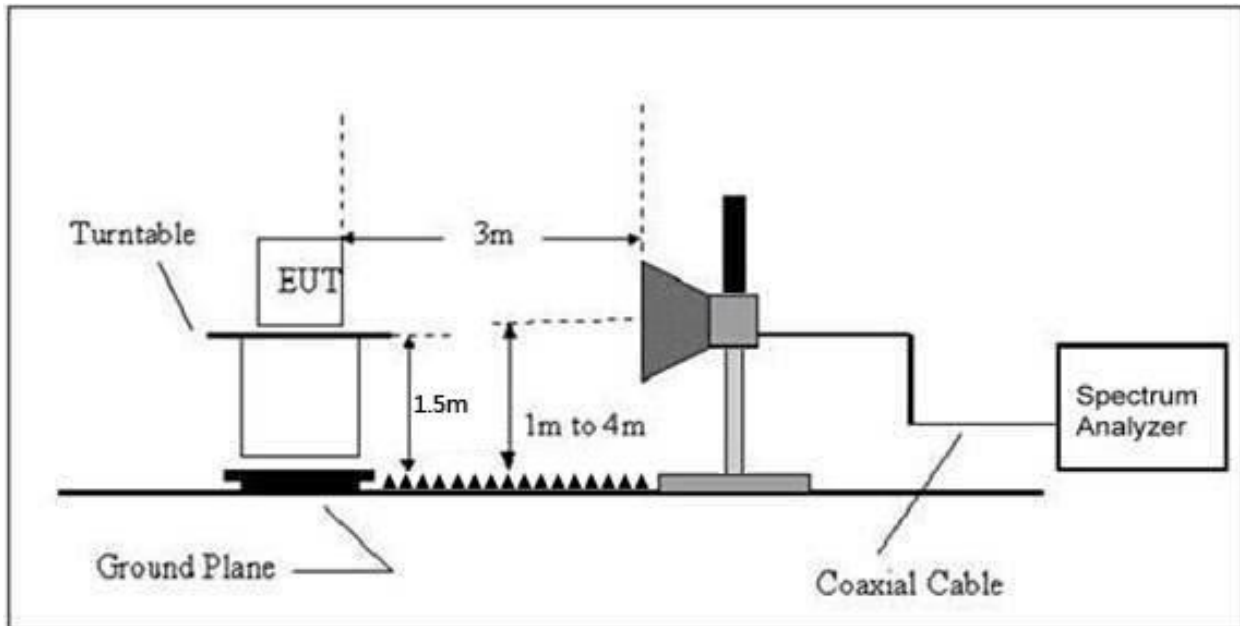

10.2 Limit

According to §22.917(a), the power of any emissions outside of the authorized operating frequency ranges must be attenuated below the transmitting power (P) by a factor of at least $43 + 10 \log(P)$ dB.

According to §24.238(a), the power of any emissions outside of the authorized operating frequency ranges must be attenuated below the transmitting power (P) by a factor of at least $43 + 10 \log(P)$ dB.

According to §27.53 (h), the power of any emission outside a licensee's frequency block shall be attenuated below the transmitter power (P) in watts by at least $43 + 10 \log_{10}(P)$ dB.

10.3 Test procedure

1. The setup of EUT is according with per ANSI/TIA Standard 603D and ANSI C63.4-2014 measurement procedure.
2. The measurement antenna was placed at a distance of 3 meters from the EUT. During the tests, the antenna height and polarization as well as EUT azimuth were varied in order to identify the maximum level of emissions from the EUT. The test was performed by placing the EUT on 3-orthogonal axis.
3. The frequency range up to tenth harmonic of the fundamental frequency was investigated.
4. Remove the EUT and replace it with substitution antenna. A signal generator was connected to the substitution antenna by a non-radiating cable. The absolute levels of the spurious emissions were measured by the substitution.

Spurious attenuation limit in dB = $43 + 10 \log_{10}(\text{power out in Watts})$

10.4 Test Result

For Cellular Band GSM850 Mode

Frequency (MHz)	Reading (dBm)	Correct dB	Result (dBm)	Limit (dBm)	Margin (dB)	Polar H/V
Low Channel (824.2MHz)						
82.53	-26.56	-30.57	-57.13	-13.00	-44.13	H
1648.40	-19.62	-27.29	-46.91	-13.00	-33.91	H
2472.60	-23.74	-25.18	-48.92	-13.00	-35.92	H
82.53	-31.17	-30.57	-61.74	-13.00	-48.74	V
1648.40	-18.04	-27.29	-45.33	-13.00	-32.33	V
2472.60	-26.97	-25.18	-52.15	-13.00	-39.15	V
Middle Channel (836.6MHz)						
82.53	-30.40	-30.57	-60.97	-13.00	-47.97	H
1673.20	-20.48	-27.32	-47.80	-13.00	-34.80	H
2509.80	-23.90	-25.07	-48.97	-13.00	-35.97	H
82.53	-42.02	-30.57	-72.59	-13.00	-59.59	V
1673.20	-18.91	-27.32	-46.23	-13.00	-33.23	V
2509.80	-26.44	-25.07	-51.51	-13.00	-38.51	V
High Channel (848.8MHz)						
82.53	-44.64	-30.57	-75.21	-13.00	-62.21	H
1697.60	-19.96	-27.27	-47.23	-13.00	-34.23	H
2546.40	-25.98	-24.96	-50.94	-13.00	-37.94	H
82.53	-42.64	-30.57	-73.21	-13.00	-60.21	V
1697.60	-20.75	-27.27	-48.02	-13.00	-35.02	V
2546.40	-24.78	-24.96	-49.74	-13.00	-36.74	V

For PCS Band GSM1900 Mode

Frequency (MHz)	Reading (dBm)	Correct dB	Result (dBm)	Limit (dBm)	Margin (dB)	Polar H/V
Low Channel (1850.2MHz)						
82.53	-32.30	-30.57	-62.87	-13.00	-49.87	H
3700.40	-26.01	-22.20	-48.21	-13.00	-35.21	H
5550.60	-32.73	-19.32	-52.05	-13.00	-39.05	H
82.53	-41.52	-30.57	-72.09	-13.00	-59.09	V
3700.40	-28.60	-22.20	-50.80	-13.00	-37.80	V
5550.60	-29.52	-19.32	-48.84	-13.00	-35.84	V
Middle Channel (1880MHz)						
82.53	-33.80	-30.57	-64.37	-13.00	-51.37	H
3760.00	-27.81	-22.08	-49.89	-13.00	-36.89	H
5640.00	-30.77	-19.28	-50.05	-13.00	-37.05	H
82.53	-43.63	-30.57	-74.20	-13.00	-61.20	V
3760.00	-29.93	-22.08	-52.01	-13.00	-39.01	V
5640.00	-28.23	-19.28	-47.51	-13.00	-34.51	V
High Channel (1909.8MHz)						
82.53	-34.05	-30.57	-64.62	-13.00	-51.62	H
3819.60	-26.98	-21.96	-48.94	-13.00	-35.94	H
5729.40	-31.62	-19.24	-50.86	-13.00	-37.86	H
82.53	-43.28	-30.57	-73.85	-13.00	-60.85	V
3819.60	-29.90	-21.96	-51.86	-13.00	-38.86	V
5729.40	-31.47	-19.24	-50.71	-13.00	-37.71	V

For Band WCDMA Band II Mode

Frequency (MHz)	Reading (dBm)	Correct dB	Result (dBm)	Limit (dBm)	Margin (dB)	Polar H/V
Low Channel (1852.4MHz)						
82.53	-42.40	-30.57	-72.97	-13.00	-59.97	H
3704.80	-25.24	-22.19	-47.43	-13.00	-34.43	H
5557.20	-30.70	-19.32	-50.02	-13.00	-37.02	H
82.53	-42.83	-30.57	-73.40	-13.00	-60.40	V
3704.80	-27.11	-22.19	-49.30	-13.00	-36.30	V
5557.20	-31.17	-19.32	-50.49	-13.00	-37.49	V
Middle Channel (1880MHz)						
82.53	-42.84	-30.57	-73.41	-13.00	-60.41	H
3760.00	-24.10	-22.08	-46.18	-13.00	-33.18	H
5640.00	-32.33	-19.28	-51.61	-13.00	-38.61	H
82.53	-43.15	-30.57	-73.72	-13.00	-60.72	V
3760.00	-26.58	-22.08	-48.66	-13.00	-35.66	V
5640.00	-31.70	-19.28	-50.98	-13.00	-37.98	V
High Channel (1907.6MHz)						
82.53	-42.56	-30.57	-73.13	-13.00	-60.13	H
3815.20	-24.95	-21.97	-46.92	-13.00	-33.92	H
5722.80	-29.79	-19.24	-49.03	-13.00	-36.03	H
82.53	-42.72	-30.57	-73.29	-13.00	-60.29	V
3815.20	-27.54	-21.97	-49.51	-13.00	-36.51	V
5722.80	-29.90	-19.24	-49.14	-13.00	-36.14	V

Note: Result=Reading+ Correct, Margin= Result- Limit

For Band WCDMA Band V Mode

Frequency (MHz)	Reading (dBm)	Correct dB	Result (dBm)	Limit (dBm)	Margin (dB)	Polar H/V
Low Channel (826.4MHz)						
82.53	-44.57	-30.57	-75.14	-13.00	-62.14	H
1652.80	-19.66	-27.36	-47.02	-13.00	-34.02	H
2479.20	-25.74	-25.16	-50.90	-13.00	-37.90	H
82.53	-42.83	-30.57	-73.40	-13.00	-60.40	V
1652.80	-18.56	-27.36	-45.92	-13.00	-32.92	V
2479.20	-23.77	-25.16	-48.93	-13.00	-35.93	V
Middle Channel (836.4MHz)						
82.53	-43.60	-30.57	-74.17	-13.00	-61.17	H
1672.80	-18.01	-27.32	-45.33	-13.00	-32.33	H
2509.20	-25.52	-25.07	-50.59	-13.00	-37.59	H
82.53	-41.29	-30.57	-71.86	-13.00	-58.86	V
1672.80	-18.99	-27.32	-46.31	-13.00	-33.31	V
2509.20	-23.68	-25.07	-48.75	-13.00	-35.75	V
High Channel (846.6MHz)						
82.53	-42.76	-30.57	-73.33	-13.00	-60.33	H
1693.20	-19.76	-27.27	-47.03	-13.00	-34.03	H
2539.80	-24.69	-24.98	-49.67	-13.00	-36.67	H
82.53	-41.66	-30.57	-72.23	-13.00	-59.23	V
1693.20	-20.59	-27.27	-47.86	-13.00	-34.86	V
2539.80	-23.84	-24.98	-48.82	-13.00	-35.82	V

Note: Result=Reading+ Correct, Margin= Result- Limit

Note: Testing is carried out with frequency rang 9kHz to the tenth harmonics, other than listed in the table above are attenuated more than 20dB below the permissible limits or the field strength is too small to be measured.

11. Frequency Stability

11.1 Block Diagram Of Test Setup

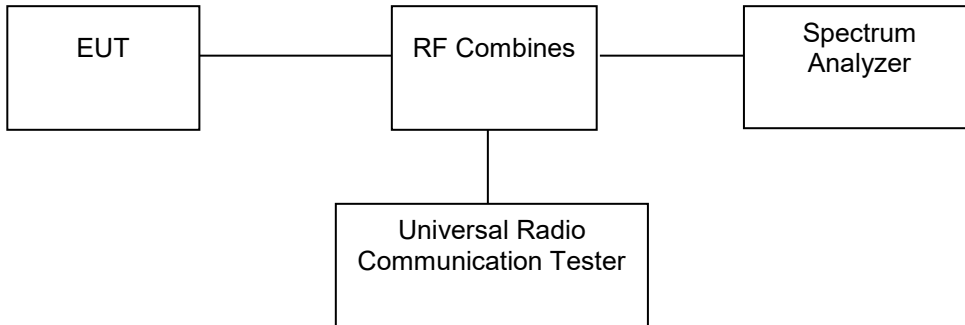

11.2 Limit

FCC Part 22.355 : ± 2.5 ppm

FCC Part 24.235 :

The frequency stability shall be sufficient to ensure that the fundamental emission stays within the authorized frequency block.

FCC Part 27.54

The frequency stability shall be sufficient to ensure that the fundamental emissions stay within the authorized bands of operation.

11.3 Test procedure

1. The testing follows FCC KDB 971168 D01v03r01 Section 9.0.
2. The EUT was set up in the thermal chamber and connected with the system simulator.
3. With power OFF, the temperature was decreased to -30°C and the EUT was stabilized before testing. Power was applied and the maximum change in frequency was recorded within one minute.
4. With power OFF, the temperature was raised in 10°C steps up to 50°C . The EUT was stabilized at each step for at least half an hour. Power was applied and the maximum frequency change was recorded within one minute.

Test Procedures for Voltage Variation

1. The testing follows FCC KDB 971168 D01v03r01 Section 9.0.
2. The EUT was placed in a temperature chamber at $25 \pm 5^{\circ}\text{C}$ and connected with the system simulator.
3. The power supply voltage to the EUT was varied from BEP to 115% of the nominal value measured at the input to the EUT.
4. The variation in frequency was measured for the worst case.

11.4 Test Result

Operation Mode	Channel Number	Test Condition		Channel Frequency (MHz)	Freq.Dev. (Hz)	Deviation (ppm)	Limit (ppm)
		Voltage (V)	Temp (°C)				
GSM850	190	VN	-30	836.60	5.72	0.0068	2.5
			-20	836.60	2.97	0.0035	2.5
			-10	836.60	4.79	0.0057	2.5
			0	836.60	2.04	0.0024	2.5
			10	836.60	3.68	0.0044	2.5
			20	836.60	-1.66	-0.0020	2.5
			30	836.60	0.75	0.0009	2.5
			40	836.60	6.20	0.0074	2.5
			50	836.60	0.47	0.0006	2.5
		VL	20	836.60	6.46	0.0077	2.5
VH	20	836.60	1.98	0.0024	2.5		
VERDICT				PASS			

Operation Mode	Channel Number	Test Condition		Channel Frequency (MHz)	Freq.Dev. (Hz)	Deviation (ppm)	Limit (ppm)
		Voltage (V)	Temp (°C)				
GSM1900	512	VN	-30	1850.20	14.49	0.0078	Note 3
			-20	1850.20	17.77	0.0096	Note 3
			-10	1850.20	14.92	0.0081	Note 3
			0	1850.20	19.70	0.0106	Note 3
			10	1850.20	14.67	0.0079	Note 3
			20	1850.20	14.00	0.0076	Note 3
			30	1850.20	11.11	0.0060	Note 3
			40	1850.20	15.78	0.0085	Note 3
			50	1850.20	13.74	0.0074	Note 3
		VL	20	1850.20	10.23	0.0055	Note 3
VH	20	1850.20	17.67	0.0096	Note 3		
VERDICT				PASS			

Note: VN Voltage:3.7V; VL Voltage: 3.33V; VH Voltage:4.07V

All modes have been tested, and the worst result recorded was report as below

Operation Mode	Channel Number	Test Condition		Channel Frequency (MHz)	Freq.Dev. (Hz)	Deviation (ppm)	Limit (ppm)
		Voltage (V)	Temp (°C)				
WCDMA850	4132	VN	-30	836.40	19.32	0.0231	2.5
			-20	836.40	13.09	0.0157	2.5
			-10	836.40	19.84	0.0237	2.5
			0	836.40	12.46	0.0149	2.5
			10	836.40	12.63	0.0151	2.5
			20	836.40	12.30	0.0147	2.5
			30	836.40	11.45	0.0137	2.5
			40	836.40	14.62	0.0175	2.5
			50	836.40	13.80	0.0165	2.5
		VL	20	836.40	15.43	0.0184	2.5
		VH	20	836.40	10.51	0.0126	2.5
VERDICT				PASS			

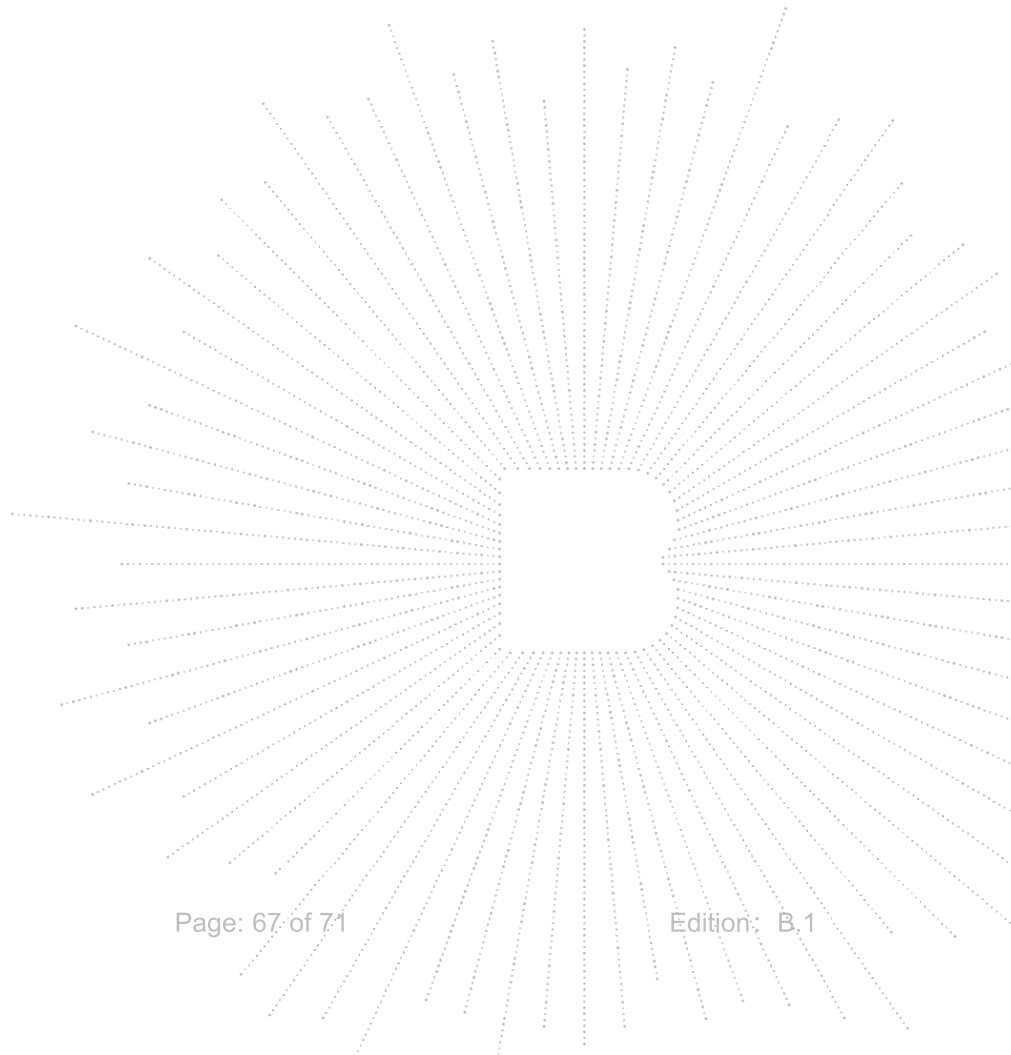

Operation Mode	Channel Number	Test Condition		Channel Frequency (MHz)	Freq.Dev. (Hz)	Deviation (ppm)	Limit (ppm)
		Voltage (V)	Temp (°C)				
WCDMA1900	9262	VN	-30	1852.40	13.36	0.0072	Note 4
			-20	1852.40	18.21	0.0098	Note 4
			-10	1852.40	12.21	0.0066	Note 4
			0	1852.40	17.35	0.0094	Note 4
			10	1852.40	18.77	0.0101	Note 4
			20	1852.40	10.38	0.0056	Note 4
			30	1852.40	14.59	0.0079	Note 4
			40	1852.40	19.58	0.0106	Note 4
			50	1852.40	14.42	0.0078	Note 4
		VL	20	1852.40	13.79	0.0074	Note 4
		VH	20	1852.40	19.48	0.0105	Note 4
VERDICT				PASS			

Note 1: All modes have been tested with GSM.

Note 2: All modes have been tested, and the worst result recorded was report as below

Note 3: The frequency stability shall be sufficient to ensure that the fundamental emission stays within the authorized frequency block.

Note 4: The frequency stability shall be sufficient to ensure that the fundamental emissions stay within the authorized bands of operation.

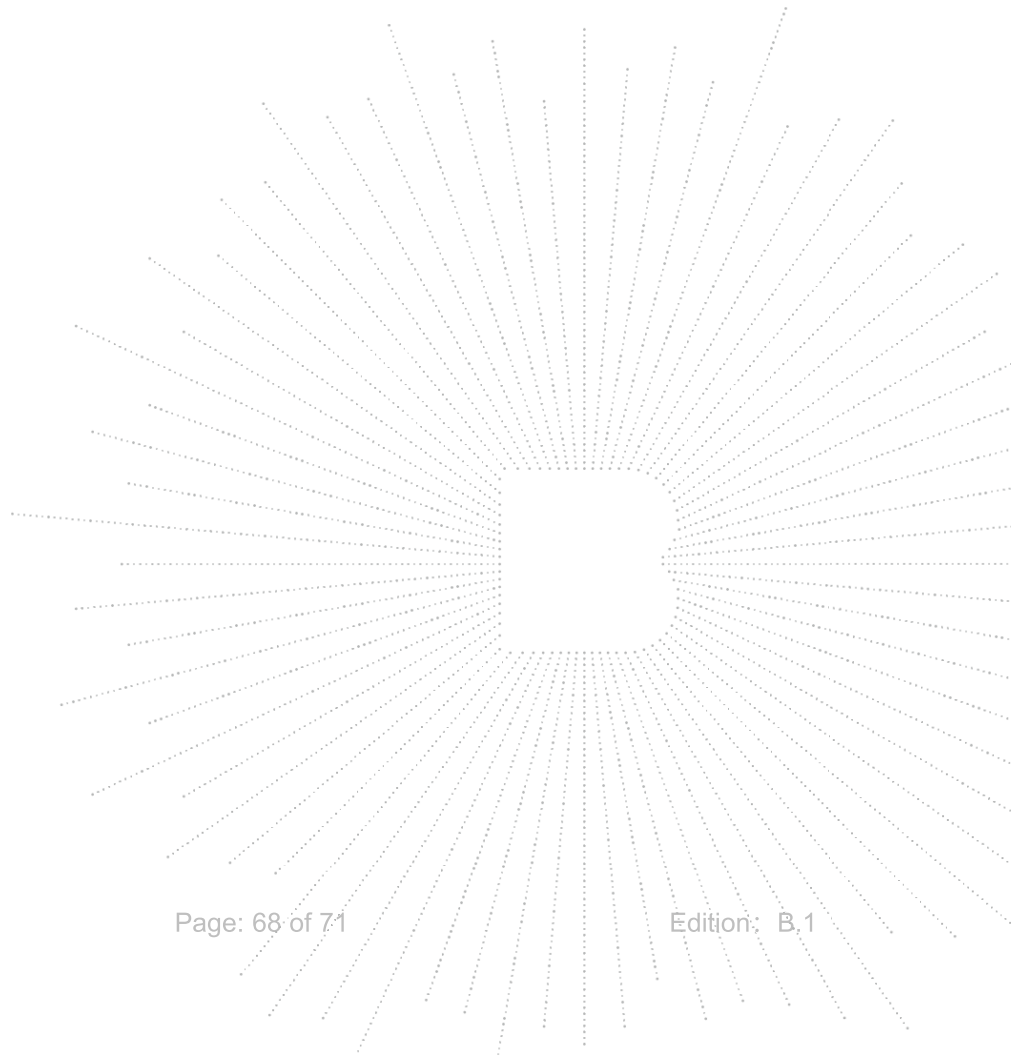

12. EUT Photographs

EUT Photo 1



EUT Photo 2



13. EUT Test Setup Photographs

Radiated Measurement Photos

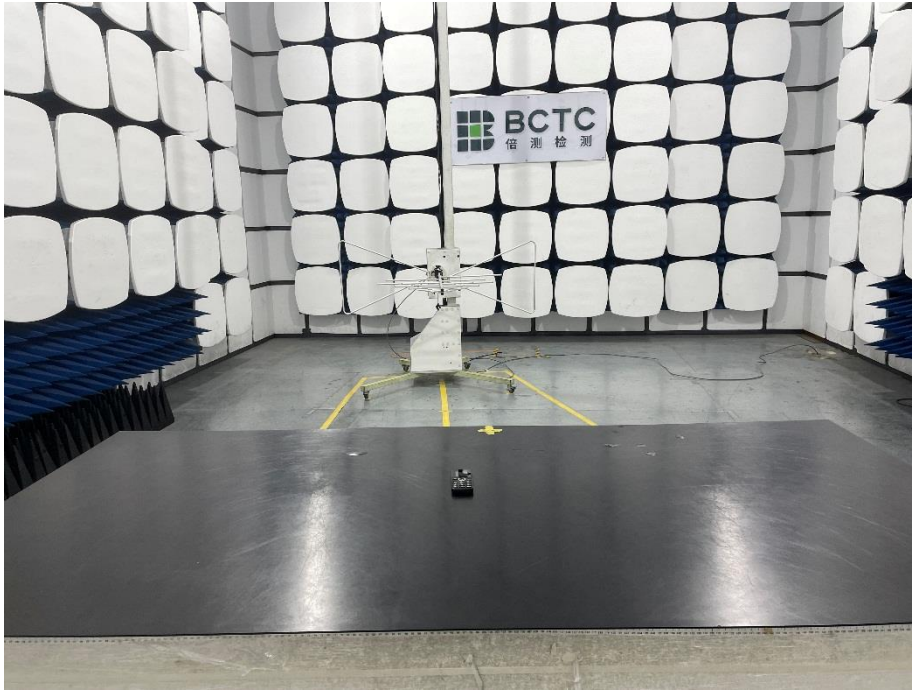

STATEMENT

1. The equipment lists are traceable to the national reference standards.
2. The test report can not be partially copied unless prior written approval is issued from our lab.
3. The test report is invalid without the "special seal for inspection and testing".
4. The test report is invalid without the signature of the approver.
5. The test process and test result is only related to the Unit Under Test.
6. Sample information is provided by the client and the laboratory is not responsible for its authenticity.
7. The quality system of our laboratory is in accordance with ISO/IEC17025.
8. If there is any objection to this test report, the client should inform issuing laboratory within 15 days from the date of receiving test report.

Address:

1-2/F., Building B, Pengzhou Industrial Park, No.158, Fuyuan 1st Road, Zhancheng, Fuhai Subdistrict, Bao'an District, Shenzhen, Guangdong, China

TEL: 400-788-9558

P.C.: 518103

FAX: 0755-33229357

Website: <http://www.chnbctc.com>

E-Mail: bctc@bctc-lab.com.cn

***** END *****