

# FCC RADIO TEST REPORT

## FCC ID: 2ADX3I282

**Product :** LTE Router  
**Trade Mark :** Horizon  
**Model Name :** I282  
**Family Model :** N/A  
**Report No. :** S21012102004002

### Prepared for

Telecell Mobile (H.K) Ltd.  
RM 801 Metro Ctr II, 21 Lam Hing Street Kln Bay Hong Kong

### Prepared by

Shenzhen NTEK Testing Technology Co., Ltd.  
1/F, Building E, Fenda Science Park, Sanwei Community,  
Xixiang Street Bao'an District, Shenzhen 518126 P.R. China  
Tel.: 400-800-6106, 0755-2320 0050 / 2320 0090  
Website: <http://www.ntek.org.cn>

### TEST RESULT CERTIFICATION

**Applicant's name** ..... Telecell Mobile (H.K) Ltd.  
**Address** ..... RM 801 Metro Ctr II, 21 Lam Hing Street Kln Bay Hong Kong  
**Manufacturer's Name** .... Telecell Mobile (H.K) Ltd.  
**Address** ..... RM 801 Metro Ctr II, 21 Lam Hing Street Kln Bay Hong Kong

**Product description**

**Product name**..... LTE Router  
**Model and/or type reference** ..... I282  
**Family Model**..... N/A

**Standards** ..... FCC Part15.407

**Test procedure** ..... ANSI C63.10-2013 and KDB 789033 D02 General UNII Test Procedures New Rules v02r01  
 FCC KDB 662911 D01 Multiple Transmitter Output v02r01

This device described above has been tested by NTEK, and the test results show that the equipment under test (EUT) is in compliance with the FCC requirements/ the Industry Canada requirements.. And it is applicable only to the tested sample identified in the report.

This report shall not be reproduced except in full, without the written approval of NTEK, this document may be altered or revised by NTEK, personnel only, and shall be noted in the revision of the document.

**Date of Test**.....

Date (s) of performance of tests ..... 21 Jan. 2021 ~ 17 Mar. 2021

Date of Issue..... 17 Mar. 2021

Test Result..... **Pass**

Testing Engineer :   
 \_\_\_\_\_  
 (Mary Hu)

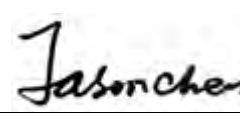
Technical Manager :   
 \_\_\_\_\_  
 (Jason Chen)

Authorized Signatory :   
 \_\_\_\_\_  
 (Alex Li)

**Table of Contents**

	<b>Page</b>
<b>1 . SUMMARY OF TEST RESULTS</b>	<b>5</b>
1.1 FACILITIES AND ACCREDITATIONS	6
1.2 MEASUREMENT UNCERTAINTY	6
<b>2 . GENERAL INFORMATION</b>	<b>7</b>
2.1 GENERAL DESCRIPTION OF EUT	7
2.2 DESCRIPTION OF TEST MODES	10
2.3 BLOCK DIGRAM SHOWING THE CONFIGURATION OF SYSTEM TESTED	11
2.4 DESCRIPTION OF SUPPORT UNITS(CONDUCTED MODE)	12
2.5 EQUIPMENTS LIST FOR ALL TEST ITEMS	13
<b>3 . TEST REQUIREMENTS</b>	<b>15</b>
3.1 CONDUCTED EMISSION MEASUREMENT	15
3.2 RADIATED EMISSION MEASUREMENT	18
3.3 POWER SPECTRAL DENSITY TEST	27
3.4 26DB & 99% EMISSION BANDWIDTH	30
3.5 MINIMUM 6 DB BANDWIDTH	32
3.6 MAXIMUM CONDUCTED OUTPUT POWER	34
3.7 OUT OF BAND EMISSIONS	38
3.8 SPURIOUS RF CONDUCTED EMISSIONS	40
3.9 FREQUENCY STABILITY MEASUREMENT	41
<b>4. ANTENNA REQUIREMENT</b>	<b>45</b>
4.1 STANDARD REQUIREMENT	45
4.2 EUT ANTENNA	45
<b>5. TEST RESULTS</b>	<b>46</b>
5.1DUTY CYCLE	46
5.2MAXIMUM CONDUCTED OUTPUT POWER	67
5.3-6DB EMISSION BANDWIDTH	68
5.4OCCUPIED CHANNEL BANDWIDTH	95
5.5MAXIMUM POWER SPECTRAL DENSITY LEVEL	147
5.6BAND EDGE	174
5.7CONDUCTED RF SPURIOUS EMISSION	193



**1. SUMMARY OF TEST RESULTS**

Test procedures according to the technical standards:

<b>FCC Part15 (15.407) , Subpart E</b>			
Standard Section	Test Item	Judgment	Remark
15.207	AC Power Line Conducted Emissions	PASS	
15.209(a), 15.407 (b)(4) 15.407 (b)(8)	Spurious Radiated Emissions	PASS	
15.407 (a)(3)	26 dB and 99% Emission Bandwidth	PASS	
15.407(e)	Minimum 6 dB bandwidth	PASS	
15.407 (a)(3)	Maximum Conducted Output Power	PASS	
15.407(b)(4)	Band Edge	PASS	
15.407 (a)(3)	Power Spectral Density	PASS	
15.407(b)	Spurious Emissions at Antenna Terminals	PASS	
15.203	Antenna Requirement	PASS	

NOTE:

(1) "N/A" denotes test is not applicable in this Test Report

**1.1 FACILITIES AND ACCREDITATIONS**

**FACILITIES**

All measurement facilities used to collect the measurement data are located at 1/F, Building E, Fenda Science Park, Sanwei Community, Xixiang Street, Bao'an District, Shenzhen 518126 P.R. China.

The sites are constructed in conformance with the requirements of ANSI C63.7, ANSI C63.10 and CISPR Publication 22.

**LABORATORY ACCREDITATIONS AND LISTINGS**

Site Description

CNAS-Lab. : The Certificate Registration Number is L5516.

IC-Registration : The Certificate Registration Number is 9270A.  
CAB identifier:CN0074

FCC- Accredited : Test Firm Registration Number: 463705.  
Designation Number: CN1184

A2LA-Lab. : The Certificate Registration Number is 4298.01  
This laboratory is accredited in accordance with the recognized International Standard ISO/IEC 17025:2005 General requirements for the competence of testing and calibration laboratories.  
This accreditation demonstrates technical competence for a defined scope and the operation of a laboratory quality management system (refer to joint ISO-ILAC-IAF Communiqué dated 8 January 2009).

Name of Firm : Shenzhen NTEK Testing Technology Co., Ltd.

Site Location : 1/F, Building E, Fenda Science Park, Sanwei Community, Xixiang Street, Bao'an District, Shenzhen 518126 P.R. China.

**1.2 MEASUREMENT UNCERTAINTY**

The reported uncertainty of measurement  $y \pm U$ , where expanded uncertainty  $U$  is based on a standard uncertainty multiplied by a coverage factor of  $k=2$ , providing a level of confidence of approximately 95 %.

No.	Item	Uncertainty
1	Conducted Emission Test	$\pm 2.80\text{dB}$
2	RF power, conducted	$\pm 0.16\text{dB}$
3	Spurious emissions, conducted	$\pm 0.21\text{dB}$
4	All emissions, radiated(30MHz~1GHz)	$\pm 2.64\text{dB}$
5	All emissions, radiated(1GHz~6GHz)	$\pm 2.40\text{dB}$
6	All emissions, radiated( > 6GHz)	$\pm 2.52\text{dB}$
7	Temperature	$\pm 0.5^\circ\text{C}$
8	Humidity	$\pm 2\%$

**2. GENERAL INFORMATION**  
**2.1 GENERAL DESCRIPTION OF EUT**

Equipment	LTE Router		
Trade Mark	Horizon		
Model Name	I282		
Family Model	N/A		
Model Difference	N/A		
FCC ID	2ADX3I282		
Product Description	IEEE 802.11 WLAN Mode Supported	<input checked="" type="checkbox"/> 802.11a/n/ac (20MHz channel bandwidth) <input checked="" type="checkbox"/> 802.11n/ac (40MHz channel bandwidth) <input checked="" type="checkbox"/> 802.11ac (80MHz channel bandwidth)	
	Data Rate	802.11a: 6,9,12,18,24,36,48,54Mbps; 802.11n(HT20/HT40):MCS0-MCS15; 802.11ac(VHT20):MCS0-MCS8; 802.11ac(VHT40/VHT80):MCS0-MCS9;	
	Modulation	OFDM with BPSK/QPSK/16QAM/64QAM/256QAM for 802.11a/n/ac;	
	Operating Frequency Range	<input type="checkbox"/> 5180-5240MHz for 802.11a/n(HT20) / ac(VHT20); 5190-5230MHz for 802.11n(HT40)/ac(VHT40); 5210MHz for 802.11ac(VHT80) <input checked="" type="checkbox"/> 5745-5825 MHz for 802.11a/n(HT20)/ ac(VHT20); 5755-5795 MHz for 802.11a/n(HT40)/ ac(VHT40); 5775MHz for 802.11ac(VHT80);	
	Number of Channels	<input type="checkbox"/> 4 channels for 802.11a/n20/ac20 in the 5180-5240MHz band ; 2 channels for 802.11 n40/ac40 in the 5190-5230MHz band ; 1 channels for 802.11 ac80 in the 5210MHz band ; <input checked="" type="checkbox"/> 5 channels for 802.11a/n20/ac20 in the 5745-5825MHz band ; 2 channels for 802.11 n40/ac40 in the 5755-5795MHz band ; 1 channels for 802.11 ac80 in the 5775MHz band ;	
	Device Type	Client Device	
	Antenna Type	Antenna 1:Whip Antenna Antenna 2:Whip Antenna	
	Antenna Gain	Antenna 1:1.8dBi Antenna 2:1.8dBi	
	Based on the application, features, or specification exhibited in User's Manual, More details of EUT technical specification, please refer to the User's Manual.		
	Ratings	DC 12V from adapter	
Adapter	MODEL: SA18V-120150U INPUT:100V~240V~50/60Hz 0.5A OUTPUT:12V---1.5A		
Connecting I/O Port(s)	Please refer to the User's Manual		
HW Version	SLT868_Q_V1.03_PCB		
SW Version	I282S_1.0.9_EQ100		

Note:

1. For a more detailed features description, please refer to the manufacturer's specifications or the User's Manual.
2. Frequency and Channel list for 802.11a/n/ac(20 MHz) band IV (5745-5825MHz):

802.11a/n/ac( 20 MHz) Carrier Frequency Channel							
Channel	Frequency (MHz)	Channel	Frequency (MHz)	Channel	Frequency (MHz)	Channel	Frequency (MHz)
149	5745	153	5765	157	5785	161	5805
165	5825	-	-	-	-	-	-

Frequency and Channel list for 802.11n/ac(40MHz) band IV (5755-5795MHz):

802.11n/ac(40MHz) Carrier Frequency Channel					
Channel	Frequency (MHz)	Channel	Frequency (MHz)	Channel	Frequency (MHz)
151	5755	159	5795	-	-

Frequency and Channel list for 802.11ac(80MHz) band IV (5775MHz):

802.11ac(80MHz) Carrier Frequency Channel					
Channel	Frequency (MHz)	Channel	Frequency (MHz)	Channel	Frequency (MHz)
155	5775			-	-



Table for Filed Antenna

Antenna	Brand	Model Name	Antenna Type	Connector	Gain (dBi)	NOTE
1	N/A	N/A	Whip Antenna	IPEX	1.8	Wifi Antenna
2	N/A	N/A	Whip Antenna	IPEX	1.8	Wifi Antenna

This EUT has supports WIFI2.4G / 5G.

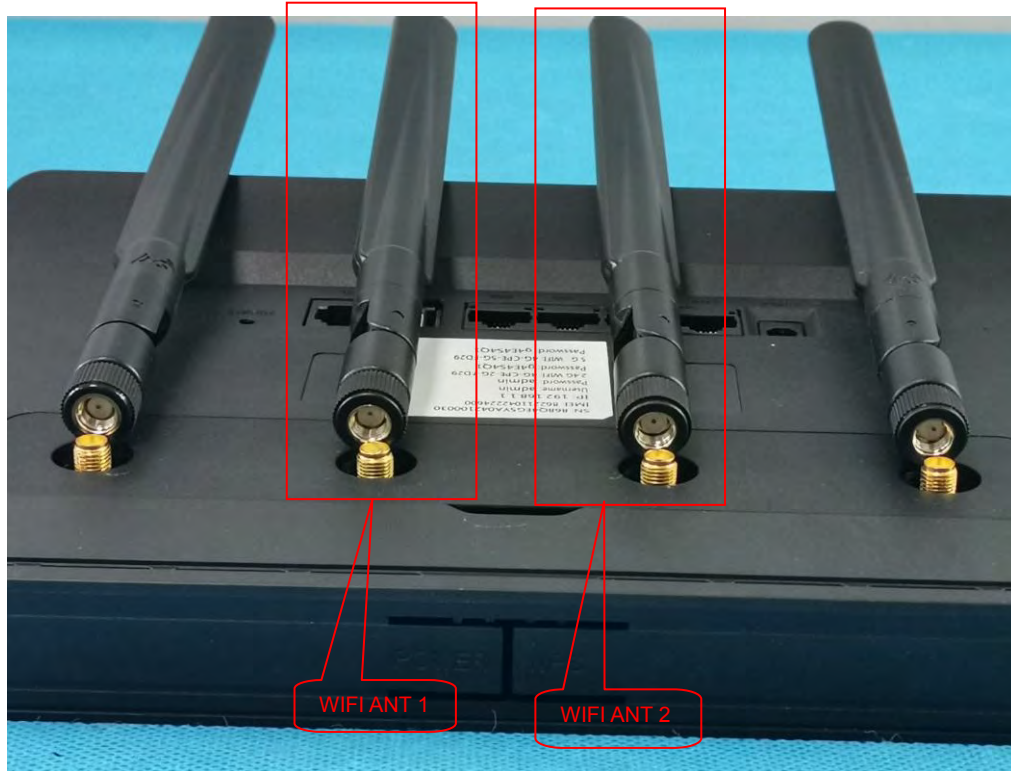

The module 5G WIFI has two antennas, and different modes support different transmit mode what describe as Following form:

Mode	Tx/Rx
802.11a	1TX, 1RX
802.11n/ac	2TX, 2RX

For 5GHz mode, Antenna 1,2 are transmitting, each with the same directional gain.  
 ANT 1 and ANT 2 are correlated with each other, each with the same directional gain  $G_{ANT}$ : 1.8dBi  
 Directional gain= $G_{ANT}+10\log(N_{ANT})$ dBi  
 For MIMO mode, Directional gain= $1.8+10\log(2)$ dBi=1.81dBi in 5.8GHz band.

Note:  $G_{ANT}$  means antenna gain for ANT in dBi.  
 $N_{ANT}$  means the number of Antennas.

**2.2 DESCRIPTION OF TEST MODES**

To investigate the maximum EMI emission characteristics generates from EUT, the test system was pre-scanning tested base on the consideration of following EUT operation mode or test configuration mode which possible have effect on EMI emission level. Each of these EUT operation mode(s) or test configuration mode(s) mentioned above was evaluated respectively.

Pretest Mode	Description
Mode 1	Normal Link Mode
Mode 2	802.11a / n 20 /ac 20 CH36/ CH40/ CH 48 802.11a / n 20 / ac 20 CH149/ CH157/ CH 165
Mode 3	802.11n40 / ac40 CH38/ CH 46 802.11n 40 / ac 40 CH 151 / CH 159
Mode 4	802.11ac80 CH 42 802.11ac 80 CH 155

For Radiated Emission	
Final Test Mode	Description
Mode 1	Normal Link Mode
Mode 2	802.11a / n 20 /ac 20 CH36/ CH40/ CH 48 802.11a / n 20 / ac 20 CH149/ CH157/ CH 165
Mode 3	802.11n40 / ac40 CH38/ CH 46 802.11n 40 / ac 40 CH 151 / CH 159
Mode 4	802.11ac80 CH 42 802.11ac 80 CH 155

Note:

- (1) The measurements are performed at the highest, middle, lowest available channels.
- (2) The measurements are performed at all Bit Rate of Transmitter, the worst data was reported

**2.3 BLOCK DIGRAM SHOWING THE CONFIGURATION OF SYSTEM TESTED**

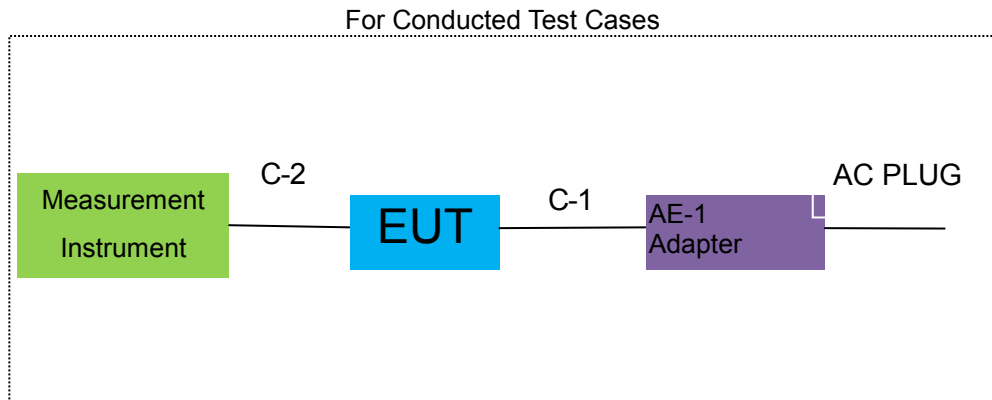
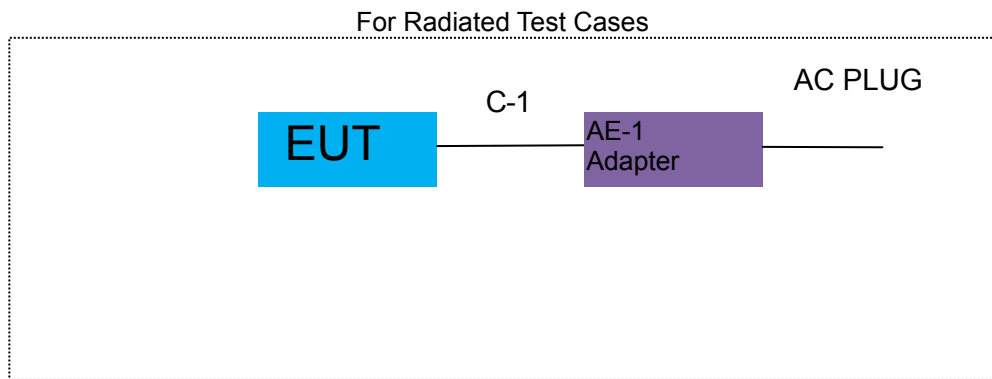
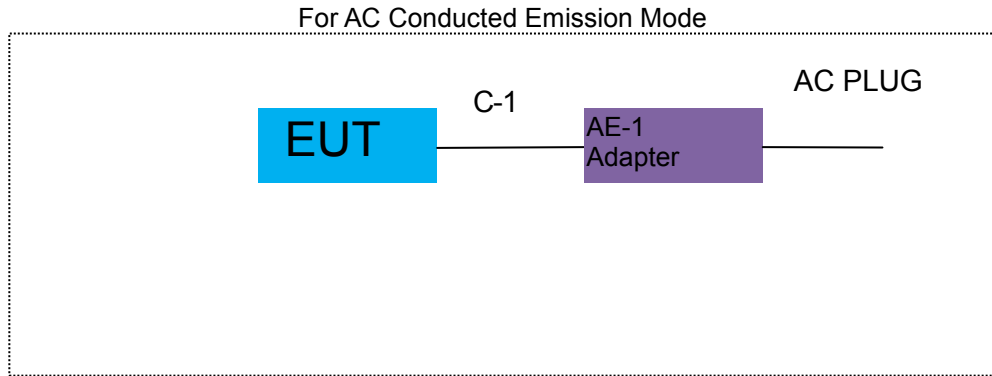

Note: 1. The temporary antenna connector is soldered on the PCB board in order to perform conducted tests and this temporary antenna connector is listed in the equipment list.  
 2. EUT built-in battery-powered, the battery is fully-charged.

**2.4 DESCRIPTION OF SUPPORT UNITS(CONDUCTED MODE)**

The EUT has been tested as an independent unit together with other necessary accessories or support units. The following support units or accessories were used to form a representative test configuration during the tests.

Item	Equipment	Brand	Model/Type No.	Series No.	Note
AE-1	Adapter	SUNUN	SA18V-120150U	N/A	Peripherals

Item	Cable Type	Shielded Type	Ferrite Core	Length
C-1	USB Cable	YES	NO	1.0m
C-2	RF Cable	YES	NO	0.1m

Note:

- (1) The support equipment was authorized by Declaration of Confirmation.
- (2) For detachable type I/O cable should be specified the length in cm in 『Length』 column.

**2.5 EQUIPMENTS LIST FOR ALL TEST ITEMS**

Radiation& Conducted Test equipment

Item	Kind of Equipment	Manufacturer	Type No.	Serial No.	Last calibration	Calibrated until	Calibration period
1	Spectrum Analyzer	Agilent	E4407B	MY45108040	2020.05.11	2021.05.10	1 year
2	Spectrum Analyzer	Agilent	N9020A	MY49100060	2020.07.13	2021.07.12	1 year
3	Spectrum Analyzer	R&S	FSV40	101417	2020.08.07	2021.08.06	1 year
4	Test Receiver	R&S	ESPI7	101318	2020.05.11	2021.05.10	1 year
5	Bilog Antenna	TESEQ	CBL6111D	31216	2020.04.11	2021.04.10	1 year
6	50Ω Coaxial Switch	Anritsu	MP59B	6200983705	2020.05.11	2023.05.10	3 year
7	Horn Antenna	EM	EM-AH-10180	2011071402	2020.04.11	2021.04.10	1 year
8	Broadband Horn Antenna	SCHWARZBECK	BBHA 9170	803	2020.12.19	2021.12.08	1 year
9	Amplifier	EMC	EMC051835SE	980246	2020.07.13	2021.07.12	1 year
10	Active Loop Antenna	SCHWARZBECK	FMZB 1519B	055	2020.12.10	2021.12.09	1 year
11	Power Meter	DARE	RPR3006W	15100041SN084	2020.07.13	2021.07.12	1 year
12	Test Cable (9KHz-30MHz)	N/A	R-01	N/A	2020.07.13	2023.07.12	3 year
13	Test Cable (30MHz-1GHz)	N/A	R-02	N/A	2020.07.13	2021.07.12	1 year
14	High Test Cable(1G-40G Hz)	N/A	R-03	N/A	2019.06.28	2022.06.27	3 year
15	High Test Cable(1G-40G Hz)	N/A	R-04	N/A	2020.04.11	2021.04.10	1 year
16	Filter	TRILTHIC	2400MHz	29	2020.07.13	2021.07.12	1 year
17	temporary antenna connector (Note)	NTS	R001	N/A	N/A	N/A	N/A

Note:

We will use the temporary antenna connector (soldered on the PCB board) When conducted test  
And this temporary antenna connector is listed within the instrument list

AC Conduction Test equipment

Item	Kind of Equipment	Manufacturer	Type No.	Serial No.	Last calibration	Calibrated until	Calibration period
1	Test Receiver	R&S	ESCI	101160	2020.05.11	2021.05.10	1 year
2	LISN	R&S	ENV216	101313	2020.04.11	2021.04.10	1 year
3	LISN	SCHWARZBECK	NNLK 8129	8129245	2020.05.11	2021.05.10	1 year
4	50Ω Coaxial Switch	ANRITSU CORP	MP59B	6200983704	2020.05.11	2023.05.10	3 year
5	Test Cable (9KHz-30MHz)	N/A	C01	N/A	2020.05.11	2023.05.10	3 year
6	Test Cable (9KHz-30MHz)	N/A	C02	N/A	2020.05.11	2023.05.10	3 year
7	Test Cable (9KHz-30MHz)	N/A	C03	N/A	2020.05.11	2023.05.10	3 year

Note: Each piece of equipment is scheduled for calibration once a year except the Test Cable& Aux Equipment which is scheduled for calibration every 3 years.

**3. TEST REQUIREMENTS**

**3.1 CONDUCTED EMISSION MEASUREMENT**

**3.1.1 APPLICABLE STANDARD**

According to FCC Part 15.207(a)

**3.1.2 CONFORMANCE LIMIT**

Frequency(MHz)	Conducted Emission Limit	
	Quasi-peak	Average
0.15-0.5	66-56*	56-46*
0.5-5.0	56	46
5.0-30.0	60	50

Note: 1. \*Decreases with the logarithm of the frequency  
 2. The lower limit shall apply at the transition frequencies  
 3. The limit decreases in line with the logarithm of the frequency in the range of 0.15 to 0.50MHz.

**3.1.3 TEST CONFIGURATION**

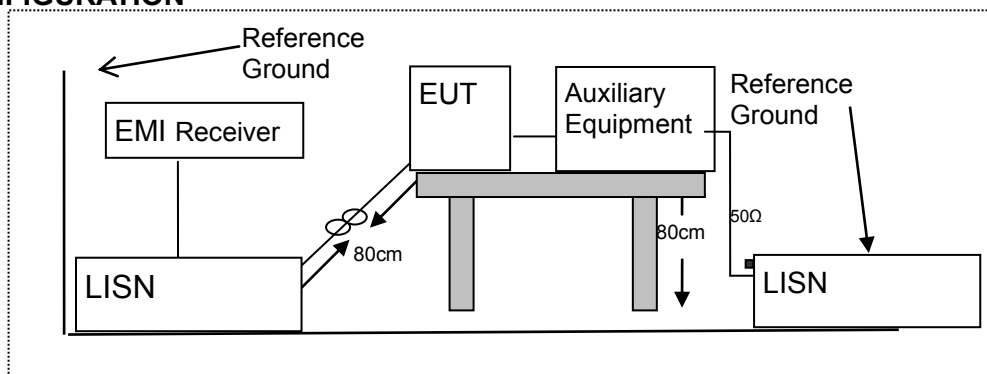

**3.1.4 TEST PROCEDURE**

According to the requirements in Section 13.1.4.1 of ANSI C63.10-2013 Conducted emissions the EUT measured in the frequency range between 0.15 MHz and 30 MHz using CISPR Quasi-Peak and average detector mode.

1. The EUT was placed 0.4 meter from the conducting wall of the shielding room.
2. The EUT was placed on a table which is 0.8m above ground plane.
3. Connect EUT to the power mains through a line impedance stabilization network (LISN). All other support equipments powered from additional LISN(s). The LISN provide 50 Ohm/ 50uH of coupling impedance for the measuring instrument.
4. Interconnecting cables that hang closer than 40 cm to the ground plane shall be folded back and forth in the center forming a bundle 30 to 40cm long.
5. I/O cables that are not connected to a peripheral shall be bundled in the center. The end of the cable may be terminated, if required, using the correct terminating impedance. The overall length shall not exceed 1 m.
6. LISN at least 80 cm from nearest part of EUT chassis.
7. The frequency range from 150KHz to 30MHz was searched.
8. Set the test-receiver system to Peak Detect Function and specified bandwidth(IF bandwidth=9KHz) with Maximum Hold Mode
9. For the actual test configuration, please refer to the related Item –EUT Test Photos.

**3.1.5 TEST RESULTS**

EUT :	LTE Router	Model Name :	I282
Temperature :	21.1 °C	Relative Humidity :	41%
Pressure :	1010hPa	Phase :	L
Test Voltage :	DC 12V from Adapter AC 120V/60Hz	Test Mode :	Mode 1

Frequency (MHz)	Reading Level (dBμV)	Correct Factor (dB)	Measure-ment (dBμV)	Limits (dBμV)	Margin (dB)	Remark
0.1685	40.90	9.56	50.46	65.03	-14.57	QP
0.1685	24.11	9.56	33.67	55.03	-21.36	AVG
0.2505	34.86	9.54	44.40	61.74	-17.34	QP
0.2505	18.81	9.54	28.35	51.74	-23.39	AVG
0.3140	29.40	9.54	38.94	59.86	-20.92	QP
0.3140	11.50	9.54	21.04	49.86	-28.82	AVG
0.4237	27.03	9.55	36.58	57.37	-20.79	QP
0.4237	21.51	9.55	31.06	47.37	-16.31	AVG
7.9019	29.03	9.67	38.70	60.00	-21.30	QP
7.9019	20.00	9.67	29.67	50.00	-20.33	AVG
8.8376	29.02	9.68	38.70	60.00	-21.30	QP
8.8376	19.12	9.68	28.80	50.00	-21.20	AVG

Remark:

1. All readings are Quasi-Peak and Average values.
2. Factor = Insertion Loss + Cable Loss.

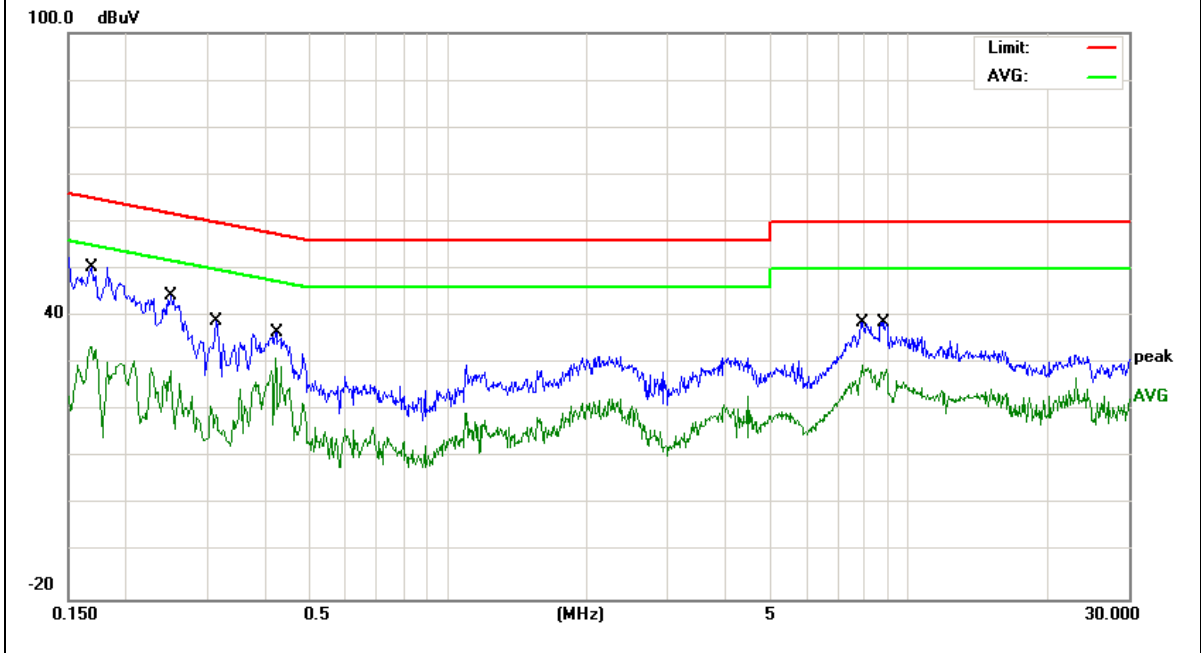



EUT :	LTE Router	Model Name :	I282
Temperature :	21 °C	Relative Humidity :	51%
Pressure :	1010hPa	Phase :	N
Test Voltage :	DC 12V from Adapter AC 120V/60Hz	Test Mode :	Mode 1

Frequency (MHz)	Reading Level (dBμV)	Correct Factor (dB)	Measure-ment (dBμV)	Limits (dBμV)	Margin (dB)	Remark
0.1580	44.25	9.55	53.80	65.56	-11.76	QP
0.1580	28.11	9.55	37.66	55.56	-17.90	AVG
0.1833	43.06	9.54	52.60	64.33	-11.73	QP
0.1833	28.64	9.54	38.18	54.33	-16.15	AVG
0.3518	37.77	9.53	47.30	58.92	-11.62	QP
0.3518	29.66	9.53	39.19	48.92	-9.73	AVG
0.9456	24.15	9.55	33.70	56.00	-22.30	QP
0.9456	14.28	9.55	23.83	46.00	-22.17	AVG
9.2858	27.42	9.68	37.10	60.00	-22.90	QP
9.2858	18.34	9.68	28.02	50.00	-21.98	AVG
14.9778	24.85	9.75	34.60	60.00	-25.40	QP
14.9778	15.32	9.75	25.07	50.00	-24.93	AVG

Remark:

1. All readings are Quasi-Peak and Average values.
2. Factor = Insertion Loss + Cable Loss.

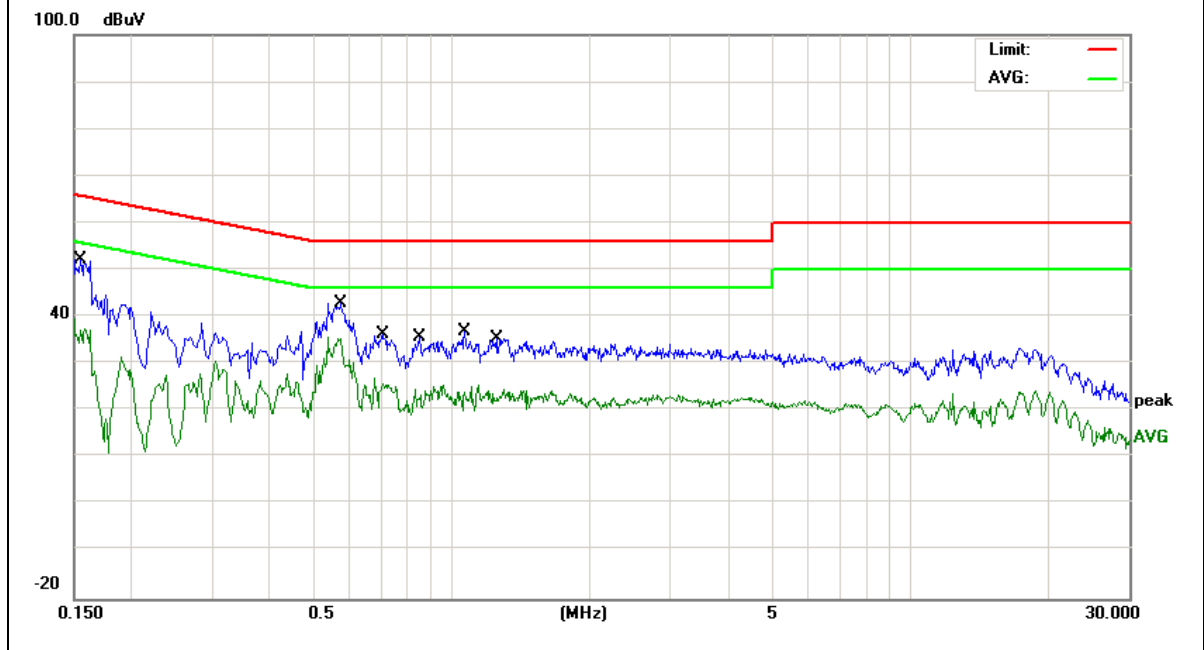

**3.2 RADIATED EMISSION MEASUREMENT**

**3.2.1 APPLICABLE STANDARD**

According to FCC Part 15.407(b) and 15.209

**3.2.2 CONFORMANCE LIMIT**

According to FCC Part 15.407(b)(7): radiated emissions which fall in the restricted bands, as defined in §15.205(a), must also comply with the radiated emission limits specified in §15.209(a) (see §15.205(c)).

According to FCC Part 15.205, Restricted bands

MHz	MHz	MHz	GHz
0.090-0.110	16.42-16.423	399.9-410	4.5-5.15
0.495-0.505	16.69475-16.69525	608-614	5.35-5.46
2.1735-2.1905	16.80425-16.80475	960-1240	7.25-7.75
4.125-4.128	25.5-25.67	1300-1427	8.025-8.5
4.17725-4.17775	37.5-38.25	1435-1626.5	9.0-9.2
4.20725-4.20775	73-74.6	1645.5-1646.5	9.3-9.5
6.215-6.218	74.8-75.2	1660-1710	10.6-12.7
6.26775-6.26825	123-138	2200-2300	14.47-14.5
8.291-8.294	149.9-150.05	2310-2390	15.35-16.2
8.362-8.366	156.52475-156.52525	2483.5-2500	17.7-21.4
8.37625-8.38675	156.7-156.9	2690-2900	22.01-23.12
8.41425-8.41475	162.0125-167.17	3260-3267	23.6-24.0
12.29-12.293	167.72-173.2	3332-3339	31.2-31.8
12.51975-12.52025	240-285	3345.8-3358	36.43-36.5
12.57675-12.57725	322-335.4	3600-4400	(2)
13.36-13.41			

20dBc in any 100 kHz bandwidth outside the operating frequency band. In case the emission fall within the restricted band specified on 15.205(a), then the 15.209(a) limit in the table below has to be followed.

Restricted Frequency(MHz)	Field Strength (µV/m)	Field Strength (dBµV/m)	Measurement Distance
0.009-0.490	2400/F(KHz)	20 log (uV/m)	300
0.490-1.705	24000/F(KHz)	20 log (uV/m)	30
1.705~30.0	30	29.5	30
30-88	100	40	3
88-216	150	43.5	3
216-960	200	46	3
Above 960	500	54	3

Limits of Radiated Emission Measurement(Above 1000MHz)

Frequency(MHz)	Class B (dBuV/m) (at 3M)	
	PEAK	AVERAGE
Above 1000	74	54

- Remark : 1. Emission level in dBuV/m=20 log (uV/m)  
 2. Measurement was performed at an antenna to the closed point of EUT distance of meters.  
 3. For Frequency 9kHz~30MHz:  
 Distance extrapolation factor =40log(Specific distance/ test distance)(dB);  
 Limit line=Specific limits(dBuV) + distance extrapolation factor.  
 For Frequency above 30MHz:  
 Distance extrapolation factor =20log(Specific distance/ test distance)(dB);  
 Limit line=Specific limits(dBuV) + distance extrapolation factor.

**3.2.3 MEASURING INSTRUMENTS**

The Measuring equipment is listed in the section 6.3 of this test report.

3.2.4 TEST CONFIGURATION

(a) For radiated emissions below 30MHz

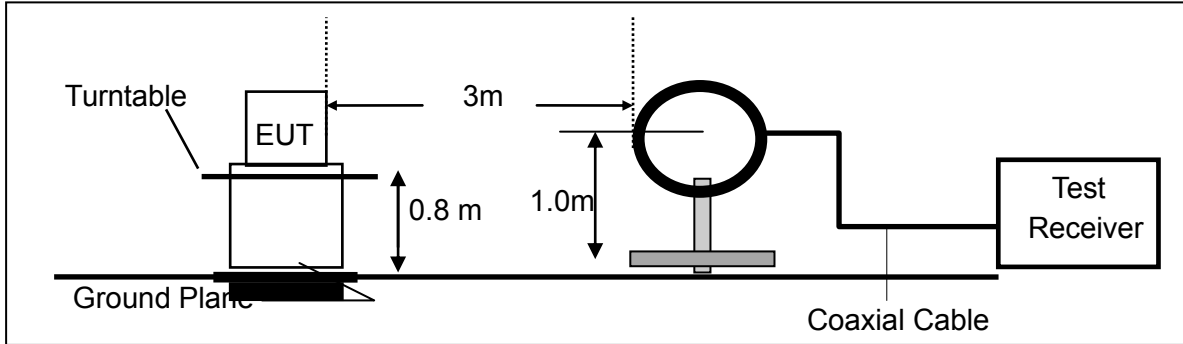

(b) For radiated emissions from 30MHz to 1000MHz

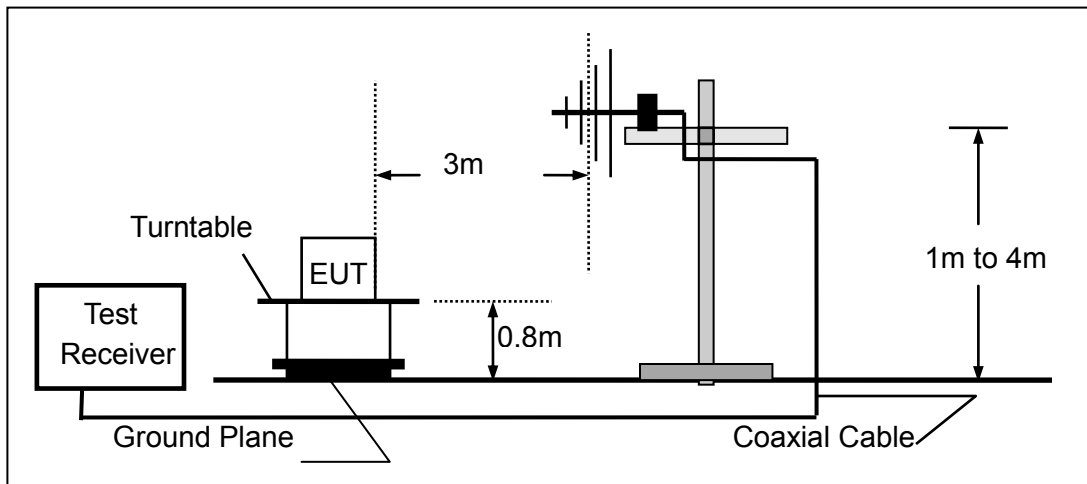

(c) For radiated emissions above 1000MHz

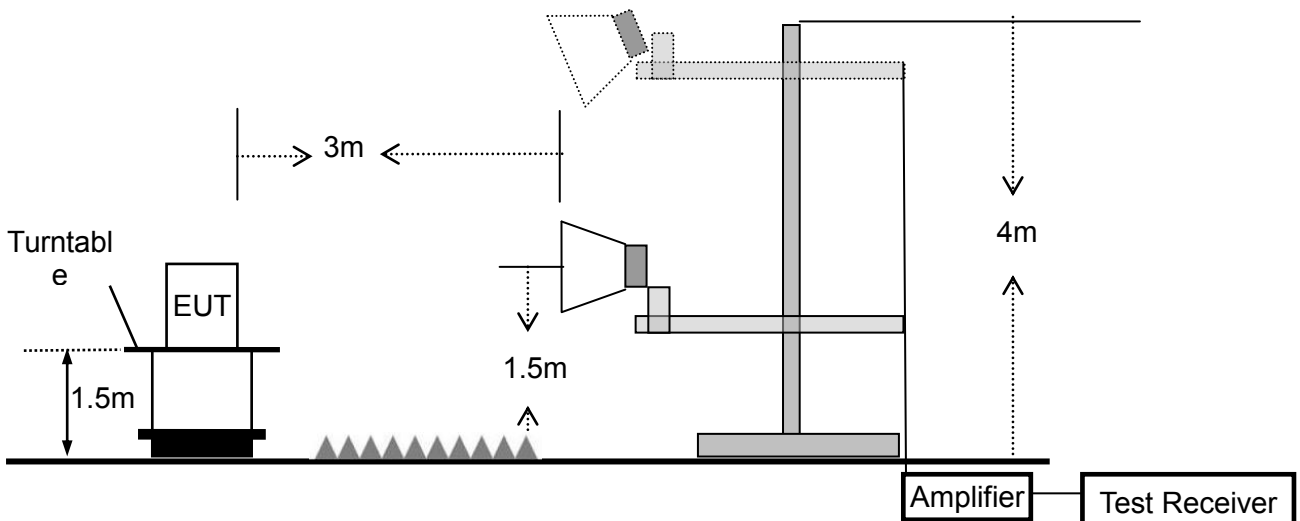

**3.2.5 TEST PROCEDURE**

The test site semi-anechoic chamber has met the requirement of NSA tolerance 4 dB according to the standards: ANSI C63.10-2013. The test distance is 3m. The setup is according to the requirements in Section 13.1.4.1 of ANSI C63.10-2013 and CAN/CSA-CEI/IEC CISPR 22.

This test is required for any spurious emission that falls in a Restricted Band, as defined in Section 15.205. It must be performed with the highest gain of each type of antenna proposed for use with the EUT.

Use the following spectrum analyzer settings:

Spectrum Parameter	Setting
Attenuation	Auto
Start Frequency	1000 MHz
Stop Frequency	10th carrier harmonic
RB / VB (emission in restricted band)	1 MHz / 1 MHz for Peak, 1 MHz / 10Hz for Average

Receiver Parameter	Setting
Attenuation	Auto
Start ~ Stop Frequency	9kHz~150kHz / RB 200Hz for QP
Start ~ Stop Frequency	150kHz~30MHz / RB 9kHz for QP
Start ~ Stop Frequency	30MHz~1000MHz / RB 120kHz for QP

- The measuring distance of at 3 m shall be used for measurements at frequency up to 1GHz. For frequencies above 1GHz, any suitable measuring distance may be used.
- The EUT was placed on the top of a rotating table 0.8 m for below 1GHz and 1.5m for above 1GHz the ground at a 3 meter. The table was rotated 360 degrees to determine the position of the highest radiation.
- The height of the equipment or of the substitution antenna shall be 0.8 m for below 1GHz and 1.5m for above 1GHz; the height of the test antenna shall vary between 1 m to 4 m. Both horizontal and vertical polarizations of the antenna are set to make the measurement.
- The initial step in collecting conducted emission data is a spectrum analyzer peak detector mode pre-scanning the measurement frequency range. Significant peaks are then marked and then Quasi Peak detector mode re-measured.
- If the Peak Mode measured value compliance with and lower than Quasi Peak Mode Limit, the EUT shall be deemed to meet QP Limits and then no additional QP Mode measurement performed.
- For the actual test configuration, please refer to the related Item –EUT Test Photos.

Note:

Both horizontal and vertical antenna polarities were tested and performed pretest to three orthogonal axis. The worst case emissions were reported

During the radiated emission test, the Spectrum Analyzer was set with the following configurations:

Frequency Band (MHz)	Function	Resolution bandwidth	Video Bandwidth
30 to 1000	QP	120 kHz	300 kHz
Above 1000	Peak	1 MHz	1 MHz
	Average	1 MHz	10 Hz

Note: for the frequency ranges below 30 MHz, a narrower RBW is used for these ranges but the measured value should add a RBW correction factor (RBWCF) where  $RBWCF [dB] = 10 \cdot \lg(100 [kHz] / \text{narrower RBW [kHz]})$ . , the narrower RBW is 1 kHz and RBWCF is 20 dB for the frequency 9 kHz to 150 kHz, and the narrower RBW is 10 kHz and RBWCF is 10 dB for the frequency 150 kHz to 30 MHz.

**3.2.6 TEST RESULTS (9KHz – 30 MHz)**

EUT:	LTE Router	Model Name. :	I282
Temperature:	20 °C	Relative Humidity:	48%
Pressure:	1010 hPa	Test Voltage :	DC 12V
Test Mode :	TX	Polarization :	--

Freq.	Reading	Limit	Margin	State
(MHz)	(dBuV/m)	(dBuV/m)	(dB)	P/F
--	--	--	--	N/A
--	--	--	--	N/A

Note:

The amplitude of spurious emissions which are attenuated by more than 20dB below the permissible value has no need to be reported.

**3.2.7 TEST RESULTS (30MHz – 1GHz)**

EUT :	LTE Router	Model Name. :	I282
Temperature :	25.4 °C	Relative Humidity :	47%
Pressure :	1010 hPa	Test Voltage :	DC 12V
Test Mode :	TX(5G)- 802.11a (Low CH)		

Polar (H/V)	Frequency	Meter Reading	Factor	Emission Level	Limits	Margin	Remark
	(MHz)	(dBuV)	(dB)	(dBuV/m)	(dBuV/m)	(dB)	
V	31.1798	11.80	18.21	30.01	40.00	-9.99	QP
V	47.6586	18.38	10.83	29.21	40.00	-10.79	QP
V	69.6005	23.00	6.31	29.31	40.00	-10.69	QP
V	104.9033	22.48	11.09	33.57	43.50	-9.93	QP
V	250.3012	11.24	13.48	24.72	46.00	-21.28	QP
V	916.0687	14.98	26.98	41.96	46.00	-4.04	QP

**Remark:**

Absolute Level= Meter Reading + Factor, Margin= Emission Level - Limit

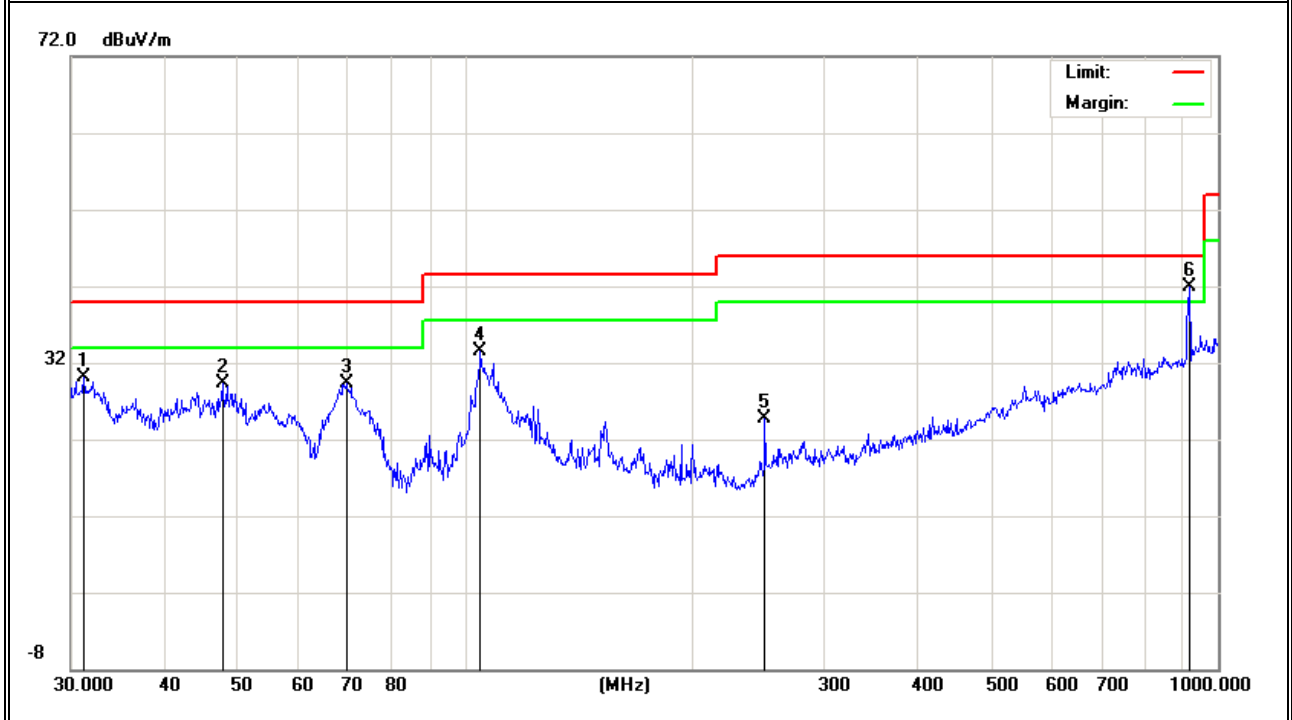

Polar (H/V)	Frequency	Meter Reading	Factor	Emission Level	Limits	Margin	Remark
	(MHz)	(dBuV)	(dB)	(dBuV/m)	(dBuV/m)	(dB)	
H	74.1351	10.20	7.24	17.44	40.00	-22.56	QP
H	106.3850	11.52	11.13	22.65	43.50	-20.85	QP
H	250.3012	8.21	13.48	21.69	46.00	-24.31	QP
H	566.6223	6.77	22.03	28.80	46.00	-17.20	QP
H	766.0570	7.96	24.89	32.85	46.00	-13.15	QP
H	912.8620	14.95	26.84	41.79	46.00	-4.21	QP

**Remark:**

Absolute Level= ReadingLevel+ Factor, Margin= Absolute Level - Limit

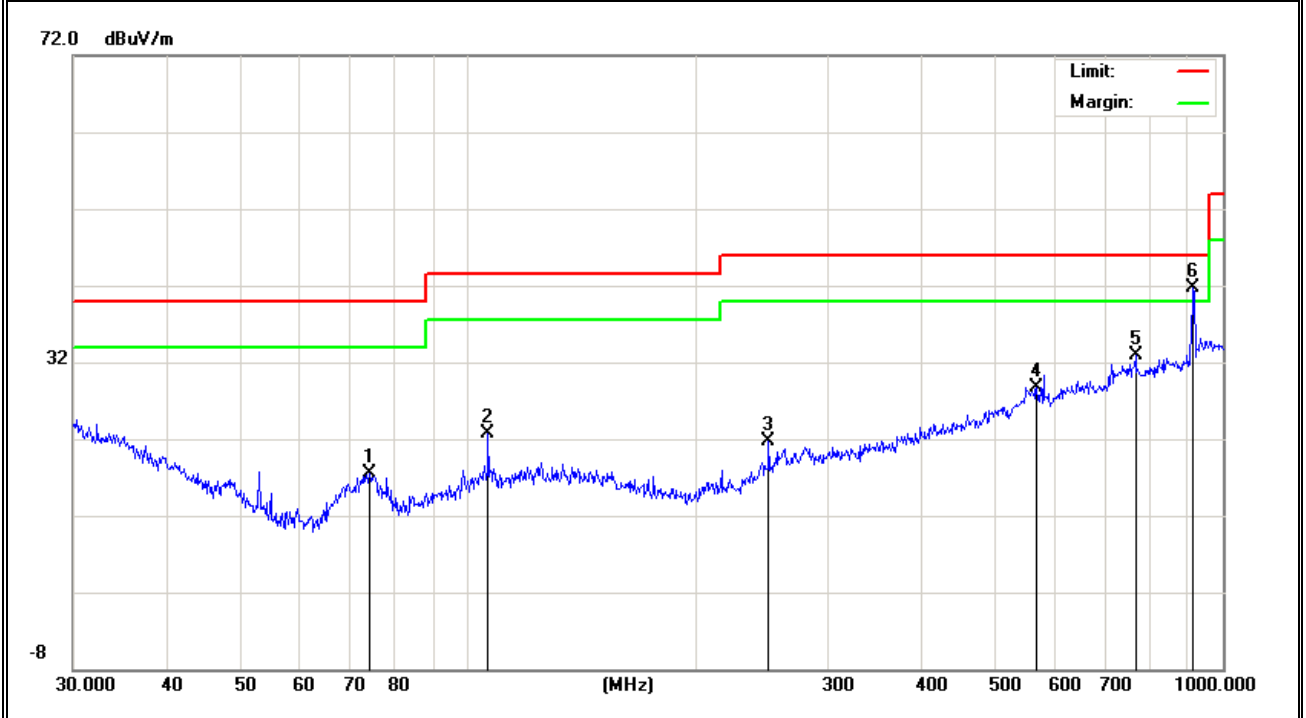

**3.2.8 TEST RESULTS (1GHz-18GHz)**

EUT :	LTE Router	Model Name. :	I282
Temperature :	20 °C	Relative Humidity :	48%
Pressure :	1010 hPa	Test Voltage :	DC 12V
Test Mode :	TX(5.8G) - 802.11n20_5180~5240MHz		

Polar	Frequency	Meter Reading	Cable loss	Antenna Factor	Preamp Factor	Emission Level	Limits	Margin	Detector Type
(H/V)	(MHz)	(dBuV)	(dB)	dB/m	(dB)	(dBuV/m)	(dBuV/m)	(dB)	
Low Channel (5745 MHz)-Above 1G									
Vertical	2806.9	65.42	5.94	35.40	44.00	62.76	74.00	-11.24	Pk
Vertical	2806.9	46.18	5.94	35.40	44.00	43.52	54.00	-10.48	AV
Vertical	11490.56	63.86	8.46	39.75	44.50	67.57	74.00	-6.43	Pk
Vertical	11490.56	44.10	8.46	39.75	44.50	47.81	54.00	-6.19	AV
Vertical	17235.32	60.15	10.12	38.80	44.10	64.97	68.20	-3.23	Pk
Horizontal	2911.524	64.93	5.94	35.18	44.00	62.05	68.20	-6.15	Pk
Horizontal	11490.56	62.91	8.46	38.71	44.50	65.58	74.00	-8.42	Pk
Horizontal	11490.56	41.39	8.46	38.71	44.50	44.06	54.00	-9.94	AV
Horizontal	17235.56	59.65	10.12	38.38	44.10	64.05	68.20	-4.15	Pk
middle Channel (5785 MHz)-Above 1G									
Vertical	3763.083	64.78	6.48	36.35	44.05	63.56	74.00	-10.44	Pk
Vertical	3763.083	42.63	6.48	36.35	44.05	41.41	54.00	-12.59	AV
Vertical	11570.56	63.77	8.47	37.88	44.51	65.61	74.00	-8.39	Pk
Vertical	11570.56	45.72	8.47	37.88	44.51	47.56	54.00	-6.44	AV
Vertical	17355.56	59.28	10.12	38.8	44.10	64.10	68.20	-4.10	Pk
Horizontal	3561.585	61.40	6.48	36.37	44.05	60.20	68.20	-8.00	Pk
Horizontal	11570.56	61.08	8.47	38.64	44.50	63.69	74.00	-10.31	Pk
Horizontal	11570.56	44.20	8.47	38.64	44.50	46.81	54.00	-7.19	AV
Horizontal	17355.56	64.67	10.12	38.38	44.10	69.07	74.00	-4.93	Pk
Horizontal	17355.35	44.33	10.12	38.38	44.10	48.72751	54.00	-5.27	AV



High Channel (5825 MHz)-Above 1G									
Vertical	3907.168	61.38	7.10	37.24	43.50	62.22	74.00	-11.78	Pk
Vertical	3907.168	43.61	7.10	37.24	43.50	44.45	54.00	-9.55	AV
Vertical	11650.54	61.87	8.46	37.68	44.50	63.51	74.00	-10.49	Pk
Vertical	11650.54	43.50	8.46	37.68	44.50	45.14	54.00	-8.86	AV
Vertical	17475.54	60.23	10.12	38.8	44.10	65.05	68.20	-3.15	Pk
Horizontal	3912.779	62.09	7.10	37.24	43.50	62.93	74.00	-11.07	Pk
Horizontal	3912.779	44.24	7.10	37.24	43.50	45.08	54.00	-8.92	AV
Horizontal	11650.54	63.23	8.46	38.57	44.50	65.76	74.00	-8.24	Pk
Horizontal	11650.54	43.62	8.46	38.57	44.50	46.15	54.00	-7.85	AV
Horizontal	17475.54	60.56	10.12	38.38	44.10	64.96	68.20	-3.24	Pk

Note: "802.11n20 (5G)" mode is the worst mode.

The amplitude of spurious emissions that are attenuated by more than 20dB below the permissible value has no need to be reported.

Emission level (dBuV/m) = 20 log Emission level (uV/m).

Corrected Reading: Antenna Factor + Cable Loss + Read Level - Preamp Factor = Level.

Spurious Emission in Restricted Bands 3260MHz- 18000MHz

All the modulation modes have been tested, the worst result was report as below:

Frequency	Reading Level	Cable Loss	Antenna Factor	Preamp Factor	Emission Level	Limits	Margin	Detector	Comment
(MHz)	(dBμV)	(dB)	dB/m	(dB)	(dBμV/m)	(dBμV/m)	(dB)	Type	
4500	64.67	5.2	35.6	44.2	61.270349	74	-12.73	Pk	Horizontal
4500	47.45	5.2	35.6	44.2	44.05	54	-9.95	AV	Horizontal
4500	54.49	5.2	35.6	44.2	51.09	74	-22.91	Pk	Horizontal
4500	40.95	5.2	35.6	44.2	37.55	54	-16.45	AV	Horizontal
5150	70.23	5.36	35.66	44.22	67.03	74	-6.97	Pk	Horizontal
5150	52.20	5.36	35.66	44.22	49.00	54	-5.00	AV	Horizontal
5150	70.41	5.36	35.66	44.22	67.21	74	-6.79	Pk	Vertical
5150	52.16	5.36	35.66	44.22	48.96	54	-5.04	AV	Vertical
5350	63.44	5.68	35.68	44.22	60.58	74	-13.42	Pk	Vertical
5350	42.43	5.68	35.68	44.22	39.57	54	-14.43	AV	Vertical
5350	55.50	5.68	35.68	44.22	52.64	74	-21.36	Pk	Horizontal
5350	38.67	5.68	35.68	44.22	35.81	54	-18.19	AV	Horizontal

“802.11n20” mode is the worst mode. When PK value is lower than the Average value limit, average don't record.

Other emissions are attenuated 20dB below the limit that does not recorded in the report.

### 3.3 POWER SPECTRAL DENSITY TEST

#### 3.3.1 Applied procedures / limit

##### According to FCC §15.407(a)(3)

For the band 5.725-5.85 GHz

(3) For the band 5.725-5.85 GHz, the maximum power spectral density shall not exceed 30 dBm in any 500-kHz band. If transmitting antennas of directional gain greater than 10 dBi are used, both the maximum conducted output power and the maximum power spectral density shall be reduced by the amount in dB that the directional gain of the antenna exceeds 10 dBi.

**3.3.2 TEST PROCEDURE**

For devices operating in the bands 5.15-5.25 GHz, 5.25-5.35 GHz, and 5.47-5.725 GHz, the above procedures make use of 1 MHz RBW to satisfy directly the 1 MHz reference bandwidth specified in § 15.407(a)(5). For devices operating in the band 5.725-5.85 GHz, the rules specify a measurement bandwidth of 500 kHz. Many spectrum analyzers do not have 500 kHz RBW, thus a narrower RBW may need to be used. The rules permit the use of a RBWs less than 1 MHz, or 500 kHz, “provided that the measured power is integrated over the full reference bandwidth” to show the total power over the specified measurement bandwidth (i.e., 1 MHz, or 500 kHz). If measurements are performed using a reduced resolution bandwidth (< 1 MHz, or < 500 kHz) and integrated over 1 MHz, or 500 KHz bandwidth, the following adjustments to the procedures apply:

- a) Set  $RBW \geq 1/T$ , where T is defined in section II.B.I.a).
- b) Set  $VBW \geq 3 RBW$ .
- c) If measurement bandwidth of Maximum PSD is specified in 500 kHz, add  $10\log(500kHz/RBW)$  to the measured result, whereas  $RBW (< 500 KHz)$  is the reduced resolution bandwidth of the spectrum analyzer set during measurement.
- d) If measurement bandwidth of Maximum PSD is specified in 1 MHz, add  $10\log(1MHz/RBW)$  to the measured result, whereas  $RBW (< 1 MHz)$  is the reduced resolution bandwidth of spectrum analyzer set during measurement.
- e) Care must be taken to ensure that the measurements are performed during a period of continuous transmission or are corrected upward for duty cycle.

Note: As a practical matter, it is recommended to use reduced RBW of 100 KHz for the sections 5.c) and 5.d) above, since  $RBW=100 KHz$  is available on nearly all spectrum analyzers.

**3.3.3 DEVIATION FROM STANDARD**

No deviation.

**3.3.4 TEST SETUP**



**3.3.5 EUT OPERATION CONDITIONS**

The EUT tested system was configured as the statements of 2.1 Unless otherwise a special operating condition is specified in the follows during the testing.

**3.3.6 TEST RESULTS**

EUT :	LTE Router	Model Name. :	I282
Temperature :	25 °C	Relative Humidity :	56%
Pressure :	1015 hPa	Test Voltage :	DC 12V
Test Mode :	TX Band IV (5725-5850MHz)		

Test data reference attachment.

**3.4 26DB & 99% EMISSION BANDWIDTH**

**3.4.1 Applied procedures / limit**

The maximum power spectral density is measured as a conducted emission by direct connection of a calibrated test instrument to the equipment under test. If the device cannot be connected directly, alternative techniques acceptable to the Commission may be used. Measurements in the 5.725-5.85 GHz band are made over a reference bandwidth of 500 kHz or the 26 dB emission bandwidth of the device, whichever is less. Measurements in the 5.15-5.25 GHz, 5.25-5.35 GHz, and the 5.47-5.725 GHz bands are made over a bandwidth of 1 MHz or the 26 dB emission bandwidth of the device, whichever is less. A narrower resolution bandwidth can be used, provided that the measured power is integrated over the full reference bandwidth.

**3.4.2 TEST PROCEDURE**

- a) Set RBW = approximately 1% of the emission bandwidth.
- b) Set the VBW > RBW.
- c) Detector = Peak.
- d) Trace mode = max hold.
- e) Measure the maximum width of the emission that is 26 dB down from the maximum of the emission. Compare this with the RBW setting of the analyzer. Readjust RBW and repeat measurement as needed until the RBW/EBW ratio is approximately 1%.

The following procedure shall be used for measuring (99 %) power bandwidth:

- 1. Set center frequency to the nominal EUT channel center frequency.
- 2. Set span = 1.5 times to 5.0 times the OBW.
- 3. Set RBW = 1 % to 5 % of the OBW
- 4. Set VBW ≥ 3 · RBW
- 5. Video averaging is not permitted. Where practical, a sample detection and single sweep mode shall be used. Otherwise, peak detection and max hold mode (until the trace stabilizes) shall be used.
- 6. Use the 99 % power bandwidth function of the instrument (if available).
- 7. If the instrument does not have a 99 % power bandwidth function, the trace data points are recovered and directly summed in power units. The recovered amplitude data points, beginning at the lowest frequency, are placed in a running sum until 0.5 % of the total is reached; that frequency is recorded as the lower frequency. The process is repeated until 99.5 % of the total is reached; that frequency is recorded as the upper frequency. The 99% occupied bandwidth is the difference between these two frequencies.

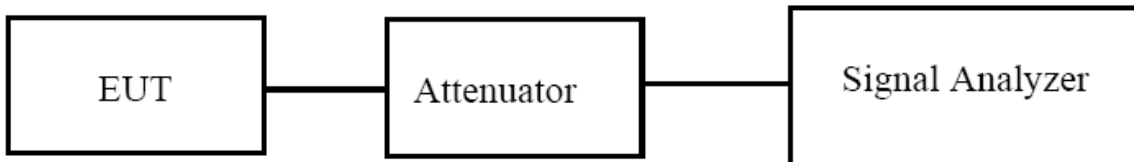

**3.4.3 EUT OPERATION CONDITIONS**

The EUT tested system was configured as the statements of 2.4 Unless otherwise a special operating condition is specified in the follows during the testing.

**3.4.4 TEST RESULTS**

EUT :	LTE Router	Model Name. :	I282
Temperature :	25 °C	Relative Humidity :	56%
Pressure :	1012 hPa	Test Voltage :	DC 12V
Test Mode :	TX Band IV (5725-5850MHz)		

Test data reference attachment.

### 3.5 MINIMUM 6 DB BANDWIDTH

#### 3.5.1 Applied procedures / limit

##### According to FCC §15.407(e)

(e) Within the 5.725-5.85 GHz band, the minimum 6 dB bandwidth of U-NII devices shall be at least 500 kHz.

#### 3.5.2 TEST PROCEDURE

Section 15.407(e) specifies the minimum 6 dB emission bandwidth of at least 500 KHz for the band 5.715-5.85 GHz. The following procedure shall be used for measuring this bandwidth:

- a) Set RBW = 100 kHz.
- b) Set the video bandwidth (VBW)  $\geq 3 \times$  RBW.
- c) Detector = Peak.
- d) Trace mode = max hold.
- e) Sweep = auto couple.
- f) Allow the trace to stabilize.
- g) Measure the maximum width of the emission that is constrained by the frequencies associated with the two outermost amplitude points (upper and lower frequencies) that are attenuated by 6 dB relative to the maximum level measured in the fundamental emission.

#### 3.5.3 DEVIATION FROM STANDARD

No deviation.

#### 3.5.4 TEST SETUP

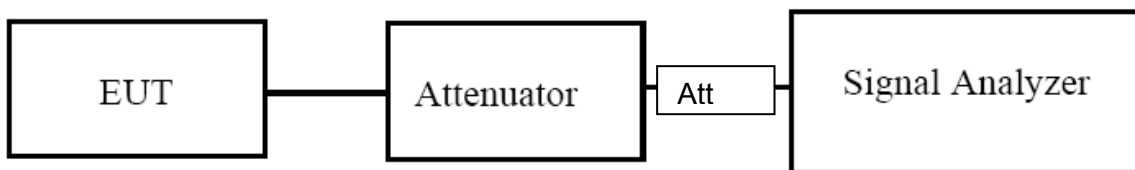

#### 3.5.5 EUT OPERATION CONDITIONS

The EUT tested system was configured as the statements of 2.4 Unless otherwise a special operating condition is specified in the follows during the testing.



**3.5.6 TEST RESULTS**

EUT :	LTE Router	Model Name. :	I282
Temperature :	25 °C	Relative Humidity :	60%
Pressure :	1012 hPa	Test Voltage :	DC 12V
Test Mode :	TX (5G) Mode Frequency Band IV (5725-5850MHz)		

Test data reference attachment.

**3.6 MAXIMUM CONDUCTED OUTPUT POWER**

**3.6.1 PPLIED PROCEDURES / LIMIT**

**According to FCC §15.407**

The maximum conducted output power should not exceed:

Frequency Band(MHz)	Limit
5725~5850	1W

**3.6.2 TEST PROCEDURE**

· Maximum conducted output power may be measured using a spectrum analyzer/EMI receiver or an RF power meter.

1. Device Configuration

If possible, configure or modify the operation of the EUT so that it transmits continuously at its maximum power control level (see section II.B.).

a) The intent is to test at 100 percent duty cycle; however a small reduction in duty cycle (to no lower than 98 percent) is permitted if required by the EUT for amplitude control purposes. Manufacturers are expected to provide software to the test lab to permit such continuous operation.

b) If continuous transmission (or at least 98 percent duty cycle) cannot be achieved due to hardware limitations (e.g., overheating), the EUT shall be operated at its maximum power control level with the transmit duration as long as possible and the duty cycle as high as possible.

2. Measurement using a Spectrum Analyzer or EMI Receiver (SA)

Measurement of maximum conducted output power using a spectrum analyzer requires integrating the spectrum across a frequency span that encompasses, at a minimum, either the EBW or the 99-percent occupied bandwidth of the signal.1 However, the EBW must be used to determine bandwidth dependent limits on maximum conducted output power in accordance with § 15.407(a).

a) The test method shall be selected as follows: (i) Method SA-1 or SA-1 Alternative (averaging with the EUT transmitting at full power throughout each sweep) shall be applied if either of the following conditions can be satisfied:

- The EUT transmits continuously (or with a duty cycle  $\geq 98$  percent).
- Sweep triggering or gating can be implemented in a way that the device transmits at the maximum power control level throughout the duration of each of the instrument sweeps to be averaged. This condition can generally be achieved by triggering the instrument's sweep if the duration of the sweep (with the analyzer configured as in Method SA-1, below) is equal to or shorter than the duration T of each transmission from the EUT and if those transmissions exhibit full power throughout their durations.

(ii) Method SA-2 or SA-2 Alternative (averaging across on and off times of the EUT transmissions, followed by duty cycle correction) shall be applied if the conditions of (i) cannot be achieved and the transmissions exhibit a constant duty cycle during the measurement duration. Duty cycle will be considered to be constant if variations are less than  $\pm 2$  percent.

(iii) Method SA-3 (RMS detection with max hold) or SA-3 Alternative (reduced VBW with max hold) shall be applied if the conditions of (i) and (ii) cannot be achieved.

b) Method SA-1 (trace averaging with the EUT transmitting at full power throughout each sweep): (i) Set span to encompass the entire emission bandwidth (EBW) (or, alternatively, the entire 99% occupied bandwidth) of the signal.

(ii) Set RBW = 1 MHz.

(iii) Set VBW  $\geq 3$  MHz.

(iv) Number of points in sweep  $\geq 2$  Span / RBW. (This ensures that bin-to-bin spacing is  $\leq$  RBW/2, so that narrowband signals are not lost between frequency bins.)

(v) Sweep time = auto.

(vi) Detector = RMS (i.e., power averaging), if available. Otherwise, use sample detector mode.

(vii) If transmit duty cycle  $< 98$  percent, use a video trigger with the trigger level set to enable triggering only on full power pulses. Transmitter must operate at maximum power control level for the entire duration of every sweep. If the EUT transmits continuously (i.e., with no off intervals) or at duty cycle  $\geq 98$  percent, and if each transmission is entirely at the maximum power control level, then the trigger shall be set to "free run".

(viii) Trace average at least 100 traces in power averaging (i.e., RMS) mode.

(ix) Compute power by integrating the spectrum across the EBW (or, alternatively, the entire 99% occupied bandwidth) of the signal using the instrument's band power measurement function with band limits set equal to the EBW (or occupied bandwidth) band edges. If the instrument does not have a band power function, sum the spectrum

### 3.6.3 DEVIATION FROM STANDARD

No deviation.

### 3.6.4 TEST SETUP

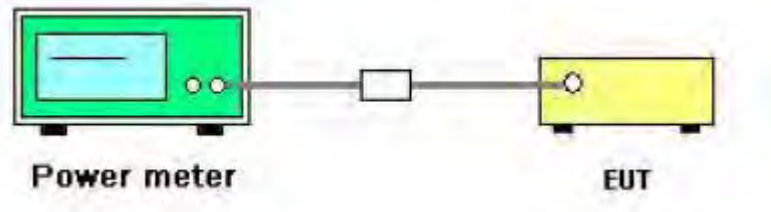

### 3.6.5 EUT OPERATION CONDITIONS

The EUT tested system was configured as the statements of 2.4 Unless otherwise a special operating condition is specified in the follows during the testing.

**3.6.6 TEST RESULTS**

EUT :	LTE Router	Model Name. :	I282
Temperature :	25 °C	Relative Humidity :	60%
Pressure :	1012 hPa	Test Voltage :	DC 12V
Test Mode :	TX (5G) Mode Frequency Band IV (5725-5850MHz)		

Test data reference attachment.

**3.7 OUT OF BAND EMISSIONS**

**3.7.1 Applicable Standard**

**According to FCC §15.407(b)**

Undesirable emission limits. Except as shown in paragraph (b)(7) of this section, the maximum emissions outside of the frequency bands of operation shall be attenuated in accordance with the following limits:

(2) For transmitters operating in the 5.725-5.85 GHz band: All emissions shall be limited to a level of -27 dBm/MHz at 75 MHz or more above or below the band edge increasing linearly to 10 dBm/MHz at 25 MHz above or below the band edge, and from 25 MHz above or below the band edge increasing linearly to a level of 15.6 dBm/MHz at 5 MHz above or below the band edge, and from 5 MHz above or below the band edge increasing linearly to a level of 27 dBm/MHz at the band edge.

**3.7.2 Test Procedure**

1. Check the calibration of the measuring instrument using either an internal calibrator or a known signal from an external generator.
2. Position the EUT without connection to measurement instrument. Turn on the EUT and connect its antenna terminal to measurement instrument via a low loss cable. Then set it to any one measured frequency within its operating range, and make sure the instrument is operated in its linear range.
3. Set RBW of spectrum analyzer to 1 MHz with a convenient frequency span.
4. Measure the highest amplitude appearing on spectral display and set it as a reference level. Plot the graph with marking the highest point and edge frequency.
5. Repeat above procedures until all measured frequencies were complete.

**3.7.3 DEVIATION FROM STANDARD**

No deviation.

**3.7.4 TEST SETUP**

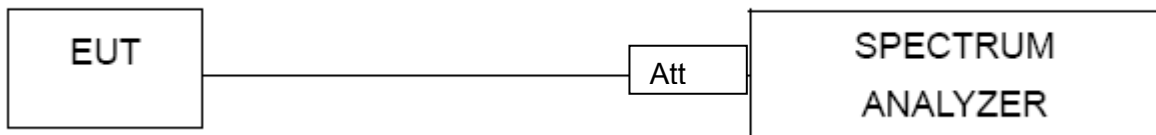

**3.7.5 EUT OPERATION CONDITIONS**

The EUT tested system was configured as the statements of 2.4 Unless otherwise a special operating condition is specified in the follows during the testing.

**3.7.6 TEST RESULTS**

EUT :	LTE Router	Model Name. :	I282
Temperature :	25 °C	Relative Humidity :	56%
Pressure :	1012 hPa	Test Voltage :	DC 12V

Note: Offset contains antenna gain and cable loss.  
Test data reference attachment.

### 3.8 SPURIOUS RF CONDUCTED EMISSIONS

#### 3.8.1 Conformance Limit

According to FCC §15.407(b)(1) (2) (3) (4)

#### 3.8.2 Measuring Instruments

The Measuring equipment is listed in the section 6.3 of this test report.

#### 3.8.3 Test Setup

Please refer to Section 6.1 of this test report.

#### 3.8.4 Test Procedure

The Spurious RF conducted emissions compliance of RF radiated emission should be measured by following the guidance in ANSI C63.10-2013 with respect to maximizing the emission by rotating the EUT, measuring the emission while the EUT is situated in three orthogonal planes (if appropriate), adjusting the measurement antenna height and polarization etc. Set RBW=100kHz and VBW= 300KHz to measure the peak field strength , and measure frequency range from 30MHz to 40GHz.

#### 3.8.5 Test Results

Remark: The measurement frequency range is from 30MHz to the 10th harmonic of the fundamental frequency. The lowest, middle and highest channels are tested to verify the spurious emissions and bandedge measurement data.

Test data reference attachment.

Offset contains antenna gain and cable loss.



### 3.9 FREQUENCY STABILITY MEASUREMENT

#### 3.9.1 LIMIT

Manufactures of U-NII devices are responsible for ensuring frequency stability such that an emission is maintained within the band of operation under all conditions of normal operation as specified in the user's manual.

#### 3.9.2 TEST PROCEDURES

1. The transmitter output (antenna port) was connected to the spectrum analyzer.
2. EUT have transmitted absence of modulation signal and fixed channelize.
3. Set the spectrum analyzer span to view the entire absence of modulation emissions bandwidth.
4. Set RBW = 10 kHz, VBW = 10 kHz with peak detector and maxhold settings.
5.  $f_c$  is declaring of channel frequency. Then the frequency error formula is  $(f_c - f)/f_c \times 10^6$  ppm .
6. The test extreme voltage is to change the primary supply voltage from 85 to 115 percent of the nominal value
7. Extreme temperature is  $-10^{\circ}\text{C} \sim 45^{\circ}\text{C}$ .

#### 3.9.3 TEST SETUP LAYOUT

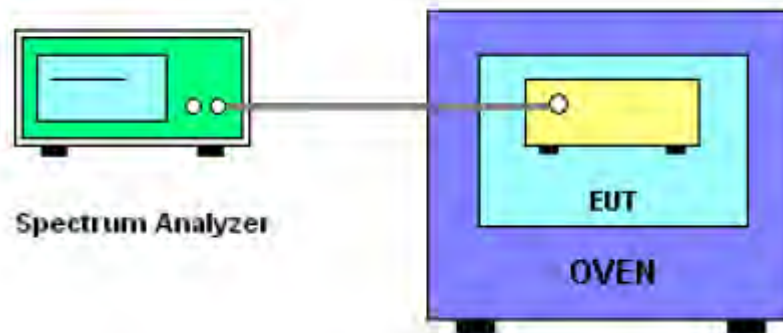

#### 3.9.4 EUT OPERATION DURING TEST

The EUT was programmed to be in continuously un-modulation transmitting mode.

3.9.5 TEST RESULTS

EUT :	LTE Router	Model Name. :	I282
Temperature :	25 °C	Relative Humidity :	56%
Pressure :	1012 hPa	Test Voltage :	DC 12V
Test Mode :	TX Frequency(5745-5825MHz)		

Voltage vs. Frequency Stability

TEST CONDITIONS				Reference Frequency: 5745MHz			
				f	fc	Max. Deviation (MHz)	Max. Deviation (ppm)
T nom (°C)	20	V nom (V)	5.00	5745.0028	5745	0.0028	0.4874
		V max (V)	5.75	5745.0026	5745	0.0026	0.4526
		V min (V)	4.25	5745.0026	5745	0.0026	0.4526
Limits				Within 5745-5850MHz			
Result				Complies			

Temperature vs. Frequency Stability

TEST CONDITIONS				Reference Frequency: 5745MHz			
				f	fc	Max. Deviation (MHz)	Max. Deviation (ppm)
V nom (V)	5	T (°C)	-20	5745.0066	5745	0.0066	1.1488
		T (°C)	-10	5745.0056	5745	0.0056	0.9748
		T (°C)	0	5745.0035	5745	0.0035	0.6092
		T (°C)	10	5745.0077	5745	0.0077	1.3403
		T (°C)	20	5745.0072	5745	0.0072	1.2533
		T (°C)	30	5745.0093	5745	0.0093	1.6157
		T (°C)	40	5745.0074	5745	0.0074	1.2881
		T (°C)	50	5745.0031	5745	0.0031	0.5460
		T (°C)	60	5745.0052	5745	0.0052	0.9051
		T (°C)	70	5745.0018	5745	0.0018	0.3133
Limits				Within 5745-5850MHz			
Result				Complies			

Voltage vs. Frequency Stability

TEST CONDITIONS				Reference Frequency: 5785MHz			
				f	fc	Max. Deviation (MHz)	Max. Deviation (ppm)
T nom (°C)	20	V nom (V)	5.00	5785.0059	5785	0.00590	1.0199
		V max (V)	5.75	5785.0089	5785	0.00890	1.5385
		V min (V)	4.25	5785.0084	5785	0.00840	1.4520
Limits				Within 5745-5850MHz			
Result				Complies			

Temperature vs. Frequency Stability

TEST CONDITIONS				Reference Frequency: 5785MHz			
				f	fc	Max. Deviation (MHz)	Max. Deviation (ppm)
V nom (V)	5	T (°C)	-20	5785.2861	5785	0.2861	49.4585
		T (°C)	-10	5785.4498	5785	0.4498	77.7603
		T (°C)	0	5785.4748	5785	0.4748	82.0711
		T (°C)	10	5785.4494	5785	0.4494	77.6866
		T (°C)	20	5785.9697	5785	0.9697	167.6316
		T (°C)	30	5785.2406	5785	0.2406	41.5838
		T (°C)	40	5785.2418	5785	0.2418	41.8063
		T (°C)	50	5785.9583	5785	0.9583	165.6499
		T (°C)	60	5785.9559	5785	0.9559	165.2291
		T (°C)	70	5785.5391	5785	0.5391	93.1933
Limits				Within 5745-5850MHz			
Result				Complies			

Voltage vs. Frequency Stability

TEST CONDITIONS				Reference Frequency: 5825MHz			
				f	fc	Max. Deviation (MHz)	Max. Deviation (ppm)
T nom (°C)	20	V nom (V)	5.00	5825.0032	5825	0.0032	0.5494
		V max (V)	5.75	5825.0035	5825	0.0035	0.6009
		V min (V)	4.25	5825.0035	5825	0.0035	0.6009
Limits				Within 5745-5850MHz			
Result				Complies			

Temperature vs. Frequency Stability

TEST CONDITIONS				Reference Frequency: 5825MHz			
				f	fc	Max. Deviation (MHz)	Max. Deviation (ppm)
V nom (V)	5	T (°C)	-20	5825.8544	5825	0.8544	146.6826
		T (°C)	-10	5825.0894	5825	0.0894	15.3476
		T (°C)	0	5825.4679	5825	0.4679	80.3255
		T (°C)	10	5825.2034	5825	0.2034	34.9134
		T (°C)	20	5825.7352	5825	0.7352	126.2182
		T (°C)	30	5825.3105	5825	0.3105	53.2977
		T (°C)	40	5825.0509	5825	0.0509	8.7368
		T (°C)	50	5825.6541	5825	0.6541	112.2947
		T (°C)	60	5826.0002	5825	1.0002	171.7045
		T (°C)	70	5825.2827	5825	0.2827	48.5389
Limits				Within 5745-5850MHz			
Result				Complies			

**4. ANTENNA REQUIREMENT**

**4.1 STANDARD REQUIREMENT**

15.203 requirement: For intentional device, according to 15.203: an intentional radiator shall be designed to ensure that no antenna other than that furnished by the responsible party shall be used with the device.

**4.2 EUT ANTENNA**

The module 5G WIFI has two antennas, and different modes support different transmit mode what describe as following form:

Mode	Tx/Rx
802.11a	1TX, 1RX
802.11n/ac	2TX, 2RX

For 5GHz mode, Antenna 1,2 are transmitting, each with the same directional gain.  
 ANT 1 and ANT 2 are correlated with each other, each with the same directional gain  $G_{ANT}$ : 1.8dBi  
 Directional gain= $G_{ANT}+10\log(N_{ANT})$ dBi  
 For MIMO mode, Directional gain= $1.8+10\log(2)$ dBi=4.81dBi in 5.8GHz band.

Note:  $G_{ANT}$  means antenna gain for ANT in dBi.  
 $N_{ANT}$  means the number of Antennas.

**5. TEST RESULTS**

5.1 DUTY CYCLE

SISO

Antenna	Condition	Mode	Frequency (MHz)	Duty Cycle (%)	Correction Factor (dB)
Ant 1	NVNT	802.11a	5745	100	0
Ant 1	NVNT	802.11a	5785	100	0
Ant 1	NVNT	802.11a	5825	100	0
Ant 2	NVNT	802.11a	5745	100	0
Ant 2	NVNT	802.11a	5785	100	0
Ant 2	NVNT	802.11a	5825	100	0
Ant 1	NVNT	802.11ac20	5745	100	0
Ant 1	NVNT	802.11ac20	5785	100	0
Ant 1	NVNT	802.11ac20	5825	100	0
Ant 2	NVNT	802.11ac20	5745	100	0
Ant 2	NVNT	802.11ac20	5785	100	0
Ant 2	NVNT	802.11ac20	5825	100	0
Ant 1	NVNT	802.11ac40	5755	100	0
Ant 1	NVNT	802.11ac40	5795	100	0
Ant 2	NVNT	802.11ac40	5755	100	0
Ant 2	NVNT	802.11ac40	5795	100	0
Ant 1	NVNT	802.11ac80	5775	100	0
Ant 2	NVNT	802.11ac80	5775	100	0
Ant 1	NVNT	802.11n(HT20)	5745	100	0
Ant 1	NVNT	802.11n(HT20)	5785	100	0
Ant 1	NVNT	802.11n(HT20)	5825	100	0
Ant 2	NVNT	802.11n(HT20)	5745	100	0
Ant 2	NVNT	802.11n(HT20)	5785	100	0
Ant 2	NVNT	802.11n(HT20)	5825	100	0
Ant 1	NVNT	802.11n(HT40)	5755	100	0
Ant 1	NVNT	802.11n(HT40)	5795	100	0
Ant 2	NVNT	802.11n(HT40)	5755	100	0
Ant 2	NVNT	802.11n(HT40)	5795	100	0

### Duty Cycle NVNT 802.11a 5745MHz Ant 1

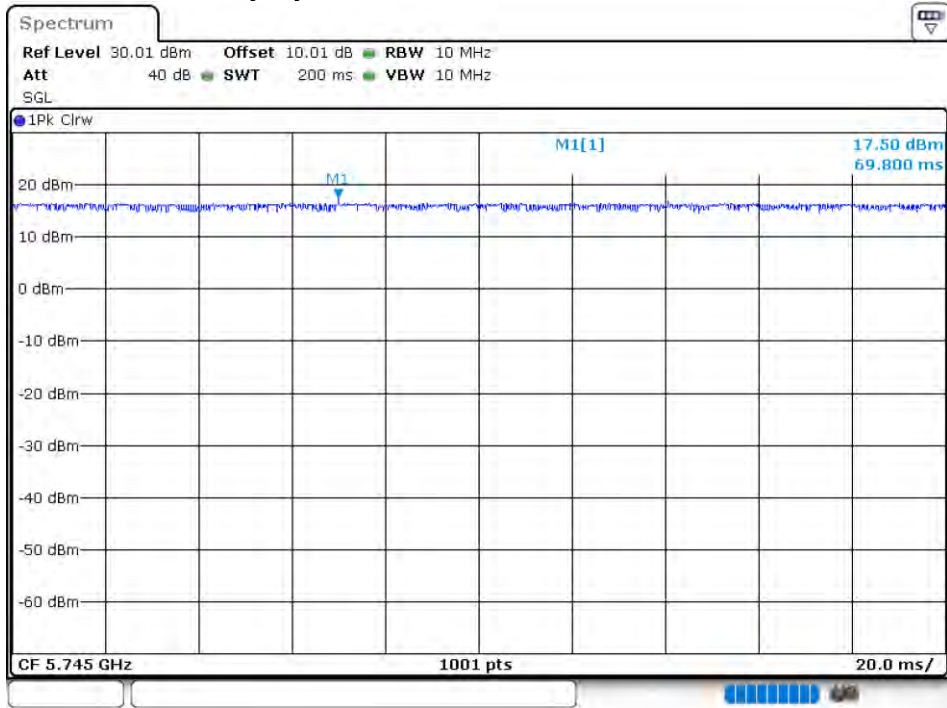

### Duty Cycle NVNT 802.11a 5785MHz Ant 1

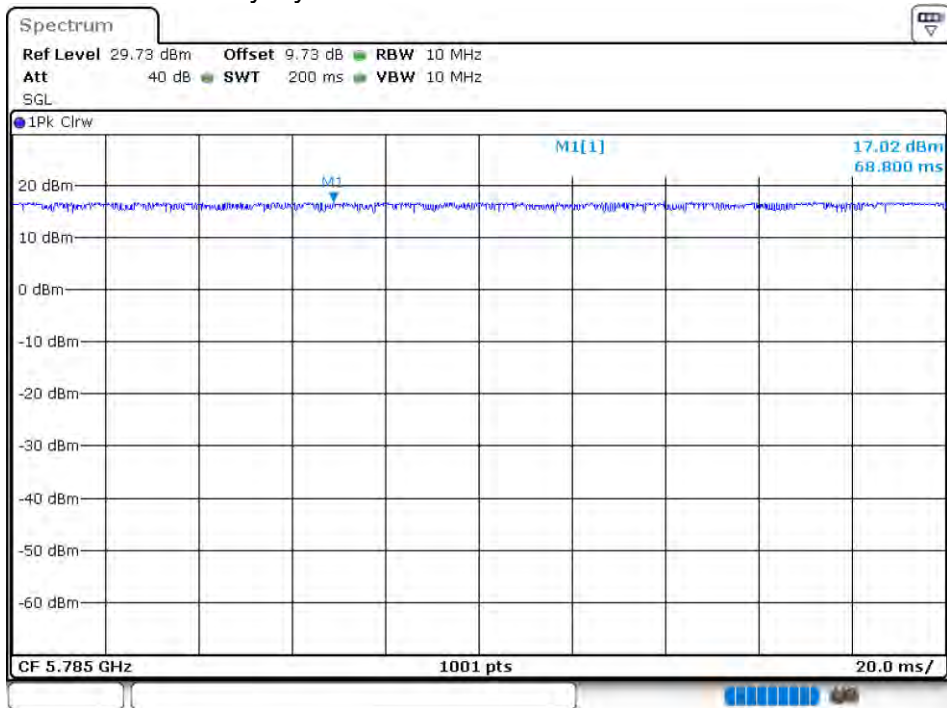

### Duty Cycle NVNT 802.11a 5825MHz Ant 1

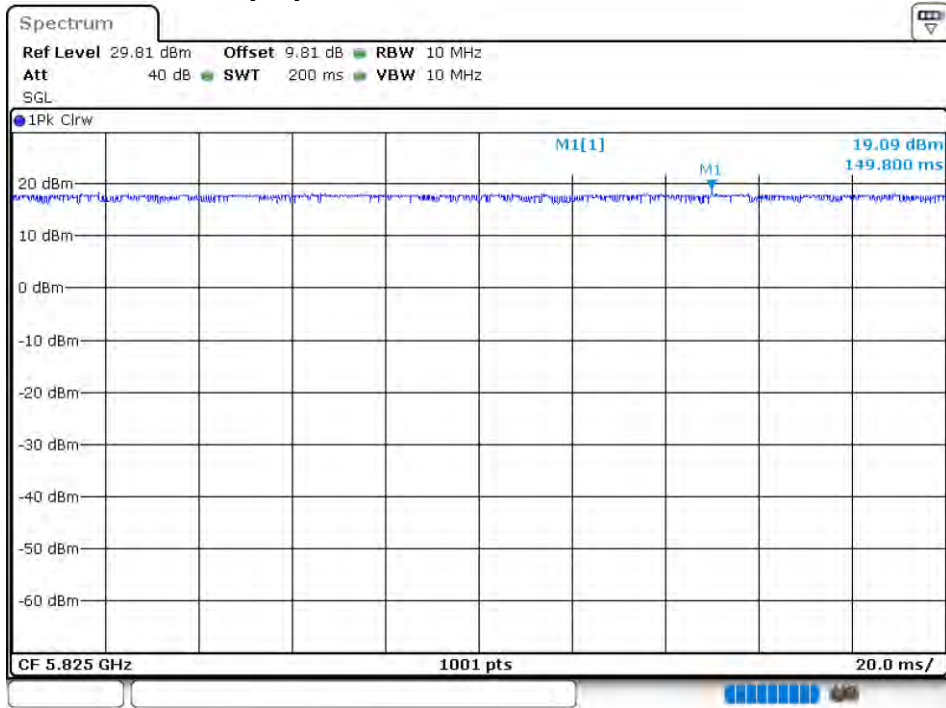

### Duty Cycle NVNT 802.11a 5745MHz Ant 2

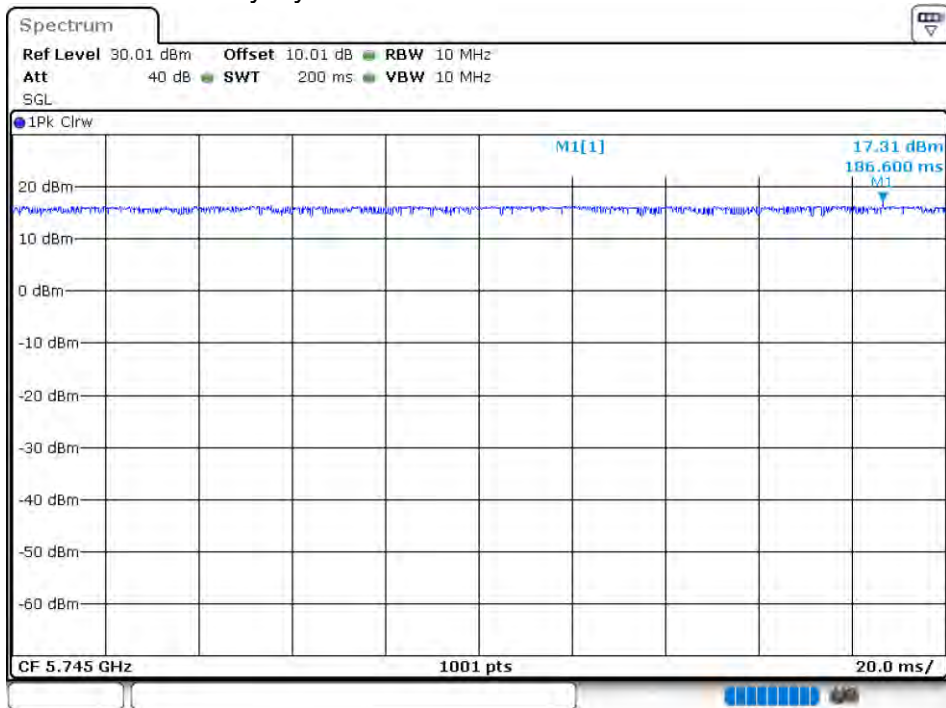



### Duty Cycle NVNT 802.11a 5785MHz Ant 2

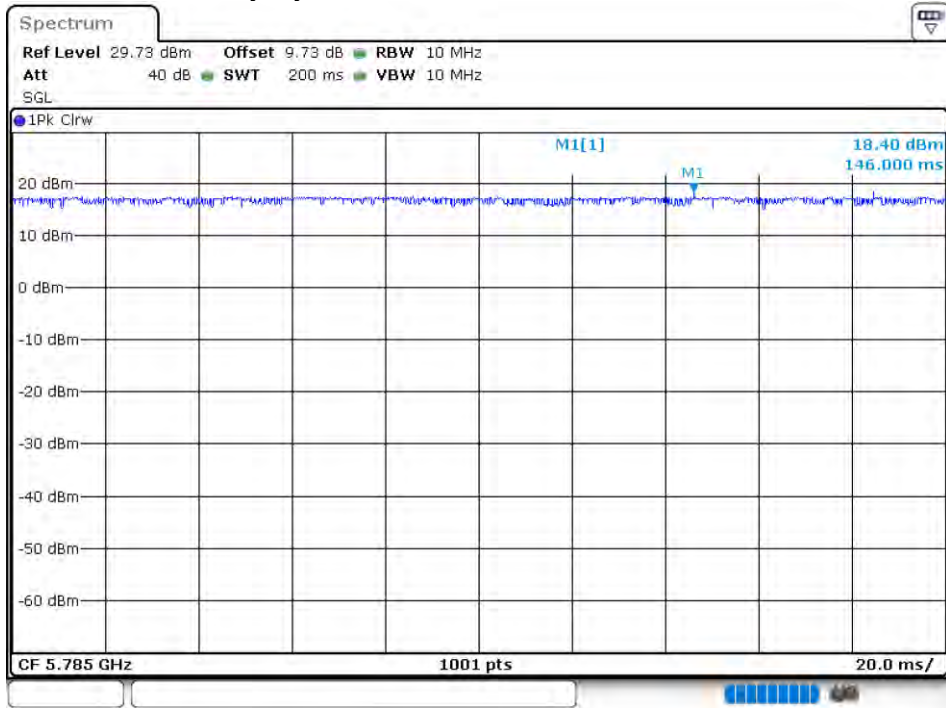

### Duty Cycle NVNT 802.11a 5825MHz Ant 2

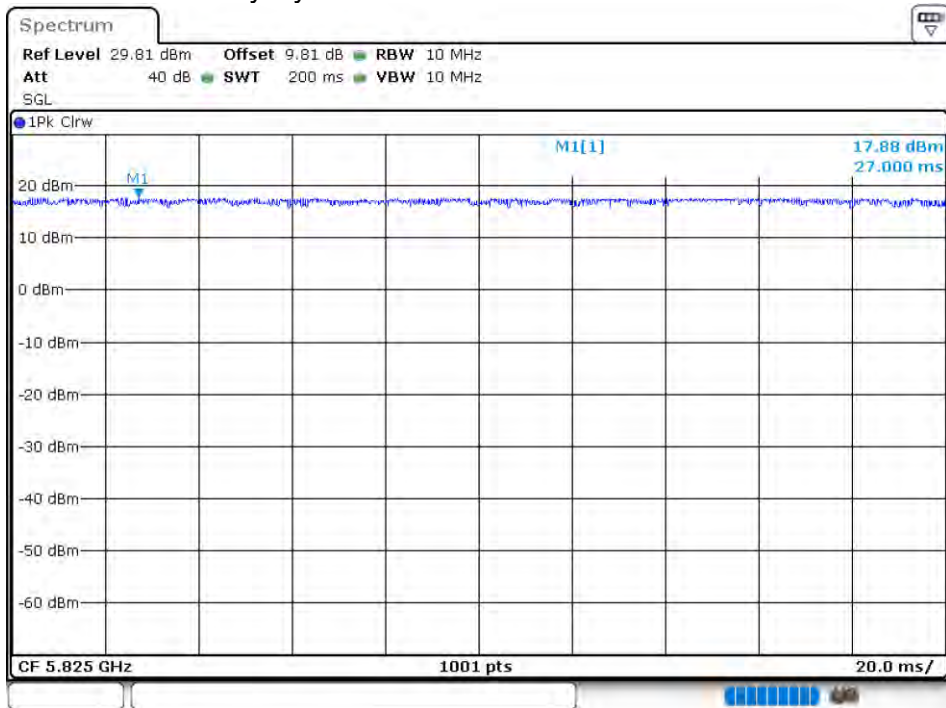

### Duty Cycle NVNT 802.11ac20 5745MHz Ant 1

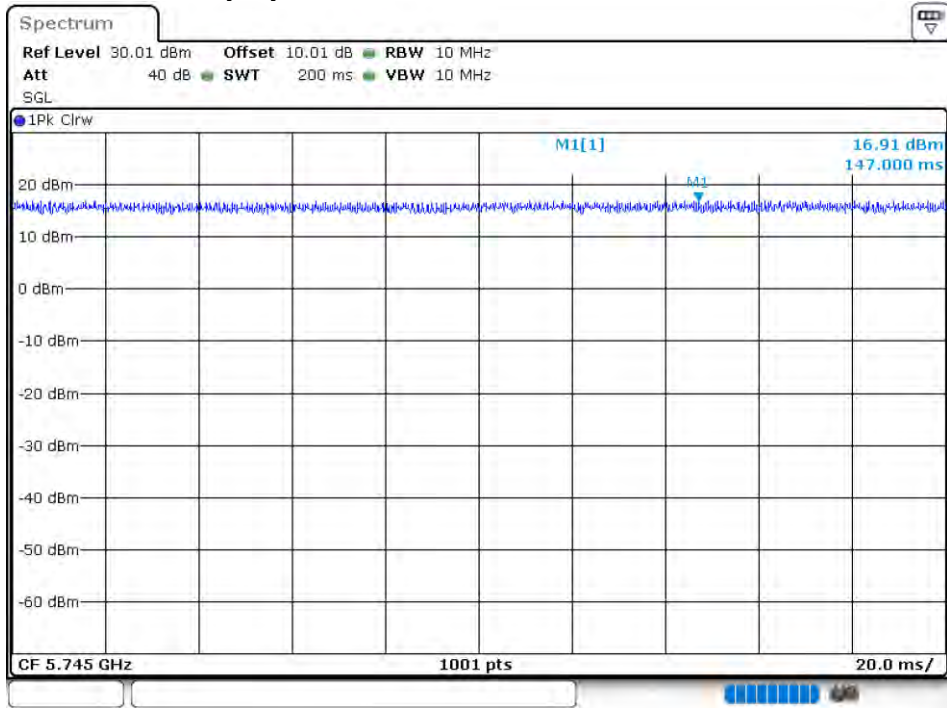

### Duty Cycle NVNT 802.11ac20 5785MHz Ant 1

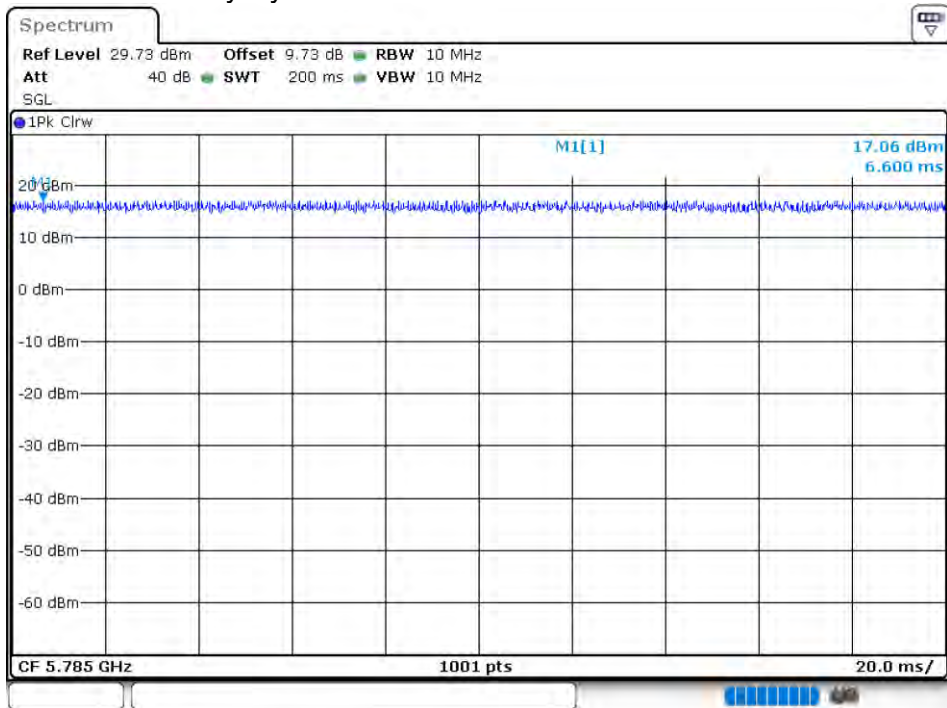

### Duty Cycle NVNT 802.11ac20 5825MHz Ant 1

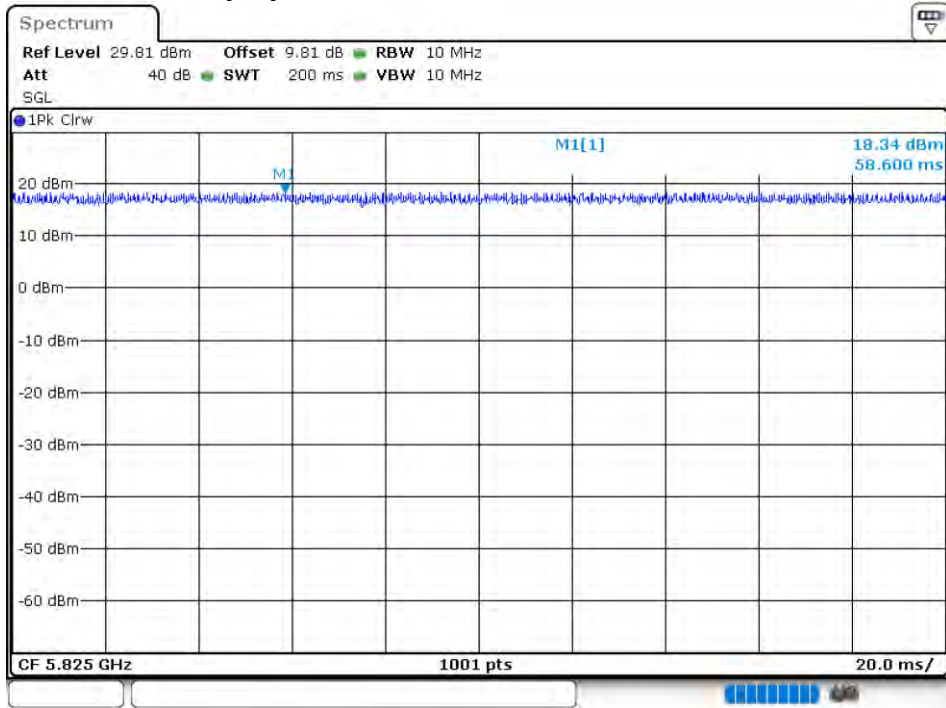

### Duty Cycle NVNT 802.11ac20 5745MHz Ant 2

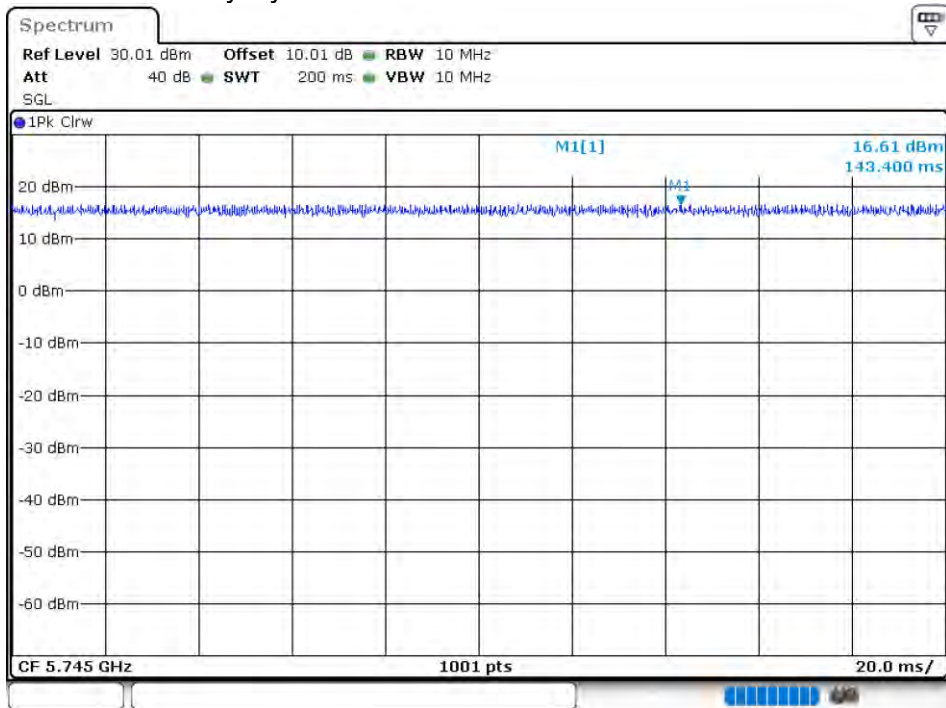

### Duty Cycle NVNT 802.11ac20 5785MHz Ant 2

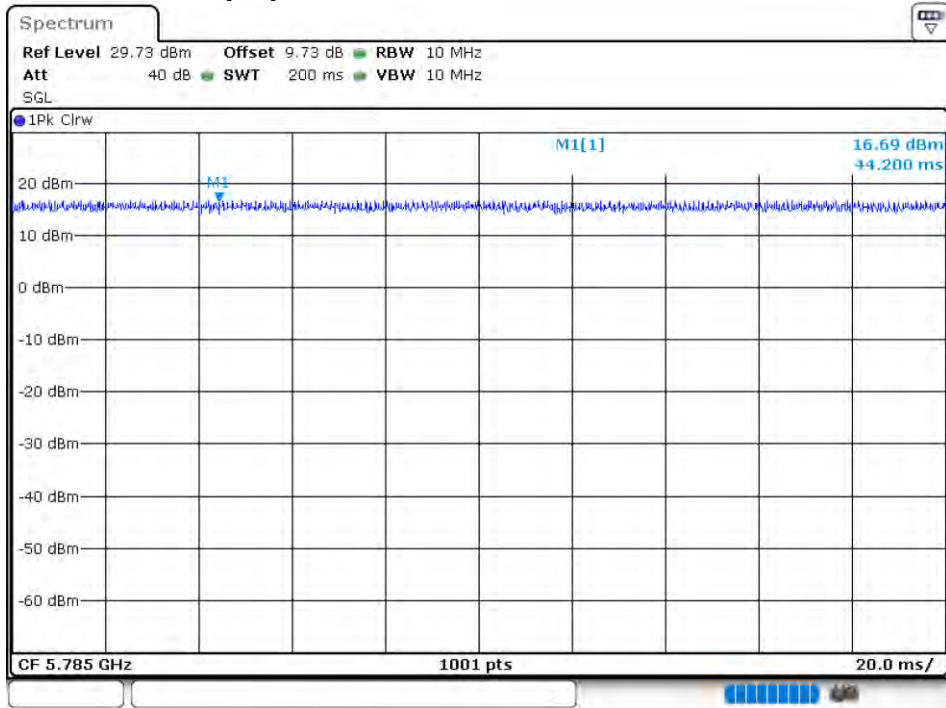

### Duty Cycle NVNT 802.11ac20 5825MHz Ant 2

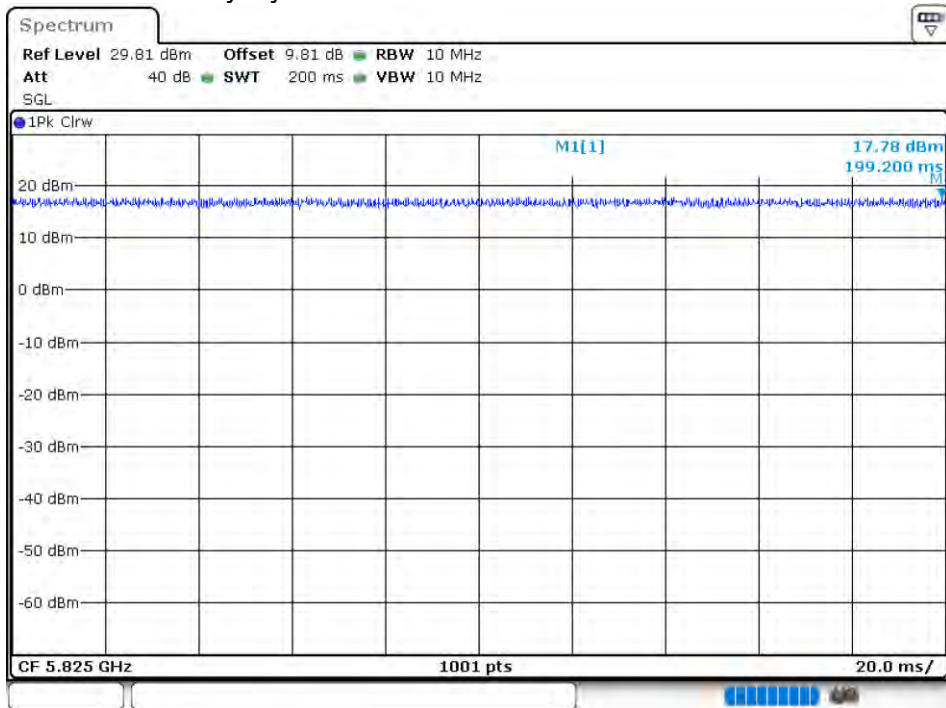

### Duty Cycle NVNT 802.11ac40 5755MHz Ant 1

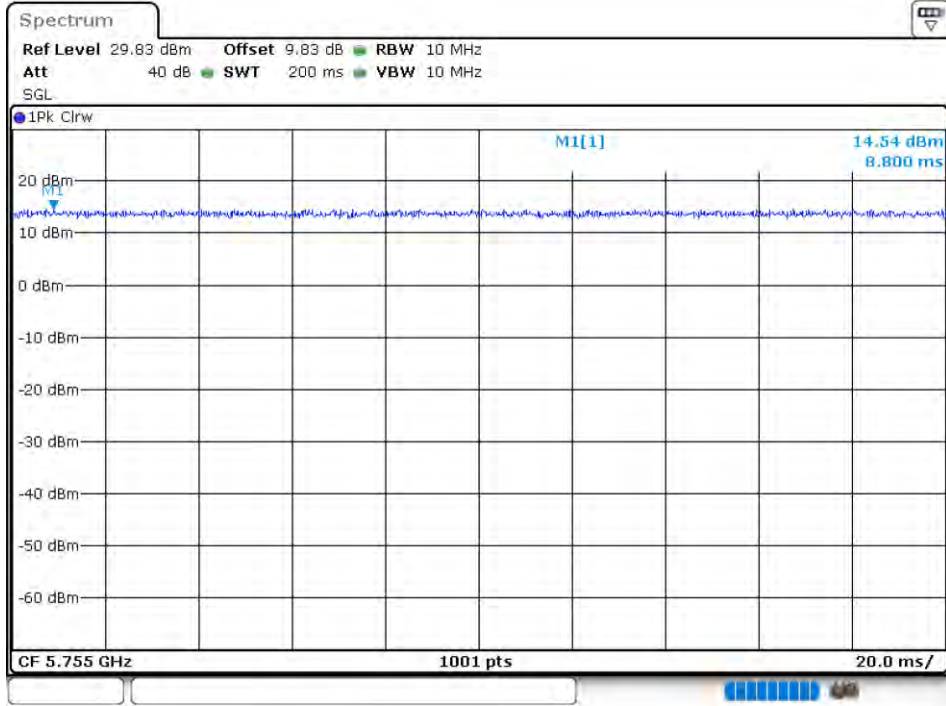

### Duty Cycle NVNT 802.11ac40 5795MHz Ant 1

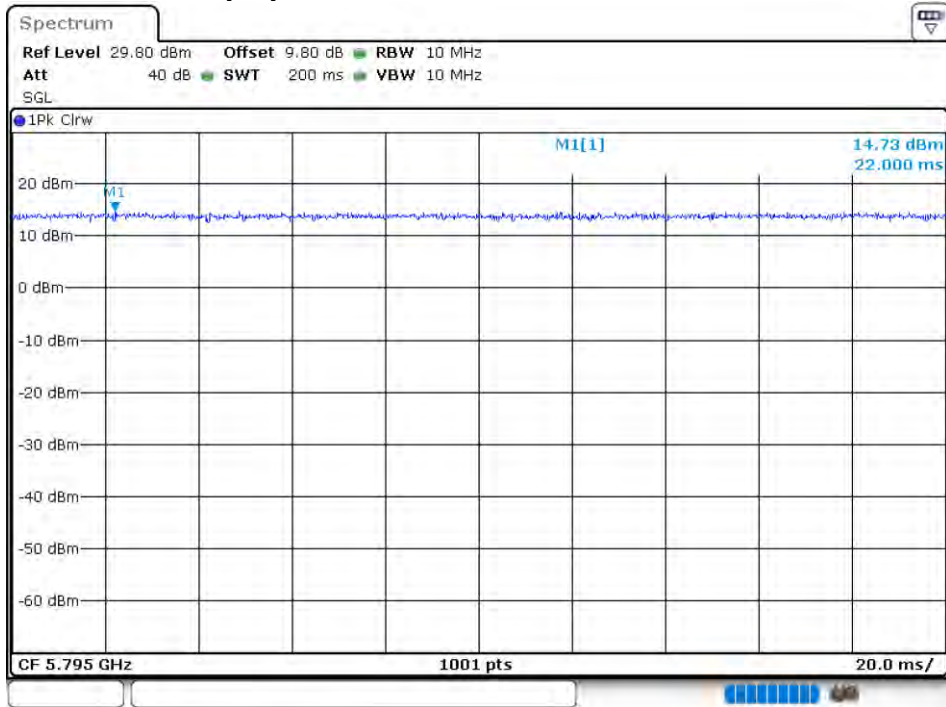



### Duty Cycle NVNT 802.11ac40 5755MHz Ant 2

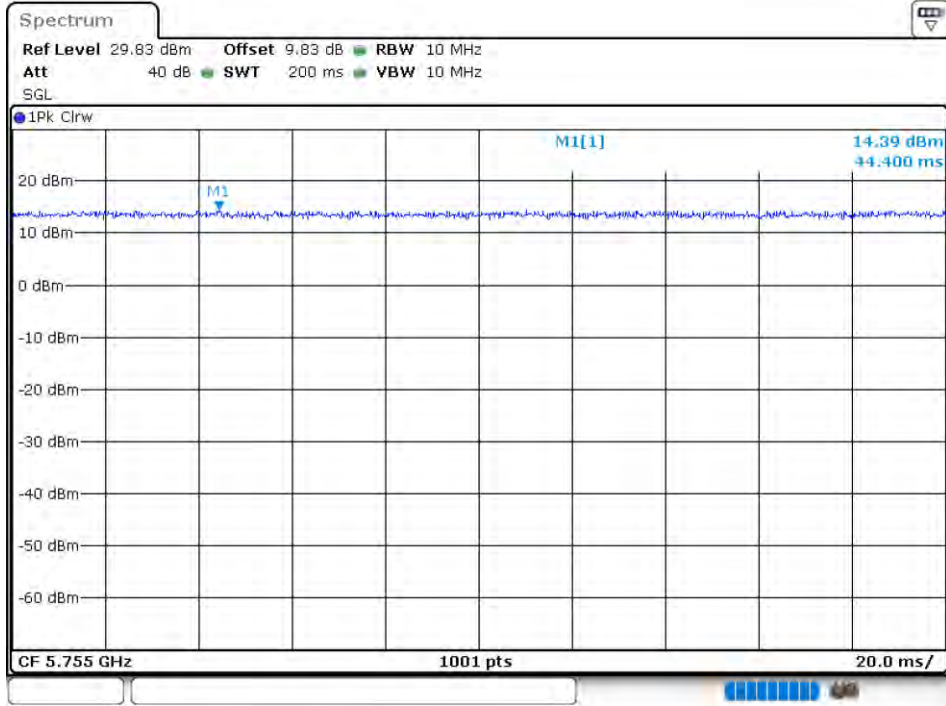

### Duty Cycle NVNT 802.11ac40 5795MHz Ant 2

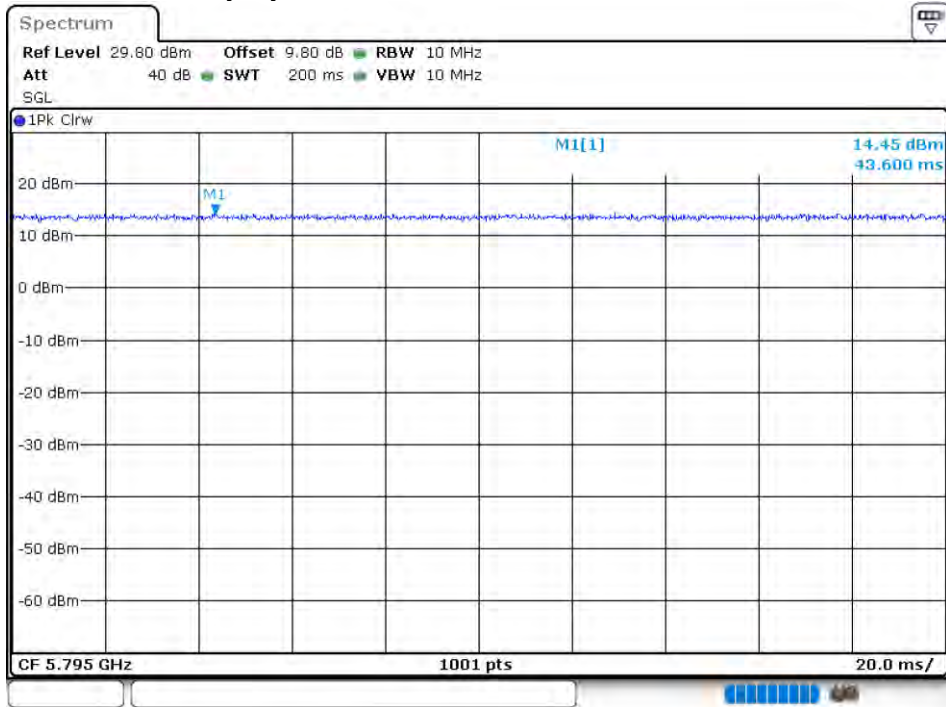

### Duty Cycle NVNT 802.11ac80 5775MHz Ant 1

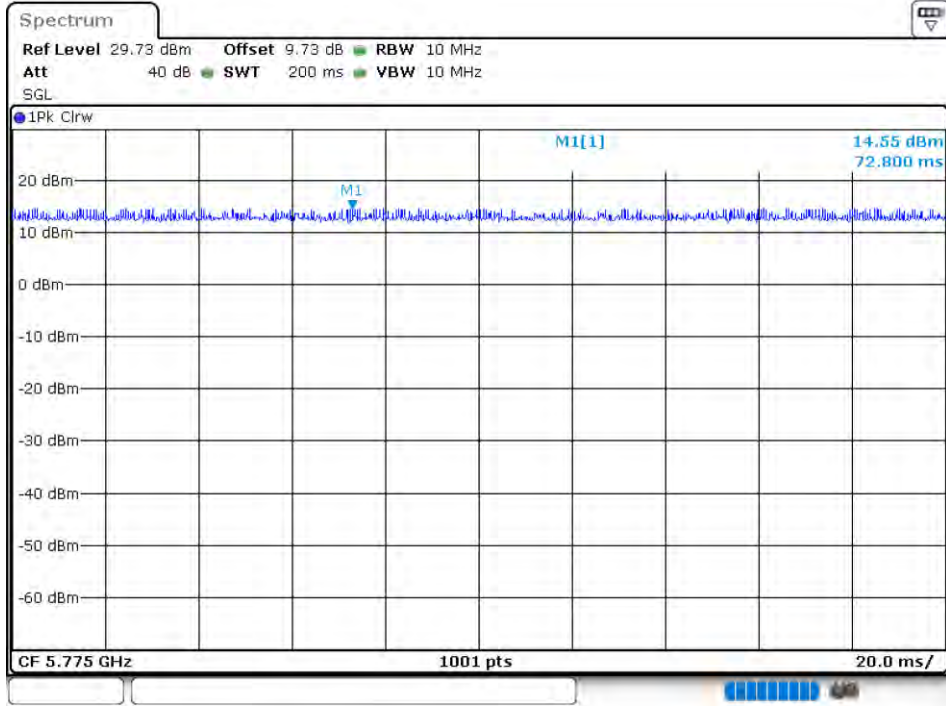

### Duty Cycle NVNT 802.11ac80 5775MHz Ant 2

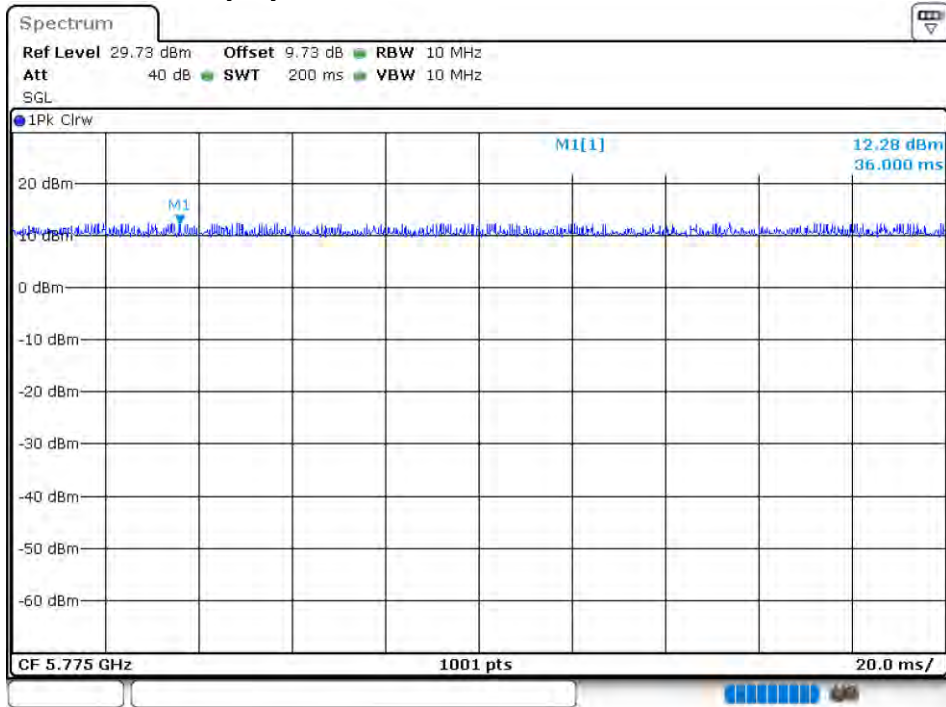

Duty Cycle NVNT 802.11n(HT20) 5745MHz Ant 1

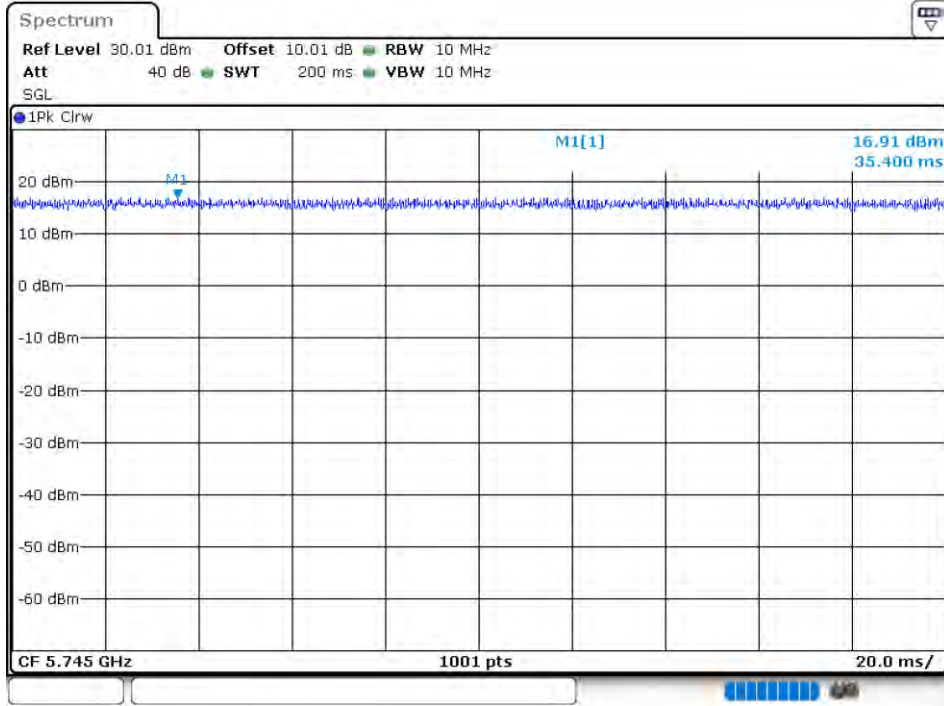

Duty Cycle NVNT 802.11n(HT20) 5785MHz Ant 1

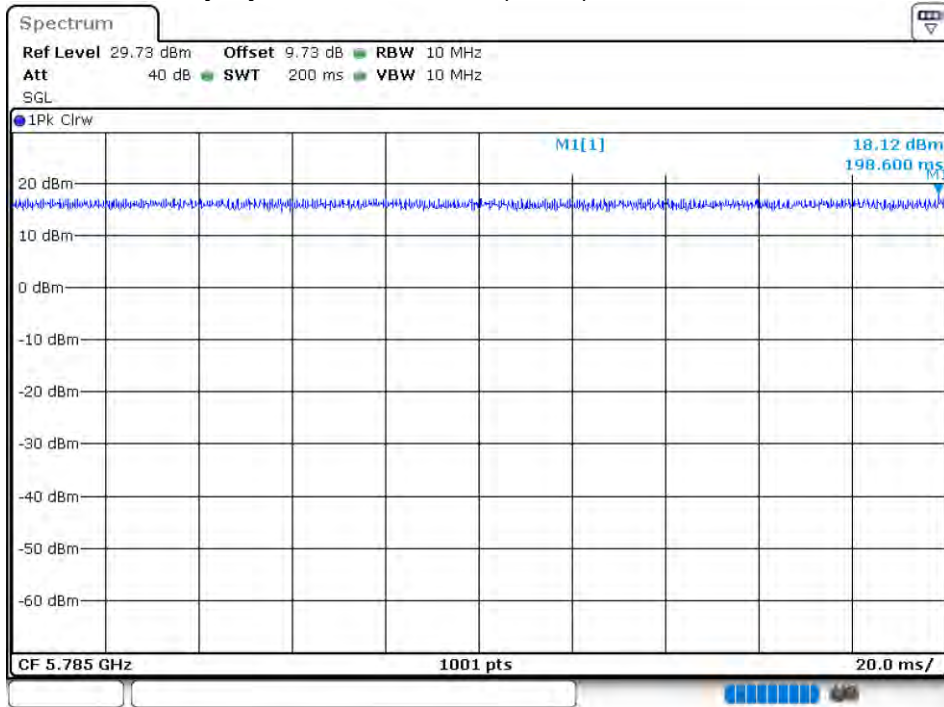



Duty Cycle NVNT 802.11n(HT20) 5825MHz Ant 1

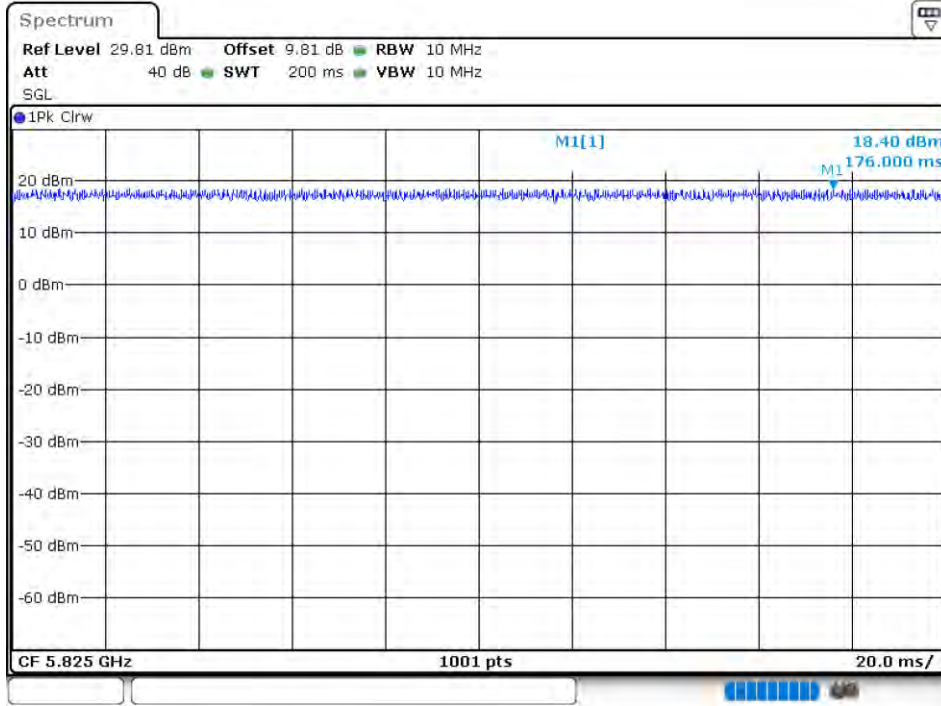

Duty Cycle NVNT 802.11n(HT20) 5745MHz Ant 2

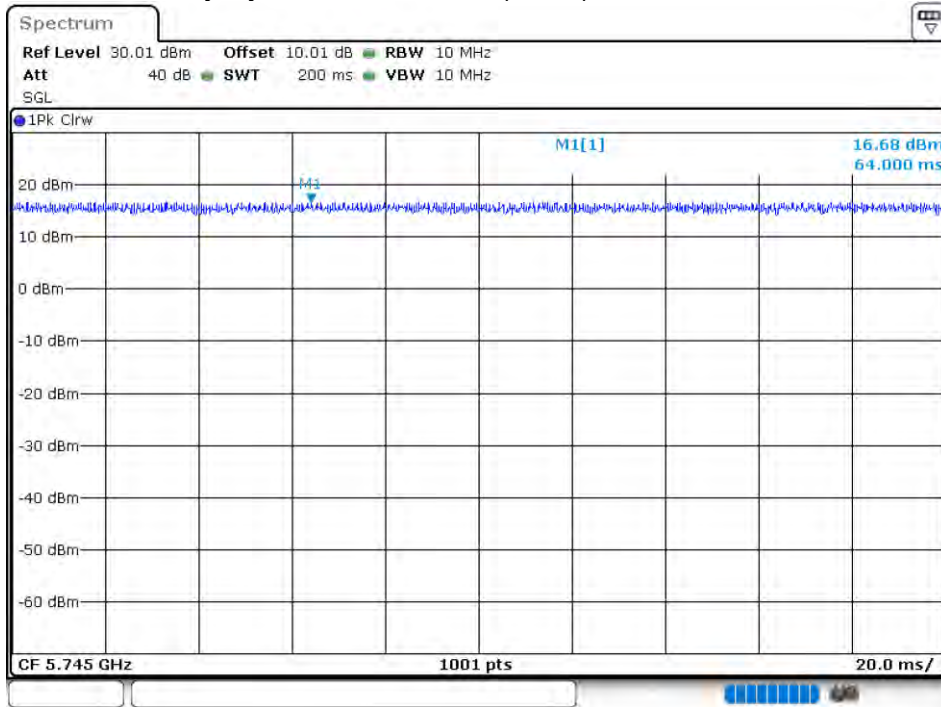

### Duty Cycle NVNT 802.11n(HT20) 5785MHz Ant 2

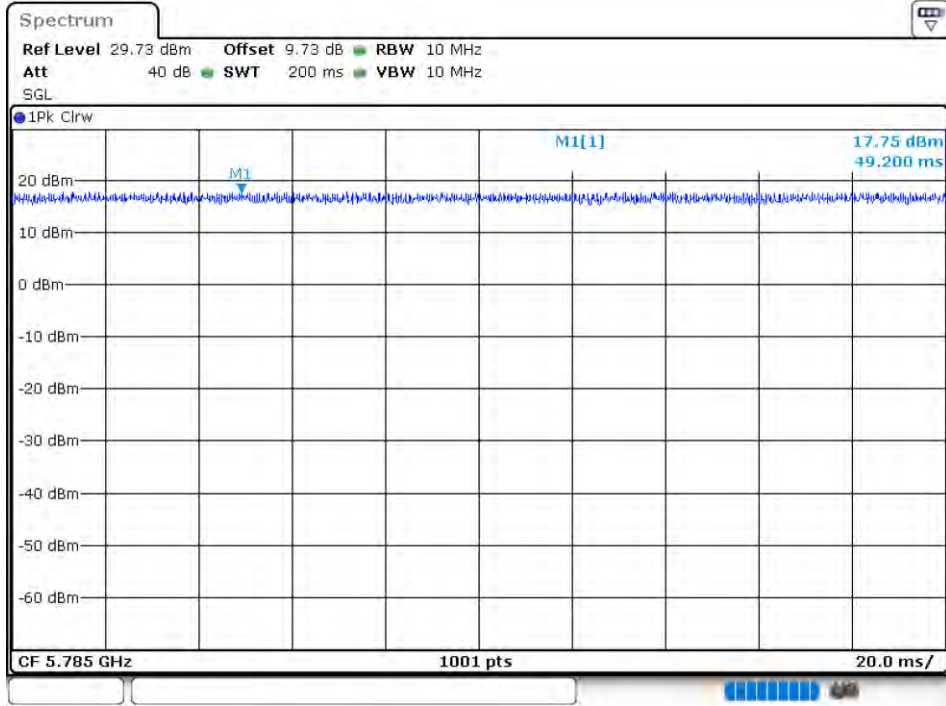

### Duty Cycle NVNT 802.11n(HT20) 5825MHz Ant 2

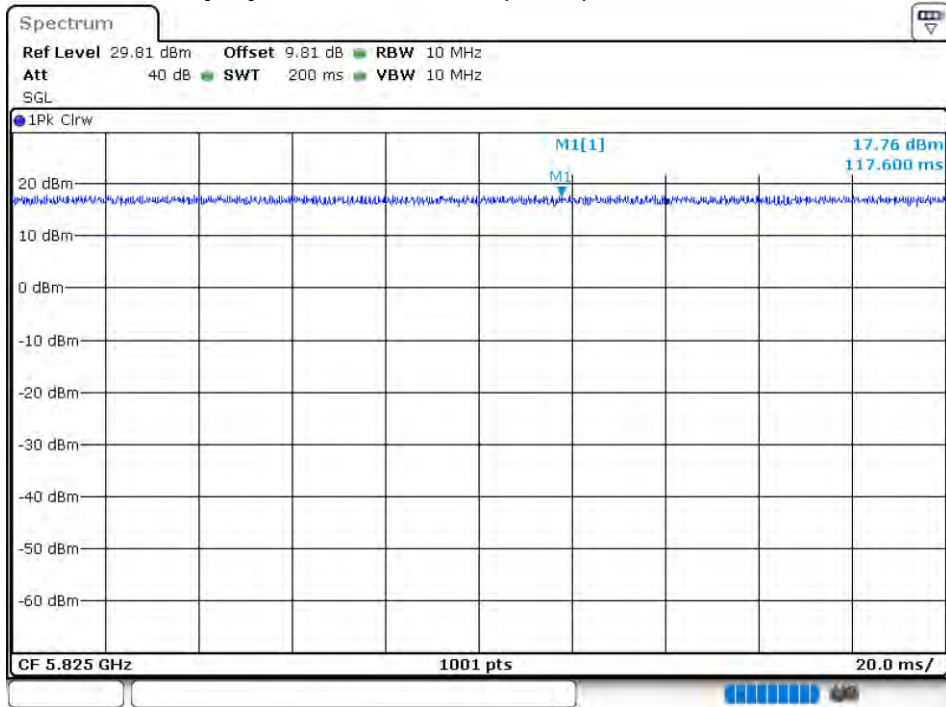

Duty Cycle NVNT 802.11n(HT40) 5755MHz Ant 1

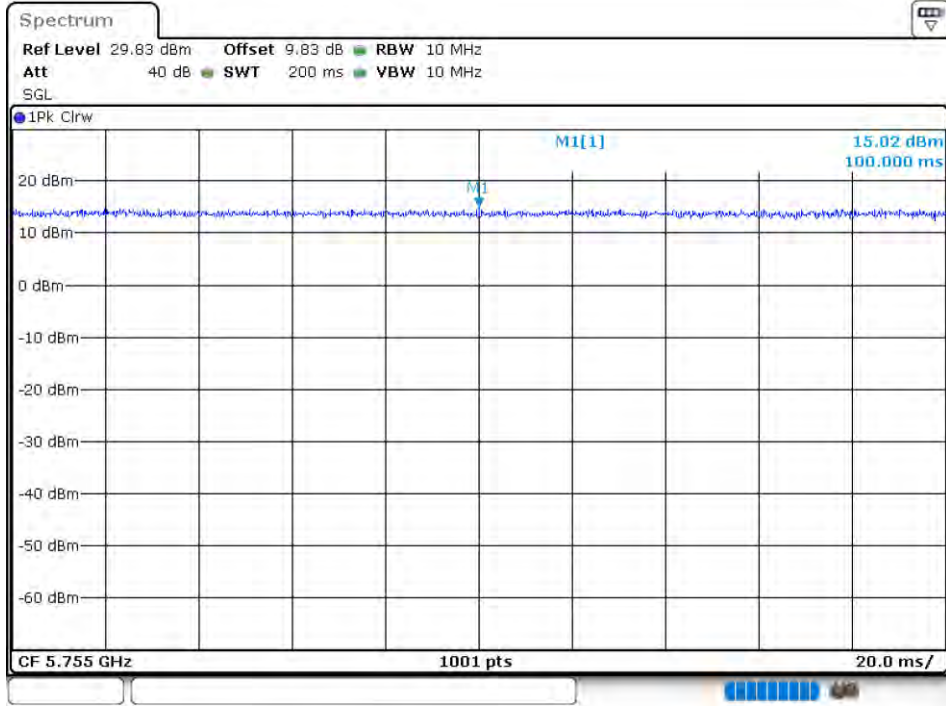

Duty Cycle NVNT 802.11n(HT40) 5795MHz Ant 1

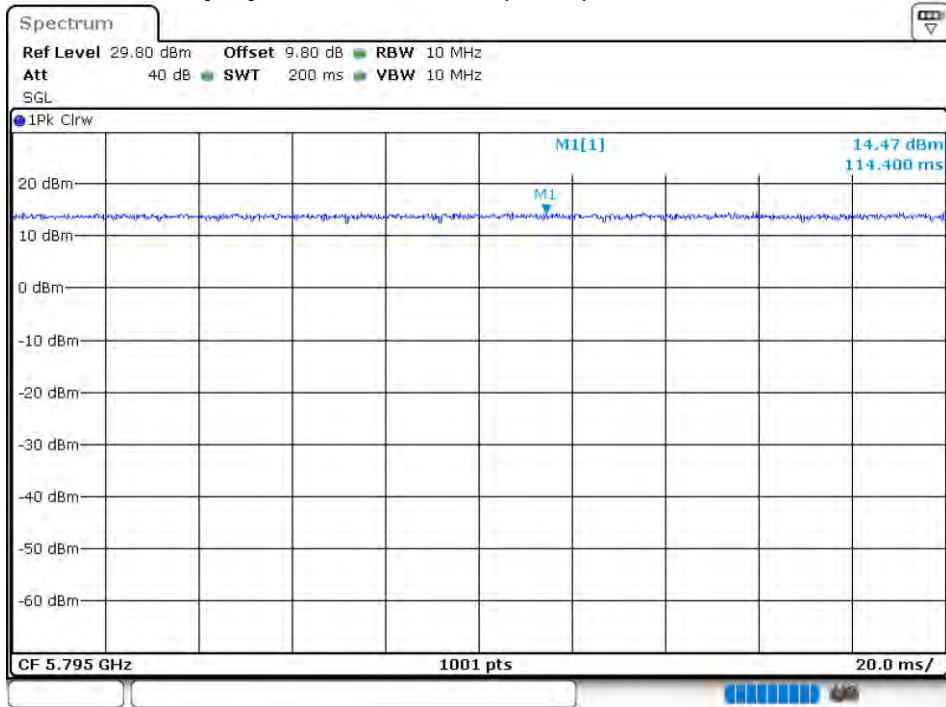

Duty Cycle NVNT 802.11n(HT40) 5755MHz Ant 2

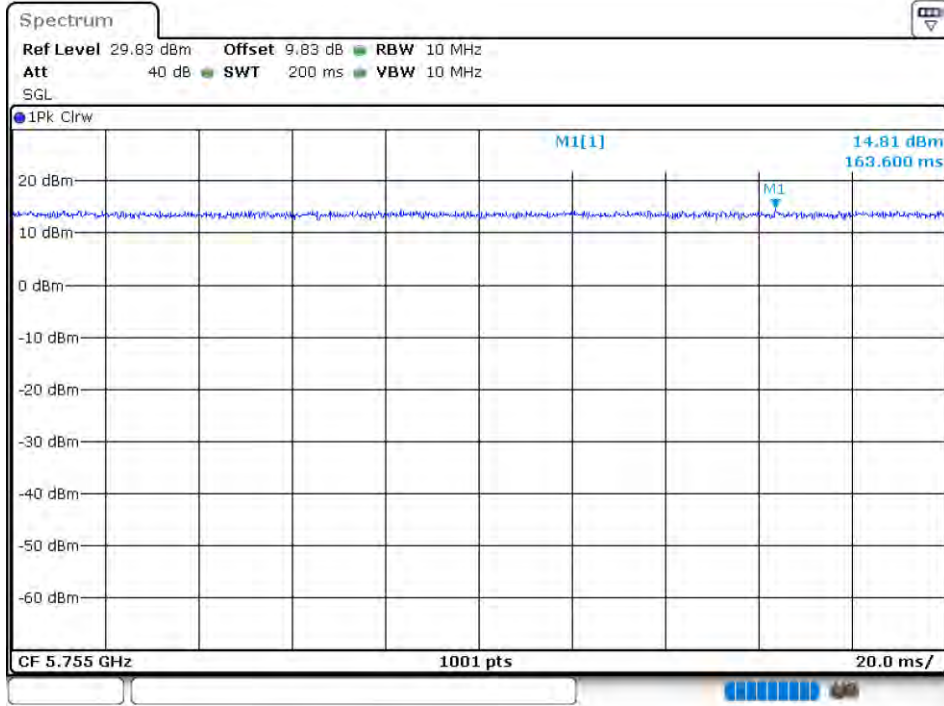

Duty Cycle NVNT 802.11n(HT40) 5795MHz Ant 2

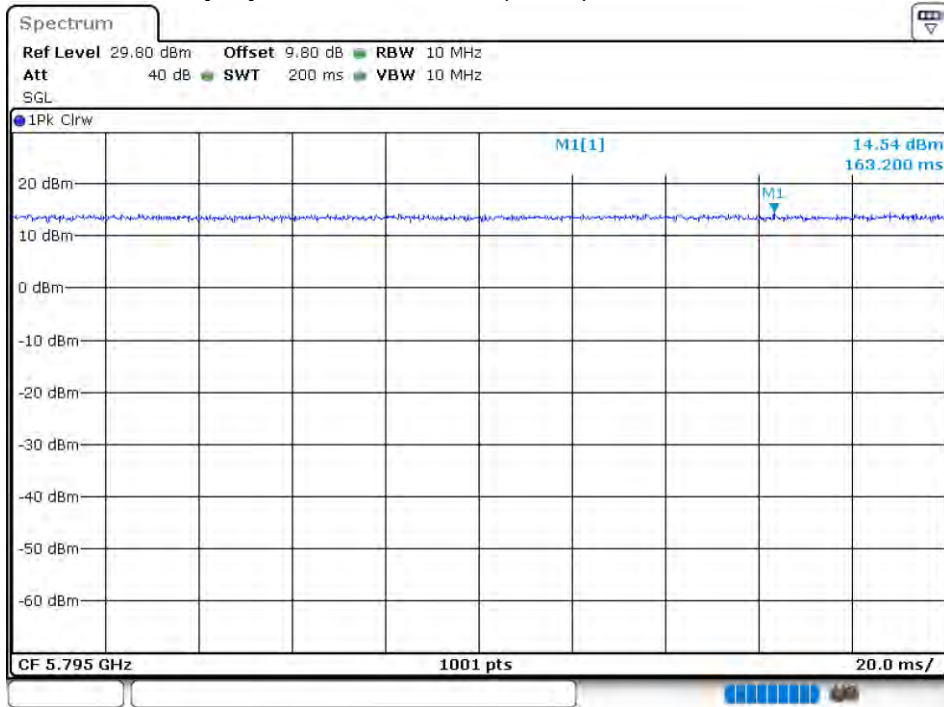

MMO

Condition	Mode	Frequency (MHz)	Duty Cycle (%)	Correction Factor (dB)
NVNT	802.11ac20	5745	100	0
NVNT	802.11ac20	5785	100	0
NVNT	802.11ac20	5825	100	0
NVNT	802.11ac40	5755	100	0
NVNT	802.11ac40	5795	100	0
NVNT	802.11ac80	5775	100	0
NVNT	802.11n(HT20)	5745	100	0
NVNT	802.11n(HT20)	5785	100	0
NVNT	802.11n(HT20)	5825	100	0
NVNT	802.11n(HT40)	5755	100	0
NVNT	802.11n(HT40)	5795	100	0

Duty Cycle NVNT 802.11ac20 5745MHz

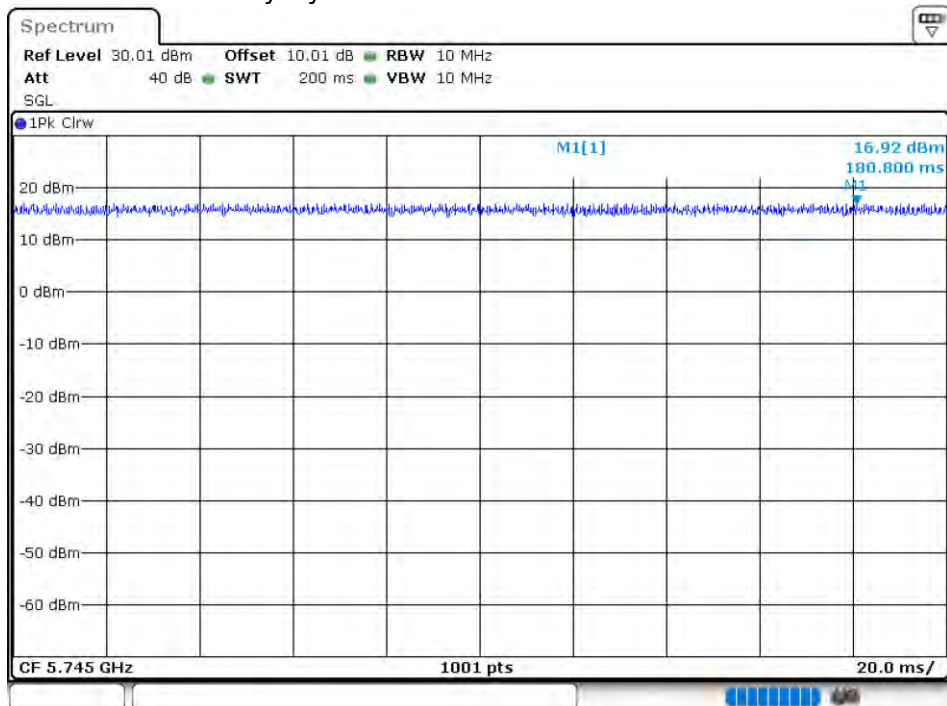



### Duty Cycle NVNT 802.11ac20 5785MHz

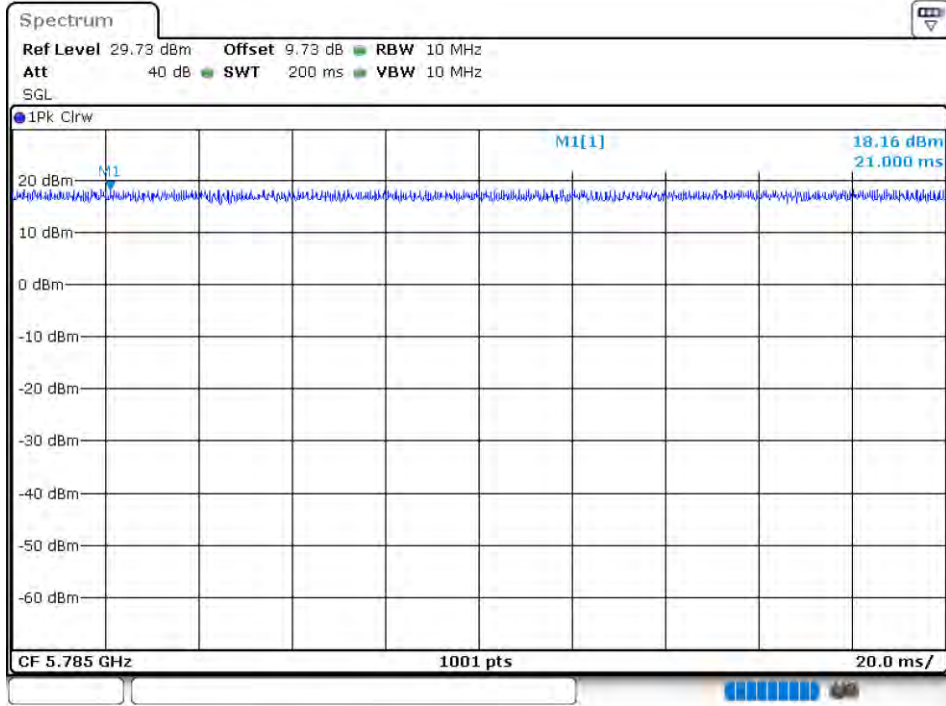

### Duty Cycle NVNT 802.11ac20 5825MHz

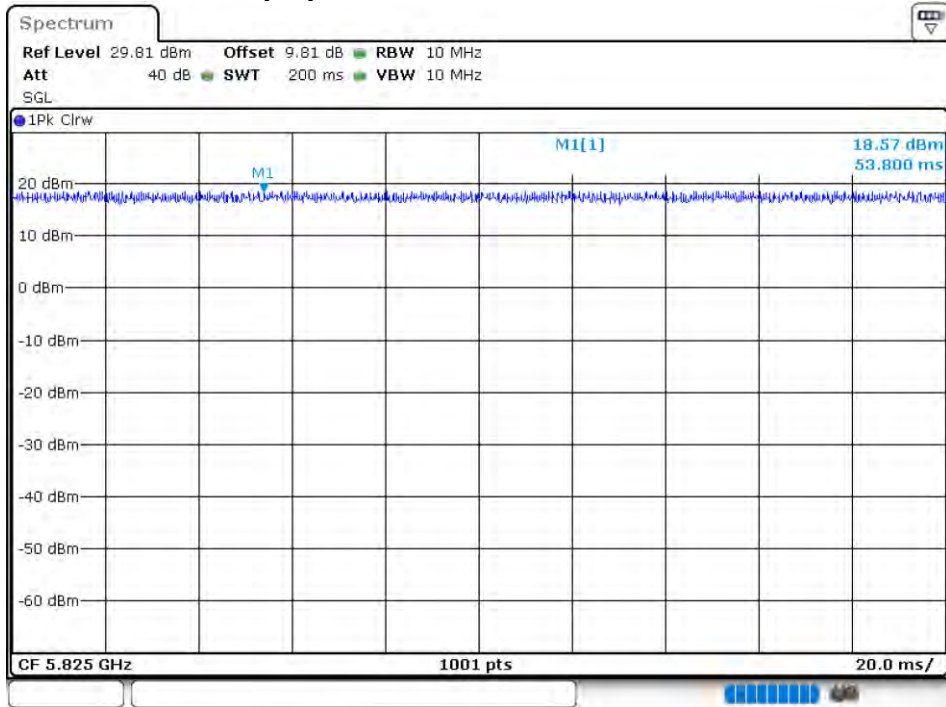

### Duty Cycle NVNT 802.11ac40 5755MHz

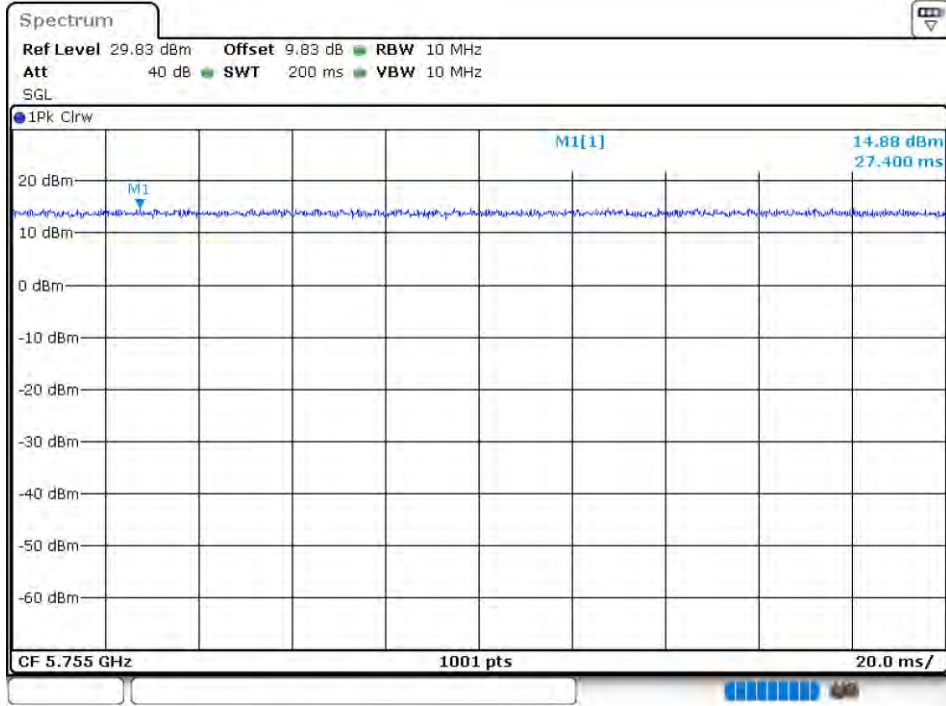

### Duty Cycle NVNT 802.11ac40 5795MHz

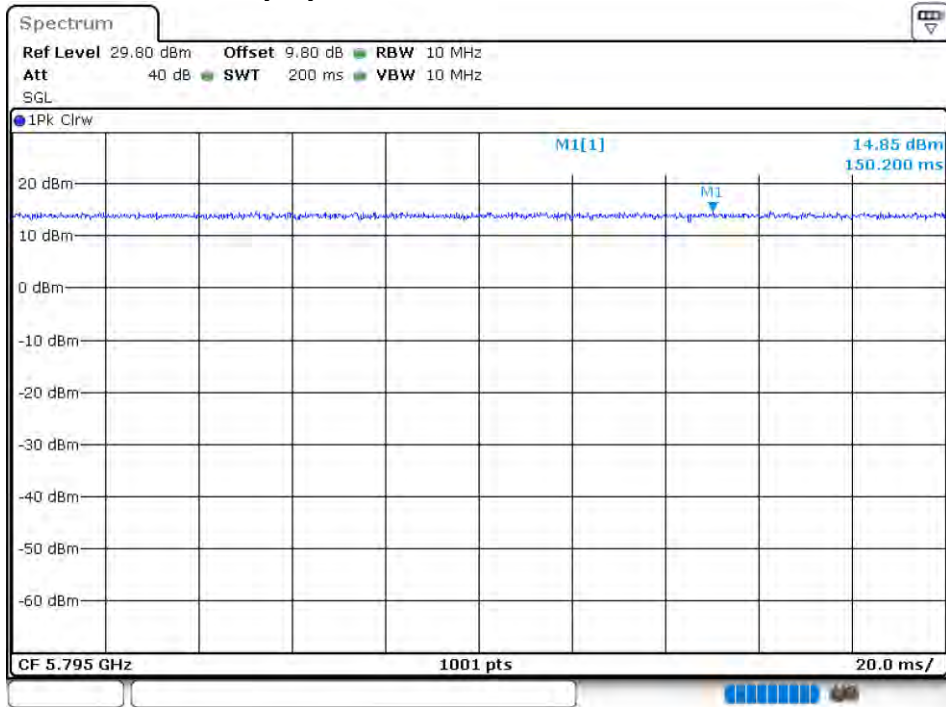

### Duty Cycle NVNT 802.11ac80 5775MHz

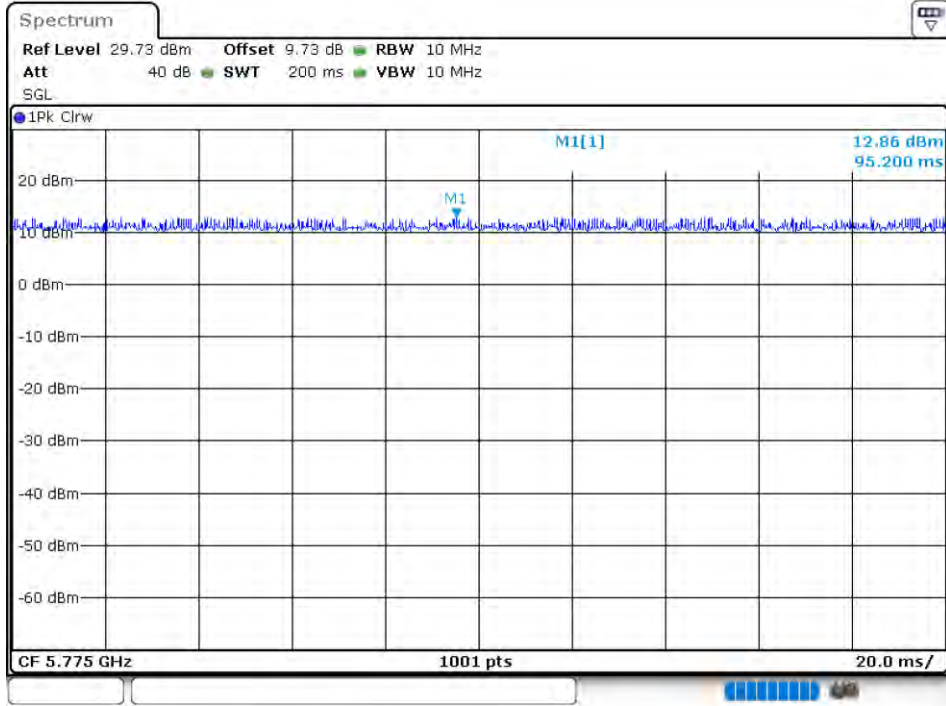

### Duty Cycle NVNT 802.11n(HT20) 5745MHz

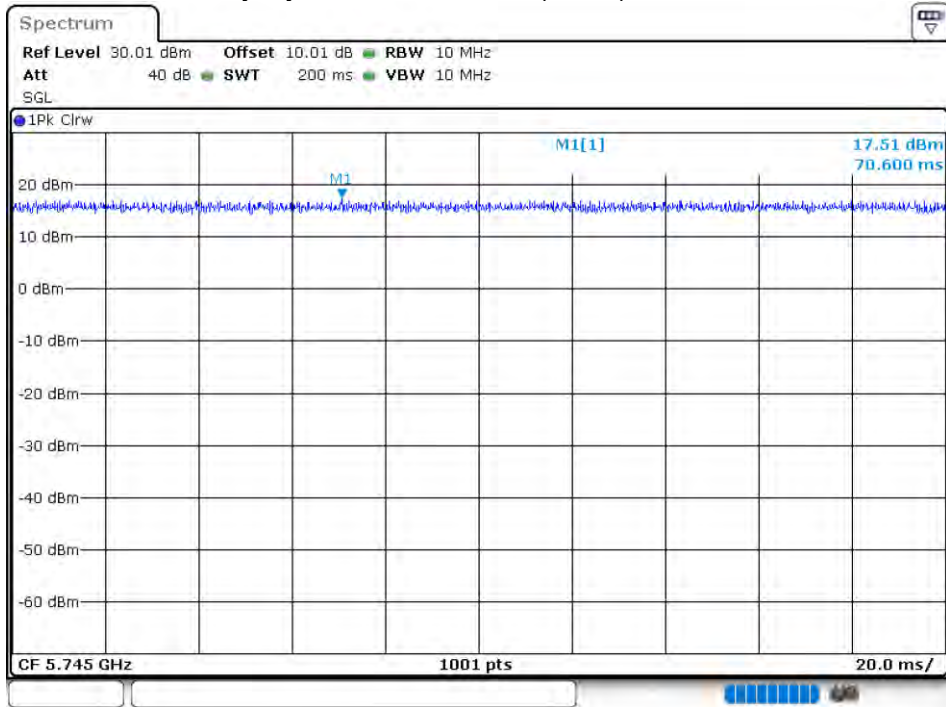



Duty Cycle NVNT 802.11n(HT20) 5785MHz

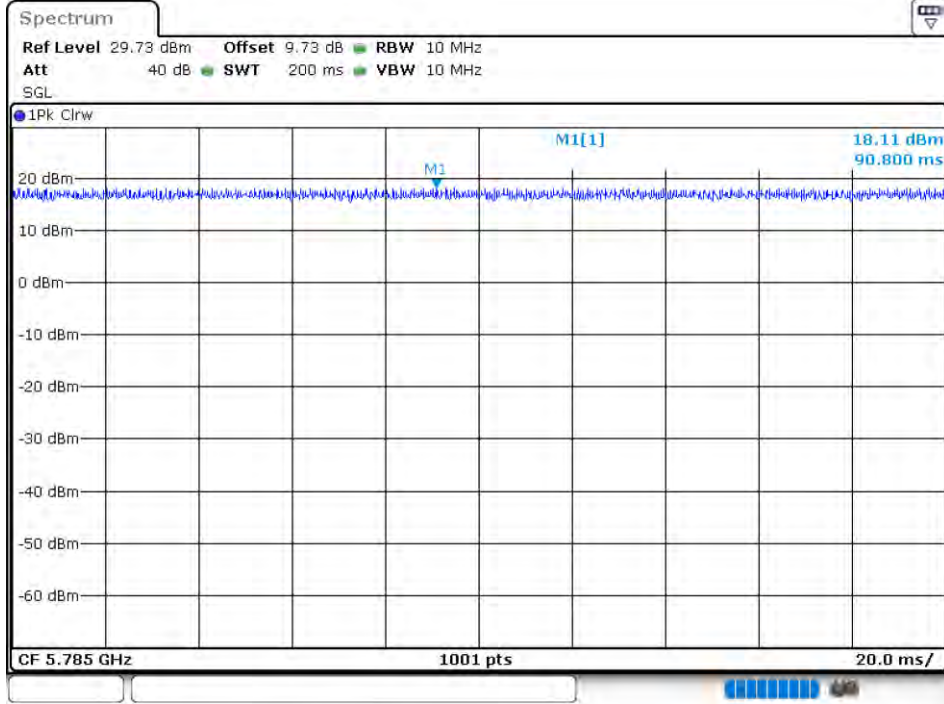

Duty Cycle NVNT 802.11n(HT20) 5825MHz

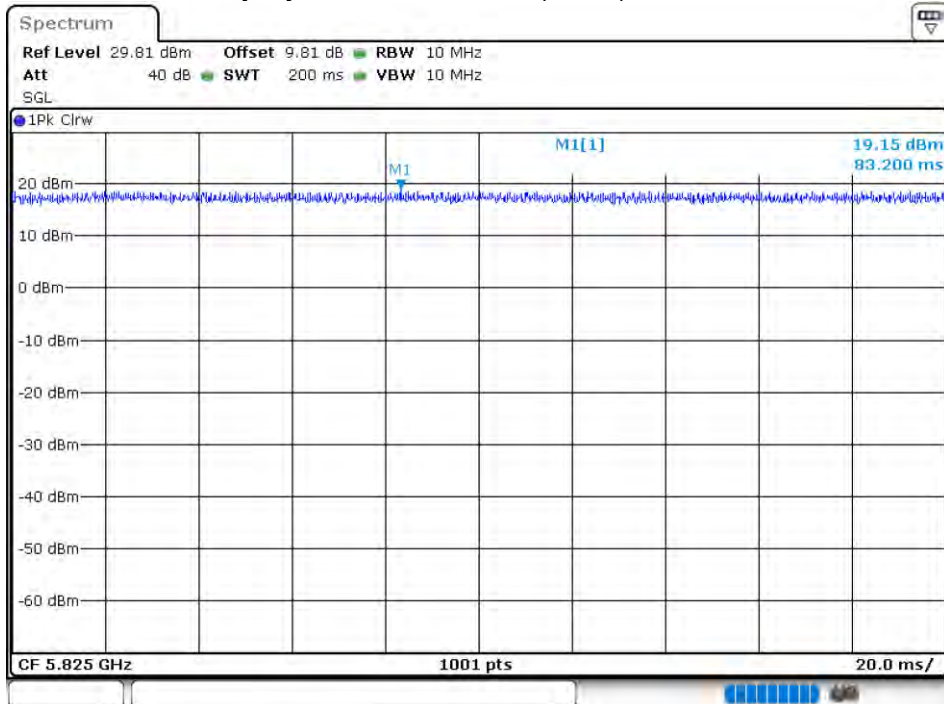

### Duty Cycle NVNT 802.11n(HT40) 5755MHz

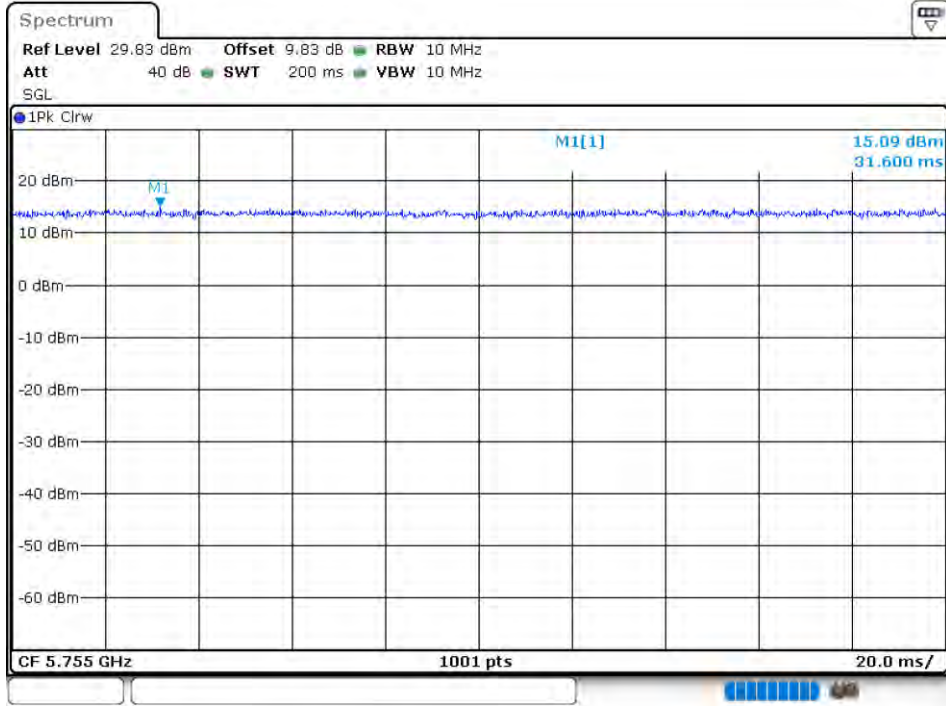

### Duty Cycle NVNT 802.11n(HT40) 5795MHz

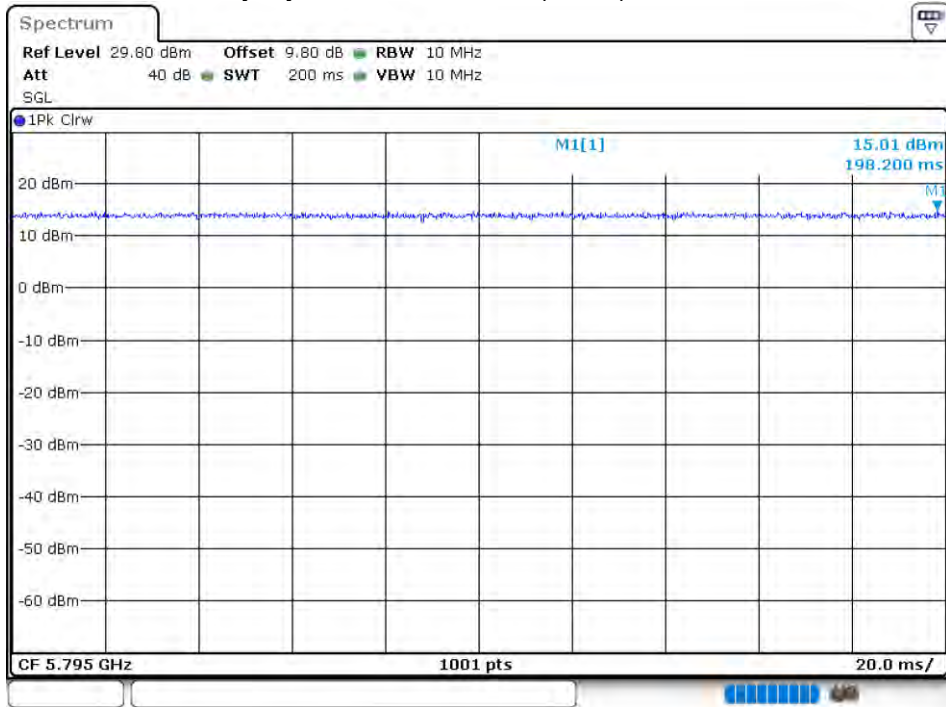

5.2 MAXIMUM CONDUCTED OUTPUT POWER

Condition	Mode	Frequency (MHz)	Antenna	Conducted Power (dBm)	Total Conducted Power (dBm)	Limit (dBm)	Verdict
NVNT	a	5745	Ant 1	8.72		30	Pass
NVNT	a	5785	Ant 1	9.4		30	Pass
NVNT	a	5825	Ant 1	10.32		30	Pass
NVNT	a	5745	Ant 2	8.58		30	Pass
NVNT	a	5785	Ant 2	10.04		30	Pass
NVNT	a	5825	Ant 2	10.13		30	Pass
NVNT	ac20	5745	Ant 1	8.87	11.79	30	Pass
NVNT	ac20	5745	Ant 2	8.68			
NVNT	ac20	5785	Ant 1	9.57	12.40	30	Pass
NVNT	ac20	5785	Ant 2	9.2			
NVNT	ac20	5825	Ant 1	10.5	13.42	30	Pass
NVNT	ac20	5825	Ant 2	10.32			
NVNT	ac40	5755	Ant 1	10.05	13.00	30	Pass
NVNT	ac40	5755	Ant 2	9.93			
NVNT	ac40	5795	Ant 1	10.09	12.96	30	Pass
NVNT	ac40	5795	Ant 2	9.8			
NVNT	ac80	5775	Ant 1	10.91	12.92	30	Pass
NVNT	ac80	5775	Ant 2	8.62			
NVNT	n20	5745	Ant 1	8.95	11.80	30	Pass
NVNT	n20	5745	Ant 2	8.63			
NVNT	n20	5785	Ant 1	9.56	12.96	30	Pass
NVNT	n20	5785	Ant 2	10.31			
NVNT	n20	5825	Ant 1	14.66	16.03	30	Pass
NVNT	n20	5825	Ant 2	10.35			
NVNT	n40	5755	Ant 1	9.97	13.04	30	Pass
NVNT	n40	5755	Ant 2	10.08			
NVNT	n40	5795	Ant 1	9.85	12.81	30	Pass
NVNT	n40	5795	Ant 2	9.75			

5.3-6DB EMISSION BANDWIDTH

SISO

Condition	Mode	Frequency (MHz)	Antenna	-6 dB Bandwidth (MHz)	Limit -6 dB Bandwidth (MHz)	Verdict
NVNT	802.11a	5745	Ant 1	15.96	0.5	Pass
NVNT	802.11a	5785	Ant 1	16.32	0.5	Pass
NVNT	802.11a	5825	Ant 1	16.32	0.5	Pass
NVNT	802.11a	5745	Ant 2	16.28	0.5	Pass
NVNT	802.11a	5785	Ant 2	16.32	0.5	Pass
NVNT	802.11a	5825	Ant 2	16.32	0.5	Pass
NVNT	802.11ac20	5745	Ant 1	17.56	0.5	Pass
NVNT	802.11ac20	5785	Ant 1	17.52	0.5	Pass
NVNT	802.11ac20	5825	Ant 1	17.56	0.5	Pass
NVNT	802.11ac20	5745	Ant 2	17.56	0.5	Pass
NVNT	802.11ac20	5785	Ant 2	17.56	0.5	Pass
NVNT	802.11ac20	5825	Ant 2	17.52	0.5	Pass
NVNT	802.11ac40	5755	Ant 1	34.48	0.5	Pass
NVNT	802.11ac40	5795	Ant 1	34.16	0.5	Pass
NVNT	802.11ac40	5755	Ant 2	35.04	0.5	Pass
NVNT	802.11ac40	5795	Ant 2	35.04	0.5	Pass
NVNT	802.11ac80	5775	Ant 1	66.4	0.5	Pass
NVNT	802.11ac80	5775	Ant 2	75.04	0.5	Pass
NVNT	802.11n(HT20)	5745	Ant 1	16.56	0.5	Pass
NVNT	802.11n(HT20)	5785	Ant 1	17.52	0.5	Pass
NVNT	802.11n(HT20)	5825	Ant 1	17.56	0.5	Pass
NVNT	802.11n(HT20)	5745	Ant 2	17.56	0.5	Pass
NVNT	802.11n(HT20)	5785	Ant 2	17.52	0.5	Pass
NVNT	802.11n(HT20)	5825	Ant 2	17.6	0.5	Pass
NVNT	802.11n(HT40)	5755	Ant 1	34.48	0.5	Pass
NVNT	802.11n(HT40)	5795	Ant 1	35.2	0.5	Pass
NVNT	802.11n(HT40)	5755	Ant 2	35.68	0.5	Pass
NVNT	802.11n(HT40)	5795	Ant 2	33.92	0.5	Pass

EBW NVNT 802.11a 5745MHz Ant 1

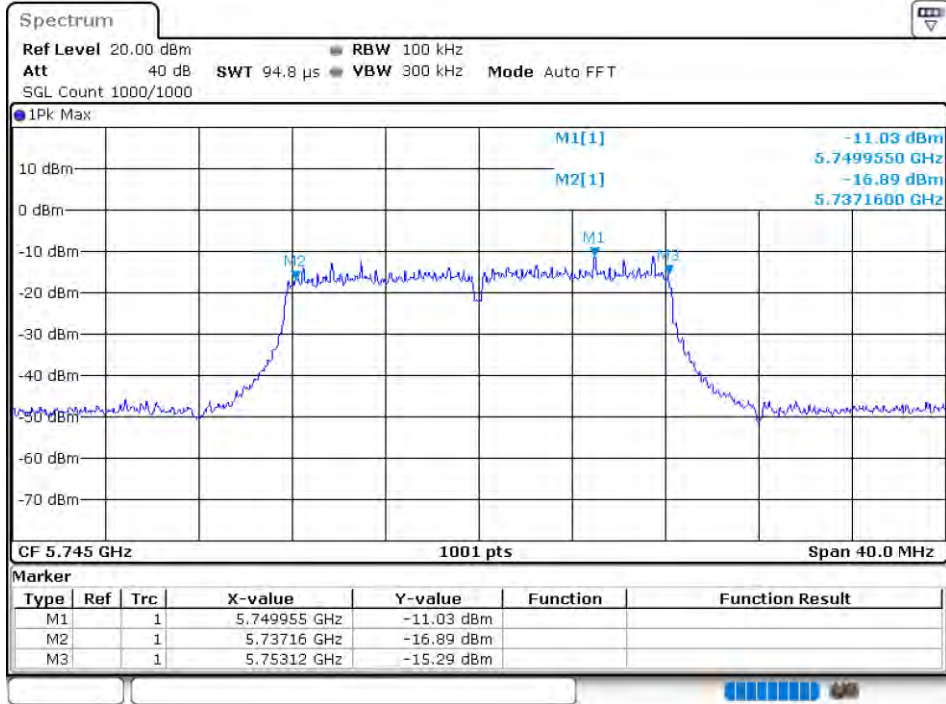

EBW NVNT 802.11a 5785MHz Ant 1

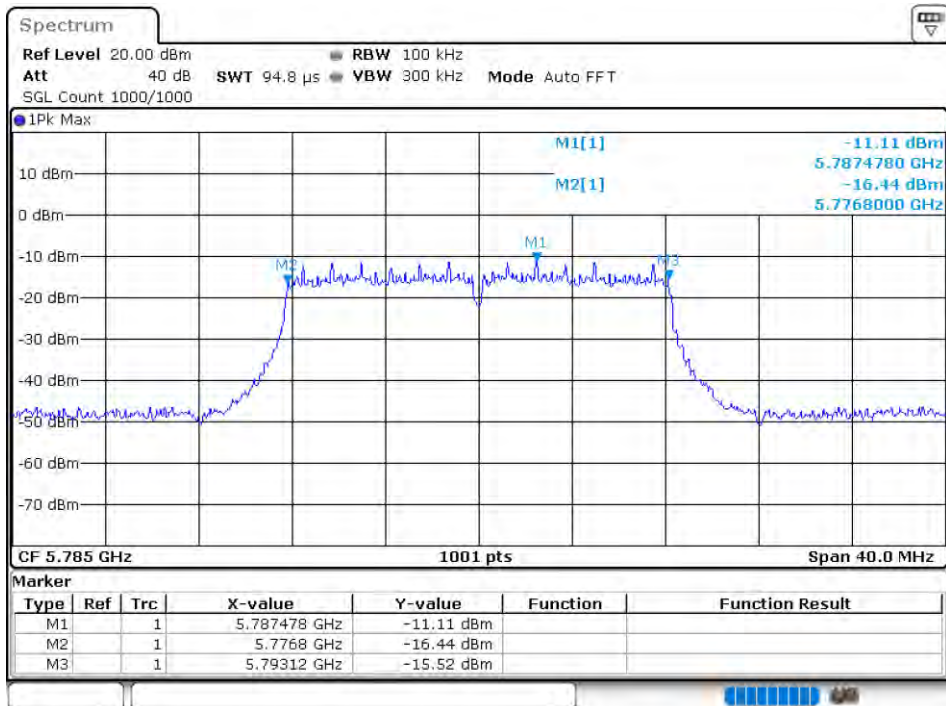



EBW NVNT 802.11a 5825MHz Ant 1

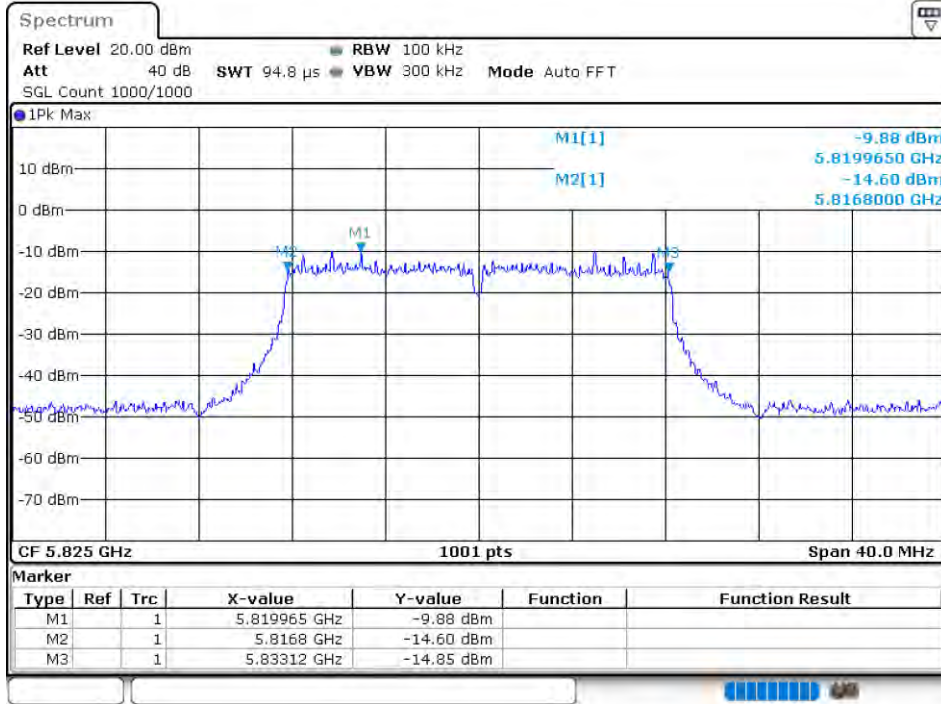

EBW NVNT 802.11a 5745MHz Ant 2

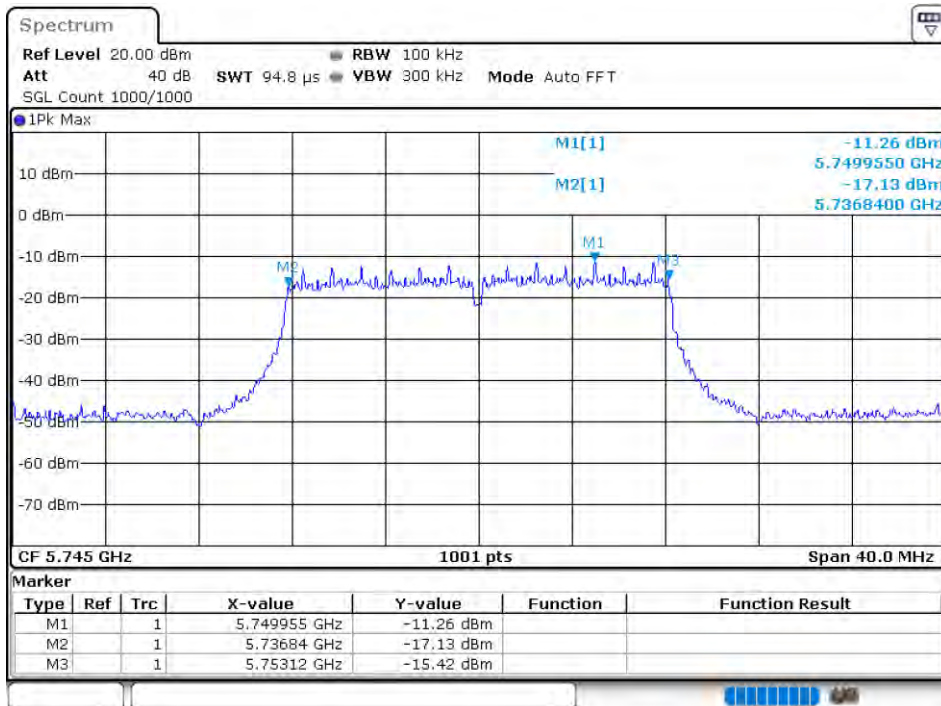

EBW NVNT 802.11a 5785MHz Ant 2

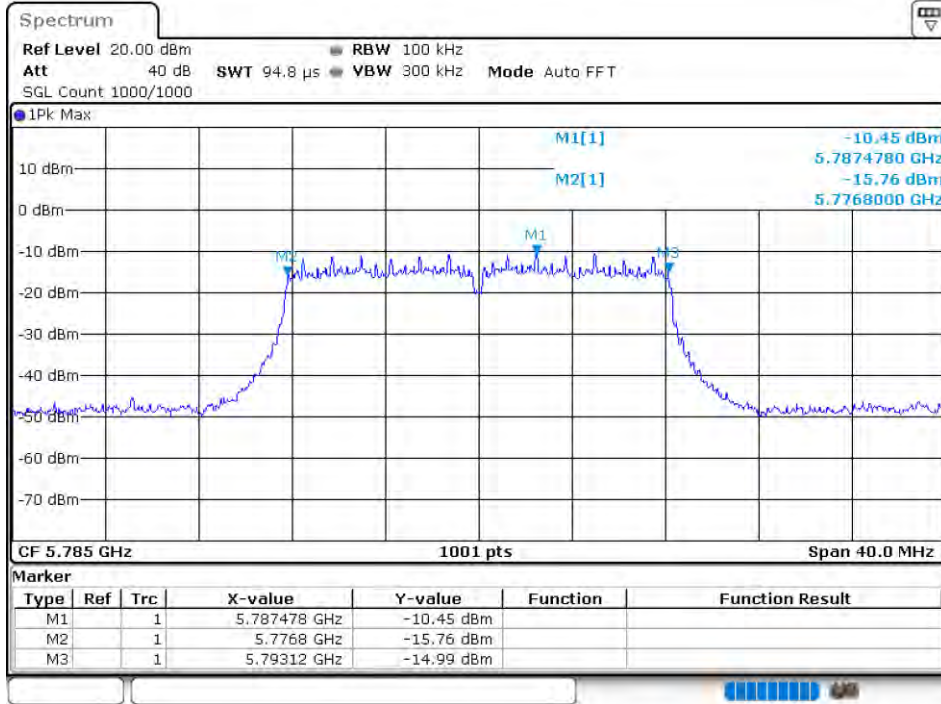

EBW NVNT 802.11a 5825MHz Ant 2

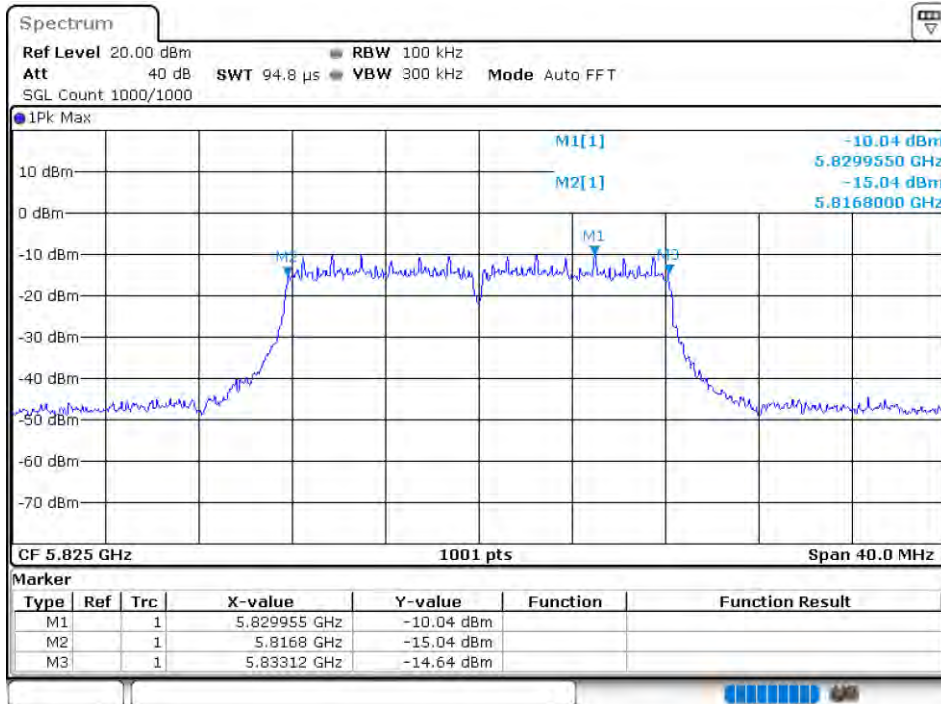

EBW NVNT 802.11ac20 5745MHz Ant 1

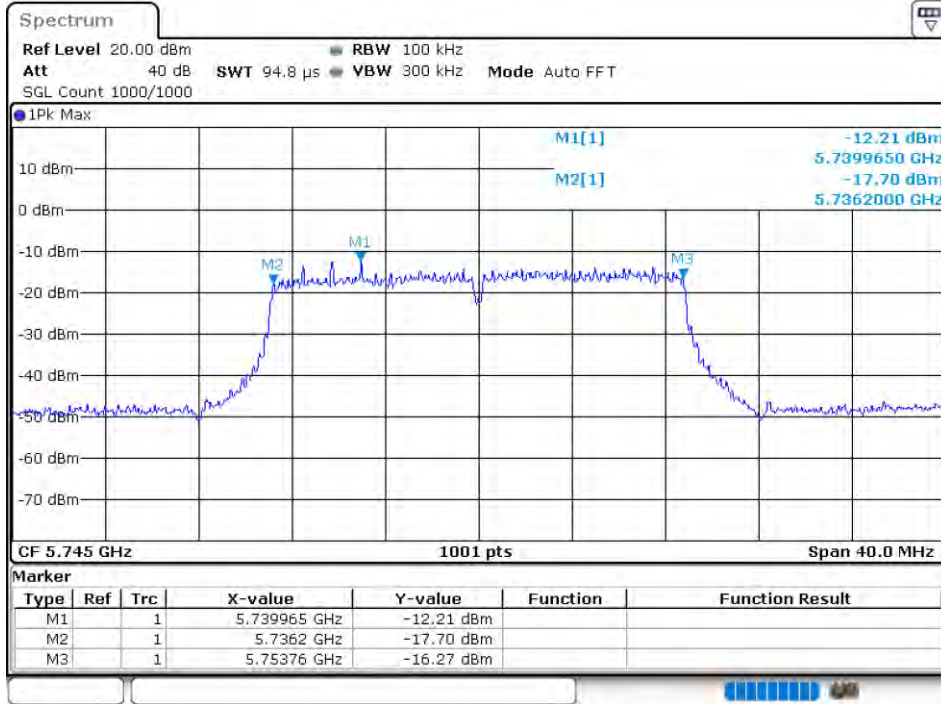

EBW NVNT 802.11ac20 5785MHz Ant 1

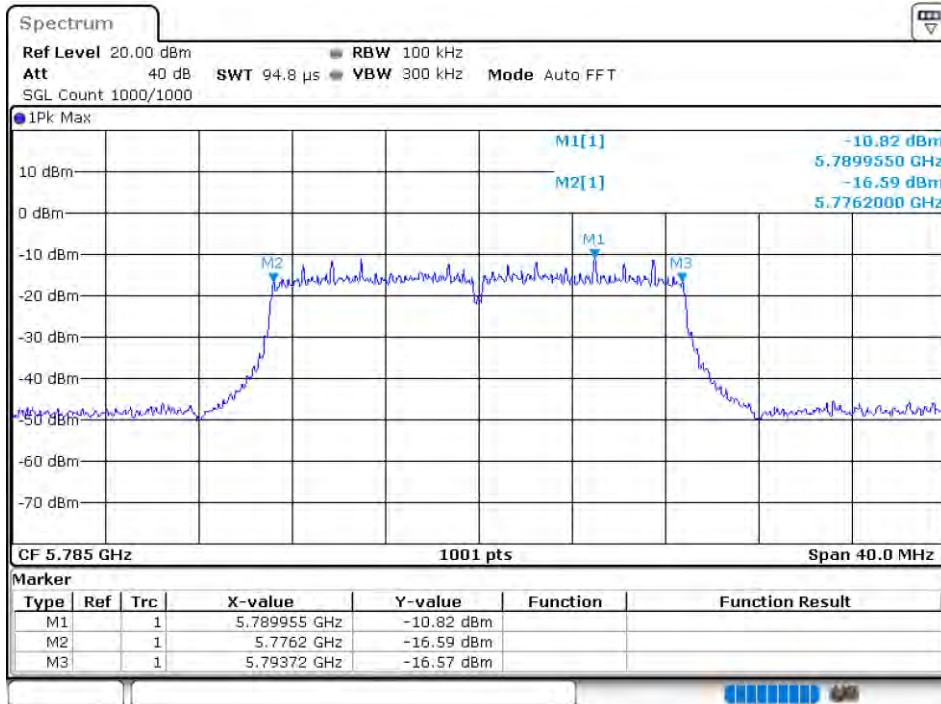



EBW NVNT 802.11ac20 5825MHz Ant 1

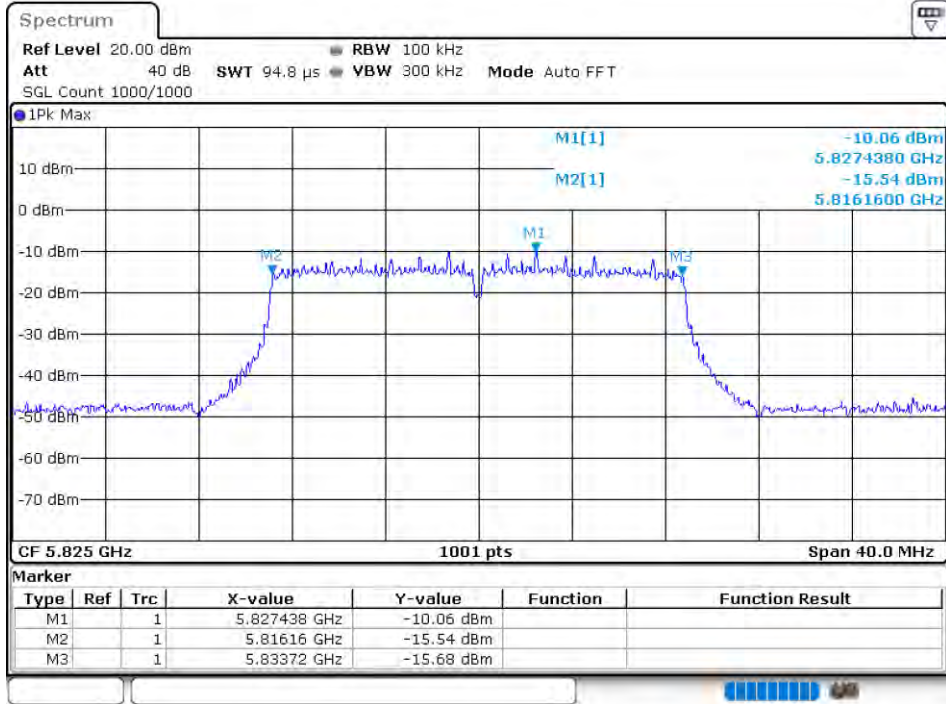

EBW NVNT 802.11ac20 5745MHz Ant 2

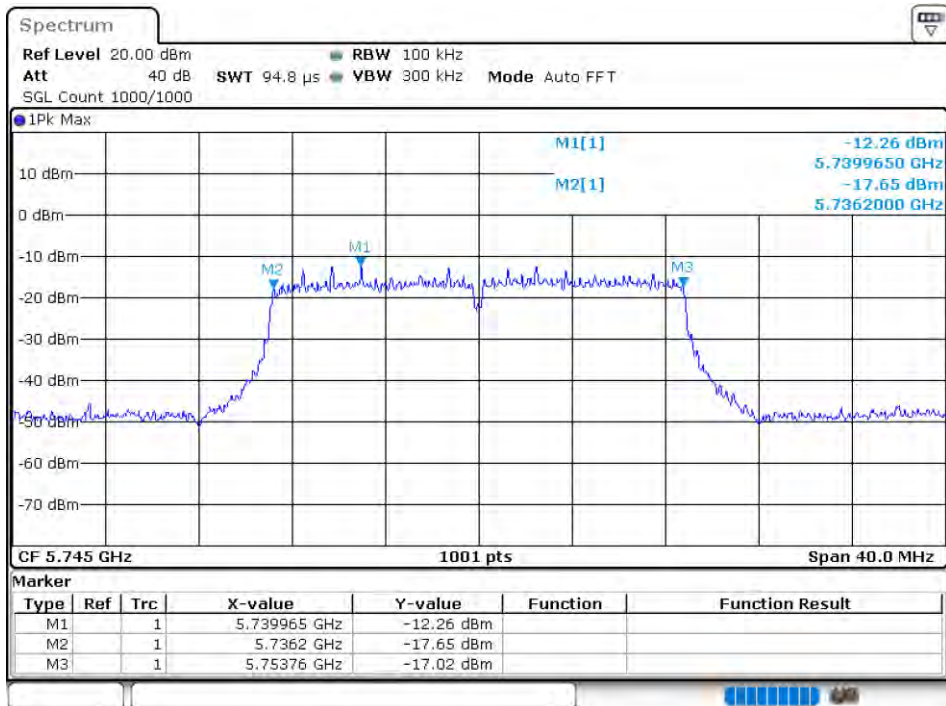

EBW NVNT 802.11ac20 5785MHz Ant 2

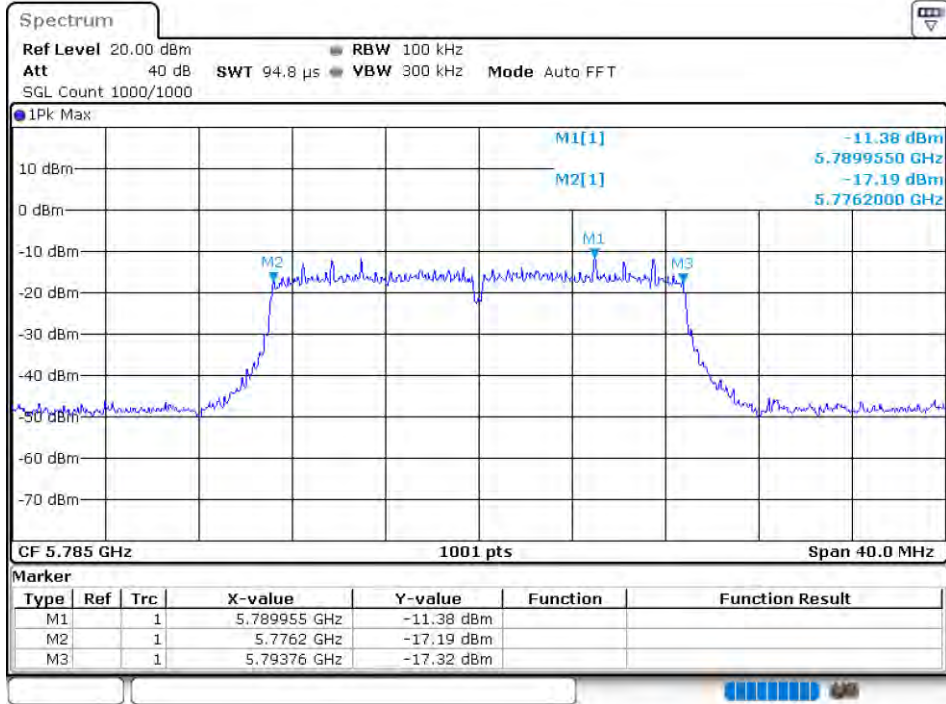

EBW NVNT 802.11ac20 5825MHz Ant 2

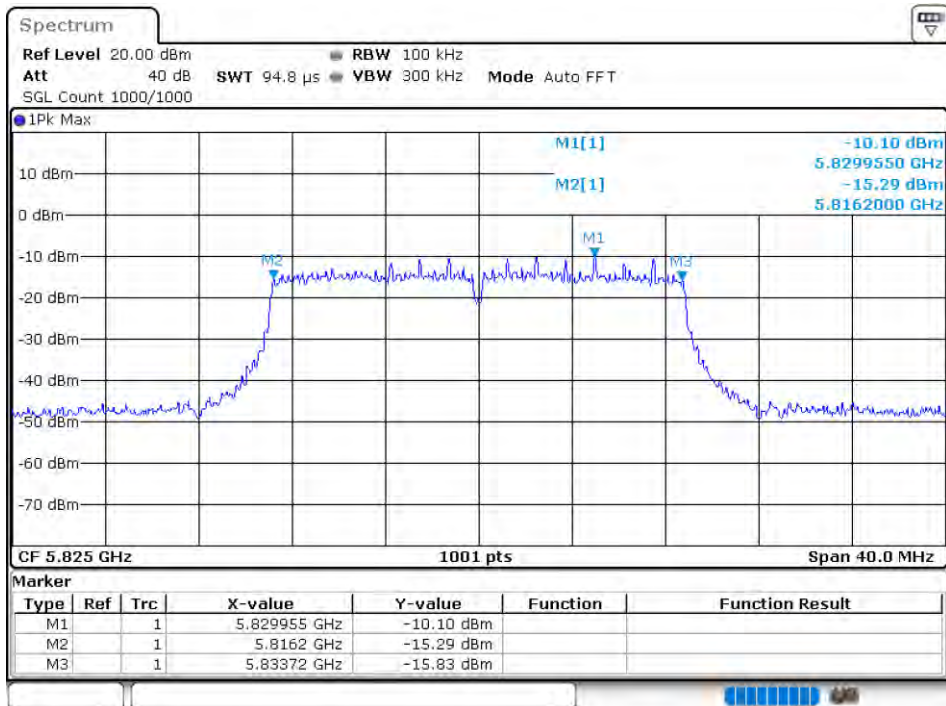

EBW NVNT 802.11ac40 5755MHz Ant 1

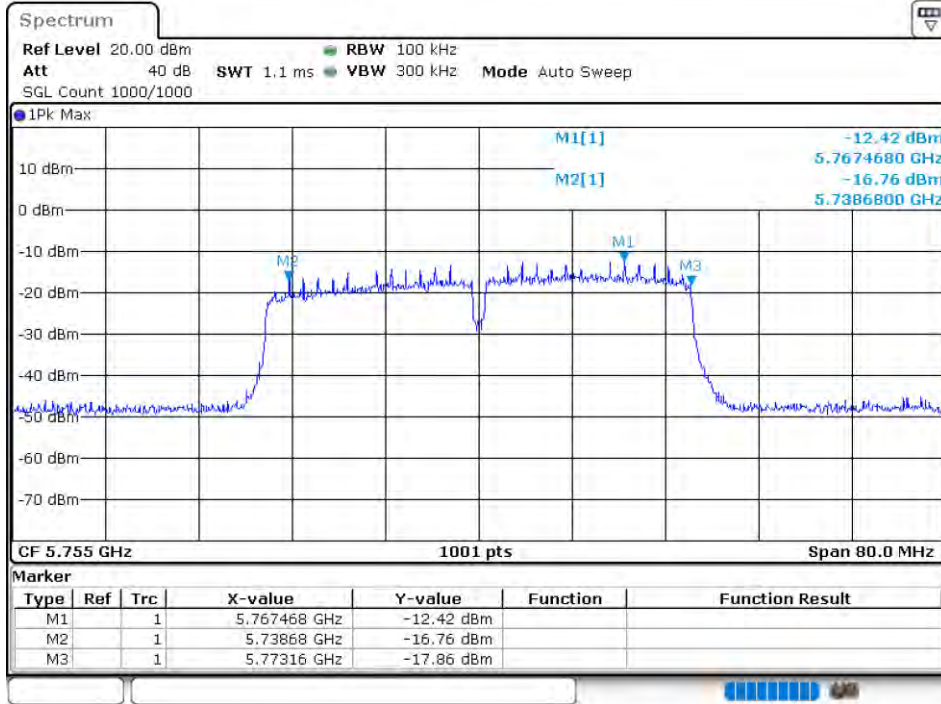

EBW NVNT 802.11ac40 5795MHz Ant 1

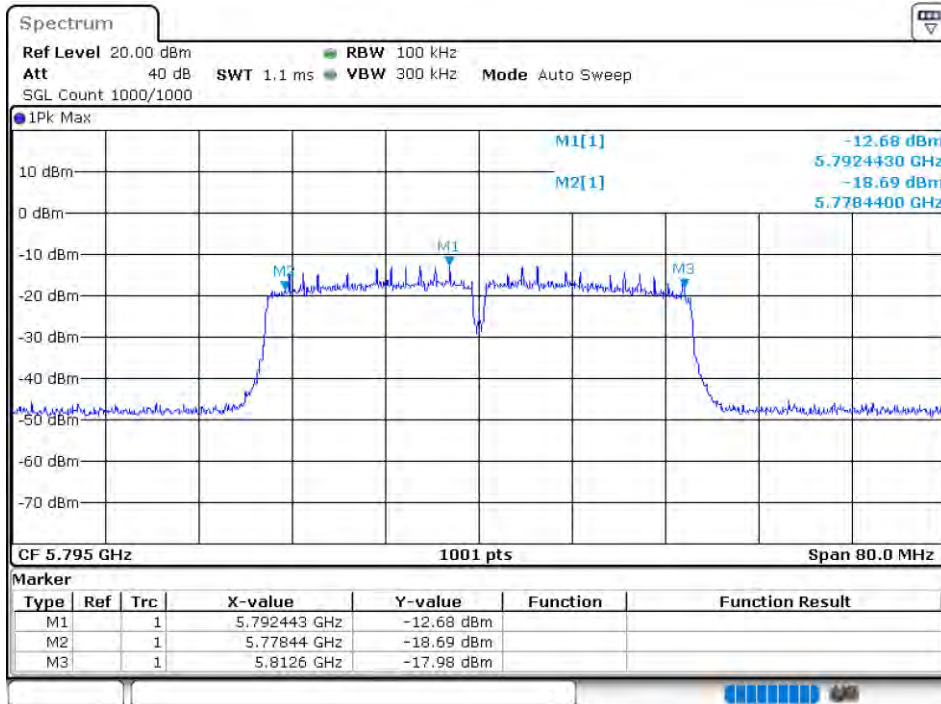



EBW NVNT 802.11ac40 5755MHz Ant 2

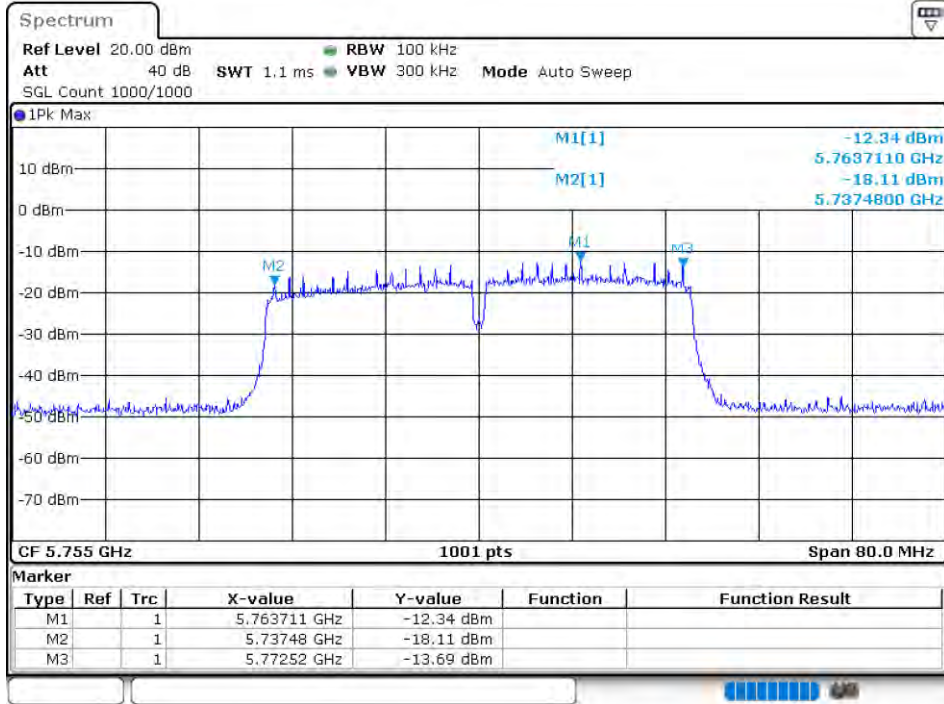

EBW NVNT 802.11ac40 5795MHz Ant 2

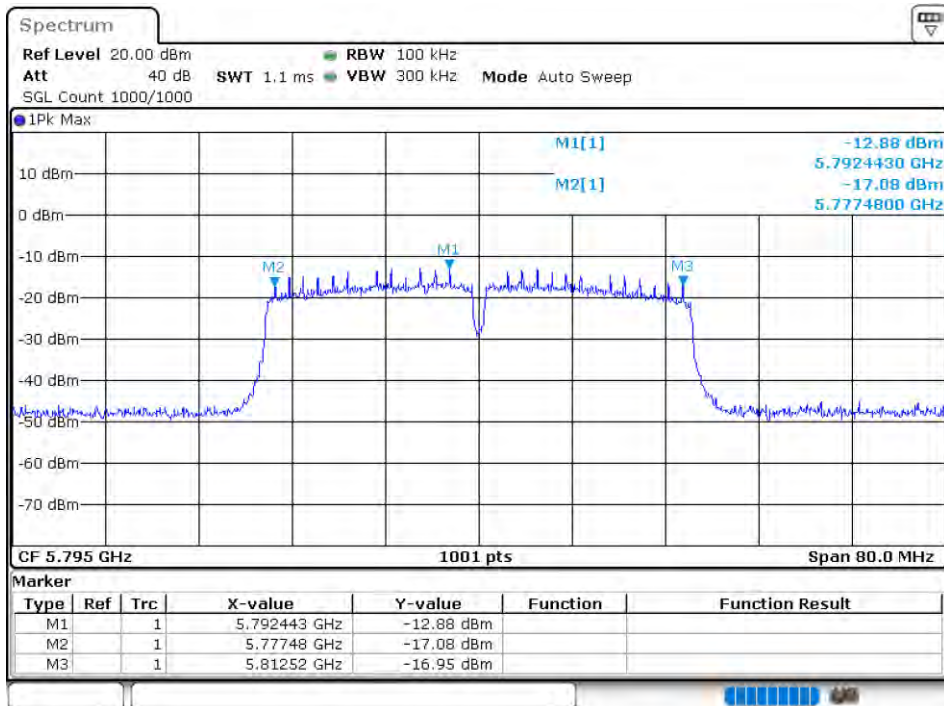

EBW NVNT 802.11ac80 5775MHz Ant 1

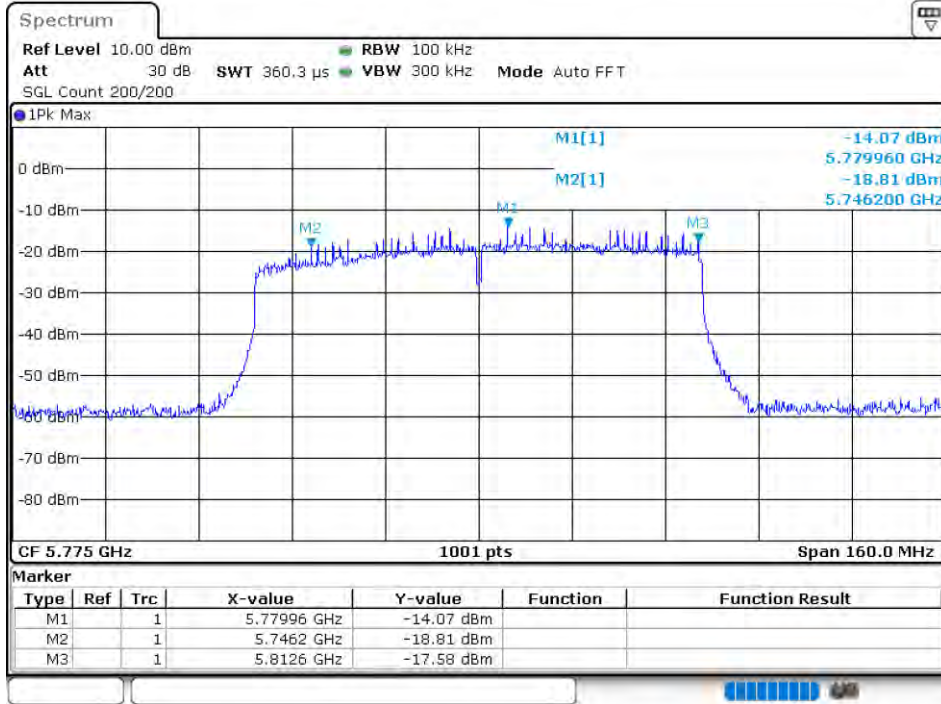

EBW NVNT 802.11ac80 5775MHz Ant 2

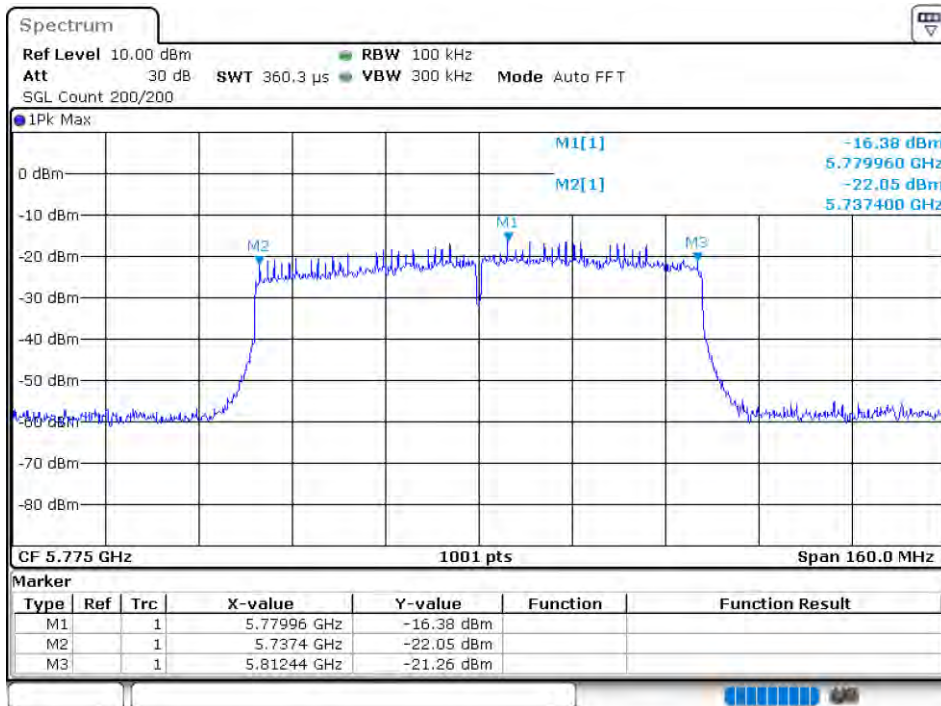

EBW NVNT 802.11n(HT20) 5745MHz Ant 1

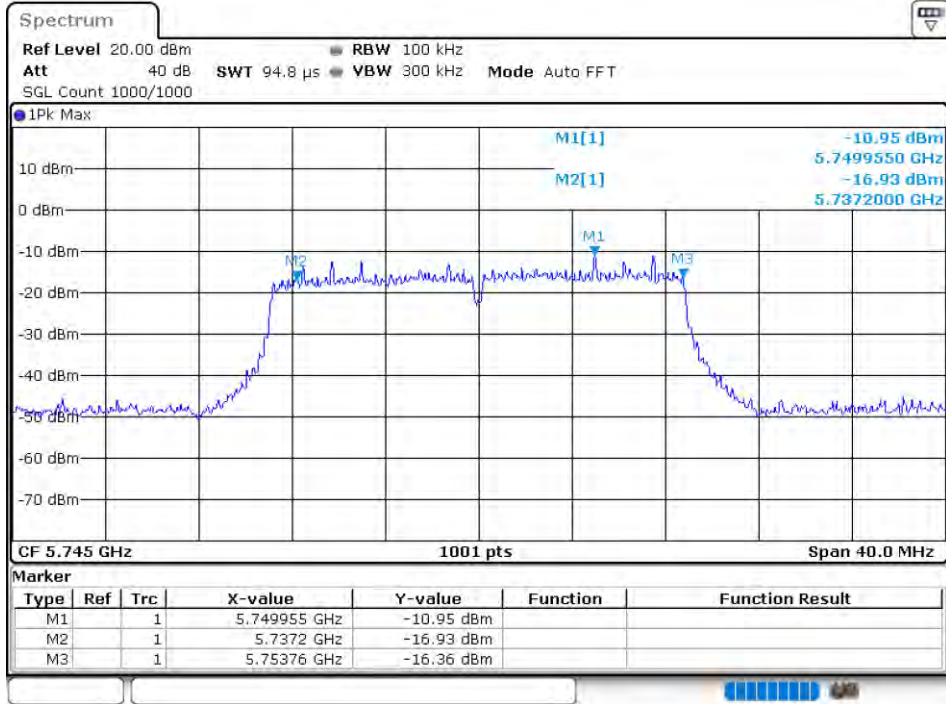

EBW NVNT 802.11n(HT20) 5785MHz Ant 1

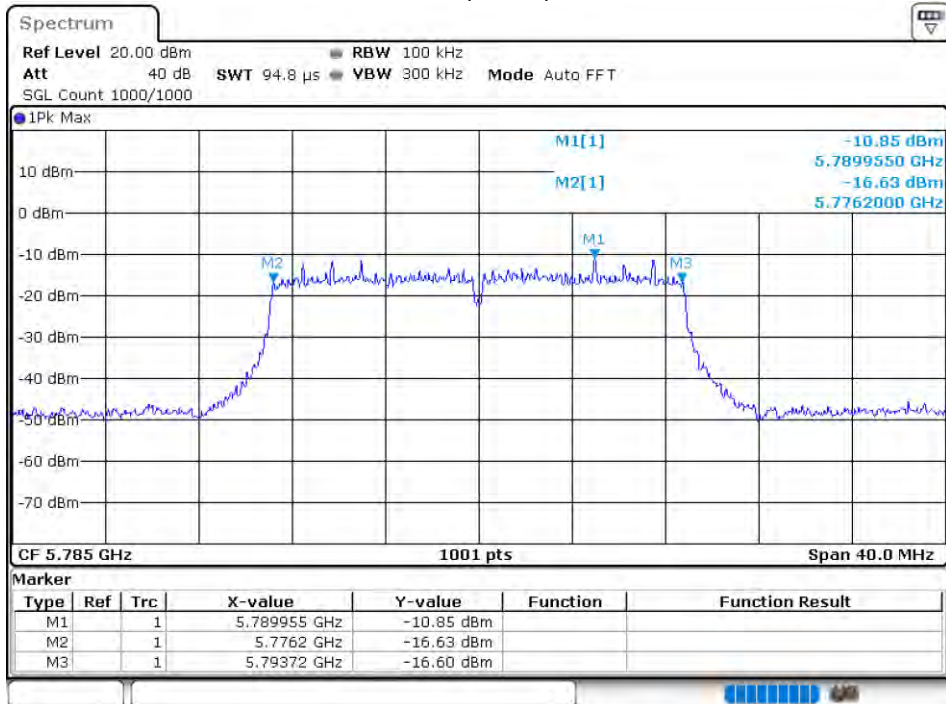



EBW NVNT 802.11n(HT20) 5825MHz Ant 1

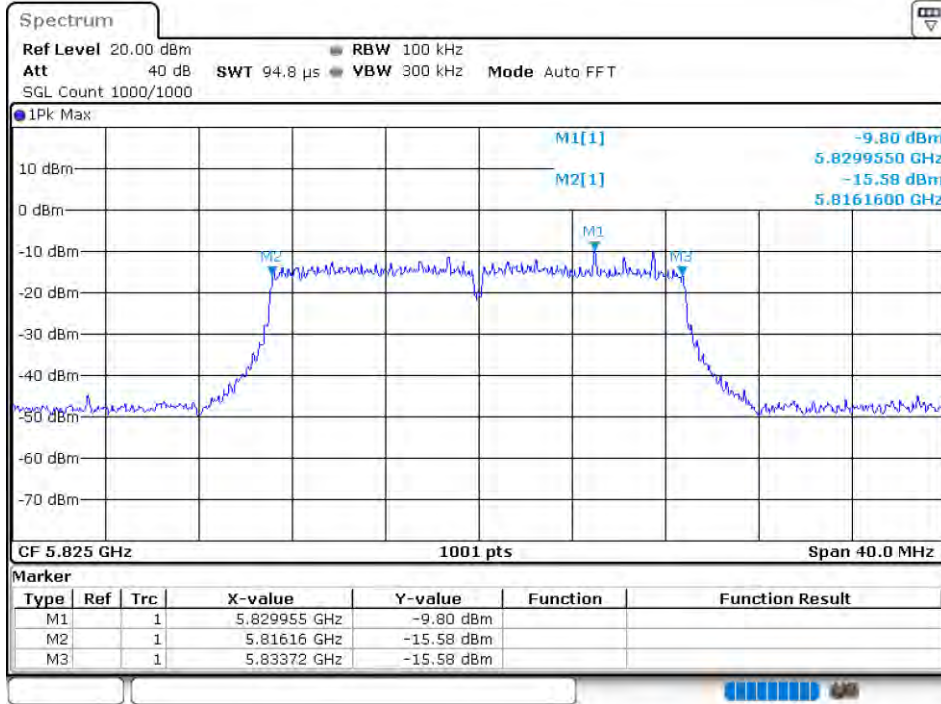

EBW NVNT 802.11n(HT20) 5745MHz Ant 2

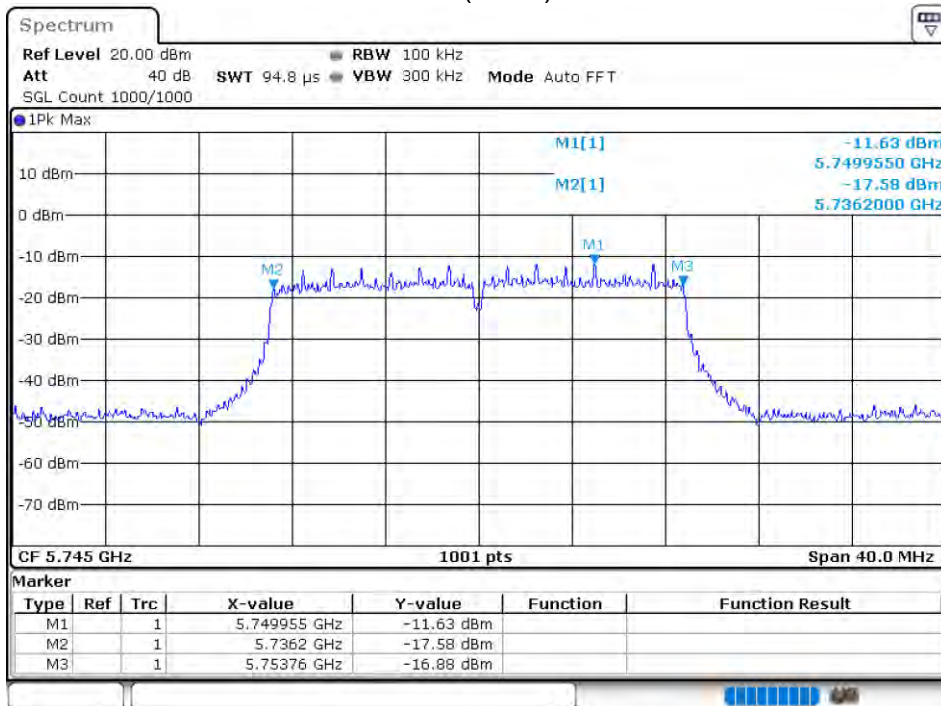

EBW NVNT 802.11n(HT20) 5785MHz Ant 2

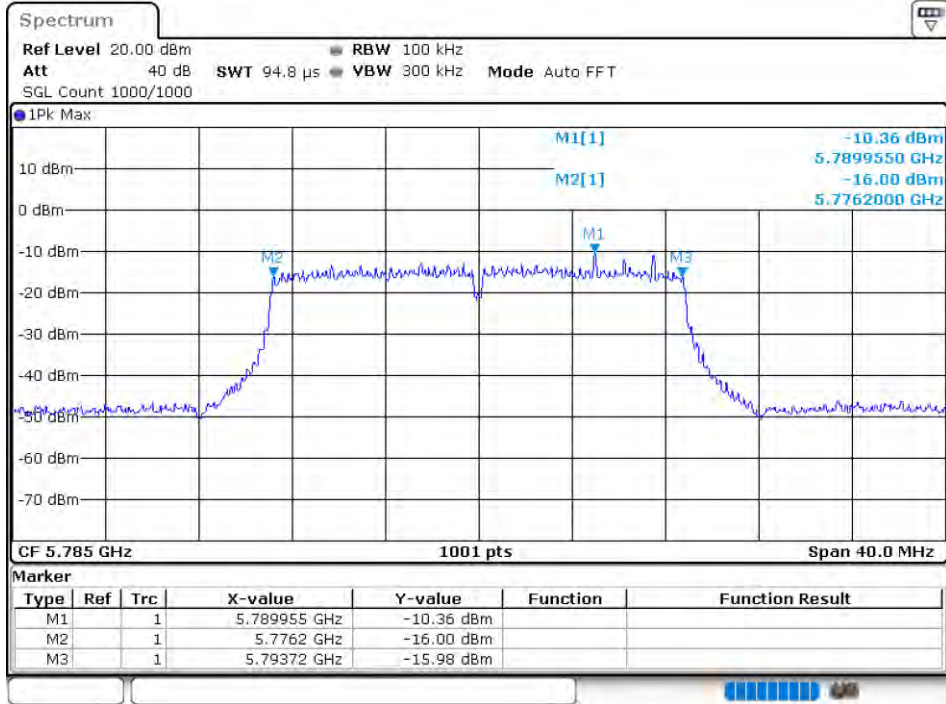

EBW NVNT 802.11n(HT20) 5825MHz Ant 2

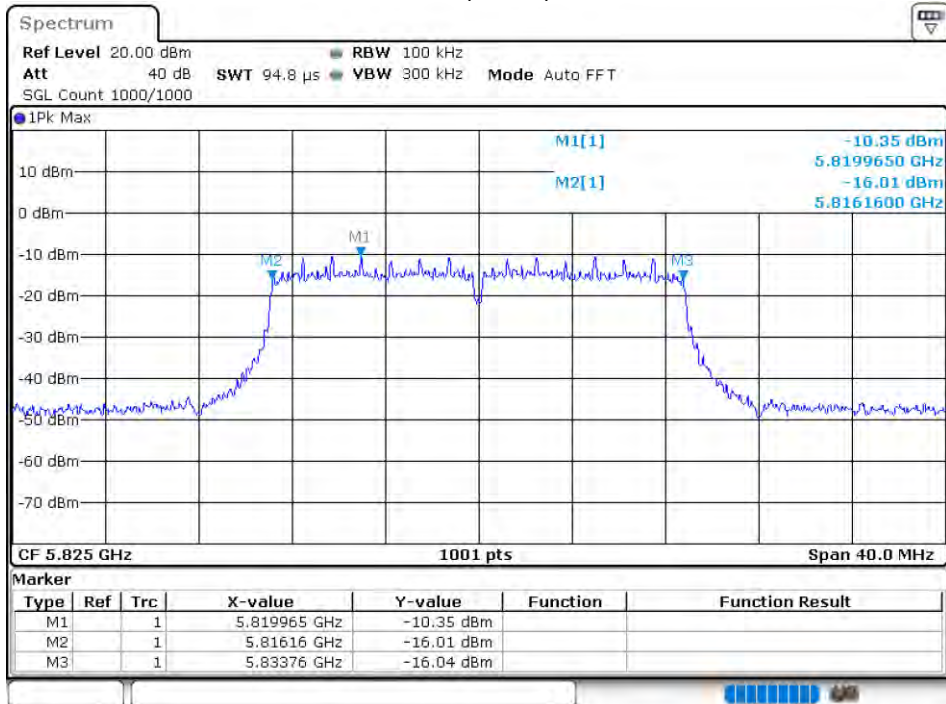



EBW NVNT 802.11n(HT40) 5755MHz Ant 1

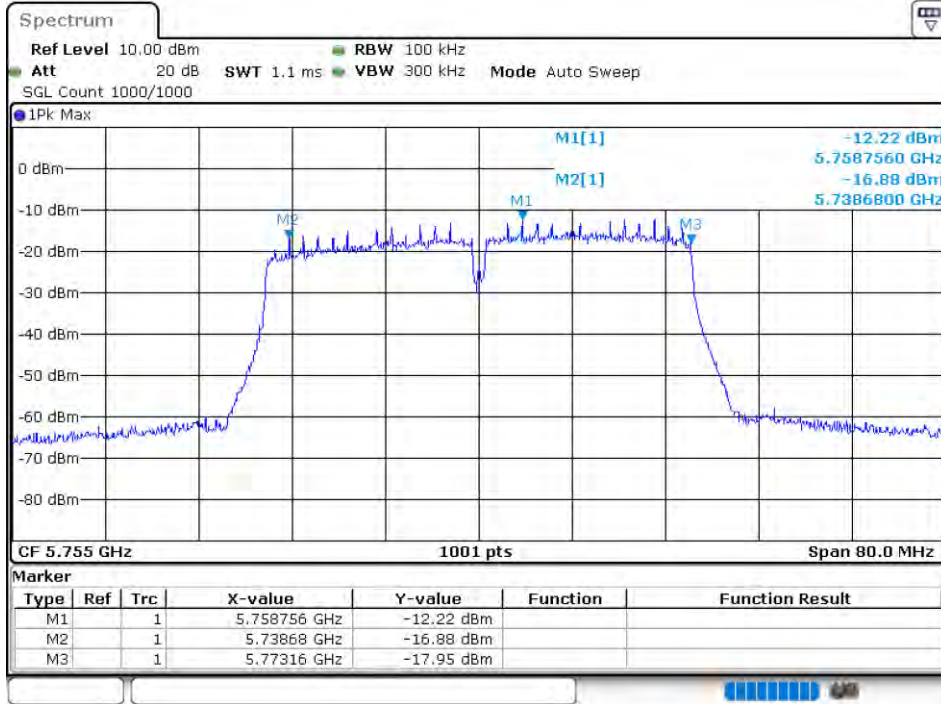

EBW NVNT 802.11n(HT40) 5795MHz Ant 1

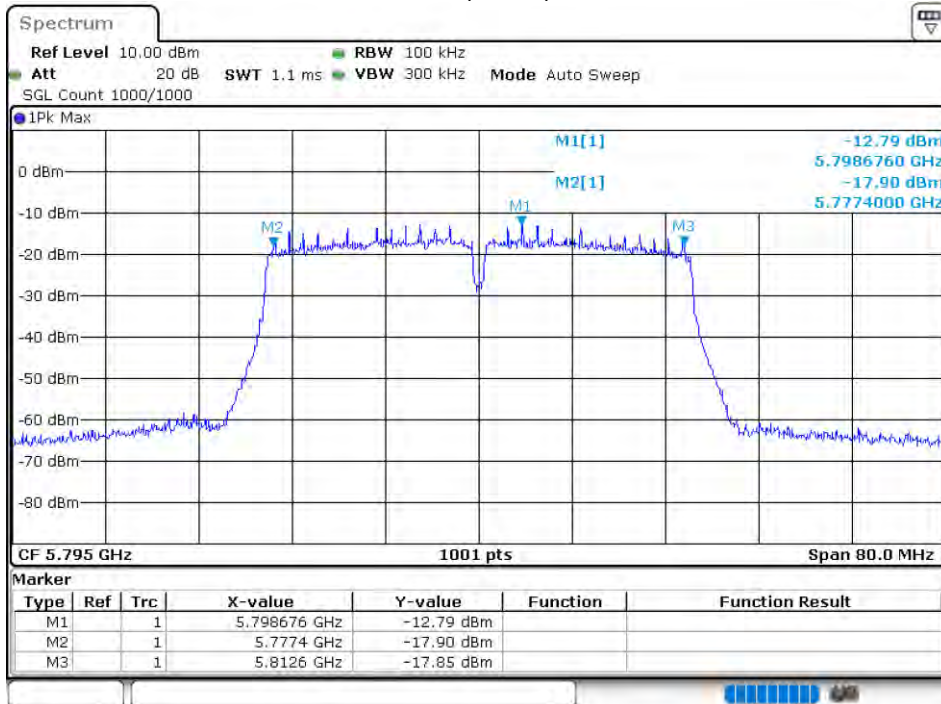

EBW NVNT 802.11n(HT40) 5755MHz Ant 2

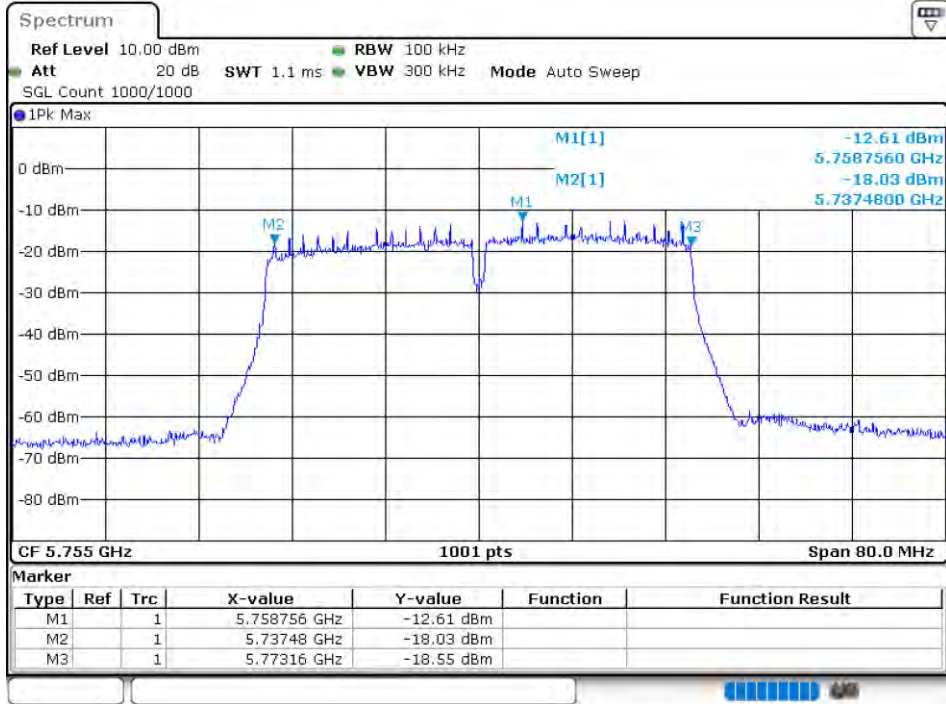

EBW NVNT 802.11n(HT40) 5795MHz Ant 2

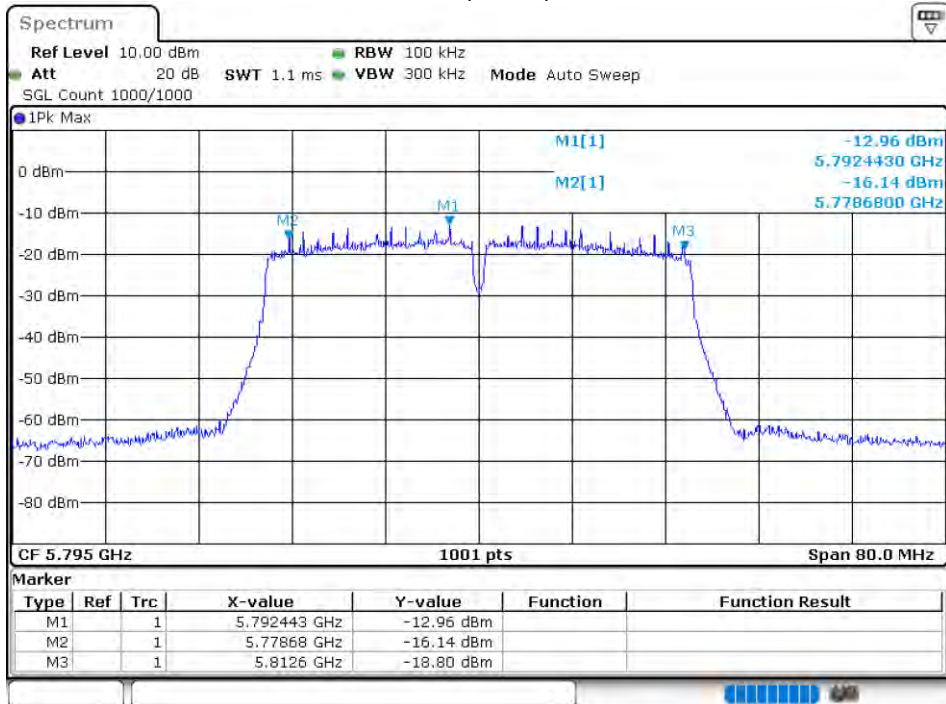

MIMO

Condition	Mode	Frequency (MHz)	Antenna	-6 dB Bandwidth (MHz)	Limit -6 dB Bandwidth (MHz)	Verdict
NVNT	802.11ac20	5745	Ant 1	17.2	0.5	Pass
NVNT	802.11ac20	5745	Ant 2	17.28	0.5	Pass
NVNT	802.11ac20	5785	Ant 1	17.56	0.5	Pass
NVNT	802.11ac20	5785	Ant 2	17.6	0.5	Pass
NVNT	802.11ac20	5825	Ant 1	17.2	0.5	Pass
NVNT	802.11ac20	5825	Ant 2	17.52	0.5	Pass
NVNT	802.11ac40	5755	Ant 1	35.68	0.5	Pass
NVNT	802.11ac40	5755	Ant 2	35.12	0.5	Pass
NVNT	802.11ac40	5795	Ant 1	35.12	0.5	Pass
NVNT	802.11ac40	5795	Ant 2	35.2	0.5	Pass
NVNT	802.11ac80	5775	Ant 1	72.48	0.5	Pass
NVNT	802.11ac80	5775	Ant 2	75.68	0.5	Pass
NVNT	802.11n(HT20)	5745	Ant 1	17.56	0.5	Pass
NVNT	802.11n(HT20)	5745	Ant 2	17.56	0.5	Pass
NVNT	802.11n(HT20)	5785	Ant 1	17.6	0.5	Pass
NVNT	802.11n(HT20)	5785	Ant 2	17.56	0.5	Pass
NVNT	802.11n(HT20)	5825	Ant 1	17.56	0.5	Pass
NVNT	802.11n(HT20)	5825	Ant 2	17.6	0.5	Pass
NVNT	802.11n(HT40)	5755	Ant 1	35.68	0.5	Pass
NVNT	802.11n(HT40)	5755	Ant 2	35.12	0.5	Pass
NVNT	802.11n(HT40)	5795	Ant 1	35.04	0.5	Pass
NVNT	802.11n(HT40)	5795	Ant 2	33.92	0.5	Pass

EBW NVNT 802.11ac20 5745MHz Ant1

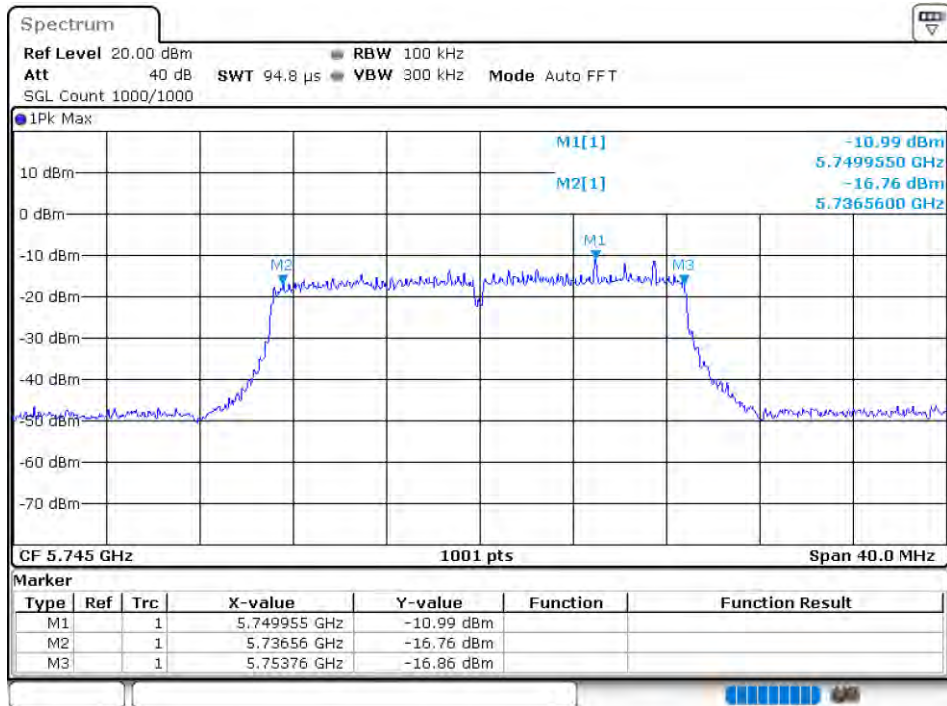

EBW NVNT 802.11ac20 5745MHz Ant2

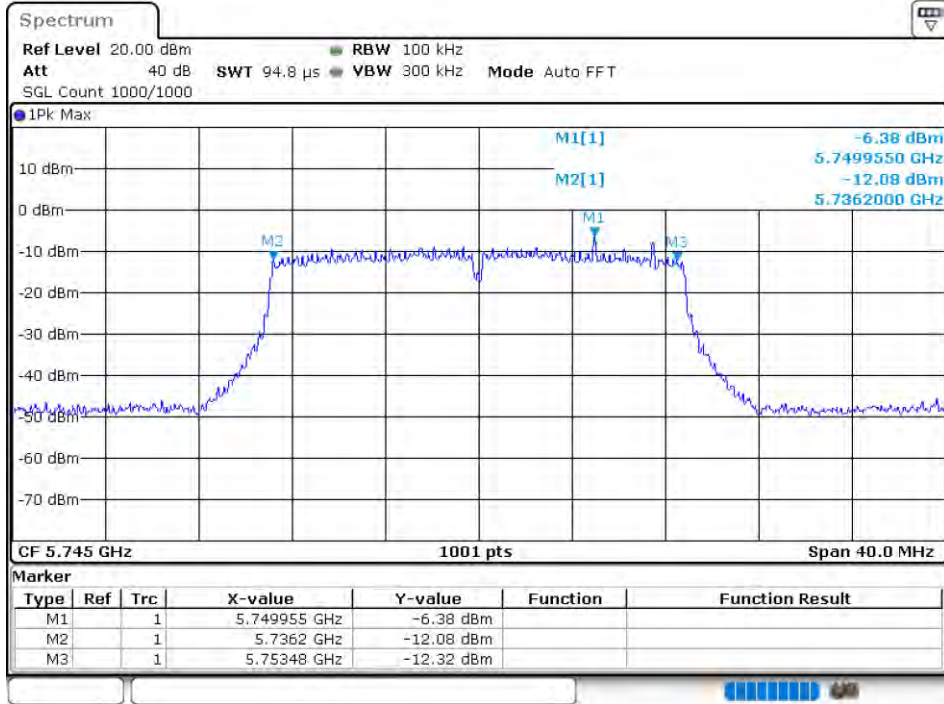

EBW NVNT 802.11ac20 5785MHz Ant1

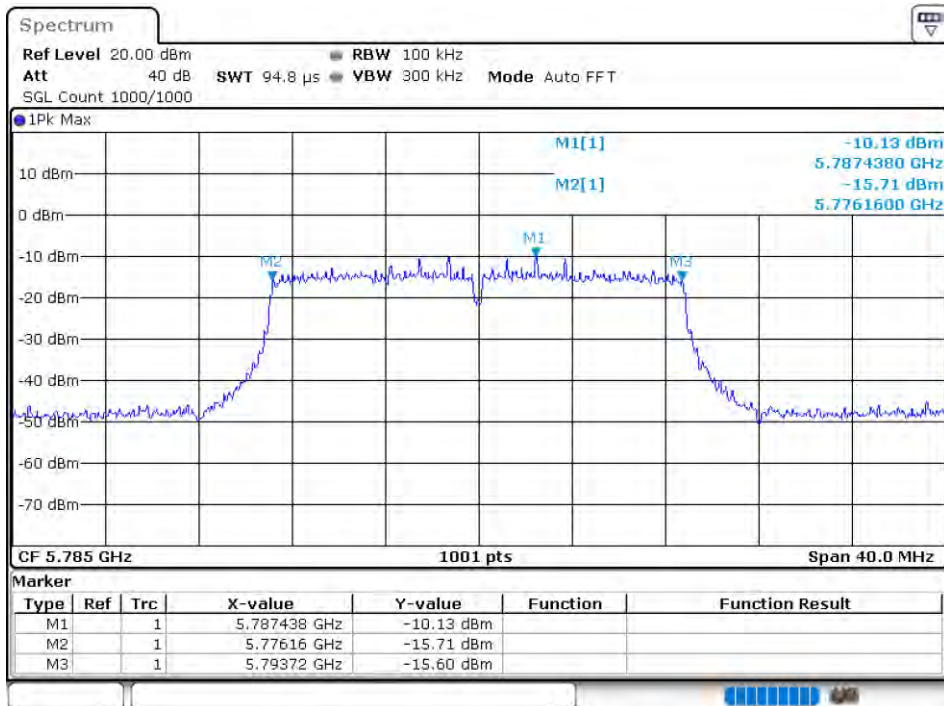



EBW NVNT 802.11ac20 5785MHz Ant2

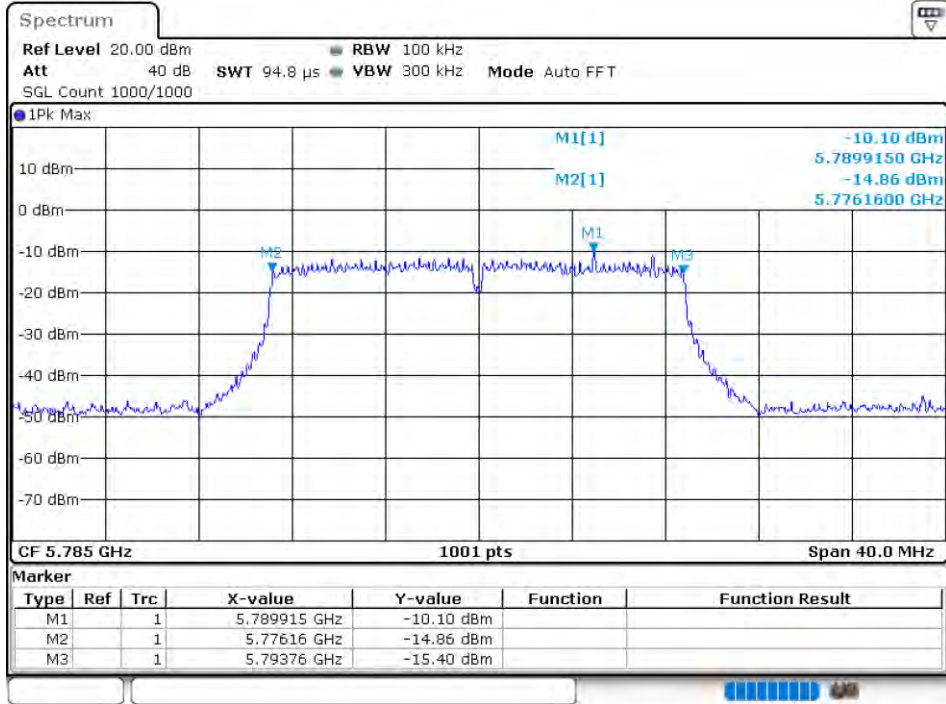

EBW NVNT 802.11ac20 5825MHz Ant1

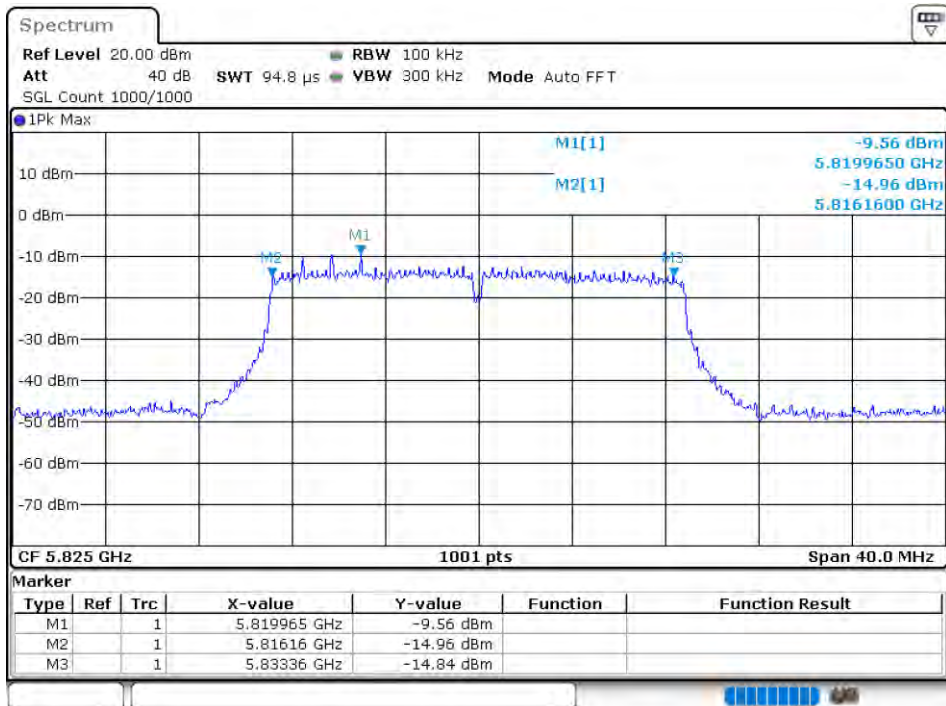

EBW NVNT 802.11ac20 5825MHz Ant2

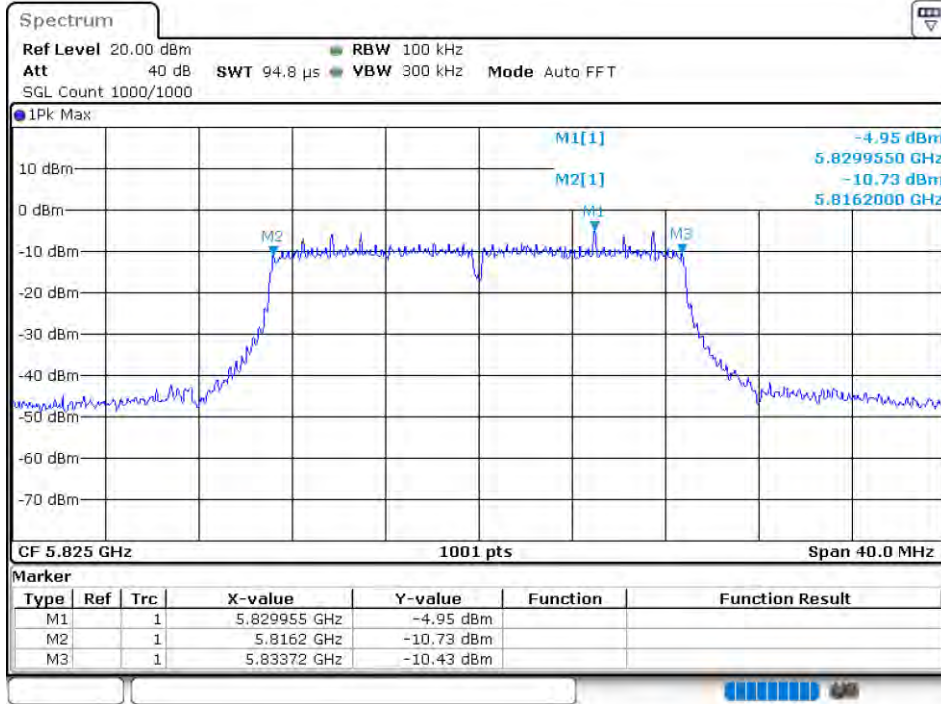

EBW NVNT 802.11ac40 5755MHz Ant1

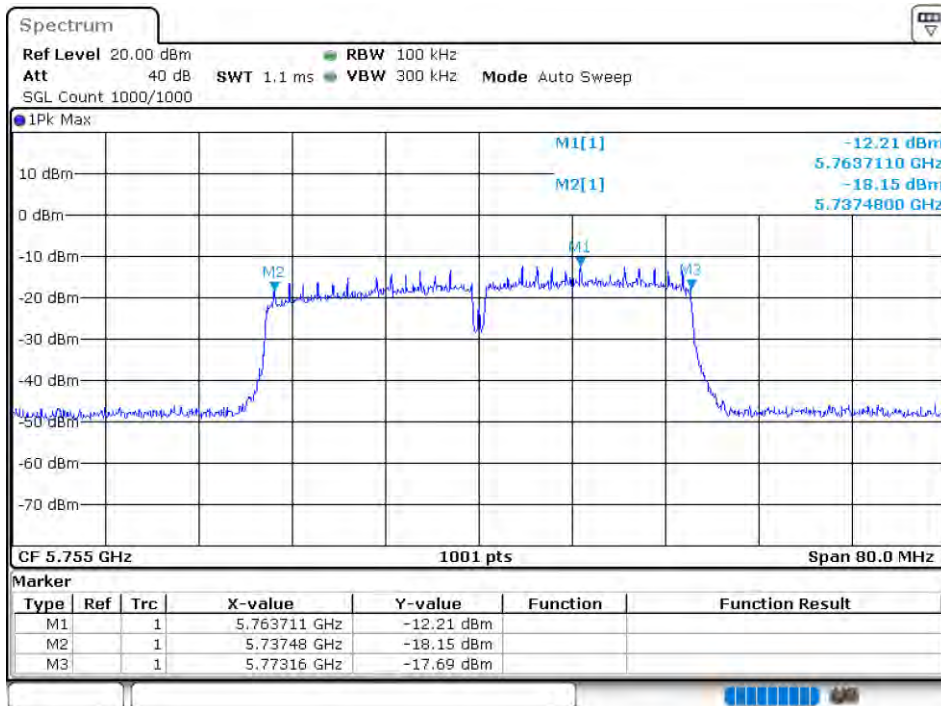

EBW NVNT 802.11ac40 5755MHz Ant2

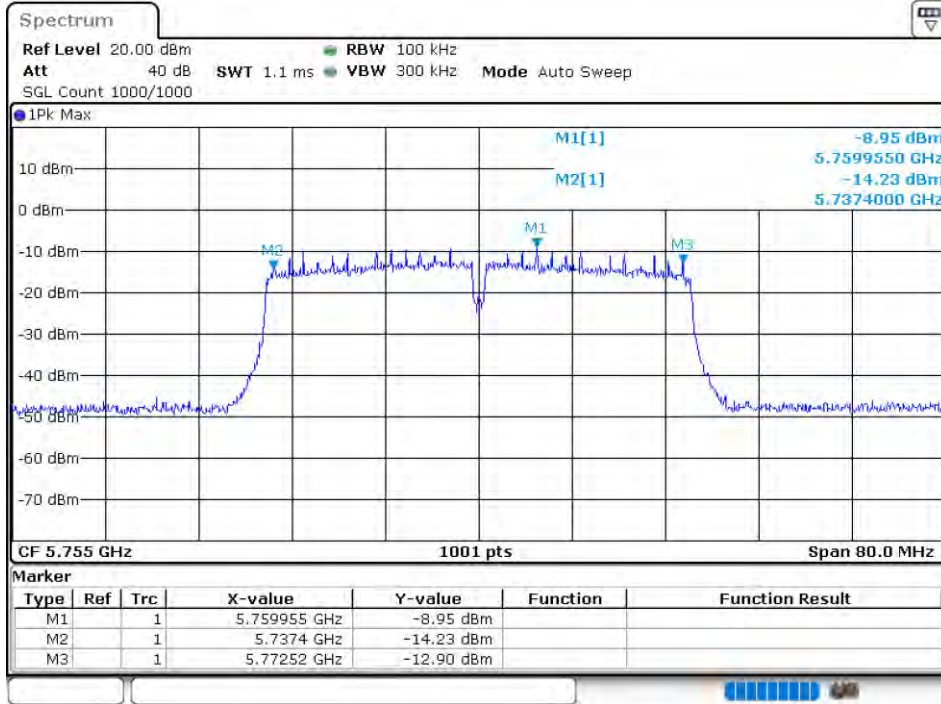

EBW NVNT 802.11ac40 5795MHz Ant1

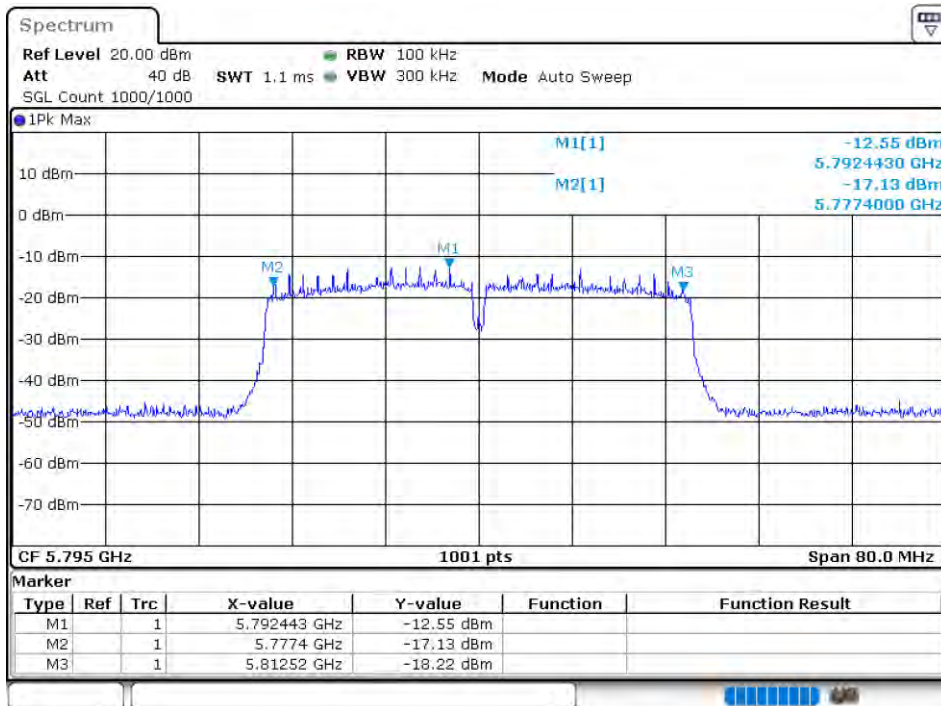



EBW NVNT 802.11ac40 5795MHz Ant2

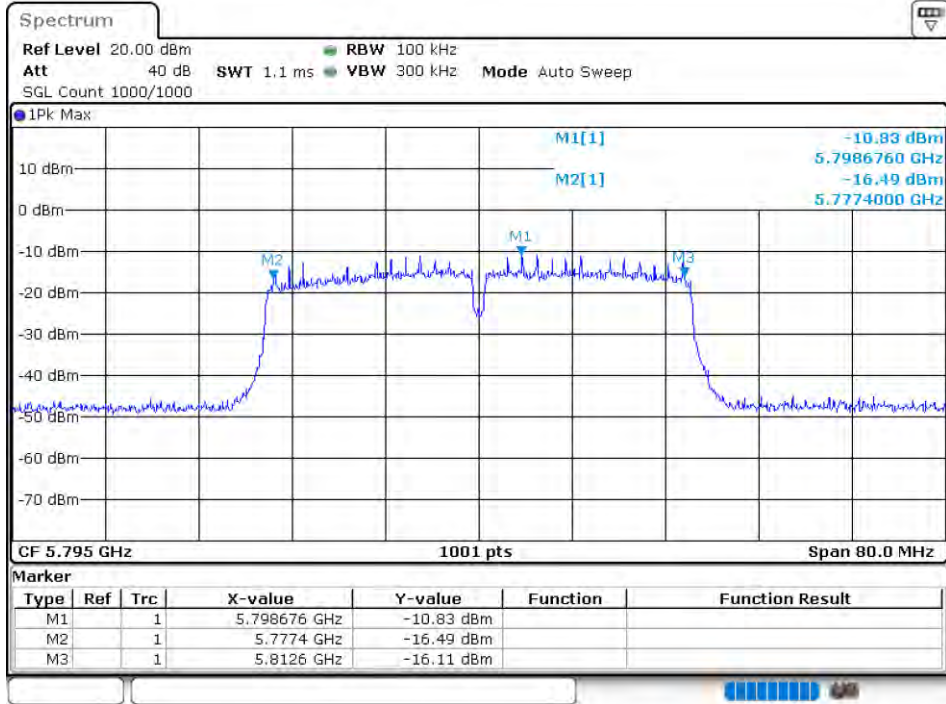

EBW NVNT 802.11ac80 5775MHz Ant1

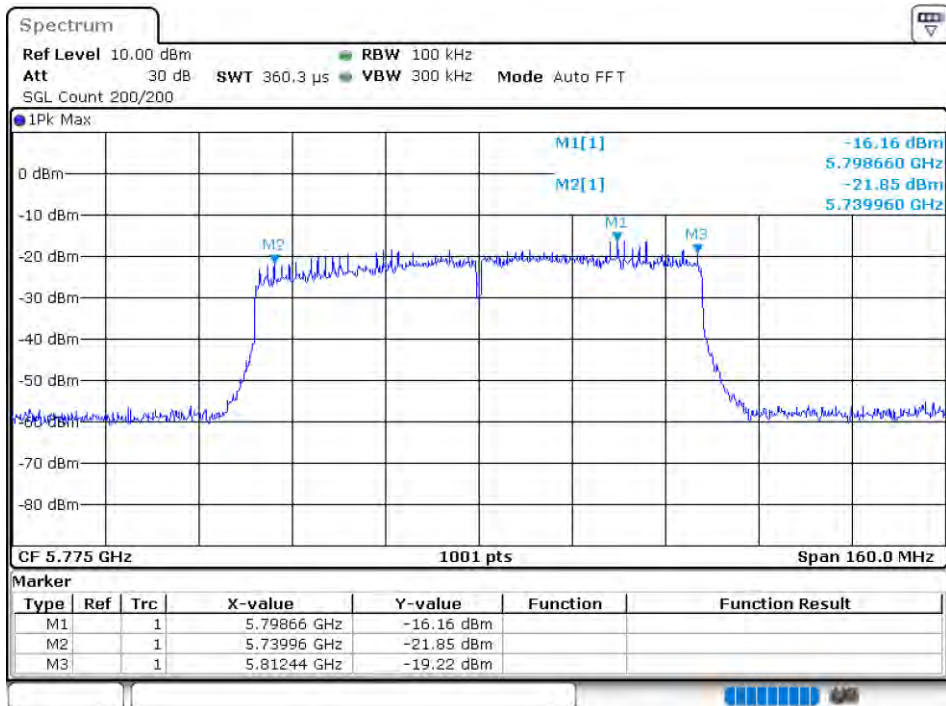

EBW NVNT 802.11ac80 5775MHz Ant2

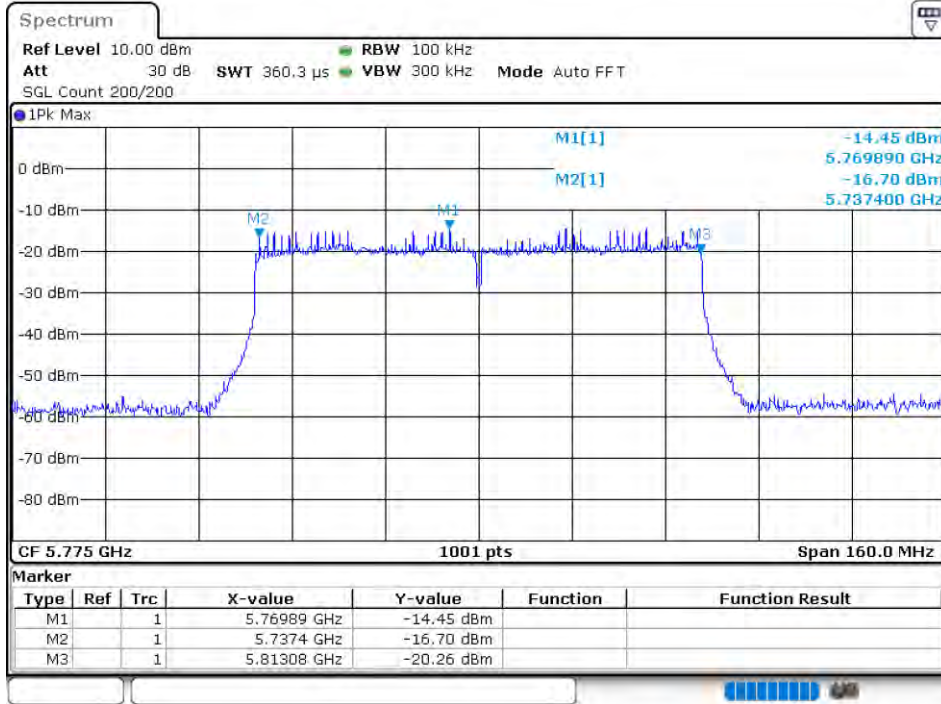

EBW NVNT 802.11n(HT20) 5745MHz Ant1

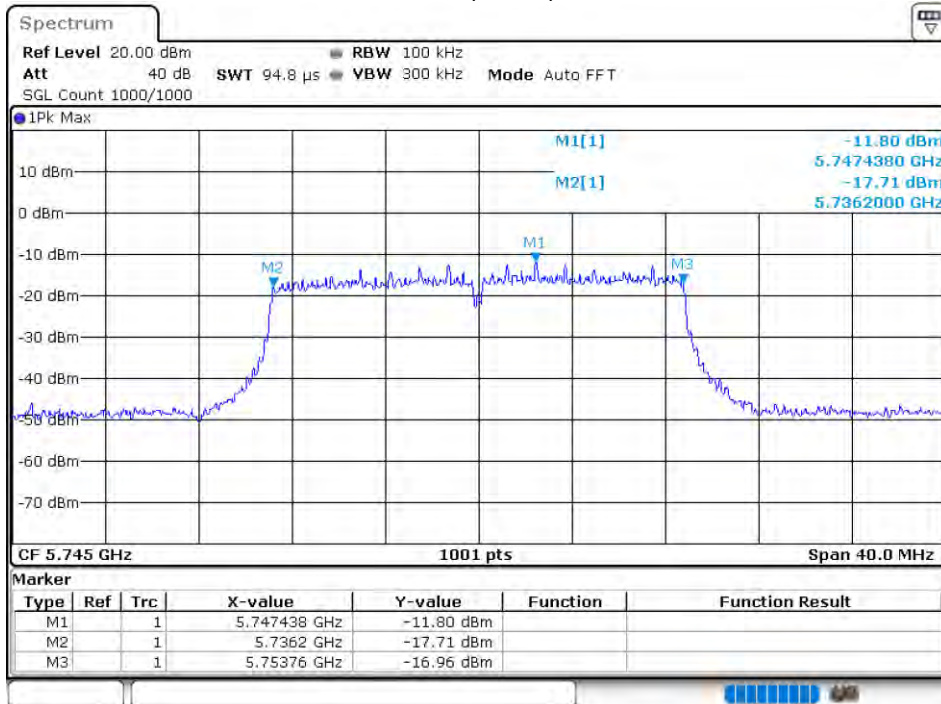

EBW NVNT 802.11n(HT20) 5745MHz Ant2

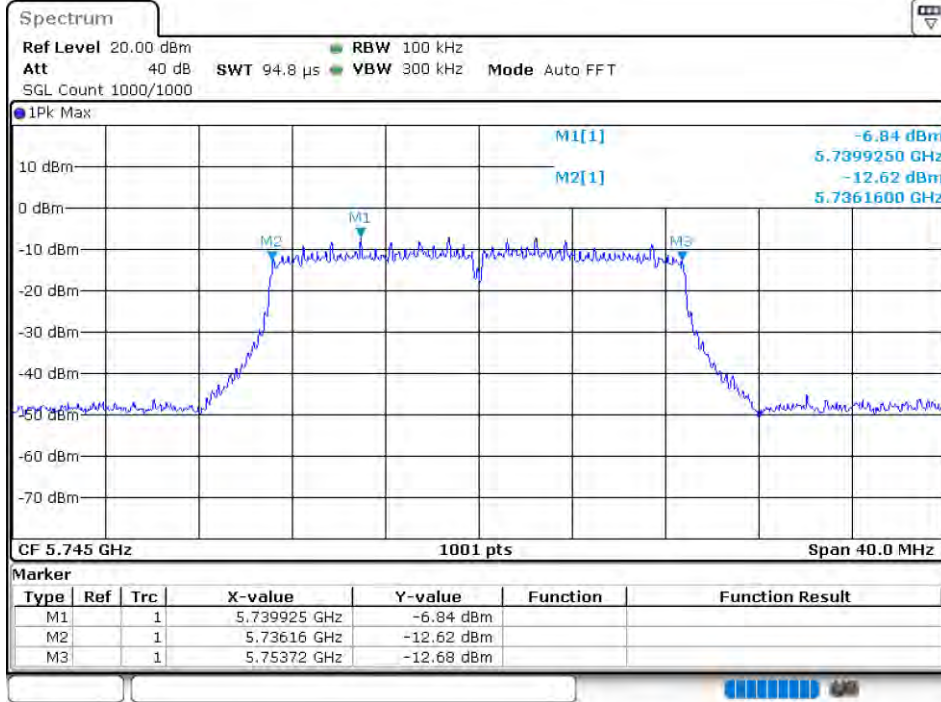

EBW NVNT 802.11n(HT20) 5785MHz Ant1

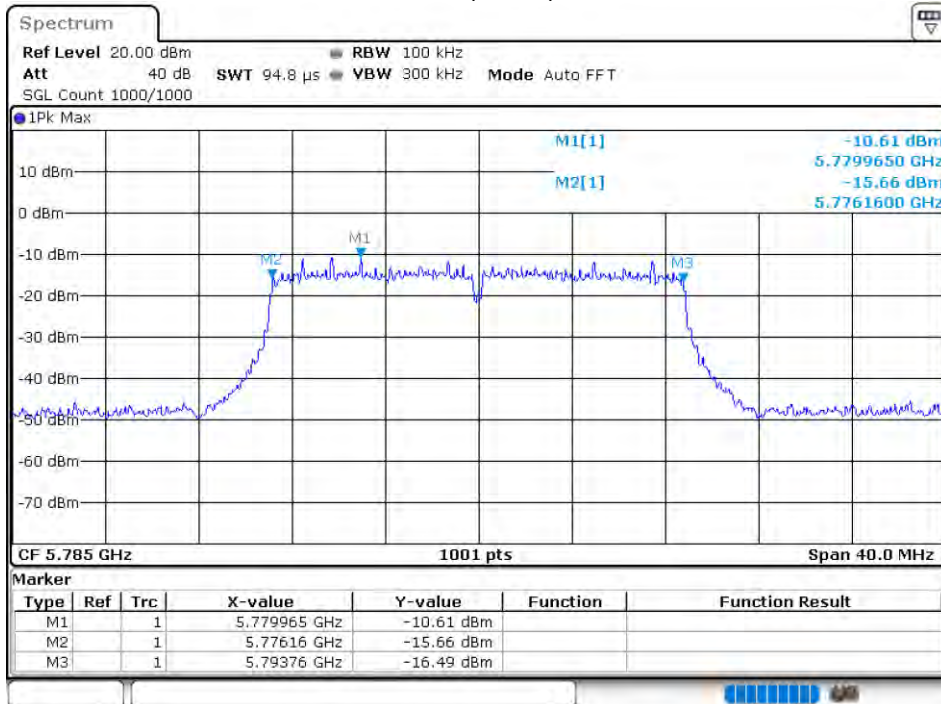

EBW NVNT 802.11n(HT20) 5785MHz Ant2

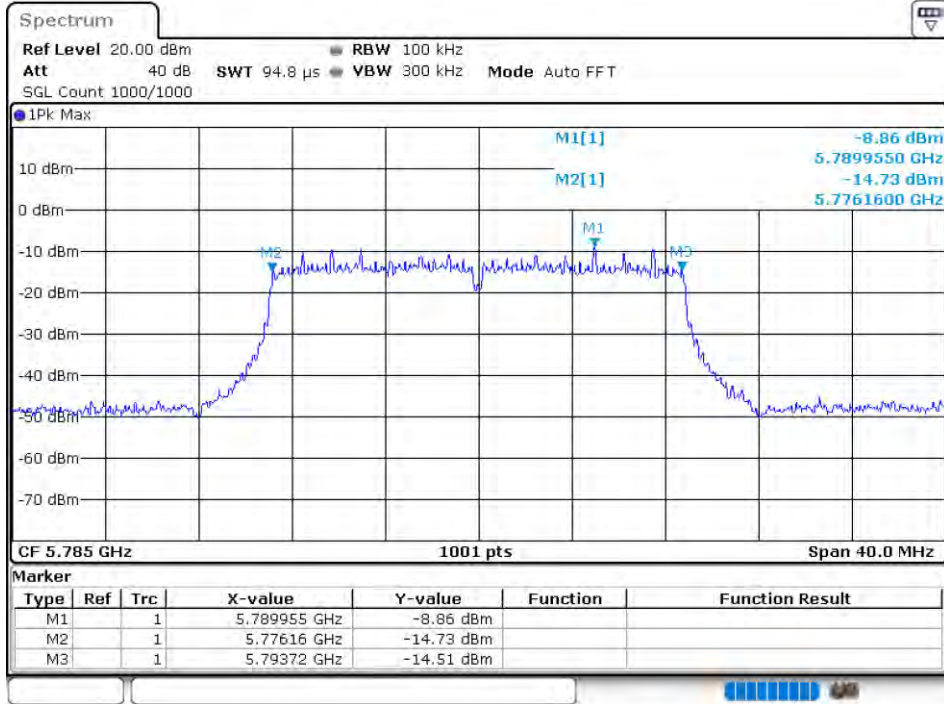

EBW NVNT 802.11n(HT20) 5825MHz Ant1

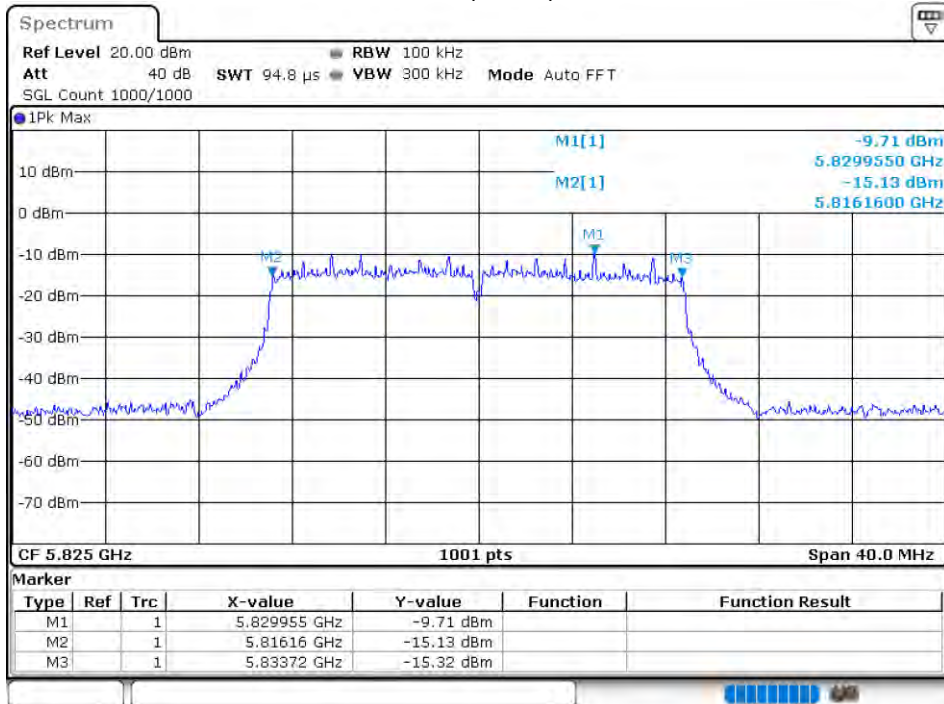



EBW NVNT 802.11n(HT20) 5825MHz Ant2

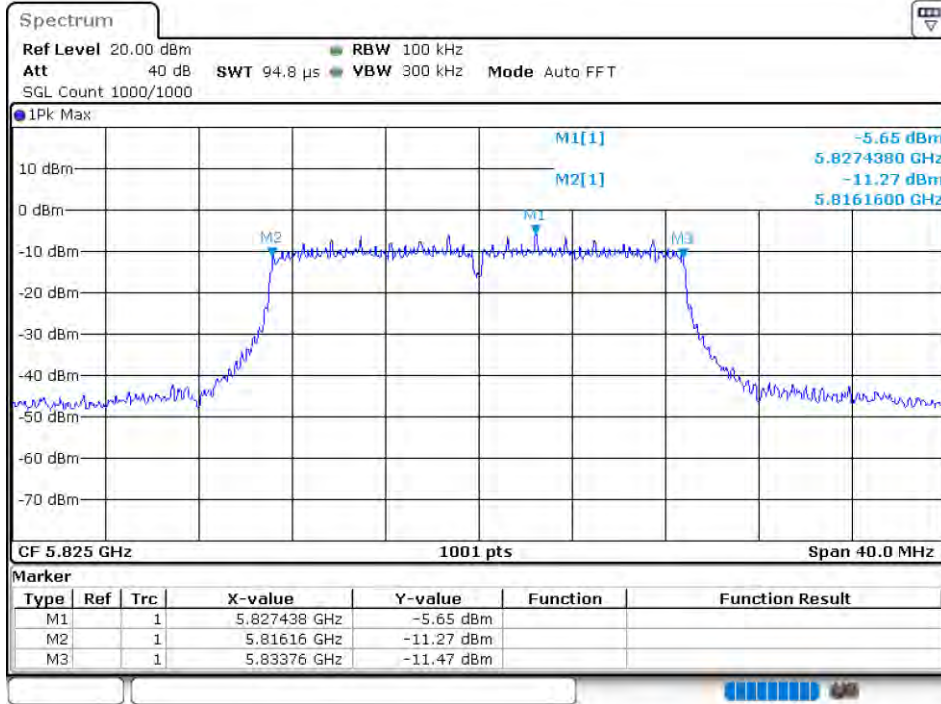

EBW NVNT 802.11n(HT40) 5755MHz Ant1

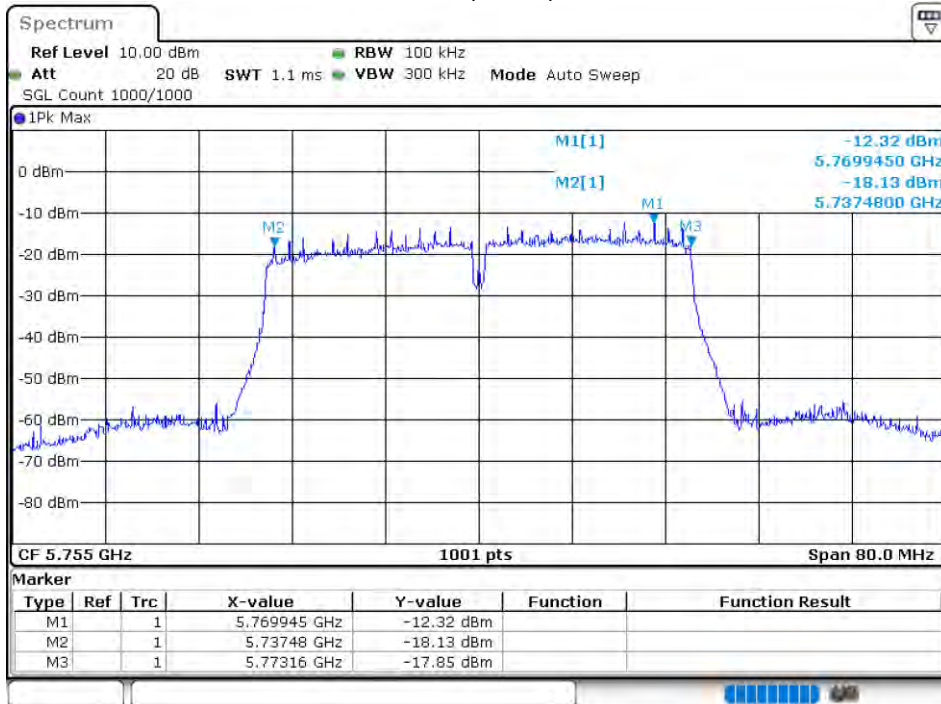

EBW NVNT 802.11n(HT40) 5755MHz Ant2

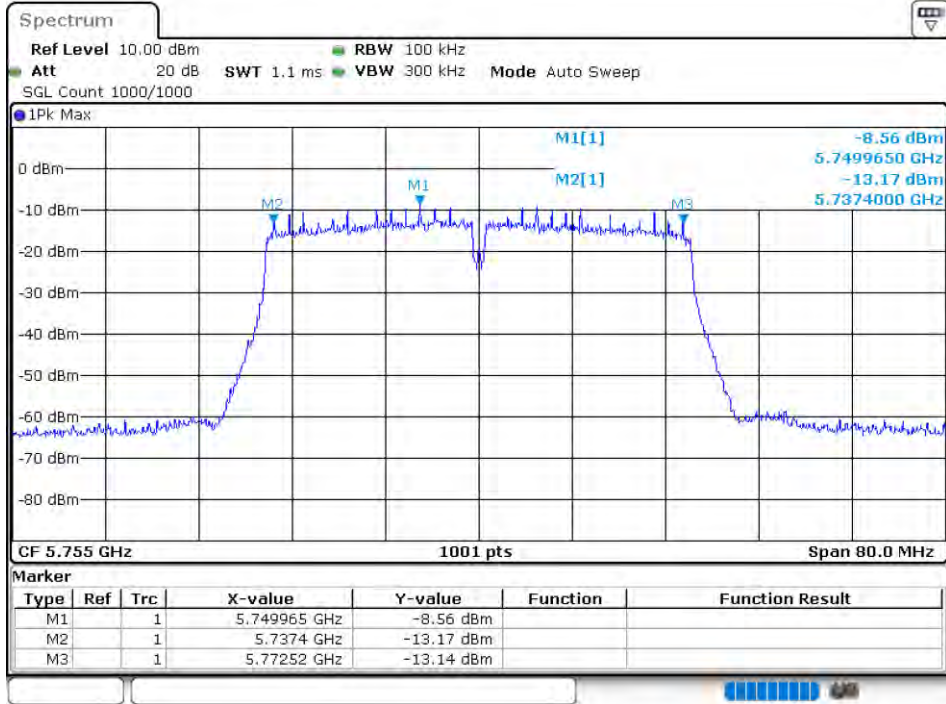

EBW NVNT 802.11n(HT40) 5795MHz Ant1

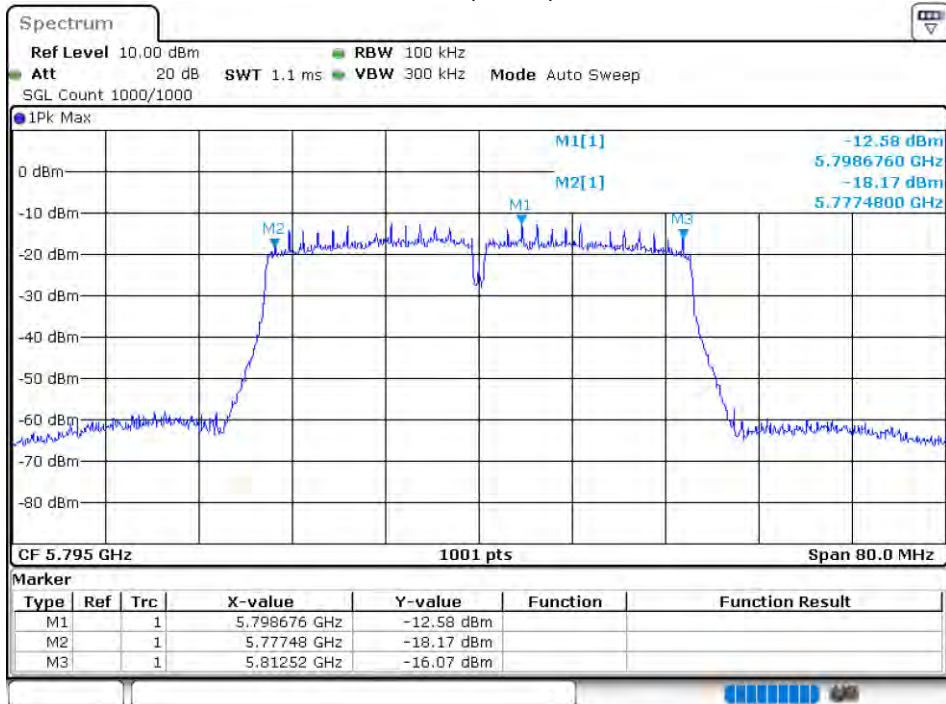

EBW NVNT 802.11n(HT40) 5795MHz Ant2

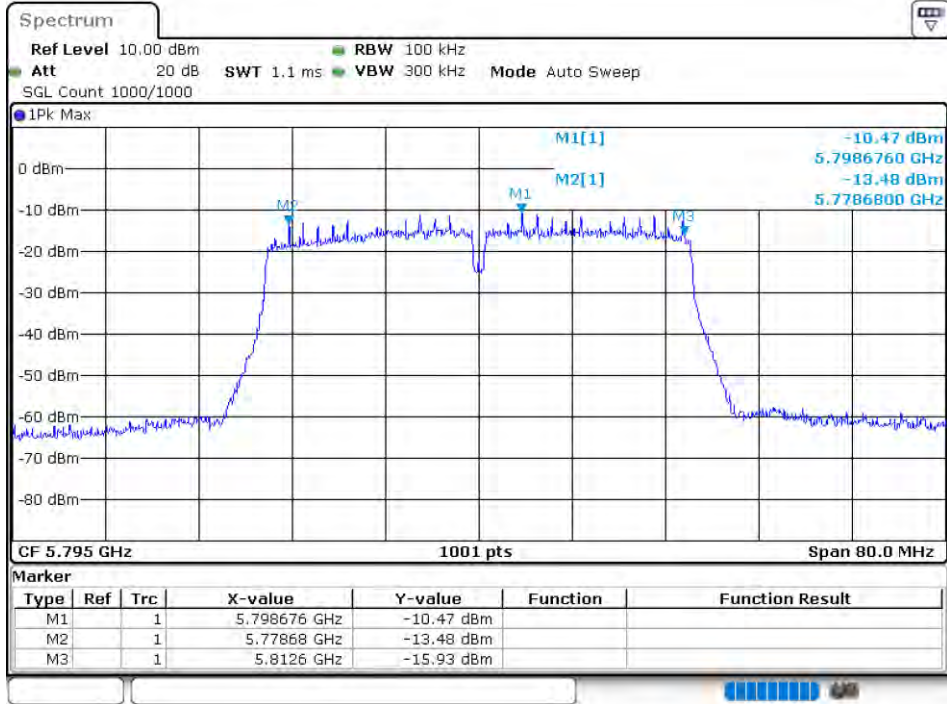



5.4 OCCUPIED CHANNEL BANDWIDTH

SISO

Condition	Mode	Frequency (MHz)	Antenna	99% OBW (MHz)	-26 dB Bandwidth (MHz)
NVNT	802.11a	5745	Ant 1	16.4635	18.44
NVNT	802.11a	5785	Ant 1	16.4635	19
NVNT	802.11a	5825	Ant 1	16.4635	19
NVNT	802.11a	5745	Ant 2	16.4236	18.84
NVNT	802.11a	5785	Ant 2	16.4635	18.88
NVNT	802.11a	5825	Ant 2	16.5435	18.72
NVNT	802.11ac20	5745	Ant 1	17.6623	19.84
NVNT	802.11ac20	5785	Ant 1	17.5824	19.84
NVNT	802.11ac20	5825	Ant 1	17.5824	20.24
NVNT	802.11ac20	5745	Ant 2	17.6623	19.84
NVNT	802.11ac20	5785	Ant 2	17.6224	19.84
NVNT	802.11ac20	5825	Ant 2	17.6623	20.28
NVNT	802.11ac40	5755	Ant 1	35.8841	39.2
NVNT	802.11ac40	5795	Ant 1	35.8841	39.52
NVNT	802.11ac40	5755	Ant 2	35.8841	39.2
NVNT	802.11ac40	5795	Ant 2	35.8042	39.68
NVNT	802.11ac80	5775	Ant 1	74.965	81.92
NVNT	802.11ac80	5775	Ant 2	75.1249	82.08
NVNT	802.11n(HT20)	5745	Ant 1	17.6623	19.64
NVNT	802.11n(HT20)	5785	Ant 1	17.6224	19.84
NVNT	802.11n(HT20)	5825	Ant 1	17.6623	20.28
NVNT	802.11n(HT20)	5745	Ant 2	17.6623	19.8
NVNT	802.11n(HT20)	5785	Ant 2	17.6623	19.68
NVNT	802.11n(HT20)	5825	Ant 2	17.6224	19.72
NVNT	802.11n(HT40)	5755	Ant 1	35.8841	39.04
NVNT	802.11n(HT40)	5795	Ant 1	35.964	39.28
NVNT	802.11n(HT40)	5755	Ant 2	35.8841	39.2
NVNT	802.11n(HT40)	5795	Ant 2	35.8042	39.28

OBW NVNT 802.11a 5745MHz Ant 1

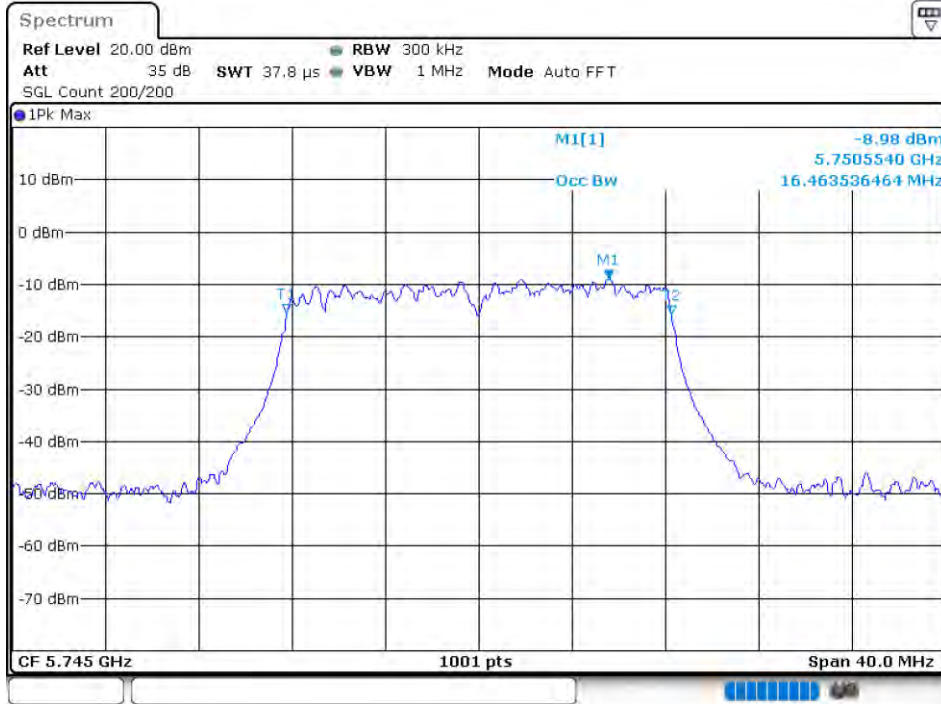

-26 dB BW NVNT 802.11a 5745MHz Ant 1

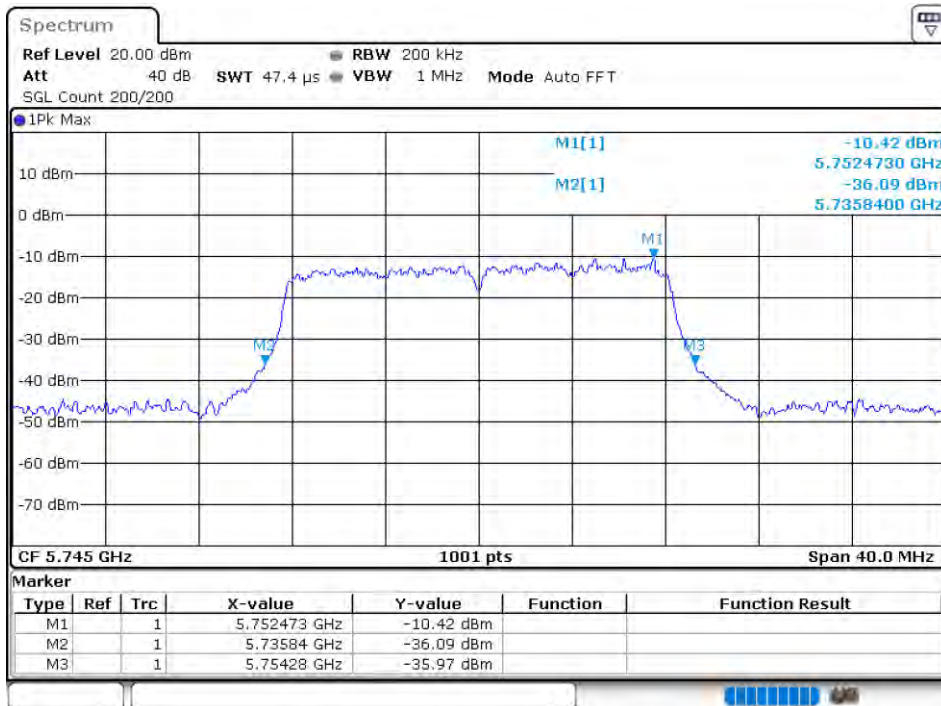

OBW NVNT 802.11a 5785MHz Ant 1

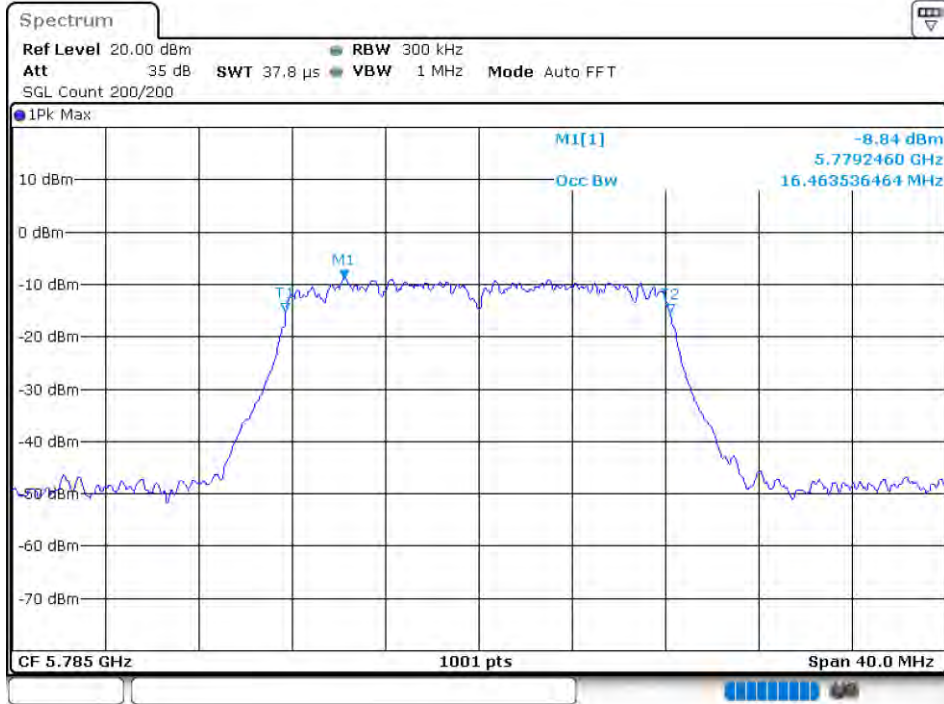

-26 dB BW NVNT 802.11a 5785MHz Ant 1

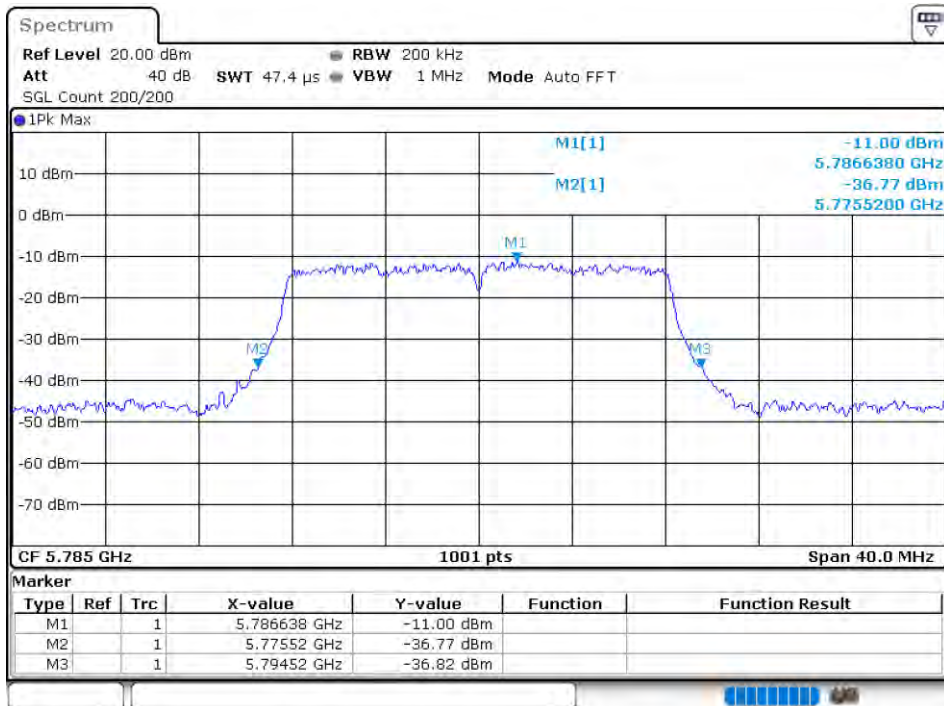

OBW NVNT 802.11a 5825MHz Ant 1

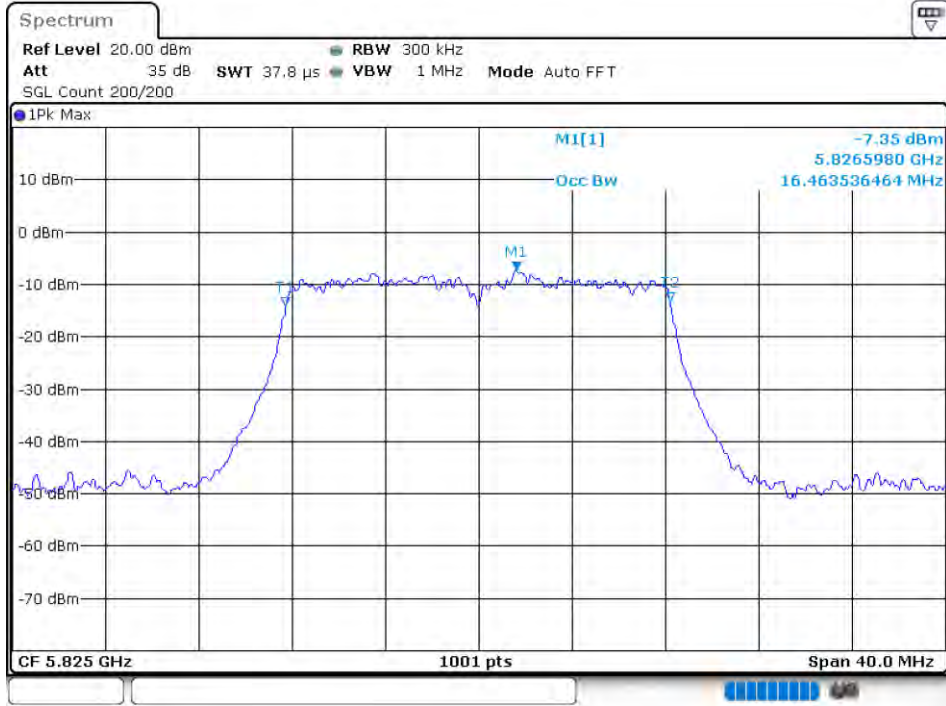

-26 dB BW NVNT 802.11a 5825MHz Ant 1

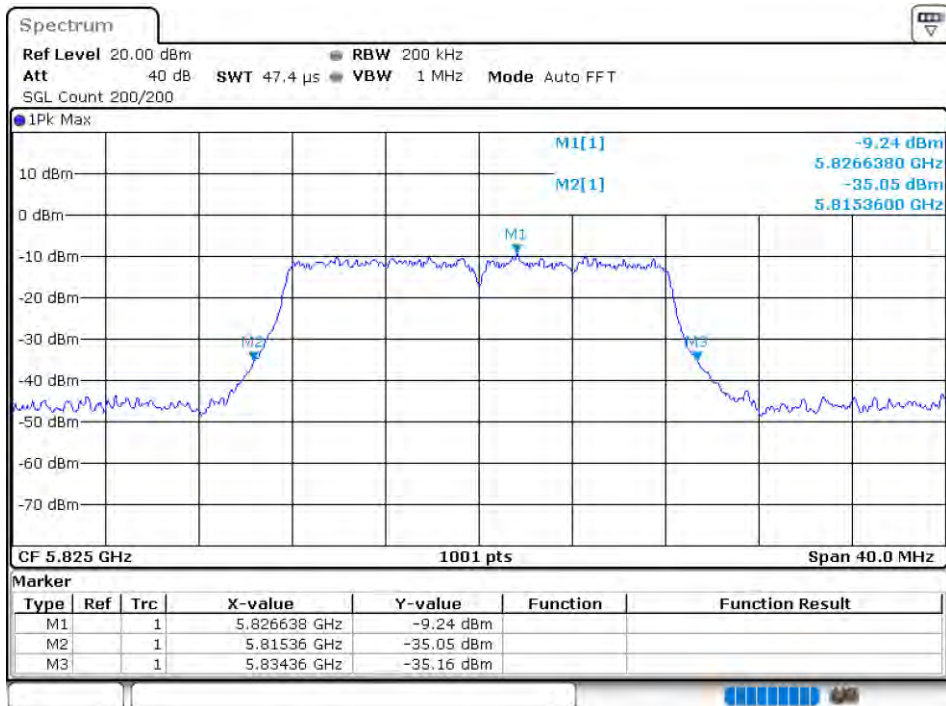



OBW NVNT 802.11a 5745MHz Ant 2

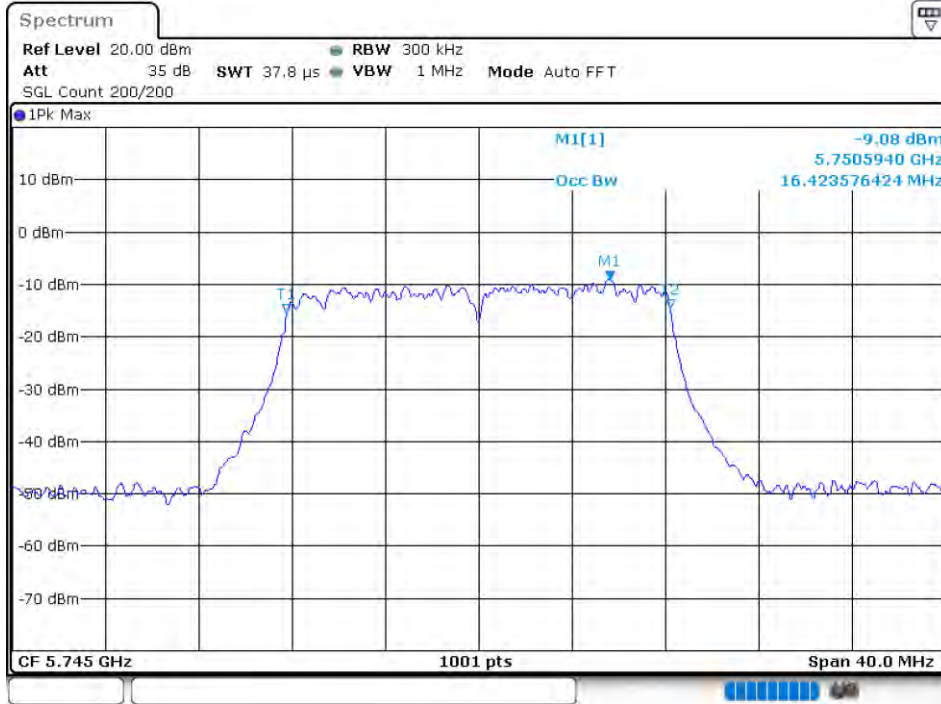

-26 dB BW NVNT 802.11a 5745MHz Ant 2

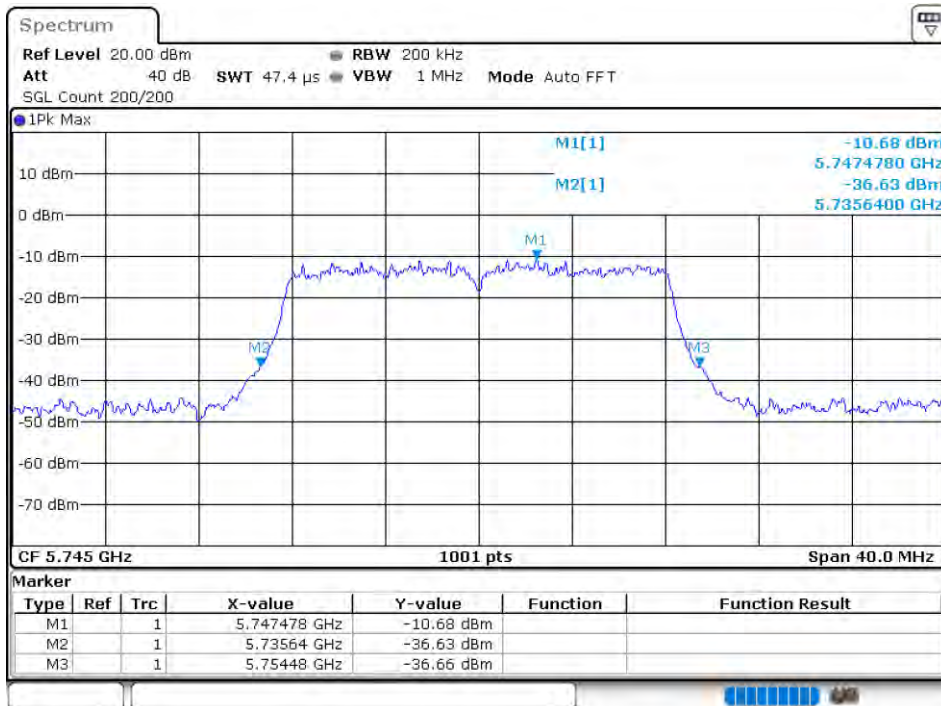

OBW NVNT 802.11a 5785MHz Ant 2

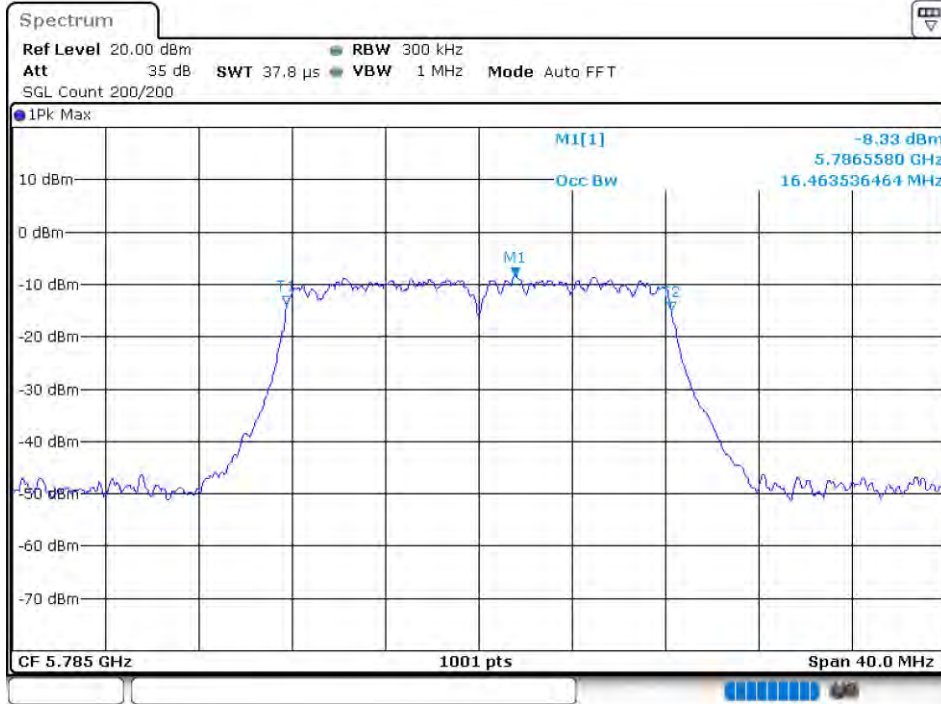

-26 dB BW NVNT 802.11a 5785MHz Ant 2

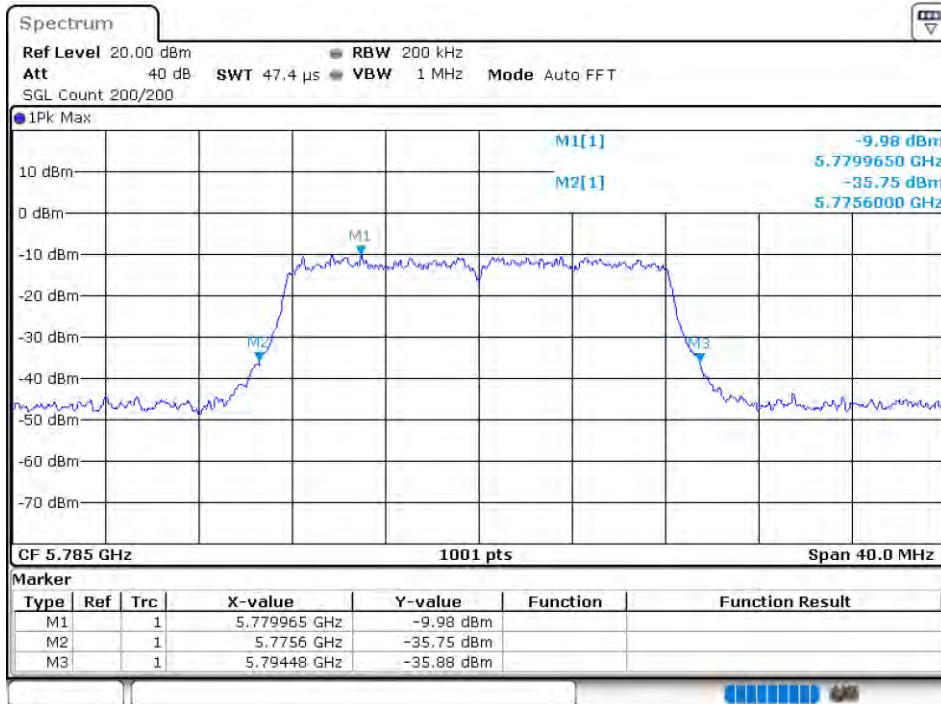



OBW NVNT 802.11a 5825MHz Ant 2

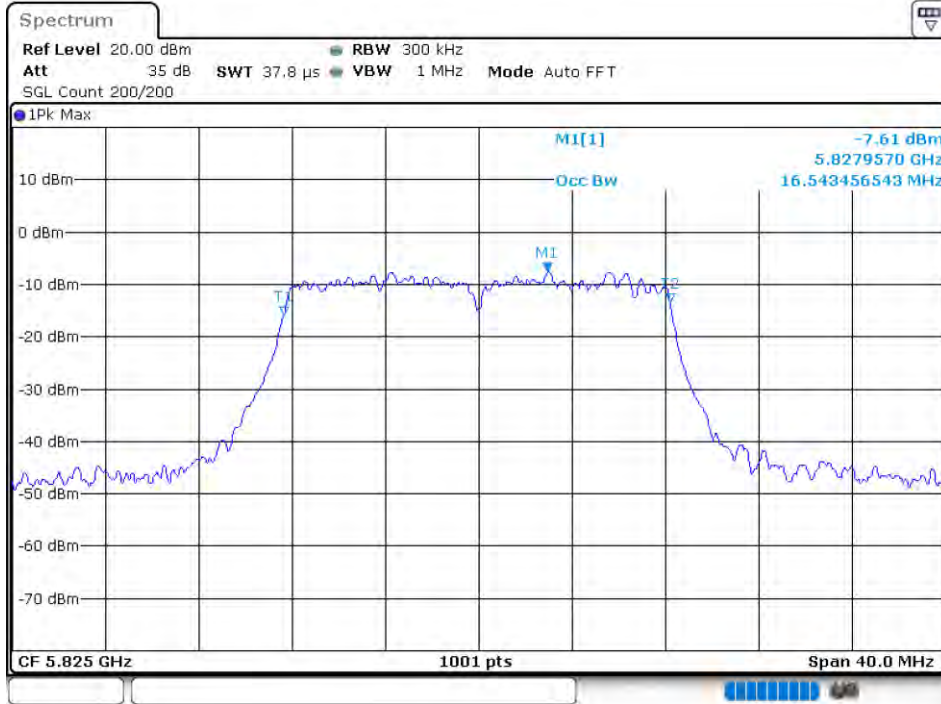

-26 dB BW NVNT 802.11a 5825MHz Ant 2



OBW NVNT 802.11ac20 5745MHz Ant 1

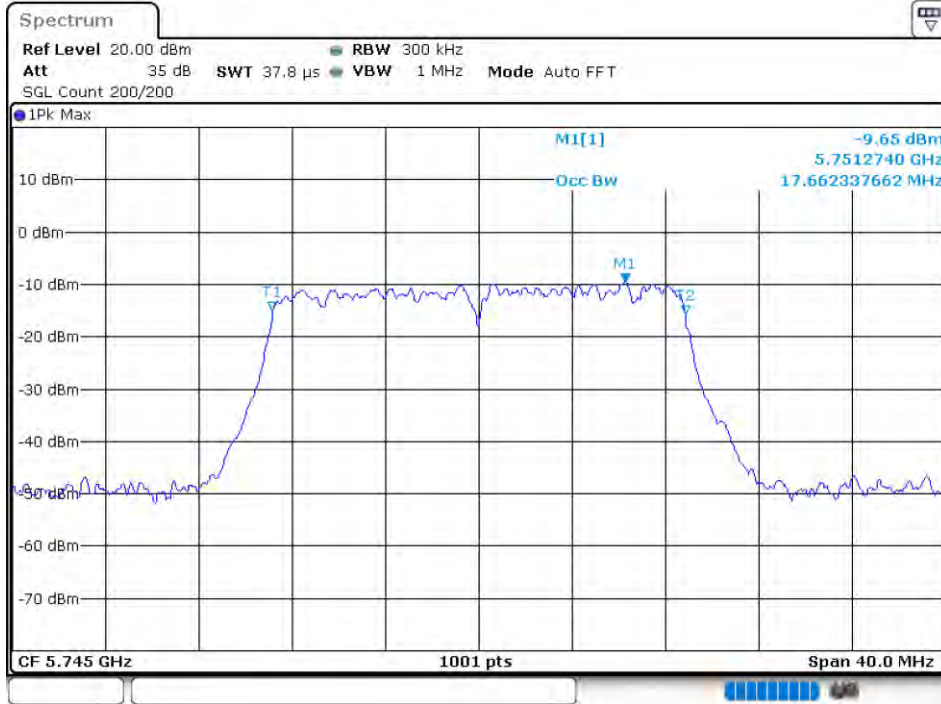

-26 dB BW NVNT 802.11ac20 5745MHz Ant 1

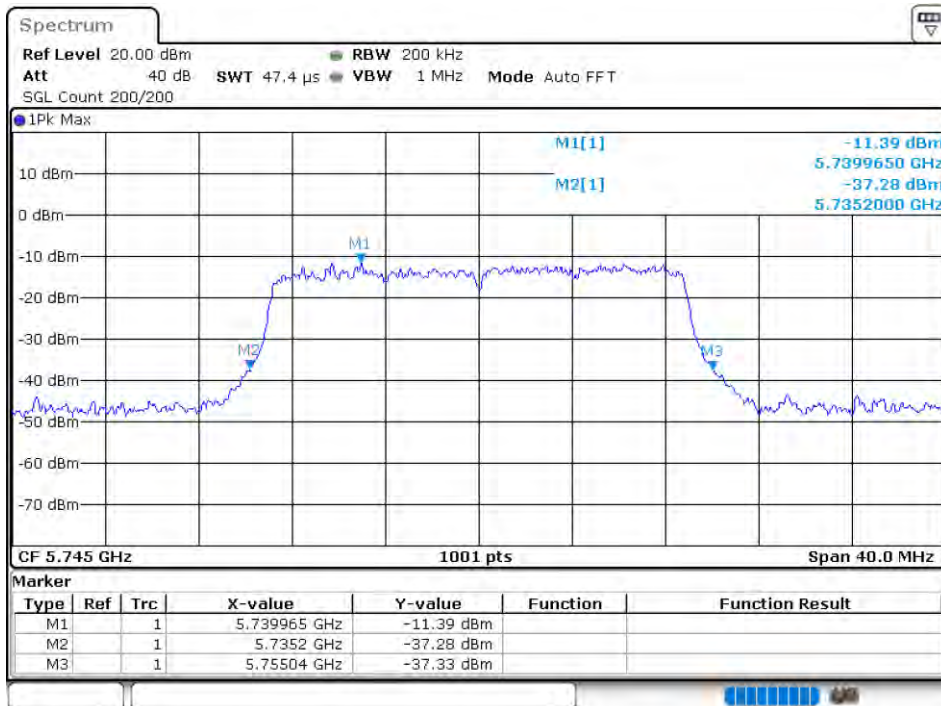

OBW NVNT 802.11ac20 5785MHz Ant 1

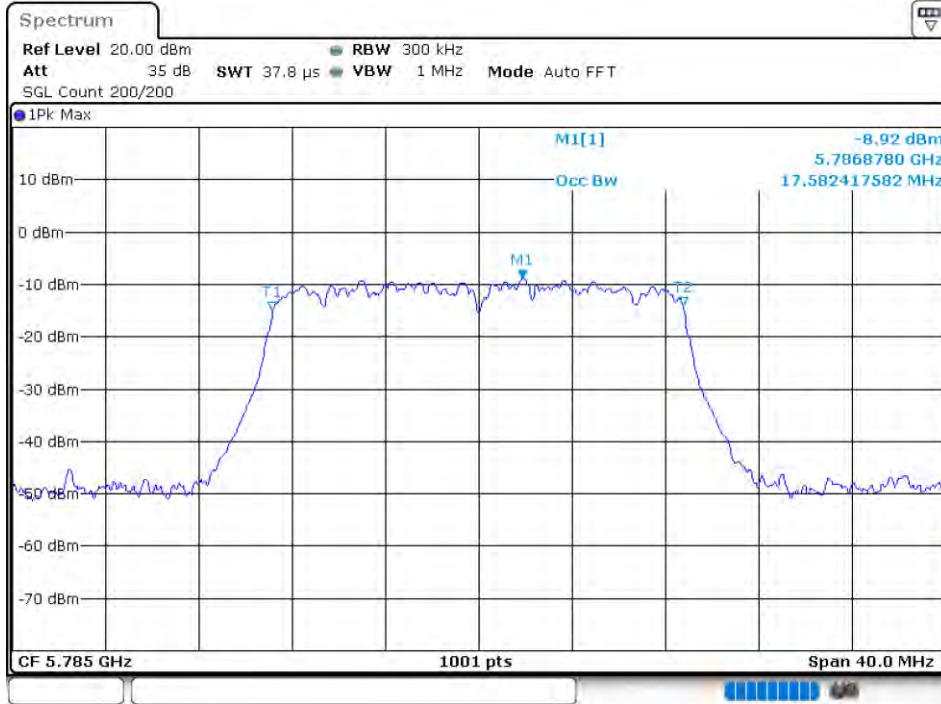

-26 dB BW NVNT 802.11ac20 5785MHz Ant 1

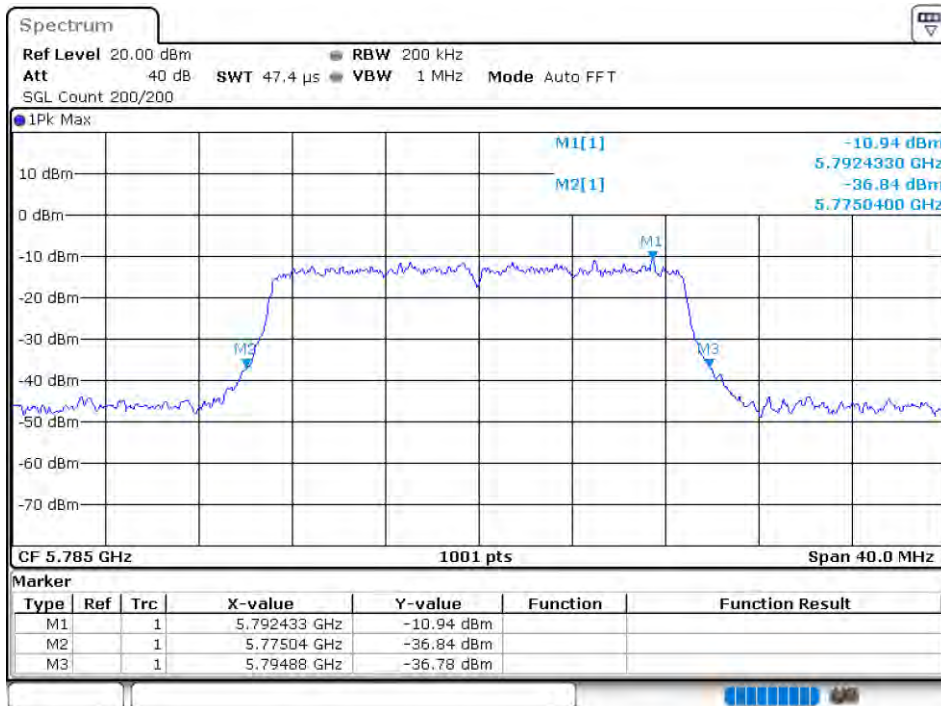

OBW NVNT 802.11ac20 5825MHz Ant 1

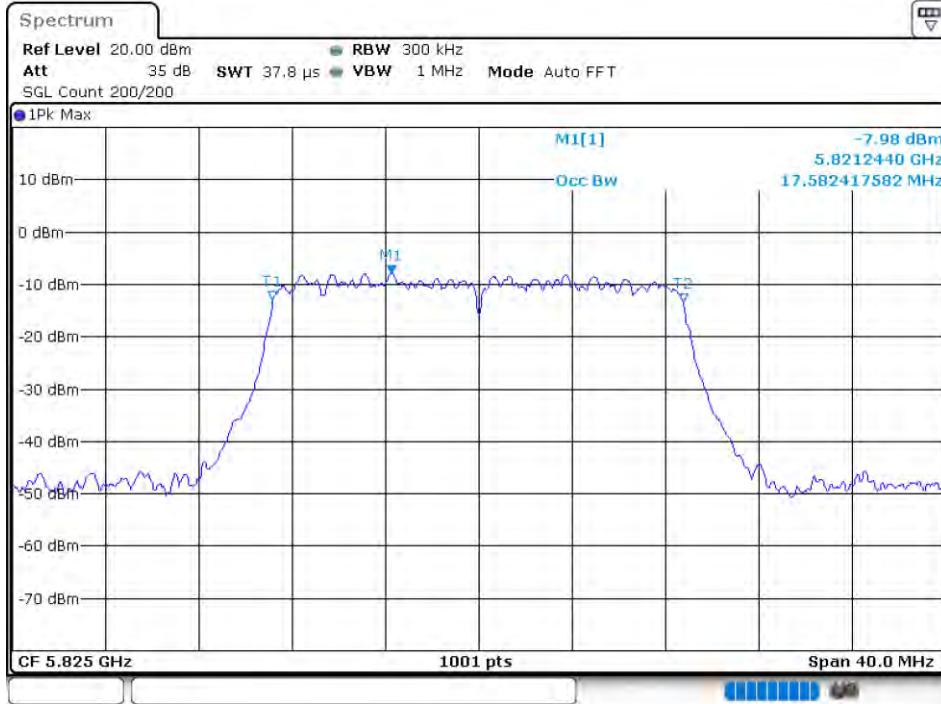

-26 dB BW NVNT 802.11ac20 5825MHz Ant 1

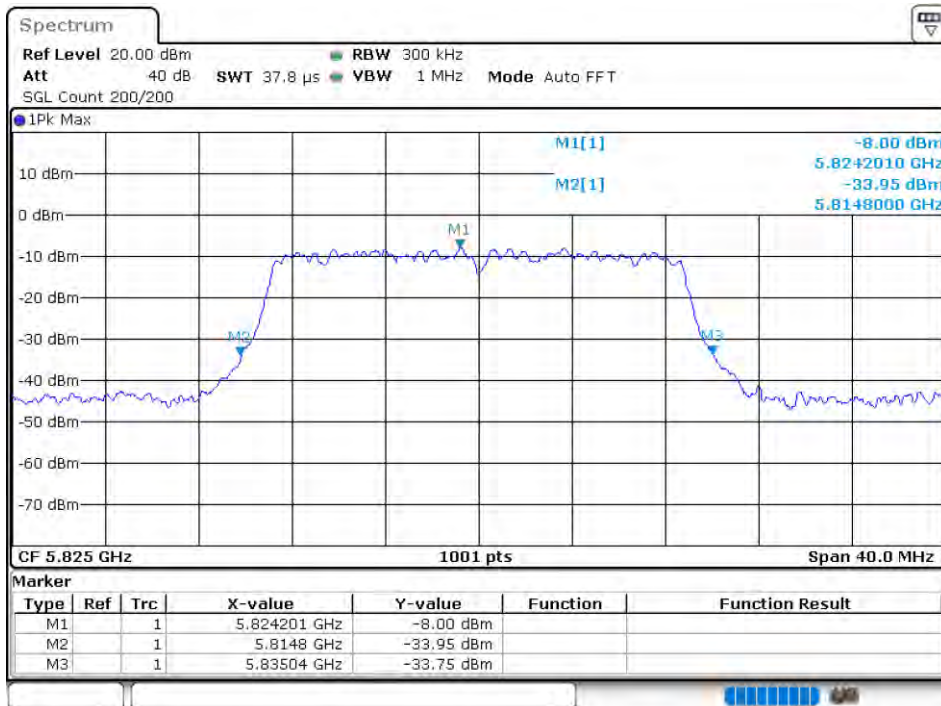



OBW NVNT 802.11ac20 5745MHz Ant 2

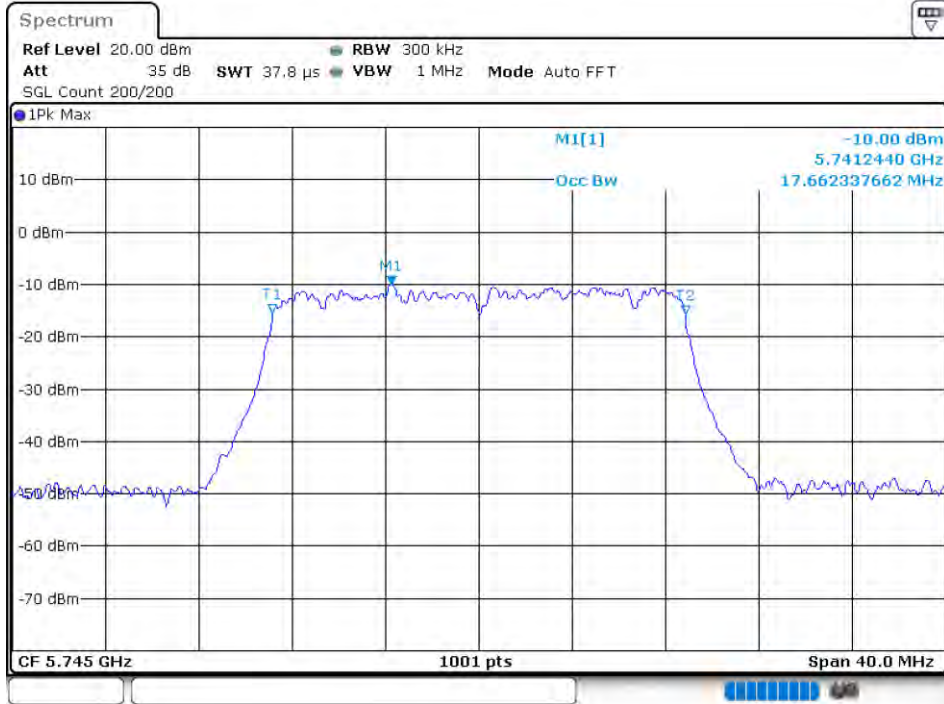

-26 dB BW NVNT 802.11ac20 5745MHz Ant 2

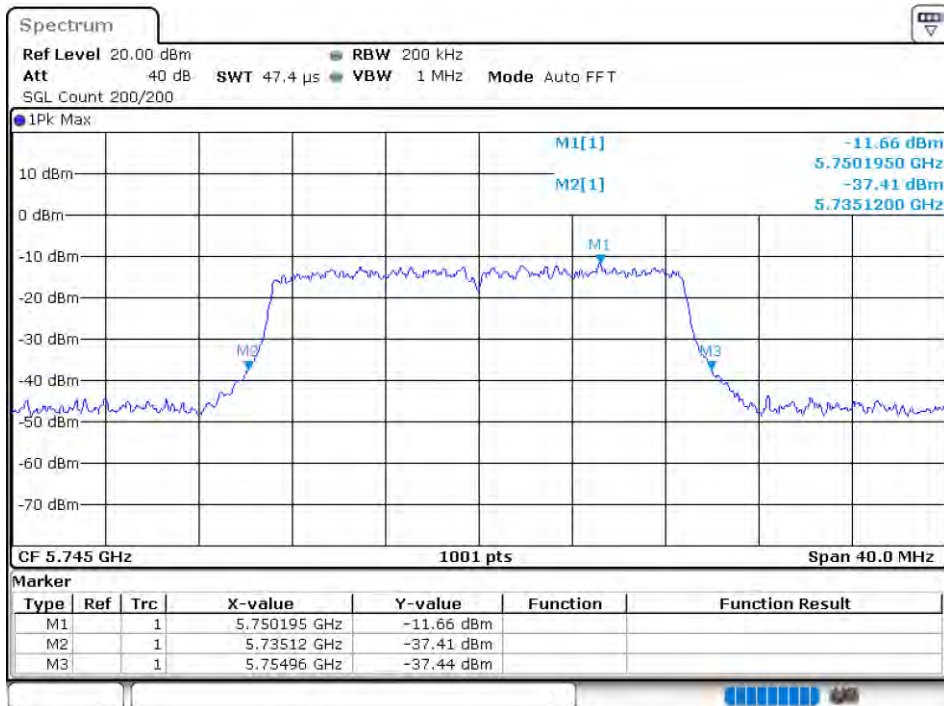

OBW NVNT 802.11ac20 5785MHz Ant 2

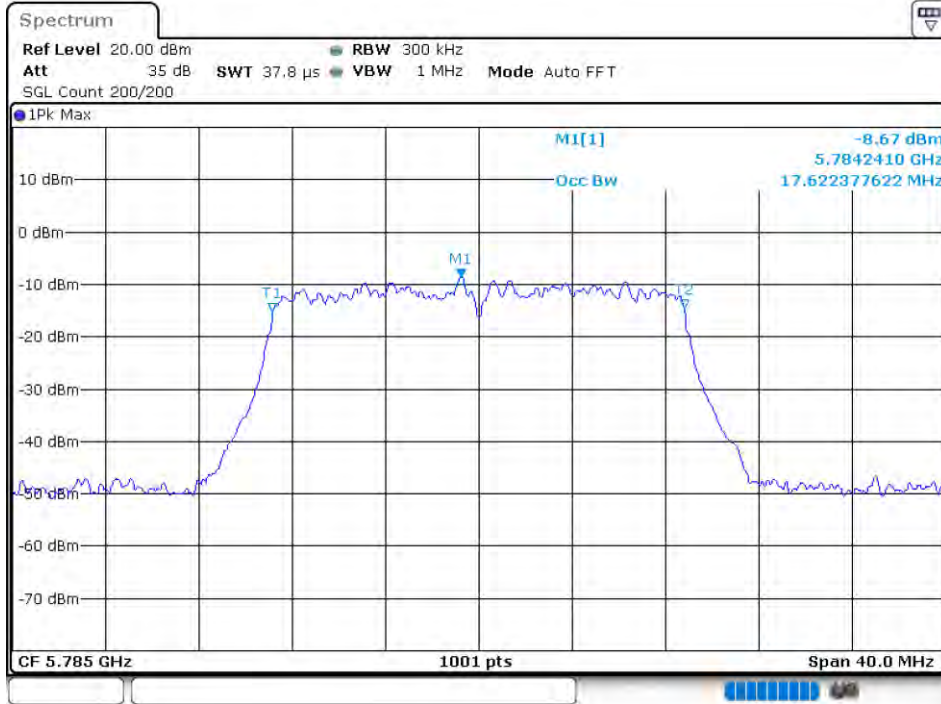

-26 dB BW NVNT 802.11ac20 5785MHz Ant 2

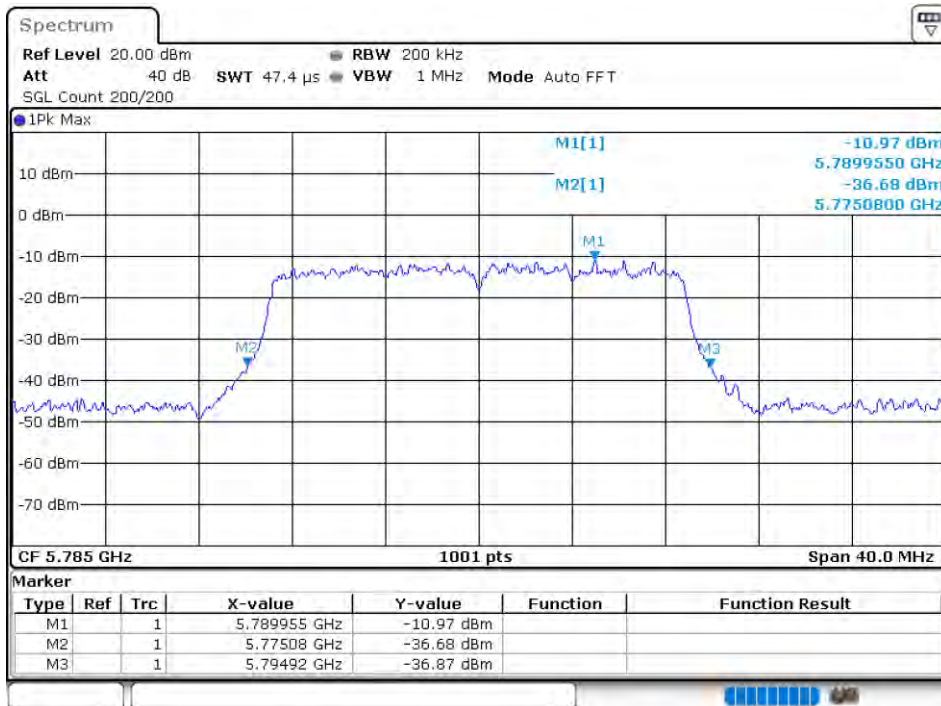



OBW NVNT 802.11ac20 5825MHz Ant 2

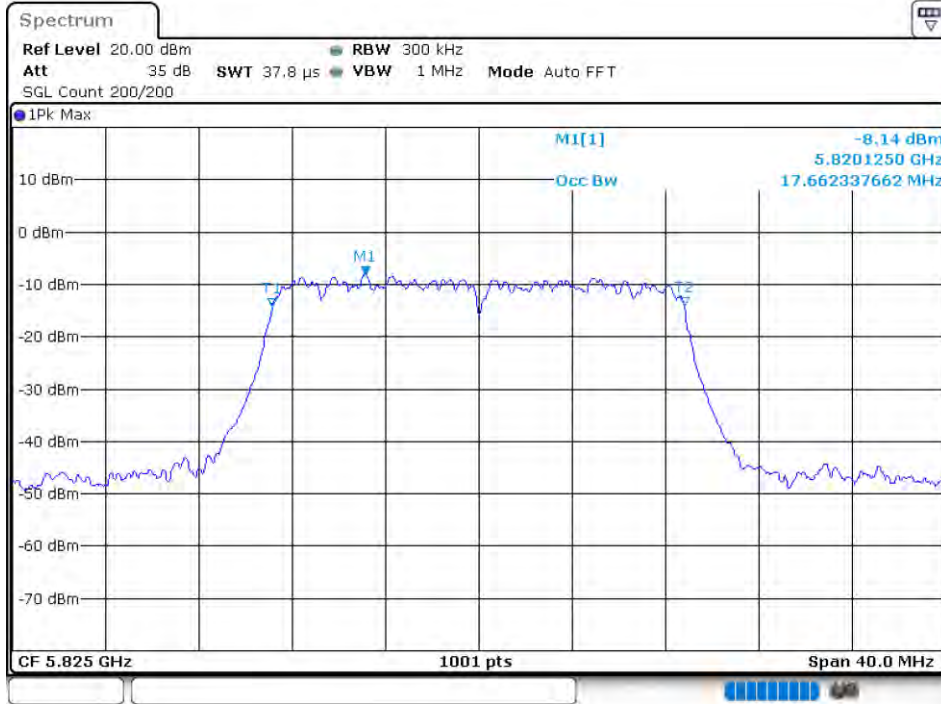

-26 dB BW NVNT 802.11ac20 5825MHz Ant 2

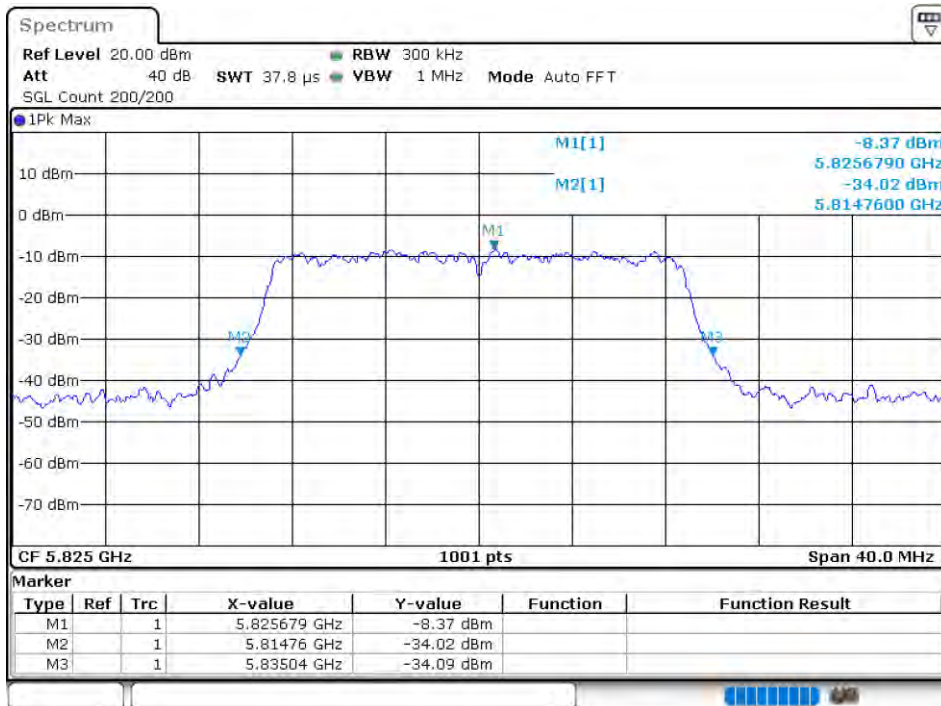

OBW NVNT 802.11ac40 5755MHz Ant 1

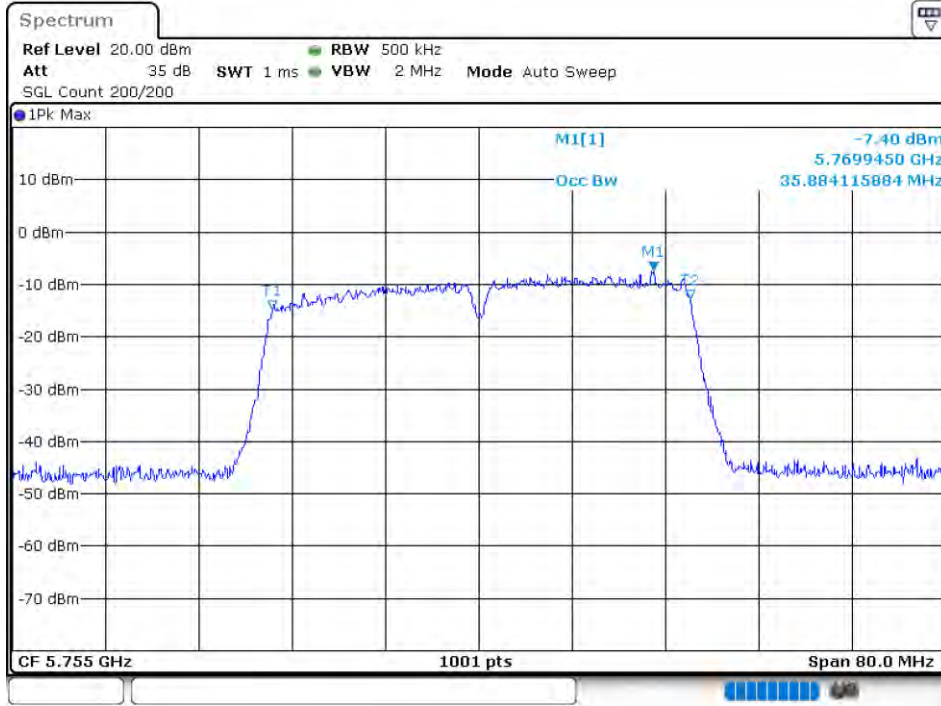

-26 dB BW NVNT 802.11ac40 5755MHz Ant 1

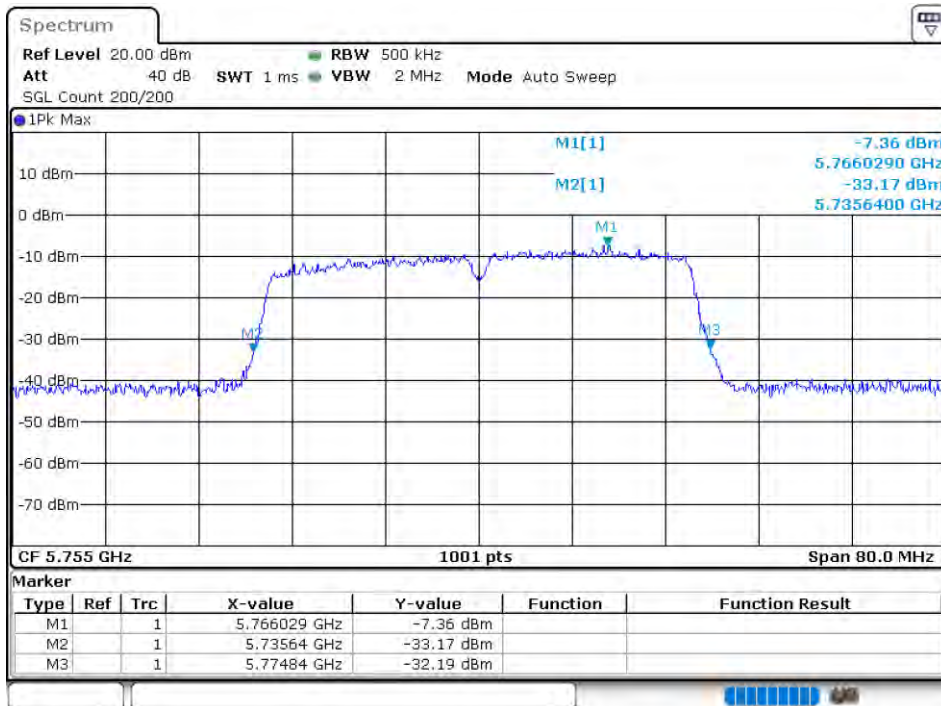

OBW NVNT 802.11ac40 5795MHz Ant 1

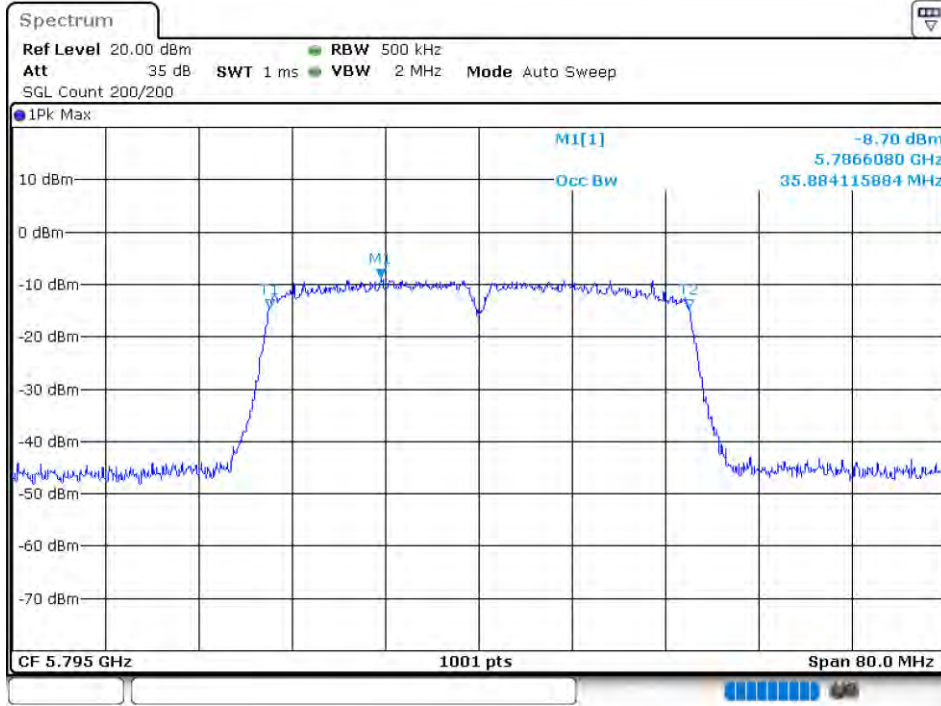

-26 dB BW NVNT 802.11ac40 5795MHz Ant 1

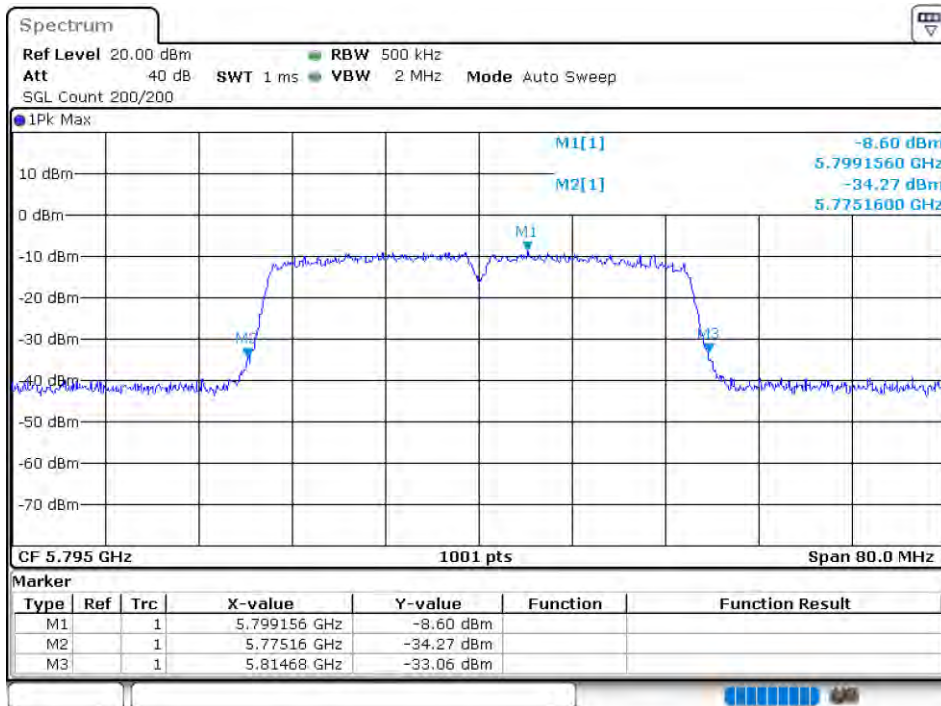

OBW NVNT 802.11ac40 5755MHz Ant 2

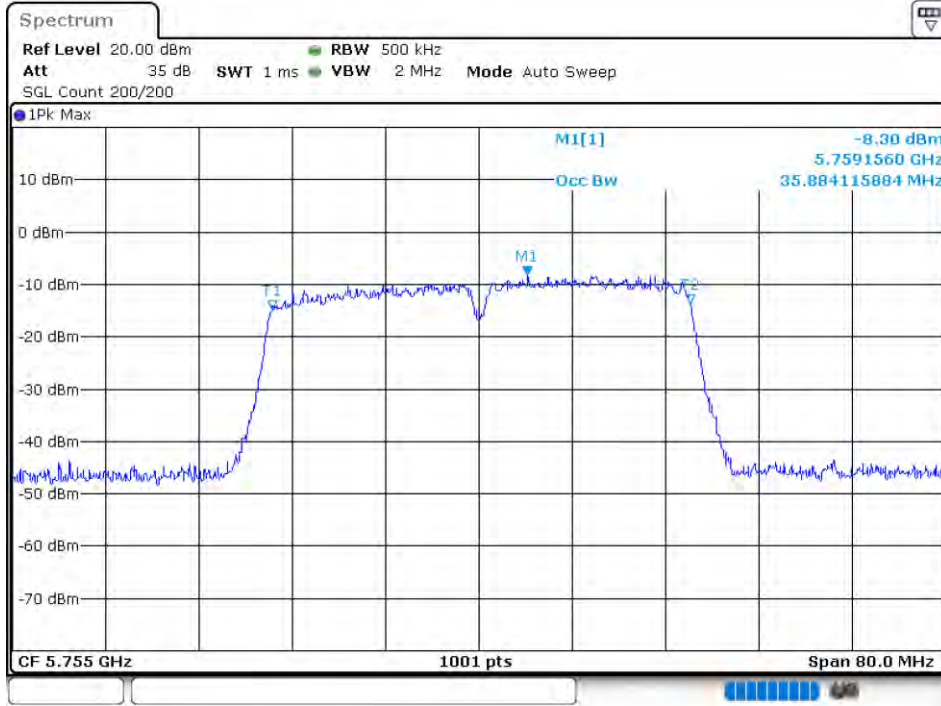

-26 dB BW NVNT 802.11ac40 5755MHz Ant 2

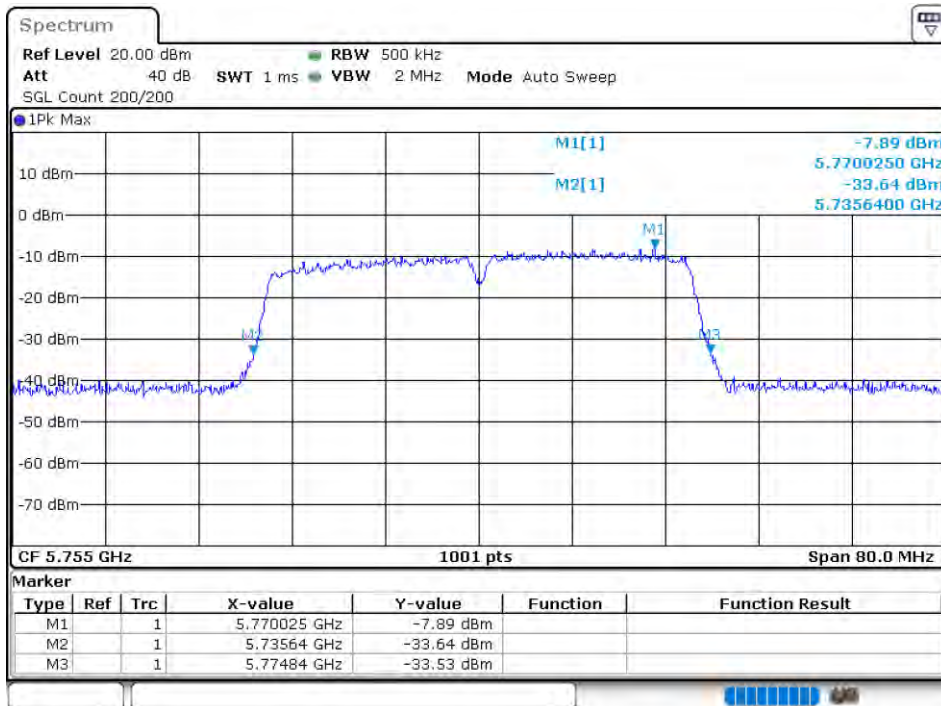



OBW NVNT 802.11ac40 5795MHz Ant 2

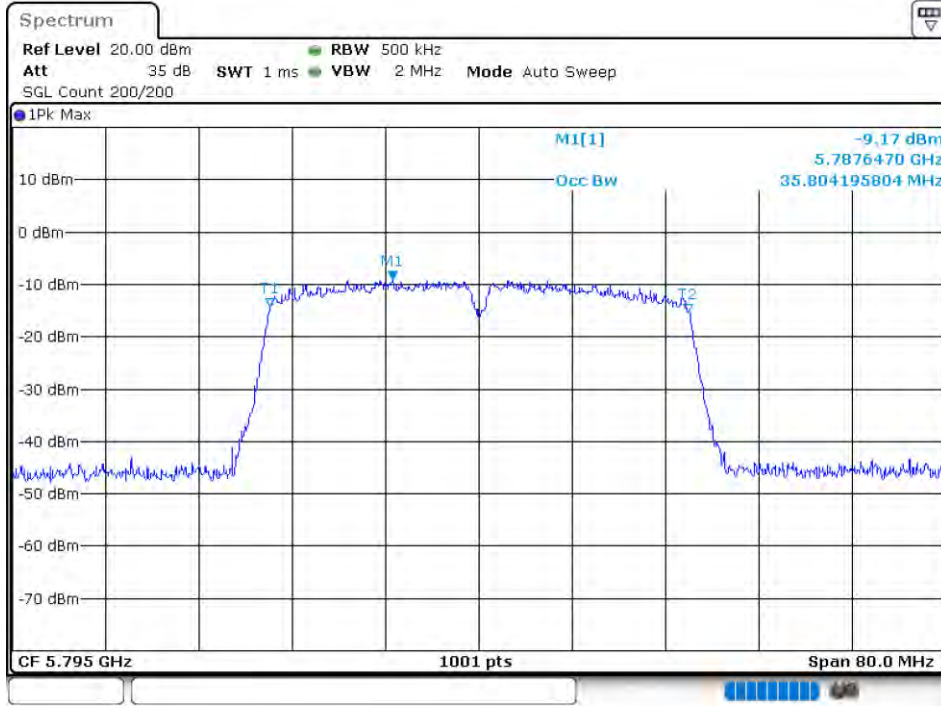

-26 dB BW NVNT 802.11ac40 5795MHz Ant 2

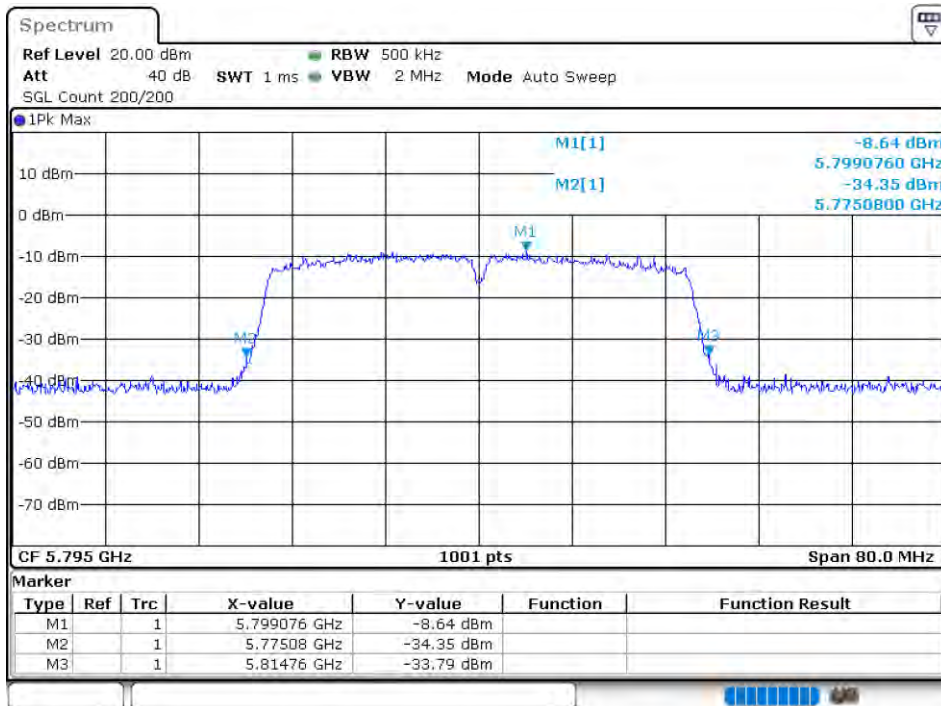

OBW NVNT 802.11ac80 5775MHz Ant 1

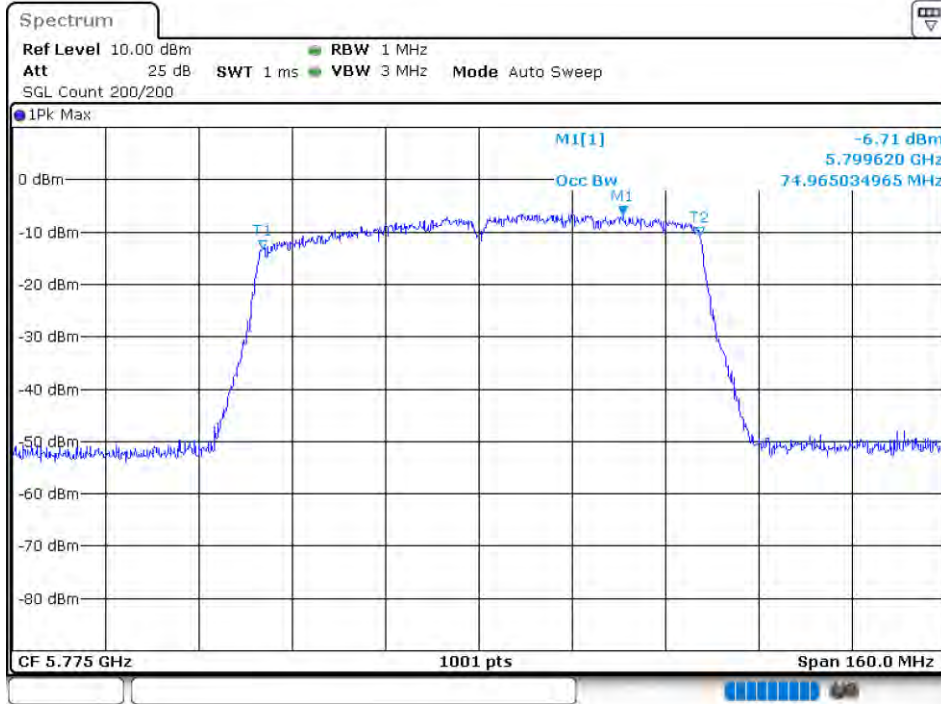

-26 dB BW NVNT 802.11ac80 5775MHz Ant 1

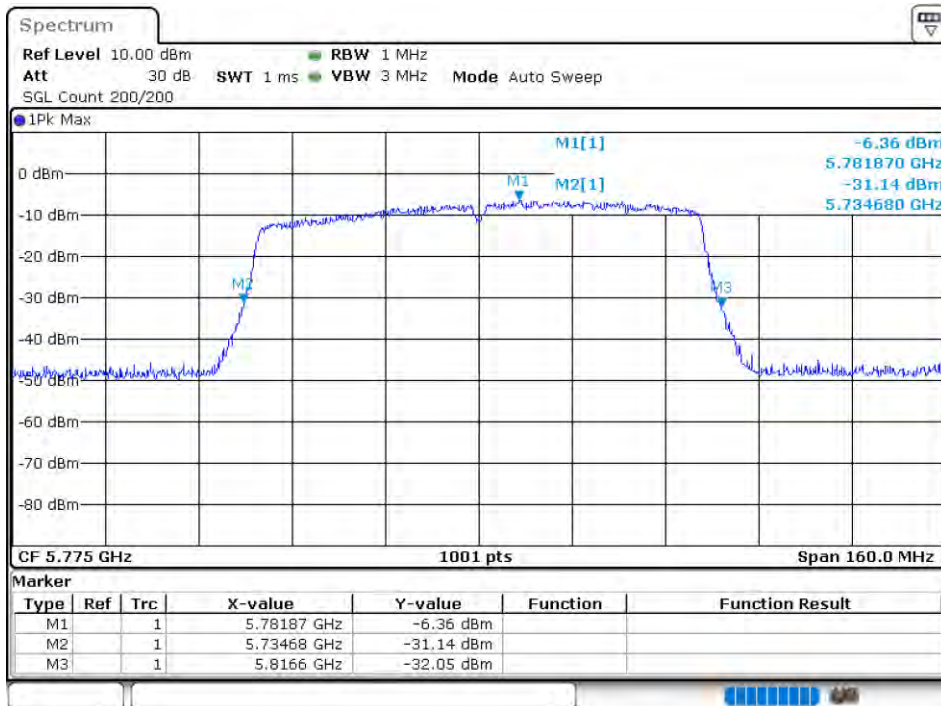



OBW NVNT 802.11ac80 5775MHz Ant 2

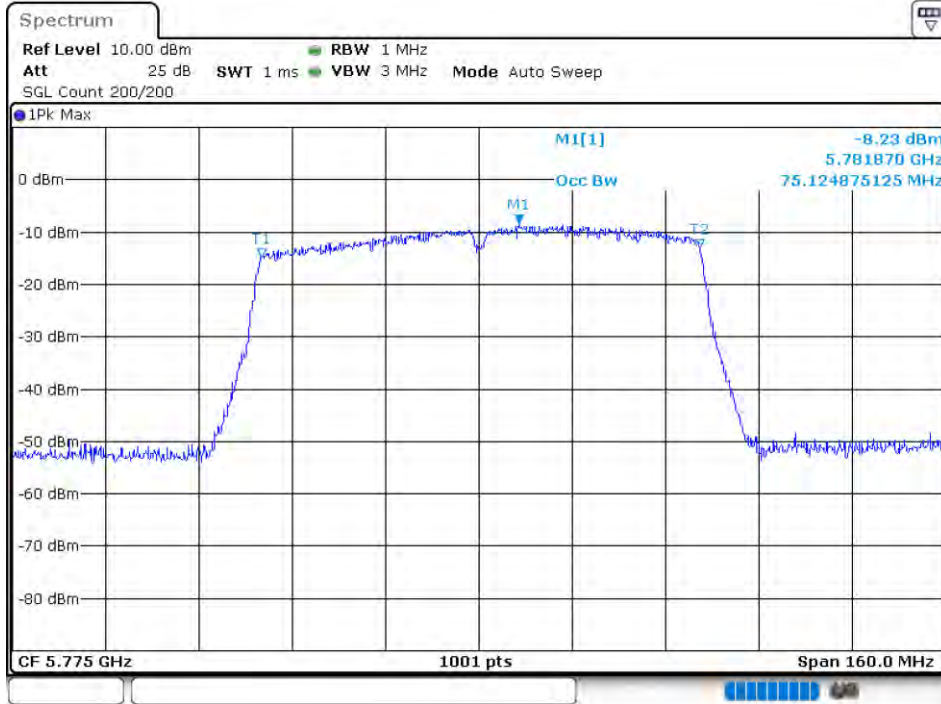

-26 dB BW NVNT 802.11ac80 5775MHz Ant 2

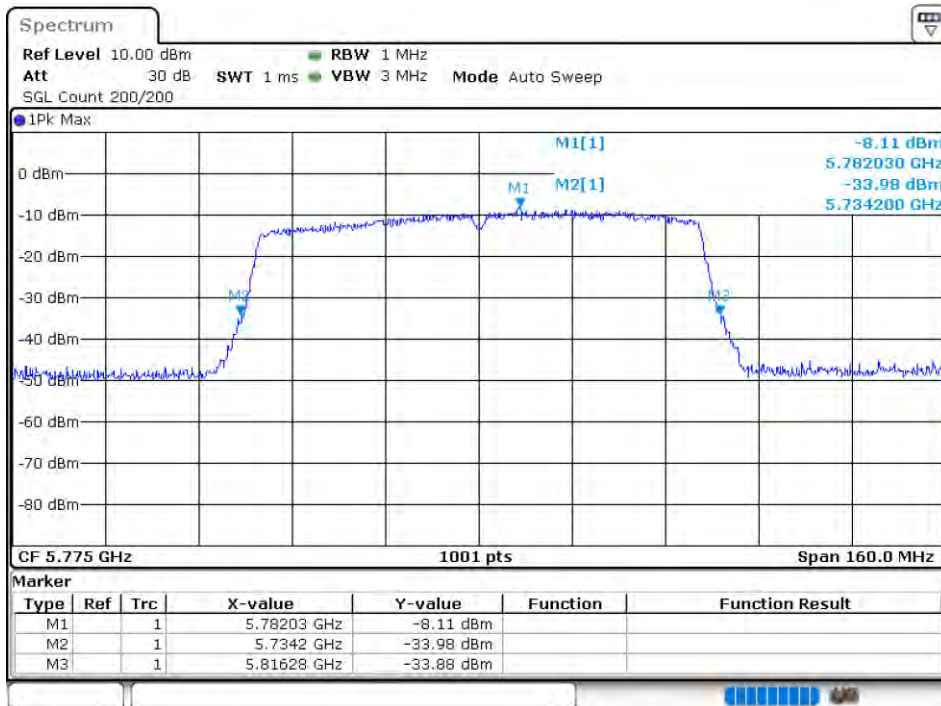

OBW NVNT 802.11n(HT20) 5745MHz Ant 1

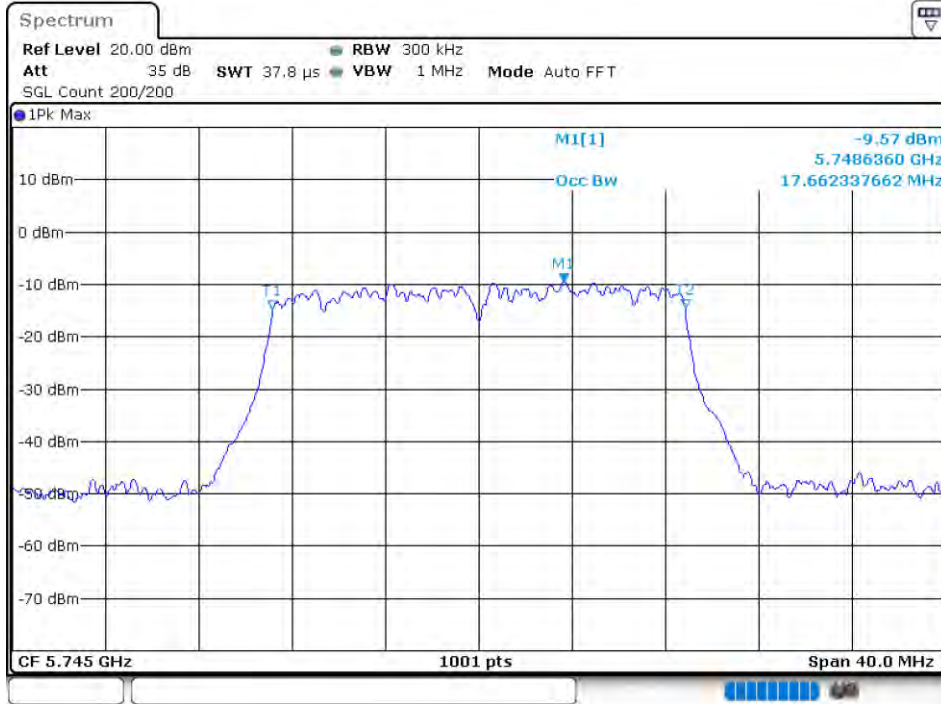

-26 dB BW NVNT 802.11n(HT20) 5745MHz Ant 1

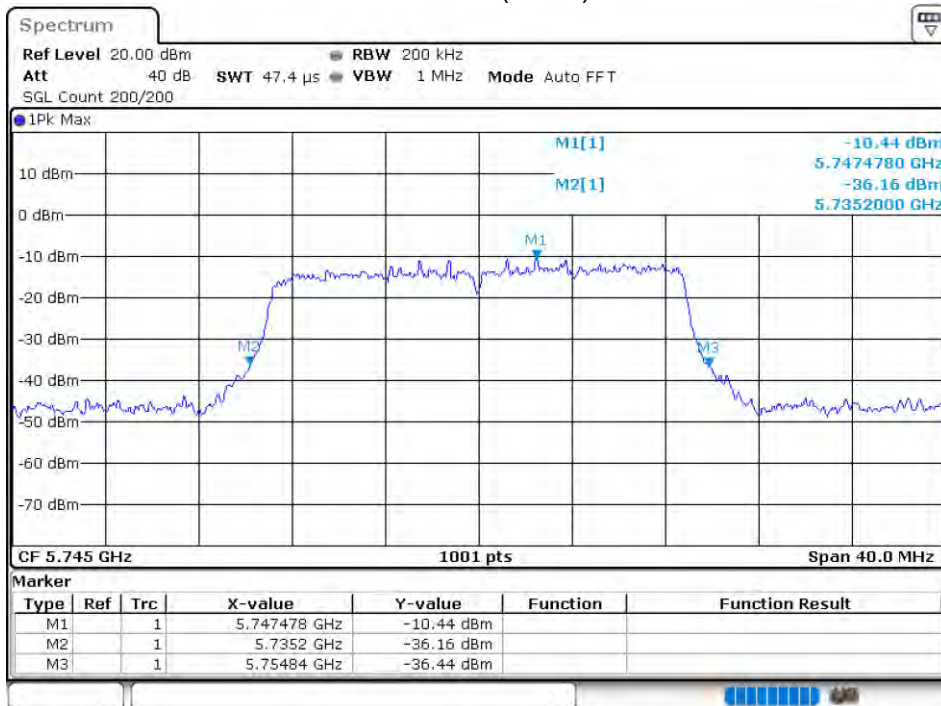

OBW NVNT 802.11n(HT20) 5785MHz Ant 1

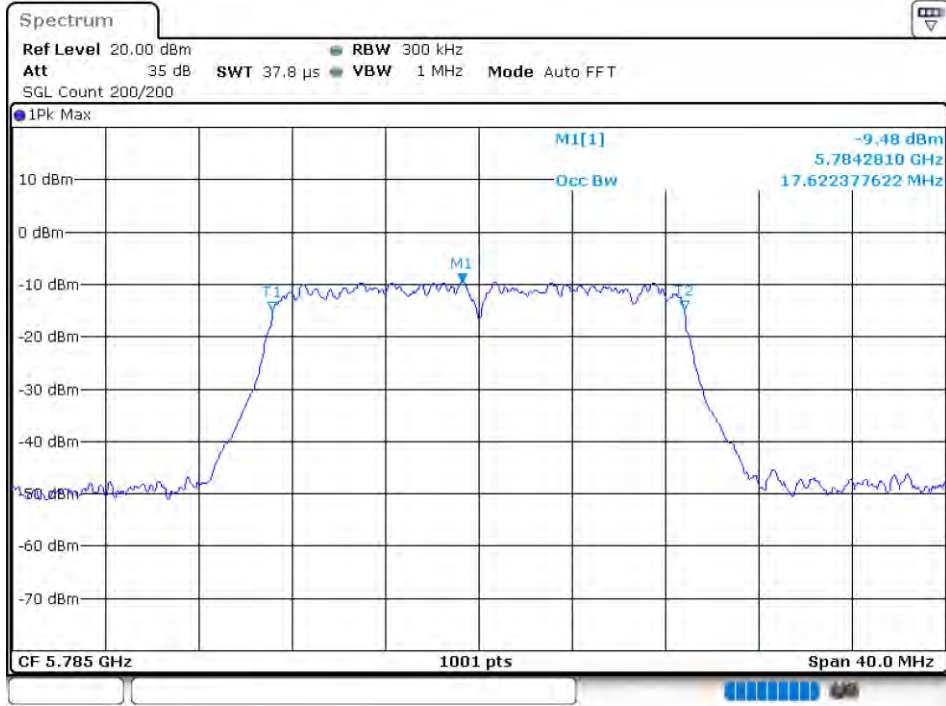

-26 dB BW NVNT 802.11n(HT20) 5785MHz Ant 1

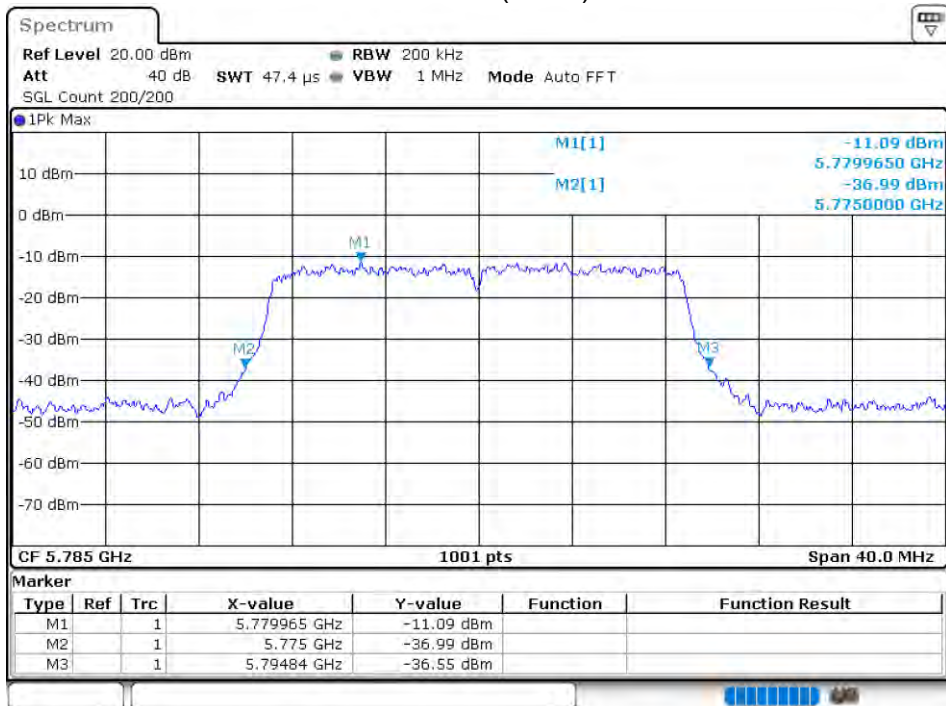

OBW NVNT 802.11n(HT20) 5825MHz Ant 1

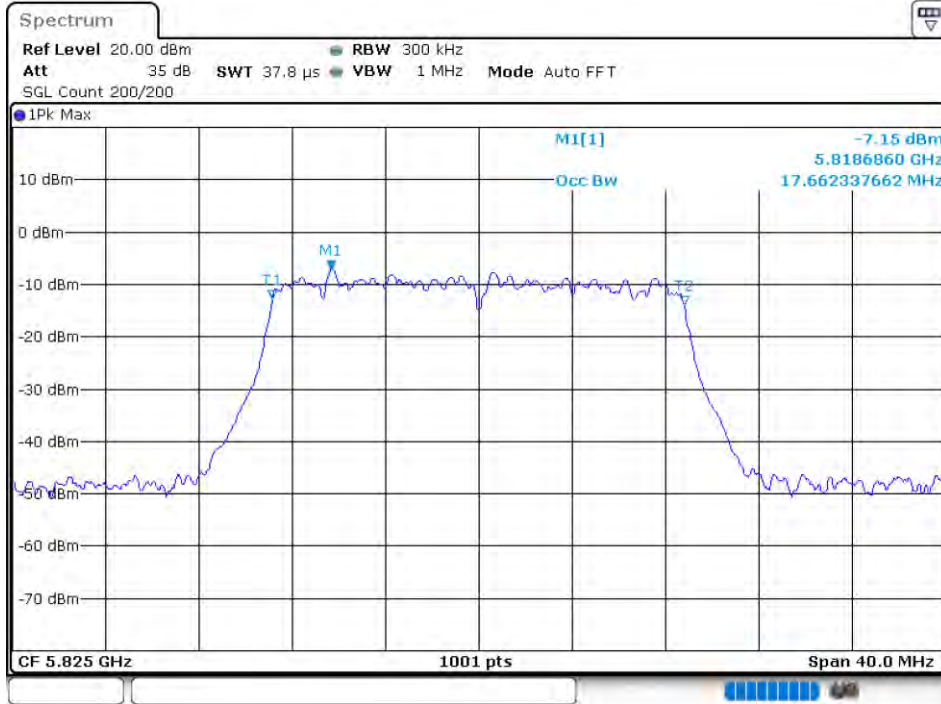

-26 dB BW NVNT 802.11n(HT20) 5825MHz Ant 1

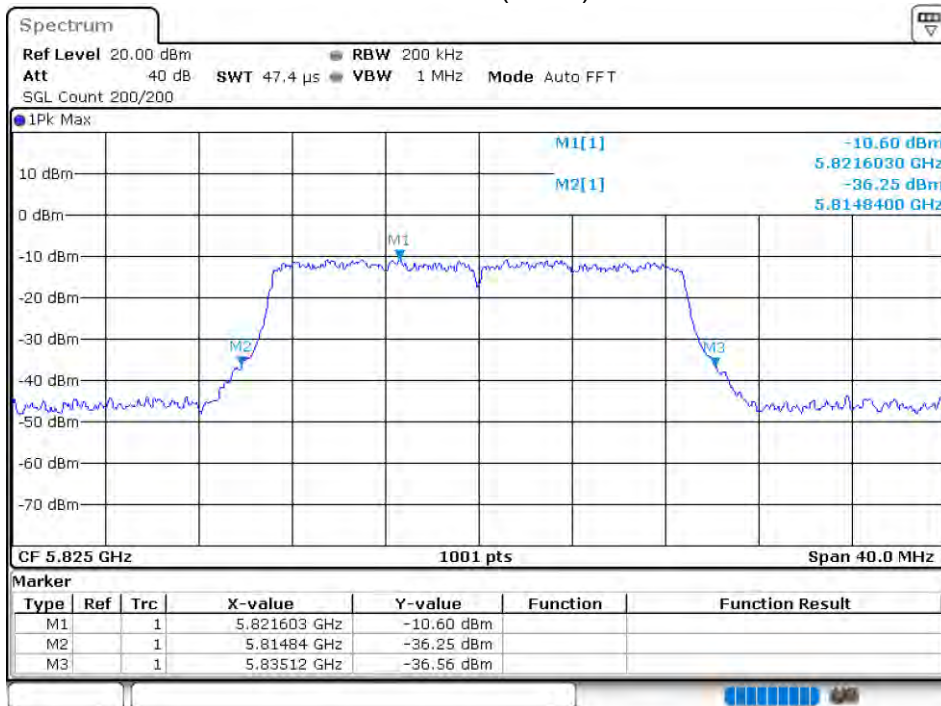



OBW NVNT 802.11n(HT20) 5745MHz Ant 2



-26 dB BW NVNT 802.11n(HT20) 5745MHz Ant 2



OBW NVNT 802.11n(HT20) 5785MHz Ant 2

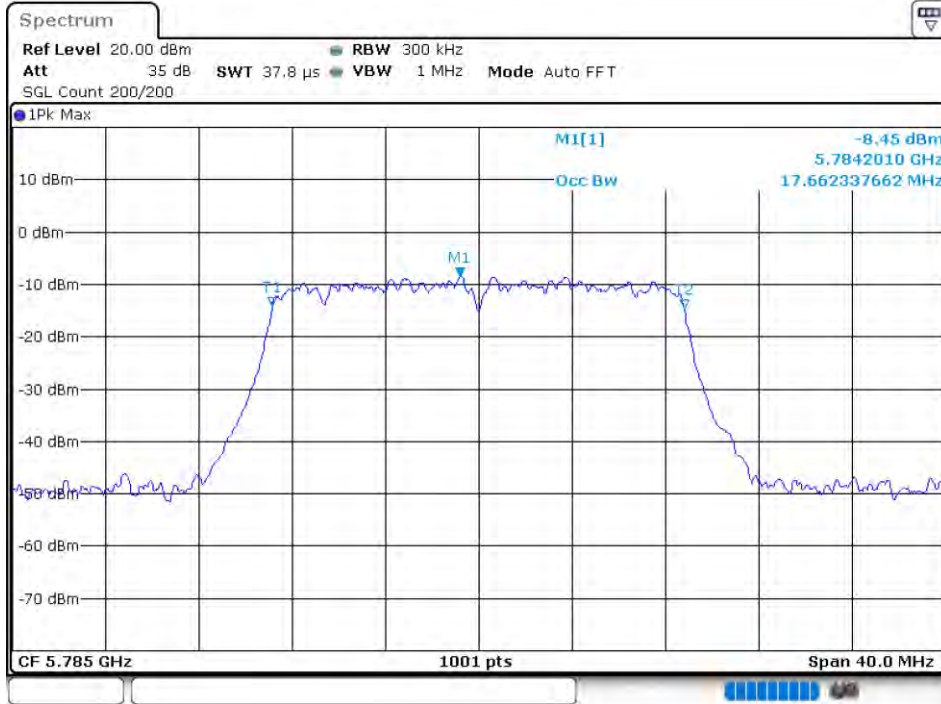

-26 dB BW NVNT 802.11n(HT20) 5785MHz Ant 2

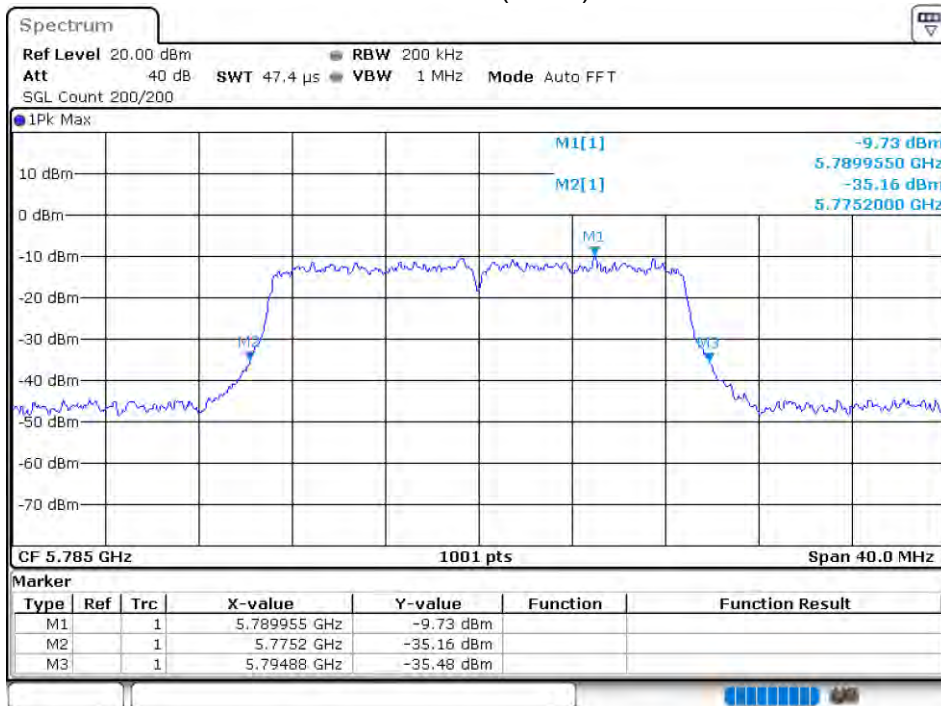



OBW NVNT 802.11n(HT20) 5825MHz Ant 2

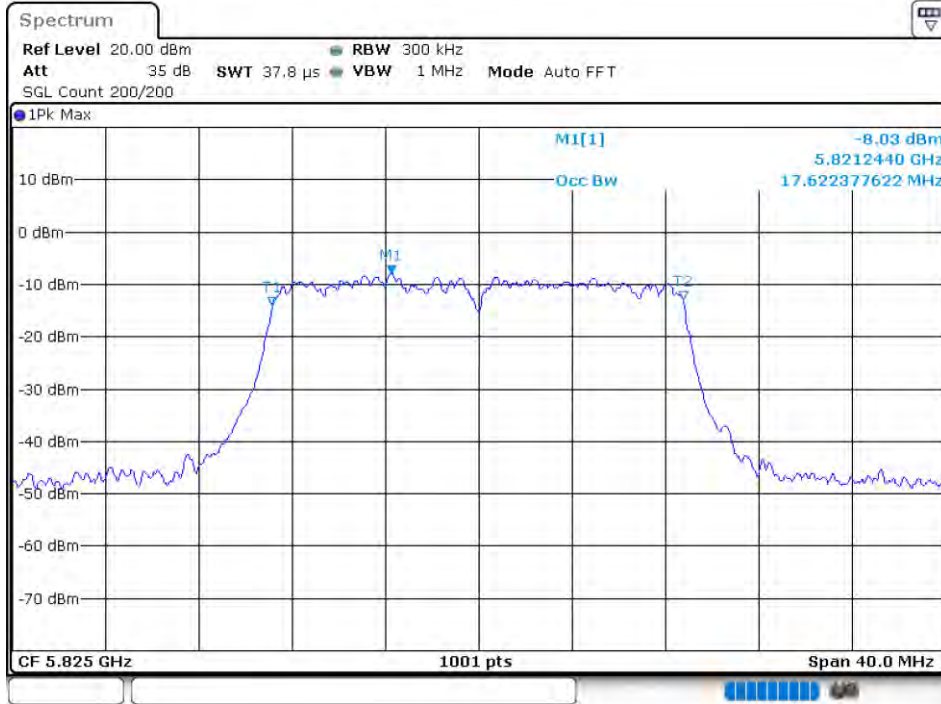

-26 dB BW NVNT 802.11n(HT20) 5825MHz Ant 2

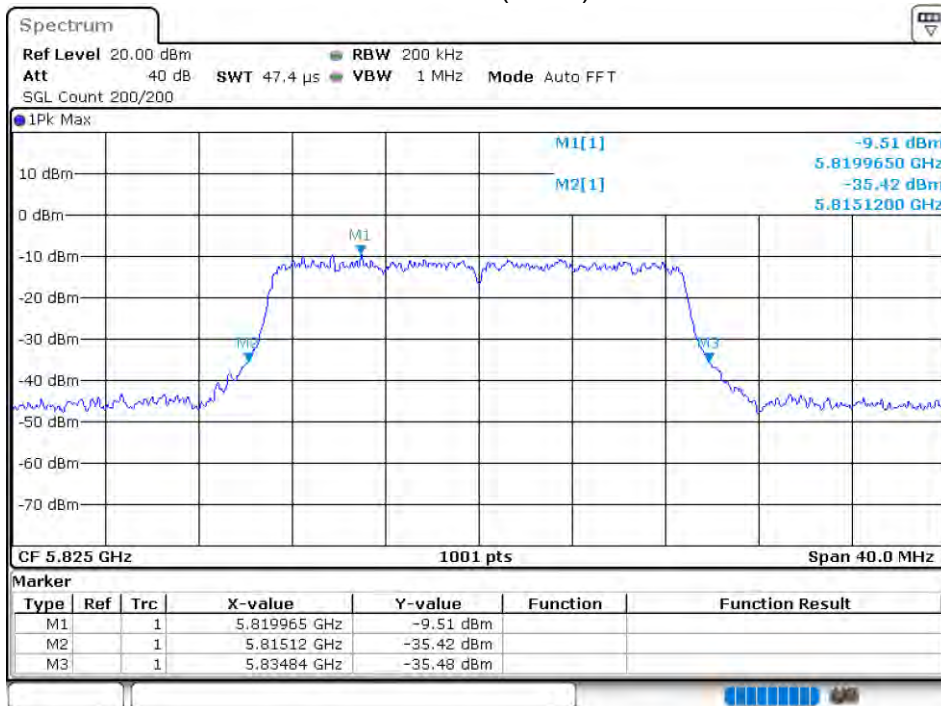

OBW NVNT 802.11n(HT40) 5755MHz Ant 1

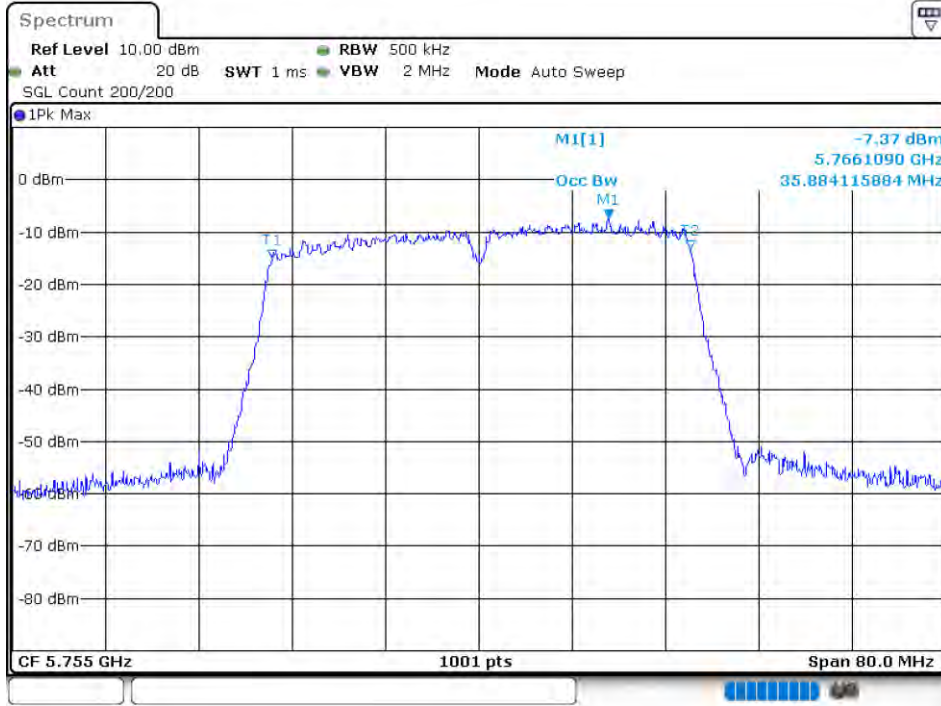

-26 dB BW NVNT 802.11n(HT40) 5755MHz Ant 1

