



# RADIO TEST REPORT

Report No:STS1906231W04

Issued for

Telecell Mobile (H.K) Ltd.

RM 801 Metro Ctr II, 21 Lam Hing Street, Kln Bay, Hong Kong

<b>Product Name:</b>	Vision
<b>Brand Name:</b>	
<b>Model Name:</b>	I232
<b>Series Model:</b>	N/A
<b>FCC ID:</b>	2ADX3I232
<b>Test Standard:</b>	FCC Part 15.407

Any reproduction of this document must be done in full. No single part of this document may be reproduced without permission from STS, All Test Data Presented in this report is only applicable to presented Test sample.

Shenzhen STS Test Services Co., Ltd.  
1/F., Building B, Zhuoke Science Park, No.190, Chongqing Road,  
Fuyong Street, Bao'an District, Shenzhen, Guangdong, China  
TEL: +86-755 3688 6288 FAX: +86-755 3688 6277 E-mail:sts@stsapp.com





### TEST RESULT CERTIFICATION

**Applicant's Name**..... : Telecell Mobile (H.K) Ltd.  
 Address ..... : RM 801 Metro Ctr II, 21 Lam Hing Street, Kln Bay, Hong Kong  
**Manufacture's Name**..... : Telecell Mobile (H.K) Ltd.  
 Address ..... : RM 801 Metro Ctr II, 21 Lam Hing Street, Kln Bay, Hong Kong

#### Product Description

Product Name..... : Vision  
 Brand Name ..... :   
 Model Name ..... : I232  
 Series Model..... : N/A

**Test Standards** ..... : FCC Part15.407

Test Procedure..... ANSI C63.10-2013

This device described above has been tested by STS, the test results show that the equipment under test (EUT) is in compliance with the FCC requirements. And it is applicable only to the tested sample identified in the report.

This report shall not be reproduced except in full, without the written approval of STS, this document only be altered or revised by STS, personal only, and shall be noted in the revision of the document.

**Date of Test** ..... :  
 Date (s) of performance of tests ..... : 26 June 2019 ~ 16 July 2019  
 Date of Issue..... : 16 July 2019  
 Test Result..... : **Pass**

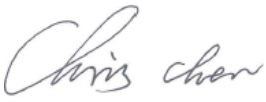
Testing Engineer :   
 \_\_\_\_\_  
 (Chris Chen)

Technical Manager :   
 \_\_\_\_\_  
 (Sunday Hu)

Authorized Signatory :   
 \_\_\_\_\_  
 (Vita Li)





Table of Contents	Page
<b>1 . SUMMARY OF TEST RESULTS</b>	<b>6</b>
1.1 TEST FACTORY	7
1.2 MEASUREMENT UNCERTAINTY	7
<b>2 . GENERAL INFORMATION</b>	<b>8</b>
2.1 GENERAL DESCRIPTION OF THE EUT	8
2.2 DESCRIPTION OF TEST MODES	11
2.3 BLOCK DIGRAM SHOWING THE CONFIGURATION OF SYSTEM TESTED	12
2.4 DESCRIPTION OF NECESSARY ACCESSORIES AND SUPPORT UNITS	13
2.5 EQUIPMENTS LIST FOR ALL TEST ITEMS	14
<b>3 . EMC EMISSION TEST</b>	<b>15</b>
3.1 CONDUCTED EMISSION MEASUREMENT	15
3.2 RADIATED EMISSION AND ( BANDEGE) MEASUREMENT	19
<b>4. CONDUCTED SPURIOUS EMISSIONS AND BANDEGE</b>	<b>34</b>
4.1 LIMIT	34
4.2 TEST PROCEDURE	34
4.3 DEVIATION FROM STANDARD	34
4.4 TEST SETUP	35
4.5 EUT OPERATION CONDITIONS	35
4.6 TEST RESULTS	35
<b>5. POWER SPECTRAL DENSITY TEST</b>	<b>36</b>
5.1 LIMIT	36
5.2 TEST PROCEDURE	36
5.3 DEVIATION FROM STANDARD	37
5.4 TEST SETUP	37
5.5 EUT OPERATION CONDITIONS	37
5.6 TEST RESULTS	37
<b>6. BANDWIDTH MEASUREMENT</b>	<b>38</b>
6.1 EMISSION BANDWIDTH (EBW) 26 BANDWID PROCEDURES / LIMIT	38
6.2 OCCUPIED BANDWIDTH ( 99%) TEST APPLIED PROCEDURES / LIMIT	39
6.3 MINIMUM EMISSION BANDWIDTH(6 DB) PROCEDURES / LIMIT	40
<b>7. MAXIMUM CONDUCTED OUTPUT POWER</b>	<b>41</b>
7.1 LIMIT	41
7.2 TEST PROCEDURE	41
7.3 DEVIATION FROM STANDARD	41



Table of Contents	Page
7.4 TEST SETUP	41
7.5 EUT OPERATION CONDITIONS	41
7.6 TEST RESULTS	42
<b>8. AUTOMATICALLY DISCONTINUE TRANSMISSION</b>	<b>53</b>
8.1 LIMIT OF AUTOMATICALLY DISCONTINUE TRANSMISSION	53
8.2 TEST RESULT OF AUTOMATICALLY DISCONTINUE TRANSMISSION	53
<b>9. ANTENNA REQUIREMENT</b>	<b>54</b>
9.1 STANDARD REQUIREMENT	54
9.2 EUT ANTENNA	54
<b>APPENDIX - PHOTOS OF TEST SETUP</b>	<b>55</b>





**Revision History**

Rev.	Issue Date	Report NO.	Effect Page	Contents
00	16 July 2019	STS1906229W04	ALL	Initial Issue





## 1. SUMMARY OF TEST RESULTS

Test procedures according to the technical standards:

§ 15.407, KDB 789033 D02 General U-NII Test Procedures New Rules v02r01

FCC Part 15.407		
FCC standard	Test Item	Results
15.207	AC Conducted Emission	PASS
§ 15.407 (2) (26 dB) / § 15.407 (e) (6 dB) / § 15.407 (a) (99%)	26dB/6dB & 99% Bandwidth	PASS
15.407(a) (1).(2).(3).(4).(5)	Maximum Conducted Output Power	PASS
15.407(b) & 15.209	Radiated Emission And (bandedge Emissions) Measurement	PASS
15.407(b)7	Conducted Emission And (bandedge Emissions) Measurement	PASS
15.407(a) (1).(2).(3).(4).(5)	Power Spectral Density	PASS
15.407(c)	Automatically Discontinue Transmission	PASS
15.203/15.204	Antenna Requirement	PASS

NOTE:

(1) "N/A" denotes test is not applicable in this Test Report

(2) all tests are according to ANSI C63.10-2013



## 1.1 TEST FACTORY

Shenzhen STS Test Services Co., Ltd.

Add. : 1/F., Building B, Zhuoke Science Park, No.190, Chongqing Road,  
Fuyong Street, Bao'an District, Shenzhen, Guangdong, China

FCC test Firm Registration Number: 625569

A2LA Certificate No.: 4338.01;

## 1.2 MEASUREMENT UNCERTAINTY

The reported uncertainty of measurement  $y \pm U$ , where expanded uncertainty  $U$  is based on a standard uncertainty multiplied by a coverage factor of  $k=2$ , providing a level of confidence of approximately **95 %**.

No.	Item	Uncertainty
1	RF output power, conducted	$\pm 0.71\text{dB}$
2	Unwanted Emissions, conducted	$\pm 0.63\text{dB}$
3	All emissions, radiated 30-200MHz	$\pm 3.43\text{dB}$
4	All emissions, radiated 200MHz-1GHz	$\pm 3.57\text{dB}$
5	All emissions, radiated >1G	$\pm 4.13\text{dB}$
6	Conducted Emission (9KHz-150KHz)	$\pm 3.18\text{dB}$
7	Conducted Emission (150KHz-30MHz)	$\pm 2.70\text{dB}$

## 2. GENERAL INFORMATION

### 2.1 GENERAL DESCRIPTION OF THE EUT

Product Name	Vision	
Trade Name		
Model Name	I232	
Series Model	N/A	
Model Difference	N/A	
Product Description	The EUT is a Vision	
	Operation Frequency:	IEEE 802.11a/ n(HT20)/ac(VHT20): 5.180GHz-5.240GHz IEEE 802.11n(HT40)/ac(VHT40): 5.190GHz-5.310GHz IEEE 802.11ac(VHT80): 5.210GHz
		IEEE 802.11a/ n(HT20)/ac(VHT20): 5.745GHz-5.825GHz IEEE 802.11n(HT40)/ac(VHT40): 5.755GHz-5.795GHz IEEE 802.11ac(VHT80): 5.775GHz
	Modulation Type:	802.11a(OFDM): BPSK,QPSK,16-QAM,64-QAM 802.11n(OFDM): BPSK,QPSK,16-QAM,64-QAM 802.11ac(OFDM): BPSK,QPSK,16-QAM,64-QAM,256-QAM
	Antenna Designation:	See Note 2
	Max.Output Power(Conducted):	16.515dBm
	More details of EUT technical specification, please refer to the User's Manual.	
Test Channel	Please refer to the Note 2.	
Adapter	Input: 100-240V, 50/60Hz, 0.5A Max Output: DC12V,1A	
Hardware version number	SLT768_V1.0.3	
Software version number	I232S_EQ103_00B.B8E980.B8A1B01_N180928_1012_C07_V01-normal	
Connecting I/O Port(s)	Please refer to the User's Manual	

Note:For a more detailed features description, please refer to the manufacturer's specifications or the User's Manual.





1. Operation Frequency of channel

5.180GHz-5.240GHz		5.745GHz-5.825GHz	
Channel	Frequency	Channel	Frequency
36	5180	149	5745
38	5190	151	5755
40	5200	153	5765
42	5210	157	5785
44	5220	159	5795
46	5230	161	5805
48	5240	165	5825

Note:

In section 15.31(m), regards to the operating frequency range over 10 MHz, the Lowest frequency, the middle frequency, and the highest frequency of channel were selected to perform the test, and the selected channel see below:

Carrier Frequency Channel

5GHz:

For 802.11a/n(HT20) /ac (VHT20)

Channel	Freq.(MHz)	Channel	Freq.(MHz)
36	5180	149	5745
40	5200	157	5785
48	5240	165	5825

For 802.11n(HT40) /ac (VHT40)

Channel	Freq.(MHz)	Channel	Freq.(MHz)
38	5190	151	5755
46	5230	159	5795

For 802.11ac (VHT80)

Channel	Freq.(MHz)	Channel	Freq.(MHz)
42	5210	155	5775

2. KDB 662911 D01 Multiple Transmitter Output v02r01

2) Directional Gain Calculations for In-Band Measurements

a) Basic methodology with NANT transmit antennas, each with the same directional gain  $G_{ANT}$  dBi, being driven by NANT transmitter outputs of equal power. Directional gain is to be computed as follows:

(i) If any transmit signals are correlated with each other,

$$\text{Directional gain} = G_{ANT} + 10 \log(NANT) \text{ dBi}$$

(ii) If all transmit signals are completely uncorrelated with each other,

$$\text{Directional gain} = G_{ANT}$$

ANT A=4.5 dBi

ANT B=4.5 dBi

$G_{ANT} + 10 \log(NANT)$  dBi

Directional gain=  $4.2+10\log 2=7.51$ dBi

Ant	Brand	Model Name	Ant Type	Connector	Gain (dBi)	NOTE
A		I232	External Antennal	N/A	Antenna A gain : 4.5dBi Antenna B gain : 4.5dBi MIMO technology Directional gain=7.51dBi	WLAN Ant



## 2.2 DESCRIPTION OF TEST MODES

To investigate the maximum EMI emission characteristics generates from EUT, the test system was pre-scanning tested base on the consideration of following EUT operation mode or test configuration mode which possible have effect on EMI emission level. Each of these EUT operation mode(s) or test configuration mode(s) mentioned above was evaluated respectively.

Worst Mode	Description	Data Rate
Mode 1	TX IEEE 802.11a HT20 CH36&CH40&CH48	6 Mbps
Mode 2	TX IEEE 802.11a HT20 CH149&CH157&CH165	6 Mbps
Mode 3	TX IEEE 802.11n HT20 CH36&CH40&CH48	MCS 0
Mode 4	TX IEEE 802.11ac VHT20 CH36&CH40&CH48	NSS1 MCS0
Mode 5	TX IEEE 802.11n HT20 CH149&CH157&CH165	MCS 0
Mode 6	TX IEEE 802.11ac VHT20 CH149&CH157&CH165	NSS1 MCS0
Mode 7	TX IEEE 802.11n HT40 CH38&CH46	MCS 0
Mode 8	TX IEEE 802.11ac VHT40 CH38&CH46	NSS1 MCS0
Mode 9	TX IEEE 802.11n HT40 CH151&CH159	MCS 0
Mode 10	TX IEEE 802.11ac VHT40 CH151&CH159	NSS1 MCS0
Mode 11	TX IEEE 802.11ac VHT80 CH42	NSS1 MCS0
Mode 12	TX IEEE 802.11ac VHT80 CH155	NSS1 MCS0

- Note: (1) The measurements are performed at the highest, middle, lowest available channels.  
(2) The measurements are performed at all Bit Rate of Transmitter, the worst data was reported  
(3) We have be tested for all available U.S. voltage and frequencies(For 120V,50/60Hz and 240V, 50/60Hz) for which the device is capable of operation.

### AC Conducted Emission

Test Case	
AC Conducted Emission	Mode 13: Keeping TX + WLAN Link

### 2.3 BLOCK DIGRAM SHOWING THE CONFIGURATION OF SYSTEM TESTED

Radiated Spurious Emission Test

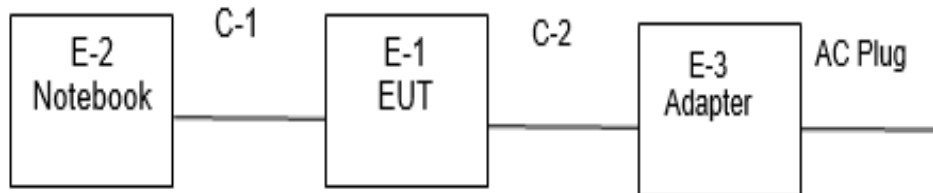

Conducted Emission Test

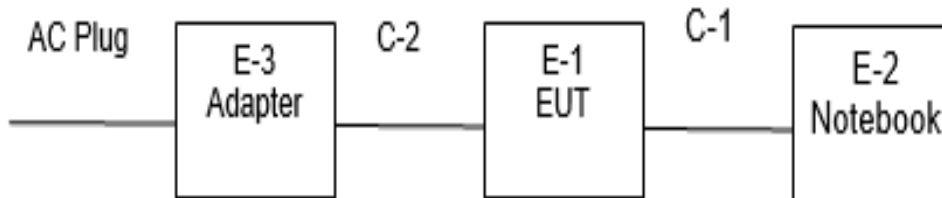



## 2.4 DESCRIPTION OF NECESSARY ACCESSORIES AND SUPPORT UNITS

The EUT has been tested as an independent unit together with other necessary accessories or support units. The following support units or accessories were used to form a representative test configuration during the tests.

### Necessary accessories

Item	Equipment	Mfr/Brand	Model/Type No.	Serial No.	Note
E-3	Adapter	GSP	GSCU1000S012V18Y	N/A	N/A
C-2	DC Cable	N/A	100cm	N/A	N/A

### Support units

Item	Equipment	Mfr/Brand	Model/Type No.	Serial No.	Note
E-2	Notebook	HP	500-320cx	N/A	N/A
C-1	USB Cable	N/A	110cm	N/A	N/A

Note:

- (1) The support equipment was authorized by Declaration of Confirmation.
- (2) For detachable type I/O cable should be specified the length in cm in 『Length』 column.
- (3) “YES” is means “shielded” “with core”; “NO” is means “unshielded” “without core”.



## 2.5 EQUIPMENTS LIST FOR ALL TEST ITEMS

### Radiation Test equipment

Kind of Equipment	Manufacturer	Type No.	Serial No.	Last calibration	Calibrated until
EMI Test Receiver	R&S	ESCI	101427	2018.10.13	2019.10.12
Signal Analyzer	Agilent	N9020A	MY51110105	2019.03.02	2020.03.01
Active loop Antenna	ZHINAN	ZN30900C	16035	2018.03.11	2021.03.10
Bilog Antenna	TESEQ	CBL6111D	34678	2017.11.02	2020.11.1
Horn Antenna	SCHWARZBECK	BBHA 9120D(1201)	9120D-1343	2018.10.19	2021.10.18
SHF-EHF Horn Antenna (18G-40GHz)	A-INFO	LB-180400-KF	J211020657	2018.03.11	2021.03.10
Pre-Amplifier(0.1 M-3GHz)	EM	EM330	060665	2018.10.13	2019.10.12
Pre-Amplifier (1G-18GHz)	SKET	LNPA-01018G-4 5	SK2018080901	2018.10.13	2019.10.12
Temperature & Humidity	HH660	Mieo	N/A	2018.10.11	2019.10.10
turn table	EM	SC100_1	60531	N/A	N/A
Antenna mast	EM	SC100	N/A	N/A	N/A
Test SW	BULUN	BL410-E/18.905			

### Conduction Test equipment

Kind of Equipment	Manufacturer	Type No.	Serial No.	Last calibration	Calibrated until
Test Receiver	R&S	ESCI	101427	2018.10.13	2019.10.12
LISN	R&S	ENV216	101242	2018.10.11	2019.10.10
LISN	EMCO	3810/2NM	23625	2018.10.11	2019.10.10
Temperature & Humidity	HH660	Mieo	N/A	2018.10.11	2019.10.10
Test SW	FARAD	EZ-EMC(Ver.STSLAB-03A1 CE)			

### RF Connected Test

Kind of Equipment	Manufacturer	Type No.	Serial No.	Last calibration	Calibrated until
USB RF power sensor	DARE	RPR3006W	15I00041SNO03	2018.10.13	2019.10.12
Signal Analyzer	Agilent	N9020A	MY49100060	2018.10.13	2019.10.12
Temperature & Humidity	HH660	Mieo	N/A	2018.10.11	2019.10.10
Test SW	FARAD	LZ-RF /LzRf-3A3			



### 3. EMC EMISSION TEST

#### 3.1 CONDUCTED EMISSION MEASUREMENT

##### 3.1.1 POWER LINE CONDUCTED EMISSION Limits (Frequency Range 150KHz-30MHz)

FREQUENCY (MHz)	Class B (dBuV)		Standard
	Quasi-peak	Average	
0.15 -0.5	66 - 56 *	56 - 46 *	CISPR
0.50 -5.0	56.00	46.00	CISPR
5.0 -30.0	60.00	50.00	CISPR

0.15 -0.5	66 - 56 *	56 - 46 *	FCC
0.50 -5.0	56.00	46.00	FCC
5.0 -30.0	60.00	50.00	FCC

Note:

- (1) The tighter limit applies at the band edges.
- (2) The limit of " \* " marked band means the limitation decreases linearly with the logarithm of the frequency in the range.

The following table is the setting of the receiver

Receiver Parameters	Setting
Attenuation	10 dB
Start Frequency	0.15 MHz
Stop Frequency	30 MHz
IF Bandwidth	9 kHz

### 3.1.2 TEST PROCEDURE

- a. The EUT was placed 0.8 meters from the horizontal ground plane with EUT being connected to the power mains through a line impedance stabilization network (LISN). All other support equipments powered from additional LISN(s). The LISN provide 50 Ohm/ 50uH of coupling impedance for the measuring instrument.
- b. Interconnecting cables that hang closer than 40 cm to the ground plane shall be folded back and forth in the center forming a bundle 30 to 40 cm long.
- c. I/O cables that are not connected to a peripheral shall be bundled in the center. The end of the cable may be terminated, if required, using the correct terminating impedance. The overall length shall not exceed 1 m.
- d. LISN at least 80 cm from nearest part of EUT chassis.
- e. For the actual test configuration, please refer to the related Item –EUT Test Photos.

### 3.1.3 DEVIATION FROM TEST STANDARD

No deviation

### 3.1.4 TEST SETUP

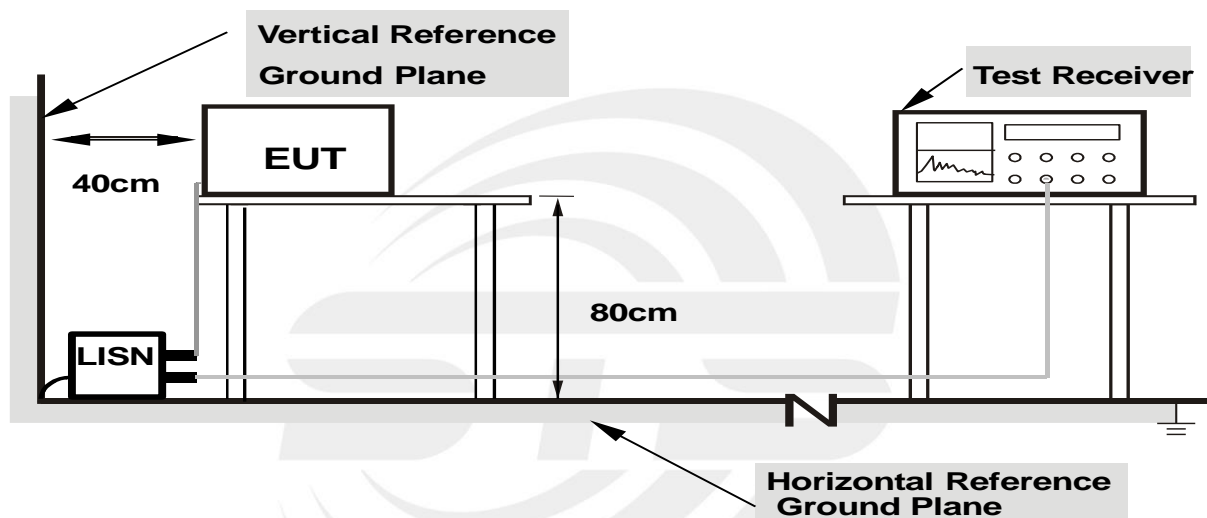

- Note: 1.Support units were connected to second LISN.**  
**2.Both of LISNs (AMN) are 80 cm from EUT and at least 80 cm from other units and other metal planes**

### 3.1.5 EUT OPERATING CONDITIONS

The EUT was configured for testing in a typical fashion (as a customer would normally use it). The EUT has been programmed to continuously transmit during test. This operating condition was tested and used to collect the included data.





### 3.1.6 TEST RESULTS

Temperature:	25.3(C)	Relative Humidity:	62%RH
Test Voltage:	AC 120V/60Hz	Phase:	L
Test Mode :	Mode 13		

No.	Frequency (MHz)	Reading (dBuV)	Correct Factor(dB)	Result (dBuV)	Limit (dBuV)	Margin (dB)	Remark
1	0.1580	18.61	20.21	38.82	65.57	-26.75	QP
2	0.1580	4.03	20.21	24.24	55.57	-31.33	AVG
3	0.5660	16.31	20.38	36.69	56.00	-19.31	QP
4	0.5660	5.56	20.38	25.94	46.00	-20.06	AVG
5	1.5660	11.38	20.15	31.53	56.00	-24.47	QP
6	1.5660	0.36	20.15	20.51	46.00	-25.49	AVG
7	2.4380	9.36	20.12	29.48	56.00	-26.52	QP
8	2.4380	0.39	20.12	20.51	46.00	-25.49	AVG
9	7.4980	14.21	19.89	34.10	60.00	-25.90	QP
10	7.4980	7.52	19.89	27.41	50.00	-22.59	AVG
11	26.5500	10.95	19.52	30.47	60.00	-29.53	QP
12	26.5500	3.27	19.52	22.79	50.00	-27.21	AVG

Remark:

1. All readings are Quasi-Peak and Average values.
2. Margin = Result (Result = Reading + Factor) – Limit

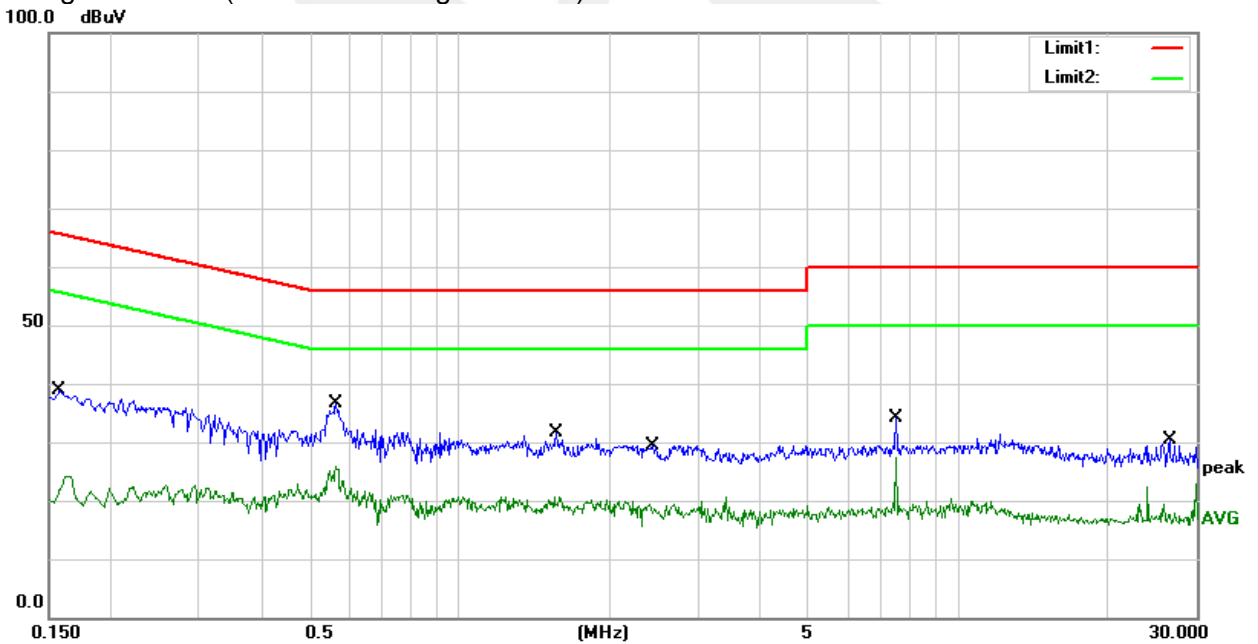



Temperature:	25.3(C)	Relative Humidity:	62%RH
Test Voltage	AC 120V/60Hz	Phase:	N
Test Mode	Mode 13		

No.	Frequency (MHz)	Reading (dBUV)	Correct Factor(dB)	Result (dBUV)	Limit (dBUV)	Margin (dB)	Remark
1	0.2020	19.68	20.34	40.02	63.53	-23.51	QP
2	0.2020	2.18	20.34	22.52	53.53	-31.01	AVG
3	0.5620	16.01	20.38	36.39	56.00	-19.61	QP
4	0.5620	4.71	20.38	25.09	46.00	-20.91	AVG
5	1.1860	10.97	20.16	31.13	56.00	-24.87	QP
6	1.1860	0.54	20.16	20.70	46.00	-25.30	AVG
7	4.5020	9.45	20.04	29.49	56.00	-26.51	QP
8	4.5020	0.02	20.04	20.06	46.00	-25.94	AVG
9	7.5540	13.04	19.90	32.94	60.00	-27.06	QP
10	7.5540	3.14	19.90	23.04	50.00	-26.96	AVG
11	12.6260	12.42	19.84	32.26	60.00	-27.74	QP
12	12.6260	4.57	19.84	24.41	50.00	-25.59	AVG

Remark:

1. All readings are Quasi-Peak and Average values.
2. Margin = Result (Result =Reading + Factor) –Limit

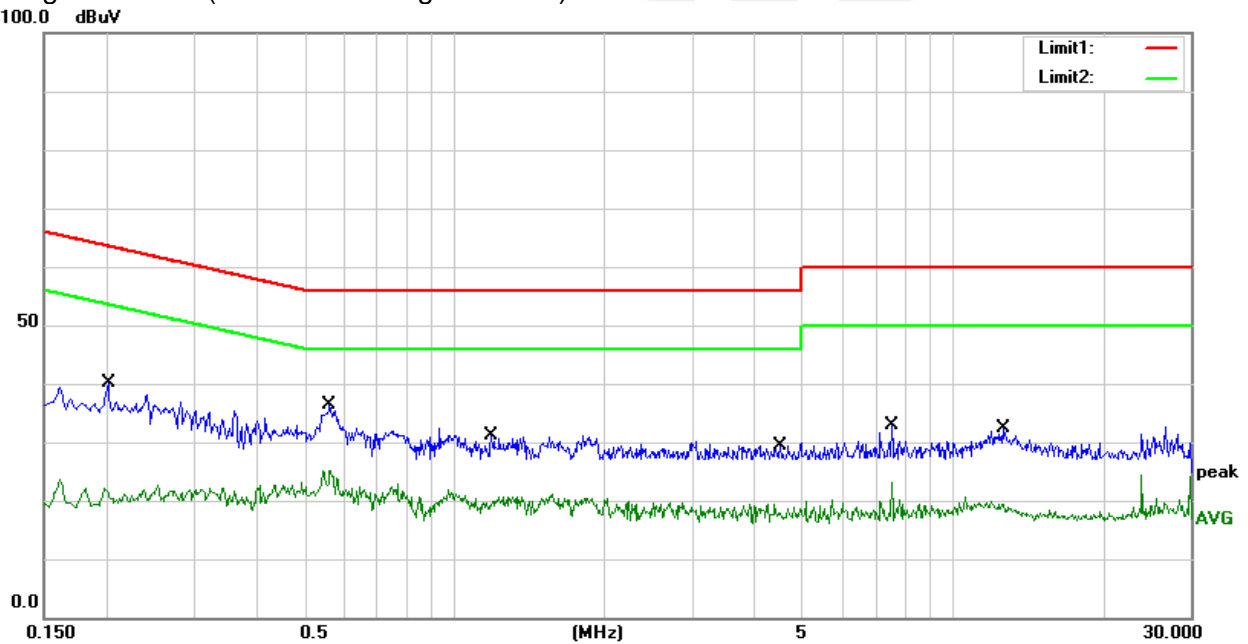

### 3.2 RADIATED EMISSION AND ( BANDEDGE) MEASUREMENT

#### 3.2.1 RADIATED EMISSION LIMITS (Frequency Range 9kHz-1000MHz)

In case the emission fall within the restricted band specified on 15.407(b)7& 15.205/209(a), then the (a); limit in the table below has to be followed.

Frequencies (MHz)	Field Strength (micorvolts/meter)	Measurement Distance (meters)
0.009~0.490	2400/F(KHz)	300
0.490~1.705	24000/F(KHz)	30
1.705~30.0	30	30
30~88	100	3
88~216	150	3
216~960	200	3
Above 960	500	3

#### LIMITS OF RADIATED EMISSION MEASUREMENT (Above 1000MHz)

FREQUENCY (MHz)	Class B (dBuV/m) (at 3M)	
	PEAK	AVERAGE
Above 1000	68.2	54

Notes:

- (1) The limit for radiated test was performed according to FCC PART 15E.
- (2) The tighter limit applies at the band edges.
- (3) Emission level (dBuV/m)=20log Emission level (uV/m).

Spectrum Parameter	Setting
Attenuation	Auto
Detector	Peak
Start Frequency	1000 MHz(Peak/AV)
Stop Frequency	10th carrier harmonic(Peak/AV)
RB / VB (emission in restricted band)	1 MHz / 1 MHz, AV=1 MHz /3 MHz

For Band edge

Spectrum Parameter	Setting
Detector	Peak
RB / VB (emission in restricted band)	1 MHz / 1 MHz, AV=1 MHz /3 MHz



Receiver Parameter	Setting
Attenuation	Auto
Start ~ Stop Frequency	9kHz~90kHz / RB 200Hz for PK & AV
Start ~ Stop Frequency	90kHz~110kHz / RB 200Hz for QP
Start ~ Stop Frequency	110kHz~490kHz / RB 200Hz for PK & AV
Start ~ Stop Frequency	490kHz~30MHz / RB 9kHz for QP
Start ~ Stop Frequency	30MHz~1000MHz / RB 120kHz for QP

### 3.2.2 TEST PROCEDURE

- The measuring distance of at 3 m shall be used for measurements at frequency 0.009MHz up to 1GHz. For frequencies above 1GHz, any suitable measuring distance may be used.
- The EUT was placed on the top of a rotating table 0.8 meters(above 1GHz is 1.5 m) above the ground at a 3 meter anechoic chamber. The table was rotated 360 degrees to determine the position of the highest radiation.
- The height of the equipment shall be 0.8 m(above 1GHz is 1.5 m); the height of the test antenna shall vary between 1 m to 4 m. Horizontal and vertical polarizations of the antenna are set to make the measurement
- The initial step in collecting conducted emission data is a spectrum analyzer peak detector mode pre-scanning the measurement frequency range. Significant peaks are then marked and then Quasi Peak detector mode re-measured.
- If the Peak Mode measured value compliance with and lower than Quasi Peak Mode Limit, the EUT shall be deemed to meet QP Limits and then no additional QP Mode measurement performed.
- For the actual test configuration, please refer to the related Item –EUT Test Photos.

Note:

Both horizontal and vertical antenna polarities were tested and performed test to three orthogonal axis. The worst case emissions were reported

### 3.2.2 DEVIATION FROM TEST STANDARD

No deviation

### 3.2.3 TEST SETUP

(A) Radiated Emission Test-Up Frequency Below 30MHz

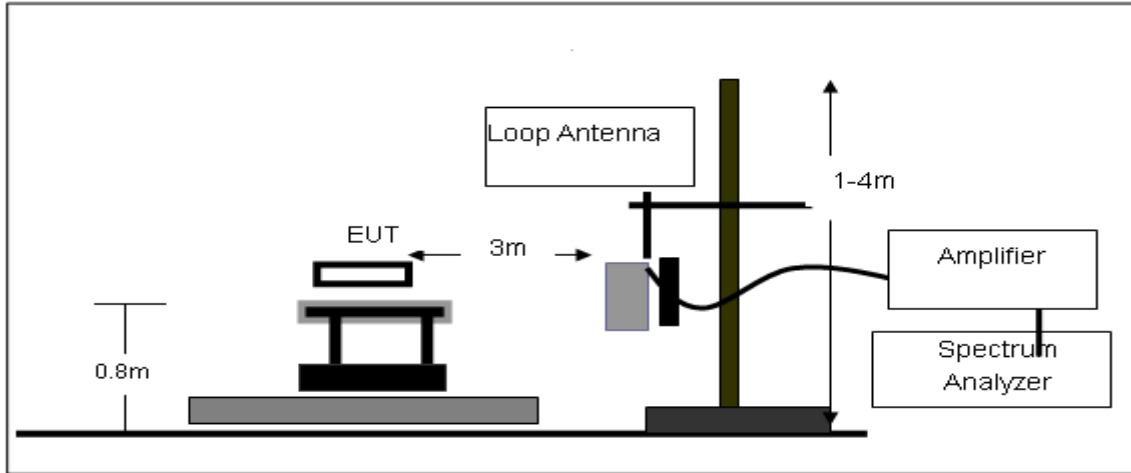

(B) Radiated Emission Test-Up Frequency 30MHz~1GHz

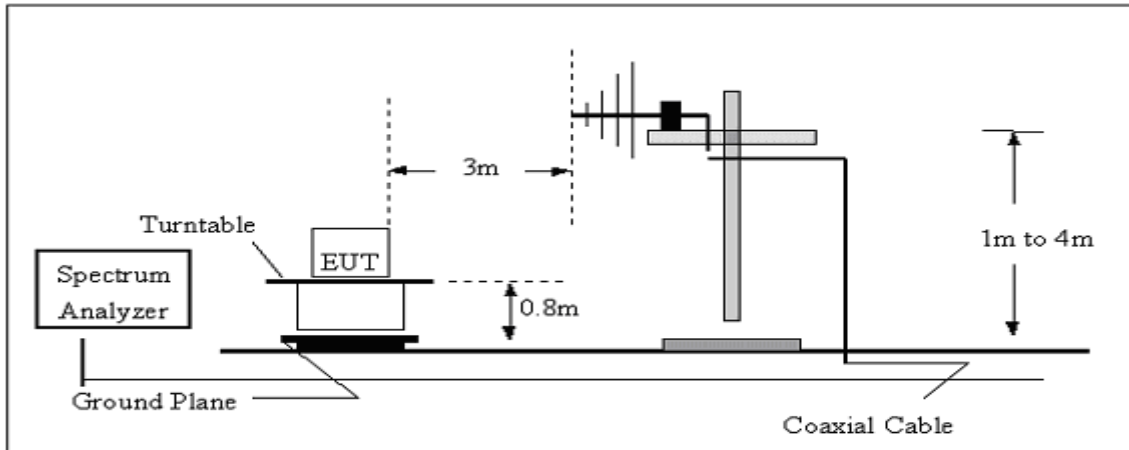

(C) Radiated Emission Test-Up Frequency Above 1GHz

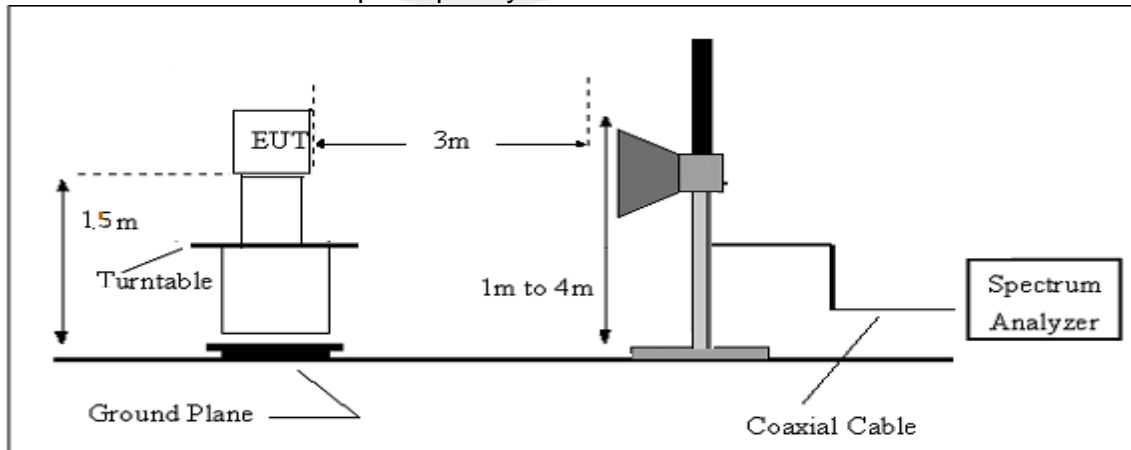



### 3.2.4 EUT OPERATING CONDITIONS

The EUT tested system was configured as the statements of 2.4 Unless otherwise a special operating condition is specified in the follows during the testing.

### 3.2.5 FIELD STRENGTH CALCULATION

The field strength is calculated by adding the Antenna Factor and Cable Factor and subtracting the Amplifier Gain and Duty Cycle Correction Factor (if any) from the measured reading. The basic equation with a sample calculation is as follows:

$$FS = RA + AF + CL - AG$$

Where

FS = Field Strength

CL = Cable Attenuation Factor (Cable Loss)

RA = Reading Amplitude

AG = Amplifier Gain

AF = Antenna Factor

For example

Frequency (MHz)	FS (dB $\mu$ V/m)	RA (dB $\mu$ V/m)	AF (dB)	CL (dB)	AG (dB)	Factor (dB)
300	40	58.1	12.2	1.6	31.9	-18.1

$$\text{Factor} = \text{AF} + \text{CL} - \text{AG}$$

**3.2.6 TEST RESULTS (Between 9KHz – 30 MHz)**

Temperature:	22.7(C)	Relative Humidity:	61%RH
Test Voltage :	AC 120V/60Hz	Polarization :	--
Test Mode :	TX Mode		

Freq.	Reading	Limit	Margin	State
(MHz)	(dBuV/m)	(dBuV/m)	(dB)	P/F
--	--	--	--	PASS
--	--	--	--	PASS

**Note:**

The amplitude of spurious emissions which are attenuated by more than 20dB below the permissible value has no need to be reported.

Distance extrapolation factor =  $40 \log(\text{specific distance}/\text{test distance})$ (dB);

Limit line = specific limits(dBuv) + distance extrapolation factor.



**3.2.7 TEST RESULTS (Between 30MHz – 1GHz)**

Temperature	22.7(C)	Relative Humidity:	61%RH
Test Voltage	AC 120V/60Hz	Polarization:	Horizontal
Test Mode	Mode 1~12(Mode 9 worst mode)		

No.	Frequency (MHz)	Reading (dBuV)	Correct Factor(dB/m)	Result (dBuV/m)	Limit (dBuV/m)	Margin (dB)	Remark
1	45.8551	44.07	-19.34	24.73	40.00	-15.27	QP
2	71.8320	54.93	-23.84	31.09	40.00	-8.91	QP
3	141.8262	52.67	-17.59	35.08	43.50	-8.42	QP
4	374.6225	48.98	-12.77	36.21	46.00	-9.79	QP
5	468.8761	47.59	-10.16	37.43	46.00	-8.57	QP
6	912.8620	33.69	-1.82	31.87	46.00	-14.13	QP

Remark:

1. Margin = Result (Result =Reading + Factor )–Limit

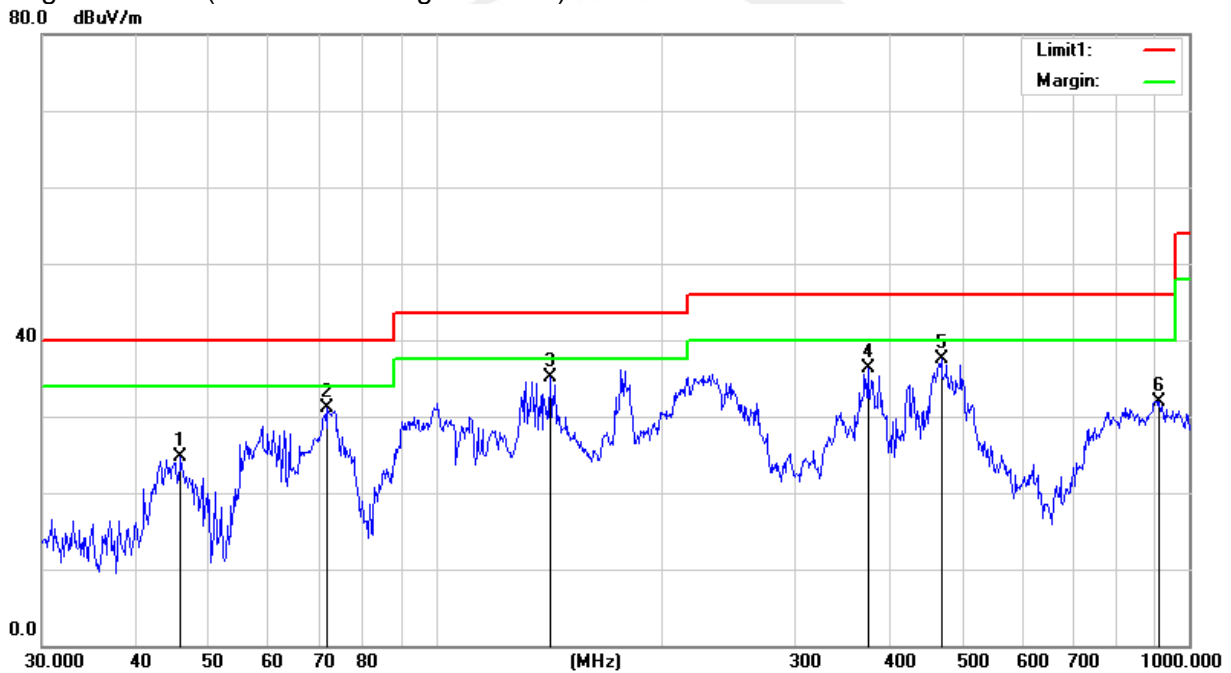





Temperature	22.7(C)	Relative Humidity:	61%RH
Test Voltage	AC 120V/60Hz	Polarization:	Vertical
Test Mode	Mode 1~12(Mode 9 worst mode)		

No.	Frequency (MHz)	Reading (dBuV)	Correct Factor(dB/m)	Result (dBuV/m)	Limit (dBuV/m)	Margin (dB)	Remark
1	43.9658	42.28	-18.37	23.91	40.00	-16.09	QP
2	60.9176	55.27	-24.32	30.95	40.00	-9.05	QP
3	178.1324	50.32	-19.42	30.90	43.50	-12.60	QP
4	368.1116	42.18	-12.94	29.24	46.00	-16.76	QP
5	574.6258	36.58	-6.67	29.91	46.00	-16.09	QP
6	968.9338	29.61	-0.13	29.48	54.00	-24.52	QP

Remark:

1. Margin = Result (Result =Reading + Factor )–Limit

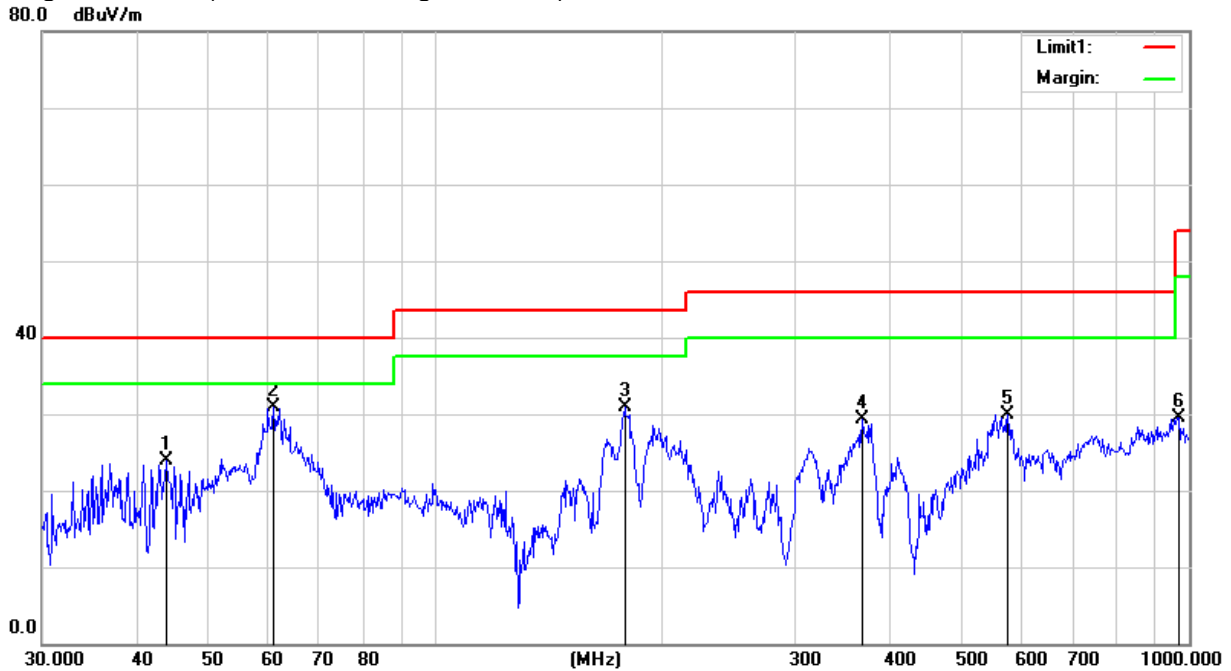



3.2.8 TEST RESULTS (Above 1000 MHz)

**Band I 5150-5250MHz**

Band I(5.15-5.25) GHz										
Frequency (MHz)	Reading	Amplifier	Loss	Antenna Factor	Orrected Factor	Emission Level	Limit (dBuV/m)	Margin	Detector	Comment
	(dBuV)	(dB)	(dB)	(dB/m)	(dB)	(dBuV/m)		(dB)		
Low Channel (802.11n40/ 5180 MHz)										
3252.95	45.18	44.70	6.70	28.20	-9.80	35.38	68.20	-32.82	Pk	Vertical
3252.95	41.35	44.70	6.70	28.20	-9.80	31.55	54.00	-22.45	AV	Vertical
3253.92	44.53	44.70	6.70	28.20	-9.80	34.73	68.20	-33.47	Pk	Horizontal
3253.92	41.97	44.70	6.70	28.20	-9.80	32.17	54.00	-21.83	AV	Horizontal
3982.06	39.39	44.20	7.90	29.70	-6.60	32.79	68.20	-35.41	Pk	Vertical
3982.06	36.22	44.20	7.90	29.70	-6.60	29.62	54.00	-24.38	AV	Vertical
3984.11	40.08	44.20	7.90	29.70	-6.60	33.48	68.20	-34.72	Pk	Horizontal
3984.11	36.48	44.20	7.90	29.70	-6.60	29.88	54.00	-24.12	AV	Horizontal
7226.64	37.35	43.50	11.40	35.50	3.40	40.75	68.20	-27.45	Pk	Vertical
7226.64	33.68	43.50	11.40	35.50	3.40	37.08	54.00	-16.92	AV	Vertical
7235.44	36.95	43.50	11.40	35.50	3.40	40.35	68.20	-27.85	Pk	Horizontal
7235.44	33.65	43.50	11.40	35.50	3.40	37.05	54.00	-16.95	AV	Horizontal
10360.10	39.54	44.50	13.80	38.80	8.10	47.64	68.20	-20.56	Pk	Vertical
10360.10	36.43	44.50	13.80	38.80	8.10	44.53	54.00	-9.47	AV	Vertical
10359.95	38.94	44.50	13.80	38.80	8.10	47.04	68.20	-21.16	Pk	Horizontal
10359.95	35.83	44.50	13.80	38.80	8.10	43.93	54.00	-10.07	AV	Horizontal
11035.26	34.04	43.60	14.30	39.50	10.20	44.24	68.20	-23.96	Pk	Vertical
11035.26	30.39	43.60	14.30	39.50	10.20	40.59	54.00	-13.41	AV	Vertical
11030.90	32.71	43.60	14.30	39.50	10.20	42.91	68.20	-25.29	Pk	Horizontal
11030.90	31.03	43.60	14.30	39.50	10.20	41.23	54.00	-12.77	AV	Horizontal
13292.11	32.19	42.60	15.90	38.90	12.20	44.39	68.20	-23.81	Pk	Vertical
13292.11	28.73	42.60	15.90	38.90	12.20	40.93	54.00	-13.07	AV	Vertical
13294.74	32.38	42.60	15.90	38.90	12.20	44.58	68.20	-23.62	Pk	Horizontal
13294.74	28.67	42.60	15.90	38.90	12.20	40.87	54.00	-13.13	AV	Horizontal



Mid Channel (802.11n40/ 5200 MHz)										
3248.61	44.33	44.70	6.70	28.20	-9.80	34.53	68.20	-33.67	Pk	Vertical
3248.61	41.10	44.70	6.70	28.20	-9.80	31.30	54.00	-22.70	AV	Vertical
3255.41	45.08	44.70	6.70	28.20	-9.80	35.28	68.20	-32.92	Pk	Horizontal
3255.41	41.72	44.70	6.70	28.20	-9.80	31.92	54.00	-22.08	AV	Horizontal
3994.01	40.05	44.20	7.90	29.70	-6.60	33.45	68.20	-34.75	Pk	Vertical
3994.01	36.40	44.20	7.90	29.70	-6.60	29.80	54.00	-24.20	AV	Vertical
3992.60	38.78	44.20	7.90	29.70	-6.60	32.18	68.20	-36.02	Pk	Horizontal
3992.60	36.67	44.20	7.90	29.70	-6.60	30.07	54.00	-23.93	AV	Horizontal
7223.54	36.72	43.50	11.40	35.50	3.40	40.12	68.20	-28.08	Pk	Vertical
7223.54	33.77	43.50	11.40	35.50	3.40	37.17	54.00	-16.83	AV	Vertical
7227.00	37.44	43.50	11.40	35.50	3.40	40.84	68.20	-27.36	Pk	Horizontal
7227.00	33.64	43.50	11.40	35.50	3.40	37.04	54.00	-16.96	AV	Horizontal
10400.08	38.93	44.50	13.80	38.80	8.10	47.03	68.20	-21.17	Pk	Vertical
10400.08	36.71	44.50	13.80	38.80	8.10	44.81	54.00	-9.19	AV	Vertical
10400.14	39.26	44.50	13.80	38.80	8.10	47.36	68.20	-20.84	Pk	Horizontal
10400.14	35.68	44.50	13.80	38.80	8.10	43.78	54.00	-10.22	AV	Horizontal
11029.21	32.79	43.60	14.30	39.50	10.20	42.99	68.20	-25.21	Pk	Vertical
11029.21	29.76	43.60	14.30	39.50	10.20	39.96	54.00	-14.04	AV	Vertical
11029.01	33.42	43.60	14.30	39.50	10.20	43.62	68.20	-24.58	Pk	Horizontal
11029.01	29.79	43.60	14.30	39.50	10.20	39.99	54.00	-14.01	AV	Horizontal
13285.30	32.87	42.60	15.90	38.90	12.20	45.07	68.20	-23.13	Pk	Vertical
13285.30	29.76	42.60	15.90	38.90	12.20	41.96	54.00	-12.04	AV	Vertical
13298.48	32.21	42.60	15.90	38.90	12.20	44.41	68.20	-23.79	Pk	Horizontal
13298.48	29.92	42.60	15.90	38.90	12.20	42.12	54.00	-11.88	AV	Horizontal



High Channel 802.11n40/ 5240 MHz)										
3260.16	44.32	44.70	6.70	28.20	-9.80	34.52	68.20	-33.68	Pk	Vertical
3260.16	41.47	44.70	6.70	28.20	-9.80	31.67	54.00	-22.33	AV	Vertical
3262.20	44.59	44.70	6.70	28.20	-9.80	34.79	68.20	-33.41	Pk	Horizontal
3262.20	41.73	44.70	6.70	28.20	-9.80	31.93	54.00	-22.07	AV	Horizontal
3994.43	39.60	44.20	7.90	29.70	-6.60	33.00	68.20	-35.20	Pk	Vertical
3994.43	35.71	44.20	7.90	29.70	-6.60	29.11	54.00	-24.89	AV	Vertical
3983.98	39.98	44.20	7.90	29.70	-6.60	33.38	68.20	-34.82	Pk	Horizontal
3983.98	36.79	44.20	7.90	29.70	-6.60	30.19	54.00	-23.81	AV	Horizontal
7236.24	37.55	43.50	11.40	35.50	3.40	40.95	68.20	-27.25	Pk	Vertical
7236.24	34.68	43.50	11.40	35.50	3.40	38.08	54.00	-15.92	AV	Vertical
7216.52	36.89	43.50	11.40	35.50	3.40	40.29	68.20	-27.91	Pk	Horizontal
7216.52	34.52	43.50	11.40	35.50	3.40	37.92	54.00	-16.08	AV	Horizontal
10480.35	40.15	44.50	13.80	38.80	8.10	48.25	68.20	-19.95	Pk	Vertical
10480.35	36.94	44.50	13.80	38.80	8.10	45.04	54.00	-8.96	AV	Vertical
10480.26	38.70	44.50	13.80	38.80	8.10	46.80	68.20	-21.40	Pk	Horizontal
10480.26	36.83	44.50	13.80	38.80	8.10	44.93	54.00	-9.07	AV	Horizontal
11034.68	33.78	43.60	14.30	39.50	10.20	43.98	68.20	-24.22	Pk	Vertical
11034.68	29.84	43.60	14.30	39.50	10.20	40.04	54.00	-13.96	AV	Vertical
11027.68	32.78	43.60	14.30	39.50	10.20	42.98	68.20	-25.22	Pk	Horizontal
11027.68	30.81	43.60	14.30	39.50	10.20	41.01	54.00	-12.99	AV	Horizontal
13296.30	32.10	42.60	15.90	38.90	12.20	44.30	68.20	-23.90	Pk	Vertical
13296.30	29.65	42.60	15.90	38.90	12.20	41.85	54.00	-12.15	AV	Vertical
13288.29	31.89	42.60	15.90	38.90	12.20	44.09	68.20	-24.11	Pk	Horizontal
13288.29	28.55	42.60	15.90	38.90	12.20	40.75	54.00	-13.25	AV	Horizontal

## Remark:

1. Factor = Antenna Factor + Cable Loss – Pre-amplifier.
2. Scan with 802.11a,802.11n (HT-20),802.11n (HT-40), 802.11ac (VHT-20),802.11ac (VHT-40), 802.11ac (VHT-80) the worst case is 802.11n (HT-40).
3. The frequency emission of peak points that did not show above the forms are at least 20dB below the limit, the frequency emission is mainly from the environment noise.
4. Pre-scan both the SISO and MIMO mode, only the worst-case results were reported.



**Band IV(5.725-5.850) GHz**

Frequency (MHz)	Reading (dBuV)	Amplifier (dB)	Loss (dB)	Antenna Factor (dB/m)	Orrected Factor (dB)	Emission Level (dBμV/m)	Limit (dBuV/m)	Margin (dB)	Detector	Comment
Low Channel (802.11n40/ 5745 MHz)										
3263.66	44.59	44.70	6.70	28.20	-9.80	34.79	68.20	-33.41	Pk	Vertical
3263.66	40.99	44.70	6.70	28.20	-9.80	31.19	54.00	-22.81	AV	Vertical
3248.09	44.00	44.70	6.70	28.20	-9.80	34.20	68.20	-34.00	Pk	Horizontal
3248.09	41.96	44.70	6.70	28.20	-9.80	32.16	54.00	-21.84	AV	Horizontal
3998.88	39.19	44.20	7.90	29.70	-6.60	32.59	68.20	-35.61	Pk	Vertical
3998.88	36.45	44.20	7.90	29.70	-6.60	29.85	54.00	-24.15	AV	Vertical
3997.87	39.13	44.20	7.90	29.70	-6.60	32.53	68.20	-35.67	Pk	Horizontal
3997.87	36.90	44.20	7.90	29.70	-6.60	30.30	54.00	-23.70	AV	Horizontal
7218.60	36.78	43.50	11.40	35.50	3.40	40.18	68.20	-28.02	Pk	Vertical
7218.60	33.53	43.50	11.40	35.50	3.40	36.93	54.00	-17.07	AV	Vertical
7235.13	36.86	43.50	11.40	35.50	3.40	40.26	68.20	-27.94	Pk	Horizontal
7235.13	33.50	43.50	11.40	35.50	3.40	36.90	54.00	-17.10	AV	Horizontal
10360.11	39.75	44.50	13.80	38.80	8.10	47.85	68.20	-20.35	Pk	Vertical
10360.11	37.04	44.50	13.80	38.80	8.10	45.14	54.00	-8.86	AV	Vertical
10360.06	39.27	44.50	13.80	38.80	8.10	47.37	68.20	-20.83	Pk	Horizontal
10360.06	36.20	44.50	13.80	38.80	8.10	44.30	54.00	-9.70	AV	Horizontal
11026.46	33.36	43.60	14.30	39.50	10.20	43.56	68.20	-24.64	Pk	Vertical
11026.46	30.98	43.60	14.30	39.50	10.20	41.18	54.00	-12.82	AV	Vertical
11025.62	33.96	43.60	14.30	39.50	10.20	44.16	68.20	-24.04	Pk	Horizontal
11025.62	30.39	43.60	14.30	39.50	10.20	40.59	54.00	-13.41	AV	Horizontal
13286.57	32.47	42.60	15.90	38.90	12.20	44.67	68.20	-23.53	Pk	Vertical
13286.57	29.70	42.60	15.90	38.90	12.20	41.90	54.00	-12.10	AV	Vertical
13294.76	32.54	42.60	15.90	38.90	12.20	44.74	68.20	-23.46	Pk	Horizontal
13294.76	29.91	42.60	15.90	38.90	12.20	42.11	54.00	-11.89	AV	Horizontal



Mid Channel (802.11n40/ 5785 MHz)										
3259.50	45.24	44.70	6.70	28.20	-9.80	35.44	68.20	-32.76	Pk	Vertical
3259.50	41.83	44.70	6.70	28.20	-9.80	32.03	54.00	-21.97	AV	Vertical
3252.25	43.98	44.70	6.70	28.20	-9.80	34.18	68.20	-34.02	Pk	Horizontal
3252.25	41.53	44.70	6.70	28.20	-9.80	31.73	54.00	-22.27	AV	Horizontal
3982.54	39.93	44.20	7.90	29.70	-6.60	33.33	68.20	-34.87	Pk	Vertical
3982.54	36.57	44.20	7.90	29.70	-6.60	29.97	54.00	-24.03	AV	Vertical
3985.59	39.29	44.20	7.90	29.70	-6.60	32.69	68.20	-35.51	Pk	Horizontal
3985.59	36.60	44.20	7.90	29.70	-6.60	30.00	54.00	-24.00	AV	Horizontal
7218.21	37.51	43.50	11.40	35.50	3.40	40.91	68.20	-27.29	Pk	Vertical
7218.21	33.86	43.50	11.40	35.50	3.40	37.26	54.00	-16.74	AV	Vertical
7234.07	37.83	43.50	11.40	35.50	3.40	41.23	68.20	-26.97	Pk	Horizontal
7234.07	34.16	43.50	11.40	35.50	3.40	37.56	54.00	-16.44	AV	Horizontal
10400.35	39.85	44.50	13.80	38.80	8.10	47.95	68.20	-20.25	Pk	Vertical
10400.35	37.18	44.50	13.80	38.80	8.10	45.28	54.00	-8.72	AV	Vertical
10400.42	39.96	44.50	13.80	38.80	8.10	48.06	68.20	-20.14	Pk	Horizontal
10400.42	36.80	44.50	13.80	38.80	8.10	44.90	54.00	-9.10	AV	Horizontal
11022.17	33.40	43.60	14.30	39.50	10.20	43.60	68.20	-24.60	Pk	Vertical
11022.17	31.01	43.60	14.30	39.50	10.20	41.21	54.00	-12.79	AV	Vertical
11032.85	33.77	43.60	14.30	39.50	10.20	43.97	68.20	-24.23	Pk	Horizontal
11032.85	31.06	43.60	14.30	39.50	10.20	41.26	54.00	-12.74	AV	Horizontal
13280.33	32.50	42.60	15.90	38.90	12.20	44.70	68.20	-23.50	Pk	Vertical
13280.33	29.15	42.60	15.90	38.90	12.20	41.35	54.00	-12.65	AV	Vertical
13294.88	32.08	42.60	15.90	38.90	12.20	44.28	68.20	-23.92	Pk	Horizontal
13294.88	29.46	42.60	15.90	38.90	12.20	41.66	54.00	-12.34	AV	Horizontal



High Channel (802.11n40/ 5825 MHz)										
3262.50	43.91	44.70	6.70	28.20	-9.80	34.11	68.20	-34.09	Pk	Vertical
3262.50	42.21	44.70	6.70	28.20	-9.80	32.41	54.00	-21.59	AV	Vertical
3255.70	43.76	44.70	6.70	28.20	-9.80	33.96	68.20	-34.24	Pk	Horizontal
3255.70	40.88	44.70	6.70	28.20	-9.80	31.08	54.00	-22.92	AV	Horizontal
3994.55	38.70	44.20	7.90	29.70	-6.60	32.10	68.20	-36.10	Pk	Vertical
3994.55	35.77	44.20	7.90	29.70	-6.60	29.17	54.00	-24.83	AV	Vertical
3990.50	39.35	44.20	7.90	29.70	-6.60	32.75	68.20	-35.45	Pk	Horizontal
3990.50	36.35	44.20	7.90	29.70	-6.60	29.75	54.00	-24.25	AV	Horizontal
7225.19	36.82	43.50	11.40	35.50	3.40	40.22	68.20	-27.98	Pk	Vertical
7225.19	33.79	43.50	11.40	35.50	3.40	37.19	54.00	-16.81	AV	Vertical
7226.83	37.42	43.50	11.40	35.50	3.40	40.82	68.20	-27.38	Pk	Horizontal
7226.83	34.91	43.50	11.40	35.50	3.40	38.31	54.00	-15.69	AV	Horizontal
10480.23	39.89	44.50	13.80	38.80	8.10	47.99	68.20	-20.21	Pk	Vertical
10480.23	35.81	44.50	13.80	38.80	8.10	43.91	54.00	-10.09	AV	Vertical
10480.34	39.80	44.50	13.80	38.80	8.10	47.90	68.20	-20.30	Pk	Horizontal
10480.34	36.08	44.50	13.80	38.80	8.10	44.18	54.00	-9.82	AV	Horizontal
11033.63	32.86	43.60	14.30	39.50	10.20	43.06	68.20	-25.14	Pk	Vertical
11033.63	30.48	43.60	14.30	39.50	10.20	40.68	54.00	-13.32	AV	Vertical
11029.07	33.07	43.60	14.30	39.50	10.20	43.27	68.20	-24.93	Pk	Horizontal
11029.07	30.61	43.60	14.30	39.50	10.20	40.81	54.00	-13.19	AV	Horizontal
13297.34	32.44	42.60	15.90	38.90	12.20	44.64	68.20	-23.56	Pk	Vertical
13297.34	29.69	42.60	15.90	38.90	12.20	41.89	54.00	-12.11	AV	Vertical
13291.36	32.67	42.60	15.90	38.90	12.20	44.87	68.20	-23.33	Pk	Horizontal
13291.36	29.52	42.60	15.90	38.90	12.20	41.72	54.00	-12.28	AV	Horizontal

**Remark:**

1. Factor = Antenna Factor + Cable Loss – Pre-amplifier.
2. Scan with 802.11a, 802.11n (HT-20), 802.11n (HT-40), 802.11ac (VHT-20), 802.11ac (VHT-40), 802.11ac (VHT-80) the worst case is 802.11n (HT-40).
3. The frequency emission of peak points that did not show above the forms are at least 20dB below the limit, the frequency emission is mainly from the environment noise.
4. Pre-scan both the SISO and MIMO mode, only the worst-case results were reported.



3.2.9 Band Edge  
Band I 5150-5250MHz

802.11n(HT20) Low  
Horizontal

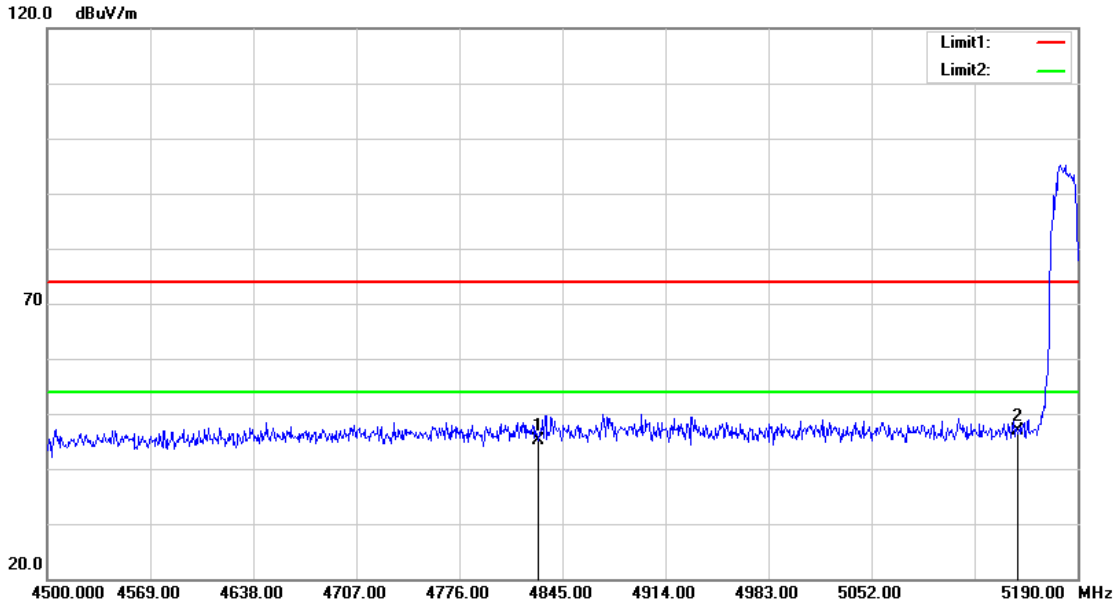

No.	Frequency (MHz)	Reading (dBuV)	Correct Factor(dB/m)	Result (dBuV/m)	Limit (dBuV/m)	Margin (dB)	Remark
1	4829.130	48.36	-3.20	45.16	74.00	-28.84	peak
2	5150.000	49.07	-2.22	46.85	74.00	-27.15	peak

Vertical

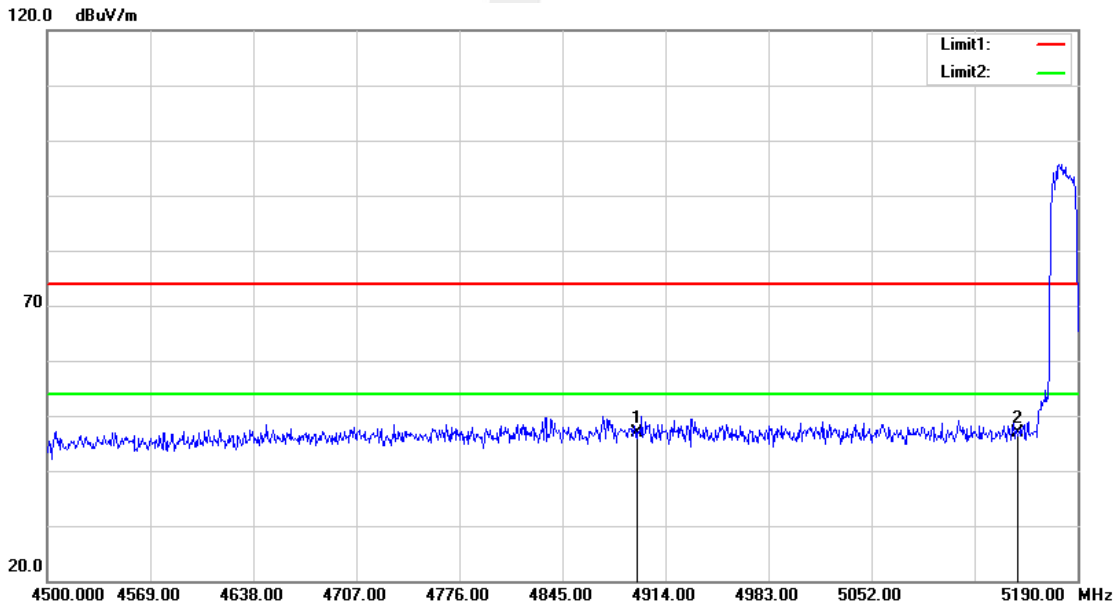

No.	Frequency (MHz)	Reading (dBuV)	Correct Factor(dB/m)	Result (dBuV/m)	Limit (dBuV/m)	Margin (dB)	Remark
1	4895.370	49.83	-3.04	46.79	74.00	-27.21	peak
2	5150.000	49.07	-2.22	46.85	74.00	-27.15	peak





**802.11n(HT20) High Horizontal**

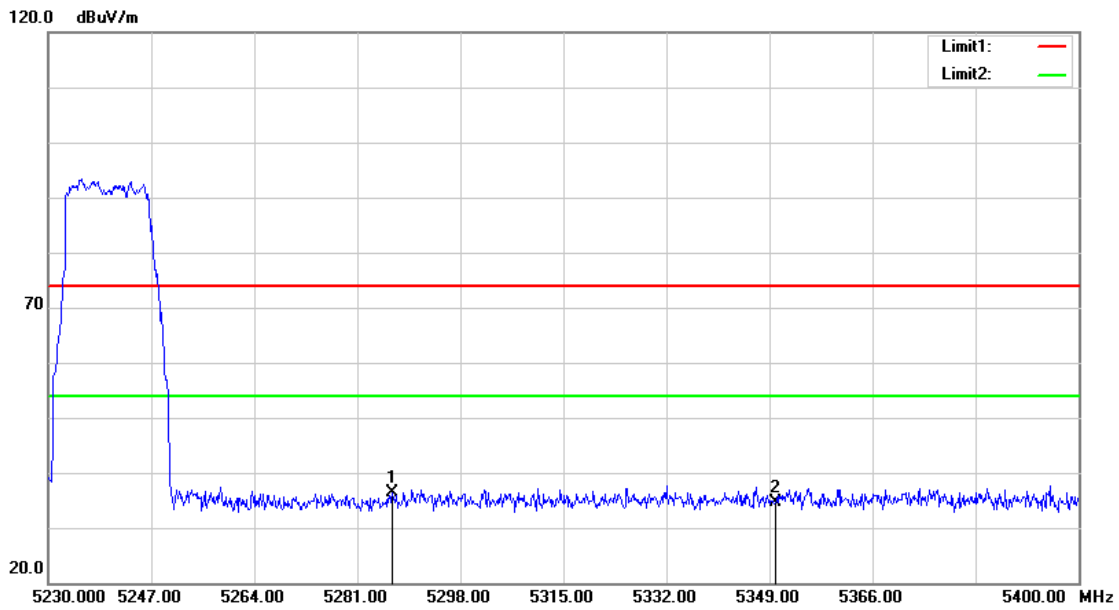

No.	Frequency (MHz)	Reading (dBuV)	Correct Factor(dB/m)	Result (dBuV/m)	Limit (dBuV/m)	Margin (dB)	Remark
1	5286.780	38.20	-1.92	36.28	74.00	-37.72	peak
2	5350.000	36.45	-1.84	34.61	74.00	-39.39	peak

**Vertical**

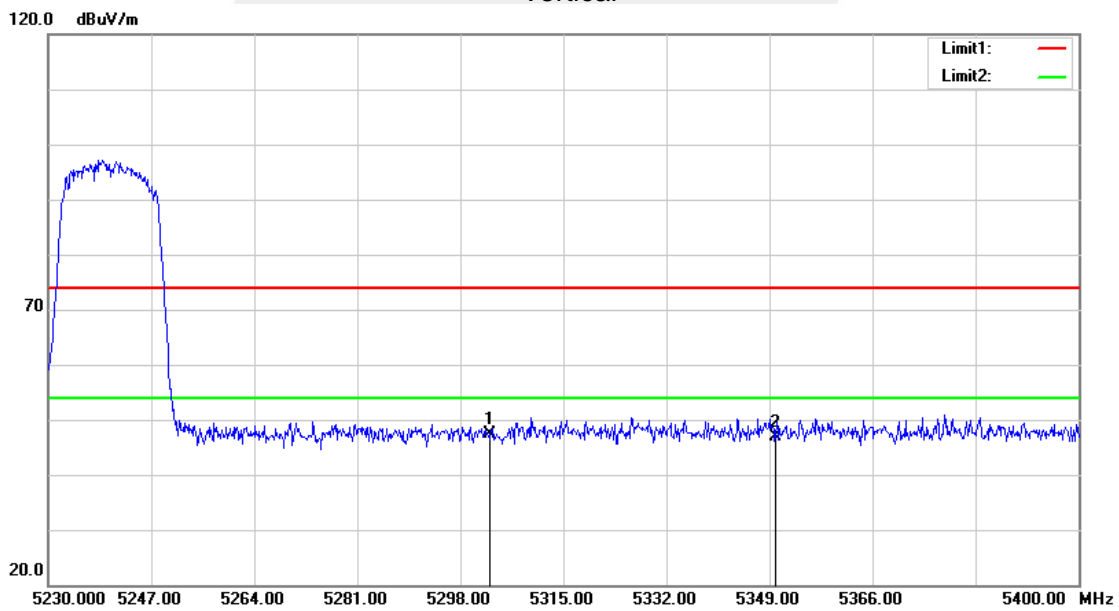

No.	Frequency (MHz)	Reading (dBuV)	Correct Factor(dB/m)	Result (dBuV/m)	Limit (dBuV/m)	Margin (dB)	Remark
1	5302.930	49.28	-1.91	47.37	74.00	-26.63	peak
2	5350.000	48.80	-1.84	46.96	74.00	-27.04	peak

Note: 1.802.11a,802.11n (HT-20),802.11n (HT-40), 802.11ac (VHT-20),802.11ac (VHT-40), 802.11ac (VHT-80) all has been tested, the worst case is 802.11a,only shown the worst case.

2. Pre-scan both the SISO and MIMO mode, only the worst-case results were reported.

**Band IV(5.725-5.85 GHz)**

Note: The main frequency is too far away from the restricted band and does not require testing.

## 4. CONDUCTED SPURIOUS EMISSIONS AND BANDEGE

### 4.1 LIMIT

Undesirable emission limits. Except as shown in paragraph (b)(7) of this section, the maximum emissions outside of the frequency bands of operation shall be attenuated in accordance with the following limits:

- (1) For transmitters operating in the 5.15-5.25 GHz band: All emissions outside of the 5.15-5.35 GHz band shall not exceed an e.i.r.p. of -27 dBm/MHz.
- (2) For transmitters operating in the 5.25-5.35 GHz band: All emissions outside of the 5.15-5.35 GHz band shall not exceed an e.i.r.p. of -27 dBm/MHz.
- (3) For transmitters operating in the 5.47-5.725 GHz band: All emissions outside of the 5.47-5.725 GHz band shall not exceed an e.i.r.p. of -27 dBm/MHz.
- (4) For transmitters operating in the 5.725-5.85 GHz band:
  - (i) All emissions shall be limited to a level of -27 dBm/MHz at 75 MHz or more above or below the band edge increasing linearly to 10 dBm/MHz at 25 MHz above or below the band edge, and from 25 MHz above or below the band edge increasing linearly to a level of 15.6 dBm/MHz at 5 MHz above or below the band edge, and from 5 MHz above or below the band edge increasing linearly to a level of 27 dBm/MHz at the band edge.

### 4.2 TEST PROCEDURE

Spectrum Parameter	Setting
Detector	Peak
Start/Stop Frequency	30 MHz to 10th carrier harmonic
RB / VB (emission in restricted band)	1000 KHz/3000 KHz
Trace-Mode:	Max hold

For Band edge

Spectrum Parameter	Setting
Detector	Peak
Start/Stop Frequency	Lower Band Edge: 5700 to 5725 MHz Upper Band Edge: 5850 to 5870 MHz
RB / VB (emission in restricted band)	1000 KHz/3000 KHz
Trace-Mode:	Max hold

### 4.3 DEVIATION FROM STANDARD

No deviation.

#### 4.4 TEST SETUP

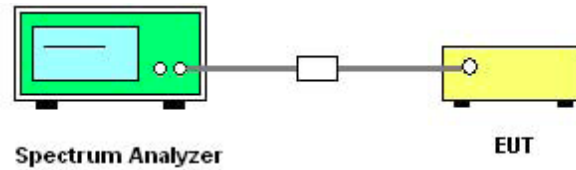

The EUT which is powered by the Battery, is coupled to the Spectrum Analyzer; the RF load attached to the EUT antenna terminal is 50Ohm; the path loss as the factor is calibrated to correct the reading.

Make the measurement with the spectrum analyzer's resolution bandwidth (RBW) = 1000 kHz. In order to make an accurate measurement, set the span greater than RBW.

#### 4.5 EUT OPERATION CONDITIONS

The EUT tested system was configured as the statements of 2.3 Unless otherwise a special operating condition is specified in the follows during the testing.

#### 4.6 TEST RESULTS

Data See Attachment A





## 5. POWER SPECTRAL DENSITY TEST

### 5.1 LIMIT

1. For mobile and portable client devices in the 5.15-5.25 GHz band, , the maximum power spectral density shall not exceed 11 dBm in any 1 megahertz band. If transmitting antennas of directional gain greater than 6 dBi are used, both the maximum conducted output power and the maximum power spectral density shall be reduced by the amount in dB that the directional gain of the antenna exceeds 6 dBi.
2. For the 5.25-5.35 GHz and 5.47-5.725 GHz bands, the maximum power spectral density shall not exceed 11 dBm in any 1 megahertz band. If transmitting antennas of directional gain greater than 6 dBi are used, both the maximum conducted output power and the maximum power spectral density shall be reduced by the amount in dB that the directional gain of the antenna exceeds 6 dBi.
3. For the band 5.725-5.850 GHz, the peak power spectral density shall not exceed 30 dBm in any 500KHz band. If transmitting antenna directional gain is greater than 6 dBi, both the maximum conducted output power and the peak power spectral density shall be reduced by the amount in dB that the directional gain of the antenna exceeds 6 dBi.

### 5.2 TEST PROCEDURE

1. The setting follows Method SA-1 of FCC KDB D02 General UNII Test Procedures New Rules v01r03.

For devices operating in the band, the rules specify a measurement bandwidth of 500 kHz.

Many spectrum analyzers do not have 500 kHz RBW, thus a narrower RBW may need to be used.

The rules permit the use of a RBWs less than 1 MHz, or 500 kHz, "provided that the measured power is integrated over the full reference bandwidth" to show the total power over the specified measurement bandwidth (*i.e.*, 1 MHz, or 500 kHz). If measurements are performed using a reduced resolution bandwidth (< 1 MHz, or < 500 kHz) and integrated over 1 MHz, or 500 KHz bandwidth, the following adjustments to the procedures apply:

- a) Set  $RBW \geq 1/T$ , where  $T$  is defined in section II.B.I.a).
- b) Set  $VBW \geq 3 RBW$ .
- c) If measurement bandwidth of Maximum PSD is specified in 500 kHz, add  $10 \log (500\text{kHz}/RBW)$  to the measured result, whereas  $RBW (< 500 \text{ kHz})$  is the reduced resolution bandwidth of the spectrum analyzer set during measurement.
- d) If measurement bandwidth of Maximum PSD is specified in 1 MHz, add  $10 \log (1\text{MHz}/RBW)$  to the measured result, whereas  $RBW (< 1 \text{ MHz})$  is the reduced resolution bandwidth of spectrum analyzer set during measurement.
- e) Care must be taken to ensure that the measurements are performed during a period of continuous transmission or are corrected upward for duty cycle.

Note: As a practical matter, it is recommended to use reduced RBW of 100 kHz for the sections 5.c) and 5.d) above, since  $RBW=100 \text{ KHZ}$  is available on nearly all spectrum analyzers.

### 5.3 DEVIATION FROM STANDARD

No deviation.

### 5.4 TEST SETUP



### 5.5 EUT OPERATION CONDITIONS

The EUT tested system was configured as the statements of 2.1 Unless otherwise a special operating condition is specified in the follows during the testing.

### 5.6 TEST RESULTS

Data see Attachment B



## 6. BANDWIDTH MEASUREMENT

### 6.1 EMISSION BANDWIDTH (EBW) 26 BANDWID PROCEDURES / LIMIT

See list of measuring instruments of this test report.

#### 6.1.1 TEST PROCEDURE

1. The testing follows FCC KDB 789033 D02 General UNII Test Procedures New Rules v02r01
2. Set RBW = approximately 1% of the emission bandwidth.
3. Set the VBW  $\geq$  RBW.
4. Detector = Peak.
5. Trace mode = max hold.
6. Measure the maximum width of the emission that is 26 dB down from the peak of the emission. Compare this with the RBW setting of the analyzer. Readjust RBW and repeat measurement as needed until the RBW/EBW ratio is approximately 1%.

#### 6.1.2 DEVIATION FROM STANDARD

No deviation.

#### 6.1.3 TEST SETUP

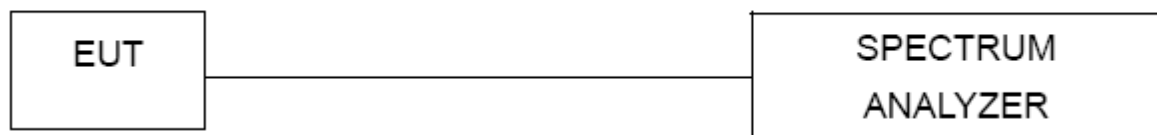

#### 6.1.4 EUT OPERATION CONDITIONS

The EUT tested system was configured as the statements of 2.4 Unless otherwise a special operating condition is specified in the follows during the testing.

#### 6.1.5 TEST RESULTS

Data see Attachment C

## 6.2 OCCUPIED BANDWIDTH ( 99%) TEST APPLIED PROCEDURES / LIMIT

The following procedure shall be used for measuring (99 %) power bandwidth:

### 6.2.1 TEST PROCEDURE

1. The testing follows FCC KDB 789033 D02 General UNII Test Procedures v02r01.

The following procedure shall be used for measuring (99 %) power bandwidth:

1. Set center frequency to the nominal EUT channel center frequency.
2. Set span = 1.5 times to 5.0 times the OBW.
3. Set RBW = 1 % to 5 % of the OBW
4. Set VBW  $\geq 3 \cdot$  RBW
5. Video averaging is not permitted. Where practical, a sample detection and single sweep mode shall be used. Otherwise, peak detection and max hold mode (until the trace stabilizes) shall be used.
6. Use the 99 % power bandwidth function of the instrument (if available).
7. If the instrument does not have a 99 % power bandwidth function, the trace data points are recovered and directly summed in power units. The recovered amplitude data points, beginning at the lowest frequency, are placed in a running sum until 0.5 % of the total is reached; that frequency is recorded as the lower frequency. The process is repeated until 99.5 % of the total is reached; that frequency is recorded as the upper frequency. The 99% occupied bandwidth is the difference between these two frequencies.

### 6.2.2 DEVIATION FROM STANDARD

No deviation.

### 6.2.3 TEST SETUP

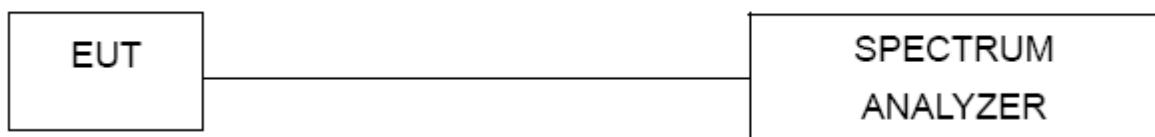

### 6.2.4 EUT OPERATION CONDITIONS

The EUT tested system was configured as the statements of 2.4 Unless otherwise a special operating condition is specified in the follows during the testing.

### 6.2.5 TEST RESULTS

Data See Attachment C

### 6.3 MINIMUM EMISSION BANDWIDTH(6 DB) PROCEDURES / LIMIT

Section 15.407(e) specifies the minimum 6 dB emission bandwidth of at least 500 KHz for the band 5.725-5.85 GHz. The following procedure shall be used for measuring this bandwidth:

#### 6.3.1 TEST PROCEDURE

1. The testing follows FCC KDB 789033 D02 General UNII Test Procedures v02r01.
  - a) Set RBW = 100 kHz.
  - b) Set the video bandwidth (VBW)  $\geq 3 \times$  RBW.
  - c) Detector = Peak.
  - d) Trace mode = max hold.
  - e) Sweep = auto couple.
  - f) Allow the trace to stabilize.
  - g) Measure the maximum width of the emission that is constrained by the frequencies associated with the two outermost amplitude points (upper and lower frequencies) that are attenuated by 6 dB relative to the maximum level measured in the fundamental emission.

#### 6.3.2 DEVIATION FROM STANDARD

No deviation.

#### 6.3.3 TEST SETUP



#### 6.3.4 EUT OPERATION CONDITIONS

The EUT tested system was configured as the statements of 2.4 Unless otherwise a special operating condition is specified in the follows during the testing.

#### 6.3.5 TEST RESULTS

Data see Attachment D



## 7. MAXIMUM CONDUCTED OUTPUT POWER

### 7.1 LIMIT

For mobile and portable client devices in the 5.15-5.25 GHz band, the maximum conducted output power over the frequency band of operation shall not exceed 250 mW provided the maximum antenna gain does not exceed 6 dBi. If transmitting antennas of directional gain greater than 6 dBi are used, both the maximum conducted output power and the maximum power spectral density shall be reduced by the amount in dB that the directional gain of the antenna exceeds 6 dBi.

For the 5.25-5.35 GHz and 5.47-5.725 GHz bands, the maximum conducted output power over the frequency bands of operation shall not exceed the lesser of 250 mW or 11 dBm + 10 log B, where B is the 26 dB emission bandwidth in megahertz, If transmitting antennas of directional gain greater than 6 dBi are used.

For the band 5.725-5.85 GHz, the maximum conducted output power over the frequency band of operation shall not exceed 1 W. If transmitting antennas of directional gain greater than 6 dBi are used.

FCC Part15 (15.407) , Subpart E				
Section	Test Item	Limit	Frequency Range (MHz)	Result
15.407(a) (1) (iv)	Peak Output Power	0.25 watt	5150-5250	PASS
		The lesser of 250 mW or 11 dBm + 10 log (26 dB emission bandwidth)	5250-5350 5470-5725	
15.407(a) (3)		1 watt	5725-5825	

### 7.2 TEST PROCEDURE

The EUT was directly connected to the Power Sensor&PC

### 7.3 DEVIATION FROM STANDARD

No deviation.

### 7.4 TEST SETUP

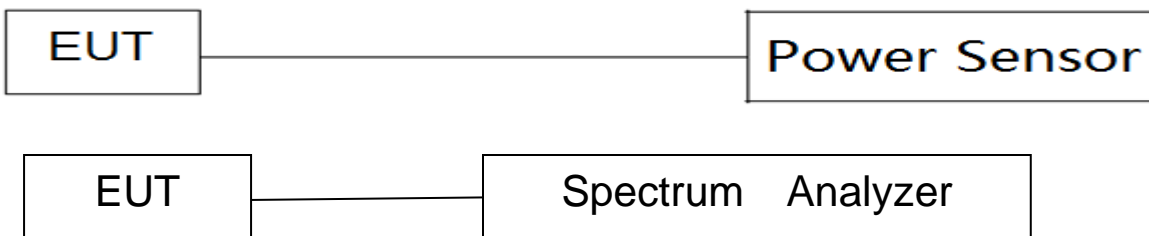

### 7.5 EUT OPERATION CONDITIONS

The EUT tested system was configured as the statements of 5 Unless otherwise a special operating condition is specified in the follows during the testing.

**7.6 TEST RESULTS****Band I (5.15-5.25GHz)**

Band I (5.15-5.25GHz)								
Test Channel	Frequency (MHz)	PK Power A(dBm)	PK Power B(dBm)	PK Power Total(dBm)	AV Power (dBm)	AV Power B(dBm)	AV Power Total(dBm)	LIMIT (dBm)
802.11a								
36	5180	12.81	11.80	--	6.31	5.46	--	23.98
40	5200	12.49	11.58	--	6.13	5.32	--	23.98
48	5240	12.42	11.31	--	6.11	5.09	--	23.98
802.11n(HT20)								
36	5180	13.01	12.24	15.65	6.14	5.23	8.72	22.47
40	5200	12.97	11.94	15.50	5.96	5.09	8.56	22.47
48	5240	12.83	11.87	15.39	5.87	4.85	8.40	22.47
802.11n(HT40)								
38	5190	13.55	12.65	16.13	6.20	5.38	8.82	22.47
46	5230	12.91	12.13	15.55	6.16	5.14	8.69	22.47
802.11ac(HT20)								
36	5180	13.24	12.20	15.76	6.12	5.24	8.71	22.47
40	5200	13.02	11.99	15.55	5.89	5.09	8.52	22.47
48	5240	12.75	11.73	15.28	5.89	4.83	8.40	22.47
802.11ac(HT40)								
38	5190	13.23	12.89	16.07	6.21	5.37	8.82	22.47
46	5230	13.41	11.99	15.77	6.18	5.11	8.69	22.47
802.11ac(HT80)								
42	5210	11.70	10.60	14.20	4.74	3.65	7.24	22.47

**Note:**

1. For mobile and portable client devices in the 5.15-5.25 GHz band, the maximum conducted output power over the frequency band of operation shall not exceed the lesser of 0.25 W. In addition, MIMO technology Directional gain=7.51dBi, 802.11n(HT20), 802.11n(HT40), 802.11ac (VHT20), 802.11ac (VHT40), 802.11ac (VHT80) limit will reduce 1.51dBi, the limit is 22.47dBm.



802.11ac HT80(5210MHz)

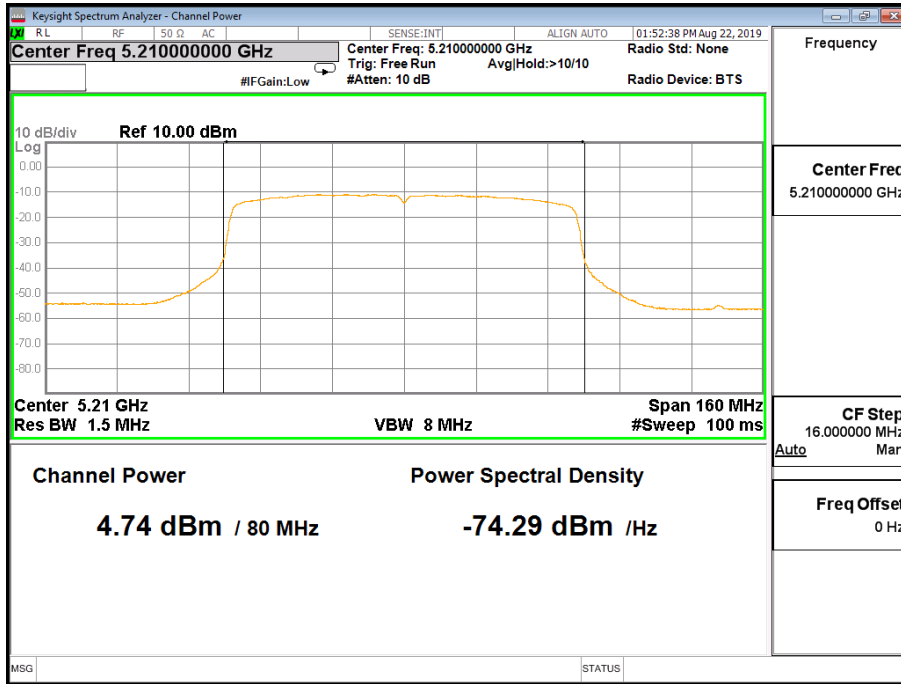

**Band IV (5.725-5.85GHz)**

Test Channel	Frequency (MHz)	PK Power A(dBm)	PK Power B(dBm)	PK Power Total(dBm)	AV Power (dBm)	AV Power B(dBm)	AV Power Total(dBm)	LIMIT (dBm)
802.11a								
149	5745	13.42	11.76	--	6.71	5.48	--	30
157	5785	12.96	11.49	--	6.66	5.27	--	30
165	5825	13.00	11.46	--	6.60	5.21	--	30
802.11n(HT20)								
149	5745	13.37	12.19	15.830	6.48	5.24	8.91	28.49
157	5785	14.02	11.86	16.083	6.45	5.01	8.80	28.49
165	5825	13.25	11.76	15.579	6.35	5.06	8.76	28.49
802.11n(HT40)								
151	5755	13.90	13.07	16.515	6.77	5.56	9.22	28.49
159	5795	14.02	12.50	16.336	6.68	5.38	9.09	28.49
802.11ac(HT20)								
149	5745	13.42	12.24	15.880	6.50	5.26	8.93	28.49
157	5785	13.22	11.96	15.646	6.42	5.05	8.80	28.49
165	5825	13.16	11.80	15.543	6.32	5.07	8.75	28.49
802.11ac(HT40)								
151	5755	13.63	12.85	16.268	6.76	5.57	9.22	28.49
159	5795	13.90	12.85	16.417	6.69	5.39	9.10	28.49
802.11ac(HT80)								
155	5775	11.54	10.60	14.106	5.34	3.65	7.59	28.49

## Note:

- For the band 5.745-5.850 GHz, the maximum conducted output power over the frequency band of operation shall not exceed the lesser of 1 W. In addition, MIMO technology Directional gain=7.51dBi, 802.11n(HT20), 802.11n(HT40), 802.11ac (VHT20), 802.11ac (VHT40), 802.11ac (VHT80) limit will reduce 1.51dBi, the limit is 28.49dBm.



802.11ac HT80(5775MHz)

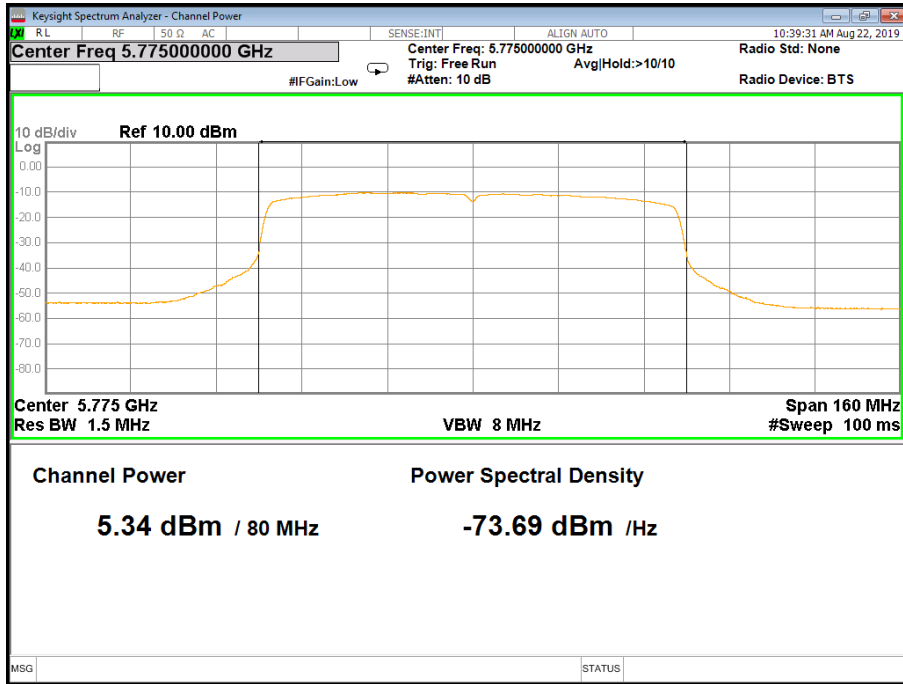



## Duty cycle

Ant_A	Mode	Ton(ms)	Tp(ms)	Duty cycle(%)
5.2G	a20	2.075	2.195	94.53%
	n20	1.755	1.920	91.41%
	n40	0.864	1.044	82.76%
	ac20	1.755	1.935	90.70%
	ac40	0.864	1.044	82.76%
	ac80	0.426	0.607	70.18%
5.8G	a20	2.075	2.195	94.53%
	n20	1.750	1.915	91.38%
	n40	0.864	1.044	82.76%
	ac20	1.755	1.925	91.17%
	ac40	0.870	1.047	83.09%
	ac80	0.426	0.609	69.95%

Ant_B	Mode	Ton(ms)	Tp(ms)	Duty cycle(%)
5.2G	a20	2.075	2.195	94.53%
	n20	1.750	1.925	90.91%
	n40	0.867	1.044	83.05%
	ac20	1.755	1.920	91.41%
	ac40	0.867	1.047	82.81%
	ac80	0.426	0.609	69.95%
5.8G	a20	2.075	2.200	94.32%
	n20	1.755	1.920	91.41%
	n40	0.864	1.044	82.76%
	ac20	1.755	1.920	91.41%
	ac40	0.867	1.047	82.81%
	ac80	0.426	0.607	70.18%

NOTE: Antenna A Power > Antenna B Power, Both antenna A and B have been test, only show the worst data of Antenna A



5.2G Ant. A

802.11a

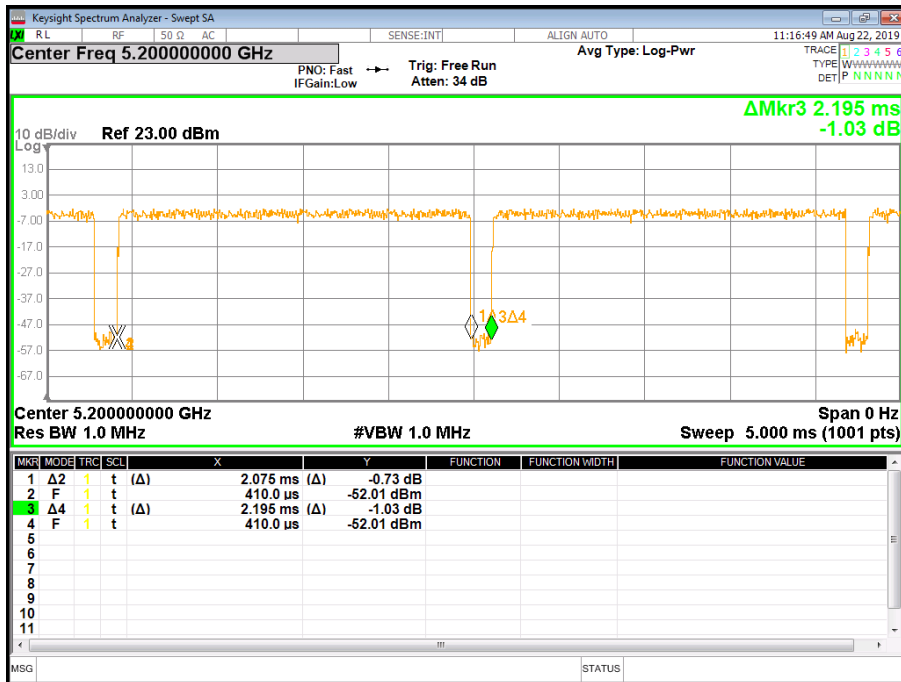

802.11n HT20





802.11n HT40

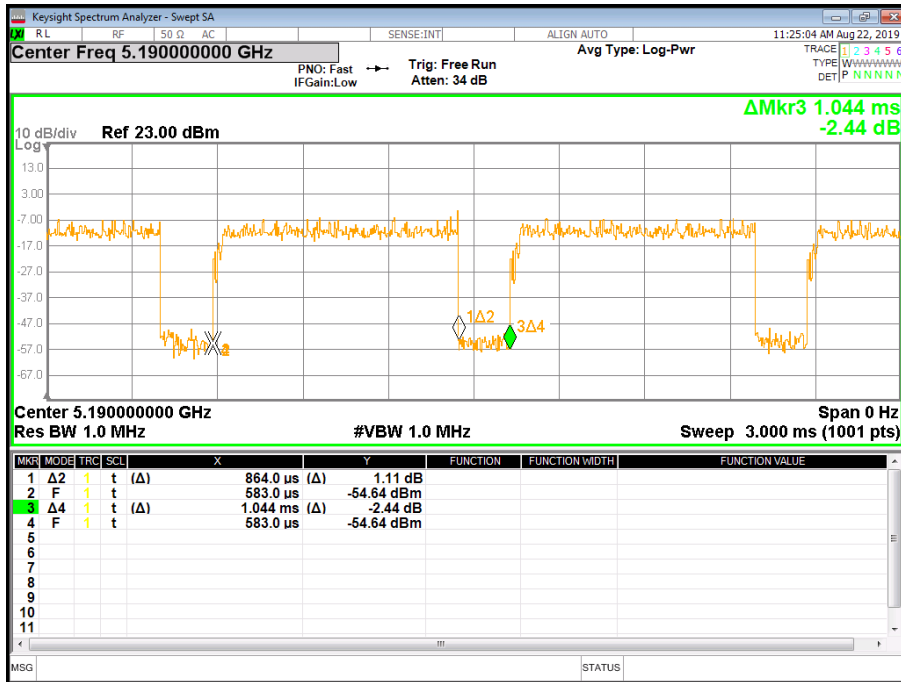

802.11ac VHT20

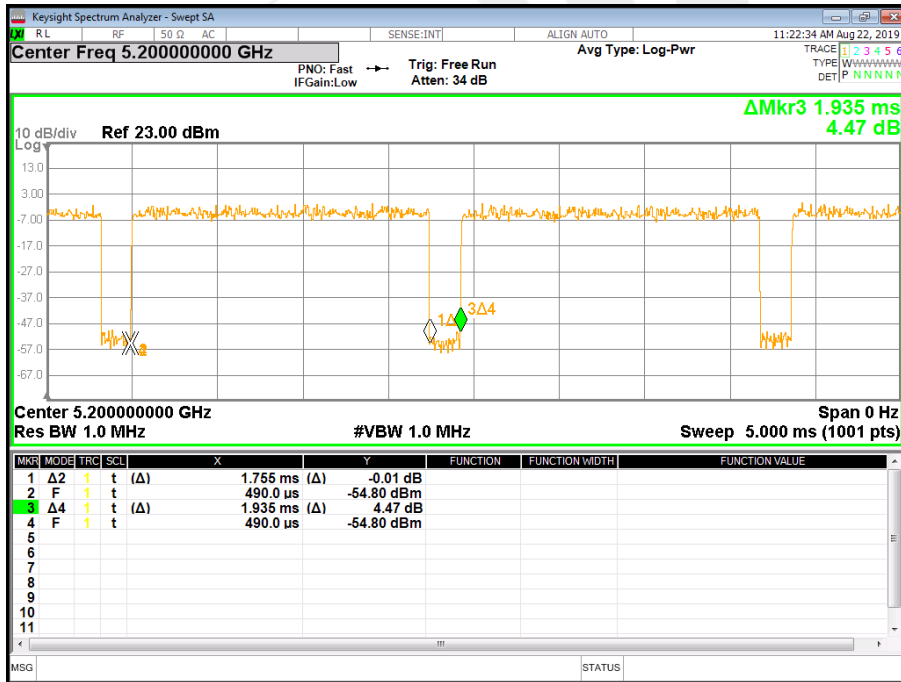





802.11ac VHT40

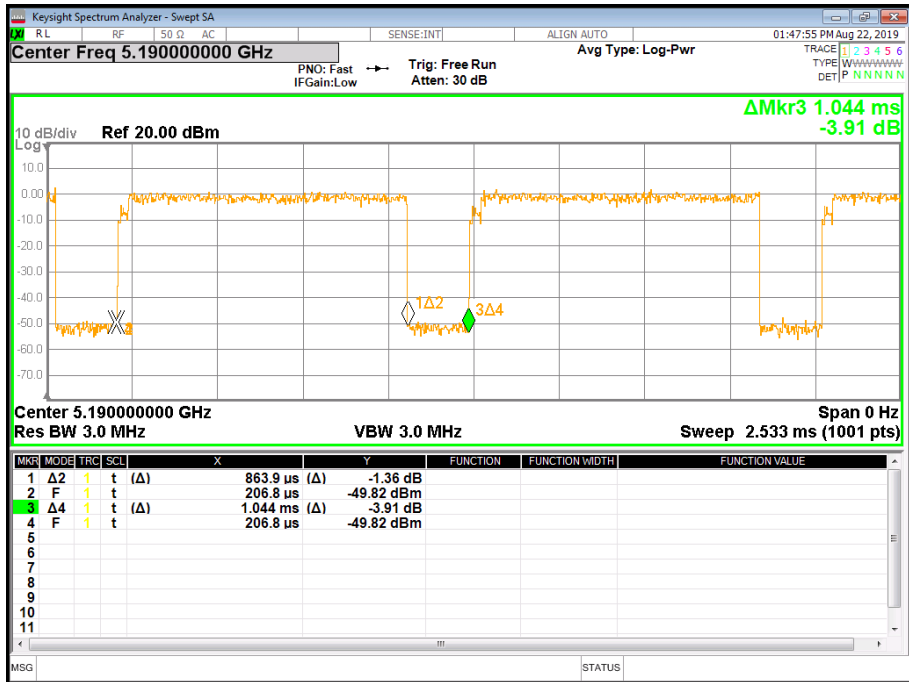

802.11ac VHT80

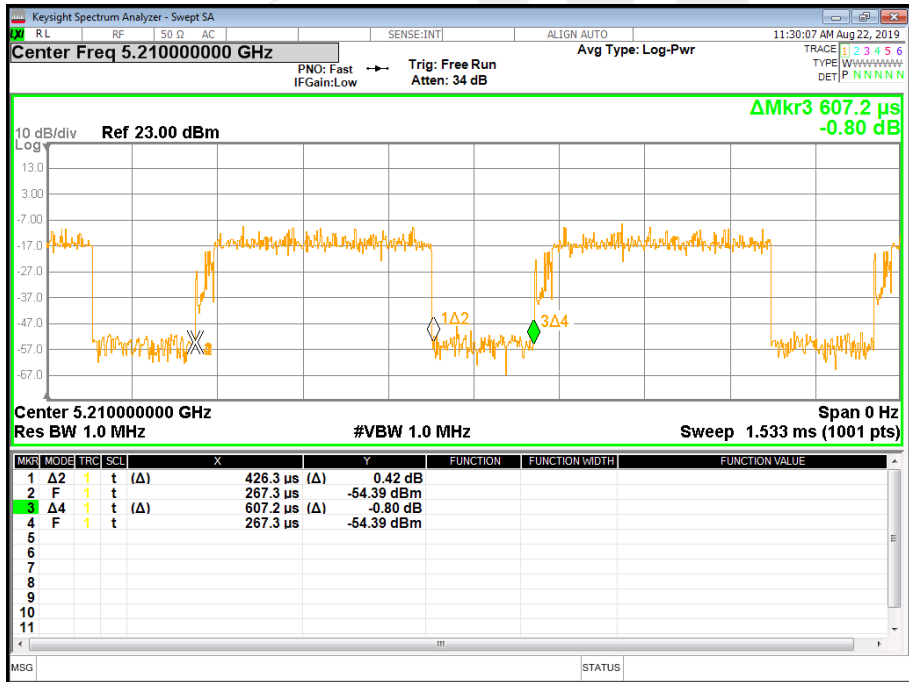



5.8G Ant. A  
802.11a

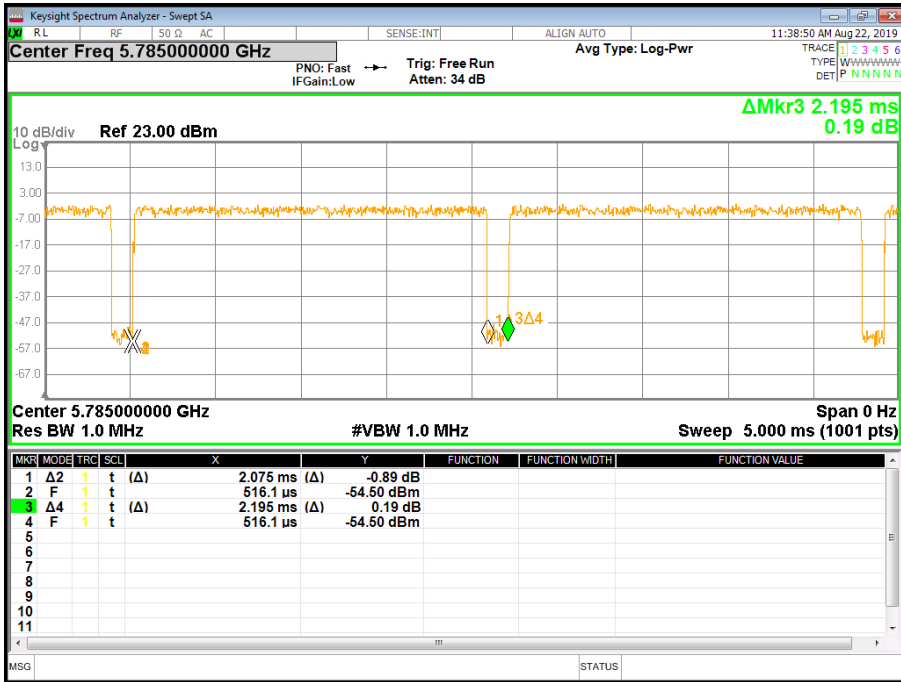

802.11n HT20

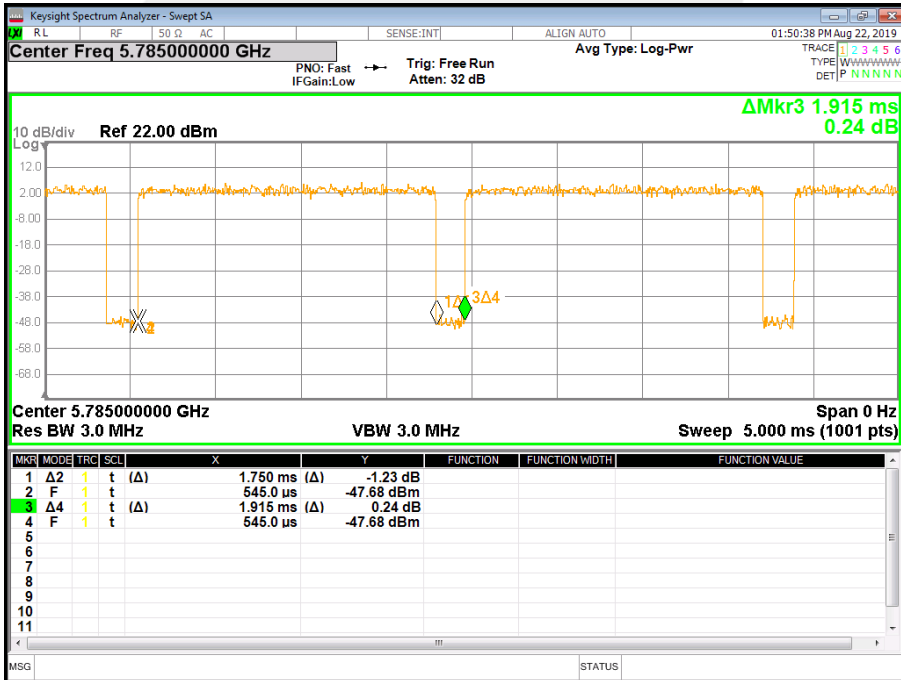



802.11n HT40

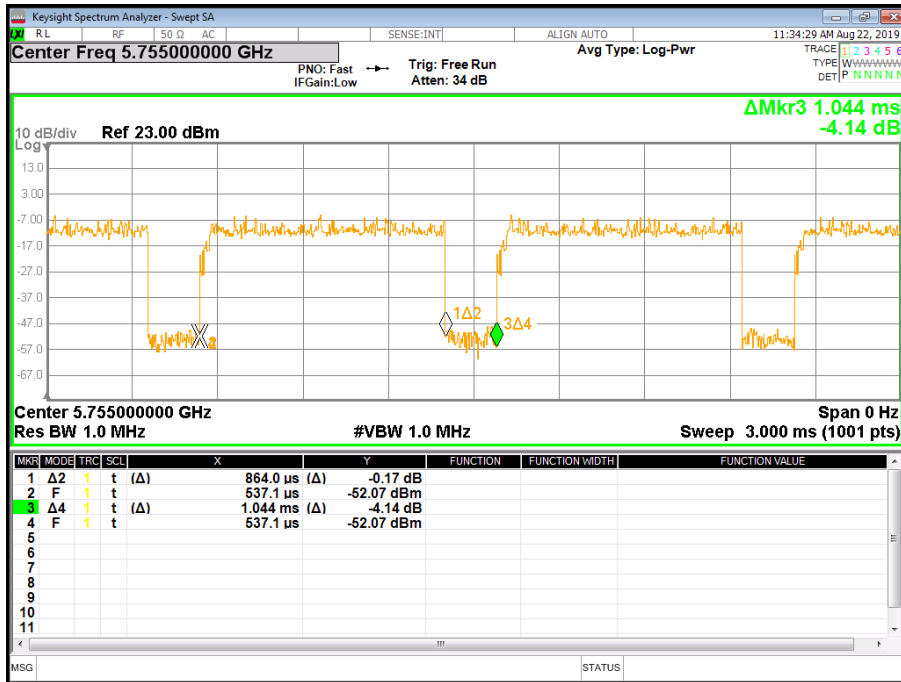

802.11ac VHT20

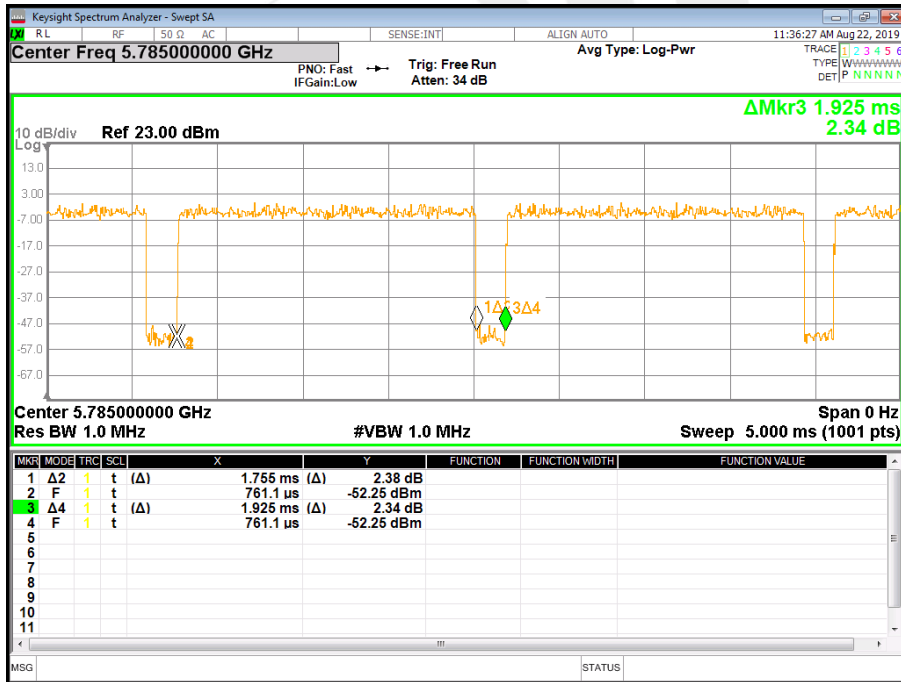



802.11ac VHT40

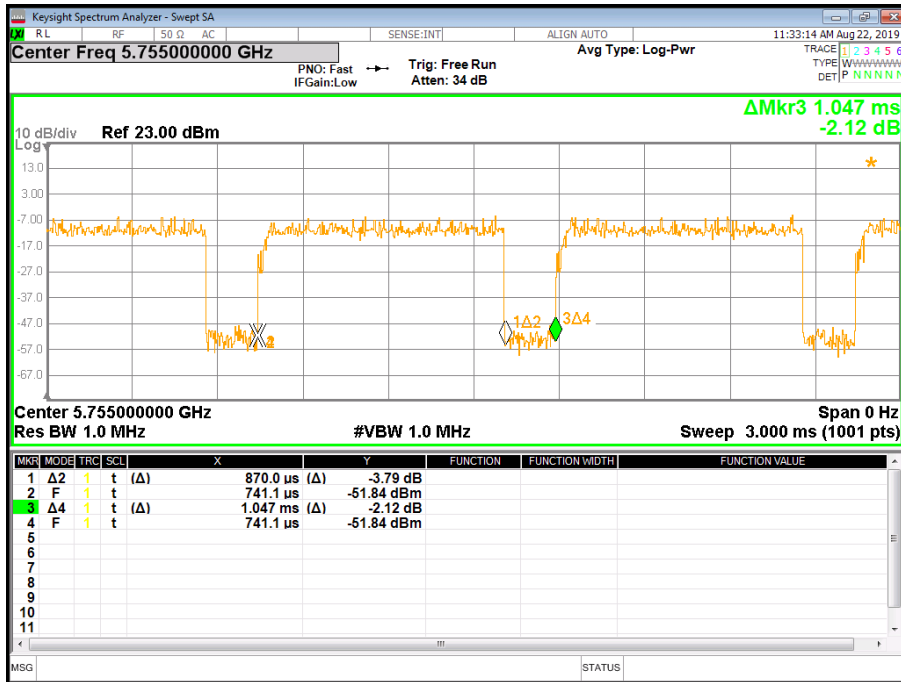

802.11ac VHT80

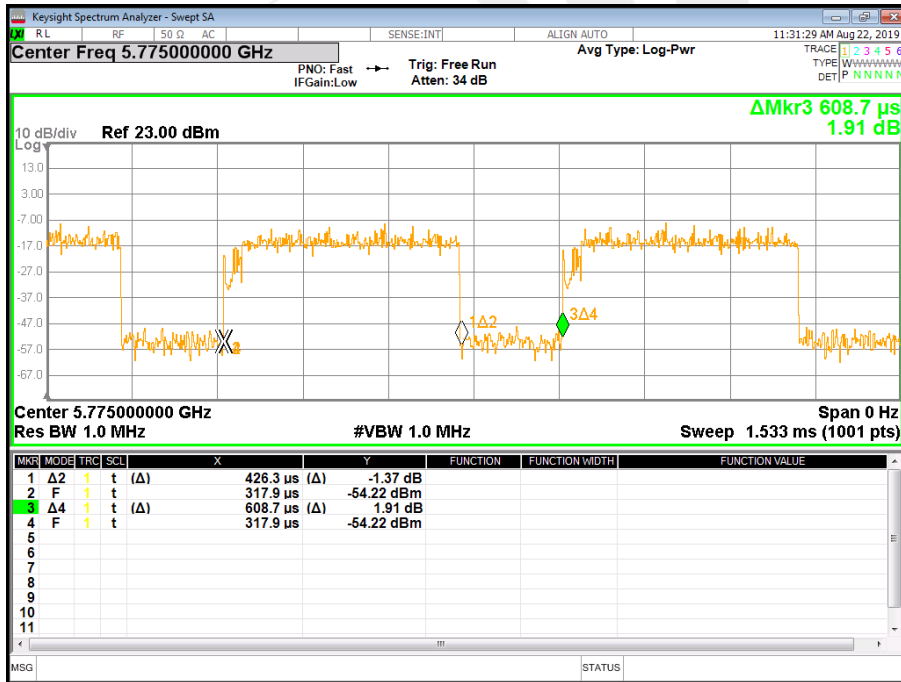



## 8. AUTOMATICALLY DISCONTINUE TRANSMISSION

### 8.1 LIMIT OF AUTOMATICALLY DISCONTINUE TRANSMISSION

The device shall automatically discontinue transmission in case of either absence of information to transmit or operational failure. These provisions are not intended to preclude the transmission of control or signaling information or the use of repetitive codes used by certain digital technologies to complete frame or burst intervals. Applicants shall include in their application for equipment authorization to describe how this requirement is met.

### 8.2 TEST RESULT OF AUTOMATICALLY DISCONTINUE TRANSMISSION

During no any information transmission, the EUT can automatically discontinue transmission and become standby mode for power saving. The EUT can detect the controlling signal of ACK message transmitting from remote device and verify whether it shall resend or discontinue transmission





## 9. ANTENNA REQUIREMENT

### 9.1 STANDARD REQUIREMENT

15.203 requirement: For intentional device, according to 15.203: an intentional radiator shall be designed to ensure that no antenna other than that furnished by the responsible party shall be used with the device.

### 9.2 EUT ANTENNA

The EUT antenna interface is an externally threaded inner needle antenna. It comply with the standard requirement.





## APPENDIX - PHOTOS OF TEST SETUP

Note: See test photos in setup photo document for the actual connections between Product and support equipment.

※※※※END OF THE REPORT※※※※

