

RF TEST REPORT



Report No.: 15071166-FCC-R5

Supersede Report No.: N/A

Applicant	Telecell Mobile (H.K) Co. Ltd.	
Product Name	Mobile Phone	
Model No.	F55L	
Serial No.	N/A	
Test Standard	FCC Part 22(H), FCC Part 24(E), FCC Part 27: 2014; ANSI/TIA-603-D: 2010	
Test Date	December 01 to December 28, 2015	
Issue Date	December 28, 2015	
Test Result	<input checked="" type="checkbox"/> Pass <input type="checkbox"/> Fail	
Equipment complied with the specification	<input checked="" type="checkbox"/>	
Equipment did not comply with the specification	<input type="checkbox"/>	
<i>Winnie Zhang</i>	<i>David Huang</i>	
Winnie Zhang Test Engineer	David Huang Checked By	
This test report may be reproduced in full only Test result presented in this test report is applicable to the tested sample only		

Issued by:

SIEMIC (SHENZHEN-CHINA) LABORATORIES

Zone A, Floor 1, Building 2 Wan Ye Long Technology Park

South Side of Zhoushi Road, Bao' an District, Shenzhen, Guangdong China 518108

Phone: +86 0755 2601 4629801 Email: China@siemic.com.cn

Laboratories Introduction

SIEMIC, headquartered in the heart of Silicon Valley, with superior facilities in US and Asia, is one of the leading independent testing and certification facilities providing customers with one-stop shop services for Compliance Testing and Global Certifications.



In addition to testing and certification, SIEMIC provides initial design reviews and compliance management throughout a project. Our extensive experience with China, Asia Pacific, North America, European, and International compliance requirements, assures the fastest, most cost effective way to attain regulatory compliance for the global markets.

Accreditations for Conformity Assessment

Country/Region	Scope
USA	EMC, RF/Wireless, SAR, Telecom
Canada	EMC, RF/Wireless, SAR, Telecom
Taiwan	EMC, RF, Telecom, SAR, Safety
Hong Kong	RF/Wireless, SAR, Telecom
Australia	EMC, RF, Telecom, SAR, Safety
Korea	EMI, EMS, RF, SAR, Telecom, Safety
Japan	EMI, RF/Wireless, SAR, Telecom
Singapore	EMC, RF, SAR, Telecom
Europe	EMC, RF, SAR, Telecom, Safety

Test Report	15071166-FCC-R5
Page	3 of 148

This page has been left blank intentionally.

CONTENTS

1. REPORT REVISION HISTORY	5
2. CUSTOMER INFORMATION	5
3. TEST SITE INFORMATION.....	5
4. EQUIPMENT UNDER TEST (EUT) INFORMATION	6
5. TEST SUMMARY	9
6. MEASUREMENTS, EXAMINATION AND DERIVED RESULTS	10
6.1 RF EXPOSURE (SAR).....	10
6.2 RF OUTPUT POWER.....	11
6.3 PEAK-AVERAGE RATIO.....	52
6.4 OCCUPIED BANDWIDTH.....	56
6.5 SPURIOUS EMISSIONS AT ANTENNA TERMINALS.....	89
6.6 SPURIOUS RADIATED EMISSIONS.....	96
6.7 BAND EDGE.....	103
6.8 BAND EDGE 27.53(M).....	127
6.9 FREQUENCY STABILITY	133
ANNEX A. TEST INSTRUMENT.....	138
ANNEX B. EUT AND TEST SETUP PHOTOGRAPHS.....	139
ANNEX C. TEST SETUP AND SUPPORTING EQUIPMENT.....	144
ANNEX C.II. EUT OPERATING CONKITIONS.....	146
ANNEX D. USER MANUAL / BLOCK DIAGRAM / SCHEMATICS / PARTLIST	147
ANNEX E. DECLARATION OF SIMILARITY.....	148

1. Report Revision History

Report No.	Report Version	Description	Issue Date
15071166-FCC-R5	NONE	Original	December 28, 2015

2. Customer information

Applicant Name	Telecell Mobile (H.K) Co. Ltd.
Applicant Add	RM 1, 8/F Metro Centre 2, 21 Lam Hing Street. Kln Bay. Hong Kong
Manufacturer	Telecell Mobile (H.K) Co. Ltd.
Manufacturer Add	RM 1, 8/F Metro Centre 2, 21 Lam Hing Street. Kln Bay. Hong Kong

3. Test site information

Lab performing tests	SIEMIC (Shenzhen-China) LABORATORIES
Lab Address	Zone A, Floor 1, Building 2 Wan Ye Long Technology Park South Side of Zhoushi Road, Bao' an District, Shenzhen, Guangdong China 518108
FCC Test Site No.	718246
IC Test Site No.	4842E-1
Test Software	Radiated Emission Program-To Shenzhen v2.0

4. Equipment under Test (EUT) Information

Description of EUT:	Mobile Phone
Main Model:	F55L
Serial Model:	N/A
Date EUT received:	December 01, 2015
Test Date(s):	December 01 to December 28, 2015
Equipment Category :	PCE
Antenna Gain:	<p>GSM850: 1.6 dBi PCS1900: 3.8 dBi UMTS-FDD Band V: 1.7 dBi UMTS-FDD Band IV: 3.7 dBi UMTS-FDD Band II: 3.8 dBi Bluetooth/BLE: 3 dBi WIFI: 2.9 dBi LTE Band 2: 3.8 dBi LTE Band 4: 3.95 dBi LTE Band 5: 1.7 dBi LTE Band 7: 4.3 dBi LTE Band 12: 1.45 dBi LTE Band 17: 1.5 dBi GPS:1.6 dBi</p>
Type of Modulation:	<p>GSM / GPRS: GMSK EGPRS: GMSK UMTS-FDD: QPSK, 16QAM 802.11b/g/n: DSSS, OFDM Bluetooth: GFSK, π /4DQPSK, 8DPSK BLE: GFSK LTE Band: QPSK, 16QAM GPS:BPSK</p>

	GSM850 TX: 824.2 ~ 848.8 MHz; RX: 869.2 ~ 893.8 MHz
	PCS1900 TX: 1850.2 ~ 1909.8 MHz; RX: 1930.2 ~ 1989.8 MHz
	UMTS-FDD Band V TX: 826.4 ~ 846.6 MHz; RX: 871.4 ~ 891.6 MHz
	UMTS-FDD Band IV TX:1712.4 ~ 1752.6 MHz;
	RX : 2112.4 ~ 2152.6 MHz
	UMTS-FDD Band II TX:1852.4 ~ 1907.6 MHz;
	RX: 1932.4 ~ 1987.6 MHz
	WiFi:802.11b/g/n(20M): 2412-2462 MHz
RF Operating Frequency (ies):	WiFi:802.11n(40M): 2422-2452 MHz
	Bluetooth& BLE: 2402-2480 MHz
	LTE Band 2 TX: 1852.5 ~ 1907.5 MHz; RX : 1932.5 ~ 1987.5 MHz
	LTE Band 4 TX: 1712.5 ~ 1752.5 MHz; RX : 2112.5 ~ 2152.5 MHz
	LTE Band 5 TX: 826.5 ~ 846.5 MHz; RX : 871.5 ~ 891.5 MHz
	LTE Band 7 TX: 2502.5 ~ 2567.5 MHz; RX : 2622.5 ~ 2687.5 MHz
	LTE Band 12 TX:699.7 ~ 715.3 MHz; RX : 729.7~ 745.3MHz
	LTE Band 17 TX: 706.5 ~ 713.5 MHz; RX : 736.5 ~ 743.5 MHz
	GPS RX:1575.42 MHz
Maximum Conducted	LTE Band 2: 23.34 dBm
AV Power to Antenna:	LTE Band 4: 22.70 dBm
	LTE Band 5: 23.01dBm
	LTE Band 7: 23.94 dBm
	LTE Band 12: 23.12 dBm
	LTE Band 17: 23.23 dBm
ERP/EIRP:	LTE Band 2: 26.84 dBm / EIRP
	LTE Band 4: 25.92 dBm / EIRP
	LTE Band 5: 24.51 dBm / EIRP
	LTE Band 7: 27.34 dBm / EIRP
	LTE Band 12: 25.21 dBm / EIRP
	LTE Band 17: 24.33 dBm / ERP
Port:	Power Port, Earphone Port, USB Port

Test Report	15071166-FCC-R5
Page	8 of 148

Adapter:
Model: SC/8WA050150US
Input: AC 100-240V; 50/60Hz;0.3A
Output: DC 5.0V,1.5A

Input Power: Battery:
Model: C975339250P
Spec:3.8V,2500mAh,9.5Wh

Trade Name : FIGO

GPRS/EGPRS Multi-slot class 8/10/12

FCC ID: 2ADX3F55L

5. Test Summary

The product was tested in accordance with the following specifications.

All testing has been performed according to below product classification:

FCC Rules	Description of Test	Result
§ 1.1307; § 2.1093	RF Exposure (SAR)	Compliance
§2.1046; § 22.913(a); § 24.232(c); § 27.50(c.10); § 27.50(d.4)	RF Output Power	Compliance
§ 24.232 (d); § 27.50(d)	Peak-Average Ratio	Compliance
§ 2.1047	Modulation Characteristics	N/A
§ 2.1049; § 22.905; § 22.917; § 24.238; § 27.53(a.5)	99% & -26 dB Occupied Bandwidth	Compliance
§ 2.1051; § 22.917(a); § 24.238(a); § 27.53(h)	Spurious Emissions at Antenna Terminal	Compliance
§ 2.1053; § 22.917(a); § 24.238(a); § 27.53(h)	Field Strength of Spurious Radiation	Compliance
§ 22.917(a); § 24.238(a);	Out of band emission, Band Edge	Compliance
§ 27.53(m)	Band Edge 27.53(m)	Compliance
§ 2.1055; § 22.355; § 24.235; § 27.5(h); § 27.54	Frequency stability vs. temperature Frequency stability vs. voltage	Compliance

Note: Testing was performed by configuring EUT to maximum output power status, the declared output power class for different

Measurement Uncertainty

Emissions		
Test Item	Description	Uncertainty
Band Edge and Radiated Spurious Emissions	Confidence level of approximately 95% (in the case where distributions are normal), with a coverage factor of 2 (for EUTs < 0.5m X 0.5m X 0.5m)	+5.6dB/-4.5dB
-	-	-

6. MEASUREMENTS, EXAMINATION AND DERIVED RESULTS

6.1 RF Exposure (SAR)

Test Result: Pass

The EUT is a portable device, thus requires SAR evaluation;

Please refer to RF Exposure Evaluation Report: 15071166-FCC-H.

6.2 RF Output Power

Temperature	24°C
Relative Humidity	56%
Atmospheric Pressure	1023mbar
Test date :	December 23, 2015
Tested By :	Winnie Zhang

Requirement(s):

Spec	Item	Requirement	Applicable
§22.913 (a)	a)	ERP:38.45dBm	<input checked="" type="checkbox"/>
§24.232 (c)	b)	EIRP:33dBm	<input checked="" type="checkbox"/>
§27.50 (c)	c)	EIRP: 30dBm	<input checked="" type="checkbox"/>

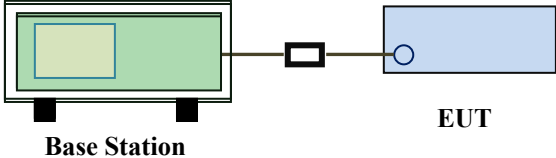
Test Setup	 <p>The diagram illustrates the test setup. On the left is a green rectangular box labeled 'Base Station'. A black cable connects it to a blue rectangular box on the right labeled 'EUT'. The connection point on the EUT is marked with a small circle.</p>
------------	--

Test Procedure	<p>For Conducted Power:</p> <ul style="list-style-type: none"> - The transmitter output port was connected to base station. - Set EUT at maximum power through base station. - Select lowest, middle, and highest channels for each band and different test mode. <p>For ERP/EIRP:</p> <ul style="list-style-type: none"> - The transmitter was placed on a wooden turntable, and it was transmitting into a non-radiating load which was also placed on the turntable. - The measurement antenna was placed at a distance of 3 meters from the EUT. During the tests, the antenna height and polarization as well as EUT azimuth were varied in order to identify the maximum level of emissions from the EUT. The test was performed by placing the EUT on 3-orthogonal axis. - The frequency range up to tenth harmonic of the fundamental frequency was investigated.
----------------	---

Test Report	15071166-FCC-R5
Page	12 of 148

	<ul style="list-style-type: none"> - Remove the EUT and replace it with substitution antenna. A signal generator was connected to the substitution antenna by a non-radiating cable. The absolute levels of the spurious emissions were measured by the substitution. - Spurious emissions in dB = 10 log (TX power in Watts/0.001) – the absolute level - Spurious attenuation limit in dB = 43 + 10 Log10 (power out in Watts).
Remark	
Result	<input checked="" type="checkbox"/> Pass <input type="checkbox"/> Fail

Test Data Yes N/A
Test Plot Yes (See below) N/A

Conducted Power

LTE Band 2:

BW (MHz)	Ch	Freq. (MHz)	Mode	UL RB Allocation	UL RB Offset	MPR	Average power (dBm)	Tune up Power tolerant
20MHz	18700	1860.0	QPSK	1	0	0	23.21	23±1
				1	49	0	23.05	23±1
				1	99	0	23.06	23±1
				50	0	1	22.20	23±1
				50	24	1	22.19	23±1
				50	49	1	22.17	23±1
			100	0	1	22.14	23±1	
			16QAM	1	0	1	22.71	22±1
				1	49	1	22.55	22±1
				1	99	1	22.56	22±1
				50	0	2	22.12	22±1
				50	24	2	22.09	22±1
				50	49	2	22.04	22±1
				100	0	2	21.24	22±1
	18900	1880.0		QPSK	1	0	0	23.27
			1		49	0	23.14	23±1
			1		99	0	23.22	23±1
			50		0	1	22.21	23±1
			50		24	1	22.19	23±1
			50		49	1	22.20	23±1
			100	0	1	22.17	23±1	
			16QAM	1	0	1	22.19	22±1
				1	49	1	22.07	22±1
				1	99	1	22.15	22±1
				50	0	2	21.89	22±1
				50	24	2	21.87	22±1
				50	49	2	21.86	22±1
				100	0	2	21.29	22±1
	19100	1900.0		QPSK	1	0	0	23.04
			1		49	0	22.95	23±1
1			99		0	23.05	23±1	
50			0		1	22.21	23±1	
50			24		1	22.19	23±1	
50			49		1	22.17	23±1	
100			0	1	22.15	23±1		
16QAM			1	0	1	22.45	22±1	
			1	49	1	22.27	22±1	
			1	99	1	22.34	22±1	
			50	0	2	22.11	22±1	
			50	24	2	22.09	22±1	
			50	49	2	22.08	22±1	
			100	0	2	21.29	22±1	

BW (MHz)	Ch	Freq. (MHz)	Mode	UL RB Allocation	UL RB Offset	MPR	Average power (dBm)	Tune up Power tolerant
15MHz	18675	1857.5	QPSK	1	0	0	23.06	23±1
				1	37	0	22.93	23±1
				1	74	0	22.92	23±1
				36	0	1	22.15	23±1
				36	16	1	22.12	23±1
				36	35	1	22.09	23±1
				75	0	1	22.17	23±1
			16QAM	1	0	1	22.81	22±1
				1	37	1	22.71	22±1
				1	74	1	22.71	22±1
				36	0	2	21.78	22±1
				36	16	2	21.76	22±1
				36	35	2	21.74	22±1
				75	0	2	21.25	22±1
	18900	1880.0	QPSK	1	0	0	23.18	23±1
				1	37	0	23.16	23±1
				1	74	0	23.15	23±1
				36	0	1	22.09	23±1
				36	16	1	22.07	23±1
				36	35	1	22.08	23±1
				75	0	1	22.14	23±1
			16QAM	1	0	1	22.08	22±1
				1	37	1	22.04	22±1
				1	74	1	22.02	22±1
				36	0	2	21.71	22±1
				36	16	2	21.70	22±1
				36	35	2	21.68	22±1
				75	0	2	21.25	22±1
	19125	1902.5	QPSK	1	0	0	23.02	23±1
				1	37	0	23.01	23±1
				1	74	0	23.07	23±1
				36	0	1	22.11	23±1
				36	16	1	22.12	23±1
				36	35	1	22.13	23±1
				75	0	1	22.15	23±1
			16QAM	1	0	1	22.42	22±1
1				37	1	22.38	22±1	
1				74	1	22.34	22±1	
36				0	2	21.68	22±1	
36				16	2	21.65	22±1	
36				35	2	21.66	22±1	
75				0	2	21.21	22±1	

BW (MHz)	Ch	Freq. (MHz)	Mode	UL RB Allocation	UL RB Offset	MPR	Average power (dBm)	Tune up Power tolerant
10MHz	18650	1855	QPSK	1	0	0	23.05	23±1
				1	24	0	22.97	23±1
				1	49	0	22.94	23±1
				25	0	1	22.16	23±1
				25	12	1	22.13	23±1
				25	24	1	22.10	23±1
				50	0	1	22.18	23±1
			16QAM	1	0	1	22.77	22±1
				1	24	1	22.69	22±1
				1	49	1	22.66	22±1
				25	0	2	22.35	22±1
				25	12	2	22.34	22±1
				25	24	2	22.31	22±1
				50	0	2	21.27	22±1
	18900	1880.0	QPSK	1	0	0	23.16	23±1
				1	24	0	23.12	23±1
				1	49	0	23.11	23±1
				25	0	1	22.15	23±1
				25	12	1	22.13	23±1
				25	24	1	22.14	23±1
				50	0	1	22.17	23±1
			16QAM	1	0	1	22.04	22±1
				1	24	1	22.00	22±1
				1	49	1	22.02	22±1
				25	0	2	21.67	22±1
				25	12	2	21.65	22±1
				25	24	2	21.64	22±1
				50	0	2	21.29	22±1
	19150	1905	QPSK	1	0	0	22.99	23±1
				1	24	0	22.93	23±1
1				49	0	23.03	23±1	
25				0	1	22.10	23±1	
25				12	1	22.11	23±1	
25				24	1	22.12	23±1	
50				0	1	22.15	23±1	
16QAM			1	0	1	22.74	22±1	
			1	24	1	22.65	22±1	
			1	49	1	22.67	22±1	
			25	0	2	21.88	22±1	
			25	12	2	21.86	22±1	
			25	24	2	21.84	22±1	
			50	0	2	21.29	22±1	

BW (MHz)	Ch	Freq. (MHz)	Mode	UL RB Allocation	UL RB Offset	MPR	Average power (dBm)	Tune up Power tolerant
5MHz	18625	1852.5	QPSK	1	0	0	23.21	23±1
				1	12	0	23.19	23±1
				1	24	0	23.08	23±1
				12	0	1	22.23	23±1
				12	6	1	22.21	23±1
				12	11	1	22.19	23±1
				25	0	1	22.16	23±1
			16QAM	1	0	1	22.18	22±1
				1	12	1	22.19	22±1
				1	24	1	22.11	22±1
				12	0	2	21.75	22±1
				12	6	2	21.73	22±1
				12	11	2	21.74	22±1
				25	0	2	21.30	22±1
	18900	1880.0	QPSK	1	0	0	23.12	23±1
				1	12	0	23.09	23±1
				1	24	0	23.06	23±1
				12	0	1	22.18	23±1
				12	6	1	22.17	23±1
				12	11	1	22.16	23±1
				25	0	1	22.14	23±1
			16QAM	1	0	1	22.62	22±1
				1	12	1	22.60	22±1
				1	24	1	22.55	22±1
				12	0	2	22.14	22±1
				12	6	2	22.12	22±1
				12	11	2	22.11	22±1
				25	0	2	21.23	22±1
	19175	1907.5	QPSK	1	0	0	23.03	23±1
				1	12	0	23.04	23±1
1				24	0	23.02	23±1	
12				0	1	22.15	23±1	
12				6	1	22.14	23±1	
12				11	1	22.16	23±1	
25				0	1	22.10	23±1	
16QAM			1	0	1	22.13	22±1	
			1	12	1	22.14	22±1	
			1	24	1	22.10	22±1	
			12	0	2	21.87	22±1	
			12	6	2	21.85	22±1	
			12	11	2	21.84	22±1	
			25	0	2	21.26	22±1	

BW (MHz)	Ch	Freq. (MHz)	Mode	UL RB Allocation	UL RB Offset	MPR	Average power (dBm)	Tune up Power tolerant
3MHz	18625	1852.5	QPSK	1	0	0	23.15	23±1
				1	7	0	23.18	23±1
				1	14	0	23.13	23±1
				8	0	1	22.18	23±1
				8	4	1	22.15	23±1
				8	7	1	22.12	23±1
				15	0	1	22.15	23±1
			16QAM	1	0	1	22.02	22±1
				1	7	1	22.01	22±1
				1	14	1	22.00	22±1
				8	0	2	21.68	22±1
				8	4	2	21.69	22±1
				8	7	2	21.67	22±1
				15	0	2	21.18	22±1
	18900	1880.0	QPSK	1	0	0	23.05	23±1
				1	7	0	23.08	23±1
				1	14	0	23.05	23±1
				8	0	1	22.11	23±1
				8	4	1	22.10	23±1
				8	7	1	22.09	23±1
				15	0	1	22.12	23±1
			16QAM	1	0	1	22.08	22±1
				1	7	1	22.08	22±1
				1	14	1	22.05	22±1
				8	0	2	21.54	22±1
				8	4	2	21.56	22±1
				8	7	2	21.53	22±1
				15	0	2	21.23	22±1
	19175	1907.5	QPSK	1	0	0	22.90	22±1
				1	7	0	22.97	22±1
1				14	0	22.93	22±1	
8				0	1	22.09	22±1	
8				4	1	22.08	22±1	
8				7	1	22.10	22±1	
15				0	1	22.12	22±1	
16QAM			1	0	1	22.59	22±1	
			1	7	1	22.62	22±1	
			1	14	1	22.51	22±1	
			8	0	2	21.95	22±1	
			8	4	2	21.96	22±1	
			8	7	2	21.94	22±1	
			15	0	2	21.33	22±1	

BW (MHz)	Ch	Freq. (MHz)	Mode	UL RB Allocation	UL RB Offset	MPR	Average power (dBm)	Tune up Power tolerant
1.4MHz	18607	1850.7	QPSK	1	0	0	23.19	23±1
				1	2	0	23.15	23±1
				1	5	0	23.18	23±1
				3	0	0	23.34	23±1
				3	1	0	23.31	23±1
				3	2	0	23.28	23±1
			6	0	1	22.07	23±1	
			16QAM	1	0	1	22.05	22±1
				1	2	1	22.02	22±1
				1	5	1	22.03	22±1
				3	0	1	21.64	22±1
				3	1	1	21.63	22±1
	3	2		1	21.65	22±1		
	6	0	2	21.12	22±1			
	18900	1880.0	QPSK	1	0	0	23.05	22.3±1
				1	2	0	23.04	22.3±1
				1	5	0	23.07	22.3±1
				3	0	0	23.17	22.3±1
				3	1	0	23.18	22.3±1
				3	2	0	23.19	22.3±1
			6	0	1	21.96	22.3±1	
			16QAM	1	0	1	22.06	21.3±1
				1	2	1	22.07	21.3±1
				1	5	1	22.12	21.3±1
				3	0	1	21.54	21.3±1
				3	1	1	21.52	21.3±1
	3	2		1	21.49	21.3±1		
	6	0	2	20.95	21.3±1			
	19193	1909.3	QPSK	1	0	0	23.01	23±1
				1	2	0	22.98	23±1
				1	5	0	23.05	23±1
				3	0	0	23.22	23±1
				3	1	0	23.19	23±1
				3	2	0	23.21	23±1
			6	0	1	22.01	23±1	
			16QAM	1	0	1	21.71	22±1
1				2	1	21.68	22±1	
1				5	1	21.71	22±1	
3				0	1	21.32	22±1	
3				1	1	21.31	22±1	
3	2	1		21.29	22±1			
6	0	2	21.04	22±1				

LTE Band 4:

BW (MHz)	Ch	Freq. (MHz)	Mode	UL RB Allocation	UL RB Offset	MPR	Average power (dBm)	Tune up Power tolerant
20MHz	20050	1720.0	QPSK	1	0	0	22.70	22 ± 1
				1	49	0	22.47	22 ± 1
				1	99	0	22.49	22 ± 1
				50	0	1	22.59	22 ± 1
				50	24	1	22.54	22 ± 1
				50	49	1	22.48	22 ± 1
				100	0	1	22.51	22 ± 1
			16QAM	1	0	1	22.57	22 ± 1
				1	49	1	22.37	22 ± 1
				1	99	1	22.36	22 ± 1
				50	0	2	22.21	22 ± 1
				50	24	2	22.20	22 ± 1
				50	49	2	22.18	22 ± 1
				100	0	2	21.75	22 ± 1
	20175	1732.5	QPSK	1	0	0	22.02	22 ± 1
				1	49	0	21.95	22 ± 1
				1	99	0	21.89	22 ± 1
				50	0	1	21.90	22 ± 1
				50	24	1	21.85	22 ± 1
				50	49	1	21.81	22 ± 1
				100	0	1	21.82	22 ± 1
			16QAM	1	0	1	21.92	22 ± 1
				1	49	1	21.85	22 ± 1
				1	99	1	21.78	22 ± 1
				50	0	2	21.75	22 ± 1
				50	24	2	21.76	22 ± 1
				50	49	2	21.74	22 ± 1
				100	0	2	21.84	22 ± 1
	20300	1745.0	QPSK	1	0	0	21.82	22 ± 1
				1	49	0	21.51	22 ± 1
1				99	0	21.49	22 ± 1	
50				0	1	21.65	22 ± 1	
50				24	1	21.63	22 ± 1	
50				49	1	21.61	22 ± 1	
100				0	1	21.61	22 ± 1	
16QAM			1	0	1	21.95	22 ± 1	
			1	49	1	21.86	22 ± 1	
			1	99	1	21.80	22 ± 1	
			50	0	2	21.78	22 ± 1	
			50	24	2	21.79	22 ± 1	
			50	49	2	21.75	22 ± 1	
			100	0	2	21.67	22 ± 1	

BW (MHz)	Ch	Freq. (MHz)	Mode	UL RB Allocation	UL RB Offset	MPR	Average power (dBm)	Tune up Power tolerant
15MHz	20025	1717.5	QPSK	1	0	0	22.11	22 ± 1
				1	37	0	21.99	22 ± 1
				1	74	0	21.93	22 ± 1
				36	0	1	22.05	22 ± 1
				36	16	1	21.96	22 ± 1
				36	35	1	21.93	22 ± 1
				75	0	1	21.99	22 ± 1
			16QAM	1	0	1	21.92	22 ± 1
				1	37	1	21.81	22 ± 1
				1	74	1	21.74	22 ± 1
				36	0	2	21.64	22 ± 1
				36	16	2	21.62	22 ± 1
				36	35	2	21.66	22 ± 1
				75	0	2	22.01	22 ± 1
	20175	1732.5	QPSK	1	0	0	21.75	22 ± 1
				1	37	0	21.67	22 ± 1
				1	74	0	21.59	22 ± 1
				36	0	1	21.85	22 ± 1
				36	16	1	21.79	22 ± 1
				36	35	1	21.74	22 ± 1
				75	0	1	21.82	22 ± 1
			16QAM	1	0	1	22.05	22 ± 1
				1	37	1	22.01	22 ± 1
				1	74	1	21.94	22 ± 1
				36	0	2	21.89	22 ± 1
				36	16	2	21.88	22 ± 1
				36	35	2	21.86	22 ± 1
				75	0	2	21.81	22 ± 1
	20325	1747.5	QPSK	1	0	0	21.52	22 ± 1
				1	37	0	21.48	22 ± 1
1				74	0	21.43	22 ± 1	
36				0	1	21.66	22 ± 1	
36				16	1	21.64	22 ± 1	
36				35	1	21.63	22 ± 1	
75				0	1	21.65	22 ± 1	
16QAM			1	0	1	22.21	22 ± 1	
			1	37	1	22.18	22 ± 1	
			1	74	1	22.10	22 ± 1	
			36	0	2	21.96	22 ± 1	
			36	16	2	21.95	22 ± 1	
			36	35	2	21.93	22 ± 1	
			75	0	2	21.69	22 ± 1	

BW (MHz)	Ch	Freq. (MHz)	Mode	UL RB Allocation	UL RB Offset	MPR	Average power (dBm)	Tune up Power tolerant
10MHz	20000	1715.0	QPSK	1	0	0	22.09	22 ± 1
				1	24	0	22.02	22 ± 1
				1	49	0	21.92	22 ± 1
				25	0	1	22.01	22 ± 1
				25	12	1	21.98	22 ± 1
				25	24	1	21.93	22 ± 1
				50	0	1	21.96	22 ± 1
			16QAM	1	0	1	21.93	22 ± 1
				1	24	1	21.86	22 ± 1
				1	49	1	21.75	22 ± 1
				25	0	2	21.68	22 ± 1
				25	12	2	21.65	22 ± 1
				25	24	2	21.64	22 ± 1
				50	0	2	21.97	22 ± 1
	20175	1732.5	QPSK	1	0	0	21.89	22 ± 1
				1	24	0	21.82	22 ± 1
				1	49	0	21.73	22 ± 1
				25	0	1	21.81	22 ± 1
				25	12	1	21.74	22 ± 1
				25	24	1	21.76	22 ± 1
				50	0	1	21.81	22 ± 1
			16QAM	1	0	1	21.85	22 ± 1
				1	24	1	21.78	22 ± 1
				1	49	1	21.67	22 ± 1
				25	0	2	21.54	22 ± 1
				25	12	2	21.52	22 ± 1
				25	24	2	21.48	22 ± 1
50				0	2	21.85	22 ± 1	
20350	1750.0	QPSK	1	0	0	21.50	22 ± 1	
			1	24	0	21.48	22 ± 1	
			1	49	0	21.40	22 ± 1	
			25	0	1	21.62	22 ± 1	
			25	12	1	21.59	22 ± 1	
			25	24	1	21.57	22 ± 1	
			50	0	1	21.64	22 ± 1	
		16QAM	1	0	1	22.20	22 ± 1	
			1	24	1	22.17	22 ± 1	
			1	49	1	22.07	22 ± 1	
			25	0	2	21.85	22 ± 1	
			25	12	2	21.83	22 ± 1	
			25	24	2	21.79	22 ± 1	
			50	0	2	21.67	22 ± 1	

BW (MHz)	Ch	Freq. (MHz)	Mode	UL RB Allocation	UL RB Offset	MPR	Average power (dBm)	Tune up Power tolerant
5MHz	20000	1715.0	QPSK	1	0	0	21.99	22±1
				1	12	0	21.98	22±1
				1	24	0	21.89	22±1
				12	0	1	22.02	22±1
				12	6	1	22.01	22±1
				12	11	1	22.00	22±1
				25	0	1	21.98	22±1
			16QAM	1	0	1	22.43	22±1
				1	12	1	22.42	22±1
				1	24	1	22.31	22±1
				12	0	2	22.12	22±1
				12	6	2	22.11	22±1
				12	11	2	22.09	22±1
				25	0	2	21.95	22±1
	20175	1732.5	QPSK	1	0	0	21.75	22±1
				1	12	0	21.73	22±1
				1	24	0	21.63	22±1
				12	0	1	21.86	22±1
				12	6	1	21.82	22±1
				12	11	1	21.78	22±1
				25	0	1	21.78	22±1
			16QAM	1	0	1	21.83	22±1
				1	12	1	21.81	22±1
				1	24	1	21.74	22±1
				12	0	2	21.79	22±1
				12	6	2	21.77	22±1
				12	11	2	21.76	22±1
				25	0	2	21.81	22±1
	20350	1750.0	QPSK	1	0	0	21.69	22±1
				1	12	0	21.68	22±1
1				24	0	21.58	22±1	
12				0	1	21.71	22±1	
12				6	1	21.69	22±1	
12				11	1	21.65	22±1	
25				0	1	21.62	22±1	
16QAM			1	0	1	21.66	22±1	
			1	12	1	21.65	22±1	
			1	24	1	21.58	22±1	
			12	0	2	21.59	22±1	
			12	6	2	21.57	22±1	
			12	11	2	21.55	22±1	
			25	0	2	21.69	22±1	

BW (MHz)	Ch	Freq. (MHz)	Mode	UL RB Allocation	UL RB Offset	MPR	Average power (dBm)	Tune up Power tolerant
3MHz	19965	1711.5	QPSK	1	0	0	21.99	22 ± 1
				1	7	0	22.02	22 ± 1
				1	14	0	21.95	22 ± 1
				8	0	1	22.00	22 ± 1
				8	4	1	21.99	22 ± 1
				8	7	1	21.97	22 ± 1
				15	0	1	21.97	22 ± 1
			16QAM	1	0	1	21.84	22 ± 1
				1	7	1	21.83	22 ± 1
				1	14	1	21.80	22 ± 1
				8	0	2	21.78	22 ± 1
				8	4	2	21.79	22 ± 1
				8	7	2	21.77	22 ± 1
				15	0	2	21.93	22 ± 1
	20175	1732.5	QPSK	1	0	0	21.81	22 ± 1
				1	7	0	21.82	22 ± 1
				1	14	0	21.76	22 ± 1
				8	0	1	21.81	22 ± 1
				8	4	1	21.80	22 ± 1
				8	7	1	21.79	22 ± 1
				15	0	1	21.80	22 ± 1
			16QAM	1	0	1	21.78	22 ± 1
				1	7	1	21.76	22 ± 1
				1	14	1	21.74	22 ± 1
				8	0	2	21.68	22 ± 1
				8	4	2	21.65	22 ± 1
				8	7	2	21.67	22 ± 1
				15	0	2	21.82	22 ± 1
	20385	1753.5	QPSK	1	0	0	21.43	22 ± 1
				1	7	0	21.46	22 ± 1
1				14	0	21.39	22 ± 1	
8				0	1	21.61	22 ± 1	
8				4	1	21.60	22 ± 1	
8				7	1	21.59	22 ± 1	
15				0	1	21.63	22 ± 1	
16QAM			1	0	1	22.10	22 ± 1	
			1	7	1	22.09	22 ± 1	
			1	14	1	21.99	22 ± 1	
			8	0	2	21.88	22 ± 1	
			8	4	2	21.87	22 ± 1	
			8	7	2	21.89	22 ± 1	
			15	0	2	21.74	22 ± 1	

BW (MHz)	Ch	Freq. (MHz)	Mode	UL RB Allocation	UL RB Offset	MPR	Average power (dBm)	Tune up Power tolerant
1.4MHz	19957	1710.7	QPSK	1	0	0	22.00	22±1
				1	2	0	22.02	22±1
				1	5	0	22.01	22±1
				3	0	0	22.12	22±1
				3	1	0	22.09	22±1
				3	2	0	22.08	22±1
			6	0	1	21.94	22±1	
			16QAM	1	0	1	21.85	22±1
				1	2	1	21.86	22±1
				1	5	1	21.84	22±1
				3	0	1	21.88	22±1
				3	1	1	21.87	22±1
	3	2		1	21.85	22±1		
	20175	1732.5	QPSK	1	0	0	21.82	22±1
				1	2	0	21.84	22±1
				1	5	0	21.77	22±1
				3	0	0	21.83	22±1
				3	1	0	21.85	22±1
				3	2	0	21.88	22±1
			6	0	1	21.72	22±1	
			16QAM	1	0	1	21.78	22±1
				1	2	1	21.86	22±1
				1	5	1	21.78	22±1
				3	0	1	21.68	22±1
				3	1	1	21.66	22±1
	3	2		1	21.65	22±1		
	20393	1754.3	QPSK	1	0	0	21.50	22±1
				1	2	0	21.53	22±1
				1	5	0	21.49	22±1
				3	0	0	21.68	22±1
3				1	0	21.67	22±1	
3				2	0	21.65	22±1	
6			0	1	21.57	22±1		
16QAM			1	0	1	21.22	22±1	
			1	2	1	21.25	22±1	
			1	5	1	21.20	22±1	
			3	0	1	21.15	22±1	
			3	1	1	21.16	22±1	
	3	2	1	21.13	22±1			
6	0	2	21.52	22±1				

LTE Band 5:

BW (MHz)	Ch	Freq. (MHz)	Mode	UL RB Allocation	UL RB Offset	MPR	Average power (dBm)	Tune up Power tolerant
10MHz	20450	829	QPSK	1	0	0	22.78	22±1
				1	24	0	22.73	22±1
				1	49	0	22.74	22±1
				25	0	1	21.84	22±1
				25	12	1	21.86	22±1
				25	24	1	21.88	22±1
				50	0	1	21.86	22±1
			16QAM	1	0	1	22.49	22±1
				1	24	1	22.49	22±1
				1	49	1	22.43	22±1
				25	0	2	21.57	21.3±1
				25	12	2	21.64	21.3±1
				25	24	2	21.48	21.3±1
				50	0	2	20.86	21.3±1
	20525	836.5	QPSK	1	0	0	22.98	22±1
				1	24	0	22.94	22±1
				1	49	0	22.93	22±1
				25	0	1	21.93	22±1
				25	12	1	21.95	22±1
				25	24	1	21.97	22±1
				50	0	1	21.94	22±1
			16QAM	1	0	1	21.84	21.3±1
				1	24	1	21.81	21.3±1
				1	49	1	21.84	21.3±1
				25	0	2	21.24	21.3±1
				25	12	2	21.36	21.3±1
				25	24	2	21.28	21.3±1
				50	0	2	20.93	21.3±1
	20600	844	QPSK	1	0	0	23.01	22.3±1
				1	24	0	22.99	22.3±1
1				49	0	22.94	22.3±1	
25				0	1	21.98	22.3±1	
25				12	1	21.94	22.3±1	
25				24	1	21.98	22.3±1	
50				0	1	21.99	22.3±1	
16QAM			1	0	1	22.03	21.3±1	
			1	24	1	22.00	21.3±1	
			1	49	1	21.97	21.3±1	
			25	0	2	21.39	21.3±1	
			25	12	2	21.42	21.3±1	
			25	24	2	21.27	21.3±1	
			50	0	2	20.98	21.3±1	

BW (MHz)	Ch	Freq. (MHz)	Mode	UL RB Allocation	UL RB Offset	MPR	Average power (dBm)	Tune up Power tolerant
5MHz	20425	826.5	QPSK	1	0	0	22.88	22±1
				1	12	0	22.83	22±1
				1	24	0	22.87	22±1
				12	0	1	21.87	22±1
				12	6	1	21.85	22±1
				12	11	1	21.86	22±1
				25	0	1	21.82	22±1
			16QAM	1	0	1	22.70	22±1
				1	12	1	22.69	22±1
				1	24	1	22.68	22±1
				12	0	2	22.16	22±1
				12	6	2	22.15	22±1
				12	11	2	22.16	22±1
				25	0	2	21.50	22±1
	20525	836.5	QPSK	1	0	0	22.81	22±1
				1	12	0	22.83	22±1
				1	24	0	22.83	22±1
				12	0	1	21.90	22±1
				12	6	1	21.92	22±1
				12	11	1	21.91	22±1
				25	0	1	21.87	22±1
			16QAM	1	0	1	22.28	22±1
				1	12	1	22.29	22±1
				1	24	1	22.30	22±1
				12	0	2	21.69	22±1
				12	6	2	21.67	22±1
				12	11	2	21.65	22±1
				25	0	2	21.83	22±1
	20625	846.5	QPSK	1	0	0	22.99	22.3±1
				1	12	0	23.01	22.3±1
1				24	0	22.98	22.3±1	
12				0	1	21.99	22.3±1	
12				6	1	21.98	22.3±1	
12				11	1	21.97	22.3±1	
25				0	1	21.93	22.3±1	
16QAM			1	0	1	22.08	21.3±1	
			1	12	1	22.09	21.3±1	
			1	24	1	22.05	21.3±1	
			12	0	2	21.22	21.3±1	
			12	6	2	21.19	21.3±1	
			12	11	2	21.17	21.3±1	
			25	0	2	20.91	21.3±1	

BW (MHz)	Ch	Freq. (MHz)	Mode	UL RB Allocation	UL RB Offset	MPR	Average power (dBm)	Tune up Power tolerant
3MHz	20415	825.5	QPSK	1	0	0	22.80	22±1
				1	7	0	22.83	22±1
				1	14	0	22.75	22±1
				8	0	1	21.80	22±1
				8	4	1	21.78	22±1
				8	7	1	21.76	22±1
				15	0	1	21.76	22±1
			16QAM	1	0	1	21.66	21.3±1
				1	7	1	21.67	21.3±1
				1	14	1	21.61	21.3±1
				8	0	2	21.13	21.3±1
				8	4	2	21.11	21.3±1
				8	7	2	21.08	21.3±1
				15	0	2	20.71	21.3±1
	20525	836.5	QPSK	1	0	0	22.81	22±1
				1	7	0	22.86	22±1
				1	14	0	22.81	22±1
				8	0	1	21.85	22±1
				8	4	1	21.87	22±1
				8	7	1	21.86	22±1
				15	0	1	21.81	22±1
			16QAM	1	0	1	21.81	21.3±1
				1	7	1	21.83	21.3±1
				1	14	1	21.81	21.3±1
				8	0	2	21.36	21.3±1
				8	4	2	21.35	21.3±1
				8	7	2	21.32	21.3±1
				15	0	2	20.82	21.3±1
	20635	847.5	QPSK	1	0	0	22.69	22±1
				1	7	0	22.75	22±1
1				14	0	22.65	22±1	
8				0	1	21.93	22±1	
8				4	1	21.91	22±1	
8				7	1	21.92	22±1	
15				0	1	21.93	22±1	
16QAM			1	0	1	22.45	22±1	
			1	7	1	22.49	22±1	
			1	14	1	22.39	22±1	
			8	0	2	21.89	22±1	
			8	4	2	21.87	22±1	
			8	7	2	21.85	22±1	
			15	0	2	21.04	22±1	

BW (MHz)	Ch	Freq. (MHz)	Mode	UL RB Allocation	UL RB Offset	MPR	Average power (dBm)	Tune up Power tolerant
1.4MHz	20407	824.7	QPSK	1	0	0	22.80	22±1
				1	2	0	22.86	22±1
				1	5	0	22.81	22±1
				3	0	0	22.89	22±1
				3	1	0	22.85	22±1
				3	2	0	22.88	22±1
				6	0	1	21.77	21.3±1
			16QAM	1	0	1	21.65	21.3±1
				1	2	1	21.72	21.3±1
				1	5	1	21.67	21.3±1
				3	0	1	21.28	21.3±1
				3	1	1	21.26	21.3±1
				3	2	1	21.25	21.3±1
				6	0	2	20.76	21.3±1
	20525	836.5	QPSK	1	0	0	22.79	22±1
				1	2	0	22.86	22±1
				1	5	0	22.83	22±1
				3	0	0	22.83	22±1
				3	1	0	22.85	22±1
				3	2	0	22.86	22±1
				6	0	1	21.81	22±1
			16QAM	1	0	1	21.81	21.3±1
				1	2	1	21.90	21.3±1
				1	5	1	21.87	21.3±1
				3	0	1	21.41	21.3±1
				3	1	1	21.39	21.3±1
				3	2	1	21.38	21.3±1
				6	0	2	20.70	21.3±1
	20643	848.3	QPSK	1	0	0	22.74	22±1
				1	2	0	22.81	22±1
1				5	0	22.75	22±1	
3				0	0	22.96	22±1	
3				1	0	22.94	22±1	
3				2	0	22.91	22±1	
6				0	1	21.93	22±1	
16QAM			1	0	1	21.52	21.3±1	
			1	2	1	21.61	21.3±1	
			1	5	1	21.53	21.3±1	
			3	0	1	21.25	21.3±1	
			3	1	1	21.28	21.3±1	
			3	2	1	21.24	21.3±1	
			6	0	2	20.87	21.3±1	

LTE Band 7:

BW (MHz)	Ch	Freq. (MHz)	Mode	UL RB Allocation	UL RB Offset	MPR	Average power (dBm)	Tune up Power tolerant
20MHz	20850	2510	QPSK	1	0	0	22.92	23±1
				1	49	0	23.05	23±1
				1	99	0	23.25	23±1
				50	0	1	22.36	23±1
				50	24	1	22.22	23±1
				50	49	1	22.14	23±1
				100	0	1	22.27	23±1
			16QAM	1	0	1	22.34	22±1
				1	49	1	22.47	22±1
				1	99	1	22.64	22±1
				50	0	2	21.89	22±1
				50	24	2	21.87	22±1
				50	49	2	21.85	22±1
				100	0	2	21.21	22±1
	21100	2535	QPSK	1	0	0	23.01	23±1
				1	49	0	23.28	23±1
				1	99	0	23.31	23±1
				50	0	1	22.09	23±1
				50	24	1	22.08	23±1
				50	49	1	22.10	23±1
				100	0	1	22.10	23±1
			16QAM	1	0	1	21.99	22±1
				1	49	1	22.05	22±1
				1	99	1	22.12	22±1
				50	0	2	21.64	22±1
				50	24	2	21.62	22±1
				50	49	2	21.61	22±1
				100	0	2	21.07	22±1
	21350	2560	QPSK	1	0	0	23.29	23±1
				1	49	0	23.65	23±1
1				99	0	22.49	23±1	
50				0	1	22.56	23±1	
50				24	1	22.59	23±1	
50				49	1	22.67	23±1	
100				0	1	22.62	23±1	
16QAM			1	0	1	22.51	22±1	
			1	49	1	22.74	22±1	
			1	99	1	21.86	22±1	
			50	0	2	21.74	22±1	
			50	24	2	21.73	22±1	
			50	49	2	21.71	22±1	
			100	0	2	21.58	22±1	

BW (MHz)	Ch	Freq. (MHz)	Mode	UL RB Allocation	UL RB Offset	MPR	Average power (dBm)	Tune up Power tolerant
15MHz	20825	1717.5	QPSK	1	0	0	22.55	23±1
				1	37	0	22.82	23±1
				1	74	0	23.05	23±1
				36	0	1	22.04	23±1
				36	16	1	22.06	23±1
				36	35	1	22.09	23±1
				75	0	1	22.11	23±1
			16QAM	1	0	1	21.67	22±1
				1	37	1	21.89	22±1
				1	74	1	21.95	22±1
				36	0	2	21.48	22±1
				36	16	2	21.47	22±1
				36	35	2	21.46	22±1
				75	0	2	21.26	22±1
	21100	1732.5	QPSK	1	0	0	22.92	23±1
				1	37	0	23.16	23±1
				1	74	0	23.26	23±1
				36	0	1	22.27	23±1
				36	16	1	22.28	23±1
				36	35	1	22.31	23±1
				75	0	1	22.30	23±1
			16QAM	1	0	1	22.18	22±1
				1	37	1	22.29	22±1
				1	74	1	22.32	22±1
				36	0	2	21.64	22±1
				36	16	2	21.63	22±1
				36	35	2	21.61	22±1
				75	0	2	21.18	22±1
	21375	1747.5	QPSK	1	0	0	23.57	23±1
				1	37	0	23.71	23±1
1				74	0	22.21	23±1	
36				0	1	22.78	23±1	
36				16	1	22.64	23±1	
36				35	1	22.48	23±1	
75				0	1	22.81	23±1	
16QAM			1	0	1	22.96	22.3±1	
			1	37	1	23.11	22.3±1	
			1	74	1	22.08	22.3±1	
			36	0	2	21.94	22.3±1	
			36	16	2	21.92	22.3±1	
			36	35	2	21.89	22.3±1	
			75	0	2	21.72	22.3±1	

BW (MHz)	Ch	Freq. (MHz)	Mode	UL RB Allocation	UL RB Offset	MPR	Average power (dBm)	Tune up Power tolerant
10MHz	20800	2502	QPSK	1	0	0	22.63	22±1
				1	24	0	22.85	22±1
				1	49	0	22.75	22±1
				25	0	1	22.18	22±1
				25	12	1	22.15	22±1
				25	24	1	22.09	22±1
				50	0	1	22.15	22±1
			16QAM	1	0	1	22.05	22±1
				1	24	1	22.37	22±1
				1	49	1	22.24	22±1
				25	0	2	21.56	22±1
				25	12	2	21.52	22±1
				25	24	2	21.51	22±1
				50	0	2	21.09	22±1
	21100	2535	QPSK	1	0	0	23.26	23±1
				1	24	0	23.39	23±1
				1	49	0	23.35	23±1
				25	0	1	22.19	23±1
				25	12	1	22.20	23±1
				25	24	1	22.21	23±1
				50	0	1	22.18	23±1
			16QAM	1	0	1	22.01	22±1
				1	24	1	22.08	22±1
				1	49	1	22.07	22±1
				25	0	2	21.74	22±1
				25	12	2	21.78	22±1
				25	24	2	21.75	22±1
				50	0	2	21.13	22±1
	21400	2565	QPSK	1	0	0	24.26	23.3±1
				1	24	0	23.82	23.3±1
1				49	0	22.57	23.3±1	
25				0	1	23.10	23.3±1	
25				12	1	22.95	23.3±1	
25				24	1	22.70	23.3±1	
50				0	1	23.03	23.3±1	
16QAM			1	0	1	23.07	22.3±1	
			1	24	1	22.98	22.3±1	
			1	49	1	21.72	22.3±1	
			25	0	2	21.64	22.3±1	
			25	12	2	21.62	22.3±1	
			25	24	2	21.57	22.3±1	
			50	0	2	22.01	22.3±1	

BW (MHz)	Ch	Freq. (MHz)	Mode	UL RB Allocation	UL RB Offset	MPR	Average power (dBm)	Tune up Power tolerant
5MHz	19975	1712.5	QPSK	1	0	0	22.77	22±1
				1	12	0	22.62	22±1
				1	24	0	22.98	22±1
				12	0	1	21.90	22±1
				12	6	1	21.98	22±1
				12	11	1	22.06	22±1
				25	0	1	21.99	22±1
			16QAM	1	0	1	21.98	22±1
				1	12	1	21.75	22±1
				1	24	1	22.17	22±1
				12	0	2	21.48	22±1
				12	6	2	21.46	22±1
				12	11	2	21.45	22±1
				25	0	2	21.12	22±1
	20175	1732.5	QPSK	1	0	0	23.29	23±1
				1	12	0	23.27	23±1
				1	24	0	23.33	23±1
				12	0	1	22.26	23±1
				12	6	1	22.27	23±1
				12	11	1	22.28	23±1
				25	0	1	22.21	23±1
			16QAM	1	0	1	22.32	22±1
				1	12	1	22.35	22±1
				1	24	1	22.33	22±1
				12	0	2	21.69	22±1
				12	6	2	21.68	22±1
				12	11	2	21.66	22±1
				25	0	2	21.11	22±1
	20375	1752.5	QPSK	1	0	0	23.94	23±1
				1	12	0	23.03	23±1
1				24	0	22.87	23±1	
12				0	1	22.87	23±1	
12				6	1	22.61	23±1	
12				11	1	22.25	23±1	
25				0	1	22.57	23±1	
16QAM			1	0	1	23.04	22.3±1	
			1	12	1	22.29	22.3±1	
			1	24	1	22.07	22.3±1	
			12	0	2	22.15	22.3±1	
			12	6	2	22.13	22.3±1	
			12	11	2	22.11	22.3±1	
			25	0	2	21.95	22.3±1	

LTE Band 12:

BW (MHz)	Ch	Freq. (MHz)	Mode	UL RB Allocation	UL RB Offset	MPR	Average power (dBm)	Tune up Power tolerant
10MHz	23060	704	QPSK	1	0	0	23.04	22.3±1
				1	24	0	23.01	22.3±1
				1	49	0	23.02	22.3±1
				25	0	1	21.97	22.3±1
				25	12	1	21.96	22.3±1
				25	24	1	21.97	22.3±1
				50	0	1	22.01	22.3±1
			16QAM	1	0	1	21.84	22±1
				1	24	1	21.83	22±1
				1	49	1	21.85	22±1
				25	0	2	21.62	22±1
				25	12	2	21.61	22±1
				25	24	2	21.59	22±1
				50	0	2	21.02	22±1
	23095	707.5	QPSK	1	0	0	23.00	22.3±1
				1	24	0	22.99	22.3±1
				1	49	0	23.03	22.3±1
				25	0	1	21.99	22.3±1
				25	12	1	21.97	22.3±1
				25	24	1	21.94	22.3±1
				50	0	1	22.00	22.3±1
			16QAM	1	0	1	21.96	22±1
				1	24	1	21.97	22±1
				1	49	1	21.92	22±1
				25	0	2	21.61	22±1
				25	12	2	21.53	22±1
				25	24	2	21.51	22±1
				50	0	2	21.04	22±1
	23130	711	QPSK	1	0	0	22.94	22±1
				1	24	0	22.94	22±1
1				49	0	22.88	22±1	
25				0	1	22.01	22±1	
25				12	1	21.98	22±1	
25				24	1	21.95	22±1	
50				0	1	21.96	22±1	
16QAM			1	0	1	22.61	22±1	
			1	24	1	22.47	22±1	
			1	49	1	22.43	22±1	
			25	0	2	21.35	22±1	
			25	12	2	21.33	22±1	
			25	24	2	21.31	22±1	
			50	0	2	21.00	22±1	

BW (MHz)	Ch	Freq. (MHz)	Mode	UL RB Allocation	UL RB Offset	MPR	Average power (dBm)	Tune up Power tolerant
5MHz	23035	701.5	QPSK	1	0	0	23.12	22.3±1
				1	12	0	23.09	22.3±1
				1	24	0	23.07	22.3±1
				12	0	1	22.01	22.3±1
				12	6	1	22.02	22.3±1
				12	11	1	22.00	22.3±1
			25	0	1	21.94	22.3±1	
			16QAM	1	0	1	22.04	21.3±1
				1	12	1	22.01	21.3±1
				1	24	1	22.03	21.3±1
				12	0	2	21.42	21.3±1
				12	6	2	21.41	21.3±1
	12	11		2	21.39	21.3±1		
	23095	707.5	QPSK	1	0	0	22.96	22±1
				1	12	0	22.95	22±1
				1	24	0	22.95	22±1
				12	0	1	22.05	22±1
				12	6	1	22.03	22±1
				12	11	1	22.04	22±1
			25	0	1	21.99	22±1	
			16QAM	1	0	1	22.35	22±1
				1	12	1	22.37	22±1
				1	24	1	22.27	22±1
				12	0	2	21.68	22±1
				12	6	2	21.65	22±1
	12	11		2	21.64	22±1		
	25	0	2	21.00	22±1			
23155	713.5	QPSK	1	0	0	23.07	22.3±1	
			1	12	0	23.05	22.3±1	
			1	24	0	22.99	22.3±1	
			12	0	1	22.03	22.3±1	
			12	6	1	22.01	22.3±1	
			12	11	1	21.98	22.3±1	
		25	0	1	21.99	22.3±1		
		16QAM	1	0	1	21.97	22±1	
			1	12	1	21.96	22±1	
			1	24	1	21.96	22±1	
			12	0	2	21.67	22±1	
			12	6	2	21.64	22±1	
12	11		2	21.65	22±1			
25	0	2	21.09	22±1				

BW (MHz)	Ch	Freq. (MHz)	Mode	UL RB Allocation	UL RB Offset	MPR	Average power (dBm)	Tune up Power tolerant
3MHz	23025	700.5	QPSK	1	0	0	22.96	22.3±1
				1	7	0	23.04	22.3±1
				1	14	0	22.95	22.3±1
				8	0	1	21.97	22.3±1
				8	4	1	21.95	22.3±1
				8	7	1	21.97	22.3±1
			15	0	1	21.95	22.3±1	
			16QAM	1	0	1	21.80	21.3±1
			16QAM	1	7	1	21.84	21.3±1
			16QAM	1	14	1	21.77	21.3±1
			16QAM	8	0	2	21.21	21.3±1
			16QAM	8	4	2	21.19	21.3±1
	16QAM	8	7	2	21.20	21.3±1		
	16QAM	15	0	2	20.91	21.3±1		
	23095	707.5	QPSK	1	0	0	22.97	22±1
	1			7	0	22.99	22±1	
	1			14	0	22.96	22±1	
	8			0	1	22.00	22±1	
	8			4	1	21.97	22±1	
	8			7	1	21.95	22±1	
	15		0	1	21.98	22±1		
	16QAM		1	0	1	21.97	22±1	
	16QAM		1	7	1	21.96	22±1	
	16QAM		1	14	1	21.94	22±1	
	16QAM		8	0	2	21.23	22±1	
	16QAM		8	4	2	21.38	22±1	
	16QAM	8	7	2	21.24	22±1		
	16QAM	15	0	2	21.02	22±1		
	23025	714.5	QPSK	1	0	0	23.07	22.3±1
	1			7	0	23.09	22.3±1	
1	14			0	22.99	22.3±1		
8	0			1	22.01	22.3±1		
8	4			1	21.98	22.3±1		
8	7			1	21.97	22.3±1		
15	0		1	21.99	22.3±1			
16QAM	1		0	1	21.84	21.3±1		
16QAM	1		7	1	21.87	21.3±1		
16QAM	1		14	1	21.83	21.3±1		
16QAM	8		0	2	21.64	21.3±1		
16QAM	8		4	2	21.63	21.3±1		
16QAM	8	7	2	21.65	21.3±1			
16QAM	15	0	2	20.95	21.3±1			

BW (MHz)	Ch	Freq. (MHz)	Mode	UL RB Allocation	UL RB Offset	MPR	Average power (dBm)	Tune up Power tolerant
1.4MHz	23017	699.7	QPSK	1	0	0	22.98	22.3±1
				1	2	0	23.05	22.3±1
				1	5	0	23.00	22.3±1
				3	0	0	23.07	22.3±1
				3	1	0	23.06	22.3±1
				3	2	0	23.04	22.3±1
			6	0	1	21.93	22.3±1	
			16QAM	1	0	1	21.80	21.3±1
				1	2	1	21.87	21.3±1
				1	5	1	21.81	21.3±1
				3	0	1	21.36	21.3±1
				3	1	1	21.34	21.3±1
	3	2		1	21.33	21.3±1		
	6	0	2	20.94	21.3±1			
	23095	707.5	QPSK	1	0	0	22.96	22.3±1
				1	2	0	23.01	22.3±1
				1	5	0	22.95	22.3±1
				3	0	0	23.06	22.3±1
				3	1	0	23.05	22.3±1
				3	2	0	23.02	22.3±1
			6	0	1	21.87	22.3±1	
			16QAM	1	0	1	21.95	21.3±1
				1	2	1	22.01	21.3±1
				1	5	1	21.96	21.3±1
				3	0	1	21.47	21.3±1
				3	1	1	21.46	21.3±1
	3	2		1	21.44	21.3±1		
	6	0	2	20.80	21.3±1			
	23173	715.3	QPSK	1	0	0	22.90	22.3±1
				1	2	0	22.97	22.3±1
1				5	0	21.90	22.3±1	
3				0	0	23.07	22.3±1	
3				1	0	23.06	22.3±1	
3				2	0	23.08	22.3±1	
6			0	1	21.95	22.3±1		
16QAM			1	0	1	21.57	21.3±1	
			1	2	1	21.66	21.3±1	
			1	5	1	21.60	21.3±1	
			3	0	1	21.45	21.3±1	
			3	1	1	21.43	21.3±1	
	3	2	1	21.44	21.3±1			
6	0	2	20.90	21.3±1				

LTE Band 17:

BW (MHz)	Ch	Freq. (MHz)	Mode	UL RB Allocation	UL RB Offset	MPR	Average power (dBm)	Tune up Power tolerant
10MHz	23780	709.0	QPSK	1	0	0	23.17	23±1
				1	24	0	23.15	23±1
				1	49	0	23.16	23±1
				25	0	1	22.16	23±1
				25	12	1	22.14	23±1
				25	24	1	22.15	23±1
				50	0	1	22.18	23±1
			16QAM	1	0	1	22.76	22±1
				1	24	1	22.73	22±1
				1	49	1	22.63	22±1
				25	0	2	21.78	22±1
				25	12	2	21.75	22±1
				25	24	2	21.76	22±1
				50	0	2	21.24	22±1
	23790	701.0	QPSK	1	0	0	23.16	23±1
				1	24	0	23.15	23±1
				1	49	0	23.10	23±1
				25	0	1	22.15	23±1
				25	12	1	22.14	23±1
				25	24	1	22.15	23±1
				50	0	1	22.15	23±1
			16QAM	1	0	1	22.07	22±1
				1	24	1	22.01	22±1
				1	49	1	21.99	22±1
				25	0	2	21.65	22±1
				25	12	2	21.63	22±1
				25	24	2	21.64	22±1
50				0	2	21.20	22±1	
23800	711.0	QPSK	1	0	0	23.14	23±1	
			1	24	0	23.15	23±1	
			1	49	0	23.07	23±1	
			25	0	1	22.16	23±1	
			25	12	1	22.15	23±1	
			25	24	1	22.13	23±1	
			50	0	1	22.16	23±1	
			16QAM	1	0	1	22.19	22±1
		1		24	1	22.11	22±1	
		1		49	1	22.08	22±1	
		25		0	2	21.84	22±1	
		25		12	2	21.86	22±1	
		25		24	2	21.87	22±1	
		50		0	2	21.23	22±1	

BW (MHz)	Ch	Freq. (MHz)	Mode	UL RB Allocation	UL RB Offset	MPR	Average power (dBm)	Tune up Power tolerant
5MHz	23755	706.5	QPSK	1	0	0	23.22	23±1
				1	12	0	23.23	23±1
				1	24	0	23.22	23±1
				12	0	1	22.25	23±1
				12	6	1	22.23	23±1
				12	11	1	22.00	23±1
			25	0	1	22.17	23±1	
			16QAM	1	0	1	22.29	22±1
				1	12	1	22.31	22±1
				1	24	1	22.25	22±1
				12	0	2	21.69	22±1
				12	6	2	21.68	22±1
	12	11		2	21.66	22±1		
	25	0	2	21.24	22±1			
	23790	710.0	QPSK	1	0	0	23.07	23±1
				1	12	0	23.12	23±1
				1	24	0	23.09	23±1
				12	0	1	22.20	23±1
				12	6	1	22.19	23±1
				12	11	1	22.20	23±1
			25	0	1	22.15	23±1	
			16QAM	1	0	1	22.54	22±1
				1	12	1	22.52	22±1
				1	24	1	22.47	22±1
				12	0	2	22.14	22±1
				12	6	2	22.12	22±1
	12	11		2	22.11	22±1		
	25	0	2	21.17	22±1			
	23825	713.5	QPSK	1	0	0	23.16	23±1
				1	12	0	23.14	23±1
1				24	0	23.09	23±1	
12				0	1	22.21	23±1	
12				6	1	22.19	23±1	
12				11	1	22.17	23±1	
25			0	1	22.18	23±1		
16QAM			1	0	1	22.15	22±1	
			1	12	1	22.11	22±1	
			1	24	1	22.09	22±1	
			12	0	2	21.87	22±1	
			12	6	2	21.85	22±1	
	12	11	2	21.84	22±1			
25	0	2	21.35	22±1				

ERP & EIRP

EIRP for LTE Band 2 (Part 24E)

Frequency (MHz)	BW (MHz)	Modulation	RB Size/Offset	Substituted level (dBm)	Antenna Polarization	Antenna Gain correction (dBi)	Cable Loss (dB)	Absolute Level (dBm)	Limit (dBm)
1850.7	1.4	QPSK	1/0	19.56	V	7.88	0.85	26.59	33.01
1880	1.4	QPSK	1/0	17.72	V	7.88	0.85	24.75	33.01
1909.3	1.4	QPSK	1/0	19.48	V	7.88	0.85	26.51	33.01
1850.7	1.4	QPSK	1/0	17.65	H	7.88	0.85	24.68	33.01
1880	1.4	QPSK	1/0	19.62	H	7.88	0.85	26.65	33.01
1909.3	1.4	QPSK	1/0	17.77	H	7.88	0.85	24.80	33.01
1850.7	1.4	16-QAM	1/0	18.74	V	7.88	0.85	25.77	33.01
1880	1.4	16-QAM	1/0	17.19	V	7.88	0.85	24.22	33.01
1909.3	1.4	16-QAM	1/0	18.83	V	7.88	0.85	25.86	33.01
1850.7	1.4	16-QAM	1/0	17.22	H	7.88	0.85	24.25	33.01
1880	1.4	16-QAM	1/0	18.79	H	7.88	0.85	25.82	33.01
1909.3	1.4	16-QAM	1/0	17.16	H	7.88	0.85	24.19	33.01
1851.5	3	QPSK	1/0	19.55	V	7.88	0.85	26.58	33.01
1880	3	QPSK	1/0	19.56	V	7.88	0.85	26.59	33.01
1908.5	3	QPSK	1/0	19.48	V	7.88	0.85	26.51	33.01
1851.5	3	QPSK	1/0	17.81	H	7.88	0.85	24.84	33.01
1880	3	QPSK	1/0	17.76	H	7.88	0.85	24.79	33.01
1908.5	3	QPSK	1/0	17.84	H	7.88	0.85	24.87	33.01
1851.5	3	16-QAM	1/0	18.69	V	7.88	0.85	25.72	33.01
1880	3	16-QAM	1/0	18.72	V	7.88	0.85	25.75	33.01
1908.5	3	16-QAM	1/0	18.63	V	7.88	0.85	25.66	33.01
1851.5	3	16-QAM	1/0	17.11	H	7.88	0.85	24.14	33.01
1880	3	16-QAM	1/0	17.09	H	7.88	0.85	24.12	33.01
1908.5	3	16-QAM	1/0	17.15	H	7.88	0.85	24.18	33.01
1852.5	5	QPSK	1/24	19.71	V	7.88	0.85	26.74	33.01
1880	5	QPSK	1/0	19.66	V	7.88	0.85	26.69	33.01
1907.5	5	QPSK	1/24	19.75	V	7.88	0.85	26.78	33.01
1852.5	5	QPSK	1/24	18.05	H	7.88	0.85	25.08	33.01
1880	5	QPSK	1/0	18.12	H	7.88	0.85	25.15	33.01
1907.5	5	QPSK	1/24	18.09	H	7.88	0.85	25.12	33.01
1852.5	5	16-QAM	1/24	18.74	V	7.88	0.85	25.77	33.01
1880	5	16-QAM	1/0	18.66	V	7.88	0.85	25.69	33.01

1907.5	5	16-QAM	1/24	18.73	V	7.88	0.85	25.76	33.01
1852.5	5	16-QAM	1/24	17.15	H	7.88	0.85	24.18	33.01
1880	5	16-QAM	1/0	17.21	H	7.88	0.85	24.24	33.01
1907.5	5	16-QAM	1/24	17.19	H	7.88	0.85	24.22	33.01
1855	10	QPSK	1/0	19.62	V	7.88	0.85	26.65	33.01
1880	10	QPSK	1/0	19.68	V	7.88	0.85	26.71	33.01
1905	10	QPSK	1/49	19.64	V	7.88	0.85	26.67	33.01
1855	10	QPSK	1/0	17.89	H	7.88	0.85	24.92	33.01
1880	10	QPSK	1/0	17.95	H	7.88	0.85	24.98	33.01
1905	10	QPSK	1/49	17.86	H	7.88	0.85	24.89	33.01
1855	10	16-QAM	1/0	18.69	V	7.88	0.85	25.72	33.01
1880	10	16-QAM	1/0	18.73	V	7.88	0.85	25.76	33.01
1905	10	16-QAM	1/49	16.68	V	7.88	0.85	23.71	33.01
1855	10	16-QAM	1/0	17.15	H	7.88	0.85	24.18	33.01
1880	10	16-QAM	1/0	17.12	H	7.88	0.85	24.15	33.01
1905	10	16-QAM	1/49	17.21	H	7.88	0.85	24.24	33.01
1857.5	15	QPSK	1/0	19.73	V	7.88	0.85	26.76	33.01
1880	15	QPSK	1/0	19.68	V	7.88	0.85	26.71	33.01
1902.5	15	QPSK	1/0	19.72	V	7.88	0.85	26.75	33.01
1857.5	15	QPSK	1/0	18.15	H	7.88	0.85	25.18	33.01
1880	15	QPSK	1/0	18.19	H	7.88	0.85	25.22	33.01
1902.5	15	QPSK	1/0	18.13	H	7.88	0.85	25.16	33.01
1857.5	15	16-QAM	1/0	18.84	V	7.88	0.85	25.87	33.01
1880	15	16-QAM	1/0	18.79	V	7.88	0.85	25.82	33.01
1902.5	15	16-QAM	1/0	18.83	V	7.88	0.85	25.86	33.01
1857.5	15	16-QAM	1/0	17.11	H	7.88	0.85	24.14	33.01
1880	15	16-QAM	1/0	17.06	H	7.88	0.85	24.09	33.01
1902.5	15	16-QAM	1/0	17.13	H	7.88	0.85	24.16	33.01
1860	20	QPSK	1/0	19.75	V	7.88	0.85	26.78	33.01
1880	20	QPSK	1/0	19.78	V	7.88	0.85	26.81	33.01
1900	20	QPSK	1/0	19.81	V	7.88	0.85	26.84	33.01
1860	20	QPSK	1/0	18.16	H	7.88	0.85	25.19	33.01
1880	20	QPSK	1/0	18.22	H	7.88	0.85	25.25	33.01
1900	20	QPSK	1/0	18.19	H	7.88	0.85	25.22	33.01
1860	20	16-QAM	1/0	18.94	V	7.88	0.85	25.97	33.01
1880	20	16-QAM	1/0	18.89	V	7.88	0.85	25.92	33.01
1900	20	16-QAM	1/0	18.92	V	7.88	0.85	25.95	33.01
1860	20	16-QAM	1/0	17.18	H	7.88	0.85	24.21	33.01

Test Report	15071166-FCC-R5
Page	41 of 148

1880	20	16-QAM	1/0	17.23	H	7.88	0.85	24.26	33.01
1900	20	16-QAM	1/0	17.19	H	7.88	0.85	24.22	33.01

EIRP for LTE Band 4 (Part 27)

Frequency (MHz)	BW (MHz)	Modulation	RB Size/Offset	Substituted level (dBm)	Antenna Polarization	Antenna Gain correction (dBi)	Cable Loss (dB)	Absolute Level (dBm)	Limit (dBm)
1710.7	1.4	QPSK	1/0	18.45	V	7.95	0.79	25.61	30
1732.5	1.4	QPSK	1/0	18.49	V	7.95	0.79	25.65	30
1754.3	1.4	QPSK	1/0	18.41	V	7.95	0.79	25.57	30
1710.7	1.4	QPSK	1/0	16.67	H	7.95	0.79	23.83	30
1732.5	1.4	QPSK	1/0	16.72	H	7.95	0.79	23.88	30
1754.3	1.4	QPSK	1/0	16.64	H	7.95	0.79	23.80	30
1710.7	1.4	16-QAM	1/5	17.69	V	7.95	0.79	24.85	30
1732.5	1.4	16-QAM	1/0	17.72	V	7.95	0.79	24.88	30
1754.3	1.4	16-QAM	1/0	17.64	V	7.95	0.79	24.80	30
1710.7	1.4	16-QAM	1/5	16.15	H	7.95	0.79	23.31	30
1732.5	1.4	16-QAM	1/0	16.08	H	7.95	0.79	23.24	30
1754.3	1.4	16-QAM	1/0	16.11	H	7.95	0.79	23.27	30
1711.5	3	QPSK	1/0	18.29	V	7.95	0.79	25.45	30
1732.5	3	QPSK	1/0	18.22	V	7.95	0.79	25.38	30
1753.5	3	QPSK	1/0	18.16	V	7.95	0.79	25.32	30
1711.5	3	QPSK	1/0	16.58	H	7.95	0.79	23.74	30
1732.5	3	QPSK	1/0	16.51	H	7.95	0.79	23.67	30
1753.5	3	QPSK	1/0	16.55	H	7.95	0.79	23.71	30
1711.5	3	16-QAM	1/0	17.43	V	7.95	0.79	24.59	30
1732.5	3	16-QAM	1/0	17.39	V	7.95	0.79	24.55	30
1753.5	3	16-QAM	1/0	17.45	V	7.95	0.79	24.61	30
1711.5	3	16-QAM	1/0	15.88	H	7.95	0.79	23.04	30
1732.5	3	16-QAM	1/0	15.92	H	7.95	0.79	23.08	30
1753.5	3	16-QAM	1/0	15.86	H	7.95	0.79	23.02	30
1712.5	5	QPSK	1/0	18.34	V	7.95	0.79	25.50	30
1732.5	5	QPSK	1/0	18.29	V	7.95	0.79	25.45	30
1752.5	5	QPSK	1/24	18.31	V	7.95	0.79	25.47	30
1712.5	5	QPSK	1/0	16.75	H	7.95	0.79	23.91	30
1732.5	5	QPSK	1/0	16.79	H	7.95	0.79	23.95	30
1752.5	5	QPSK	1/24	16.68	H	7.95	0.79	23.84	30
1712.5	5	16-QAM	1/0	17.59	V	7.95	0.79	24.75	30
1732.5	5	16-QAM	1/0	17.55	V	7.95	0.79	24.71	30
1752.5	5	16-QAM	1/24	17.52	V	7.95	0.79	24.68	30

1712.5	5	16-QAM	1/0	15.93	H	7.95	0.79	23.09	30
1732.5	5	16-QAM	1/0	15.89	H	7.95	0.79	23.05	30
1752.5	5	16-QAM	1/24	15.91	H	7.95	0.79	23.07	30
1715	10	QPSK	1/0	18.43	V	7.95	0.79	25.59	30
1732.5	10	QPSK	1/49	18.37	V	7.95	0.79	25.53	30
1750	10	QPSK	1/0	18.29	V	7.95	0.79	25.45	30
1715	10	QPSK	1/0	16.88	H	7.95	0.79	24.04	30
1732.5	10	QPSK	1/49	16.92	H	7.95	0.79	24.08	30
1750	10	QPSK	1/0	16.85	H	7.95	0.79	24.01	30
1715	10	16-QAM	1/0	17.73	V	7.95	0.79	24.89	30
1732.5	10	16-QAM	1/49	17.68	V	7.95	0.79	24.84	30
1750	10	16-QAM	1/0	17.62	V	7.95	0.79	24.78	30
1715	10	16-QAM	1/0	16.22	H	7.95	0.79	23.38	30
1732.5	10	16-QAM	1/49	16.23	H	7.95	0.79	23.39	30
1750	10	16-QAM	1/0	16.15	H	7.95	0.79	23.31	30
1717.5	15	QPSK	1/0	18.38	V	7.95	0.79	25.54	30
1732.5	15	QPSK	1/74	18.41	V	7.95	0.79	25.57	30
1747.5	15	QPSK	1/0	18.31	V	7.95	0.79	25.47	30
1717.5	15	QPSK	1/0	16.85	H	7.95	0.79	24.01	30
1732.5	15	QPSK	1/74	16.88	H	7.95	0.79	24.04	30
1747.5	15	QPSK	1/0	16.81	H	7.95	0.79	23.97	30
1717.5	15	16-QAM	1/0	17.52	V	7.95	0.79	24.68	30
1732.5	15	16-QAM	1/74	17.56	V	7.95	0.79	24.72	30
1747.5	15	16-QAM	1/0	17.49	V	7.95	0.79	24.65	30
1717.5	15	16-QAM	1/0	16.05	H	7.95	0.79	23.21	30
1732.5	15	16-QAM	1/74	16.09	H	7.95	0.79	23.25	30
1747.5	15	16-QAM	1/0	16.02	H	7.95	0.79	23.18	30
1720	20	QPSK	1/99	18.76	V	7.95	0.79	25.92	30
1732.5	20	QPSK	1/99	18.52	V	7.95	0.79	25.68	30
1745	20	QPSK	1/0	18.25	V	7.95	0.79	25.41	30
1720	20	QPSK	1/99	17.24	H	7.95	0.79	24.40	30
1732.5	20	QPSK	1/99	17.13	H	7.95	0.79	24.29	30
1745	20	QPSK	1/0	17.01	H	7.95	0.79	24.17	30
1720	20	16-QAM	1/99	18.12	V	7.95	0.79	25.28	30
1732.5	20	16-QAM	1/99	17.68	V	7.95	0.79	24.84	30
1745	20	16-QAM	1/0	17.73	V	7.95	0.79	24.89	30
1720	20	16-QAM	1/99	16.59	H	7.95	0.79	23.75	30
1732.5	20	16-QAM	1/99	16.24	H	7.95	0.79	23.40	30

Test Report	15071166-FCC-R5
Page	44 of 148

1745	20	16-QAM	1/0	16.03	H	7.95	0.79	23.19	30
------	----	--------	-----	-------	---	------	------	-------	----

EIRP for LTE Band 5 (Part 22)

Frequency (MHz)	BW (MHz)	Modulation	RB Size/Offset	Substituted level (dBm)	Antenna Polarization	Antenna Gain correction (dBi)	Cable Loss (dB)	Absolute Level (dBm)	Limit (dBm)
824.7	1.4	QPSK	1/5	17.95	V	6.8	0.44	24.31	34.77
836.5	1.4	QPSK	1/5	17.98	V	6.8	0.44	24.34	34.77
848.3	1.4	QPSK	1/5	17.91	V	6.9	0.44	24.37	34.77
824.7	1.4	QPSK	1/5	16.24	H	6.8	0.44	22.60	34.77
836.5	1.4	QPSK	1/5	16.25	H	6.8	0.44	22.61	34.77
848.3	1.4	QPSK	1/5	16.21	H	6.9	0.44	22.67	34.77
824.7	1.4	16-QAM	1/5	16.84	V	6.8	0.44	23.20	34.77
836.5	1.4	16-QAM	1/5	16.92	V	6.8	0.44	23.28	34.77
848.3	1.4	16-QAM	1/5	16.88	V	6.9	0.44	23.34	34.77
824.7	1.4	16-QAM	1/5	15.16	H	6.8	0.44	21.52	34.77
836.5	1.4	16-QAM	1/5	15.09	H	6.8	0.44	21.45	34.77
848.3	1.4	16-QAM	1/5	15.11	H	6.9	0.44	21.57	34.77
825.5	3	QPSK	1/14	17.82	V	6.8	0.44	24.18	34.77
836.5	3	QPSK	1/0	17.76	V	6.8	0.44	24.12	34.77
847.5	3	QPSK	1/14	17.83	V	6.9	0.44	24.29	34.77
825.5	3	QPSK	1/14	16.22	H	6.8	0.44	22.58	34.77
836.5	3	QPSK	1/0	16.15	H	6.8	0.44	22.51	34.77
847.5	3	QPSK	1/14	16.08	H	6.9	0.44	22.54	34.77
825.5	3	16-QAM	1/14	16.94	V	6.8	0.44	23.30	34.77
836.5	3	16-QAM	1/0	16.89	V	6.8	0.44	23.25	34.77
847.5	3	16-QAM	1/14	16.86	V	6.9	0.44	23.32	34.77
825.5	3	16-QAM	1/14	15.31	H	6.8	0.44	21.67	34.77
836.5	3	16-QAM	1/0	15.26	H	6.8	0.44	21.62	34.77
847.5	3	16-QAM	1/14	15.24	H	6.9	0.44	21.70	34.77
826.5	5	QPSK	1/24	18.05	V	6.8	0.44	24.41	34.77
836.5	5	QPSK	1/24	17.96	V	6.8	0.44	24.32	34.77
846.5	5	QPSK	1/24	18.01	V	6.8	0.44	24.37	34.77
826.5	5	QPSK	1/24	16.43	H	6.8	0.44	22.79	34.77
836.5	5	QPSK	1/24	16.41	H	6.8	0.44	22.77	34.77
846.5	5	QPSK	1/24	16.38	H	6.8	0.44	22.74	34.77
826.5	5	16-QAM	1/24	17.15	V	6.8	0.44	23.51	34.77
836.5	5	16-QAM	1/24	17.03	V	6.8	0.44	23.39	34.77
846.5	5	16-QAM	1/24	17.15	V	6.8	0.44	23.51	34.77

826.5	5	16-QAM	1/24	15.68	H	6.8	0.44	22.04	34.77
836.5	5	16-QAM	1/24	15.63	H	6.8	0.44	21.99	34.77
846.5	5	16-QAM	1/24	15.59	H	6.8	0.44	21.95	34.77
829	10	QPSK	1/49	18.15	V	6.8	0.44	24.51	34.77
836.5	10	QPSK	1/49	18.08	V	6.8	0.44	24.44	34.77
844	10	QPSK	1/49	18.11	V	6.8	0.44	24.47	34.77
829	10	QPSK	1/49	16.59	H	6.8	0.44	22.95	34.77
836.5	10	QPSK	1/49	16.55	H	6.8	0.44	22.91	34.77
844	10	QPSK	1/49	16.56	H	6.8	0.44	22.92	34.77
829	10	16-QAM	1/49	17.22	V	6.8	0.44	23.58	34.77
836.5	10	16-QAM	1/49	17.15	V	6.8	0.44	23.51	34.77
844	10	16-QAM	1/49	17.09	V	6.8	0.44	23.45	34.77
829	10	16-QAM	1/49	15.49	H	6.8	0.44	21.85	34.77
836.5	10	16-QAM	1/49	17.52	H	6.8	0.44	23.88	34.77
844	10	16-QAM	1/49	17.56	H	6.8	0.44	23.92	34.77

ERP for LTE Band 7 (Part 27)

Frequency (MHz)	BW (MHz)	Modulation	RB Size/Offset	Substituted level (dBm)	Antenna Polarization	Antenna Gain correction (dBi)	Cable Loss (dB)	Absolute Level (dBm)	Limit (dBm)
2502.5	5	QPSK	1/0	18.96	V	8.93	0.83	27.06	30
2535	5	QPSK	1/0	19.13	V	8.93	0.83	27.23	30
2567.5	5	QPSK	1/24	19.24	V	8.93	0.83	27.34	30
2502.5	5	QPSK	1/0	17.25	H	8.93	0.83	25.35	30
2535	5	QPSK	1/0	17.49	H	8.93	0.83	25.59	30
2567.5	5	QPSK	1/24	17.61	H	8.93	0.83	25.71	30
2502.5	5	16-QAM	1/0	18.06	V	8.93	0.83	26.16	30
2535	5	16-QAM	1/0	18.11	V	8.93	0.83	26.21	30
2567.5	5	16-QAM	1/24	18.19	V	8.93	0.83	26.29	30
2502.5	5	16-QAM	1/0	16.73	H	8.93	0.83	24.83	30
2535	5	16-QAM	1/0	16.75	H	8.93	0.83	24.85	30
2567.5	5	16-QAM	1/24	16.79	H	8.93	0.83	24.89	30
2505	10	QPSK	1/0	18.92	V	8.93	0.83	27.02	30
2535	10	QPSK	1/49	19.05	V	8.93	0.83	27.15	30
2565	10	QPSK	1/0	19.11	V	8.93	0.83	27.21	30
2505	10	QPSK	1/0	17.34	H	8.93	0.83	25.44	30
2535	10	QPSK	1/49	17.45	H	8.93	0.83	25.55	30
2565	10	QPSK	1/0	17.56	H	8.93	0.83	25.66	30
2505	10	16-QAM	1/0	17.95	V	8.93	0.83	26.05	30
2535	10	16-QAM	1/49	18.02	V	8.93	0.83	26.12	30
2565	10	16-QAM	1/0	18.09	V	8.93	0.83	26.19	30
2505	10	16-QAM	1/0	16.52	H	8.93	0.83	24.62	30
2535	10	16-QAM	1/49	16.59	H	8.93	0.83	24.69	30
2565	10	16-QAM	1/0	16.66	H	8.93	0.83	24.76	30
2507.5	15	QPSK	1/0	18.86	V	8.93	0.83	26.96	30
2535	15	QPSK	1/74	19.15	V	8.93	0.83	27.25	30
2562.5	15	QPSK	1/0	19.21	V	8.93	0.83	27.31	30
2507.5	15	QPSK	1/0	17.21	H	8.93	0.83	25.31	30
2535	15	QPSK	1/74	17.43	H	8.93	0.83	25.53	30
2562.5	15	QPSK	1/0	17.59	H	8.93	0.83	25.69	30
2507.5	15	16-QAM	1/0	17.95	V	8.93	0.83	26.05	30
2535	15	16-QAM	1/74	18.06	V	8.93	0.83	26.16	30
2562.5	15	16-QAM	1/0	18.15	V	8.93	0.83	26.25	30

2507.5	15	16-QAM	1/0	16.43	H	8.93	0.83	24.53	30
2535	15	16-QAM	1/74	16.52	H	8.93	0.83	24.62	30
2562.5	15	16-QAM	1/0	16.61	H	8.93	0.83	24.71	30
2510	20	QPSK	1/99	18.86	V	8.93	0.83	26.96	30
2535	20	QPSK	1/99	18.95	V	8.93	0.83	27.05	30
2560	20	QPSK	1/0	19.04	V	8.93	0.83	27.14	30
2510	20	QPSK	1/99	17.28	H	8.93	0.83	25.38	30
2535	20	QPSK	1/99	17.41	H	8.93	0.83	25.51	30
2560	20	QPSK	1/0	17.56	H	8.93	0.83	25.66	30
2510	20	16-QAM	1/99	17.98	V	8.93	0.83	26.08	30
2535	20	16-QAM	1/99	18.05	V	8.93	0.83	26.15	30
2560	20	16-QAM	1/0	18.12	V	8.93	0.83	26.22	30
2510	20	16-QAM	1/99	16.55	H	8.93	0.83	24.65	30
2535	20	16-QAM	1/99	16.61	H	8.93	0.83	24.71	30
2560	20	16-QAM	1/0	16.67	H	8.93	0.83	24.77	30

ERP for LTE Band 12 (Part 27)

Frequency (MHz)	BW (MHz)	Modulation	RB Size/Offset	Substituted level (dBm)	Antenna Polarization	Antenna Gain correction (dBi)	Cable Loss (dB)	Absolute Level (dBm)	Limit (dBm)
699.7	1.4	QPSK	1/5	17.86	V	6.9	0.42	24.34	34.77
707.5	1.4	QPSK	1/5	17.91	V	6.8	0.42	24.29	34.77
715.3	1.4	QPSK	1/5	17.89	V	6.8	0.42	24.27	34.77
699.7	1.4	QPSK	1/5	16.48	H	6.9	0.42	22.96	34.77
707.5	1.4	QPSK	1/5	16.52	H	6.8	0.42	22.90	34.77
715.3	1.4	QPSK	1/5	16.44	H	6.8	0.42	22.82	34.77
699.7	1.4	16-QAM	1/5	17.15	V	6.9	0.42	23.63	34.77
707.5	1.4	16-QAM	1/5	17.19	V	6.8	0.42	23.57	34.77
715.3	1.4	16-QAM	1/5	17.06	V	6.8	0.42	23.44	34.77
699.7	1.4	16-QAM	1/5	15.63	H	6.9	0.42	22.11	34.77
707.5	1.4	16-QAM	1/5	15.68	H	6.8	0.42	22.06	34.77
715.3	1.4	16-QAM	1/5	15.59	H	6.8	0.42	21.97	34.77
700.5	3	QPSK	1/14	17.91	V	6.9	0.42	24.39	34.77
707.5	3	QPSK	1/0	17.86	V	6.8	0.42	24.24	34.77
714.5	3	QPSK	1/14	17.88	V	6.8	0.42	24.26	34.77
700.5	3	QPSK	1/14	16.55	H	6.9	0.42	23.03	34.77
707.5	3	QPSK	1/0	16.57	H	6.8	0.42	22.95	34.77
714.5	3	QPSK	1/14	15.53	H	6.8	0.42	21.91	34.77
700.5	3	16-QAM	1/14	17.03	V	6.9	0.42	23.51	34.77
707.5	3	16-QAM	1/0	17.08	V	6.8	0.42	23.46	34.77
714.5	3	16-QAM	1/14	17.04	V	6.8	0.42	23.42	34.77
700.5	3	16-QAM	1/14	15.62	H	6.9	0.42	22.10	34.77
707.5	3	16-QAM	1/0	15.64	H	6.8	0.42	22.02	34.77
714.5	3	16-QAM	1/14	15.68	H	6.8	0.42	22.06	34.77
701.5	5	QPSK	1/24	17.84	V	6.9	0.42	24.32	34.77
707.5	5	QPSK	1/24	17.79	V	6.8	0.42	24.17	34.77
713.5	5	QPSK	1/24	18.83	V	6.8	0.42	25.21	34.77
701.5	5	QPSK	1/24	16.24	H	6.9	0.42	22.72	34.77
707.5	5	QPSK	1/24	16.29	H	6.8	0.42	22.67	34.77
713.5	5	QPSK	1/24	16.21	H	6.8	0.42	22.59	34.77
701.5	5	16-QAM	1/24	17.11	V	6.9	0.42	23.59	34.77
707.5	5	16-QAM	1/24	17.15	V	6.8	0.42	23.53	34.77
713.5	5	16-QAM	1/24	17.08	V	6.8	0.42	23.46	34.77
701.5	5	16-QAM	1/24	15.59	H	6.9	0.42	22.07	34.77

707.5	5	16-QAM	1/24	15.62	H	6.8	0.42	22.00	34.77
713.5	5	16-QAM	1/24	15.54	H	6.8	0.42	21.92	34.77
704	10	QPSK	1/49	17.76	V	6.8	0.42	24.14	34.77
707.5	10	QPSK	1/49	17.82	V	6.8	0.42	24.20	34.77
711	10	QPSK	1/49	17.79	V	6.8	0.42	24.17	34.77
704	10	QPSK	1/49	15.15	H	6.8	0.42	21.53	34.77
707.5	10	QPSK	1/49	15.21	H	6.8	0.42	21.59	34.77
711	10	QPSK	1/49	15.19	H	6.8	0.42	21.57	34.77
704	10	16-QAM	1/49	16.84	V	6.8	0.42	23.22	34.77
707.5	10	16-QAM	1/49	16.89	V	6.8	0.42	23.27	34.77
711	10	16-QAM	1/49	16.81	V	6.8	0.42	23.19	34.77
704	10	16-QAM	1/49	15.13	H	6.8	0.42	21.51	34.77
707.5	10	16-QAM	1/49	15.19	H	6.8	0.42	21.57	34.77
711	10	16-QAM	1/49	15.11	H	6.8	0.42	21.49	34.77

ERP for LTE Band 17 (Part 27)

Frequency (MHz)	BW (MHz)	Modulation	RB Size/Offset	Substituted level (dBm)	Antenna Polarization	Antenna Gain correction (dBi)	Cable Loss (dB)	Absolute Level (dBm)	Limit (dBm)
706.5	5	QPSK	1/0	17.95	V	6.8	0.42	24.33	34.77
710	5	QPSK	1/0	17.89	V	6.8	0.42	24.27	34.77
713.5	5	QPSK	1/0	17.94	V	6.8	0.42	24.32	34.77
706.5	5	QPSK	1/0	16.37	H	6.8	0.42	22.75	34.77
710	5	QPSK	1/0	16.32	H	6.8	0.42	22.70	34.77
713.5	5	QPSK	1/0	16.34	H	6.8	0.42	22.72	34.77
706.5	5	16-QAM	1/0	17.12	V	6.8	0.42	23.50	34.77
710	5	16-QAM	1/0	17.06	V	6.8	0.42	23.44	34.77
713.5	5	16-QAM	1/0	17.09	V	6.8	0.42	23.47	34.77
706.5	5	16-QAM	1/0	15.62	H	6.8	0.42	22.00	34.77
710	5	16-QAM	1/0	15.58	H	6.8	0.42	21.96	34.77
713.5	5	16-QAM	1/0	15.53	H	6.8	0.42	21.91	34.77
709	10	QPSK	1/0	17.88	V	6.8	0.42	24.26	34.77
710	10	QPSK	1/0	17.83	V	6.8	0.42	24.21	34.77
711	10	QPSK	1/0	17.84	V	6.8	0.42	24.22	34.77
709	10	QPSK	1/0	16.94	H	6.8	0.42	23.32	34.77
710	10	QPSK	1/0	16.91	H	6.8	0.42	23.29	34.77
711	10	QPSK	1/0	16.88	H	6.8	0.42	23.26	34.77
709	10	16-QAM	1/0	16.94	V	6.8	0.42	23.32	34.77
710	10	16-QAM	1/0	16.89	V	6.8	0.42	23.27	34.77
711	10	16-QAM	1/0	16.86	V	6.8	0.42	23.24	34.77
709	10	16-QAM	1/0	15.38	H	6.8	0.42	21.76	34.77
710	10	16-QAM	1/0	15.42	H	6.8	0.42	21.80	34.77
711	10	16-QAM	1/0	15.35	H	6.8	0.42	21.73	34.77

6.3 Peak-Average Ratio

Temperature	24°C
Relative Humidity	56%
Atmospheric Pressure	1023mbar
Test date :	December 23, 2015
Tested By :	Winnie Zhang

Requirement(s):

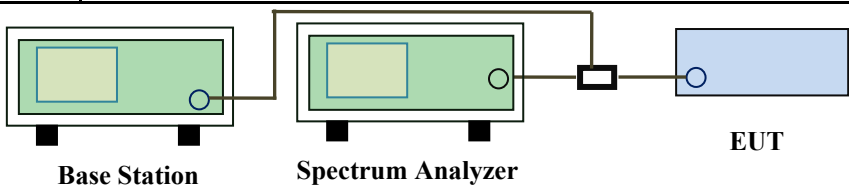
Spec	Item	Requirement	Applicable
§24.232(d) § 27.50(d)	a)	The peak-to-average ratio (PAR) of the transmission may not exceed 13 dB.	<input checked="" type="checkbox"/>
Test Setup	 <p>The diagram shows a Base Station (green box) connected to a Spectrum Analyzer (green box), which is then connected to an EUT (blue box). The Spectrum Analyzer is connected to the EUT via a small black box, likely a coupler or attenuator.</p>		
Test Procedure	<p>According with KDB 971168</p> <ol style="list-style-type: none"> 1. The signal analyzer' s CCDF measurement profile is enabled 2. Frequency = carrier center frequency 3. Measurement BW > Emission bandwidth of signal 4. The signal analyzer was set to collect one million samples to generate the CCDF curve 5. The measurement interval was set depending on the type of signal analyzed. For continuous signals (>98% duty cycle), the measurement interval was set to 1ms. For burst transmissions, the spectrum analyzer is set to use an internal “ RF Burst” trigger that is synced with an incoming pulse and the measurement interval is set to less than the duration of the “ on time” of one burst to ensure that energy is only captured during a time in which the transmitter is operating at maximum power 		
Remark			
Result	<input checked="" type="checkbox"/> Pass <input type="checkbox"/> Fail		

Test Data Yes N/A
 Test Plot Yes (See below) N/A

LTE Band 2 (part 24E)

BW(MHz)	Frequency (MHz)	Mode	Modulation	Conducted Power (dBm)		Peak-Average Ratio (PAR)
				Peak	Average	
1.4	1880	RB 1/0	QPSK	24.21	23.05	1.16
			16QAM	23.17	22.06	1.11
3	1880	RB 1/0	QPSK	24.35	23.05	1.30
			16QAM	24.28	22.08	2.20
5	1880	RB 1/0	QPSK	24.37	23.12	1.25
			16QAM	23.81	22.62	1.19
10	1880	RB 1/0	QPSK	24.72	23.16	1.56
			16QAM	23.61	22.04	1.57
15	1880	RB 1/0	QPSK	24.62	23.18	1.44
			16QAM	23.71	22.08	1.63
20	1880	RB 1/0	QPSK	24.67	23.27	1.40
			16QAM	23.58	22.19	1.39

LTE Band 4 (part 27)

BW(MHz)	Frequency (MHz)	Mode	Modulation	Conducted Power (dBm)		Peak-Average Ratio (PAR)
				Peak	Average	
1.4	1732.5	RB 1/0	QPSK	23.21	21.82	1.39
			16QAM	23.65	21.78	1.87
3	1732.5	RB 1/0	QPSK	23.45	21.81	1.64
			16QAM	23.72	21.78	1.94
5	1732.5	RB 1/0	QPSK	23.68	21.75	1.93
			16QAM	23.69	21.83	1.86
10	1732.5	RB 1/0	QPSK	23.75	21.89	1.86
			16QAM	23.84	21.85	1.99
15	1732.5	RB 1/0	QPSK	23.73	21.75	1.98
			16QAM	23.88	22.05	1.83
20	1732.5	RB 1/0	QPSK	23.79	22.02	1.77
			16QAM	23.91	21.92	1.99

LTE Band 5 (part 27)

BW(MHz)	Frequency (MHz)	Mode	Modulation	Conducted Power (dBm)		Peak-Average Ratio (PAR)
				Peak	Average	
1.4	836.5	RB 1/0	QPSK	23.64	22.79	0.85
			16QAM	23.51	21.81	1.70
3	836.5	RB 1/0	QPSK	23.56	22.81	0.75
			16QAM	23.26	21.81	1.45
5	836.5	RB 1/0	QPSK	24.37	22.81	1.56
			16QAM	24.21	22.28	1.93
10	836.5	RB 1/0	QPSK	24.32	22.98	1.34
			16QAM	23.66	21.84	1.82

LTE Band 7 (part 27)

BW(MHz)	Frequency (MHz)	Mode	Modulation	Conducted Power (dBm)		Peak-Average Ratio (PAR)
				Peak	Average	
5	2535	RB 1/0	QPSK	24.69	23.29	1.40
			16QAM	23.75	22.32	1.43
10	2535	RB 1/0	QPSK	24.34	23.26	1.08
			16QAM	23.51	22.01	1.50
15	2535	RB 1/0	QPSK	24.16	22.92	1.24
			16QAM	23.73	22.18	1.55
20	2535	RB 1/0	QPSK	24.29	23.01	1.28
			16QAM	23.86	21.99	1.87

LTE Band 12 (part 27)

BW(MHz)	Frequency (MHz)	Mode	Modulation	Conducted Power (dBm)		Peak-Average Ratio (PAR)
				Peak	Average	
1.4	1732.5	RB 1/0	QPSK	24.87	22.96	1.91
			16QAM	23.74	21.95	1.79
3	1732.5	RB 1/0	QPSK	24.25	22.97	1.28
			16QAM	23.64	21.97	1.67
5	1732.5	RB 1/0	QPSK	24.84	22.96	1.88
			16QAM	23.59	22.35	1.24
10	1732.5	RB 1/0	QPSK	24.28	23	1.28
			16QAM	23.47	21.96	1.51

LTE Band 17 (part 27)

BW(MHz)	Frequency (MHz)	Mode	Modulation	Conducted Power (dBm)		Peak-Average Ratio (PAR)
				Peak	Average	
5	710	RB 1/0	QPSK	24.12	23.07	1.05
			16QAM	23.69	22.54	1.15
10	710	RB 1/0	QPSK	24.22	23.16	1.06
			16QAM	23.29	22.07	1.22

6.4 Occupied Bandwidth

Temperature	24°C
Relative Humidity	56%
Atmospheric Pressure	1023mbar
Test date :	December 23, 2015
Tested By :	Winnie Zhang

Requirement(s):

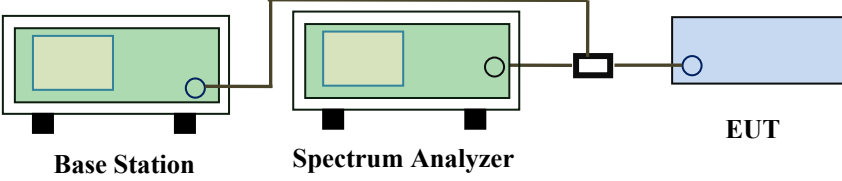
Spec	Item	Requirement	Applicable
§2.1049, §22.917, §22.905 §24.238 §27.53(a)	a)	99% Occupied Bandwidth(kHz)	<input checked="" type="checkbox"/>
	b)	26 dB Bandwidth(kHz)	<input checked="" type="checkbox"/>
Test Setup	 <p style="text-align: center;">Base Station Spectrum Analyzer EUT</p>		
Test Procedure	<ul style="list-style-type: none"> - The EUT was connected to Spectrum Analyzer and Base Station via power divider. - The 99% and 26 dB occupied bandwidth (BW) of the middle channel for the highest RF powers. 		
Remark			
Result	<input checked="" type="checkbox"/> Pass <input type="checkbox"/> Fail		

Test Data Yes N/A

Test Plot Yes (See below) N/A

LTE Band 2 (Part 24E)

BW(MHz)	Channel	Frequency (MHz)	Modulation	99% Occupied Bandwidth (MHz)	26 dB Bandwidth (MHz)
1.4	18607	1850.7	16QAM	1.1026	1.273
			QPSK	1.0987	1.272
1.4	18900	1880	16QAM	1.0885	1.267
			QPSK	1.1055	1.271
1.4	19193	1909.3	16QAM	1.0944	1.267
			QPSK	1.1034	1.272
3	18615	1851.5	16QAM	2.7348	3.101
			QPSK	2.7389	3.099
3	18900	1880	16QAM	2.7319	3.068
			QPSK	2.7418	3.074
3	19185	1908.5	16QAM	2.7370	3.052
			QPSK	2.7397	3.099
5	18625	1852.5	16QAM	4.5226	5.059
			QPSK	4.5309	5.121
5	18900	1880	16QAM	4.5220	5.111
			QPSK	4.5286	5.043
5	19175	1907.5	16QAM	4.5242	5.055
			QPSK	4.5091	5.024
10	18650	1855	16QAM	9.0522	10.113
			QPSK	9.0633	10.117
10	18900	1880	16QAM	9.0271	10.075
			QPSK	9.0772	10.068
10	19150	1905	16QAM	9.0279	9.989
			QPSK	9.0403	10.027
15	18675	1857.5	16QAM	13.5158	14.795
			QPSK	13.4459	14.789
15	18900	1880	16QAM	13.4716	14.758
			QPSK	13.4347	14.860
15	19125	1902.5	16QAM	13.4934	14.907
			QPSK	13.4727	14.974

20	18700	1860	16QAM	17.9308	19.422
			QPSK	17.8907	19.413
20	18900	1880	16QAM	17.8751	19.023
			QPSK	17.8731	19.393
20	19100	1900	16QAM	17.9139	19.423
			QPSK	17.9239	19.533

LTE Band 4 (Part 27)

BW(MHz)	Channel	Frequency (MHz)	Modulation	99% Occupied Bandwidth (MHz)	26 dB Bandwidth (MHz)
1.4	19957	1710.7	16QAM	1.0985	1.278
			QPSK	1.0982	1.271
1.4	20175	1732.5	16QAM	1.0942	1.264
			QPSK	1.0944	1.282
1.4	20393	1754.3	16QAM	1.0963	1.259
			QPSK	1.1045	1.274
3	19965	1711.5	16QAM	2.7350	3.091
			QPSK	2.7459	3.067
3	20175	1732.5	16QAM	2.7463	3.100
			QPSK	2.7314	3.102
3	20385	1753.5	16QAM	2.7335	3.086
			QPSK	2.7487	3.083
5	19975	1712.5	16QAM	4.5311	5.026
			QPSK	4.5181	5.098
5	20175	1732.5	16QAM	4.5208	5.017
			QPSK	4.5154	5.024
5	20375	1752.5	16QAM	4.5130	5.070
			QPSK	4.5166	5.112
10	20000	1715	16QAM	9.0250	10.154
			QPSK	9.0323	10.196
10	20175	1732.5	16QAM	13.4727	14.652
			QPSK	9.0758	10.017
10	20350	1750	16QAM	9.0417	10.154
			QPSK	9.0488	10.089

15	20025	1717.5	16QAM	13.4572	14.829
			QPSK	13.4347	14.699
15	20175	1732.5	16QAM	13.4748	14.743
			QPSK	13.4645	14.737
15	20325	1747.5	16QAM	13.4488	14.765
			QPSK	13.4473	14.807
20	20050	1720	16QAM	17.8713	19.265
			QPSK	17.8541	19.141
20	20175	1732.5	16QAM	17.9191	19.380
			QPSK	17.8992	19.283
20	20300	1745	16QAM	17.8519	19.255
			QPSK	17.8708	19.315

LTE Band 5 (Part 22H)

BW(MHz)	Channel	Frequency (MHz)	Modulation	99% Occupied Bandwidth (MHz)	26 dB Bandwidth (MHz)
1.4	20407	824.7	16QAM	1.1034	1.278
			QPSK	1.0959	1.282
1.4	20525	936.5	16QAM	1.0912	1.260
			QPSK	1.0952	1.288
1.4	20643	949.3	16QAM	1.1013	1.272
			QPSK	1.1051	1.267
3	20415	825.5	16QAM	2.7356	3.078
			QPSK	2.7371	3.099
3	20525	936.5	16QAM	2.7568	3.112
			QPSK	2.7501	3.090
3	20635	847.5	16QAM	2.7371	3.103
			QPSK	2.7402	3.099
5	20425	826.5	16QAM	4.5247	5.044
			QPSK	4.5320	5.080
5	20525	936.5	16QAM	4.5162	5.049
			QPSK	4.5087	5.058
5	20625	846.5	16QAM	4.5951	5.030
			QPSK	4.5144	5.023

10	20450	829	16QAM	9.0481	10.116
			QPSK	9.0793	10.107
10	20525	936.5	16QAM	9.0898	10.156
			QPSK	9.0795	10.191
10	20800	844	16QAM	9.0736	10.132
			QPSK	9.0552	10.241

LTE Band 7 (Part 27) result

BW(MHz)	Channel	Frequency (MHz)	Modulation	99% Occupied Bandwidth (MHz)	26 dB Bandwidth (MHz)
5	20775	2502.5	16QAM	4.5351	5.088
			QPSK	4.5327	5.042
5	21100	2535	16QAM	4.5313	5.093
			QPSK	4.5223	5.062
5	21425	2567.5	16QAM	4.5137	5.086
			QPSK	4.5299	5.050
10	20800	2505	16QAM	9.0709	10.160
			QPSK	9.0708	10.024
10	21100	2535	16QAM	9.0686	10.065
			QPSK	9.0703	10.101
10	21400	2562.5	16QAM	9.0580	10.124
			QPSK	9.0893	10.106
15	20825	2507.5	16QAM	13.5565	14.921
			QPSK	13.4575	14.963
15	21100	2535	16QAM	13.5000	14.860
			QPSK	13.5100	14.850
15	21400	2562.5	16QAM	13.5078	14.914
			QPSK	13.5080	14.945
20	20850	2510	16QAM	17.9258	19.388
			QPSK	17.9123	19.507
20	21100	2535	16QAM	17.9284	19.569
			QPSK	17.9107	19.445
20	21350	2560	16QAM	17.9337	19.305
			QPSK	17.9393	19.533

LTE Band 12 (Part 27)

BW(MHz)	Channel	Frequency (MHz)	Modulation	99% Occupied Bandwidth (MHz)	26 dB Bandwidth (MHz)
1.4	23017	699.7	16QAM	1.1043	1.265
			QPSK	1.0995	1.261
1.4	23095	707.5	16QAM	1.0937	1.264
			QPSK	1.0959	1.275
1.4	23173	715.3	16QAM	1.0939	1.283
			QPSK	1.1072	1.273
3	23025	700.5	16QAM	2.7362	3.088
			QPSK	2.7347	3.056
3	23095	707.5	16QAM	2.7444	3.071
			QPSK	2.7431	3.105
3	23165	714.5	16QAM	2.7314	3.084
			QPSK	2.7445	3.076
5	23035	701.5	16QAM	4.5143	5.040
			QPSK	4.5143	5.033
5	23095	707.5	16QAM	4.5305	5.045
			QPSK	4.5319	5.069
5	23055	713.5	16QAM	4.5043	5.067
			QPSK	4.5210	5.002
10	23060	704	16QAM	9.1002	10.069
			QPSK	9.1194	10.103
10	23095	707.5	16QAM	9.0708	10.044
			QPSK	9.0840	10.175
10	23130	711	16QAM	9.0364	10.037
			QPSK	9.0429	10.175

LTE Band 17 (Part 27)

BW(MHz)	Channel	Frequency (MHz)	Modulation	99% Occupied Bandwidth (MHz)	26 dB Bandwidth (MHz)
5	23755	706.5	16QAM	4.5290	5.052
			QPSK	4.5437	5.042
5	23790	710	16QAM	4.5144	5.033
			QPSK	4.5186	5.101
5	23825	713.5	16QAM	4.5087	4.995
			QPSK	4.5061	5.016
10	23780	709	16QAM	9.0475	10.110
			QPSK	9.0500	10.166
10	23790	710	16QAM	9.0352	10.133
			QPSK	9.0542	10.002
10	23800	711	16QAM	9.0024	10.085
			QPSK	9.0348	9.996

Test Plots

LTE Band 2 (Part 24E)

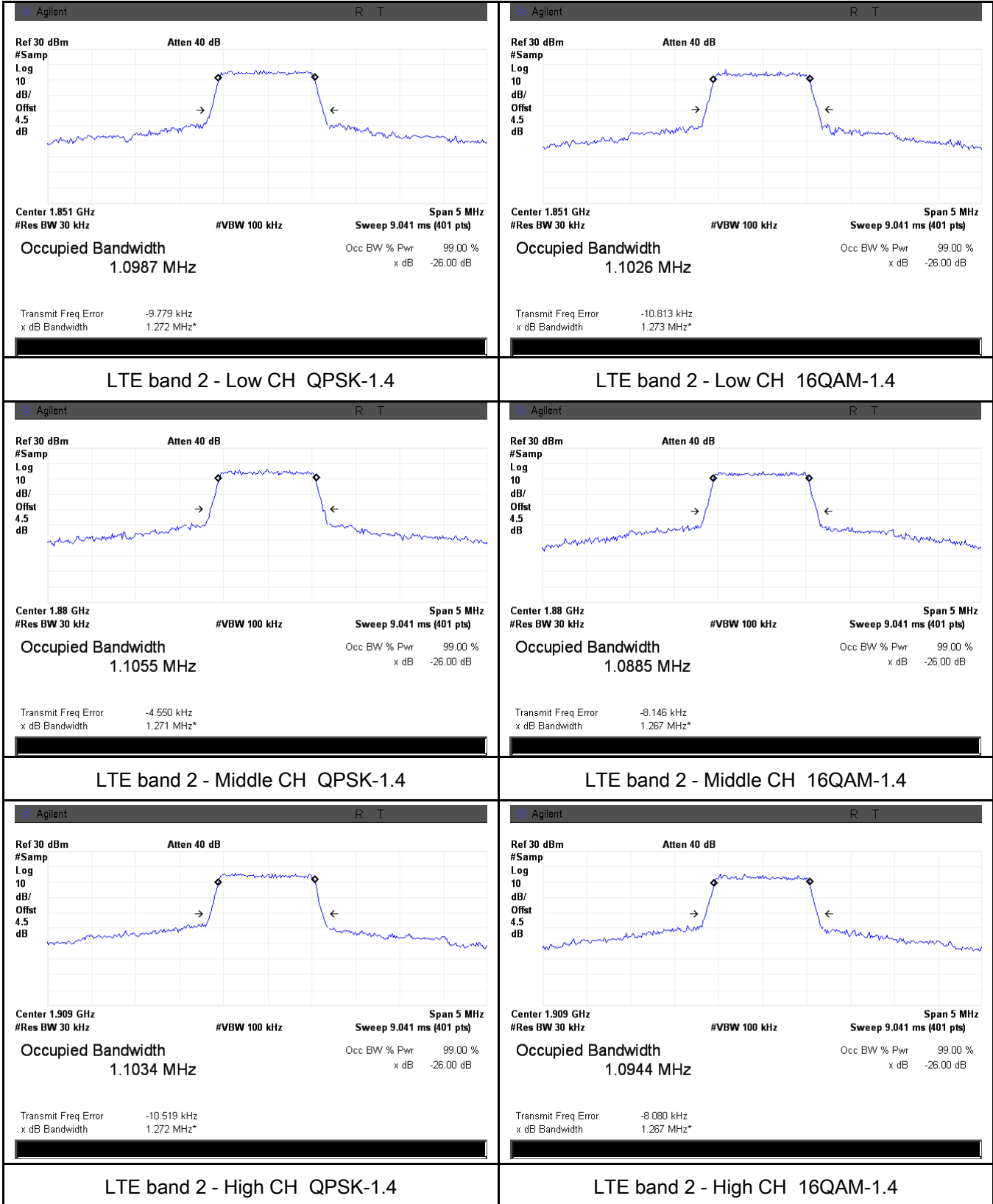

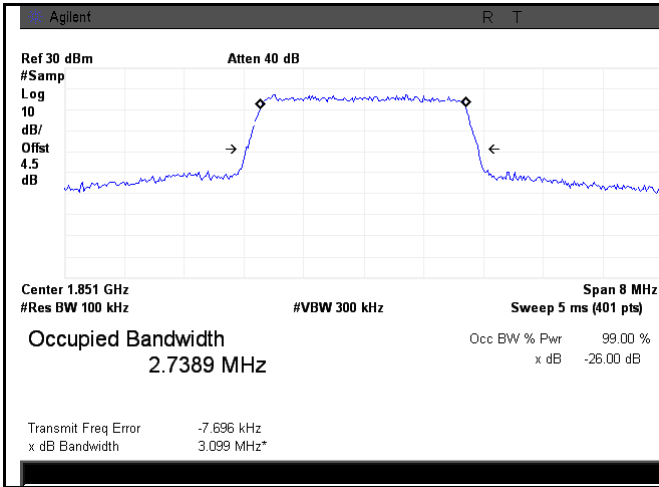

LTE band 2 - Low CH QPSK-3

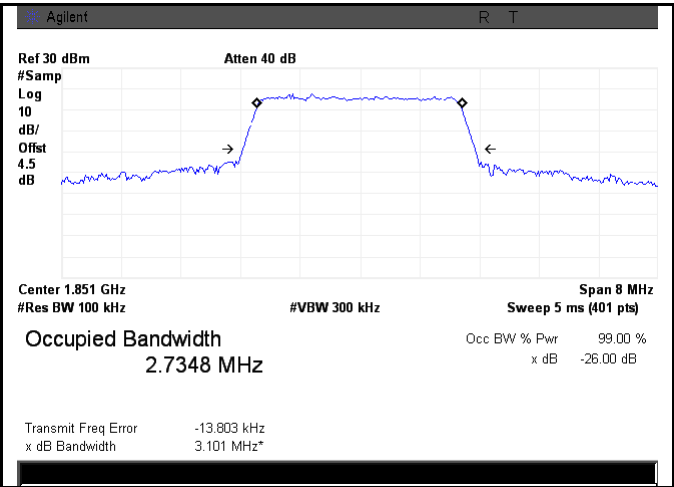

LTE band 2 - Low CH 16QAM-3

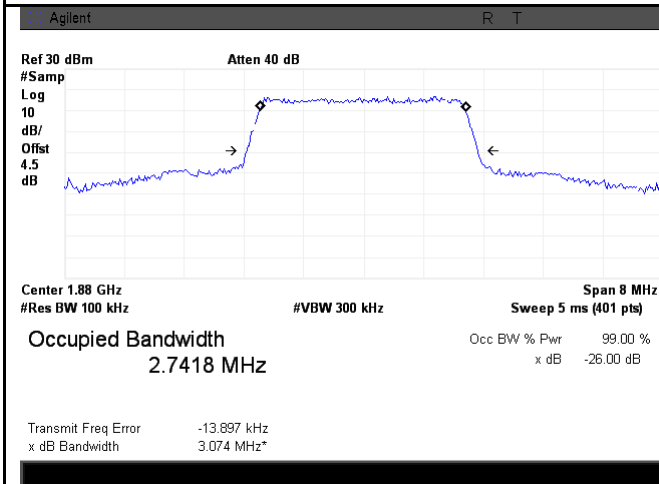

LTE band 2 - Middle CH QPSK-3

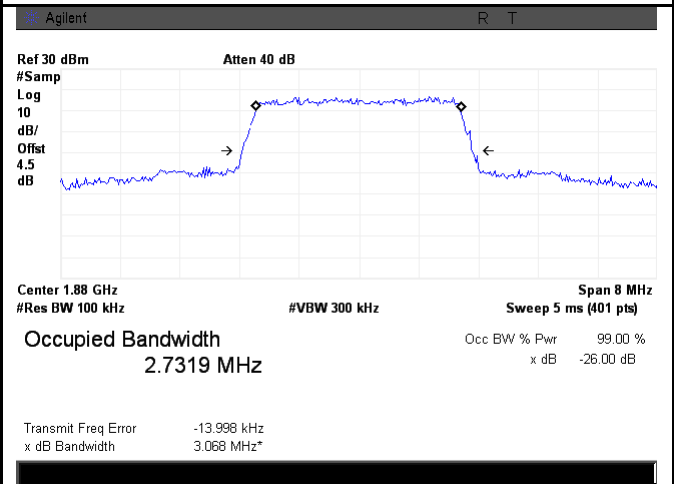

LTE band 2 - Middle CH 16QAM-3

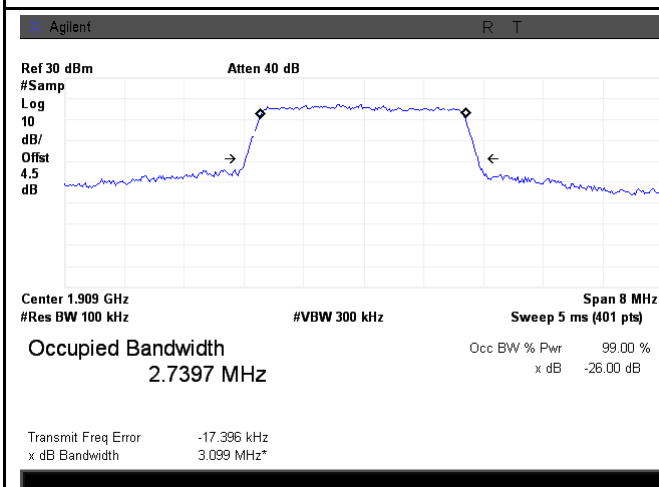

LTE band 2 - High CH QPSK-3

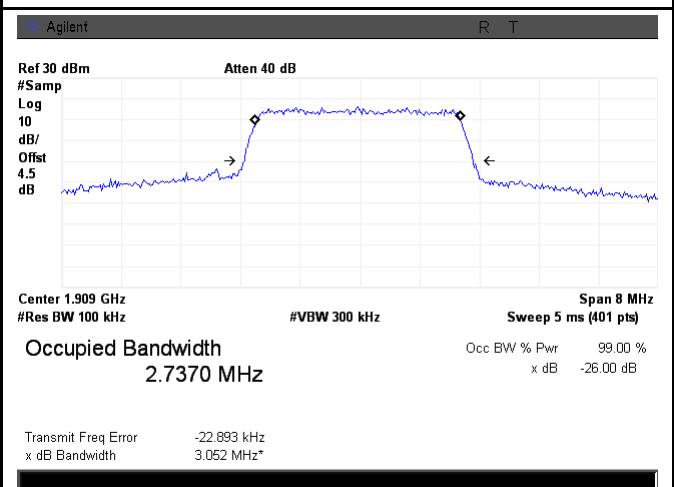

LTE band 2 - High CH 16QAM-3

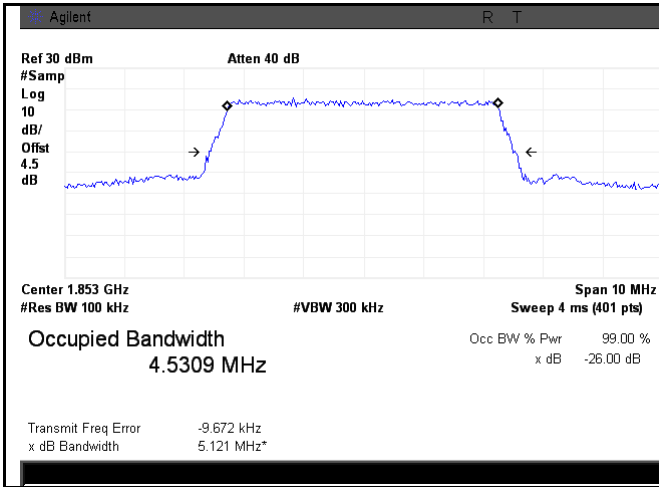

LTE band 2 - Low CH QPSK-5

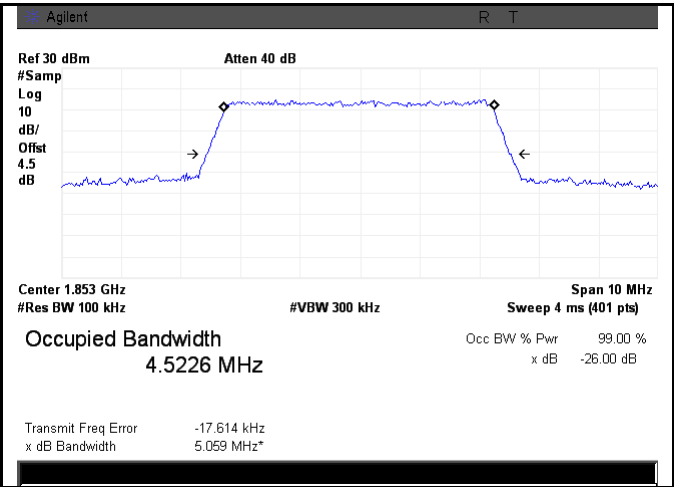

LTE band 2 - Low CH 16QAM-5

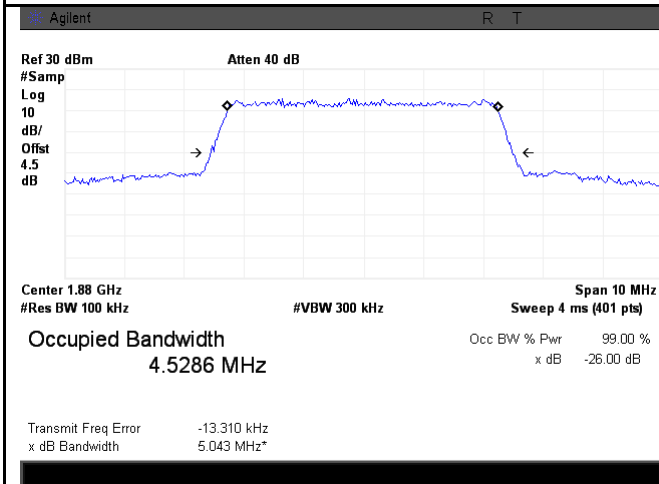

LTE band 2 - Middle CH QPSK-5

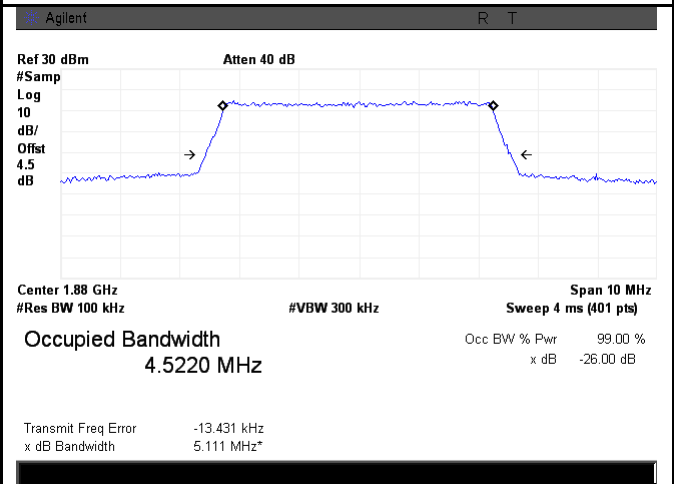

LTE band 2 - Middle CH 16QAM-5

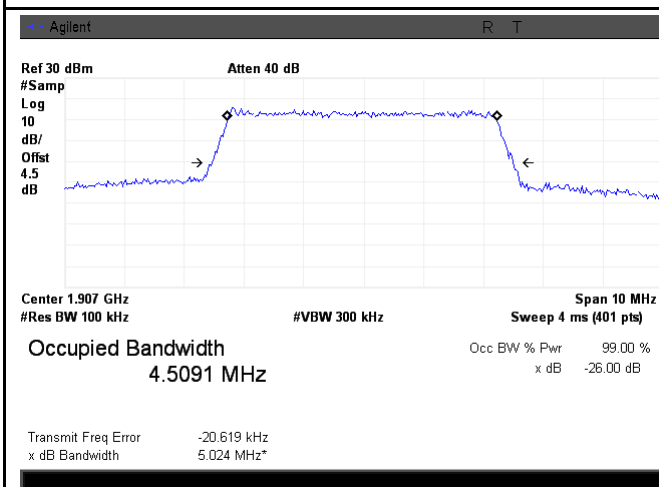

LTE band 2 - High CH QPSK-5

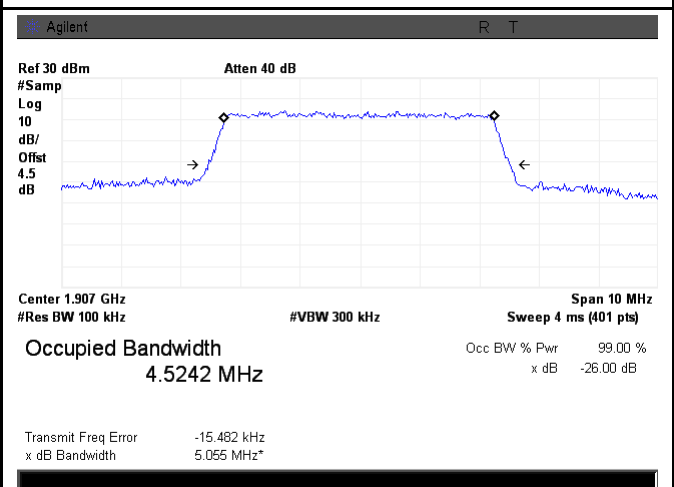

LTE band 2 - High CH 16QAM-5

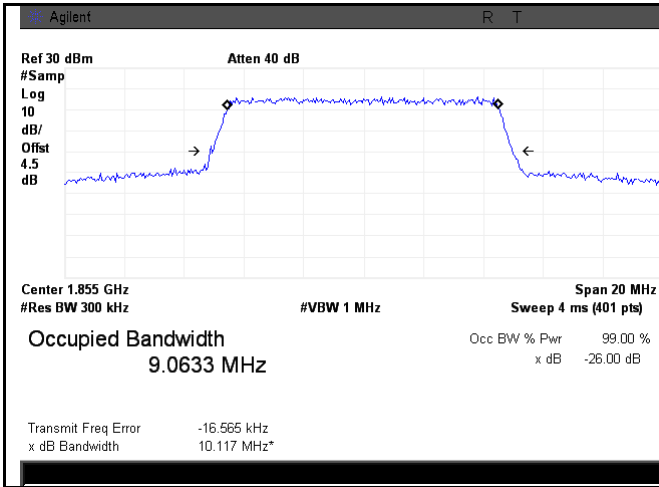

LTE band 2 - Low CH QPSK-10

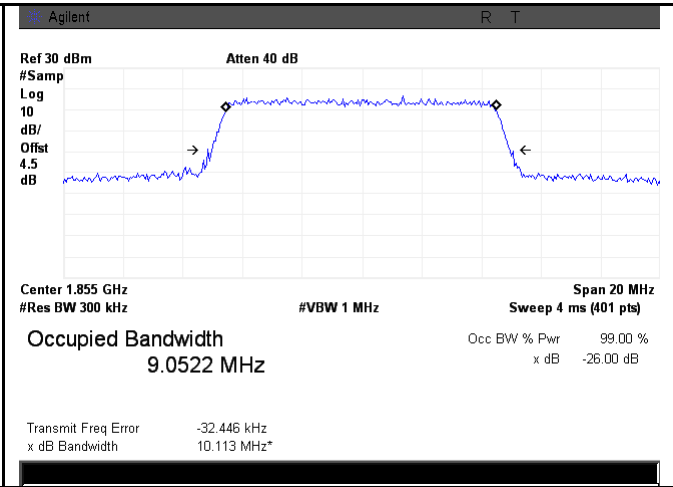

LTE band 2 - Low CH 16QAM-10

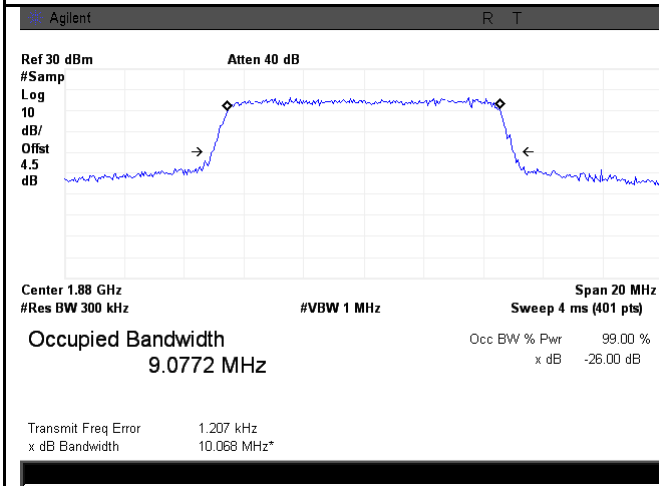

LTE band 2 - Middle CH QPSK-10

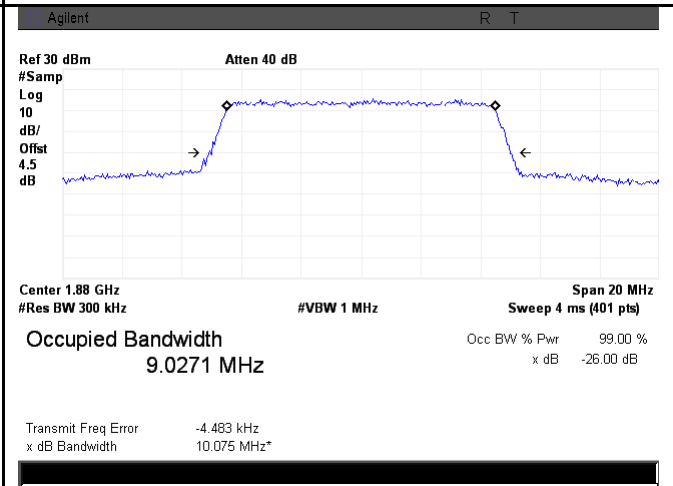

LTE band 2 - Middle CH 16QAM-10

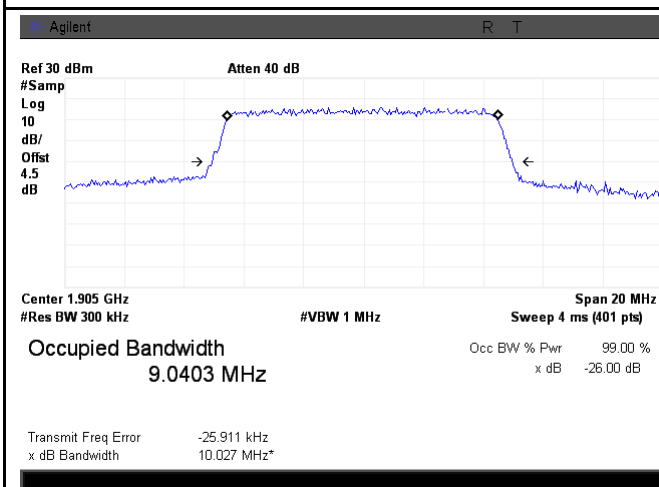

LTE band 2 - High CH QPSK-10

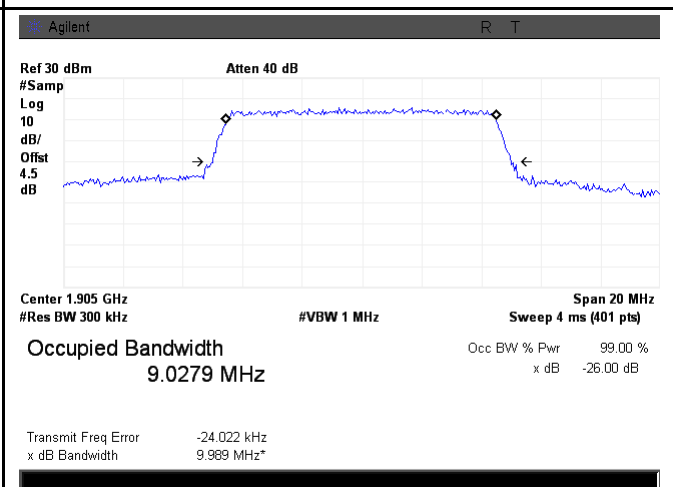

LTE band 2 - High CH 16QAM-10

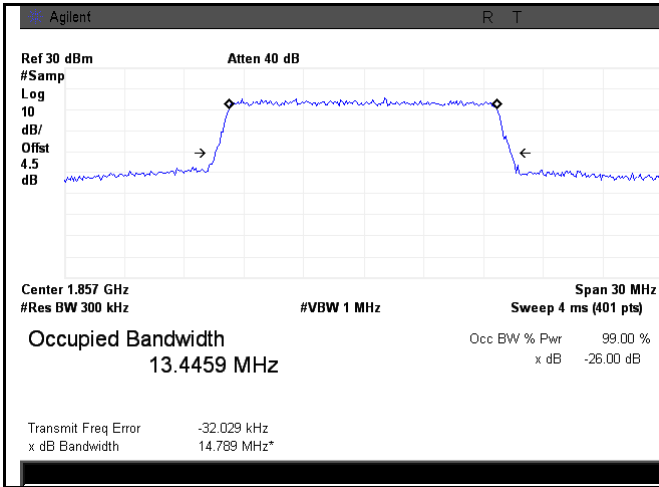

LTE band 2 - Low CH QPSK-15

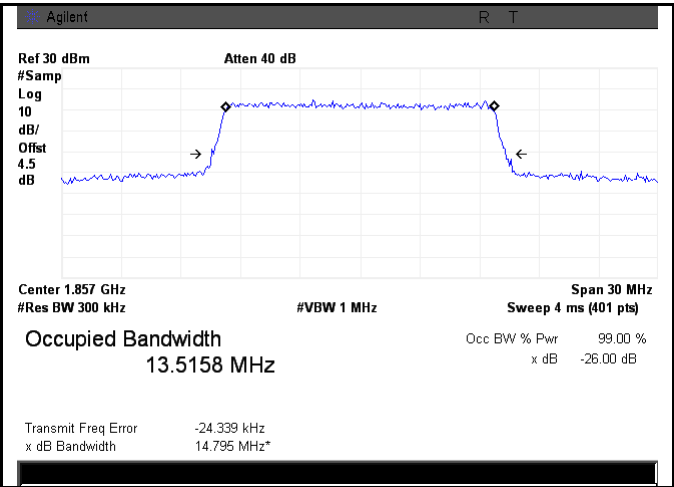

LTE band 2 - Low CH 16QAM-15

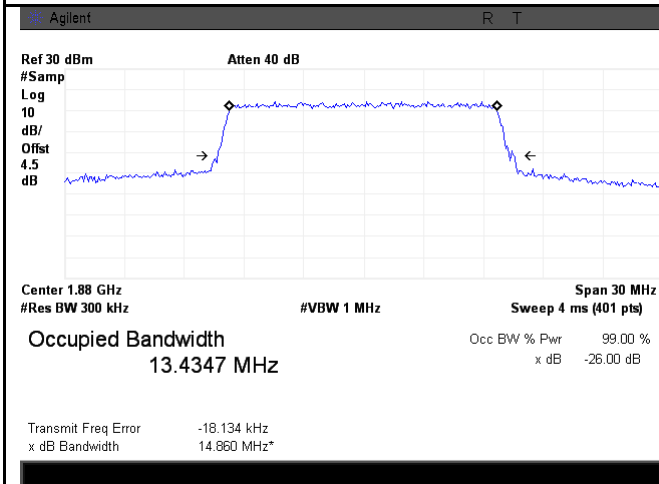

LTE band 2 - Middle CH QPSK-15

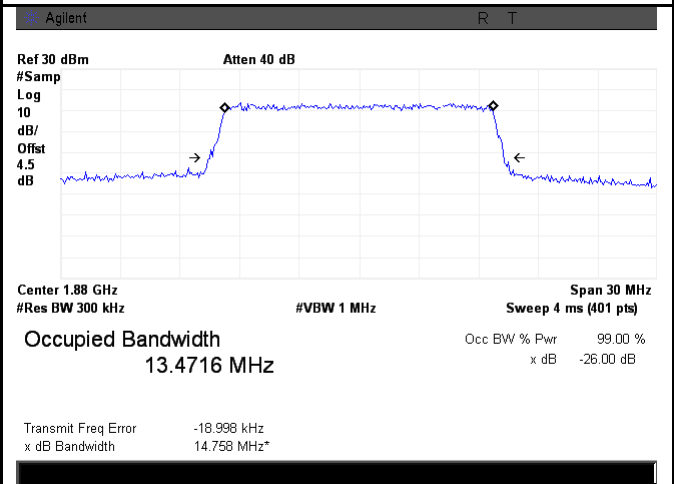

LTE band 2 - Middle CH 16QAM-15

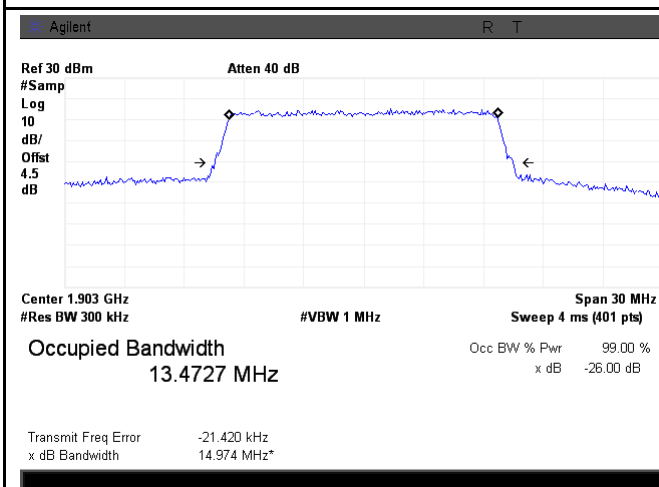

LTE band 2 - High CH QPSK-15

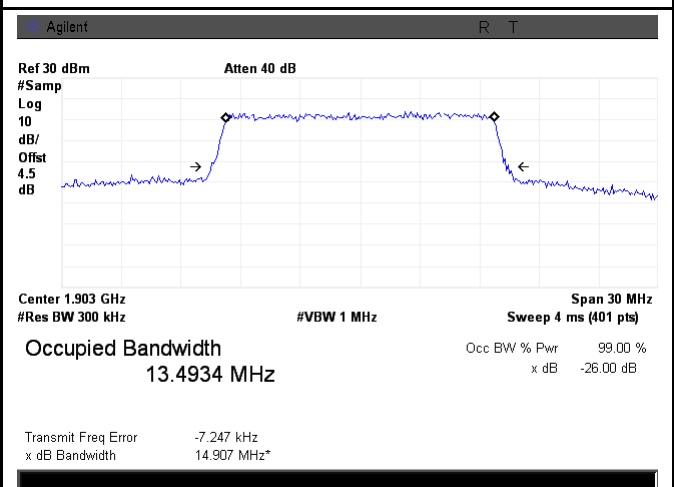

LTE band 2 - High CH 16QAM-15

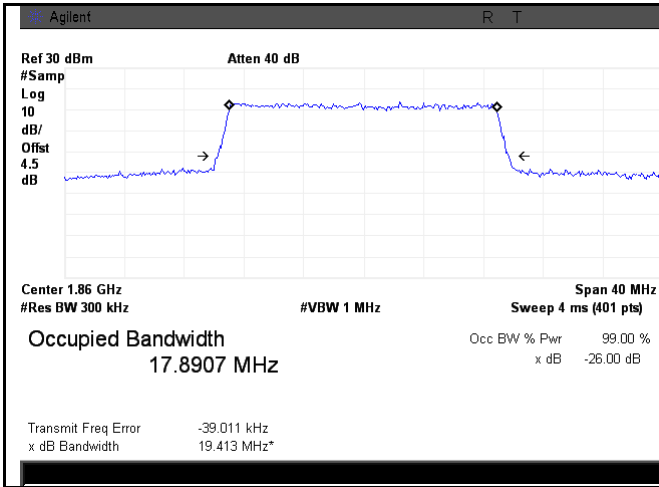

LTE band 2 - Low CH QPSK-20

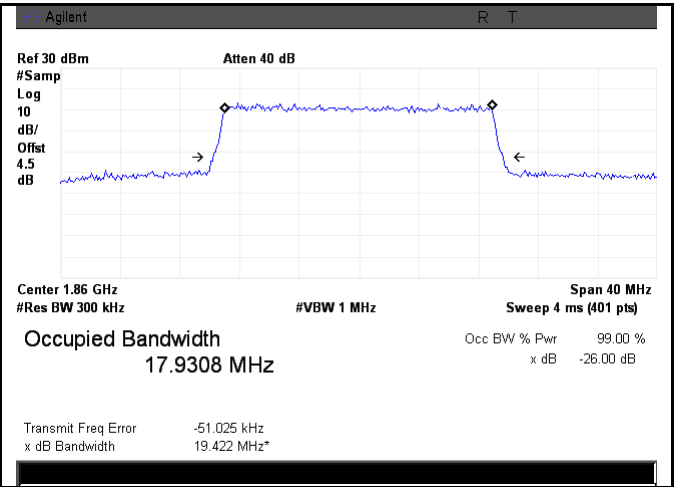

LTE band 2 - Low CH 16QAM-20

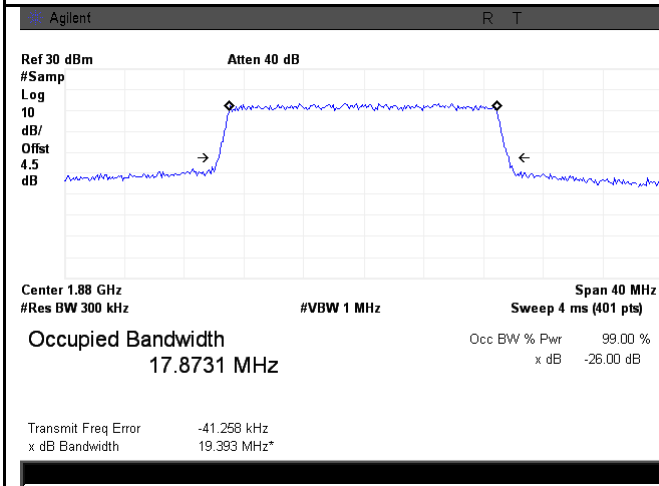

LTE band 2 - Middle CH QPSK-20

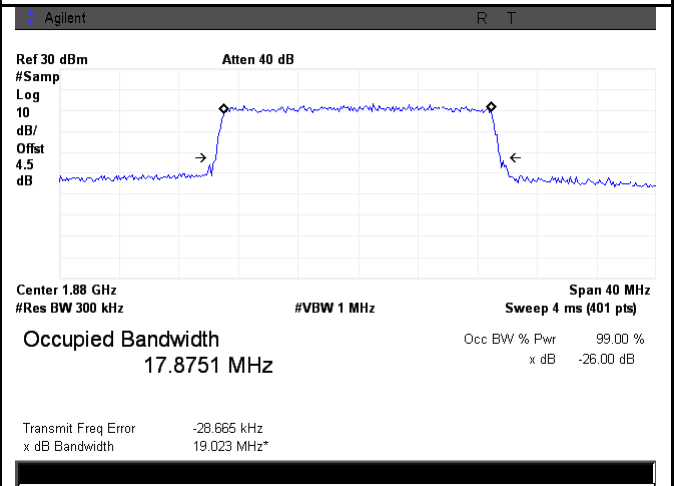

LTE band 2 - Middle CH 16QAM-20

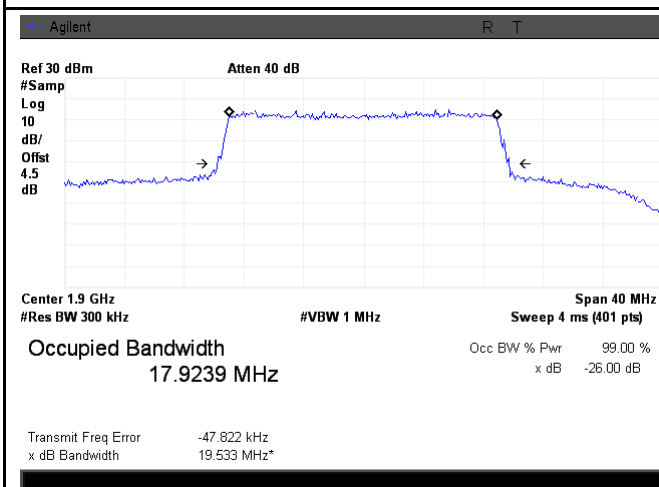

LTE band 2 - High CH QPSK-20

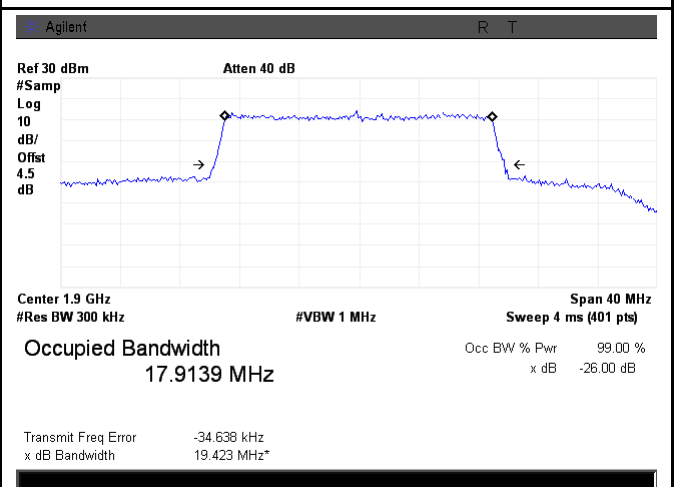

LTE band 2 - High CH 16QAM-20

LTE Band 4 (Part 27)

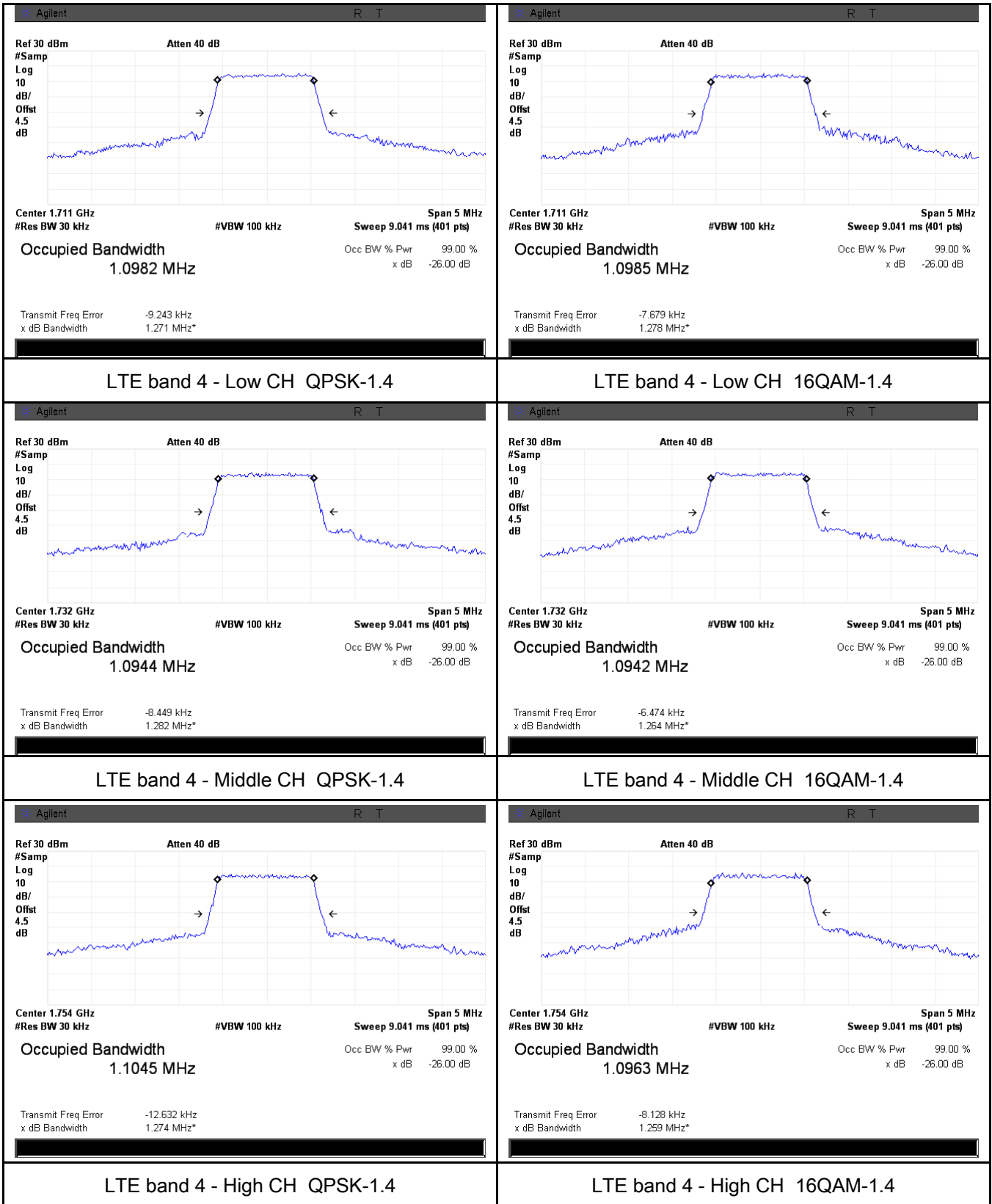

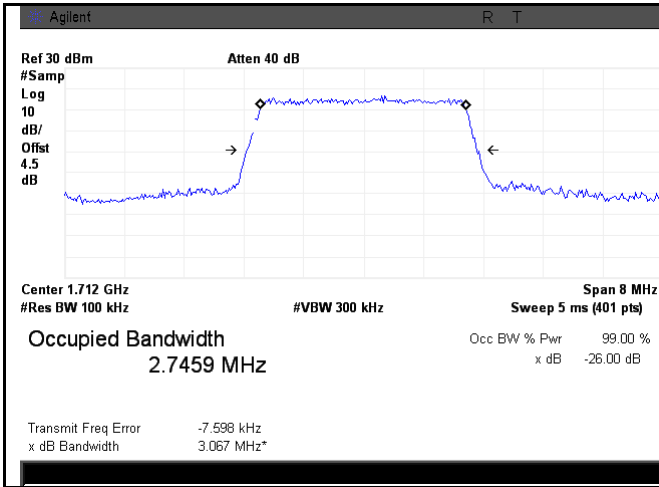

LTE band 4 - Low CH QPSK-3

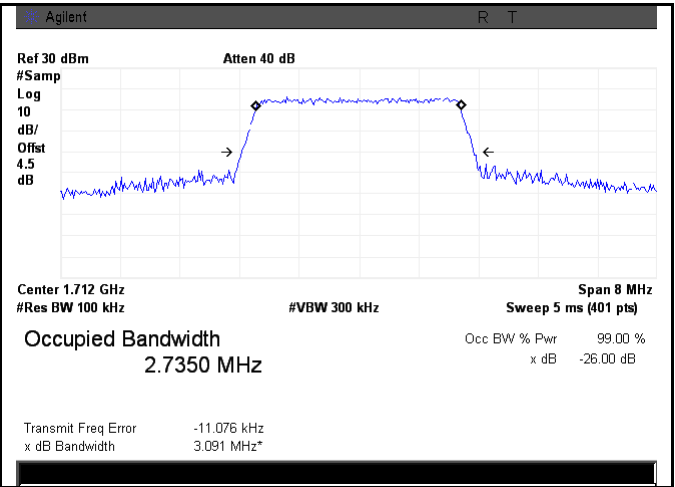

LTE band 4 - Low CH 16QAM-3

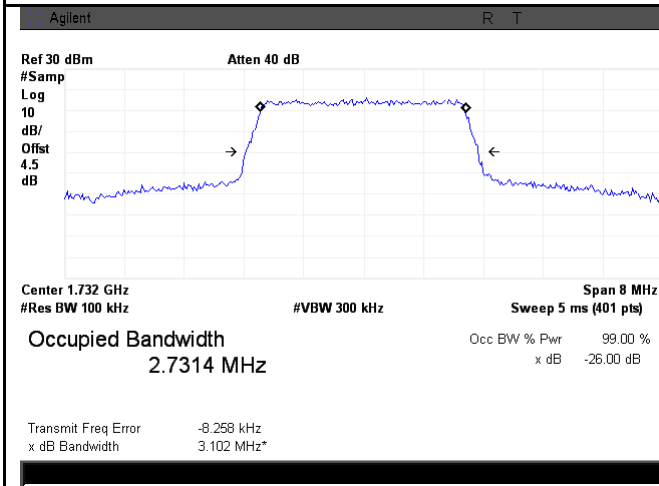

LTE band 4 - Middle CH QPSK-3

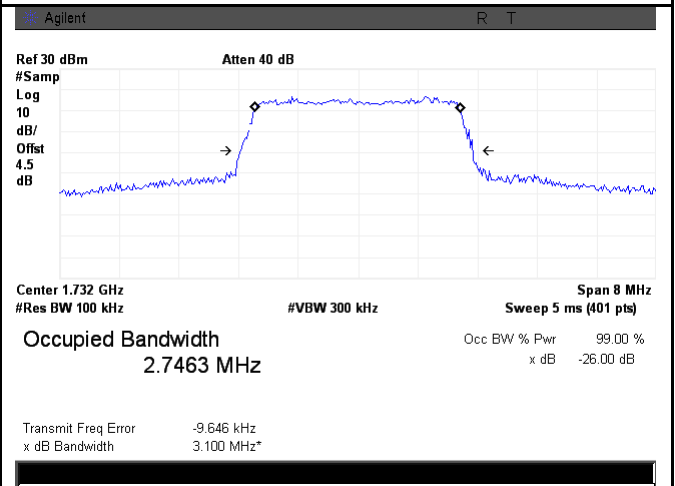

LTE band 4 - Middle CH 16QAM-3

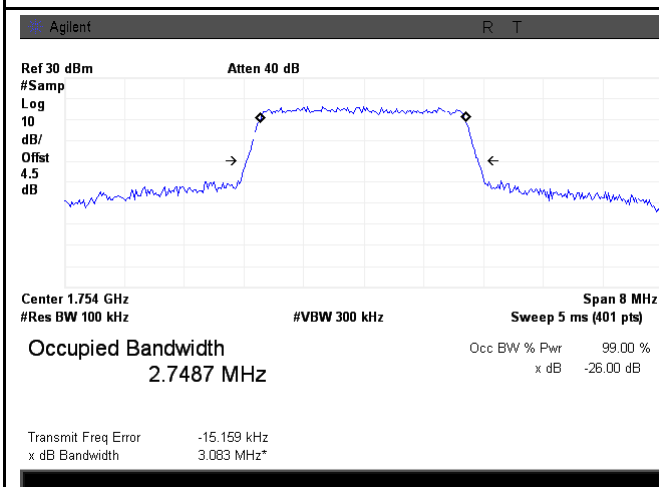

LTE band 4 - High CH QPSK-3

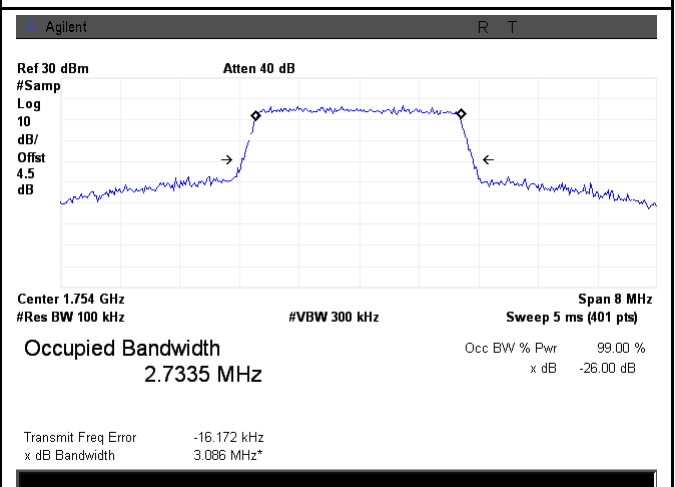

LTE band 4 - High CH 16QAM-3

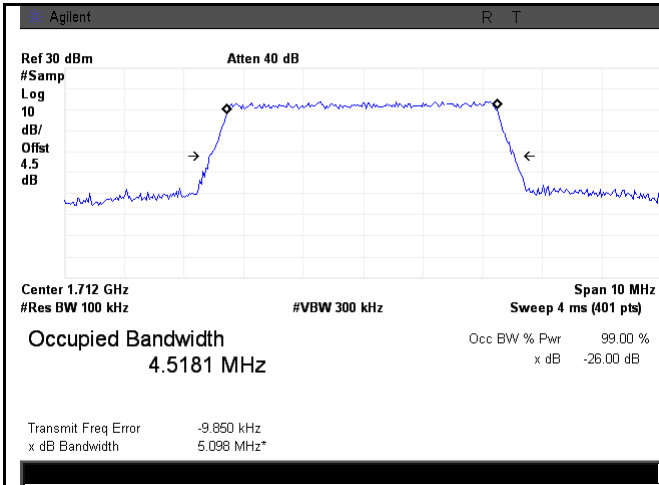

LTE band 4 - Low CH QPSK-5

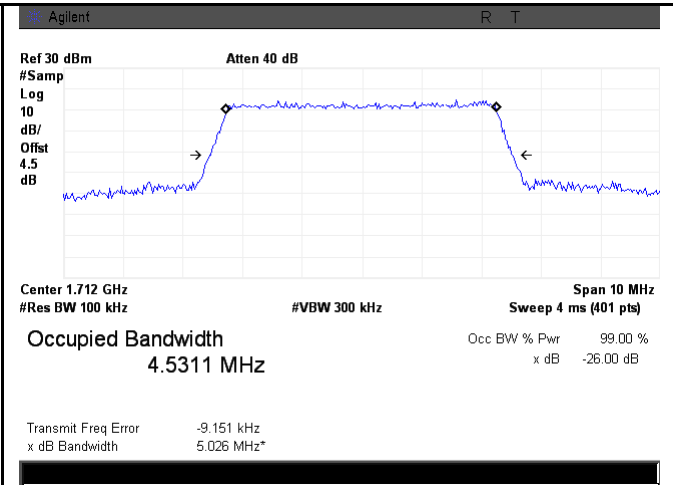

LTE band 4 - Low CH 16QAM-5

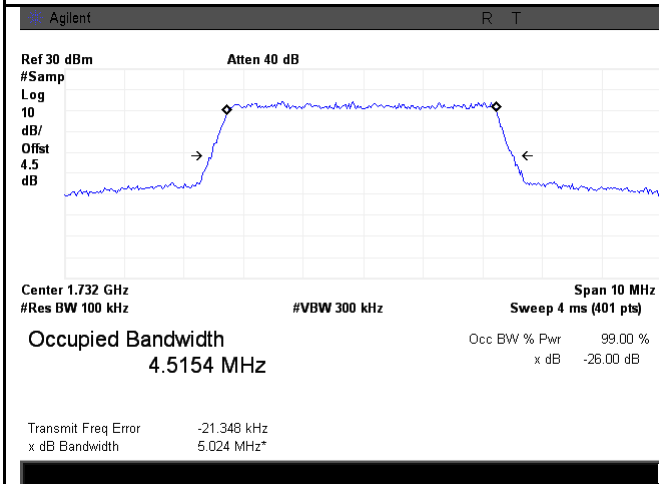

LTE band 4 - Middle CH QPSK-5

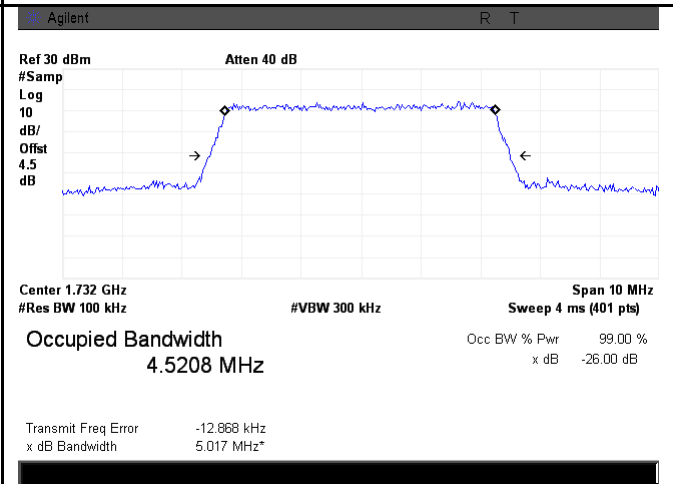

LTE band 4 - Middle CH 16QAM-5

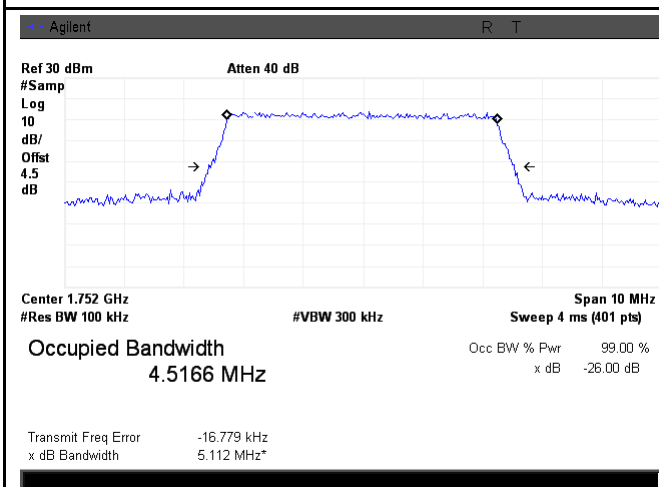

LTE band 4 - High CH QPSK-5

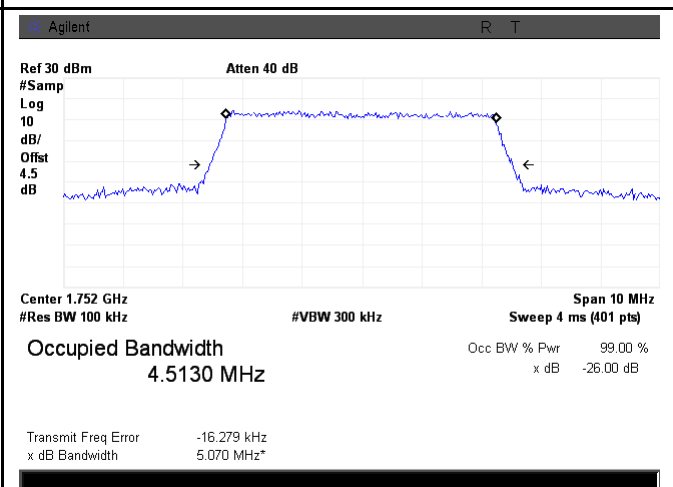

LTE band 4 - High CH 16QAM-5

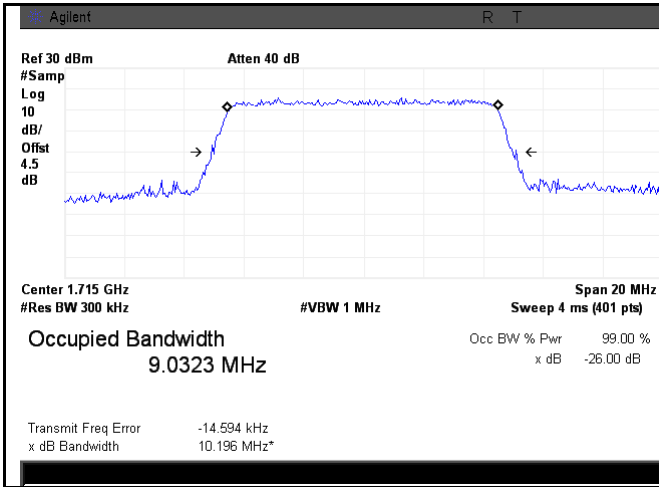

LTE band 4 - Low CH QPSK-10

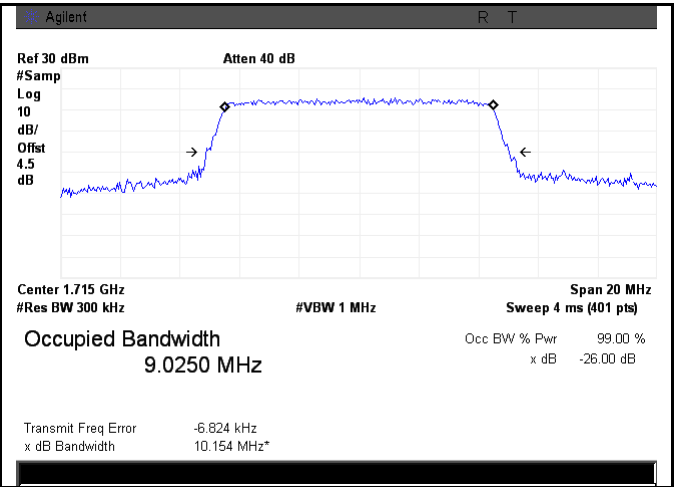

LTE band 4 - Low CH 16QAM-10

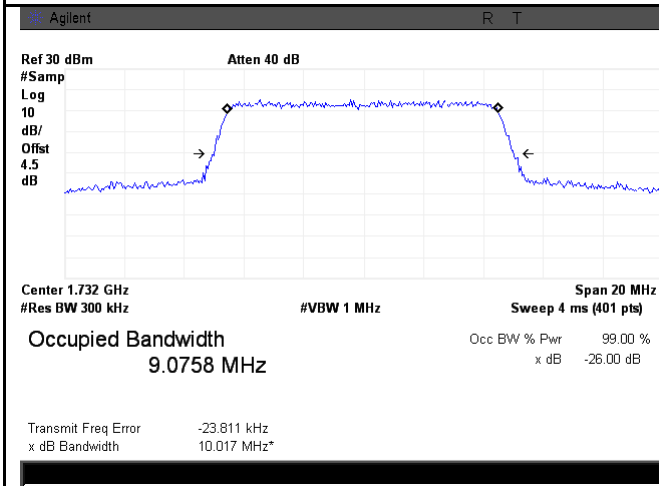

LTE band 4 - Middle CH QPSK-10

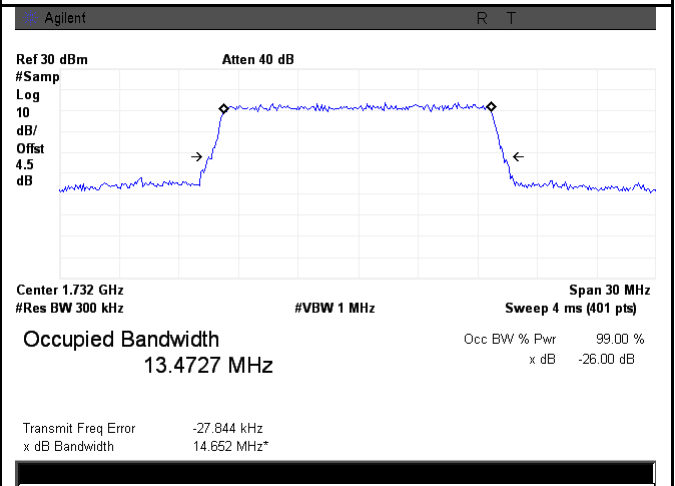

LTE band 4 - Middle CH 16QAM-10

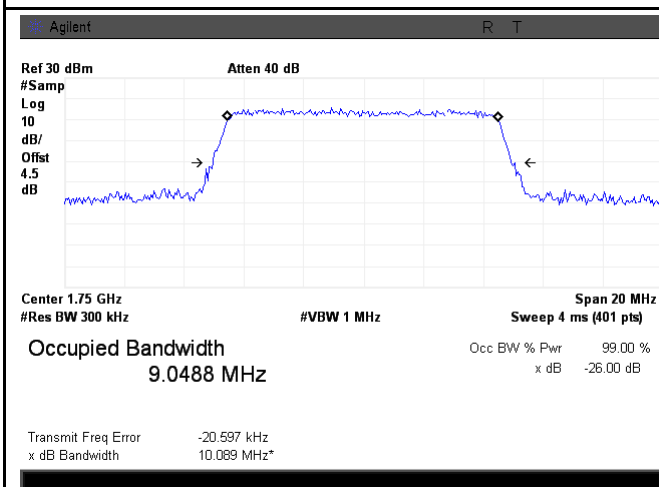

LTE band 4 - High CH QPSK-10

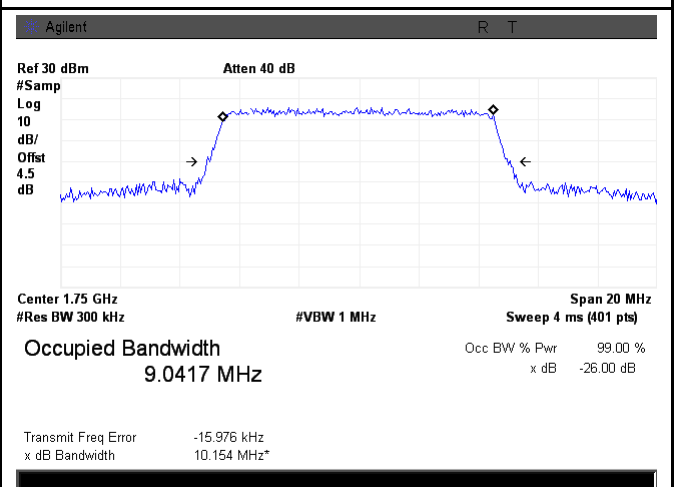

LTE band 4 - High CH 16QAM-10

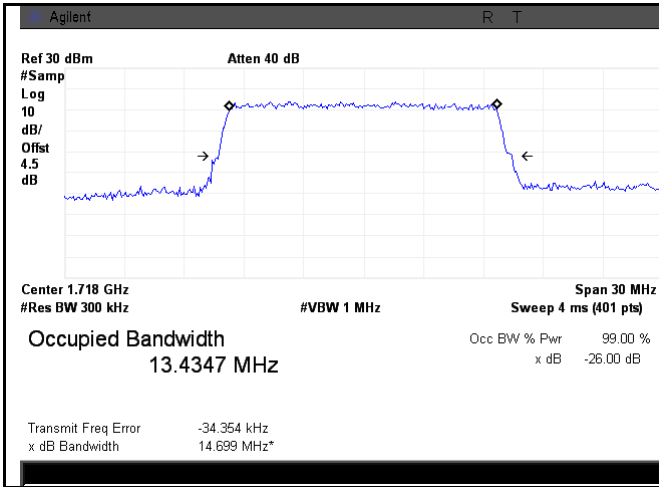

LTE band 4 - Low CH QPSK-15

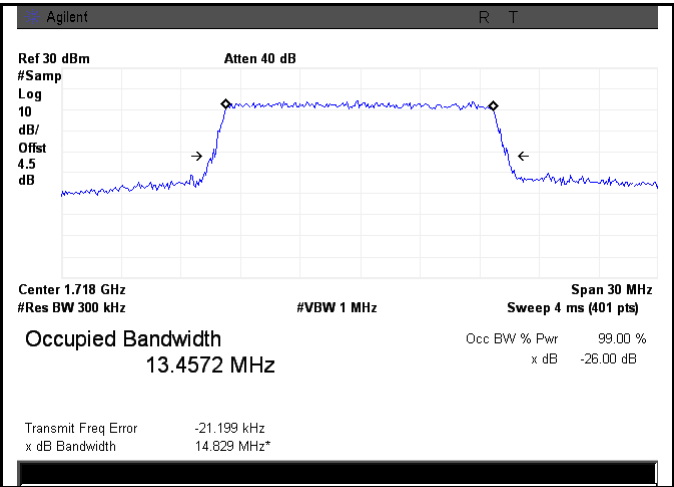

LTE band 4 - Low CH 16QAM-15

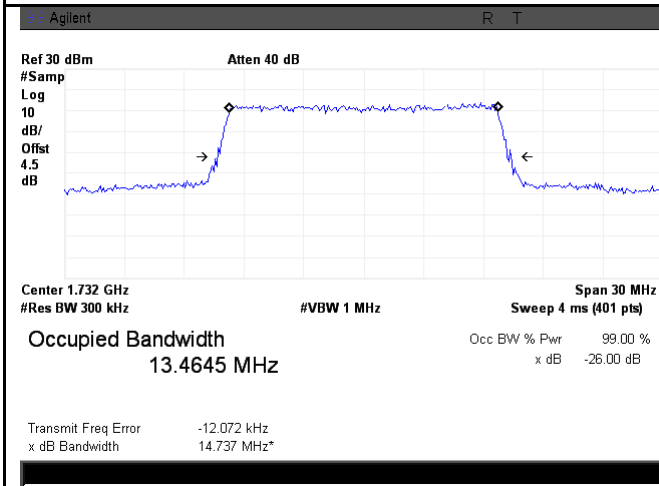

LTE band 4 - Middle CH QPSK-15

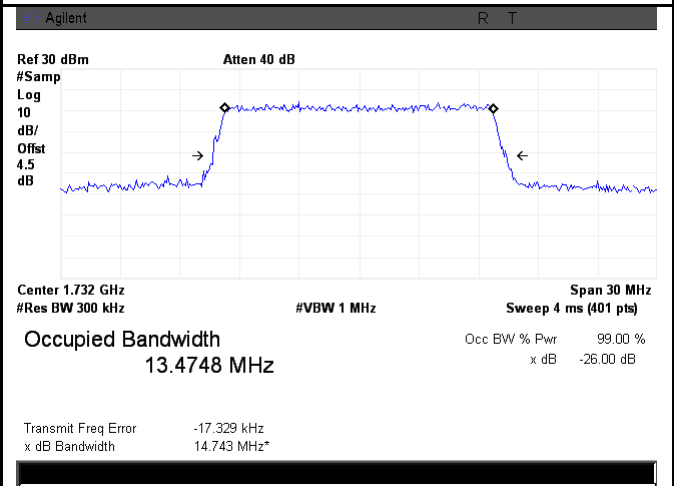

LTE band 4 - Middle CH 16QAM-15

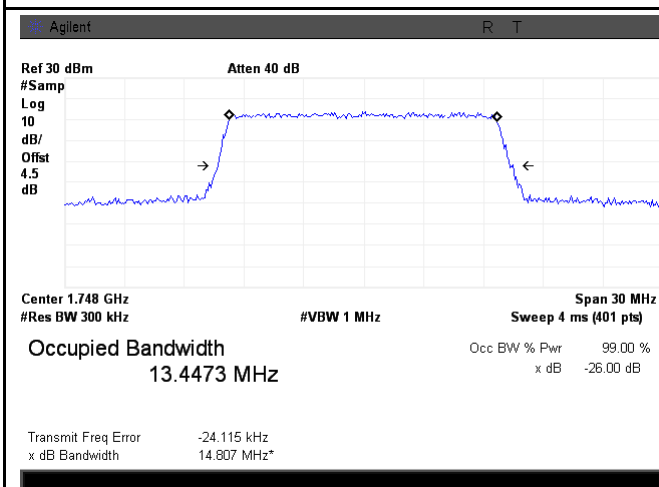

LTE band 4 - High CH QPSK-15

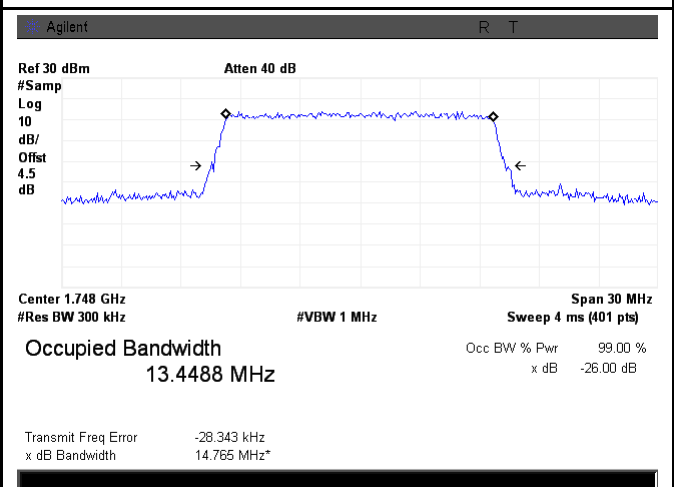

LTE band 4 - High CH 16QAM-15

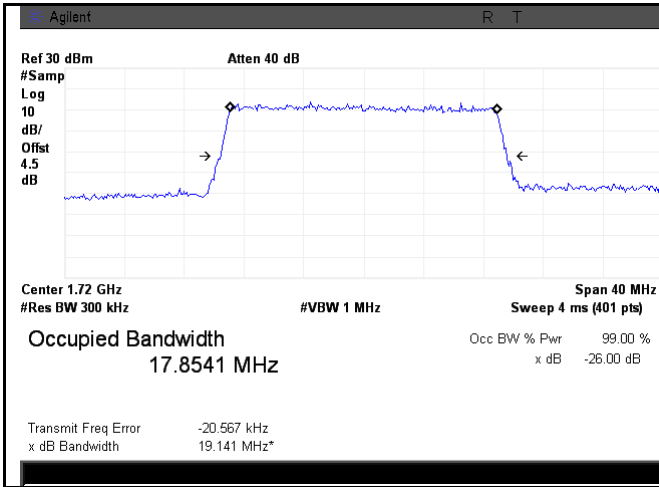

LTE band 4 - Low CH QPSK-20

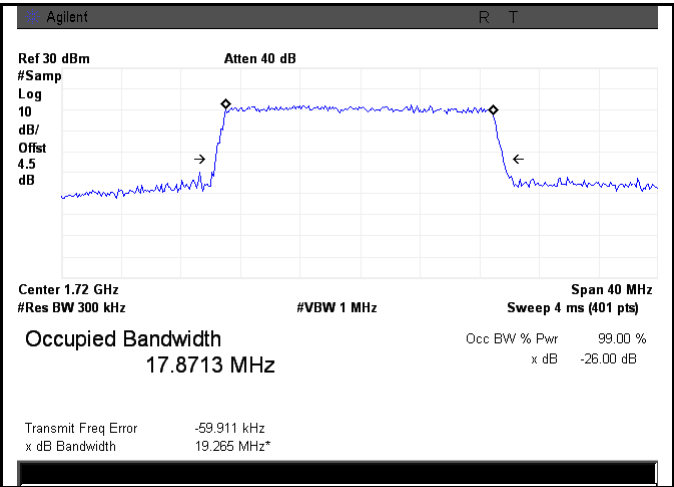

LTE band 4 - Low CH 16QAM-20

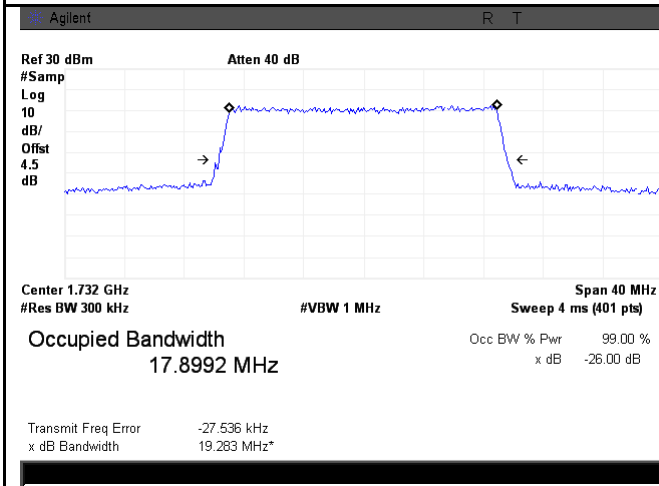

LTE band 4 - Middle CH QPSK-20

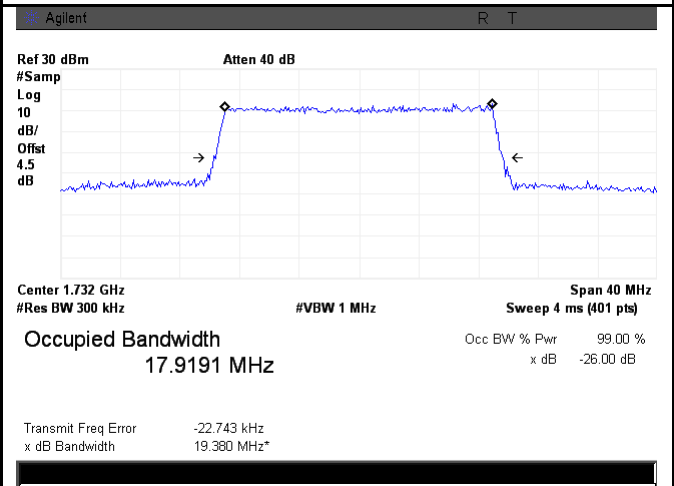

LTE band 4 - Middle CH 16QAM-20

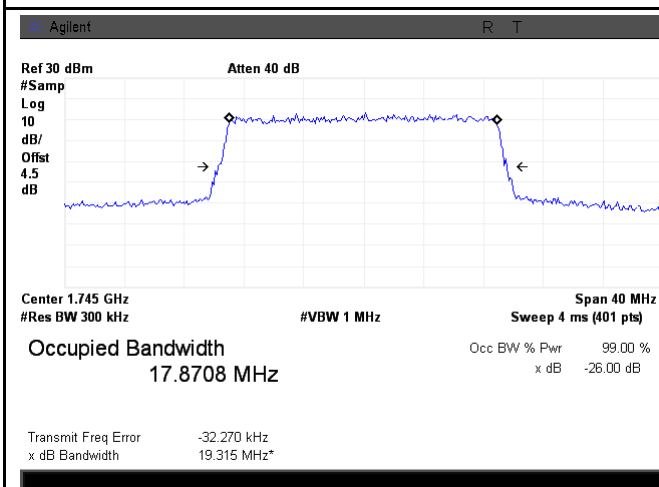

LTE band 4 - High CH QPSK-20

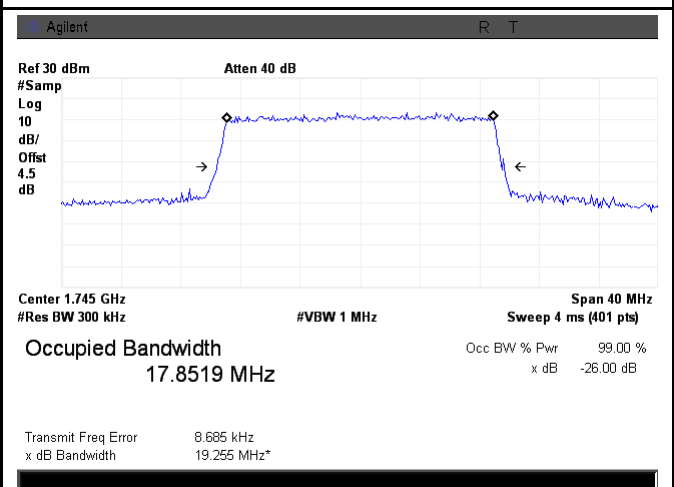

LTE band 4 - High CH 16QAM-20

LTE Band 5 (Part 22H)

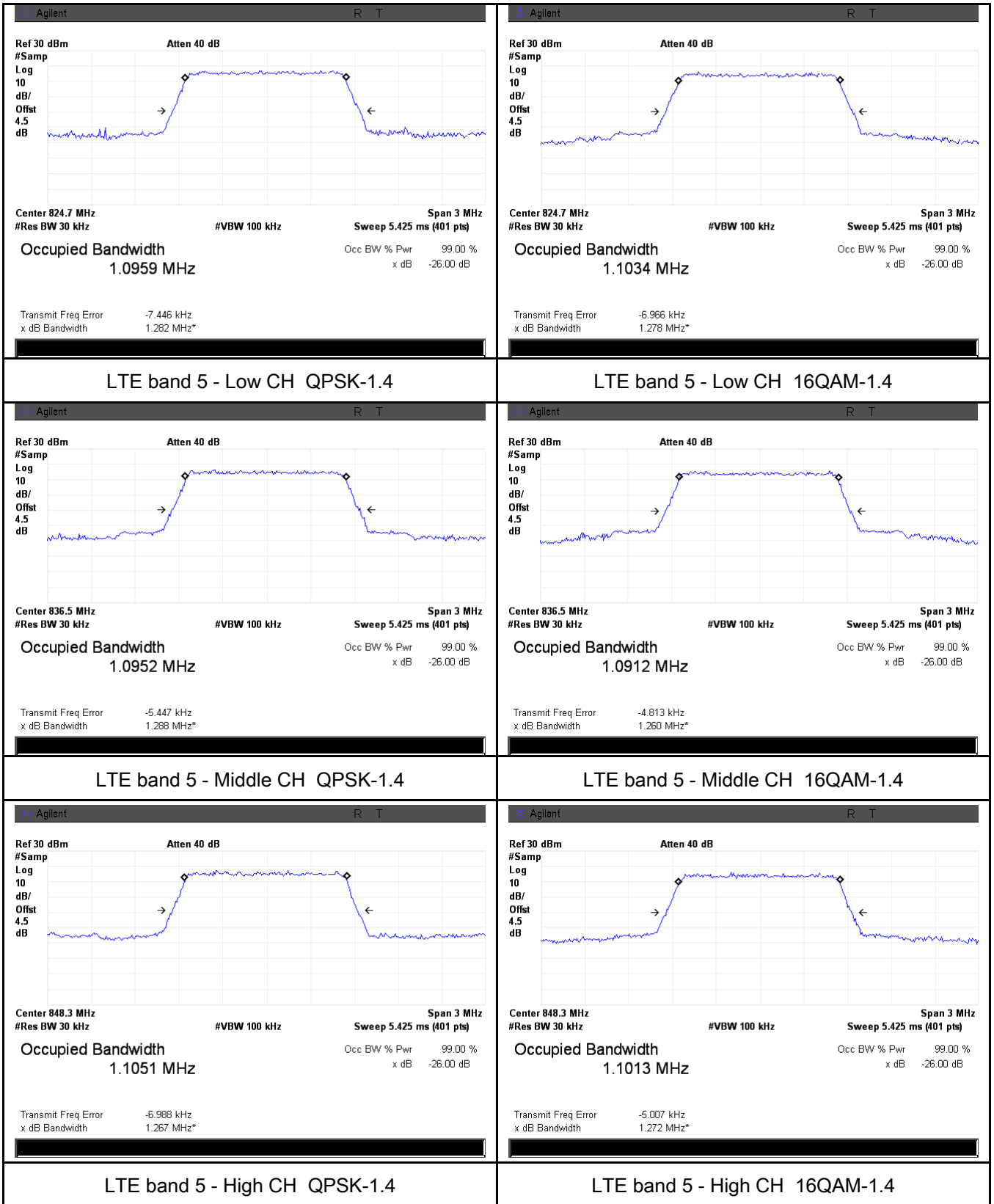

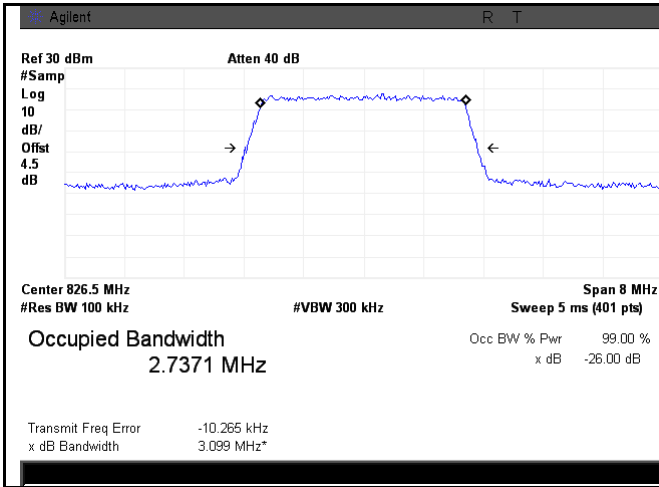

LTE band 5 - Low CH QPSK-3

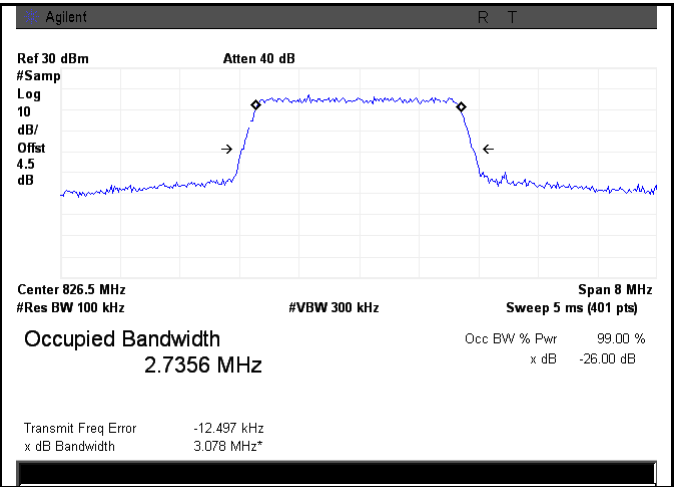

LTE band 5 - Low CH 16QAM-3

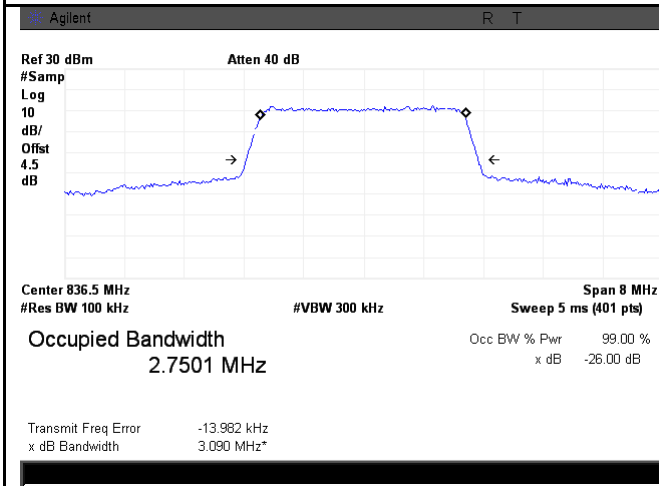

LTE band 5 - Middle CH QPSK-3

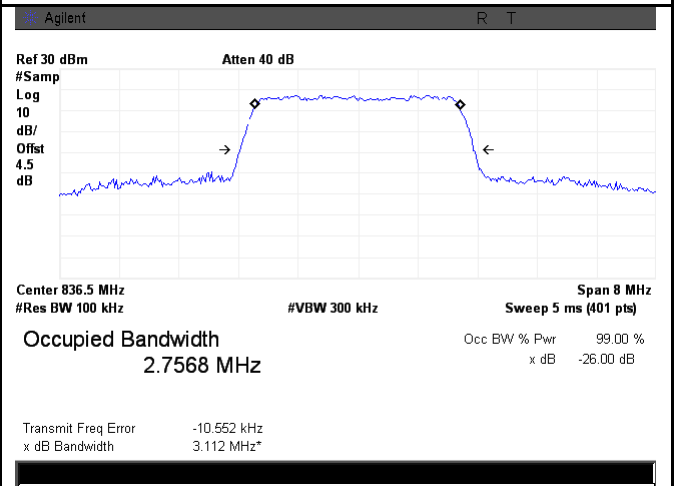

LTE band 5 - Middle CH 16QAM-3

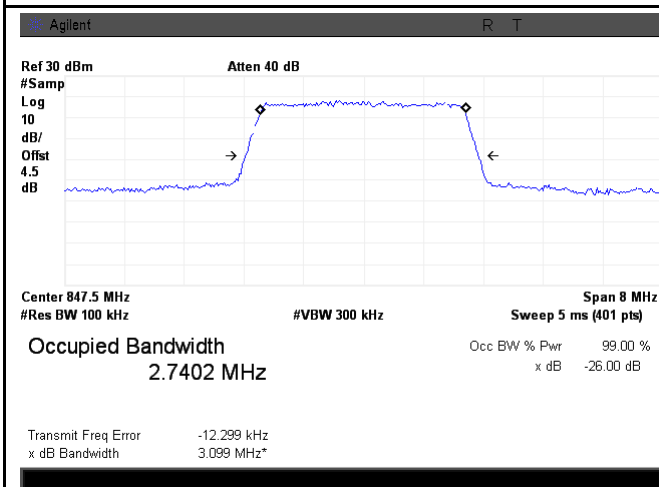

LTE band 5 - High CH QPSK-3

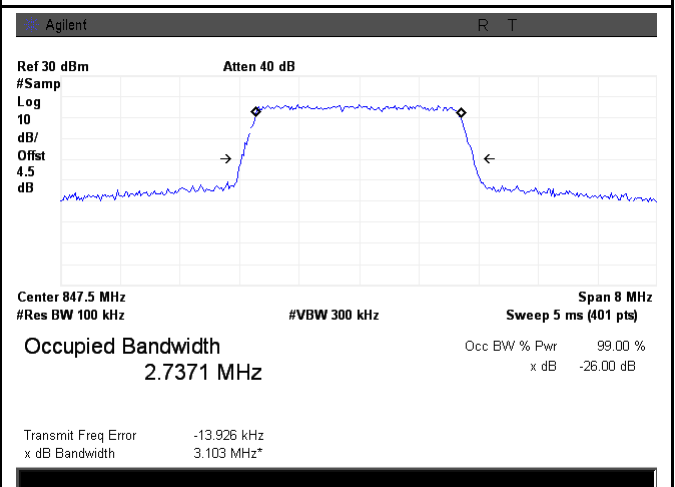

LTE band 5 - High CH 16QAM-3

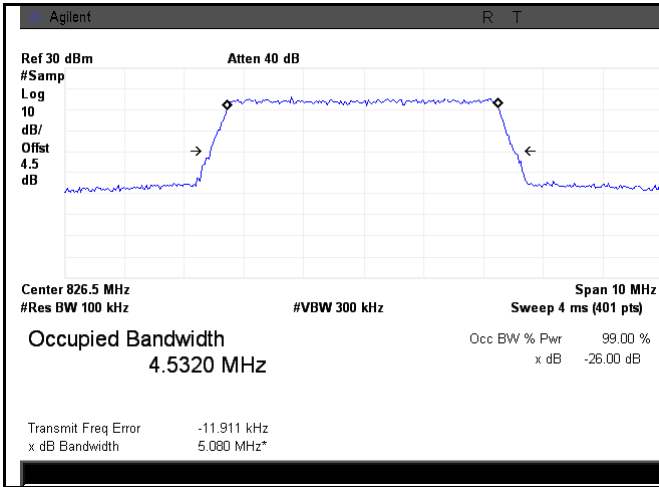

LTE band 5 - Low CH QPSK-5

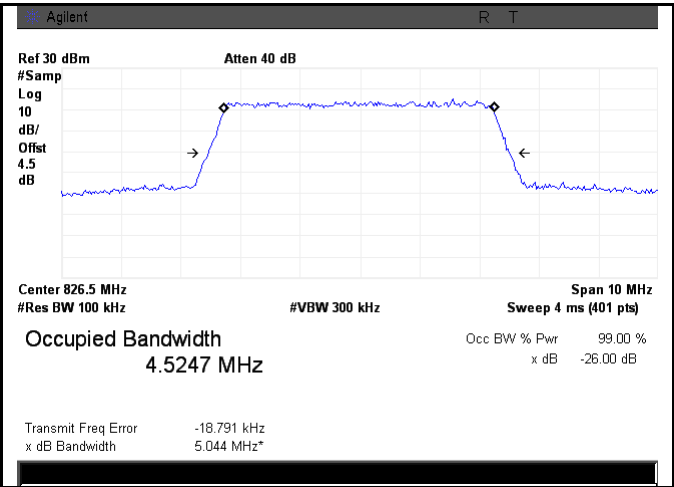

LTE band 5 - Low CH 16QAM-5

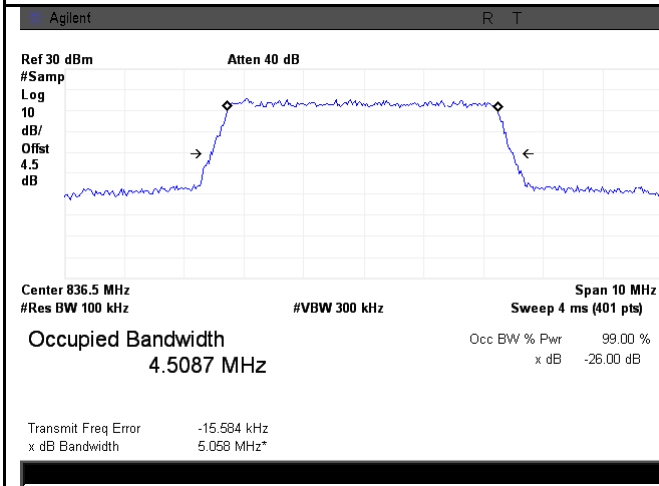

LTE band 5 - Middle CH QPSK-5

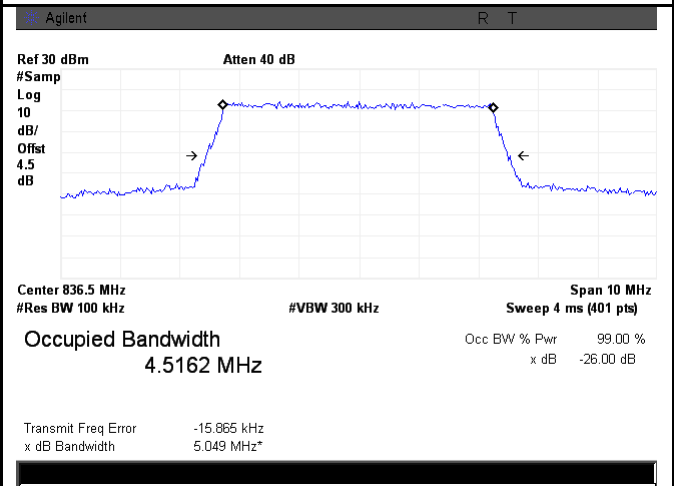

LTE band 5 - Middle CH 16QAM-5

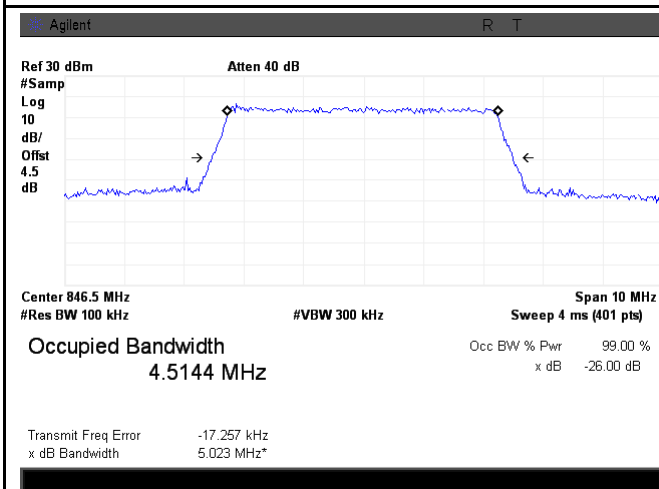

LTE band 5 - High CH QPSK-5

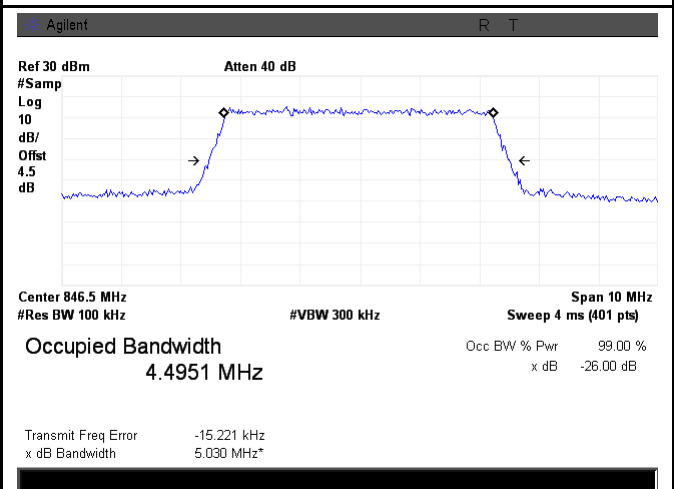

LTE band 5 - High CH 16QAM-5

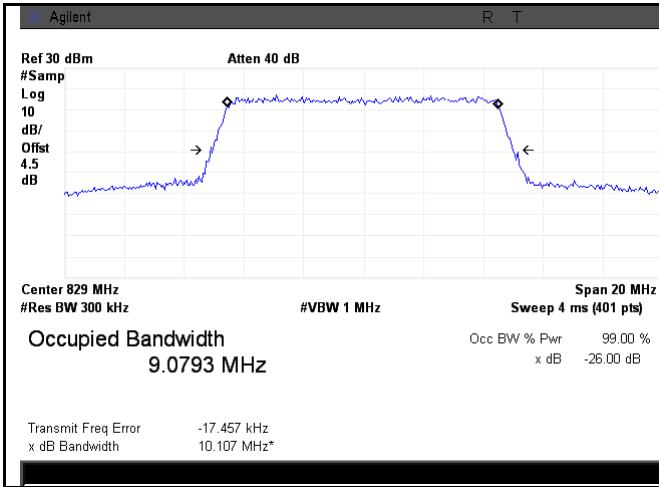

LTE band 5 - Low CH QPSK-10

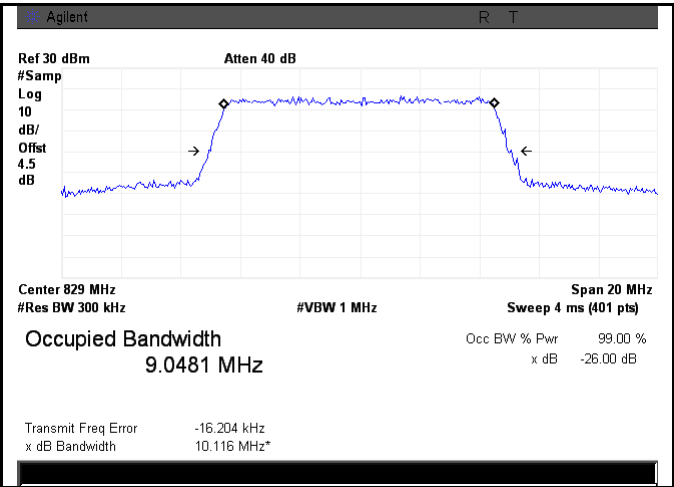

LTE band 5 - Low CH 16QAM-10

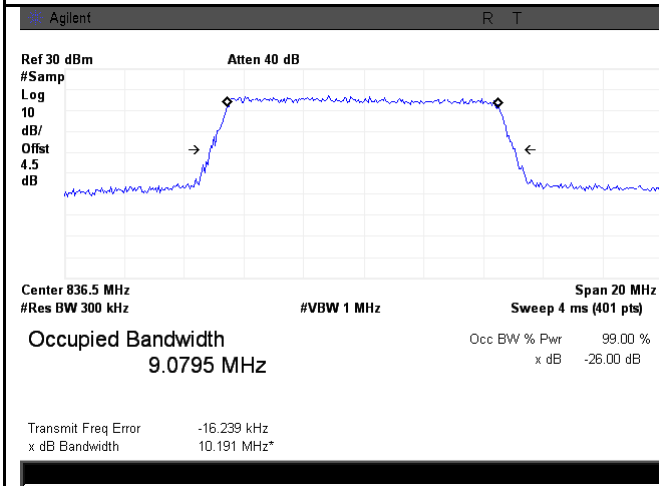

LTE band 5 - Middle CH QPSK-10

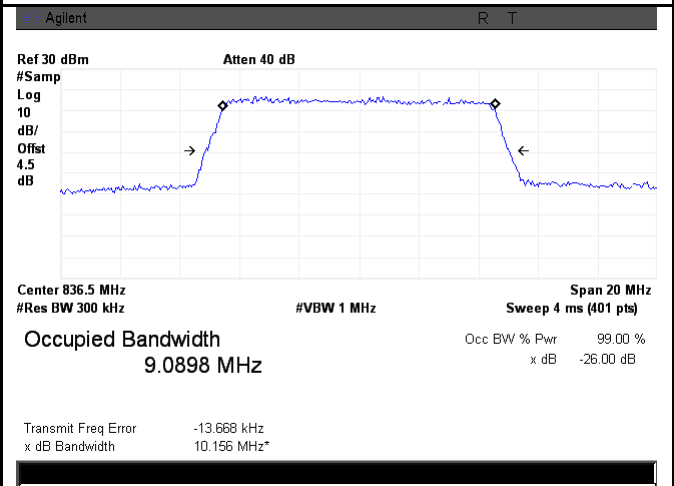

LTE band 5 - Middle CH 16QAM-10

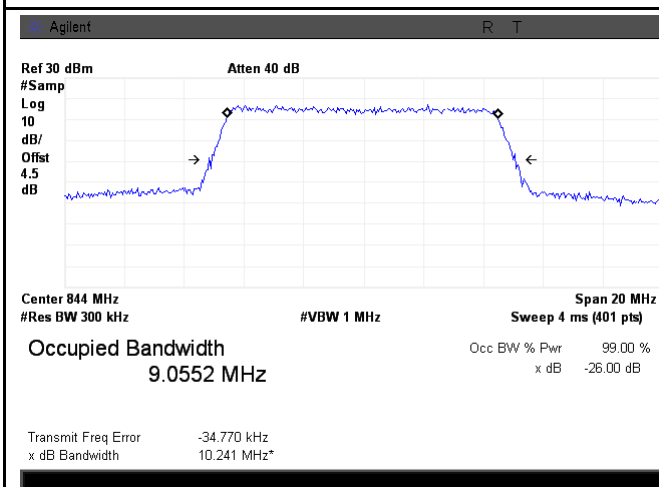

LTE band 5 - High CH QPSK-10

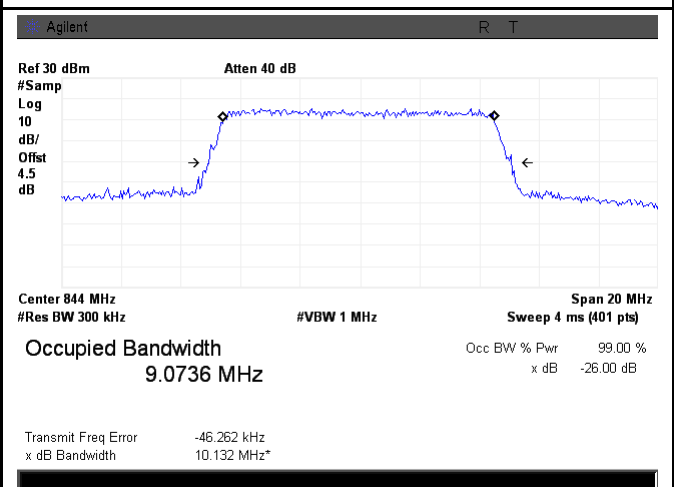

LTE band 5 - High CH 16QAM-10

LTE Band 7 (Part 27)

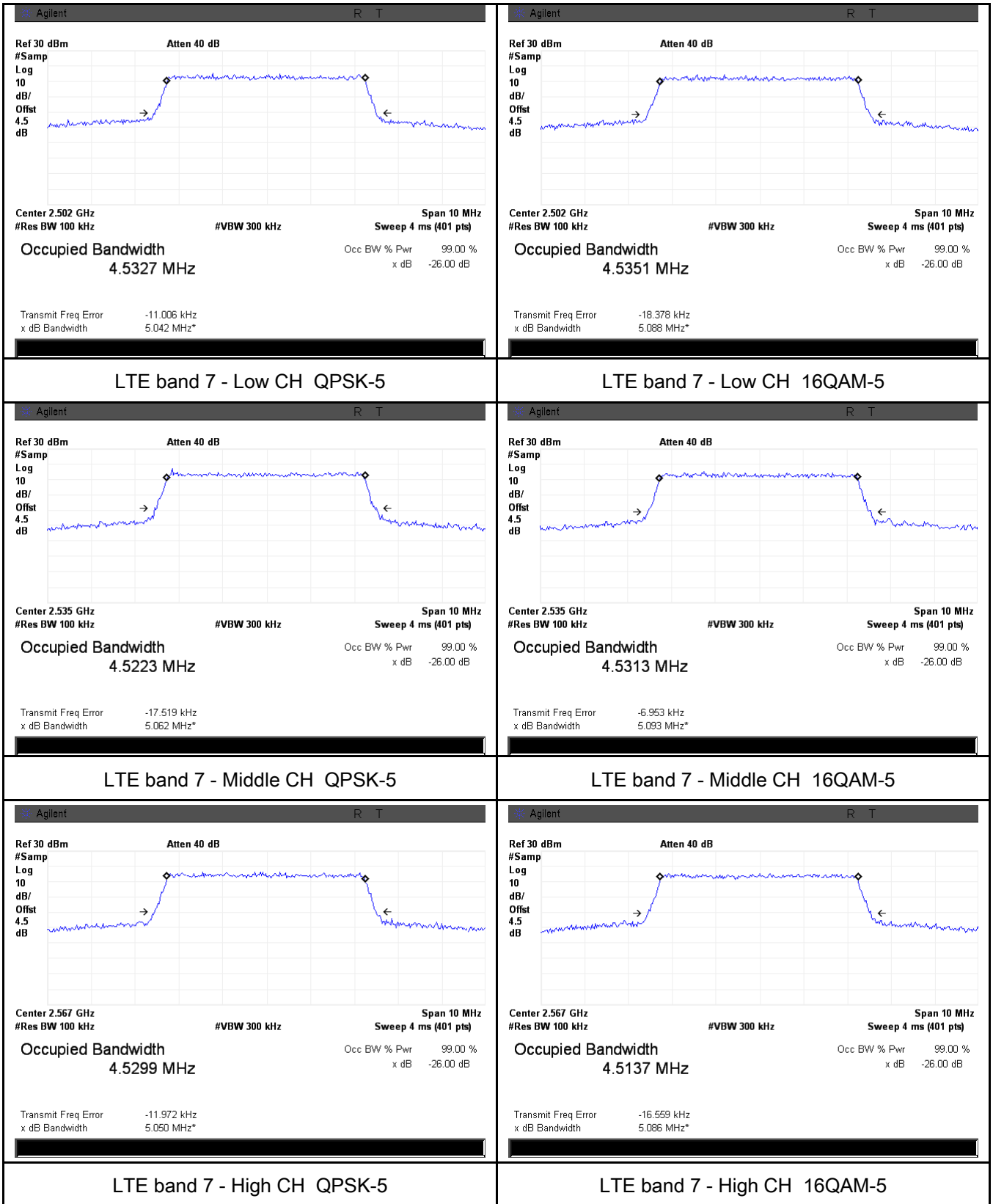

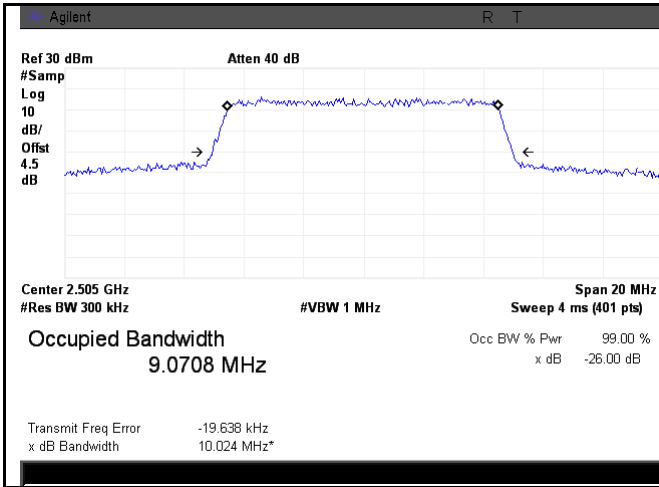

LTE band 7 - Low CH QPSK-10

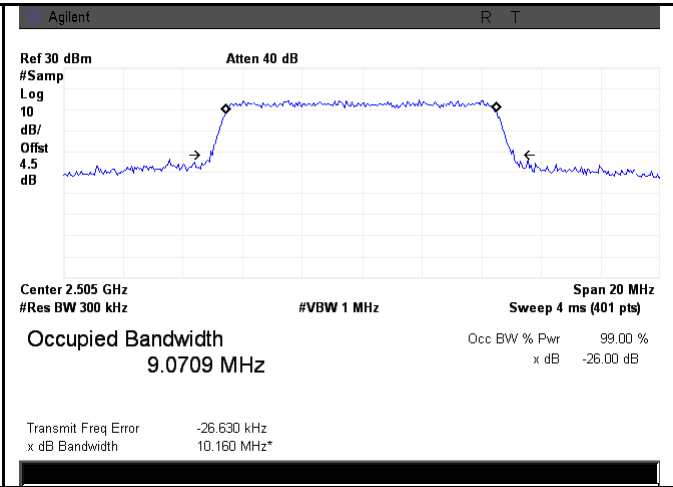

LTE band 7 - Low CH 16QAM-10

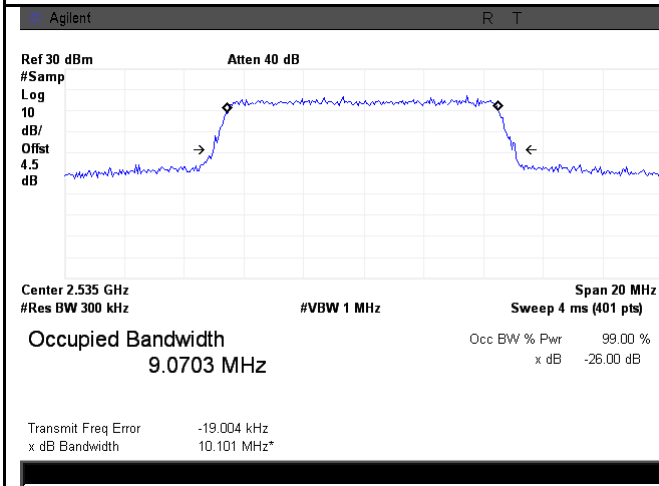

LTE band 7 - Middle CH QPSK-10

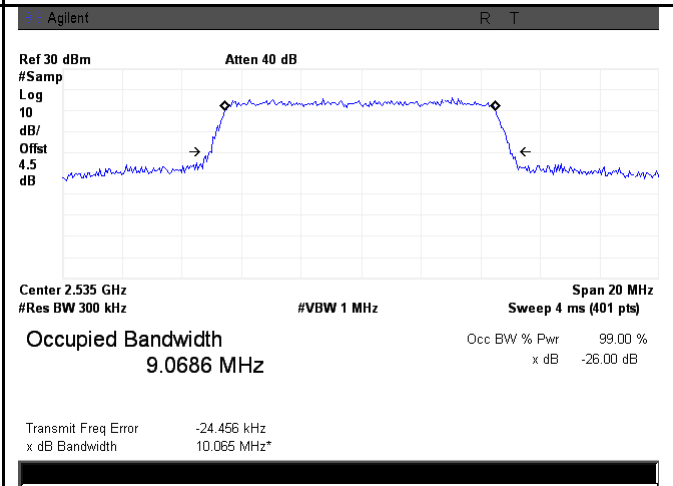

LTE band 7 - Middle CH 16QAM-10

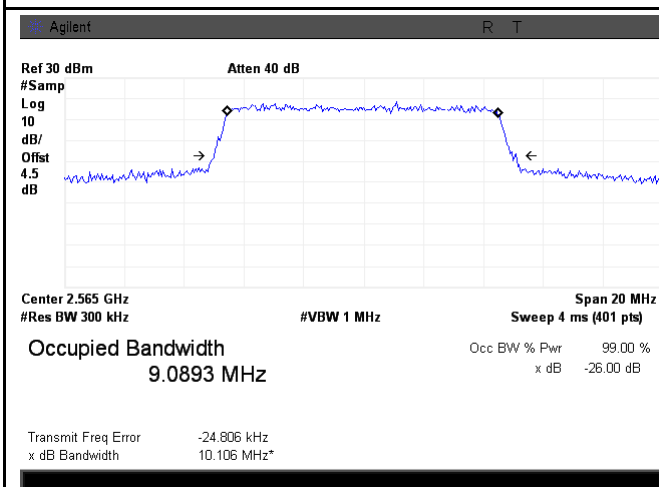

LTE band 7 - High CH QPSK-10

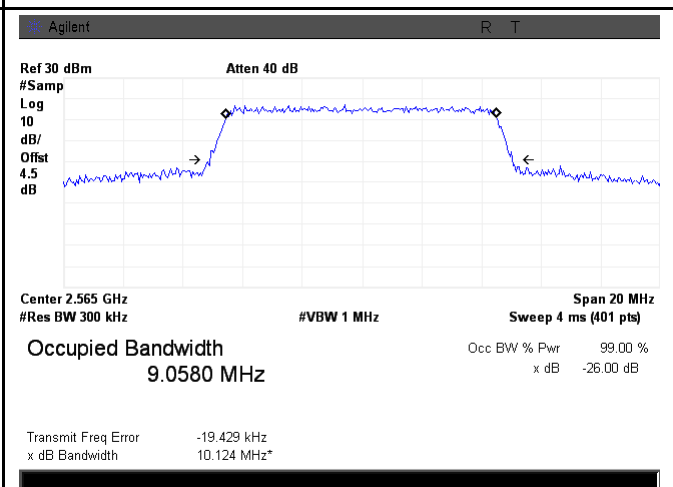

LTE band 7 - High CH 16QAM-10

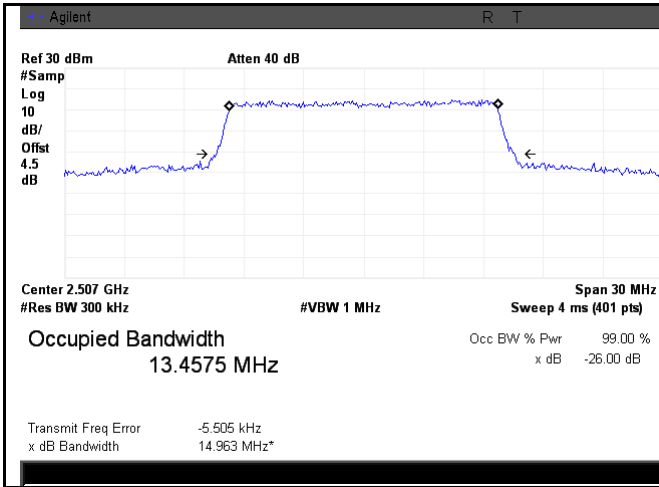

LTE band 7 - Low CH QPSK-15

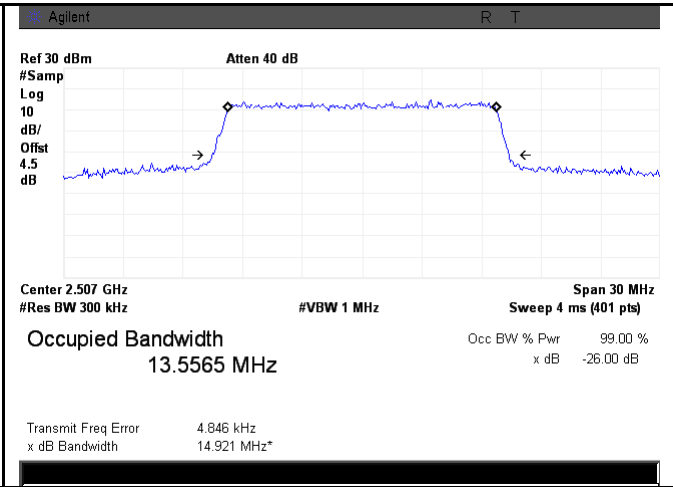

LTE band 7 - Low CH 16QAM-15

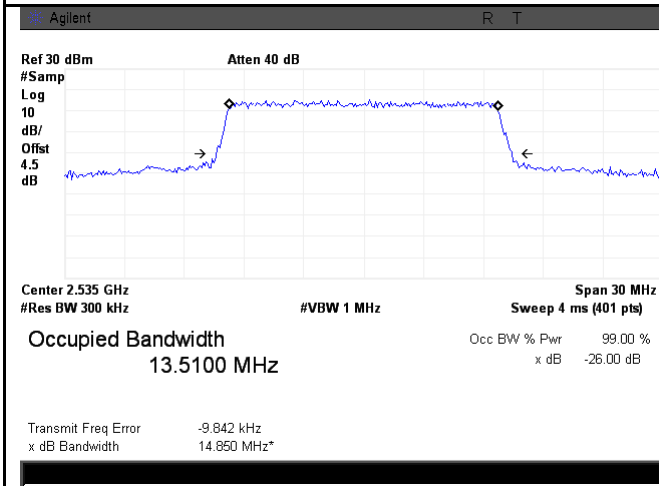

LTE band 7 - Middle CH QPSK-15

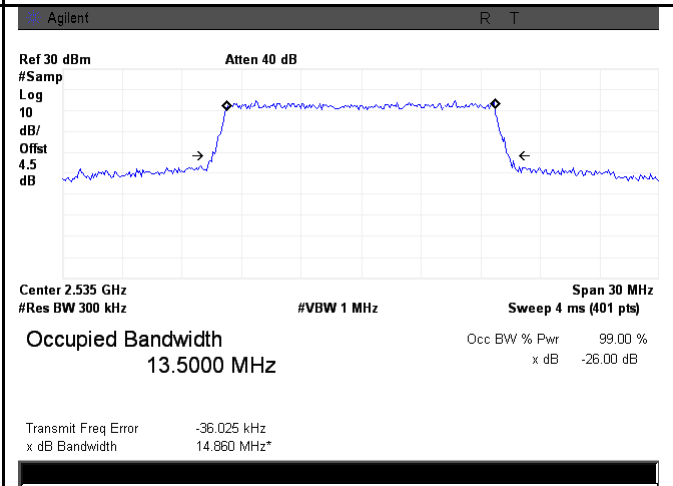

LTE band 7 - Middle CH 16QAM-15

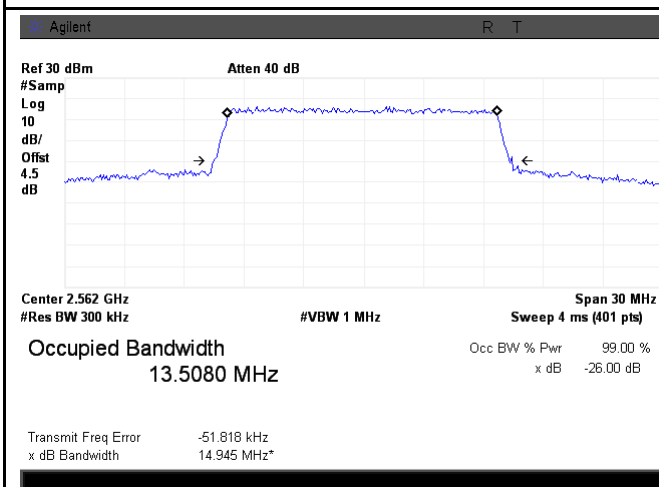

LTE band 7 - High CH QPSK-15

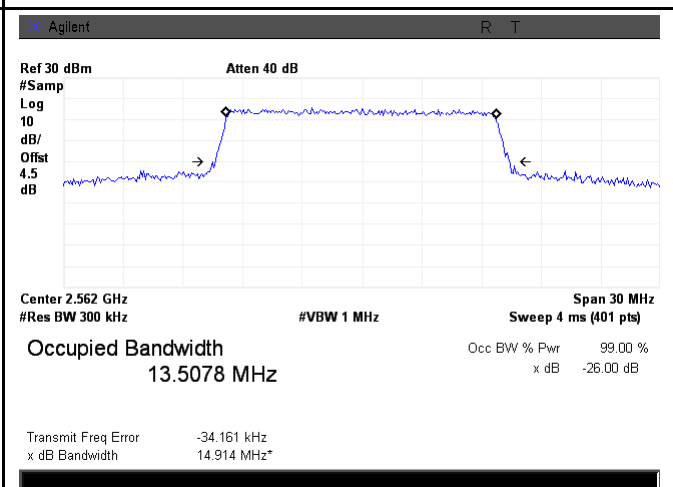

LTE band 7 - High CH 16QAM-15

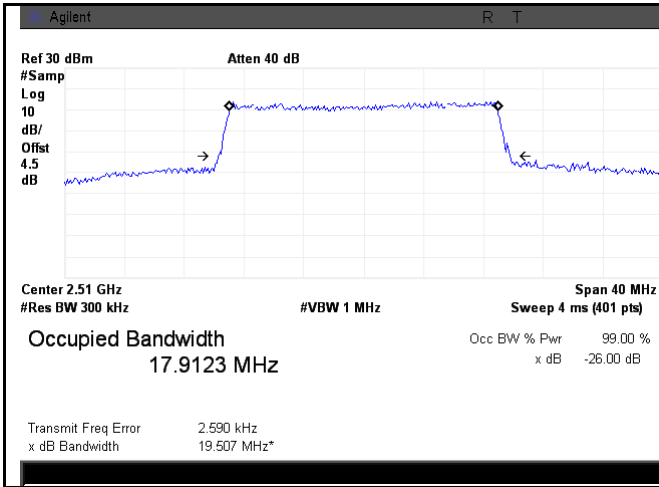

LTE band 7 - Low CH QPSK-20

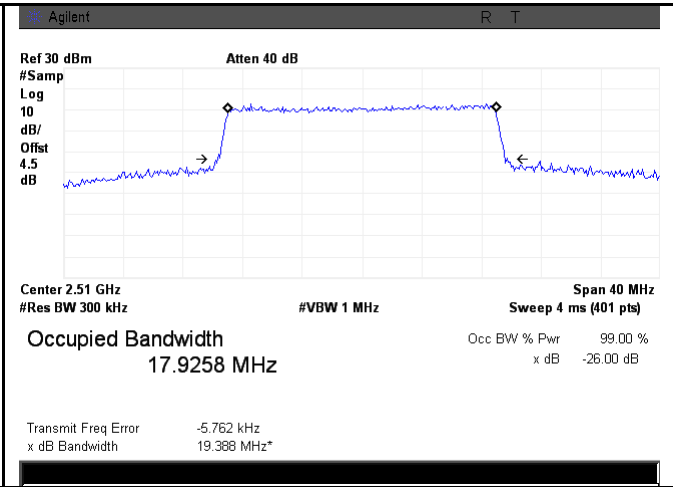

LTE band 7 - Low CH 16QAM-20

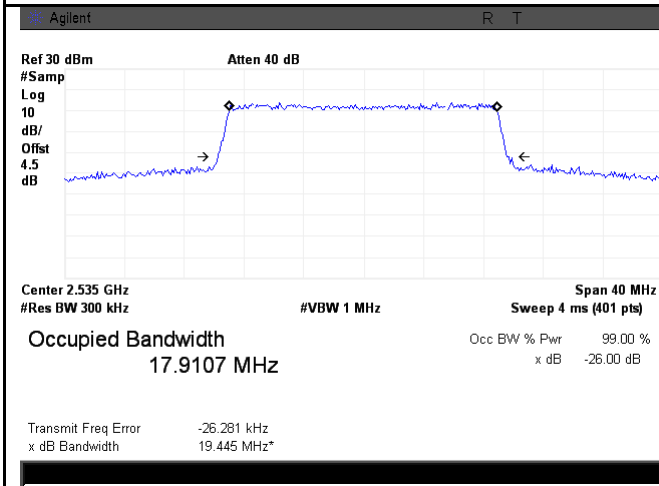

LTE band 7 - Middle CH QPSK-20

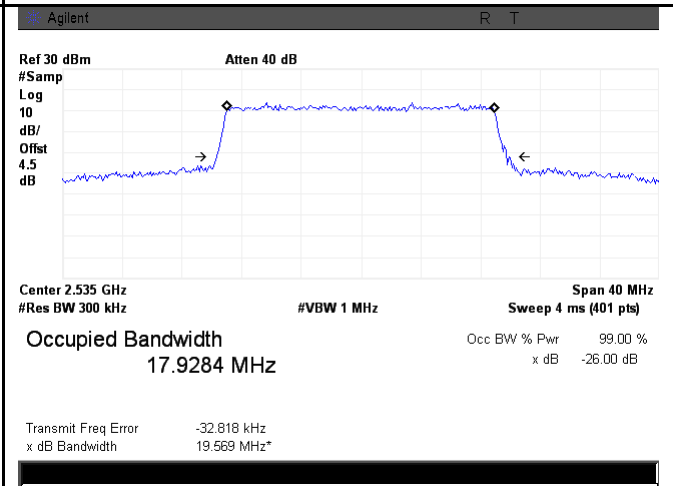

LTE band 7 - Middle CH 16QAM-20

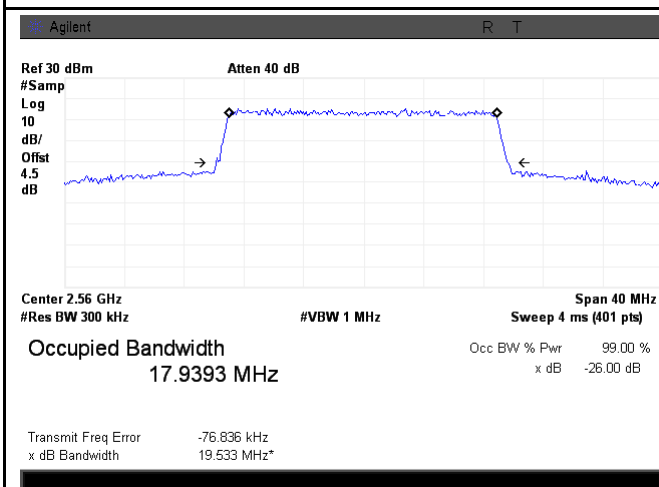

LTE band 7 - High CH QPSK-20

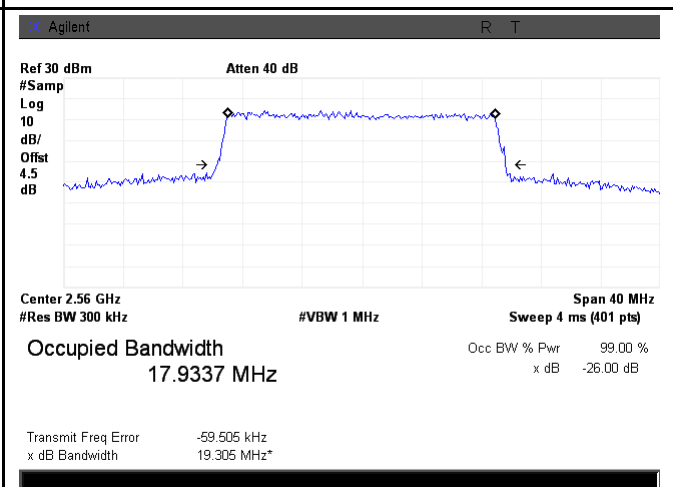

LTE band 7 - High CH 16QAM-20

LTE Band 12 (Part 27)

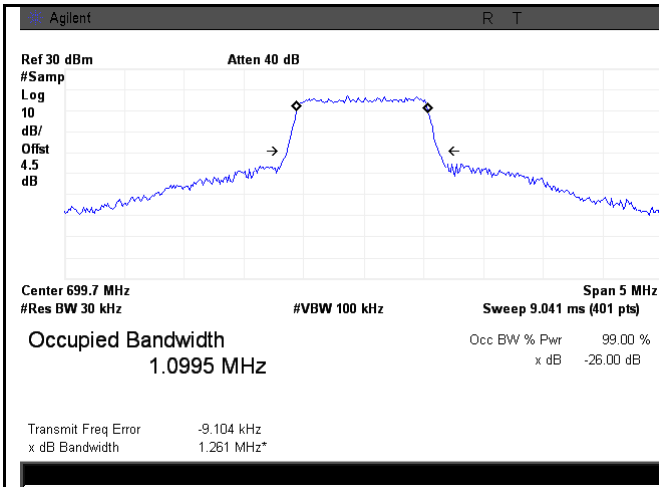

LTE band 12 - Low CH QPSK-1.4

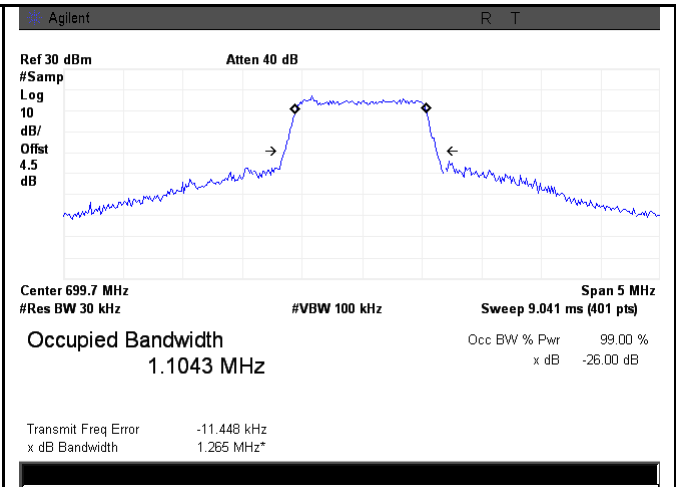

LTE band 12 - Low CH 16QAM-1.4

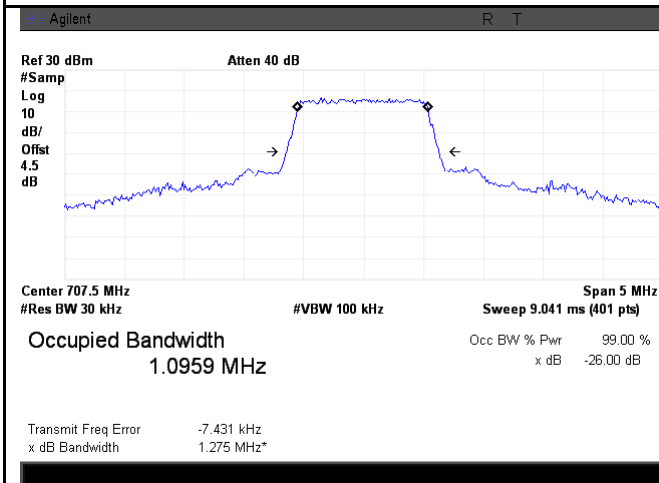

LTE band 12 - Middle CH QPSK-1.4

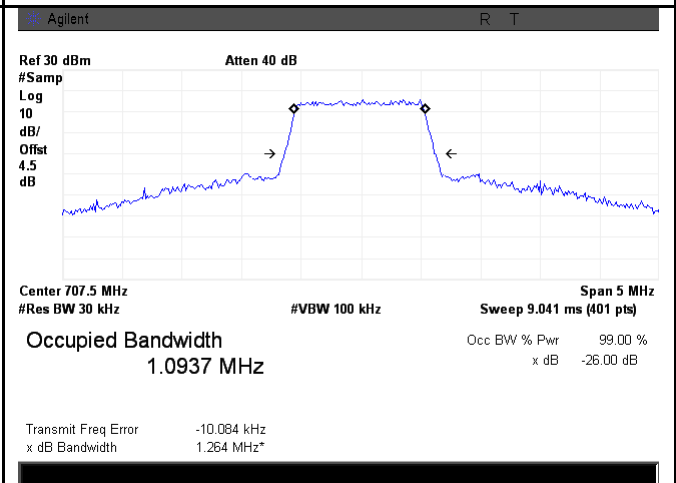

LTE band 12 - Middle CH 16QAM-1.4

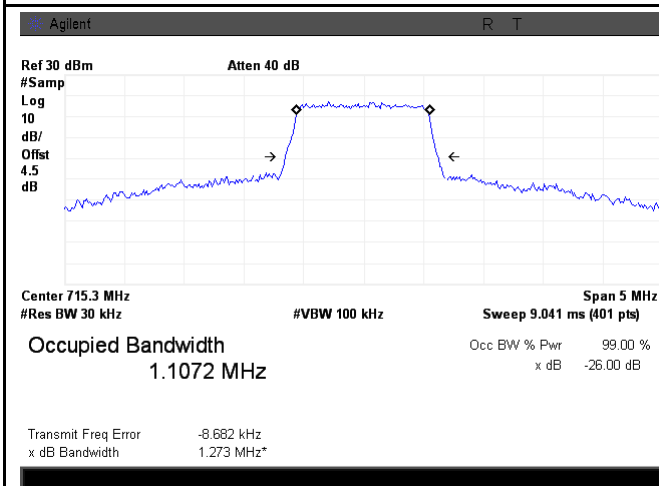

LTE band 12 - High CH QPSK-1.4

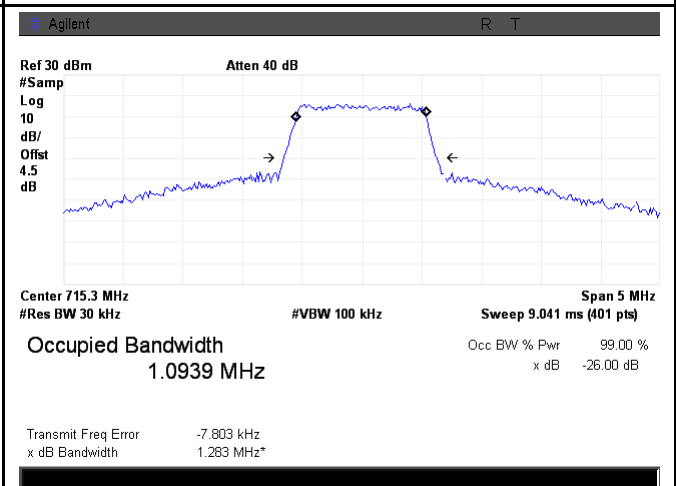

LTE band 12 - High CH 16QAM-1.4

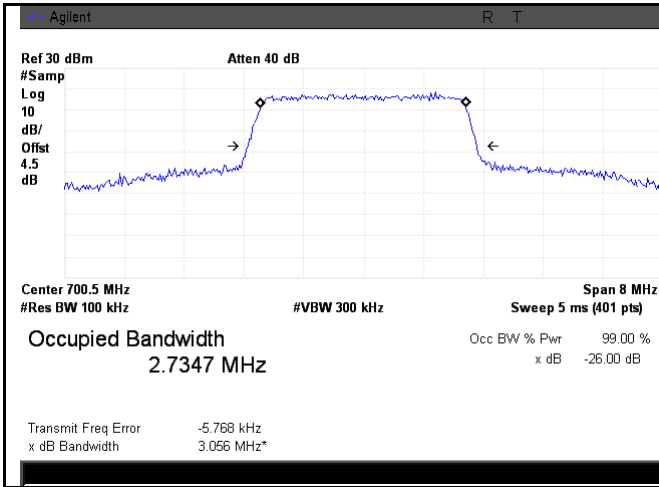

LTE band 12 - Low CH QPSK-3

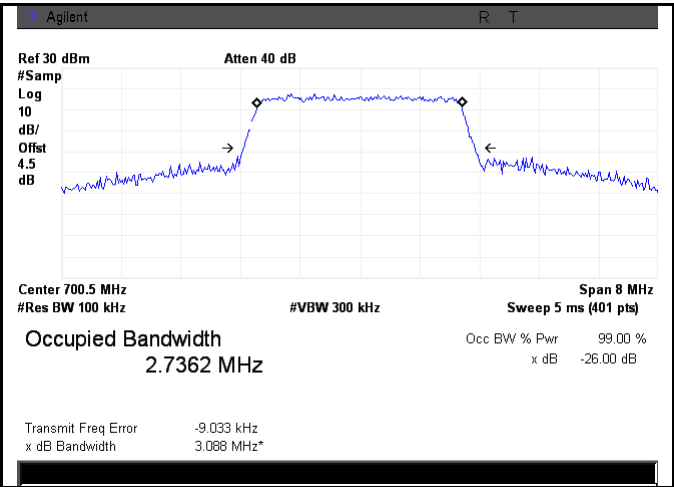

LTE band 12 - Low CH 16QAM-3

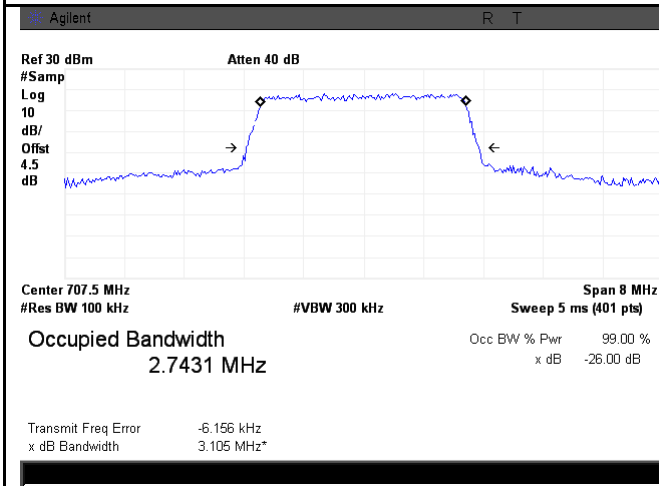

LTE band 12 - Middle CH QPSK-3

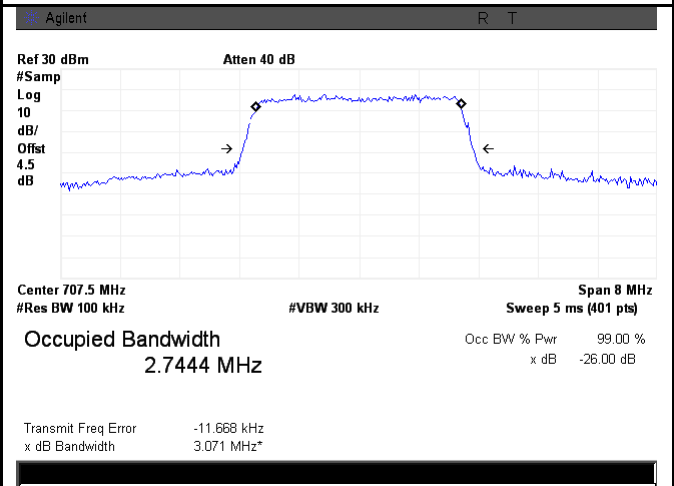

LTE band 12 - Middle CH 16QAM-3

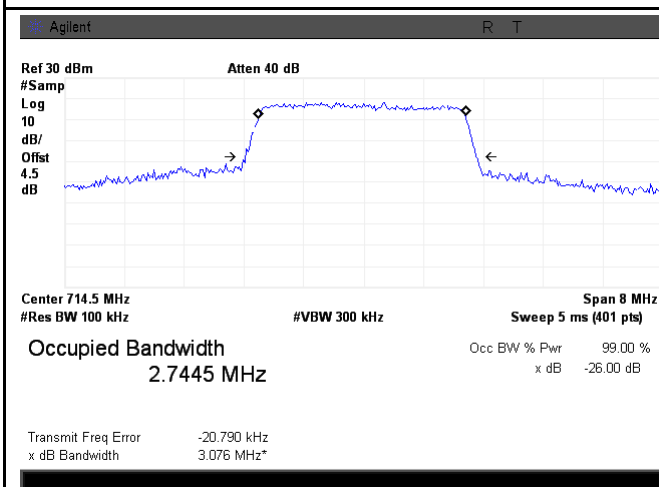

LTE band 12 - High CH QPSK-3

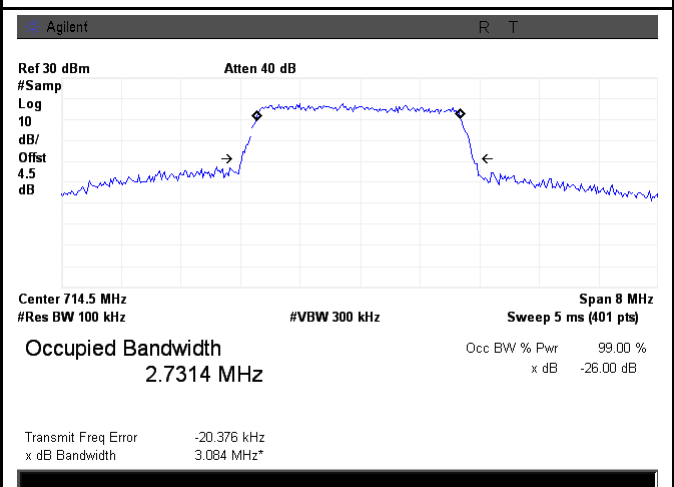

LTE band 12 - High CH 16QAM-3

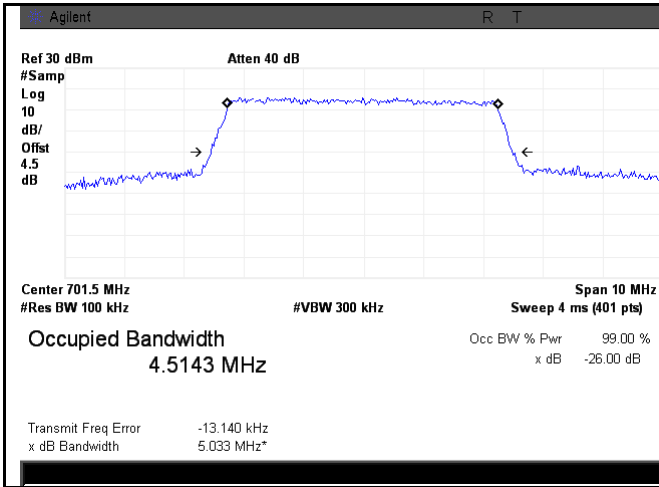

LTE band 12 - Low CH QPSK-5

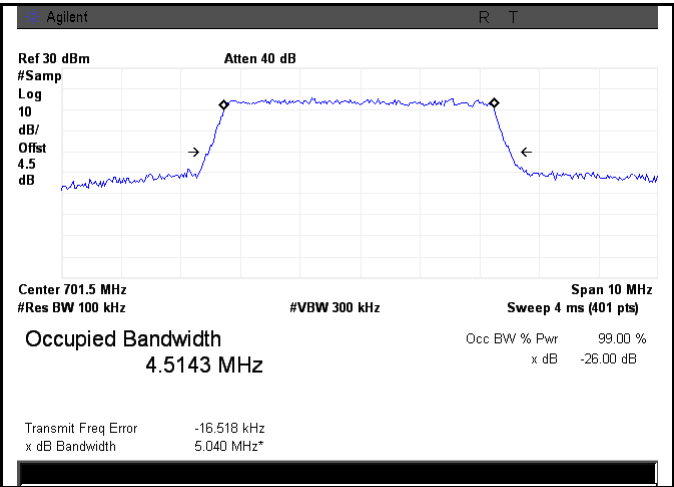

LTE band 12 - Low CH 16QAM-5

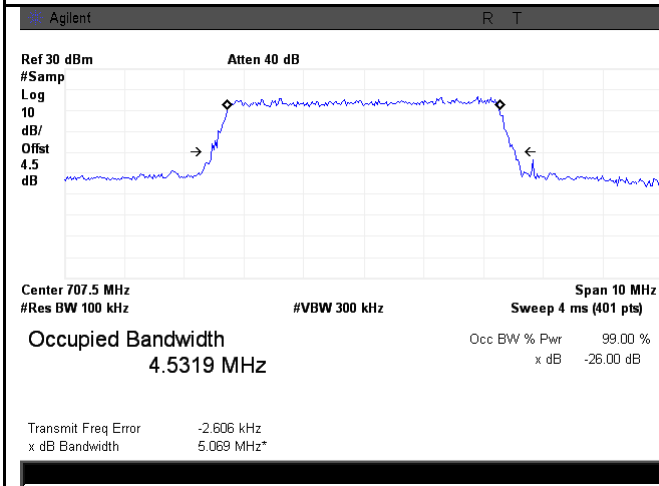

LTE band 12 - Middle CH QPSK-5

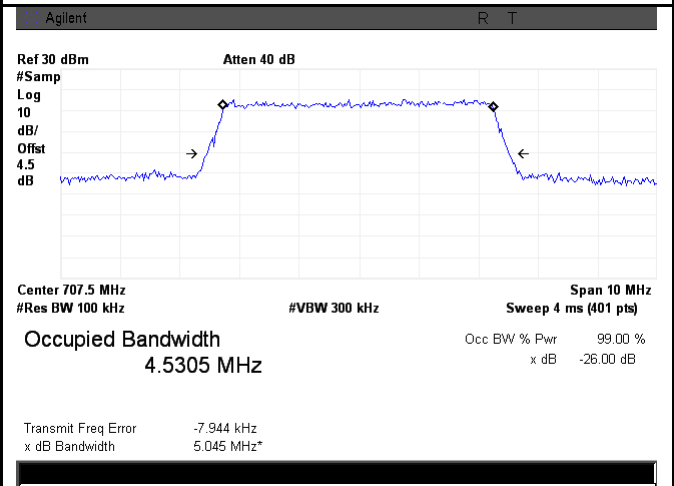

LTE band 12 - Middle CH 16QAM-5

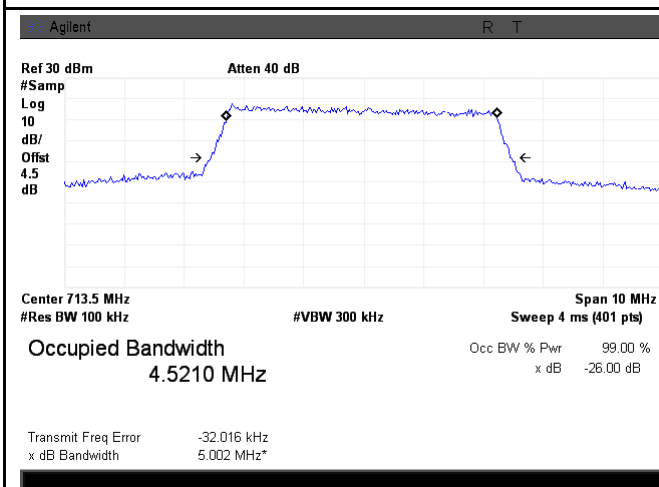

LTE band 12 - High CH QPSK-5

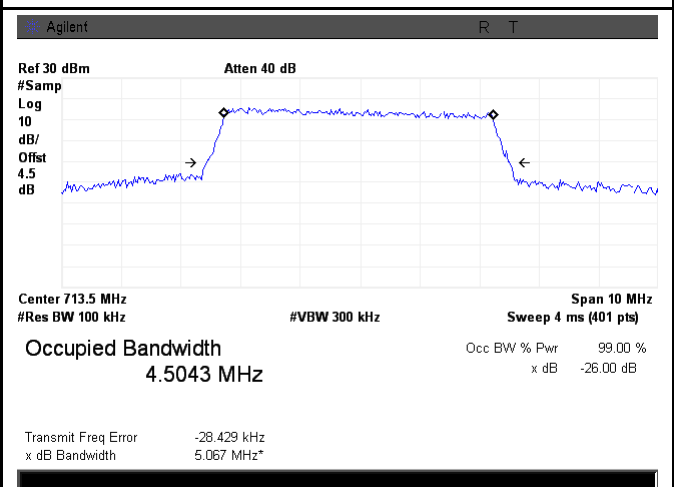

LTE band 12 - High CH 16QAM-5

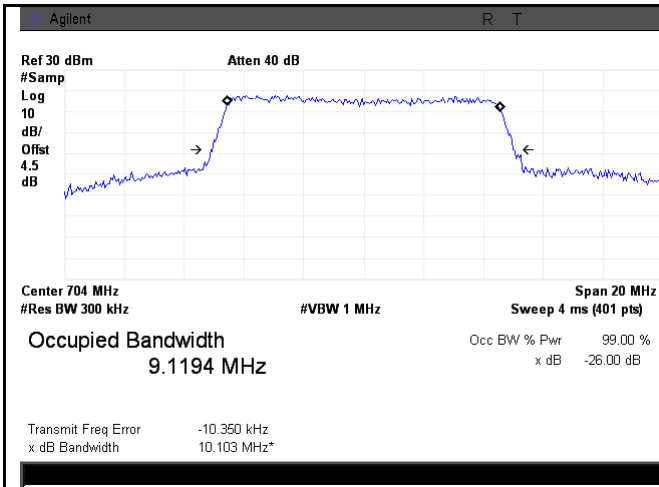

LTE band 12 - Low CH QPSK-10

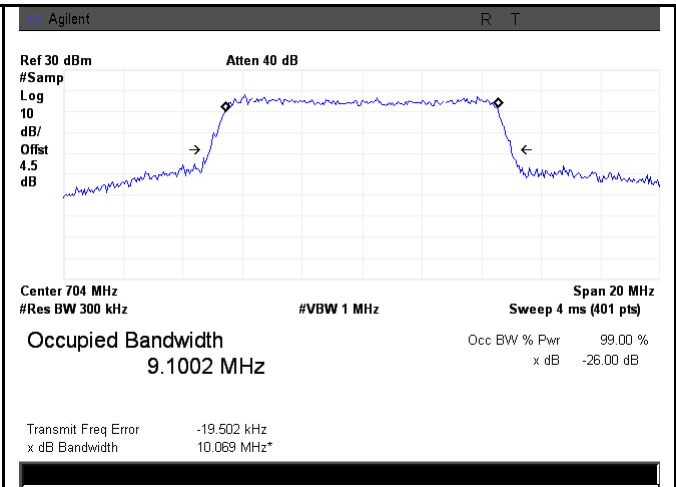

LTE band 12 - Low CH 16QAM-10

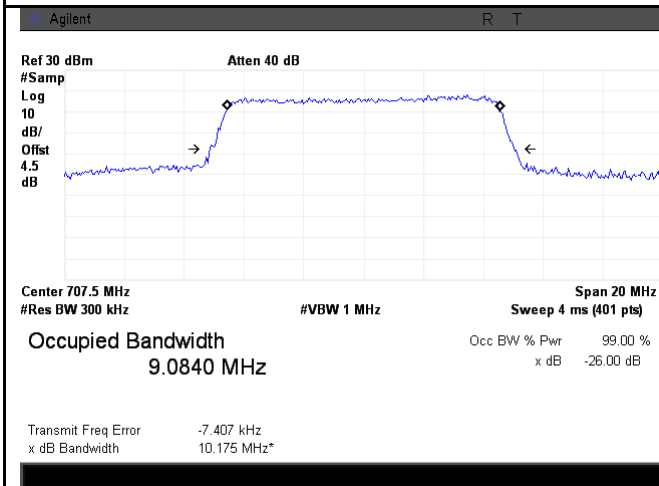

LTE band 12 - Middle CH QPSK-10

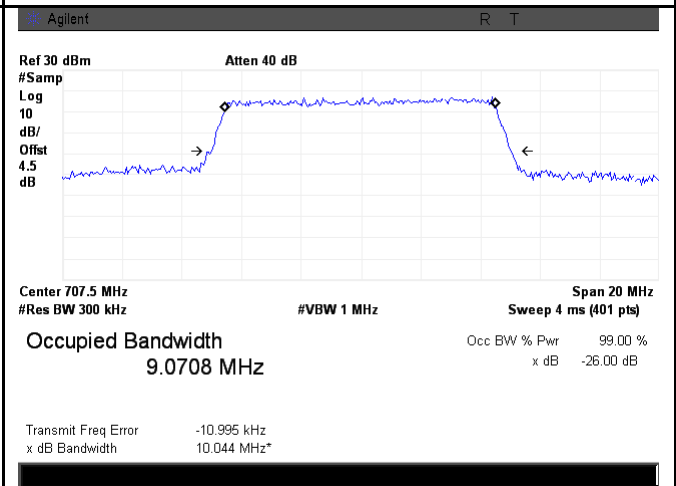

LTE band 12 - Middle CH 16QAM-10

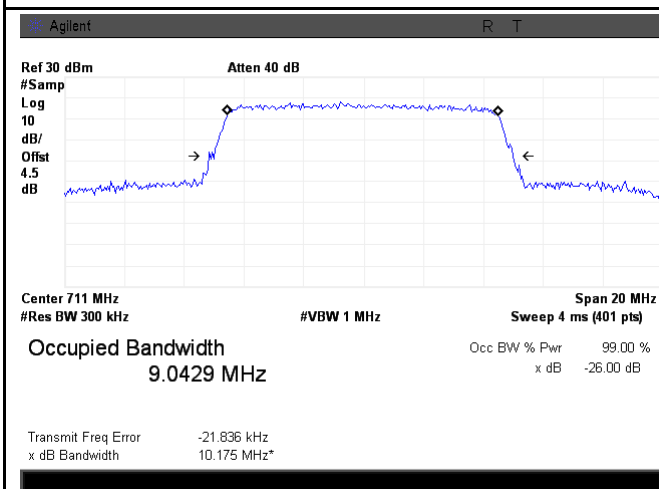

LTE band 12 - High CH QPSK-10

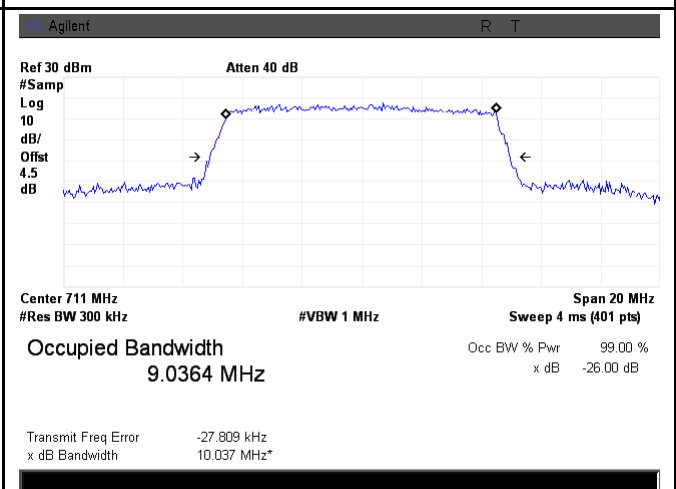

LTE band 12 - High CH 16QAM-10

LTE Band 17 (Part 27)

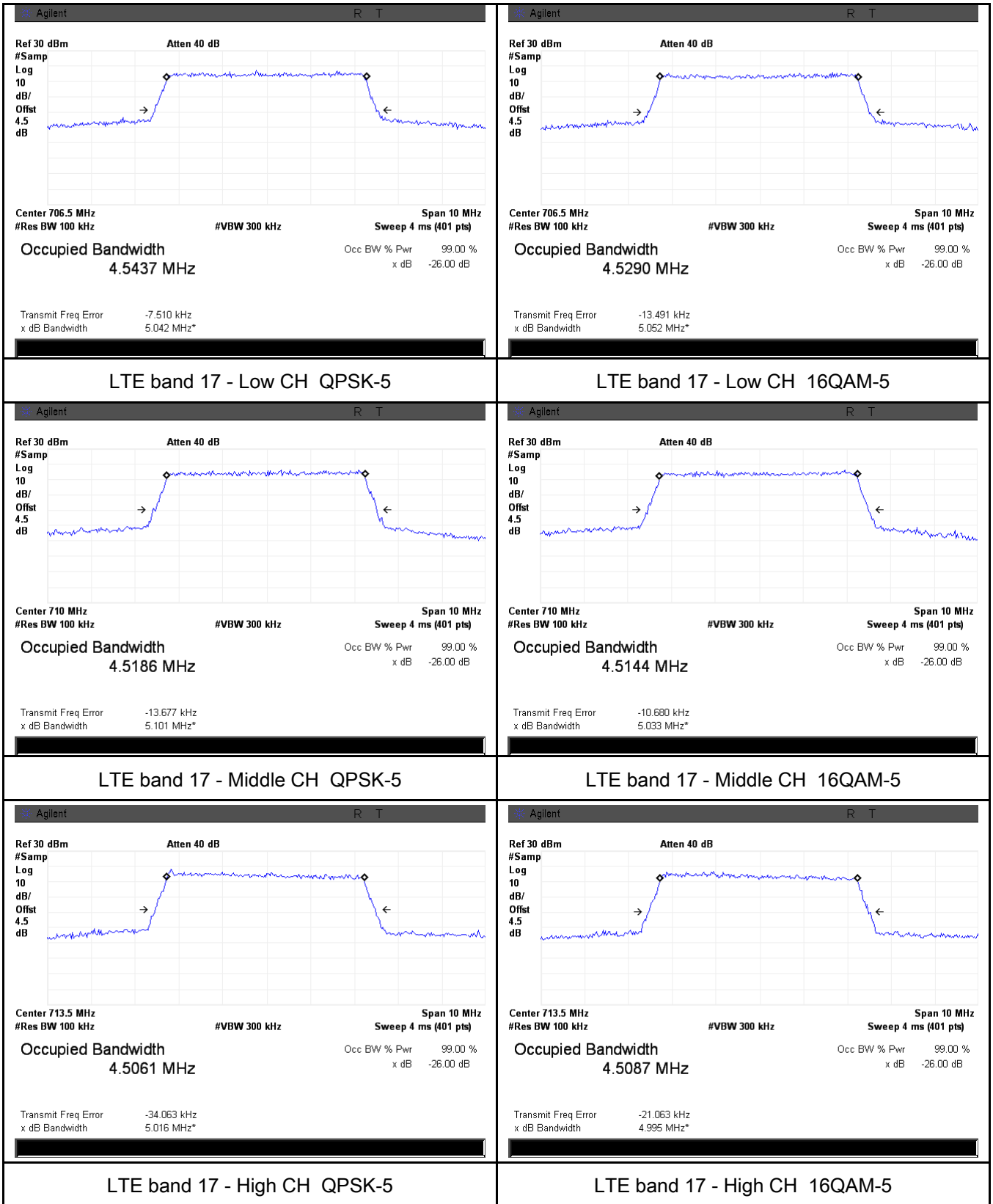

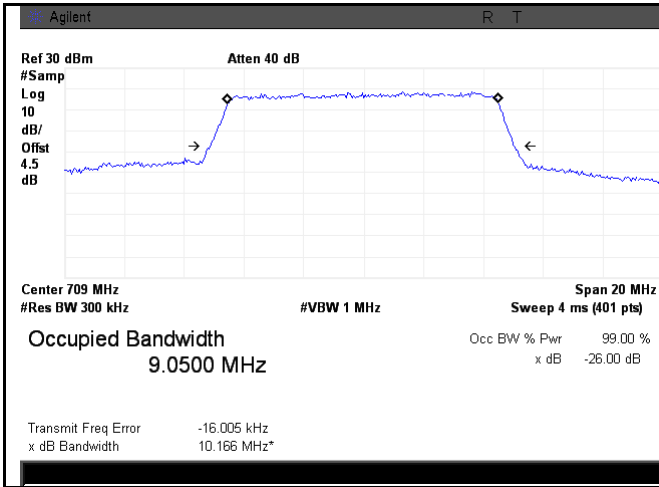

LTE band 17 - Low CH QPSK-10

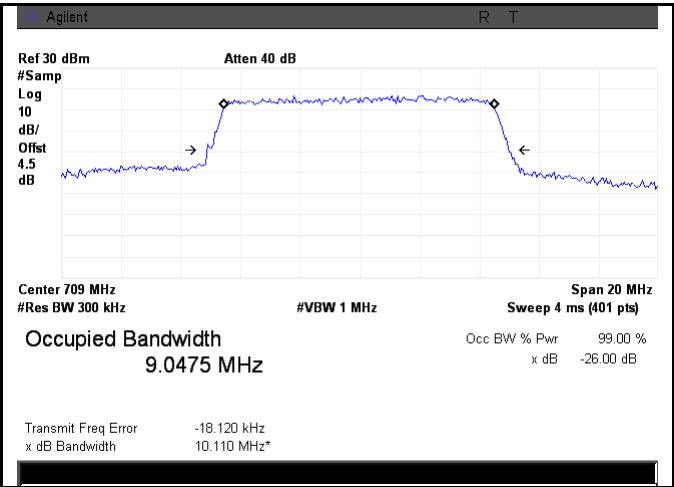

LTE band 17 - Low CH 16QAM-10

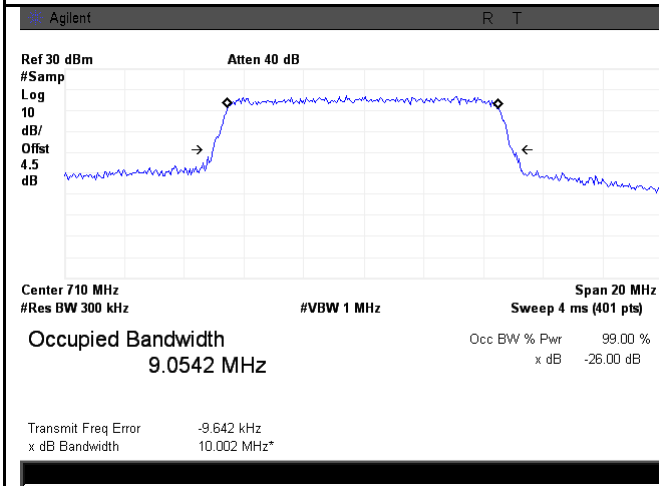

LTE band 17 - Middle CH QPSK-10

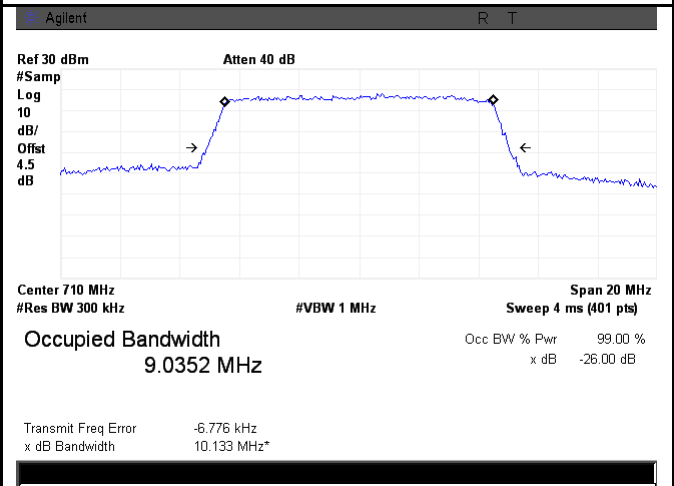

LTE band 17 - Middle CH 16QAM-10

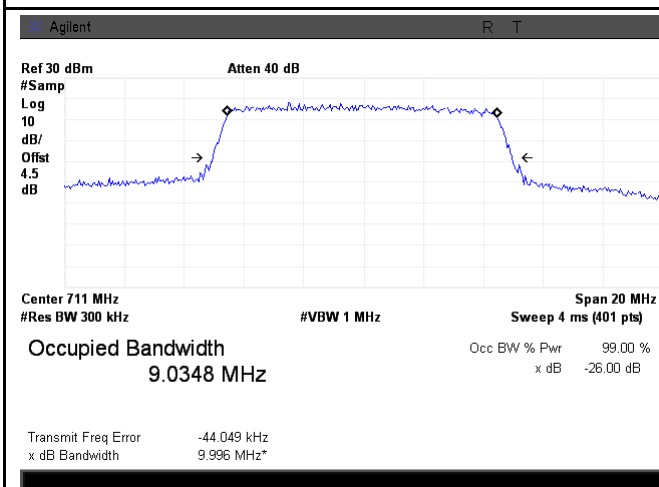

LTE band 17 - High CH QPSK-10

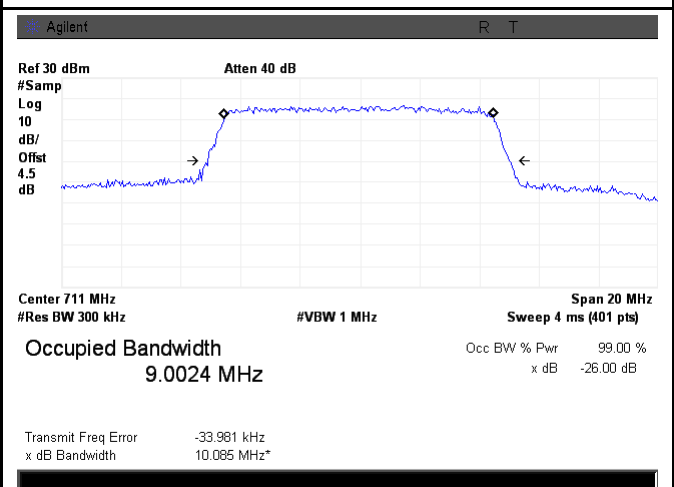

LTE band 17 - High CH 16QAM-10

6.5 Spurious Emissions at Antenna Terminals

Temperature	24°C
Relative Humidity	56%
Atmospheric Pressure	1023mbar
Test date :	December 23, 2015
Tested By :	Winnie Zhang

Requirement(s):

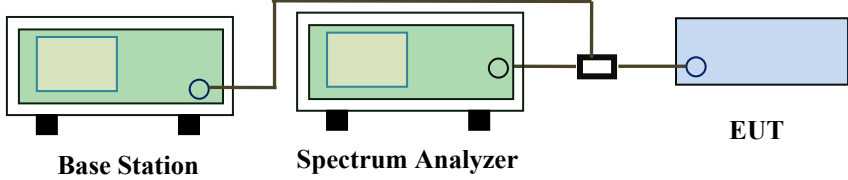
Spec	Item	Requirement	Applicable
§2.1051, §22.917(a)& §24.238(a) § 27.53(h)	a)	The power of any emission outside of the authorized operating frequency ranges must be lower than the transmitter power (P) by a factor of at least $43 + 10 \log (P)$ dB	<input checked="" type="checkbox"/>
Test Setup	 <p>The diagram illustrates the test setup. On the left is a green box labeled 'Base Station'. In the middle is a green box labeled 'Spectrum Analyzer'. On the right is a blue box labeled 'EUT'. A power divider is connected between the Spectrum Analyzer and the EUT. The Base Station is connected to the Spectrum Analyzer.</p>		
Test Procedure	<ul style="list-style-type: none"> - The EUT was connected to Spectrum Analyzer and Base Station via power divider. - The Band Edges of low and high channels for the highest RF powers were measured. - Setting RBW as roughly BW/100. 		
Remark			
Result	<input checked="" type="checkbox"/> Pass <input type="checkbox"/> Fail		

Test Data Yes N/A
 Test Plot Yes (See below) N/A

Test Plots 30MHz-5GHz
LTE Band 2 (Part 24E)

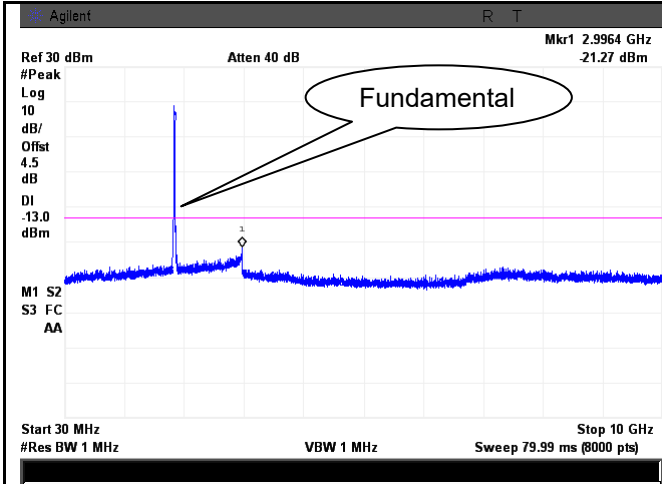

LTE Band 2 - Low Channel-1

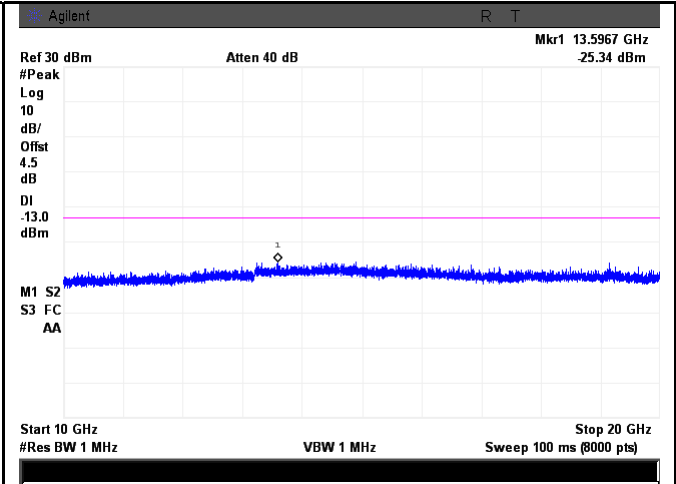

LTE Band 2 - Low Channel-2

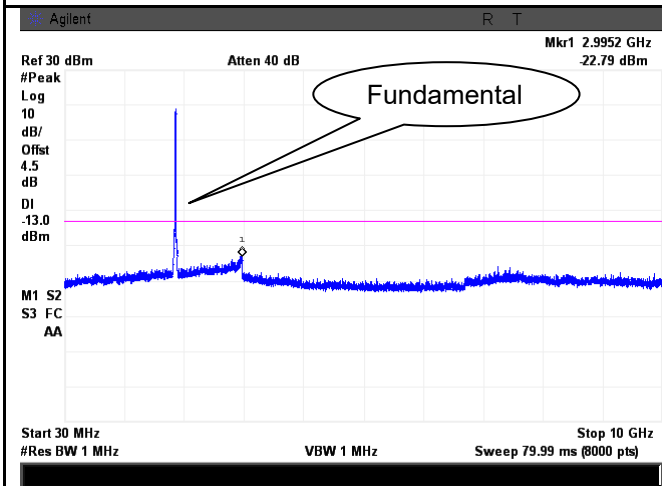

LTE Band 2 Middle Channel-1

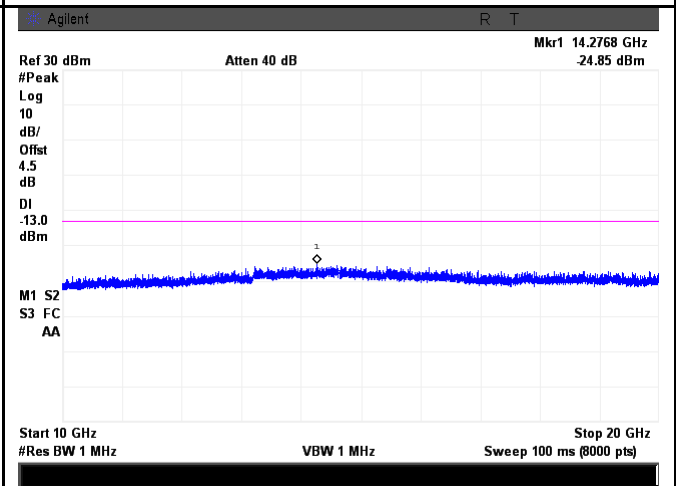

LTE Band 2 Middle Channel-2

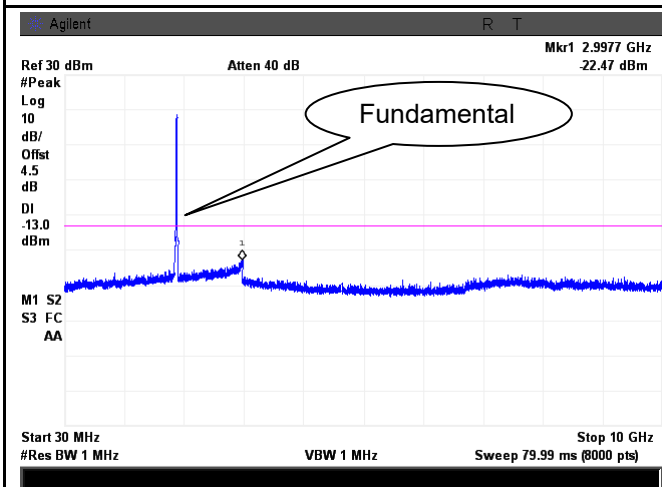

LTE Band 2 - High Channel-1

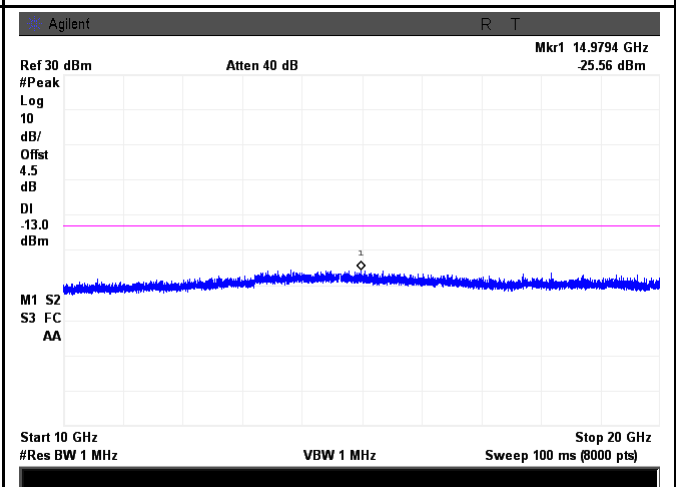

LTE Band 2 - High Channel-2

LTE Band 4 (Part27) result

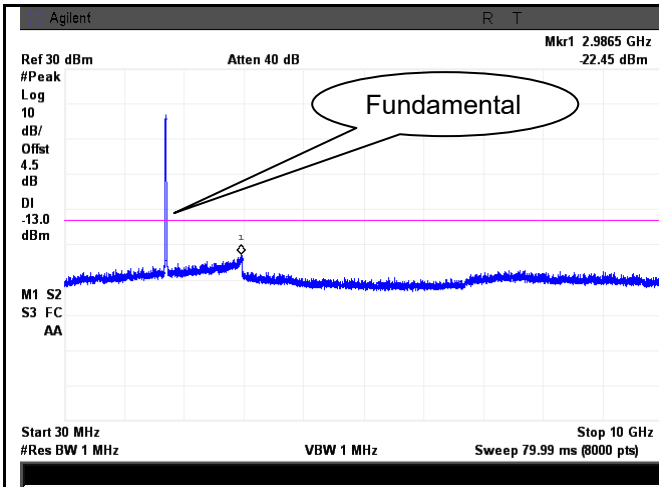

LTE Band 4 - Low Channel-1

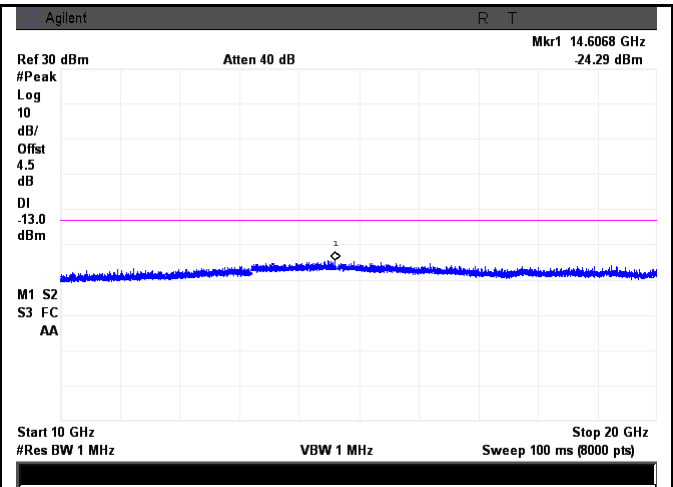

LTE Band 4 - Low Channel-2

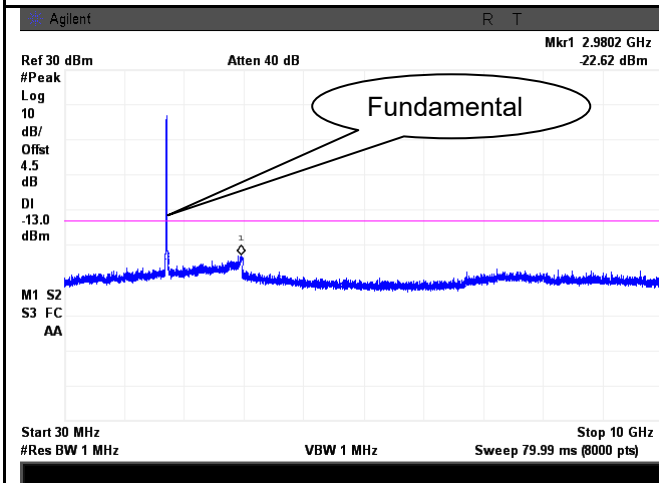

LTE Band 4 - Middle Channel-1

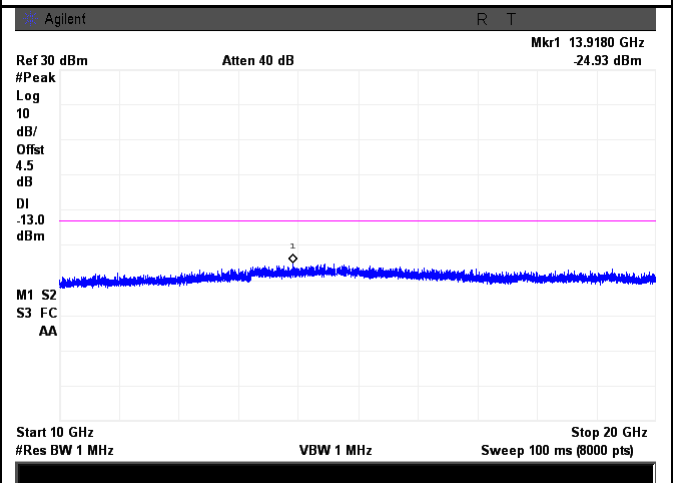

LTE Band 4 - Middle Channel-2

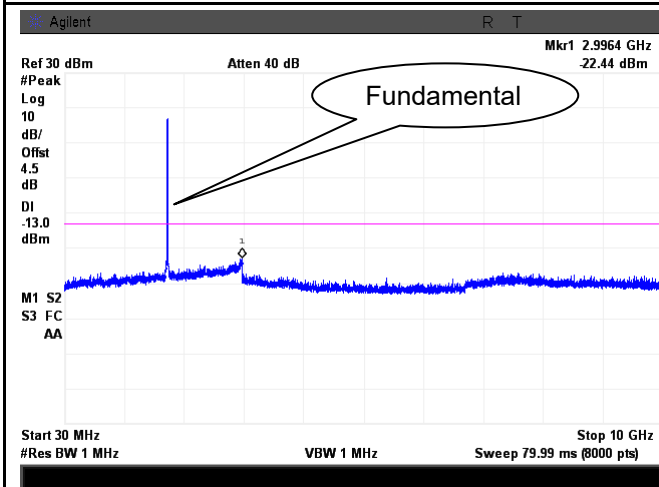

LTE Band 4 - High Channel-1

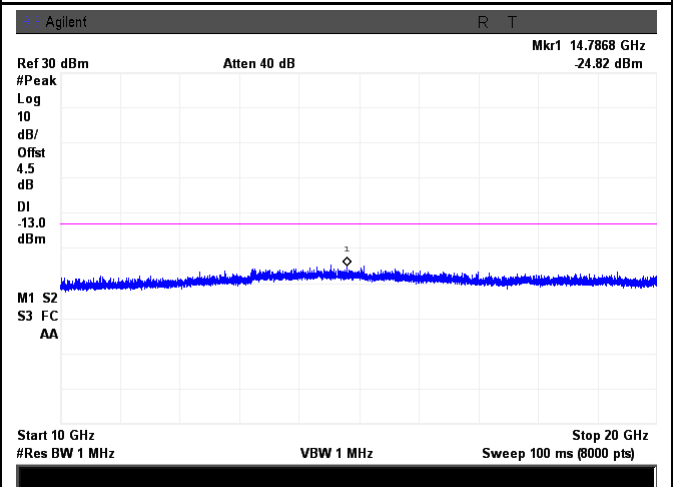

LTE Band 4 - High Channel-2

LTE Band 5 (Part 22H)

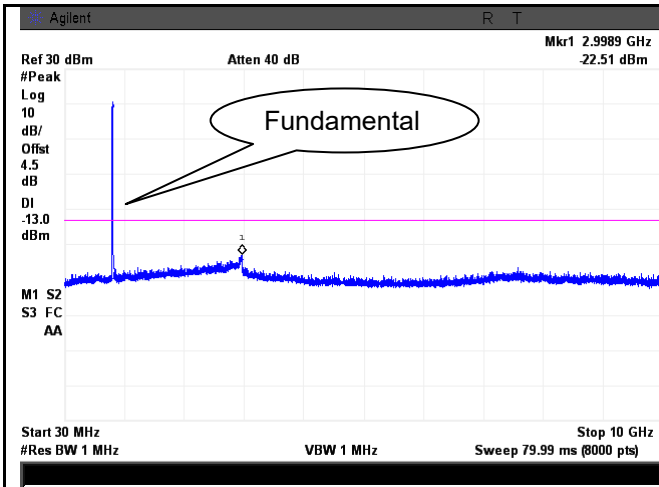

LTE Band 5 - Low Channel-1

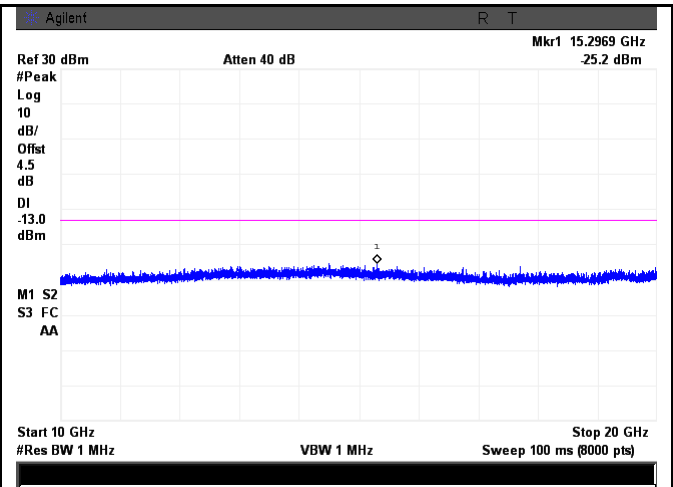

LTE Band 5 - Low Channel-2

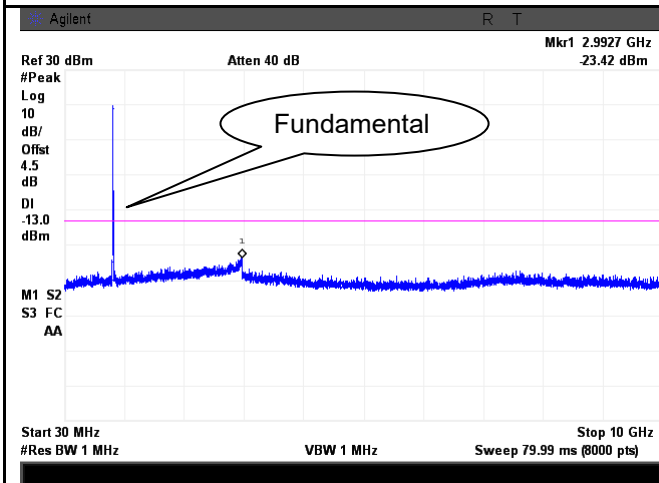

LTE Band 5- Middle Channel-1

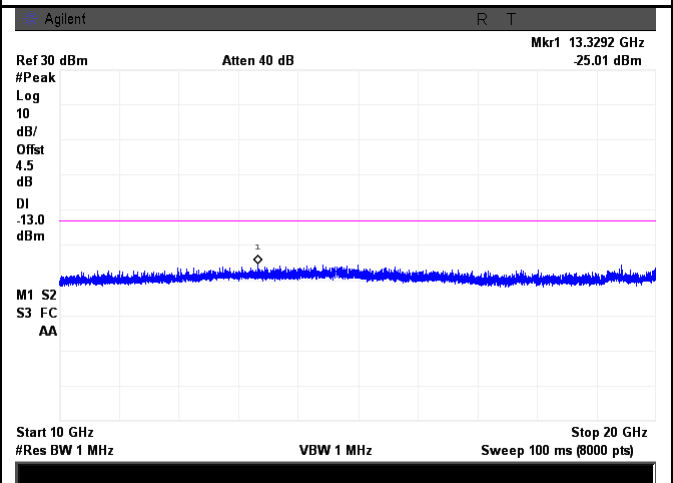

LTE Band 5 - Middle Channel-2

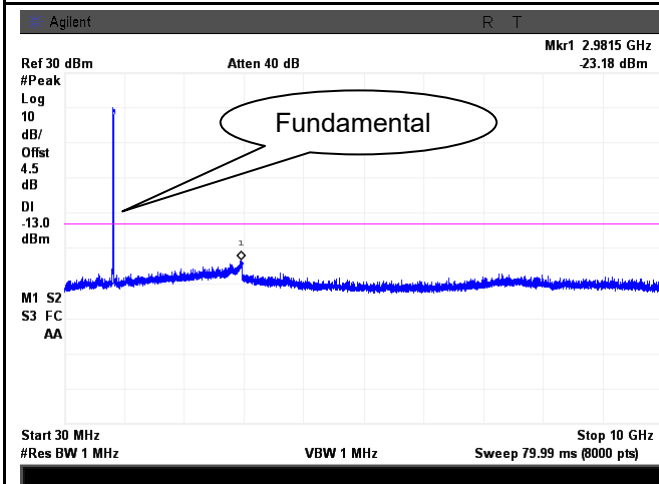

LTE Band 5 - High Channel-1

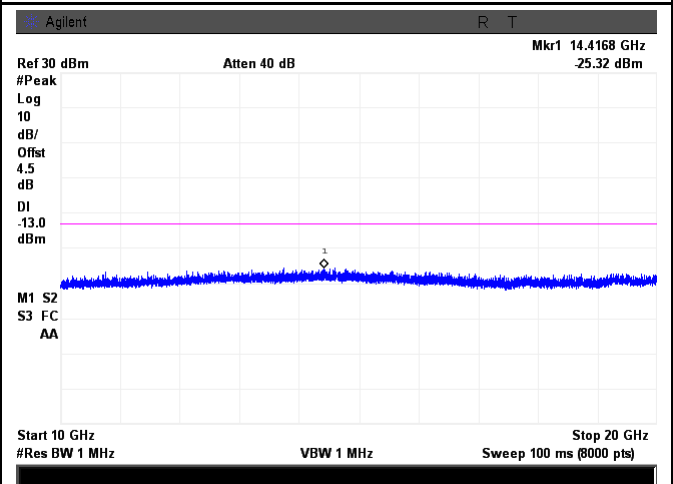

LTE Band 5 - High Channel-2

LTE Band 7 (Part 27)

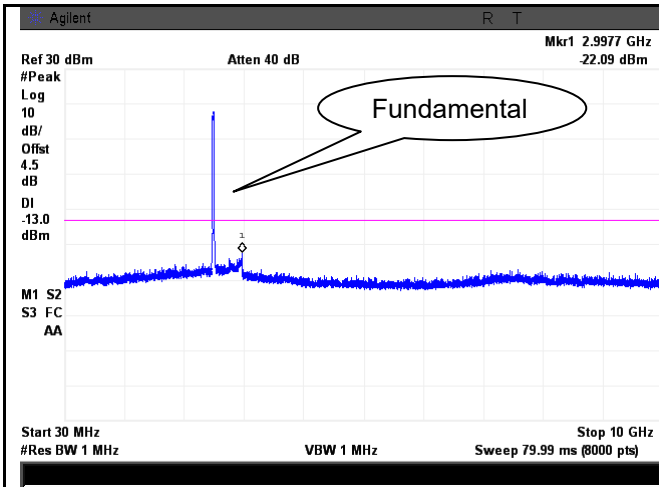

LTE Band 7 - Low Channel-1

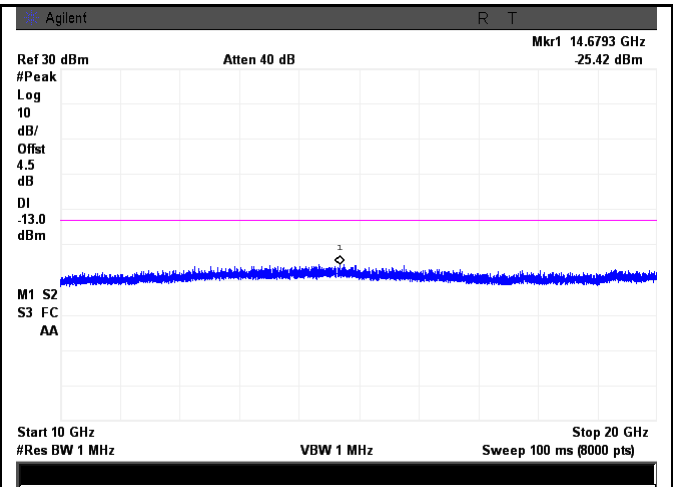

LTE Band 7 - Low Channel-2

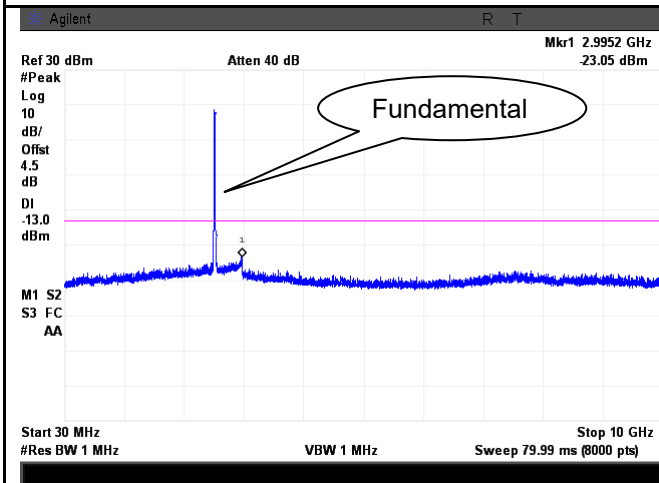

LTE Band 7 - Middle Channel-1

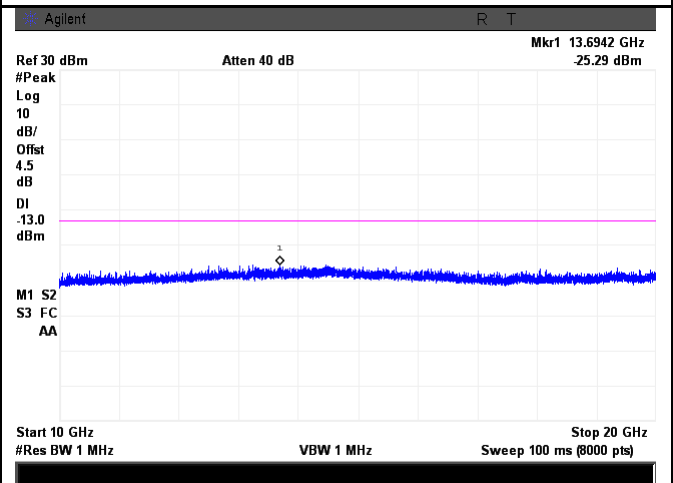

LTE Band 7 - Middle Channel-2

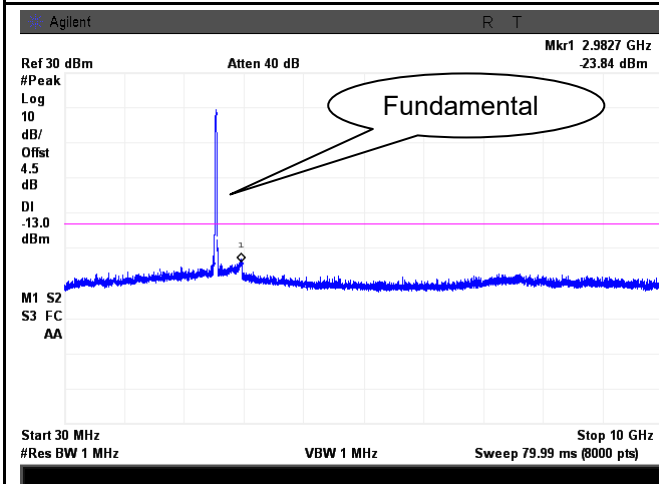

LTE Band 7 - High Channel-1

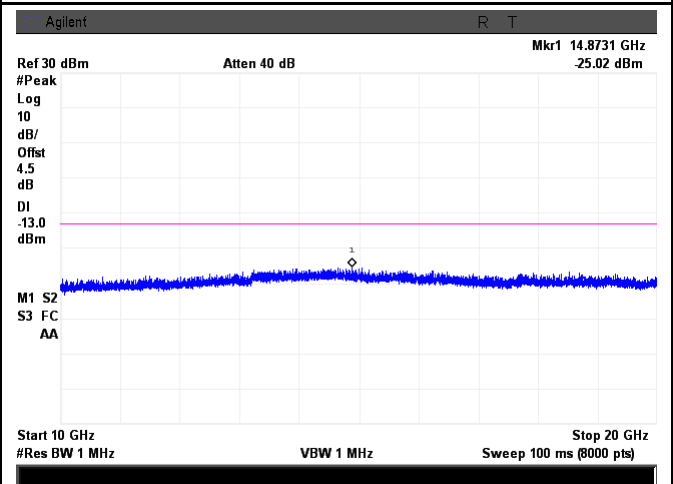

LTE Band 7 - High Channel-2

LTE Band 12 (Part 27)

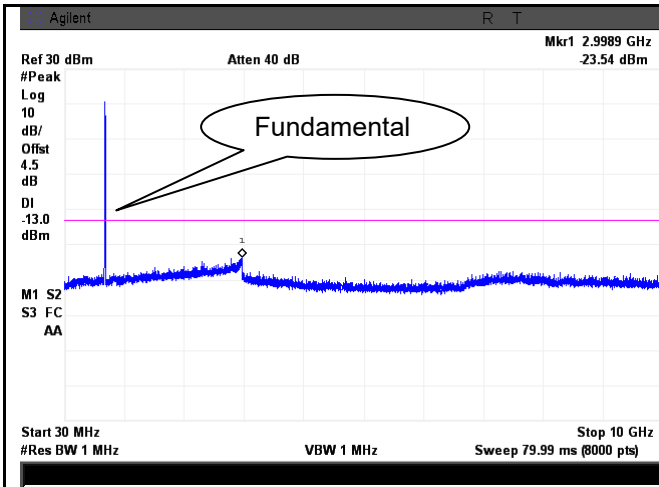

LTE Band 12 - Low Channel-1

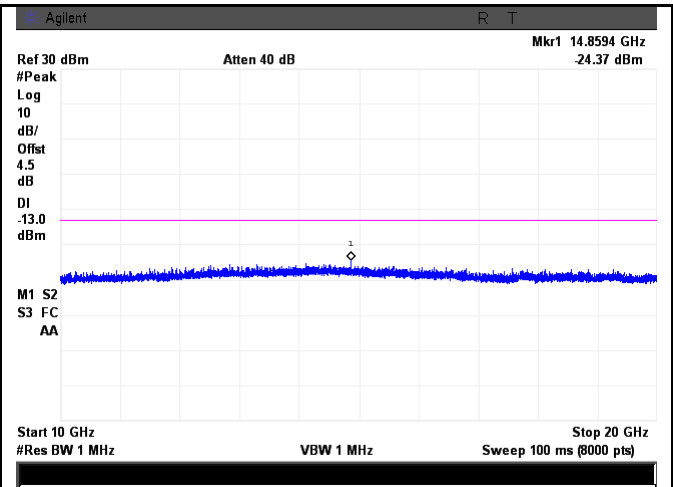

LTE Band 12 - Low Channel-2

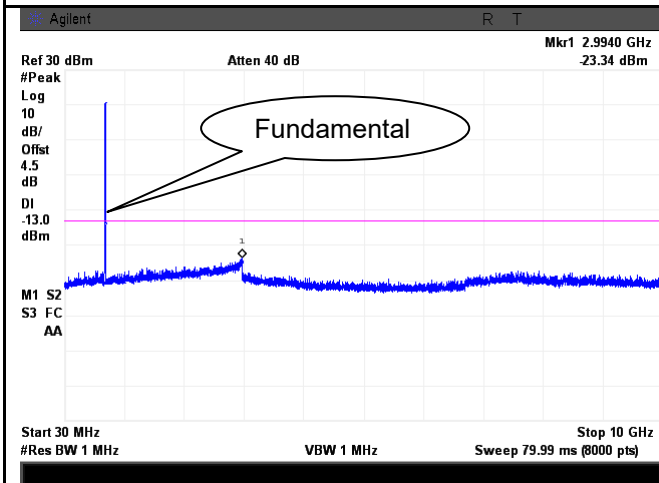

LTE Band 12 - Middle Channel-1

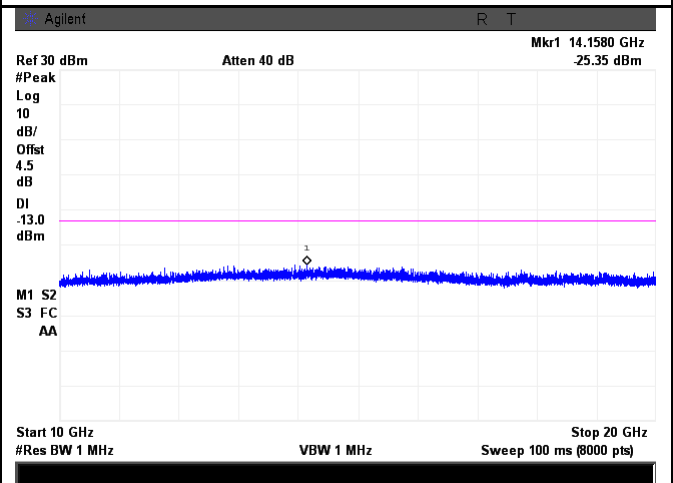

LTE Band 12 - Middle Channel-2

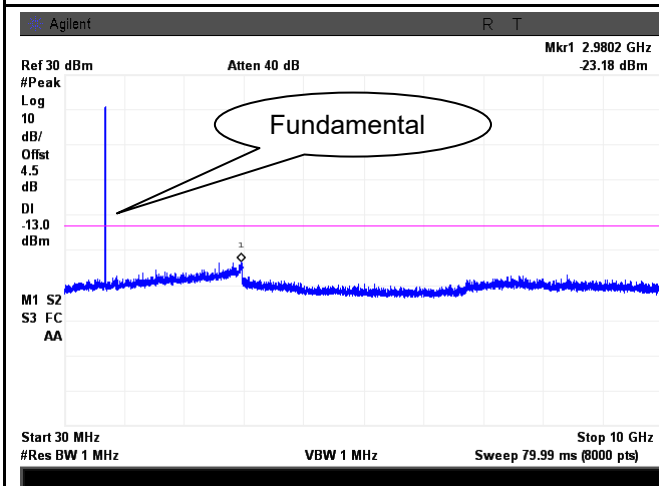

LTE Band 12 - High Channel-1

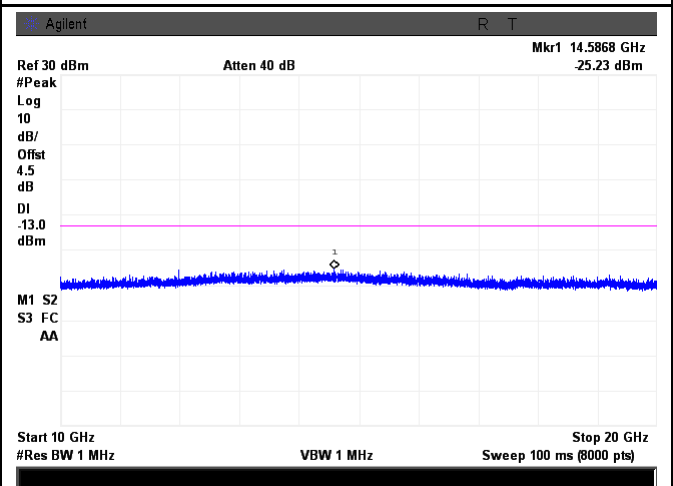

LTE Band 12 - High Channel-2

LTE Band 17 (Part 27)

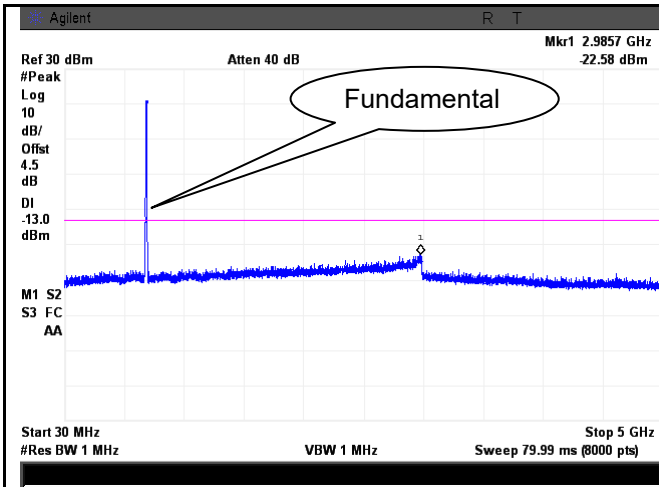

LTE Band 17 - Low Channel-1

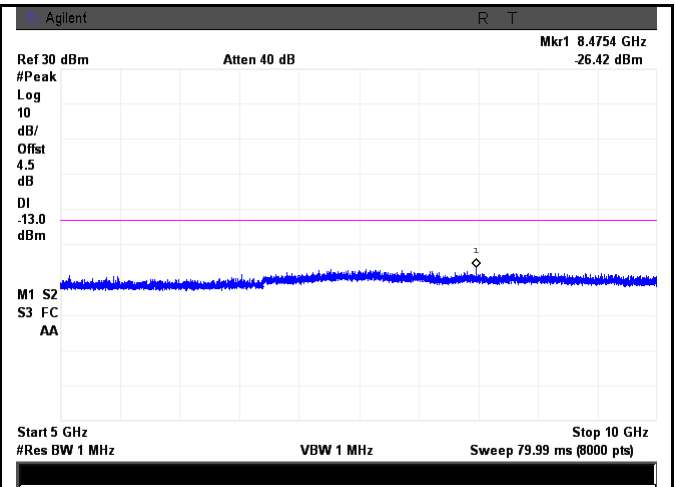

LTE Band 17 - Low Channel-2

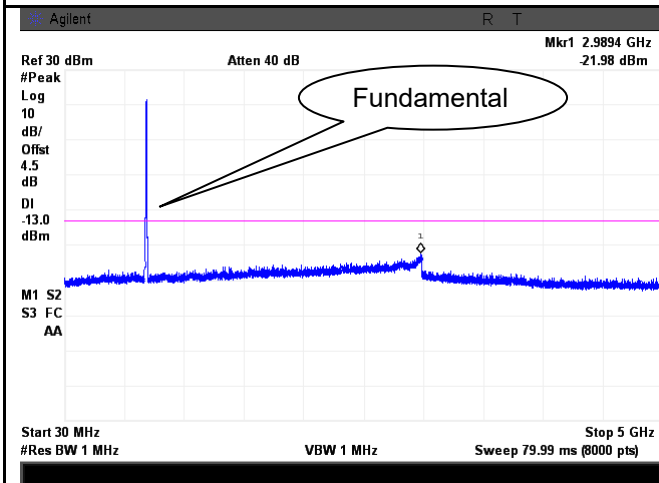

LTE Band 17 - Middle Channel-1

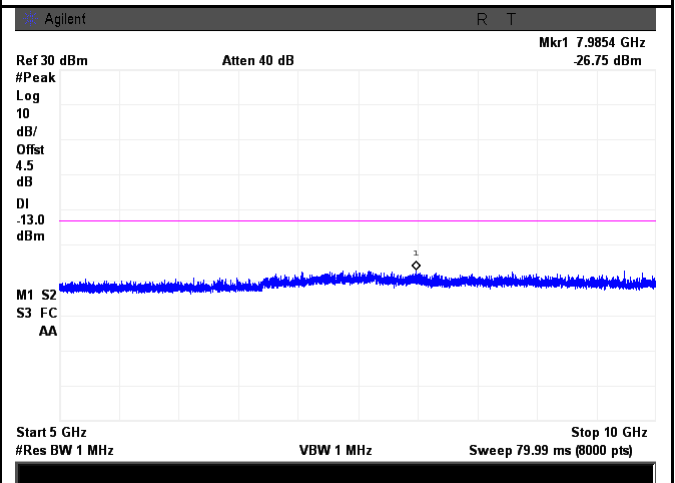

LTE Band 17 - Middle Channel-2

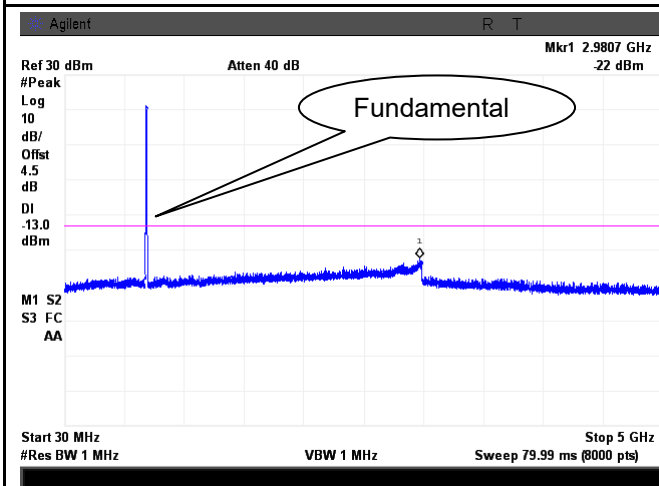

LTE Band 17 - High Channel-1

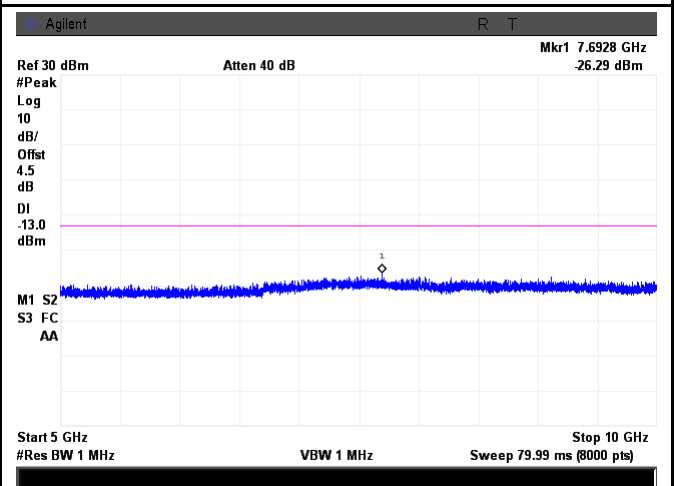

LTE Band 17 - High Channel-2

6.6 Spurious Radiated Emissions

Temperature	24°C
Relative Humidity	56%
Atmospheric Pressure	1023mbar
Test date :	December 23, 2015
Tested By :	Winnie Zhang

Requirement(s):

Spec	Item	Requirement	Applicable
§2.1053, §22.917 & §24.238 § 27.53(h)	a)	The power of any emission outside of the authorized operating frequency ranges must be attenuated below the transmitter power (P) by a factor of at least $43 + 10 \log (P)$ dB. The spectrum is scanned from 30 MHz up to a frequency including its 10th harmonic.	<input checked="" type="checkbox"/>

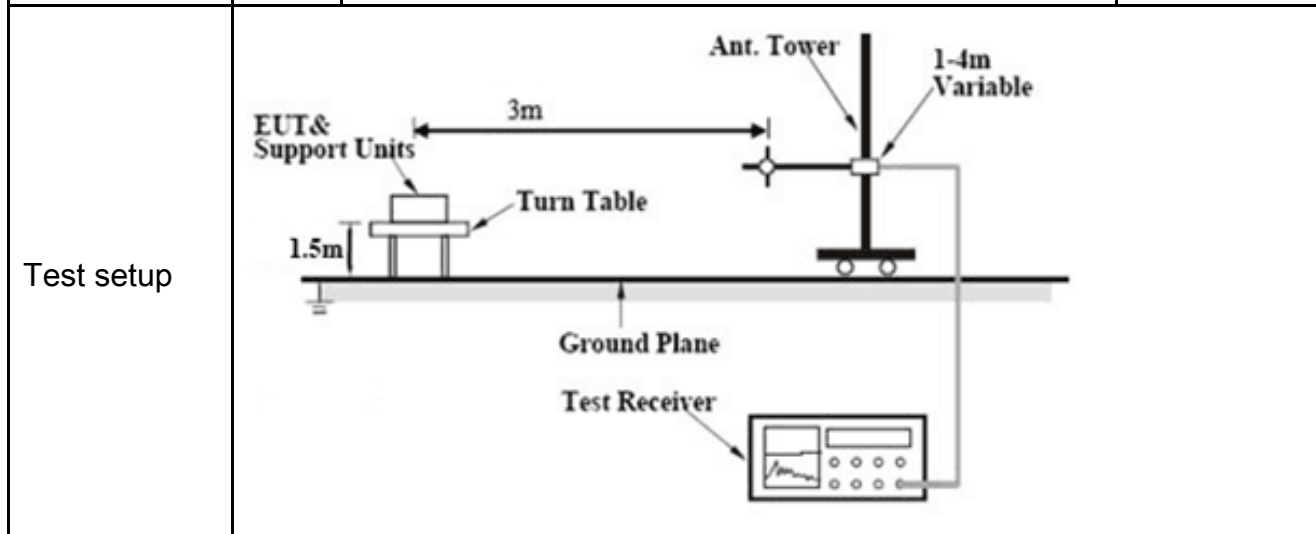

Test Procedure	<ol style="list-style-type: none"> 1. The transmitter was placed on a wooden turntable, and it was transmitting into a non-radiating load which was also placed on the turntable. 2. The measurement antenna was placed at a distance of 3 meters from the EUT. During the tests, the antenna height and polarization as well as EUT azimuth were varied in order to identify the maximum level of emissions from the EUT. The test was performed by placing the EUT on 3-orthogonal axis. 3. Remove the EUT and replace it with substitution antenna. A signal generator was connected to the substitution antenna by a non-radiating cable. The absolute levels of the spurious emissions were measured by the substitution. <p>Sample Calculation:</p> $\text{EUT Field Strength} = \text{Raw Amplitude (dB}\mu\text{V/m)} - \text{Amplifier Gain (dB)} + \text{Antenna Factor (dB)} + \text{Cable Loss (dB)} + \text{Filter Attenuation (dB, if used)}$
----------------	--

Remark	
Result	<input checked="" type="checkbox"/> Pass <input type="checkbox"/> Fail

Test Data Yes N/A
 Test Plot Yes (See below) N/A

LTE Band 2 (Part 24E) result

Low channel

Frequency (MHz)	Substituted level (dBm)	Polarity (H/V)	Antenna Gain Correction (dB)	Cable Loss (dB)	Corrected Reading (dBm)	Limit (dBm)	Margin (dB)
3720	-46.22	V	10.25	2.73	-38.7	-13	-25.70
3720	-46.85	H	10.25	2.73	-39.33	-13	-26.33
44.8	-41.26	V	-4.2	0.11	-45.57	-13	-32.57
196.5	-49.44	H	4.6	0.18	-45.02	-13	-32.02

Middle channel

Frequency (MHz)	Substituted level (dBm)	Polarity (H/V)	Antenna Gain Correction (dB)	Cable Loss (dB)	Corrected Reading (dBm)	Limit (dBm)	Margin (dB)
3760	-46.19	V	10.25	2.73	-38.67	-13	-25.67
3760	-47.02	H	10.25	2.73	-39.5	-13	-26.50
44.2	-41.35	V	-4.2	0.11	-45.66	-13	-32.66
196.8	-49.61	H	4.6	0.18	-45.19	-13	-32.19

High channel

Frequency (MHz)	Substituted level (dBm)	Polarity (H/V)	Antenna Gain Correction (dB)	Cable Loss (dB)	Corrected Reading (dBm)	Limit (dBm)	Margin (dB)
3800	-45.88	V	10.36	2.73	-38.25	-13	-25.25
3800	-46.74	H	10.36	2.73	-39.11	-13	-26.11
44.1	-41.29	V	-4.2	0.11	-45.6	-13	-32.60
196.4	-49.72	H	4.6	0.18	-45.3	-13	-32.30

LTE Band 4(Part27) result

Low channel

Frequency (MHz)	Substituted level (dBm)	Polarity (H/V)	Antenna Gain Correction (dB)	Cable Loss (dB)	Corrected Reading (dBm)	Limit (dBm)	Margin (dB)
3440	-46.82	V	10.06	2.52	-39.28	-13	-26.28
3440	-47.37	H	10.06	2.52	-39.83	-13	-26.83
43.6	-40.16	V	-4.2	0.11	-44.47	-13	-31.47
195.8	-49.82	H	4.6	0.18	-45.4	-13	-32.40

Middle channel

Frequency (MHz)	Substituted level (dBm)	Polarity (H/V)	Antenna Gain Correction (dB)	Cable Loss (dB)	Corrected Reading (dBm)	Limit (dBm)	Margin (dB)
3465	-46.89	V	10.09	2.52	-39.32	-13	-26.32
3465	-47.42	H	10.09	2.52	-39.85	-13	-26.85
43.5	-40.08	V	-4.2	0.11	-44.39	-13	-31.39
195.6	-49.83	H	4.6	0.18	-45.41	-13	-32.41

High channel

Frequency (MHz)	Substituted level (dBm)	Polarity (H/V)	Antenna Gain Correction (dB)	Cable Loss (dB)	Corrected Reading (dBm)	Limit (dBm)	Margin (dB)
3490	-46.95	V	10.09	2.52	-39.38	-13	-26.38
3490	-47.04	H	10.09	2.52	-39.47	-13	-26.47
43.9	-40.13	V	-4.2	0.11	-44.44	-13	-31.44
195.2	-49.97	H	4.6	0.18	-45.55	-13	-32.55

LTE Band 5(Part22H) result

Low channel

Frequency (MHz)	Substituted level (dBm)	Polarity (H/V)	Antenna Gain Correction (dB)	Cable Loss (dB)	Corrected Reading (dBm)	Limit (dBm)	Margin (dB)
1658	-45.29	V	7.95	0.78	-38.12	-13	-25.12
1658	-45.81	H	7.95	0.78	-38.64	-13	-25.64
42.8	-41.23	V	-4.2	0.11	-45.54	-13	-32.54
193.7	-50.18	H	4.6	0.18	-45.76	-13	-32.76

Middle channel

Frequency (MHz)	Substituted level (dBm)	Polarity (H/V)	Antenna Gain Correction (dB)	Cable Loss (dB)	Corrected Reading (dBm)	Limit (dBm)	Margin (dB)
1673	-45.22	V	7.95	0.78	-38.05	-13	-25.05
1673	-45.76	H	7.95	0.78	-38.59	-13	-25.59
42.5	-41.13	V	-4.2	0.11	-45.44	-13	-32.44
193.1	-50.07	H	4.6	0.18	-45.65	-13	-32.65

High channel

Frequency (MHz)	Substituted level (dBm)	Polarity (H/V)	Antenna Gain Correction (dB)	Cable Loss (dB)	Corrected Reading (dBm)	Limit (dBm)	Margin (dB)
1688	-45.18	V	7.95	0.78	-38.01	-13	-25.01
1688	-45.64	H	7.95	0.78	-38.47	-13	-25.47
42.4	-41.05	V	-4.2	0.11	-45.36	-13	-32.36
193.8	-50.12	H	4.6	0.18	-45.7	-13	-32.70

LTE Band 7(Part27) result

Low channel

Frequency (MHz)	Substituted level (dBm)	Polarity (H/V)	Antenna Gain Correction (dB)	Cable Loss (dB)	Corrected Reading (dBm)	Limit (dBm)	Margin (dB)
5020	-48.53	V	10.29	0.98	-39.22	-13	-26.22
5020	-48.71	H	10.29	0.98	-39.4	-13	-26.4
43.1	-41.96	V	-4.2	0.11	-46.27	-13	-33.27
195.6	-50.52	H	4.6	0.18	-46.1	-13	-33.1

Middle channel

Frequency (MHz)	Substituted level (dBm)	Polarity (H/V)	Antenna Gain Correction (dB)	Cable Loss (dB)	Corrected Reading (dBm)	Limit (dBm)	Margin (dB)
5070	-48.49	V	10.3	0.99	-39.18	-13	-26.18
5070	-48.66	H	10.3	0.99	-39.35	-13	-26.35
43.5	-41.85	V	-4.2	0.11	-46.16	-13	-33.16
195.2	-50.47	H	4.6	0.18	-46.05	-13	-33.05

High channel

Frequency (MHz)	Substituted level (dBm)	Polarity (H/V)	Antenna Gain Correction (dB)	Cable Loss (dB)	Corrected Reading (dBm)	Limit (dBm)	Margin (dB)
5120	-48.51	V	10.32	1	-39.19	-13	-26.19
5120	-48.75	H	10.32	1	-39.43	-13	-26.43
43.8	-41.79	V	-4.2	0.11	-46.1	-13	-33.10
196.5	-50.55	H	4.6	0.18	-46.13	-13	-33.13

LTE Band 12(Part27) result

Low channel

Frequency (MHz)	Substituted level (dBm)	Polarity (H/V)	Antenna Gain Correction (dB)	Cable Loss (dB)	Corrected Reading (dBm)	Limit (dBm)	Margin (dB)
1408	-47.56	V	7.65	0.75	-40.66	-13	-27.66
1408	-47.95	H	7.65	0.75	-41.05	-13	-28.05
45.1	-42.13	V	-4.2	0.11	-46.44	-13	-33.44
194.8	-50.87	H	4.6	0.18	-46.45	-13	-33.45

Middle channel

Frequency (MHz)	Substituted level (dBm)	Polarity (H/V)	Antenna Gain Correction (dB)	Cable Loss (dB)	Corrected Reading (dBm)	Limit (dBm)	Margin (dB)
1415	-47.51	V	7.65	0.75	-40.61	-13	-27.61
1415	-47.86	H	7.65	0.75	-40.96	-13	-27.96
45.6	-42.05	V	-4.2	0.11	-46.36	-13	-33.36
194.3	-50.81	H	4.6	0.18	-46.39	-13	-33.39

High channel

Frequency (MHz)	Substituted level (dBm)	Polarity (H/V)	Antenna Gain Correction (dB)	Cable Loss (dB)	Corrected Reading (dBm)	Limit (dBm)	Margin (dB)
1422	-47.44	V	7.65	0.75	-40.54	-13	-27.54
1422	-47.79	H	7.65	0.75	-40.89	-13	-27.89
45.7	-41.93	V	-4.2	0.11	-46.24	-13	-33.24
194.5	-50.68	H	4.6	0.18	-46.26	-13	-33.26

LTE Band 17(Part27) result

Low channel

Frequency (MHz)	Substituted level (dBm)	Polarity (H/V)	Antenna Gain Correction (dB)	Cable Loss (dB)	Corrected Reading (dBm)	Limit (dBm)	Margin (dB)
1418	-45.38	V	7.65	0.75	-38.48	-13	-25.48
1418	-45.91	H	7.65	0.75	-39.01	-13	-26.01
44.5	-40.66	V	-4.2	0.11	-44.97	-13	-31.97
196.3	-49.52	H	4.6	0.18	-45.1	-13	-32.10

Middle channel

Frequency (MHz)	Substituted level (dBm)	Polarity (H/V)	Antenna Gain Correction (dB)	Cable Loss (dB)	Corrected Reading (dBm)	Limit (dBm)	Margin (dB)
1420	-45.31	V	7.65	0.75	-38.41	-13	-25.41
1420	-45.86	H	7.65	0.75	-38.96	-13	-25.96
44.1	-40.52	V	-4.2	0.11	-44.83	-13	-31.83
196.8	-49.47	H	4.6	0.18	-45.05	-13	-32.05

High channel

Frequency (MHz)	Substituted level (dBm)	Polarity (H/V)	Antenna Gain Correction (dB)	Cable Loss (dB)	Corrected Reading (dBm)	Limit (dBm)	Margin (dB)
1422	-45.28	V	7.65	0.75	-38.38	-13	-25.38
1422	-45.79	H	7.65	0.75	-38.89	-13	-25.89
44.3	-40.35	V	-4.2	0.11	-44.66	-13	-31.66
196.4	-49.38	H	4.6	0.18	-44.96	-13	-31.96

6.7 Band Edge

Temperature	25°C
Relative Humidity	57%
Atmospheric Pressure	1024mbar
Test date :	December 24, 2015
Tested By :	Winnie Zhang

Requirement(s):

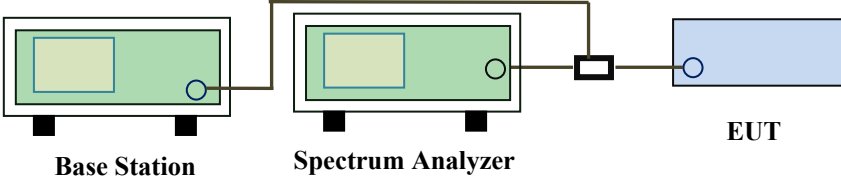
Spec	Item	Requirement	Applicable
§22.917(a) §24.238(a) § 27.53(h)	a)	The power of any emission outside of the authorized operating frequency ranges must be lower than the transmitter power (P) by a factor of at least $43 + 10 \log (P)$ dB.	<input checked="" type="checkbox"/>
Test setup	 <p>The diagram shows a Base Station (green box) connected to a Spectrum Analyzer (green box) and an EUT (blue box) through a power divider (black box). The Base Station and Spectrum Analyzer are connected to each other, and the Spectrum Analyzer is connected to the power divider, which then splits the signal to the EUT.</p>		
Procedure	<ul style="list-style-type: none"> - The EUT was connected to Spectrum Analyzer and Base Station via power divider. - The Band Edges of low and high channels for the highest RF powers were measured. Setting RBW as roughly BW/100. 		
Remark			
Result	<input checked="" type="checkbox"/> Pass <input type="checkbox"/> Fail		

Test Data Yes N/A

Test Plot Yes (See below) N/A

LTE Band 2 (Part 24E) result

BW(MHz)	Channel	Frequency (MHz)	Mode	Emission (dBm)	Limit (dBm)
1.4	18607	1850.7	QPSK	-24.29	-13
			16QAM	-23.93	-13
1.4	18900	1909.3	QPSK	-24.42	-13
			16QAM	-23.10	-13
3	18615	1851.5	QPSK	-17.11	-13
			16QAM	-17.87	-13
3	19185	1908.5	QPSK	-20.73	-13
			16QAM	-18.60	-13
5	18625	1852.5	QPSK	-13.86	-13
			16QAM	-15.17	-13
5	19175	1907.5	QPSK	-19.42	-13
			16QAM	-19.46	-13
10	18650	1855	QPSK	-16.28	-13
			16QAM	-18.36	-13
10	19150	1905	QPSK	-18.67	-13
			16QAM	-18.92	-13
15	18675	1857.5	QPSK	-18.13	-13
			16QAM	-17.37	-13
15	19125	1902.5	QPSK	-17.56	-13
			16QAM	-18.47	-13
20	18700	1860	QPSK	-17.50	-13
			16QAM	-20.03	-13
20	19100	1900	QPSK	-16.86	-13
			16QAM	-19.35	-13

LTE Band 4 (Part 27) result

BW(MHz)	Channel	Frequency (MHz)	Mode	Emission (dBm)	Limit (dBm)
1.4	19957	1710.7	QPSK	-30.76	-13
			16QAM	-26.93	-13
1.4	20393	1754.3	QPSK	-27.15	-13
			16QAM	-23.85	-13
3	19965	1711.5	QPSK	-19.86	-13
			16QAM	-19.84	-13
3	20385	1753.5	QPSK	-21.66	-13
			16QAM	-20.83	-13
5	19975	1712.5	QPSK	-17.56	-13
			16QAM	-19.54	-13
5	20375	1752.5	QPSK	-19.82	-13
			16QAM	-17.94	-13
10	20000	1715	QPSK	-21.11	-13
			16QAM	-20.72	-13
10	20350	1750	QPSK	-21.32	-13
			16QAM	-20.23	-13
15	20025	1717.5	QPSK	-25.88	-13
			16QAM	-22.40	-13
15	20325	1747.5	QPSK	-22.62	-13
			16QAM	-21.98	-13
20	20050	1720	QPSK	-25.96	-13
			16QAM	-26.53	-13
20	20300	1745	QPSK	-24.99	-13
			16QAM	-24.10	-13

LTE Band 5 (Part 22H) result

BW(MHz)	Channel	Frequency (MHz)	Mode	Emission (dBm)	Limit (dBm)
1.4	20407	824.7	QPSK	-28.50	-13
			16QAM	-27.81	-13
1.4	20643	848.3	QPSK	-26.33	-13
			16QAM	-28.09	-13
3	20415	825.5	QPSK	-16.04	-13
			16QAM	-16.37	-13
3	20635	847.5	QPSK	-25.49	-13
			16QAM	-25.80	-13
5	20425	826.5	QPSK	-14.81	-13
			16QAM	-17.55	-13
5	20625	846.5	QPSK	-17.08	-13
			16QAM	-16.70	-13
10	20450	829	QPSK	-16.28	-13
			16QAM	-20.40	-13
10	20800	844	QPSK	-18.06	-13
			16QAM	-18.98	-13

LTE Band 12 (Part 27) result

BW(MHz)	Channel	Frequency (MHz)	Mode	Emission (dBm)	Limit (dBm)
1.4	23017	699.7	QPSK	-24.02	-13
			16QAM	-23.75	-13
1.4	23173	715.3	QPSK	-21.81	-13
			16QAM	-21.27	-13
3	23025	700.5	QPSK	-21.67	-13
			16QAM	-22.24	-13
3	23165	714.5	QPSK	-20.26	-13
			16QAM	-20.89	-13
5	23035	701.5	QPSK	-14.87	-13
			16QAM	-16.72	-13
5	23155	713.5	QPSK	-18.24	-13
			16QAM	-18.03	-13
10	23060	704	QPSK	-23.61	-13
			16QAM	-25.21	-13
10	23130	711	QPSK	-26.50	-13
			16QAM	-28.20	-13

LTE Band 17 (Part 27) result

BW(MHz)	Channel	Frequency (MHz)	Mode	Emission (dBm)	Limit (dBm)
5	23755	706.5	QPSK	-18.53	-13
			16QAM	-21.24	-13
5	23825	713.5	QPSK	-24.93	-13
			16QAM	-25.05	-13
10	23780	709	QPSK	-21.01	-13
			16QAM	-22.42	-13
10	23800	711	QPSK	-22.83	-13
			16QAM	-24.83	-13

Test Plots

LTE Band 2 (Part 24E)

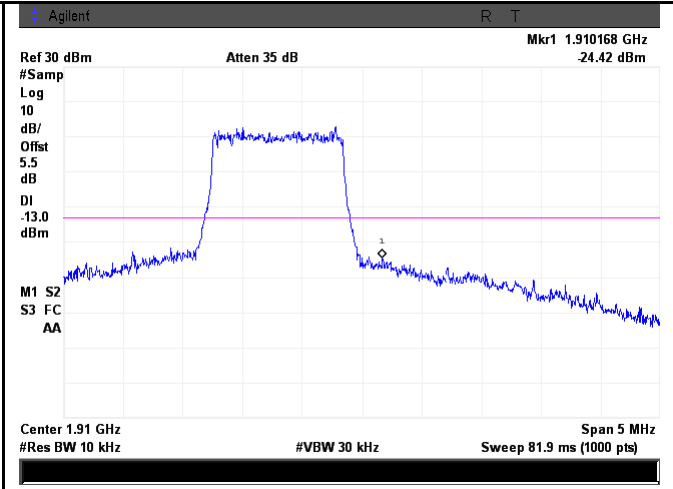
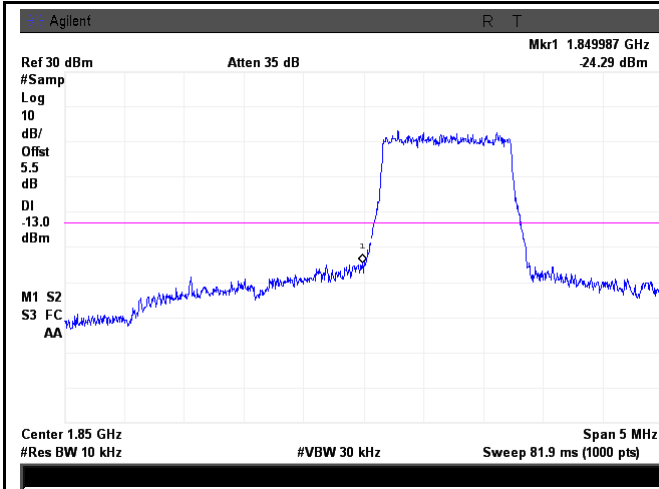

LTE Band 2 - Low Channel QPSK-1.4

LTE Band 2 - High Channel QPSK-1.4

Note: Offset=Cable loss (4.5) + 10log
(12.72/10)=4.5+1.0=5.5 dB

Note: Offset=Cable loss (4.5) + 10log
(12.72/10)=4.5+1.0=5.5 dB

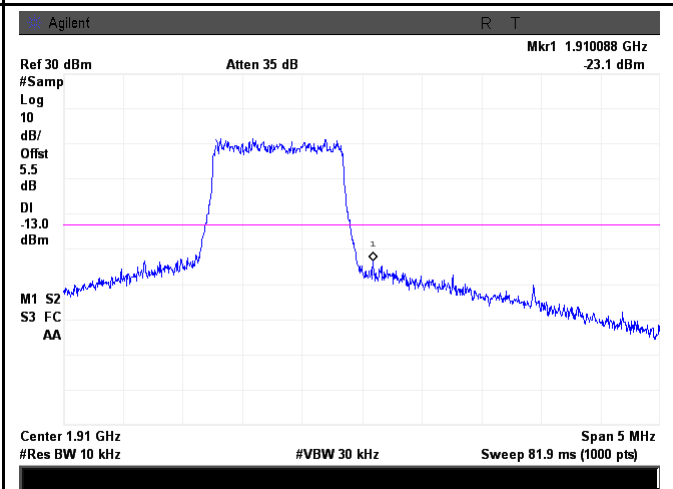
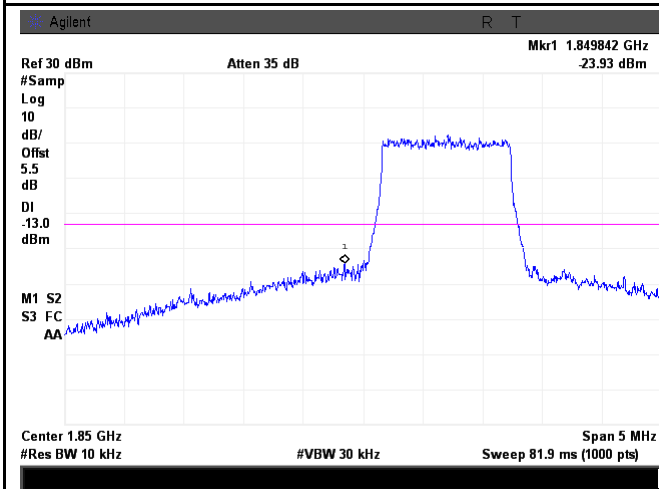

LTE Band 2 - Low Channel 16QAM-1.4

LTE Band 2 - High Channel 16QAM-1.4

Note: Offset=Cable loss (4.5) + 10log
(12.73/10)=4.5+1.0=5.5 dB

Note: Offset=Cable loss (4.5) + 10log
(12.67/10)=4.5+1.0=5.5 dB

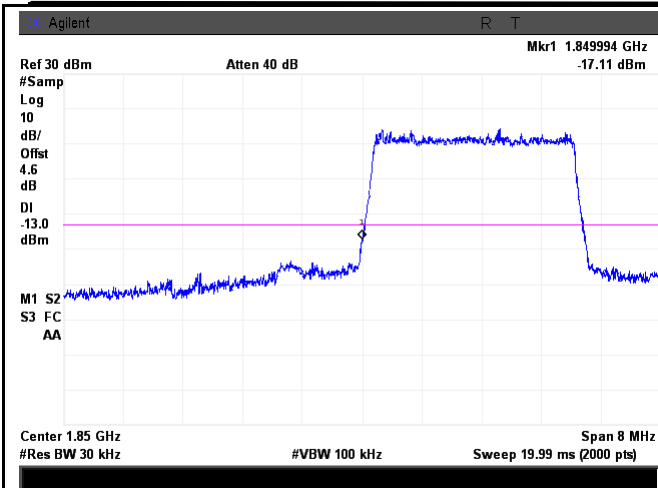

LTE Band 2 - Low Channel QPSK-3

Note: Offset=Cable loss (4.5) + 10log
(30.99/30)=4.5+0.1=4.6 dB

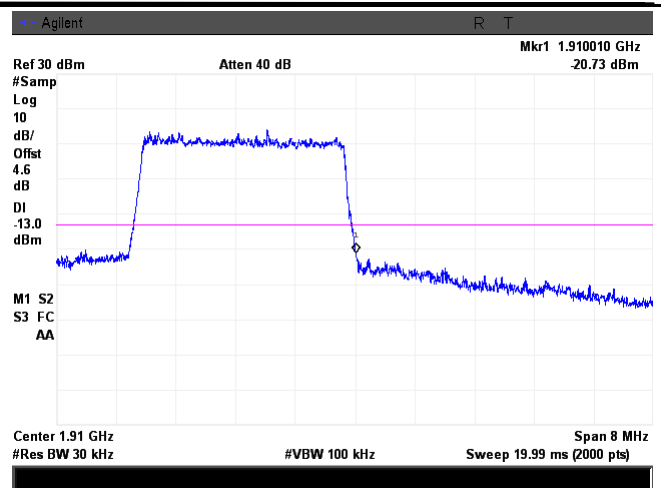

LTE Band 2 - High Channel QPSK-3

Note: Offset=Cable loss (4.5) + 10log
(30.99/30)=4.5+0.1=4.6 dB

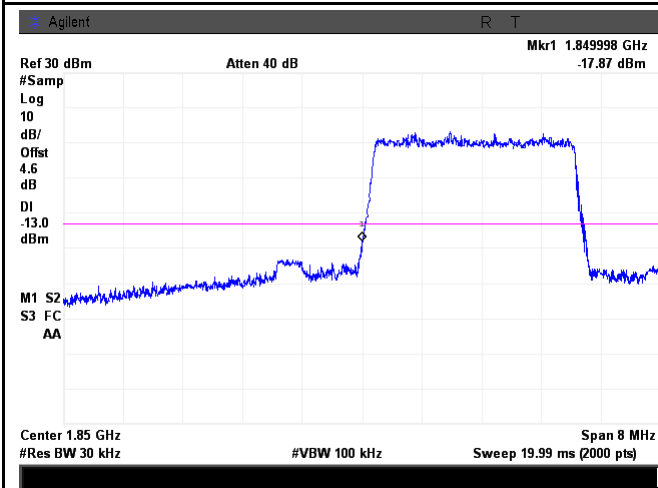

LTE Band 2 - Low Channel 16QAM-3

Note: Offset=Cable loss (4.5) + 10log
(31.01/30)=4.5+0.1=4.6 dB

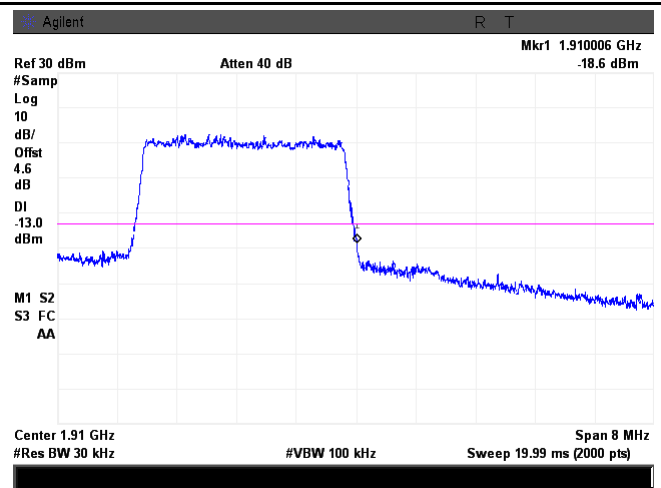

LTE Band 2 - High Channel 16QAM-3

Note: Offset=Cable loss (4.5) + 10log
(30.52/30)=4.5+0.1=4.6 dB

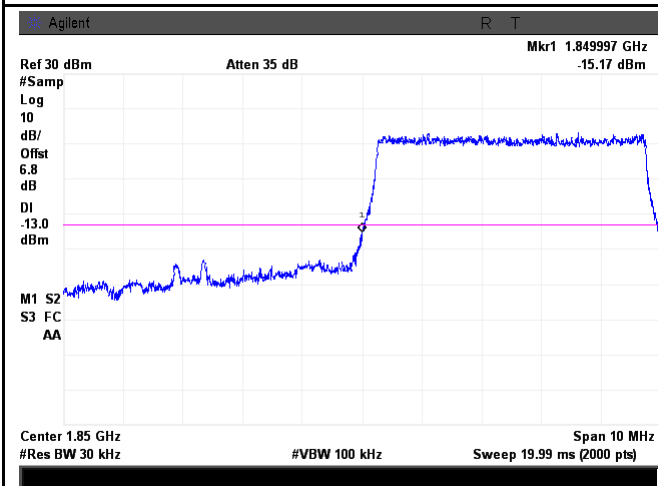

LTE Band 2 - Low Channel QPSK-5

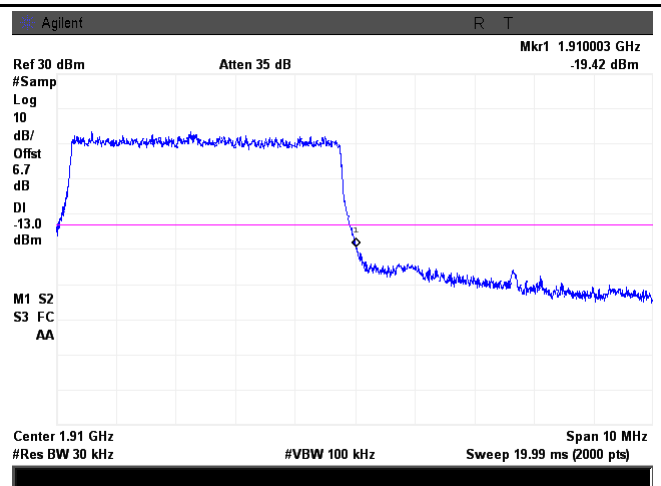

LTE Band 2 - High Channel QPSK-5

Note: Offset=Cable loss (4.5) + 10log
(51.21/30)=4.5+2.3=6.8 dB

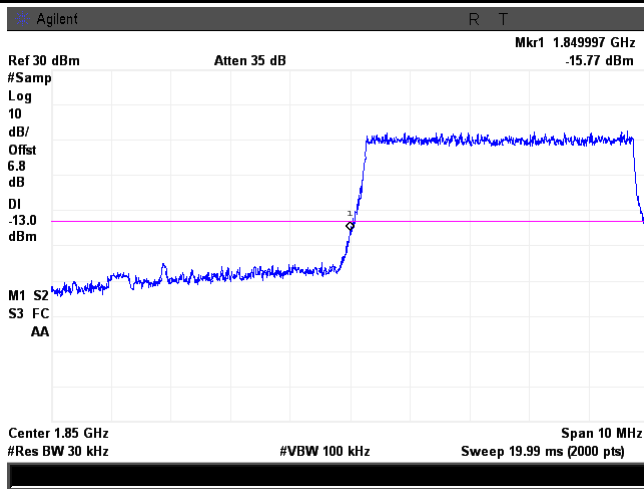

LTE Band 2 - Low Channel 16QAM-5

Note: Offset=Cable loss (4.5) + 10log
(50.24/30)=4.5+2.2=6.7 dB

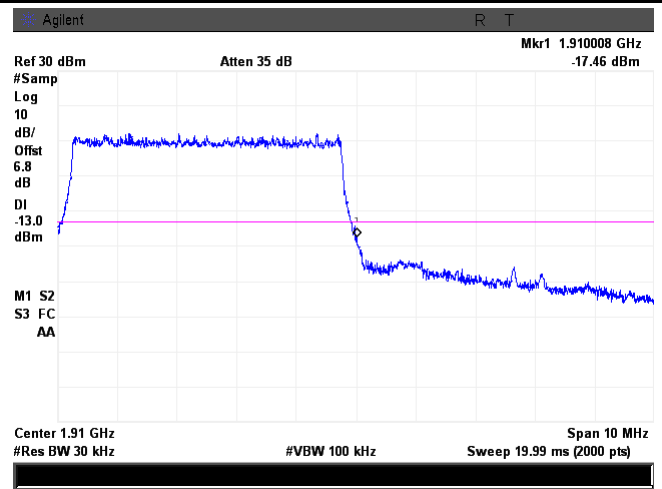

LTE Band 2 - High Channel 16QAM-5

Note: Offset=Cable loss (4.5) + 10log
(50.59/30)=4.5+2.3=6.8 dB

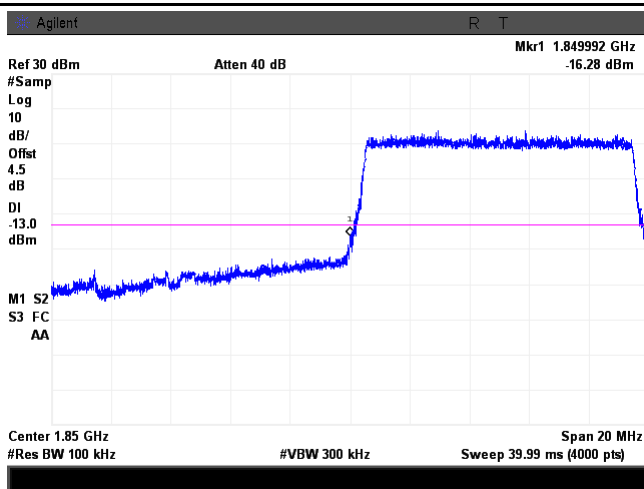

LTE Band 2 - Low Channel QPSK-10

Note: Offset=Cable loss (4.5) + 10log
(50.55/30)=4.5+2.3=6.8 dB

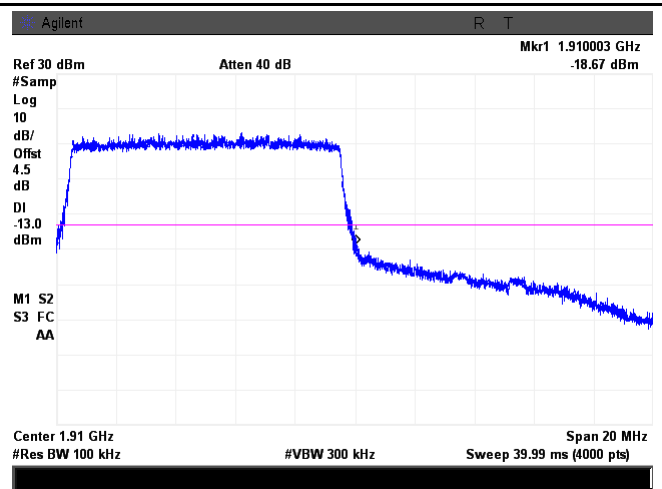

LTE Band 2 - High Channel QPSK-10

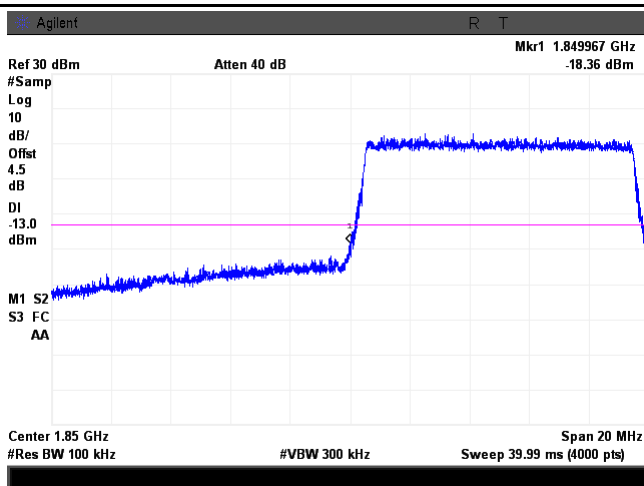

LTE Band 2 - Low Channel 16QAM-10

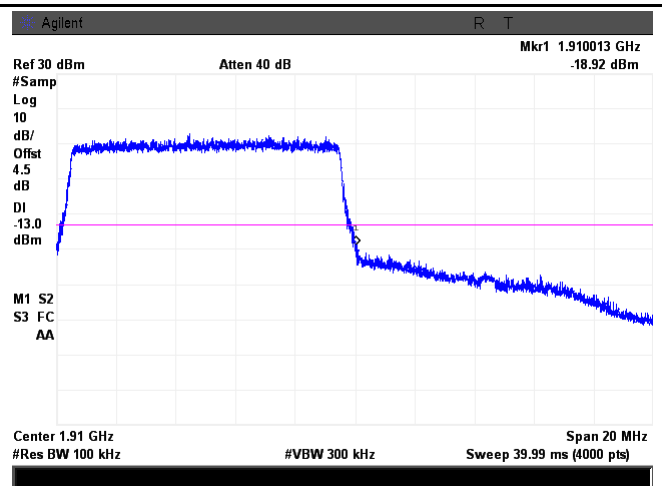

LTE Band 2 - High Channel 16QAM-10

Note: Offset=Cable loss (4.5) + 10log
(101.1/100)=4.5+0.0=4.5 dB

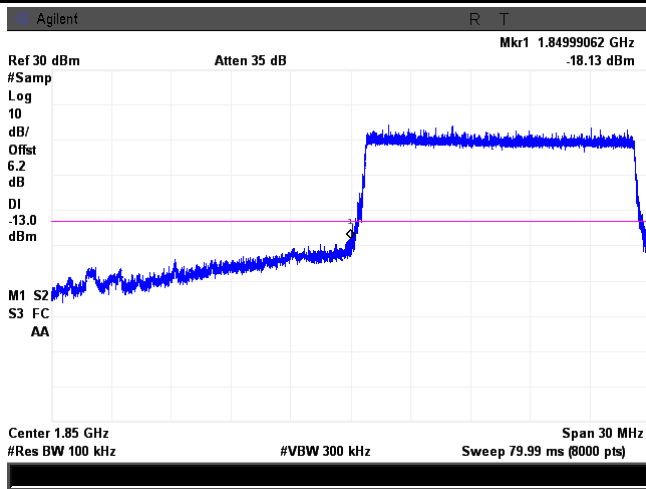

LTE Band 2 - Low Channel QPSK-15

Note: Offset=Cable loss (4.5) + 10log
(99.9/100)=4.5+0.0=4.5 dB

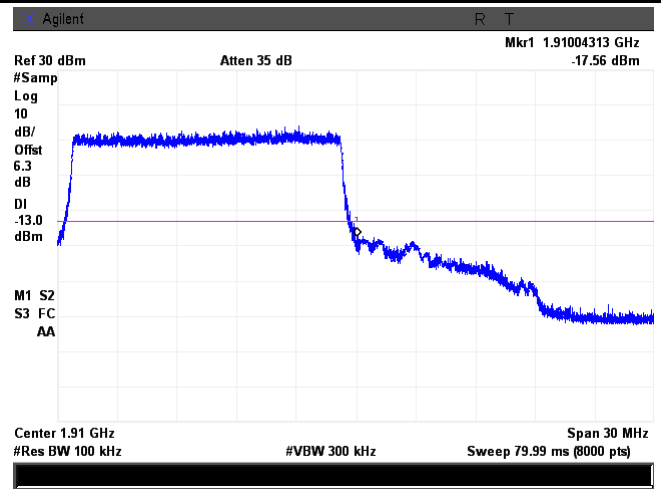

LTE Band 2 - High Channel QPSK-15

Note: Offset=Cable loss (4.5) + 10log
(147.9/100)=4.5+1.7=6.2 dB

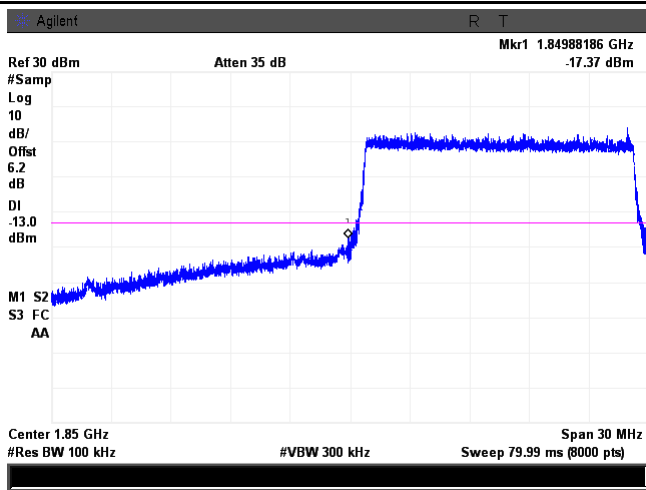

LTE Band 2 - Low Channel 16QAM-15

Note: Offset=Cable loss (4.5) + 10log
(149.7/100)=4.5+1.8=6.3 dB

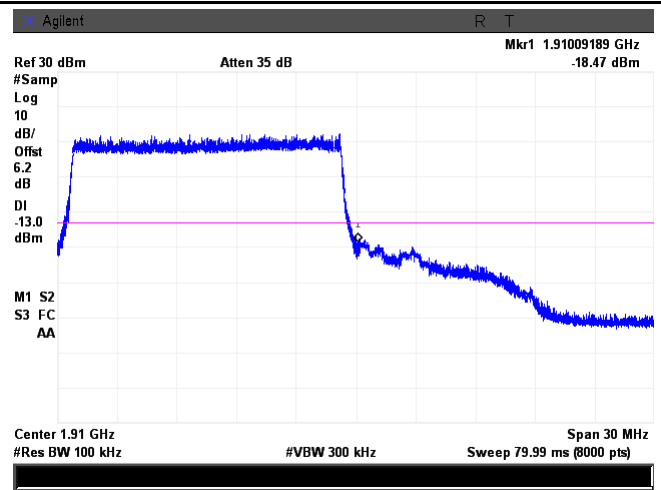

LTE Band 2 - High Channel 16QAM-15

Note: Offset=Cable loss (4.5) + 10log
(148/100)=4.5+1.7=6.2 dB

Note: Offset=Cable loss (4.5) + 10log
(149.1/100)=4.5+1.7=6.2 dB

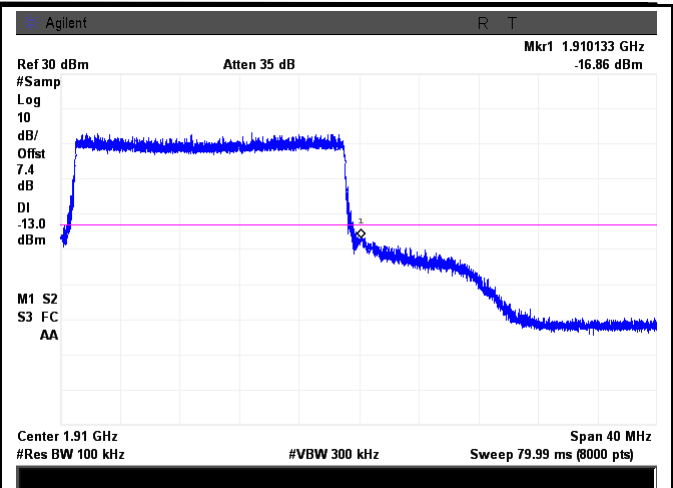
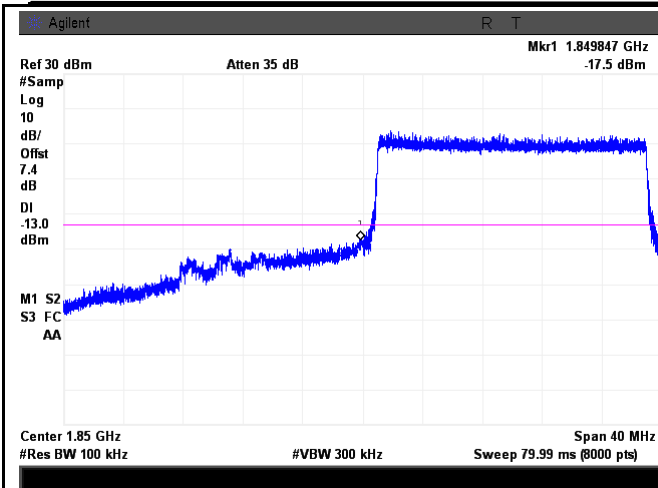

LTE Band 2 - Low Channel QPSK-20

LTE Band 2 - High Channel QPSK-20

Note: Offset=Cable loss (4.5) + 10log
 (194.1/100)=4.5+2.9=7.4 dB

Note: Offset=Cable loss (4.5) + 10log
 (195.3/100)=4.5+2.9=7.4 dB

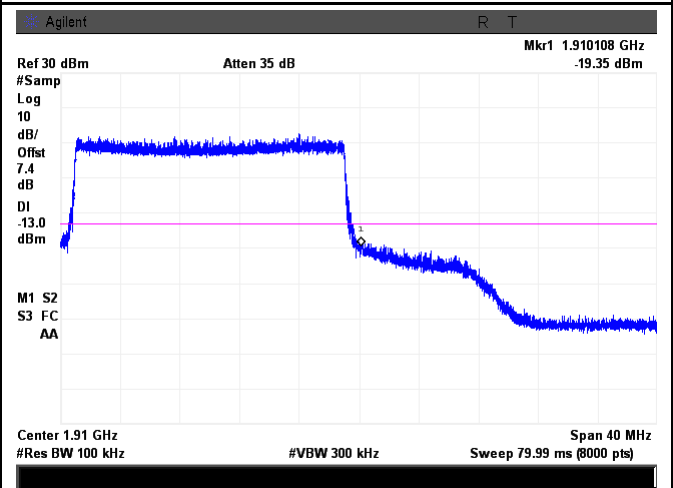
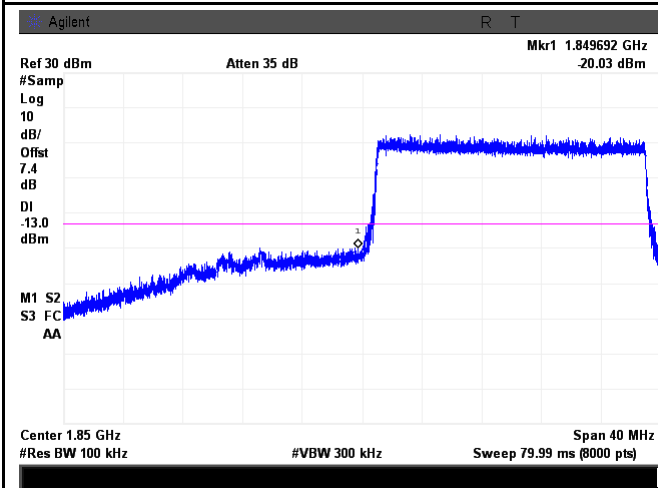

LTE Band 2 - Low Channel 16QAM-20

LTE Band 2 - High Channel 16QAM-20

Note: Offset=Cable loss (4.5) + 10log
 (194.2/100)=4.5+2.9=7.4 dB

Note: Offset=Cable loss (4.5) + 10log
 (194.2/100)=4.5+2.9=7.4 dB

LTE Band 4 (Part 27)

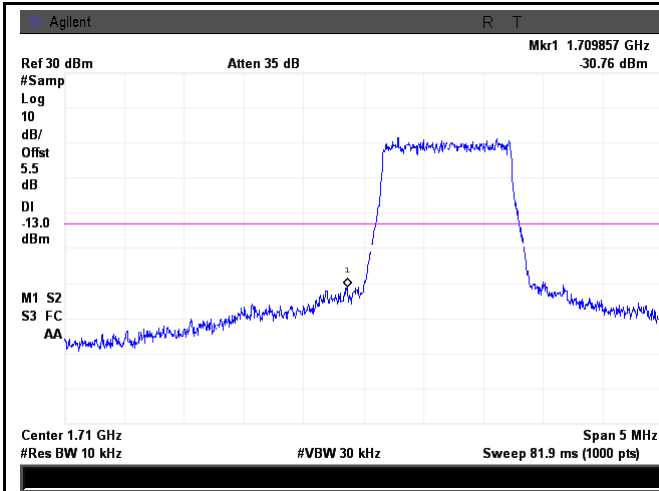

LTE Band 4 - Low Channel QPSK-1.4

Note: Offset=Cable loss (4.5) + 10log
(12.71/10)=4.5+1.0=5.5 dB

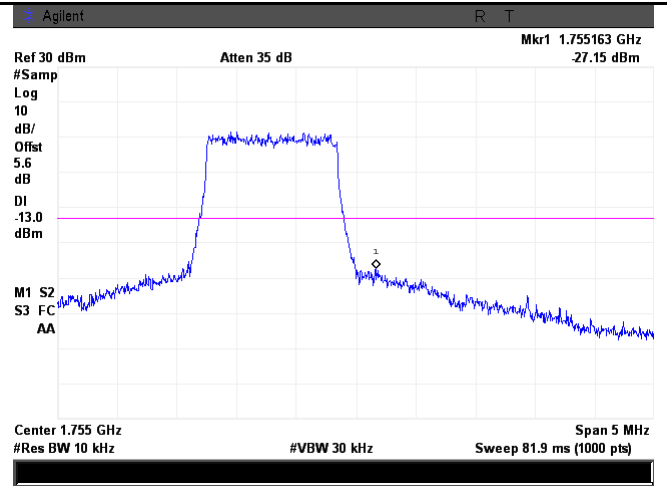

LTE Band 4 - High Channel QPSK-1.4

Note: Offset=Cable loss (4.5) + 10log
(12.74/10)=4.5+1.1=5.6 dB

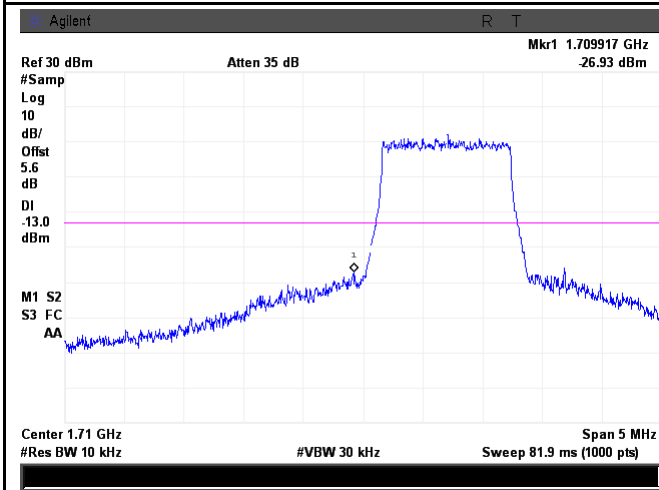

LTE Band 4 - Low Channel 16QAM-1.4

Note: Offset=Cable loss (4.5) + 10log
(12.78/10)=4.5+1.1=5.6 dB

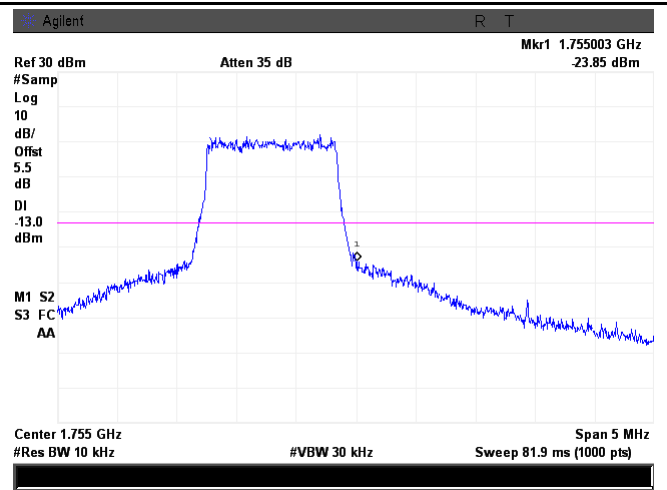

LTE Band 4 - High Channel 16QAM-1.4

Note: Offset=Cable loss (4.5) + 10log
(12.59/10)=4.5+1.0=5.5 dB

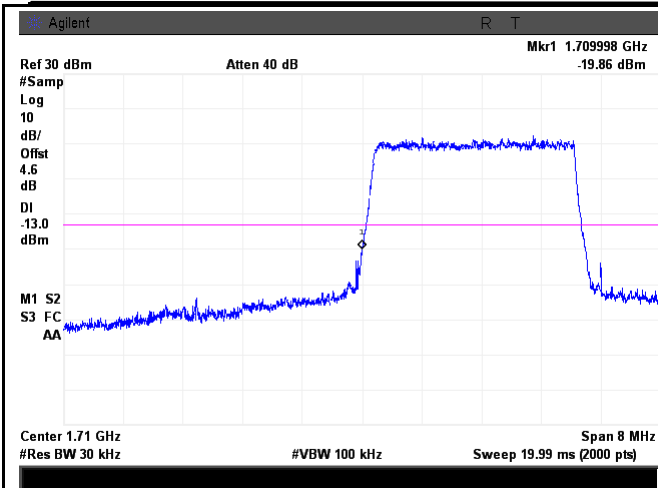

LTE Band 4 - Low Channel QPSK-3

Note: Offset=Cable loss (4.5) + 10log
(30.67/30)=4.5+0.1=4.6 dB

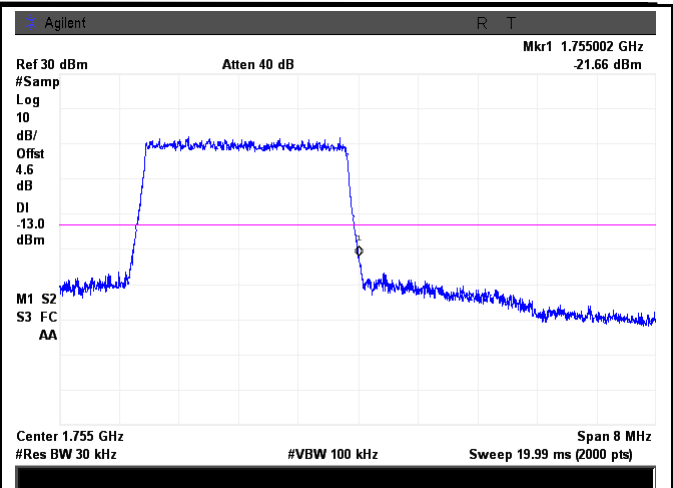

LTE Band 4 - High Channel QPSK-3

Note: Offset=Cable loss (4.5) + 10log
(30.83/30)=4.5+0.1=4.6 dB

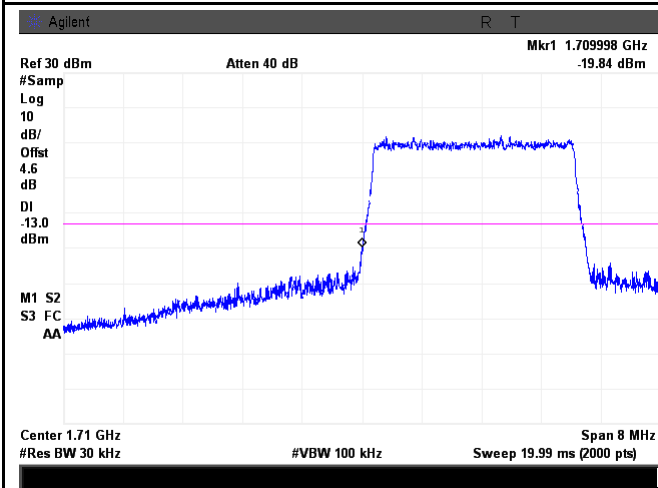

LTE Band 4 - Low Channel 16QAM-3

Note: Offset=Cable loss (4.5) + 10log
(30.91/30)=4.5+0.1=4.6 dB

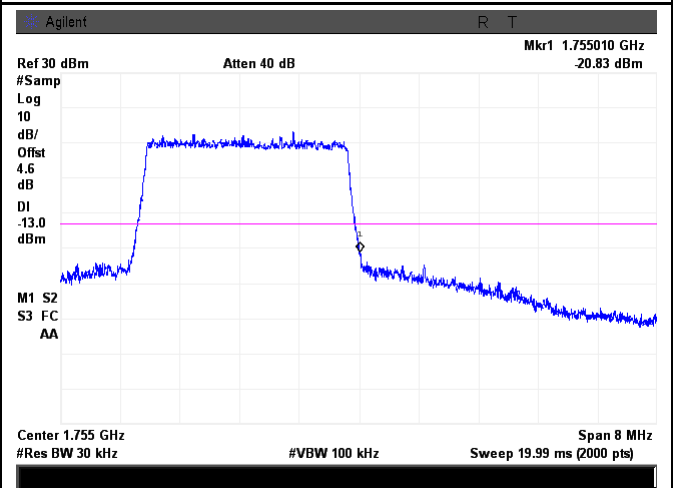

LTE Band 4 - High Channel 16QAM-3

Note: Offset=Cable loss (4.5) + 10log
(30.86/30)=4.5+0.1=4.6 dB

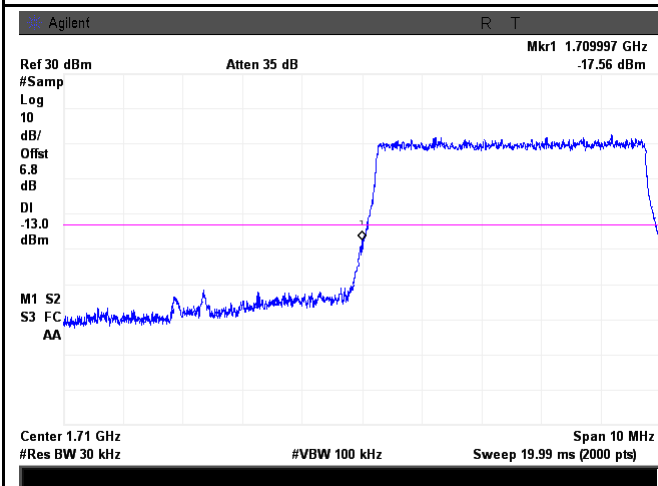

LTE Band 4 - Low Channel QPSK-5

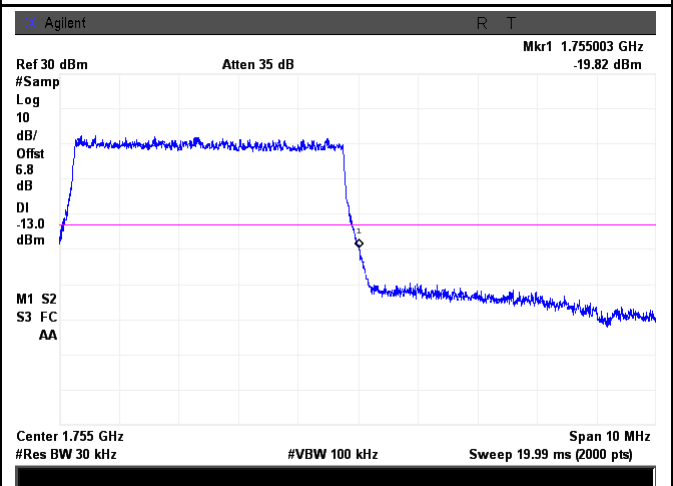

LTE Band 4 - High Channel QPSK-5

Note: Offset=Cable loss (4.5) + 10log
(50.98/30)=4.5+2.3=6.8 dB

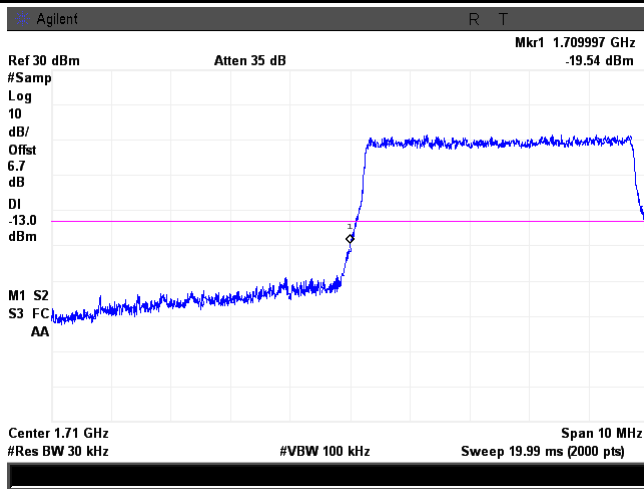

LTE Band 4 - Low Channel 16QAM-5

Note: Offset=Cable loss (4.5) + 10log
(51.12/30)=4.5+2.3=6.8 dB

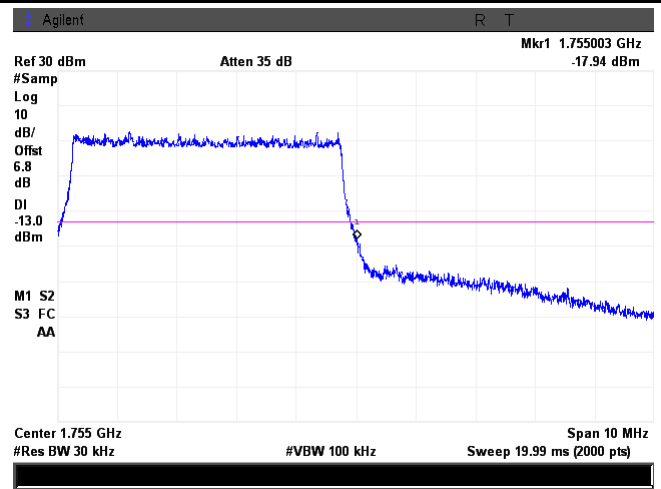

LTE Band 4 - High Channel 16QAM-5

Note: Offset=Cable loss (4.5) + 10log
(50.26/30)=4.5+2.2=6.7 dB

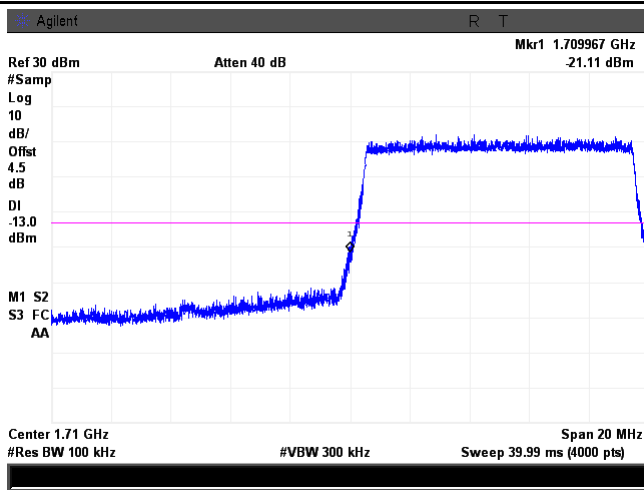

LTE Band 4 - Low Channel QPSK-10

Note: Offset=Cable loss (4.5) + 10log
(50.70/30)=4.5+2.3=6.8 dB

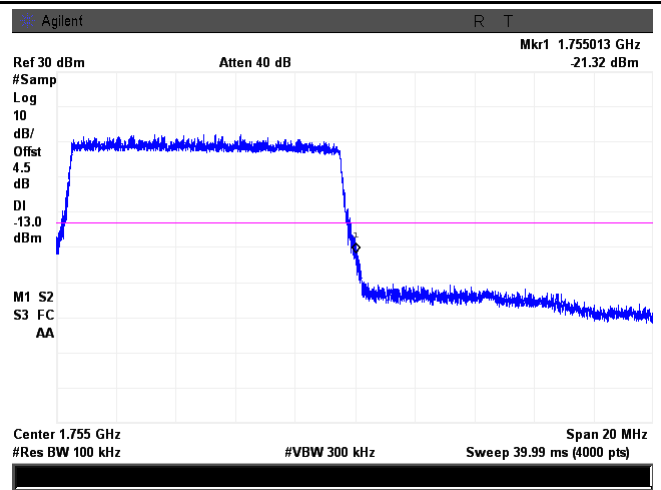

LTE Band 4 - High Channel QPSK-10

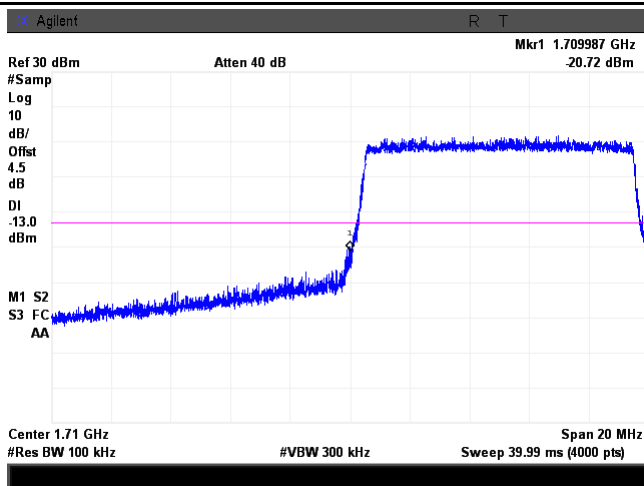

LTE Band 4 - Low Channel 16QAM-10

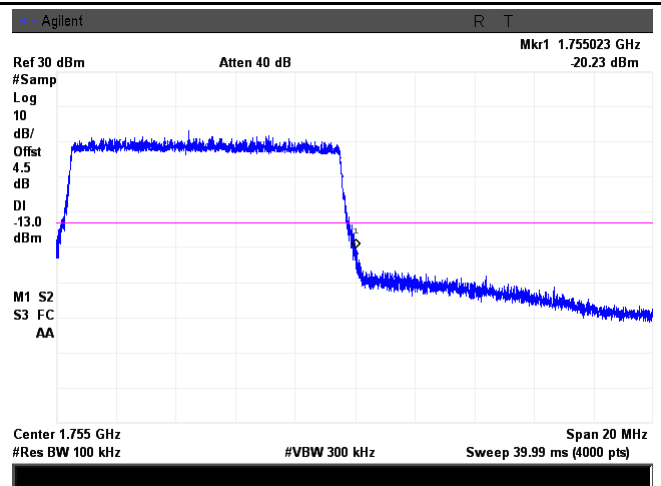

LTE Band 4 - High Channel 16QAM-10

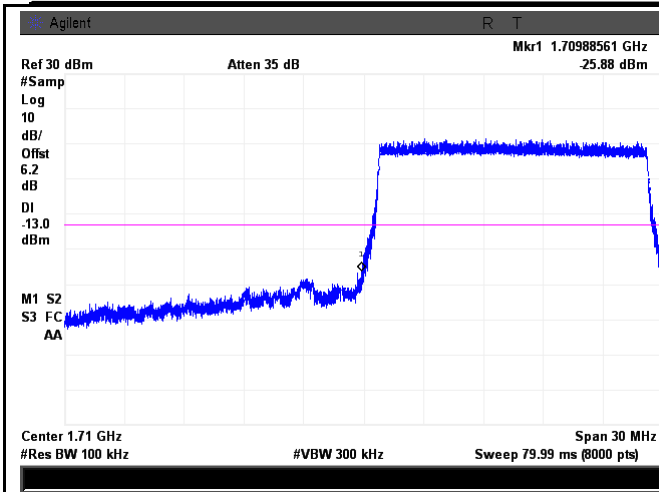

LTE Band 4 - Low Channel QPSK-15

Note: Offset=Cable loss (4.5) + 10log
(147/100)=4.5+1.7=6.2 dB

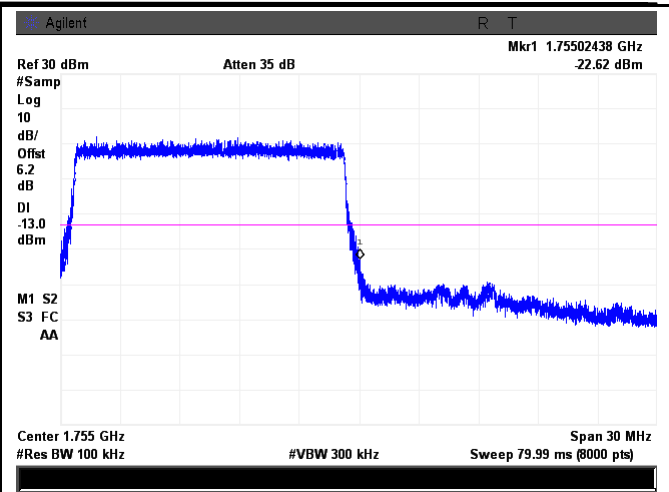

LTE Band 4 - High Channel QPSK-15

Note: Offset=Cable loss (4.5) + 10log
(148.1/100)=4.5+1.7=6.2 dB

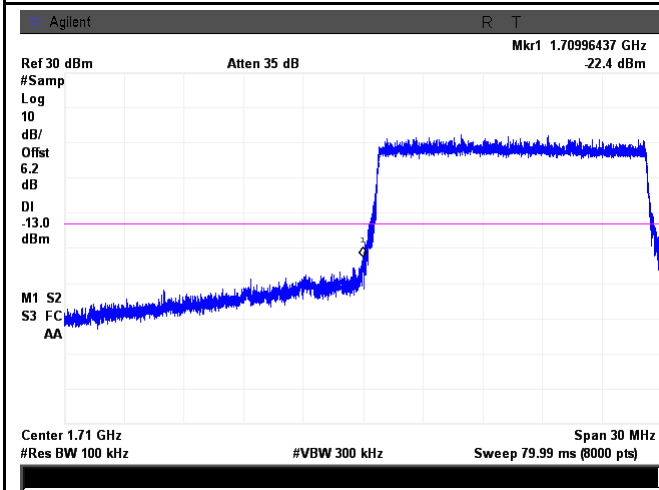

LTE Band 4 - Low Channel 16QAM-15

Note: Offset=Cable loss (4.5) + 10log
(148.3/100)=4.5+1.7=6.2 dB

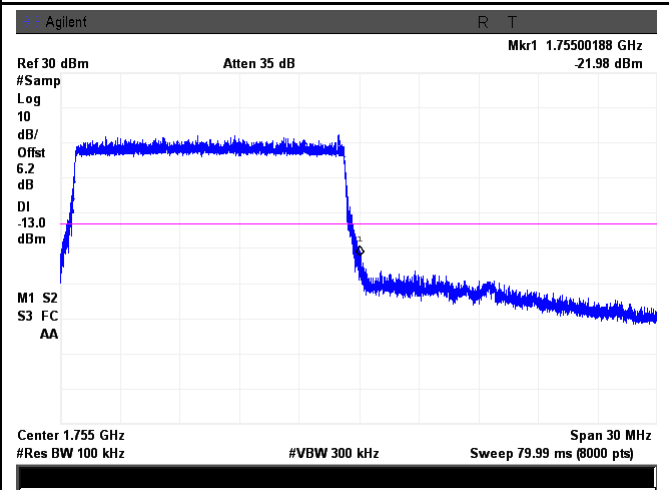

LTE Band 4 - High Channel 16QAM-15

Note: Offset=Cable loss (4.5) + 10log
(147.7/100)=4.5+1.7=6.2 dB

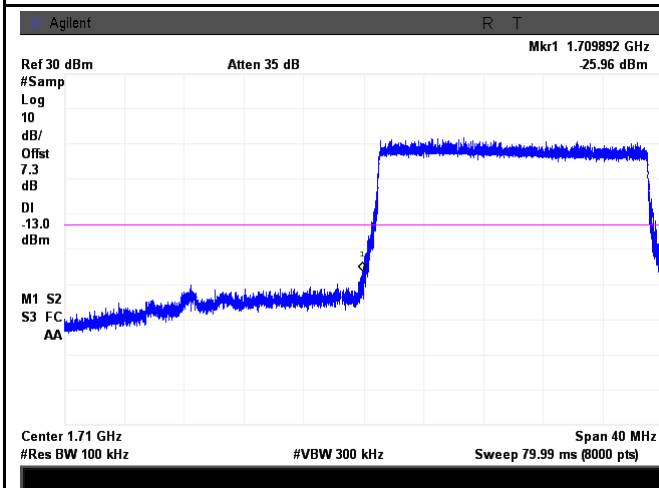

LTE Band 4 - Low Channel QPSK-20

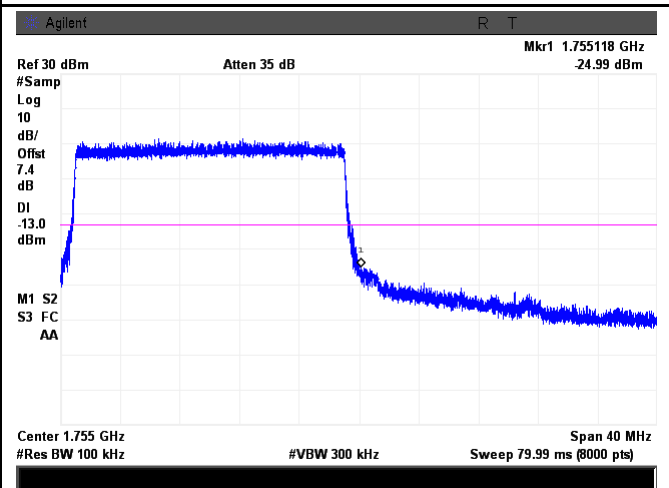

LTE Band 4 - High Channel QPSK-20

Note: Offset=Cable loss (4.5) + 10log
 (191.4/100)=4.5+2.8=7.3 dB

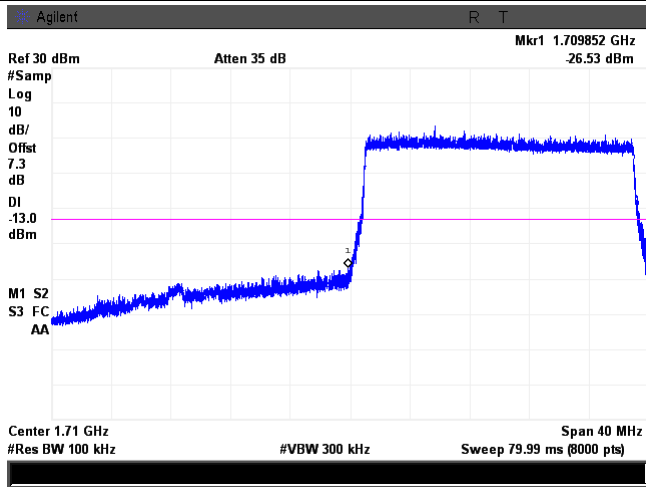

LTE Band 4 - Low Channel 16QAM-20

Note: Offset=Cable loss (4.5) + 10log
 (192.7/100)=4.5+2.8=7.3 dB

Note: Offset=Cable loss (4.5) + 10log
 (193.2/100)=4.5+2.9=7.4 dB

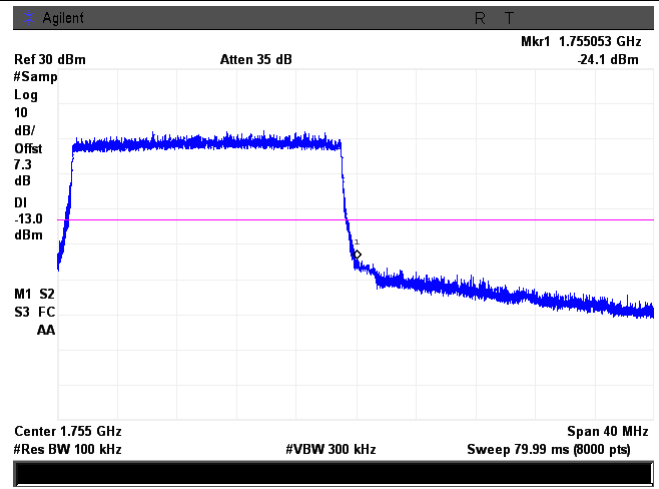

LTE Band 4 - High Channel 16QAM-20

Note: Offset=Cable loss (4.5) + 10log
 (192.6/100)=4.5+2.8=7.3 dB

LTE Band 5 (Part 22H)

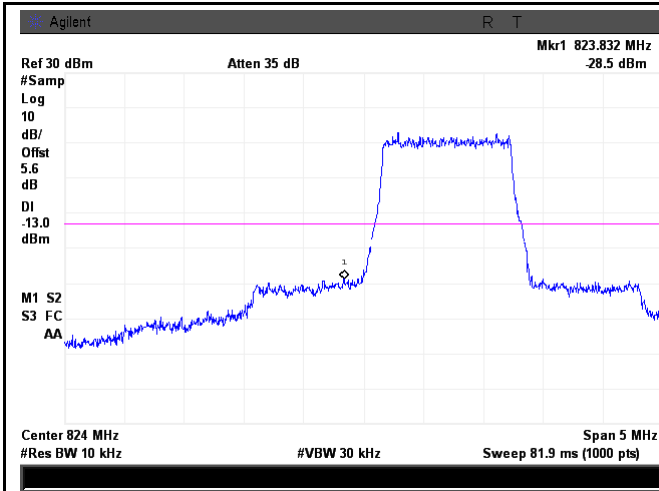

LTE Band 5 - Low Channel QPSK-1.4

Note: Offset=Cable loss (4.5) + 10log
(12.82/10)=4.5+1.1=5.6 dB

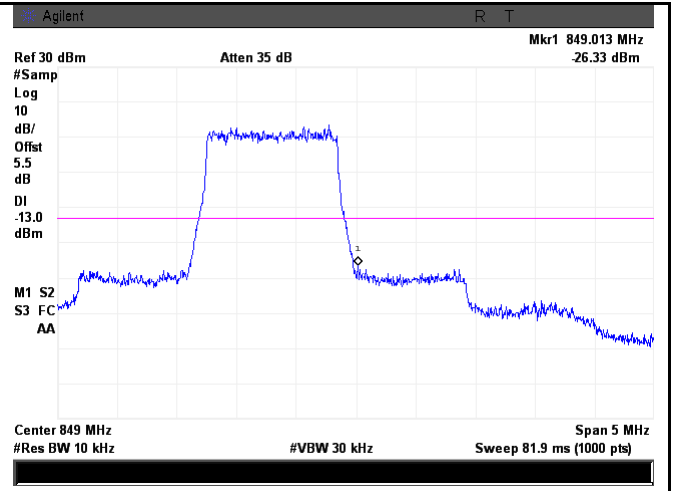

LTE Band 5 - High Channel QPSK-1.4

Note: Offset=Cable loss (4.5) + 10log
(12.67/10)=4.5+1.0=5.5 dB

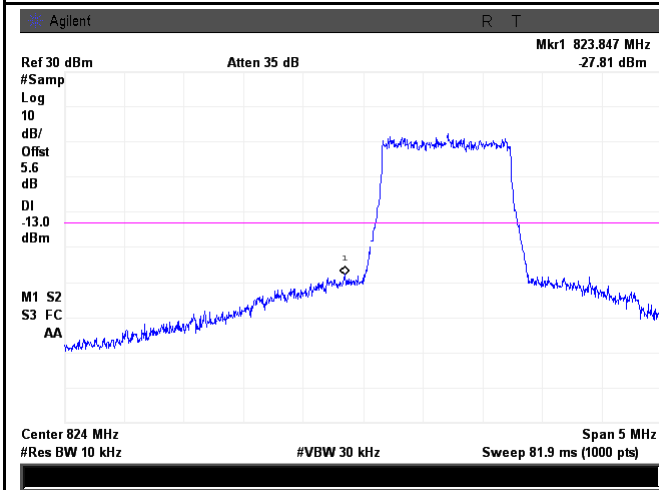

LTE Band 5 - Low Channel 16QAM-1.4

Note: Offset=Cable loss (4.5) + 10log
(12.78/10)=4.5+1.1=5.6 dB

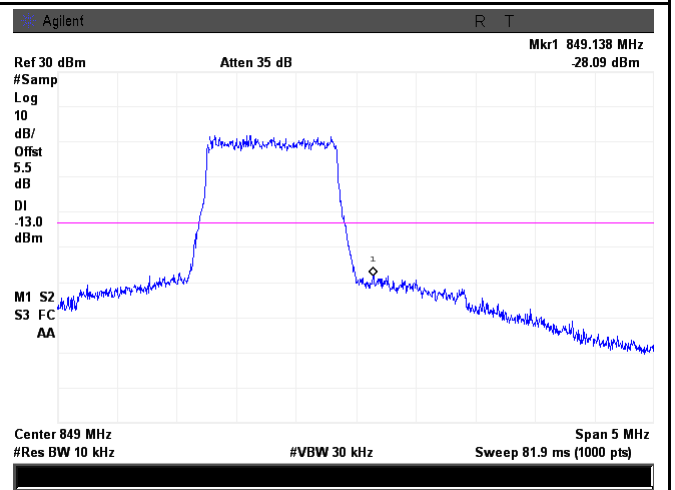

LTE Band 5 - High Channel 16QAM-1.4

Note: Offset=Cable loss (4.5) + 10log
(12.72/10)=4.5+1.0=5.5 dB

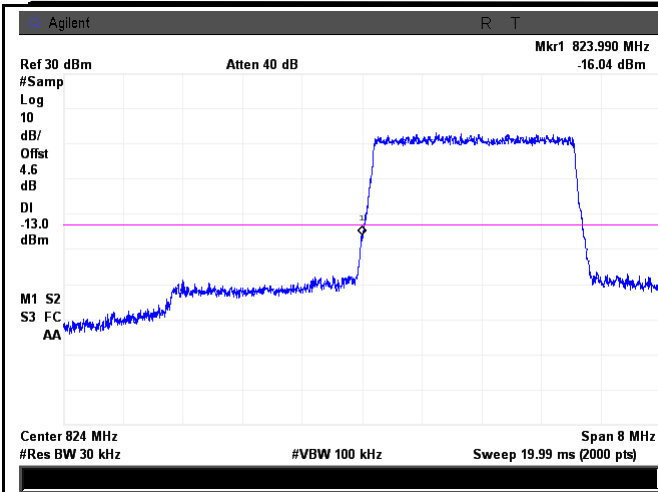

LTE Band 5 - Low Channel QPSK-3

Note: Offset=Cable loss (4.5) + 10log
(30.99/30)=4.5+0.1=4.6dB

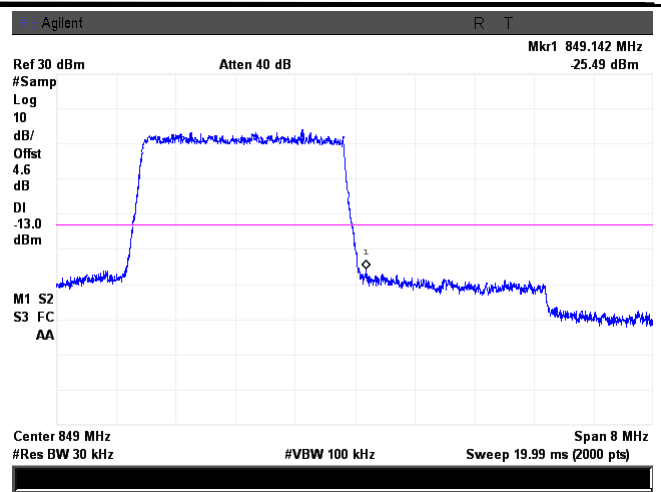

LTE Band 5 - High Channel QPSK-3

Note: Offset=Cable loss (4.5) + 10log
(30.99/30)=4.5+0.1=4.6 dB

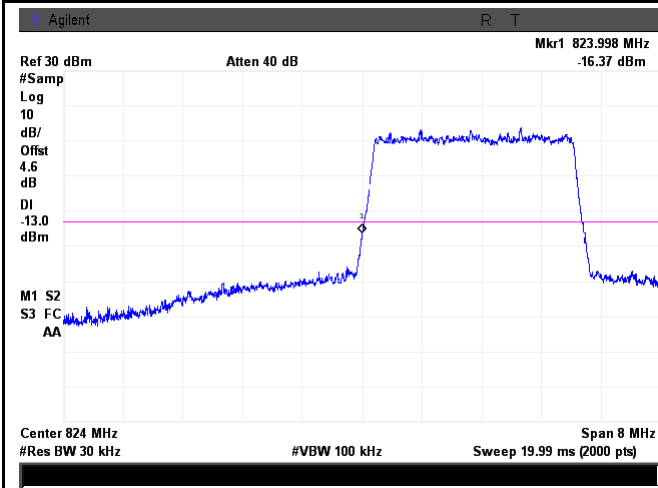

LTE Band 5 - Low Channel 16QAM-3

Note: Offset=Cable loss (4.5) + 10log
(30.78/30)=4.5+0.1=4.6 dB

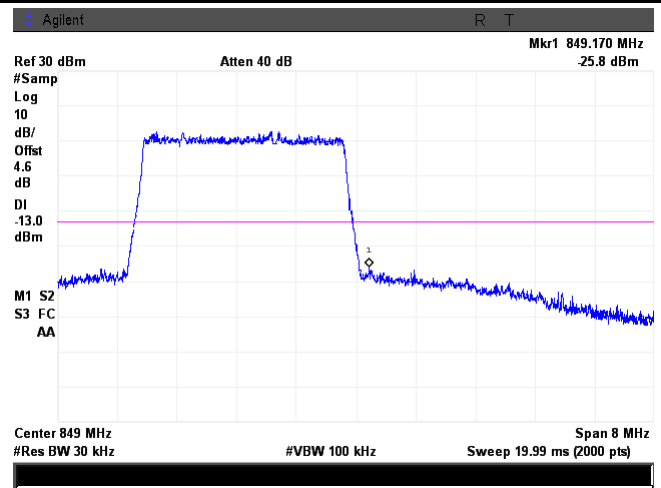

LTE Band 5 - High Channel 16QAM-3

Note: Offset=Cable loss (4.5) + 10log
(31.03/30)=4.5+0.1=4.6 dB

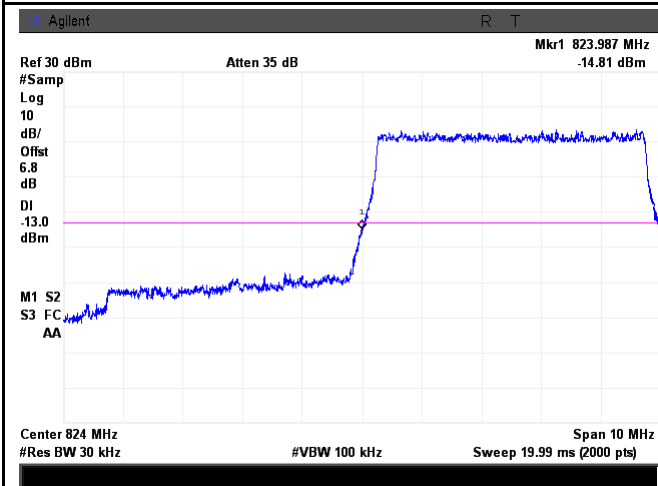

LTE Band 5 - Low Channel QPSK-5

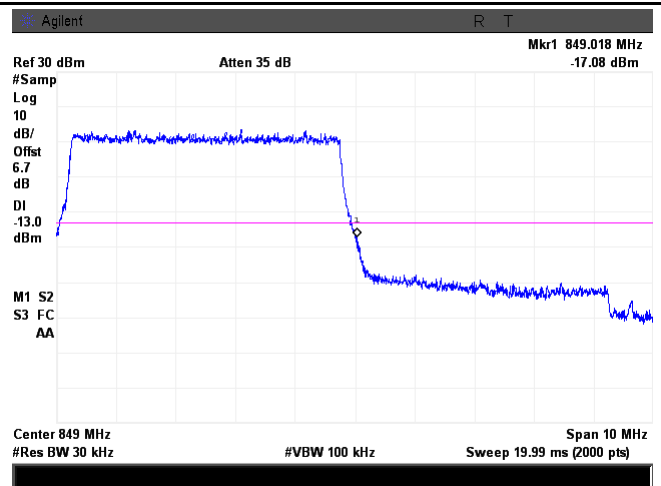

LTE Band 5 - High Channel QPSK-5

Note: Offset=Cable loss (4.5) + 10log
(50.80/30)=4.5+2.3=6.8 dB

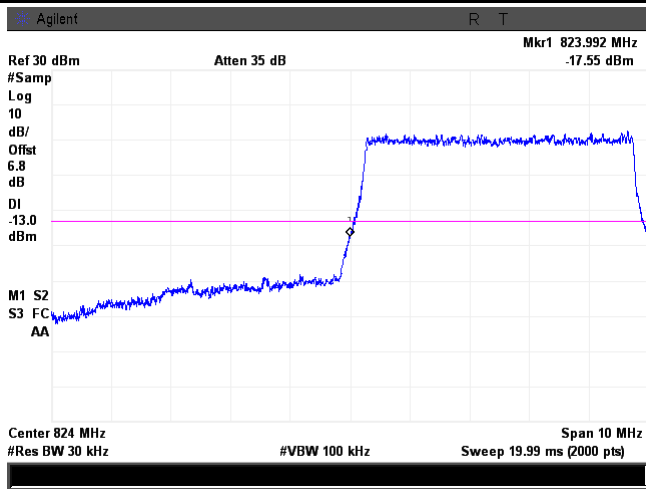

LTE Band 5 - Low Channel 16QAM-5

Note: Offset=Cable loss (4.5) + 10log
(50.23/30)=4.5+2.2=6.7 dB

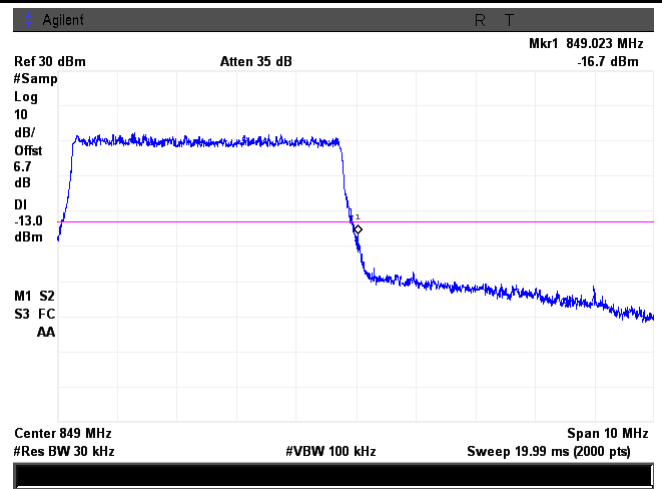

LTE Band 5 - High Channel 16QAM-5

Note: Offset=Cable loss (4.5) + 10log
(50.44/30)=4.5+2.3=6.8 dB

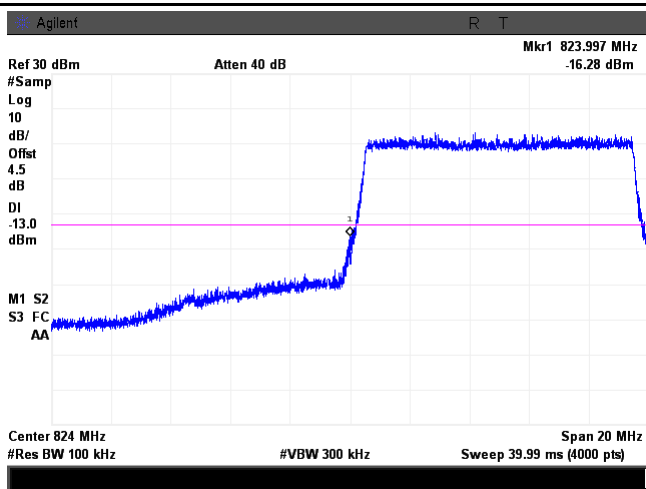

LTE Band 5 - Low Channel QPSK-10

Note: Offset=Cable loss (4.5) + 10log
(50.3/30)=4.5+2.2=6.7 dB

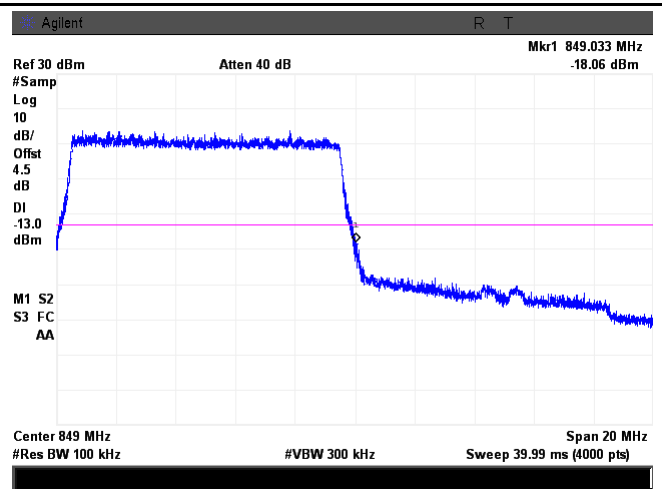

LTE Band 5 - High Channel QPSK-10

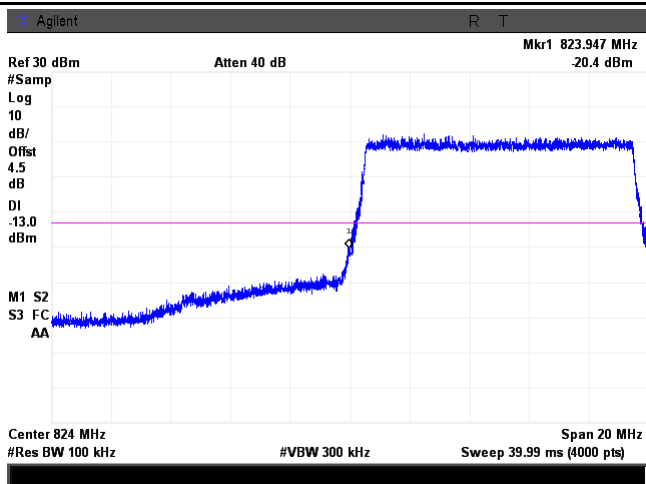

LTE Band 5 - Low Channel 16QAM-10

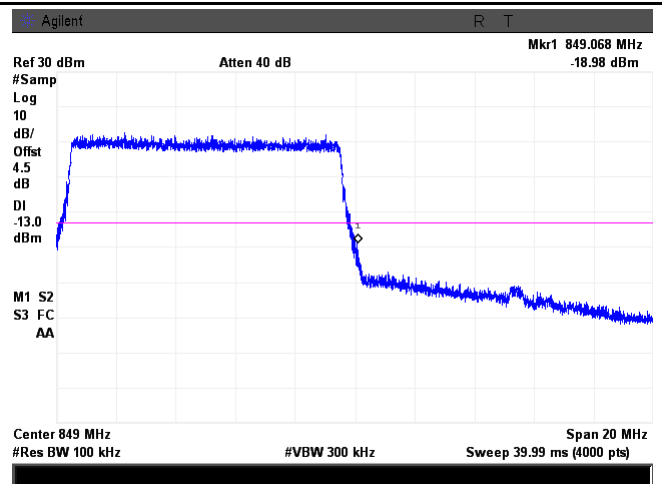

LTE Band 5 - High Channel 16QAM-10

LTE Band 12 (Part 27)

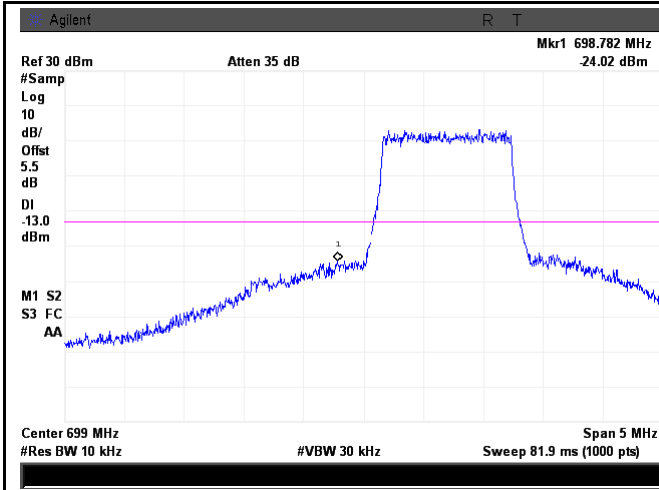

LTE Band 12 - Low Channel QPSK-1.4

Note: Offset=Cable loss (4.5) + 10log
(12.61/10)=4.5+1.0=5.5 dB

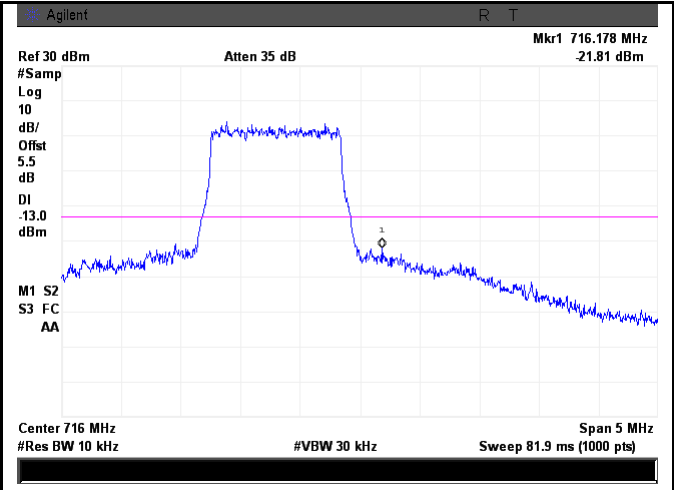

LTE Band 12 - High Channel QPSK-1.4

Note: Offset=Cable loss (4.5) + 10log
(12.73/10)=4.5+1.0=5.5 dB

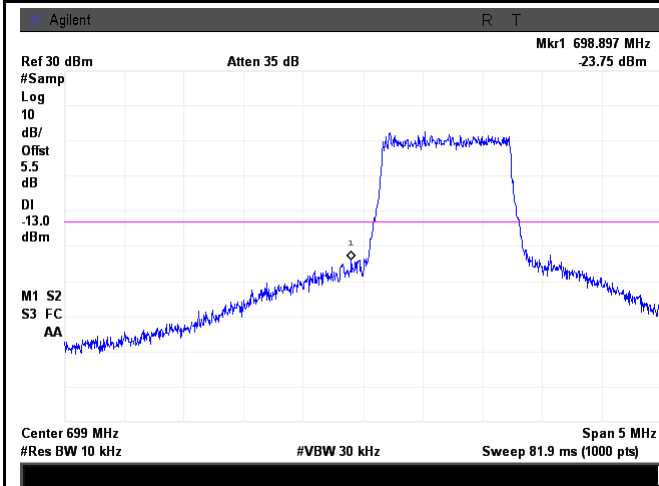

LTE Band 12 - Low Channel 16QAM-1.4

Note: Offset=Cable loss (4.5) + 10log
(12.65/10)=4.5+1.0=5.5 dB

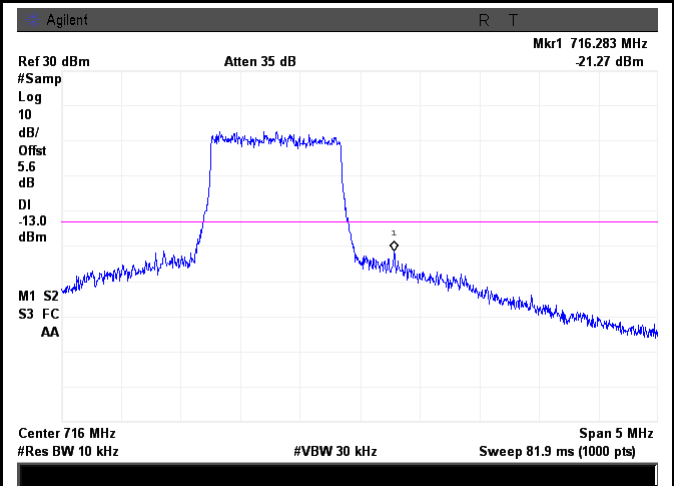

LTE Band 12 - High Channel 16QAM-1.4

Note: Offset=Cable loss (4.5) + 10log
(12.83/10)=4.5+1.1=5.6 dB

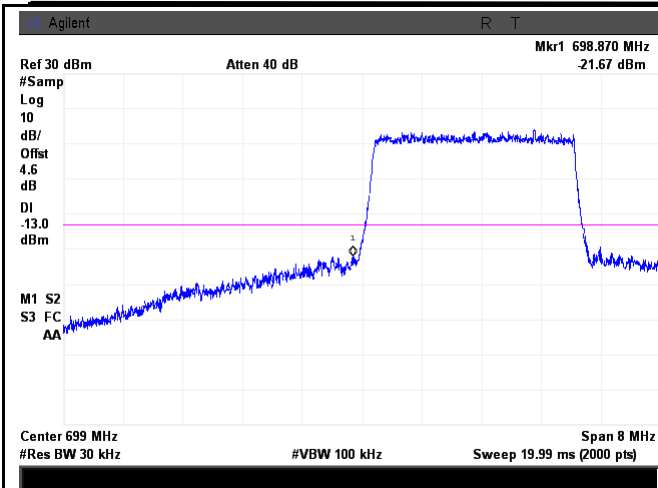

LTE Band 12 - Low Channel QPSK-3

Note: Offset=Cable loss (4.5) + 10log
(30.56/30)=4.5+0.1=4.6 dB

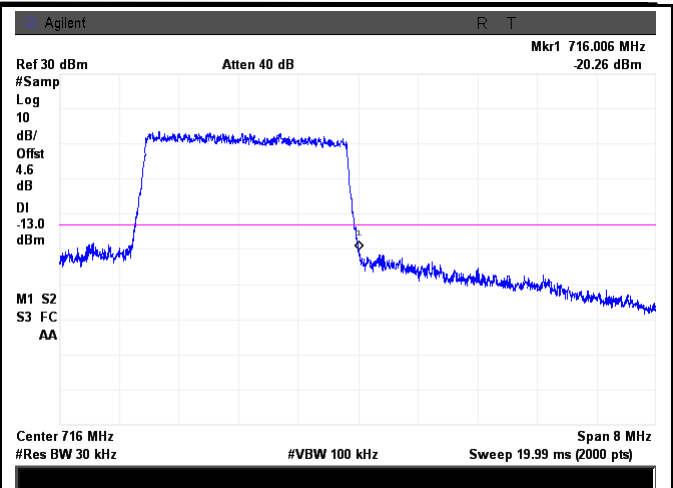

LTE Band 12 - High Channel QPSK-3

Note: Offset=Cable loss (4.5) + 10log
(30.76/30)=4.5+0.1=4.6 dB

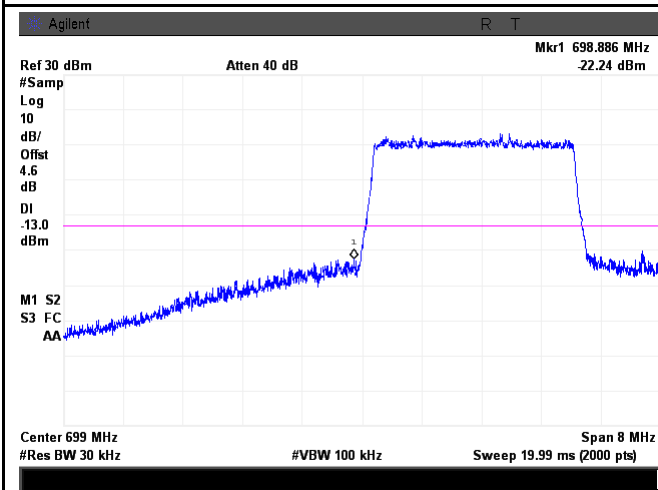

LTE Band 12 - Low Channel 16QAM-3

Note: Offset=Cable loss (4.5) + 10log
(30.88/30)=4.5+0.1=4.6 dB

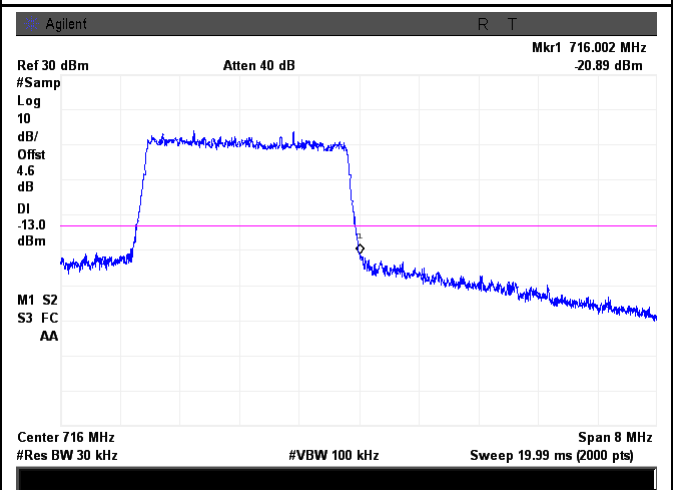

LTE Band 12 - High Channel 16QAM-3

Note: Offset=Cable loss (4.5) + 10log
(30.84/30)=4.5+0.1=4.6 dB

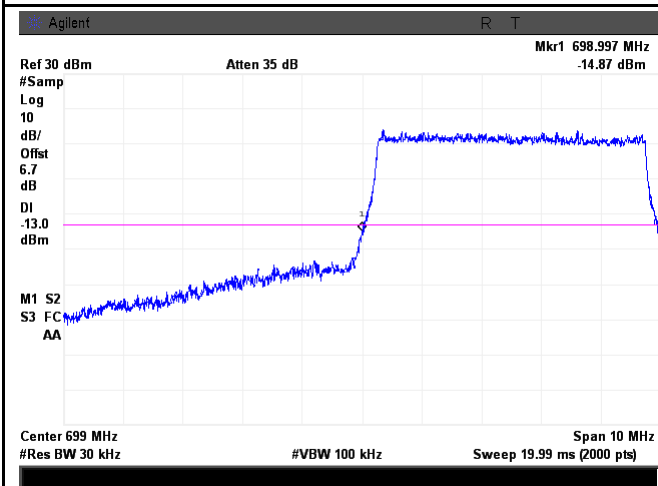

LTE Band 12 - Low Channel QPSK-5

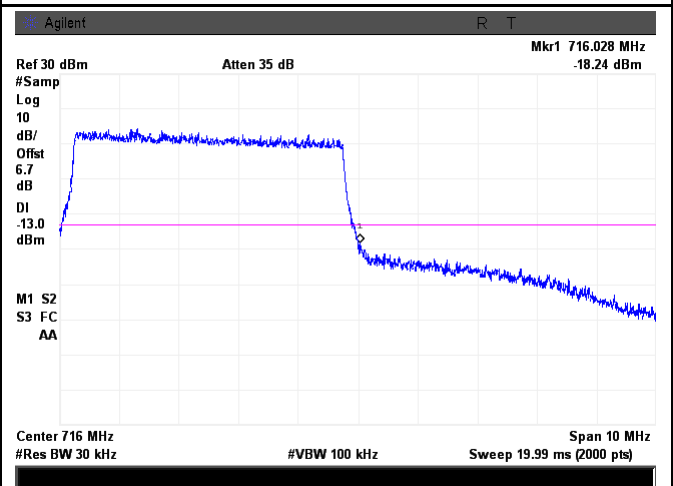

LTE Band 12 - High Channel QPSK-5

Note: Offset=Cable loss (4.5) + 10log
(50.33/30)=4.5+2.2=6.7dB

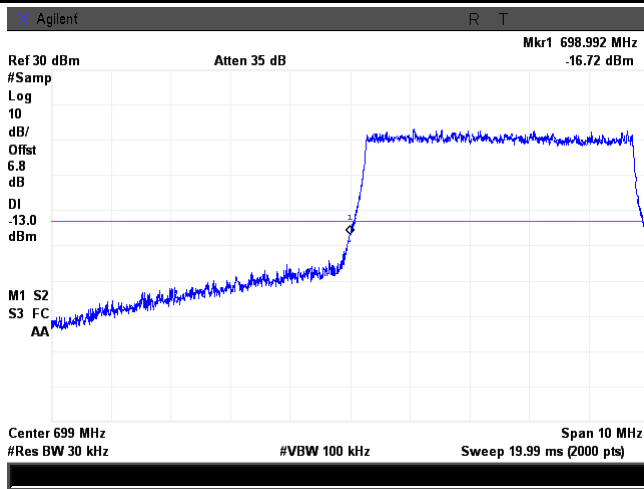

LTE Band 12 - Low Channel 16QAM-5

Note: Offset=Cable loss (4.5) + 10log
(50.02/30)=4.5+2.2=6.7 dB

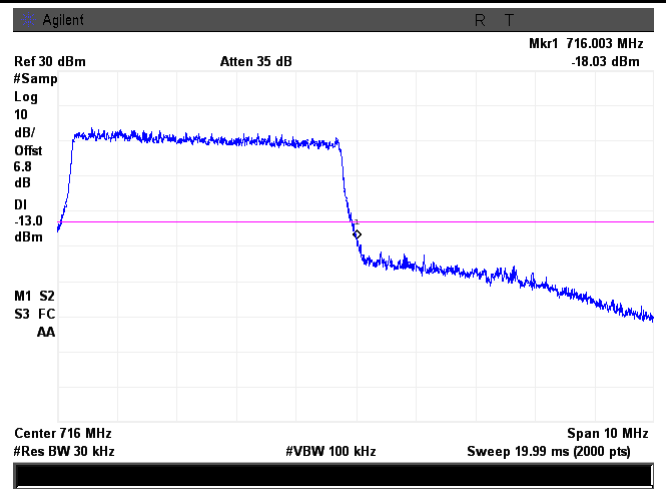

LTE Band 12 - High Channel 16QAM-5

Note: Offset=Cable loss (4.5) + 10log
(50.4/30)=4.5+2.3=6.8 dB

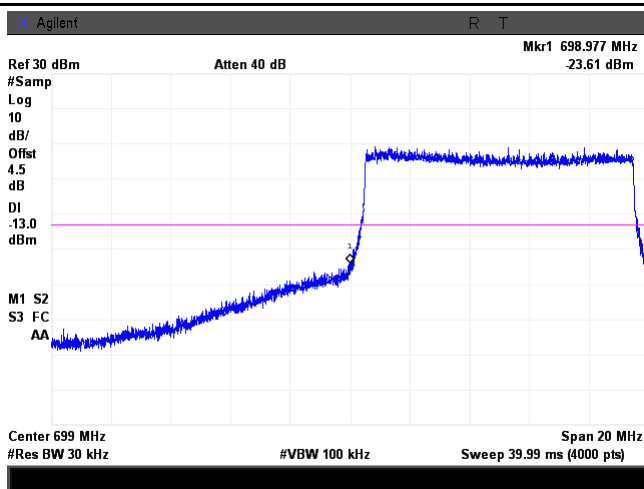

LTE Band 12 - Low Channel QPSK-10

Note: Offset=Cable loss (4.5) + 10log
(50.67/30)=4.5+2.3=6.8dB

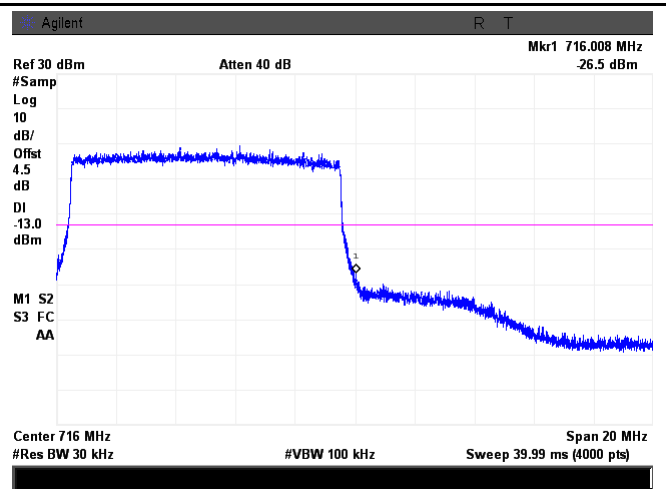

LTE Band 12 - High Channel QPSK-10

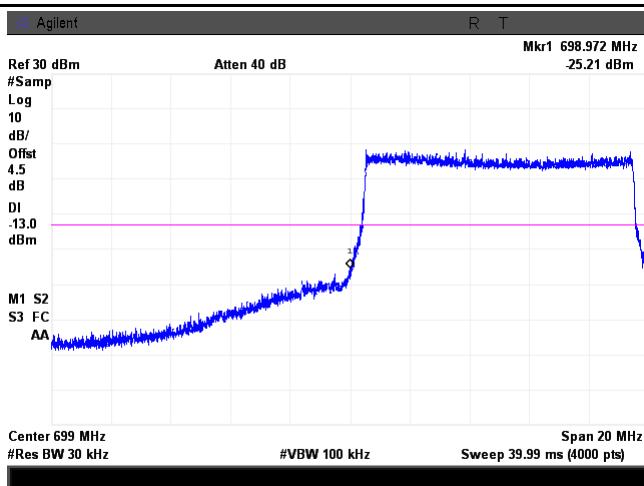

LTE Band 12 - Low Channel 16QAM-10

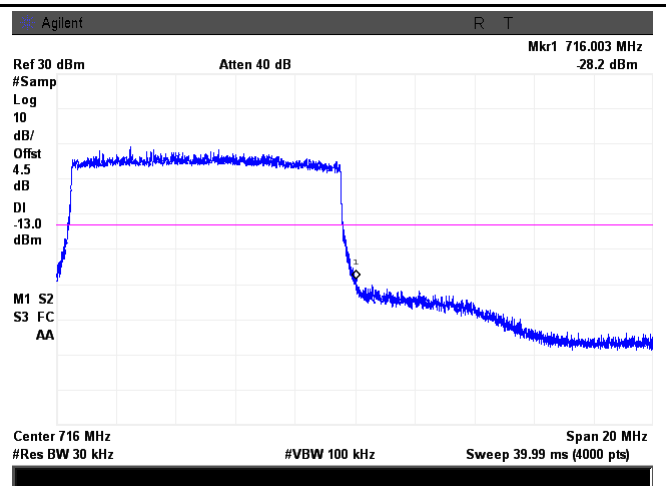

LTE Band 12 - High Channel 16QAM-10

LTE Band 17 (Part 27)

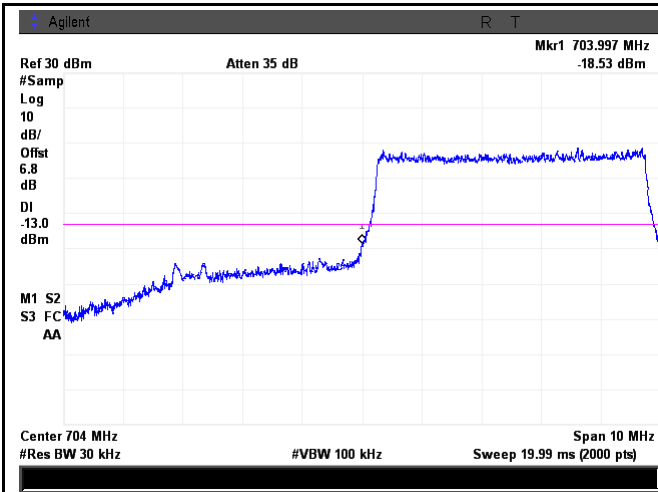

LTE Band 17 - Low Channel QPSK-5

Note: Offset=Cable loss (4.0) + 10log
 (50.42/30)=4.5+2.3=6.8 dB

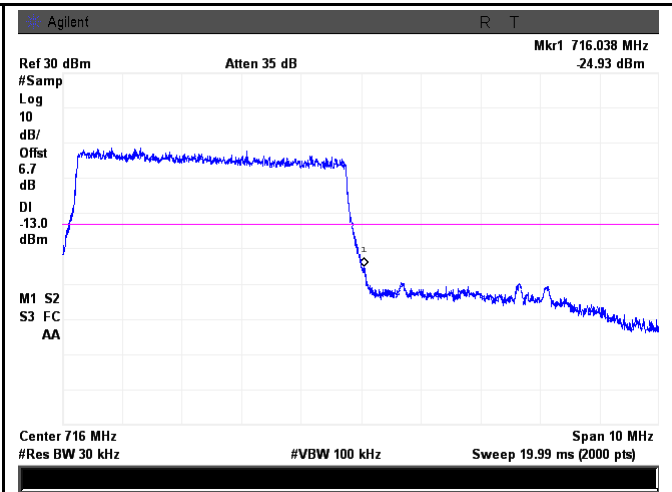

LTE Band 17 - High Channel QPSK-5

Note: Offset=Cable loss (4.0) + 10log
 (50.16/30)=4.5+2.2=6.7 dB

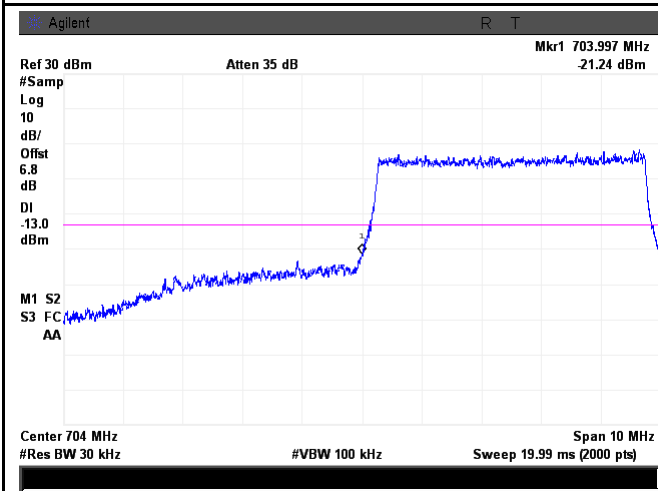

LTE Band 17 - Low Channel 16QAM-5

Note: Offset=Cable loss (4.0) + 10log
 (50.52/30)=4.5+2.3=6.8 dB

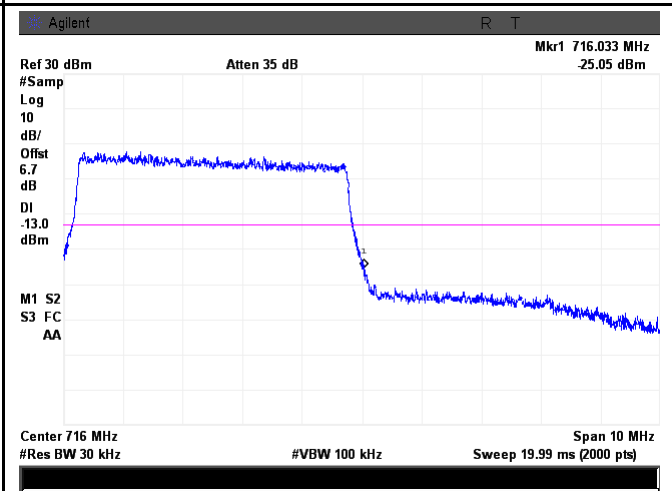

LTE Band 17 - High Channel 16QAM-5

Note: Offset=Cable loss (4.0) + 10log
 (49.95/30)=4.5+2.2=6.7 dB

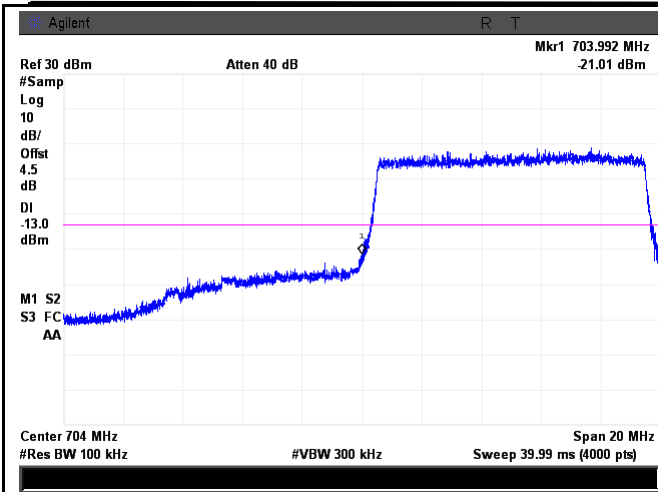

LTE Band 17 - Low Channel QPSK-10

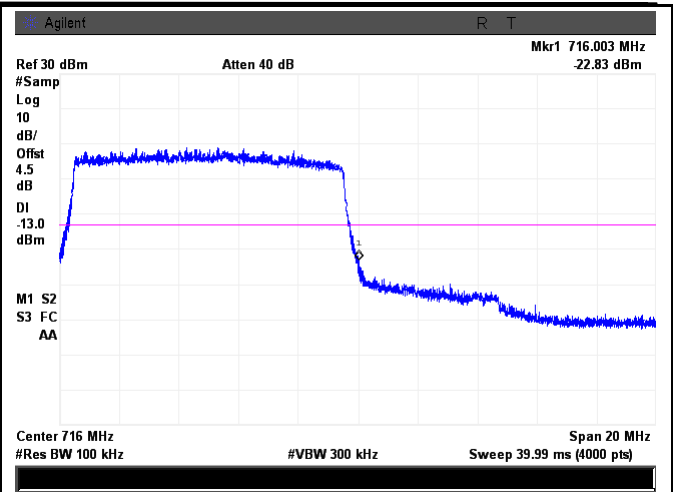

LTE Band 17 - High Channel QPSK-10

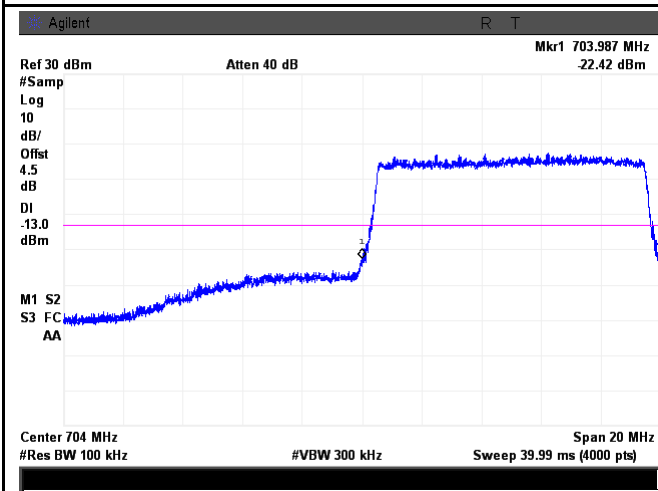

LTE Band 17 - Low Channel 16QAM-10

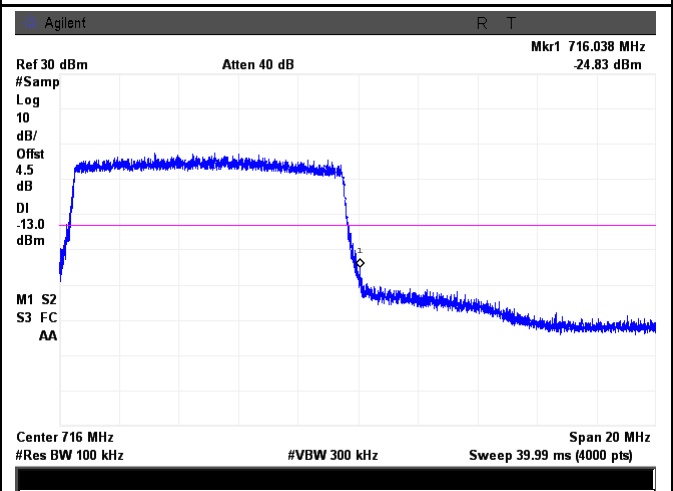

LTE Band 17 - High Channel 16QAM-10

6.8 Band Edge 27.53(m)

Temperature	25°C
Relative Humidity	57%
Atmospheric Pressure	1024mbar
Test date :	December 24, 2015
Tested By :	Winnie Zhang

Requirement(s):

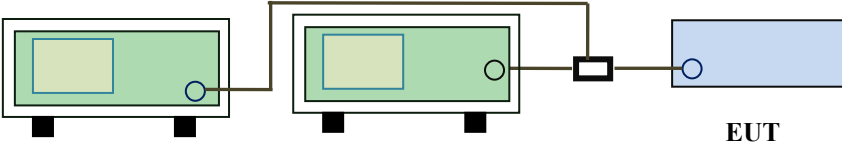
Spec	Requirement	Applicable
§27.53(m)	According to FCC 27.53(m)(4) specified that power of any emission outside of the channel edge must be attenuated below the transmitting power(P) by a factor shall be not less than $43+10\log(P)$ dB at the channel edge, the limit of emission equal to -13dBm. And $55+10\log(P)$ dB at 5.5MHz from the channel edges, the limit of emission equal to -25dBm. In the 1MHz bands immediately outside and adjacent to the frequency block a resolution bandwidth of at least one percent of the emission bandwidth of the fundamental emission of the transmitter may be employed.	<input checked="" type="checkbox"/>
Test Setup	 <p style="text-align: center;">Base Station Spectrum Analyzer EUT</p>	
Test Procedure	<ul style="list-style-type: none"> - The EUT was connected to Spectrum Analyzer and Base Station via power divider. - The 99% and 26 dB occupied bandwidth (BW) of the middle channel for the highest RF powers. 	
Remark		
Result	<input checked="" type="checkbox"/> Pass <input type="checkbox"/> Fail	

Test Data Yes N/A
 Test Plot Yes (See below) N/A

LTE Band 7 (Part 27) result

BW(MHz)	Channel	Frequency (MHz)	Mode	Emission (dBm)	Limit (dBm)
5	20775	2502.5	QPSK	-15.07	-13
			16QAM	-14.41	-13
5	21425	2567.5	QPSK	-15.29	-13
			16QAM	-17.56	-13
10	20800	2505	QPSK	-16.17	-13
			16QAM	-17.27	-13
10	21400	2562.5	QPSK	-16.70	-13
			16QAM	-18.30	-13
15	20825	2507.5	QPSK	-16.79	-13
			16QAM	-17.90	-13
15	21400	2562.5	QPSK	-15.35	-13
			16QAM	-18.33	-13
20	20850	2510	QPSK	-18.10	-13
			16QAM	-17.34	-13
20	21350	2560	QPSK	-15.87	-13
			16QAM	-18.57	-13

LTE Band 7 (Part 27)

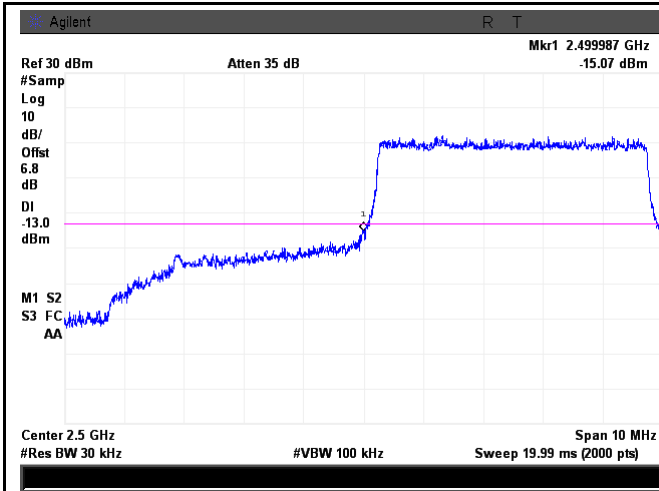

LTE Band 7 - Low Channel QPSK-5

Note: Offset=Cable loss (4.5) + 10log
 (50.42/30)=4.5+2.3=6.8 dB

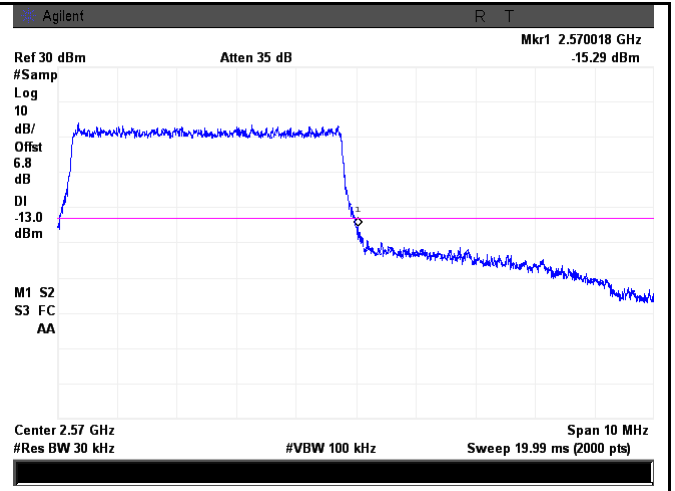

LTE Band 7 - High Channel QPSK-5

Note: Offset=Cable loss (4.5) + 10log
 (50.5/30)=4.5+2.3=6.8 dB

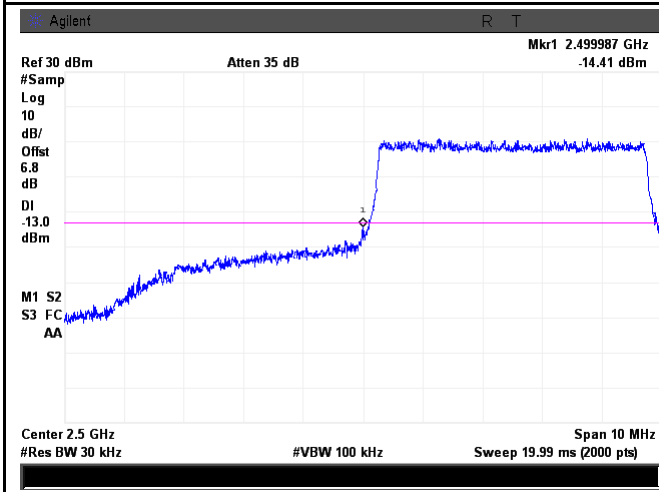

LTE Band 7 - Low Channel 16QAM-5

Note: Offset=Cable loss (4.5) + 10log
 (50.88/30)=4.5+2.3=6.8 dB

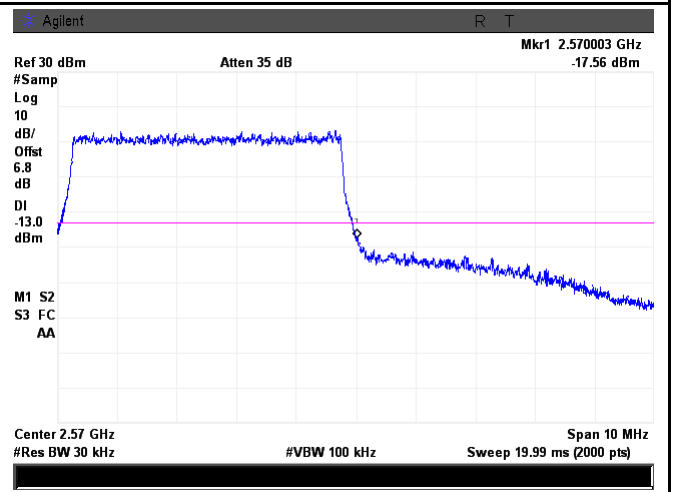

LTE Band 7 - High Channel 16QAM-5

Note: Offset=Cable loss (4.5) + 10log
 (50.86/30)=4.5+2.3=6.8 dB

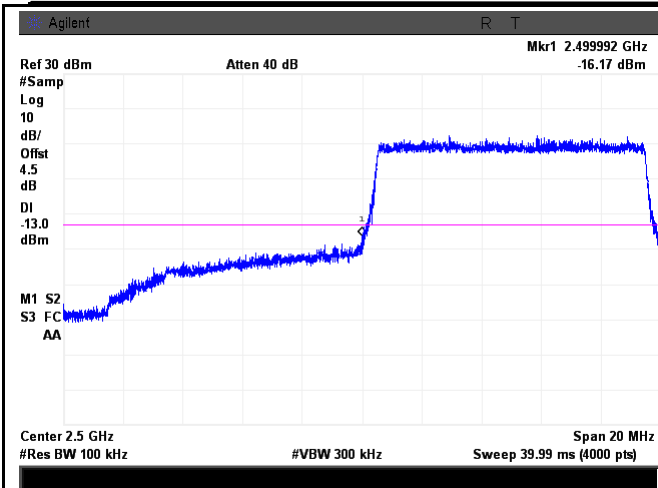

LTE Band 7 - Low Channel QPSK-10

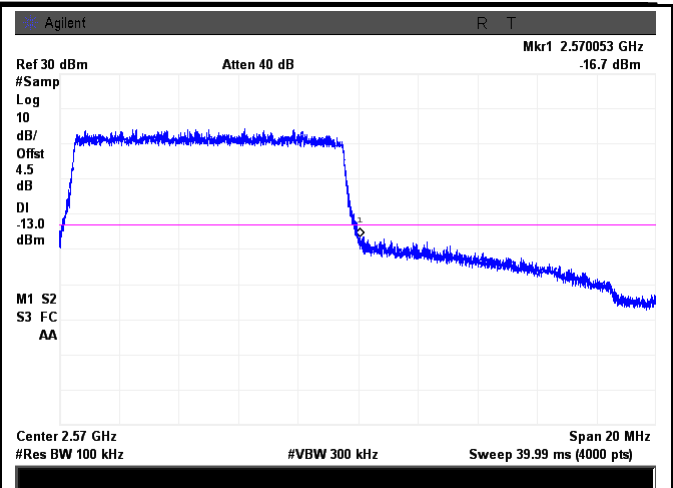

LTE Band 7 - High Channel QPSK-10

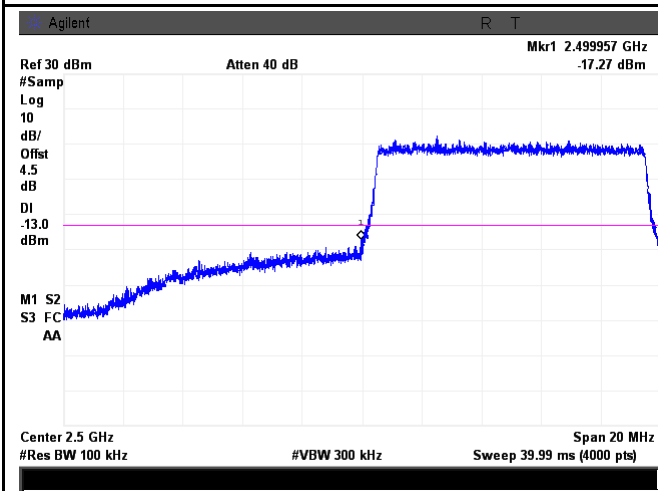

LTE Band 7 - Low Channel 16QAM-10

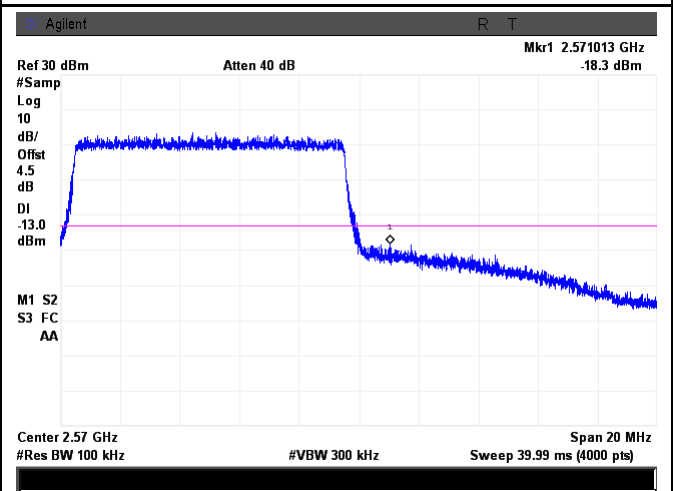

LTE Band 7 - High Channel 16QAM-10

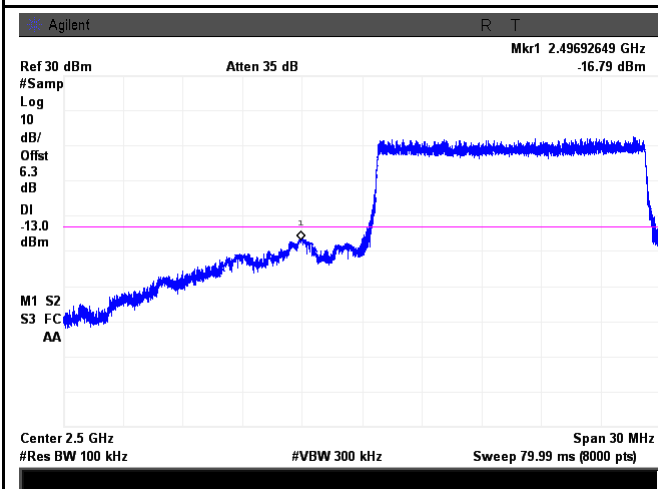

LTE Band 7 - Low Channel QPSK-15

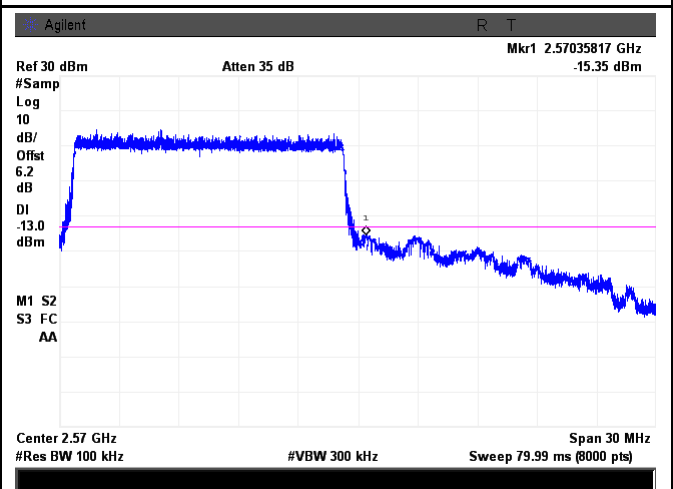

LTE Band 7 - High Channel QPSK-15

Note: Offset=Cable loss (4.5) + 10log
(149.6/100)=4.5+1.8=6.3 dB

Note: Offset=Cable loss (4.5) + 10log
(149.5/100)=4.5+1.7=6.2 dB

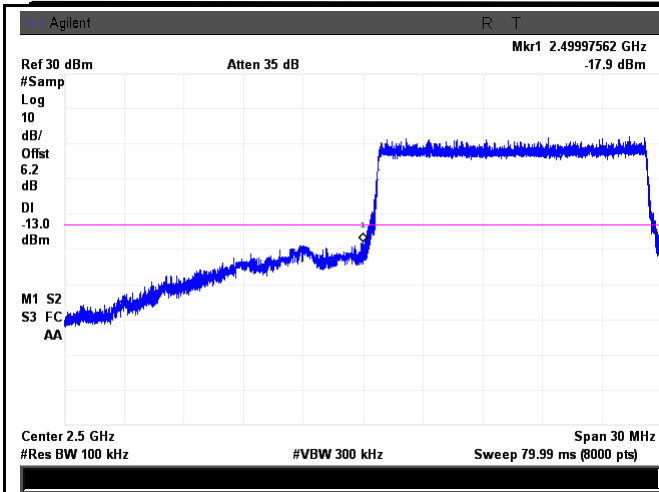

LTE Band 7 - Low Channel 16QAM-15

Note: Offset=Cable loss (4.5) + 10log
(149.2/100)=4.5+1.7=6.2 dB

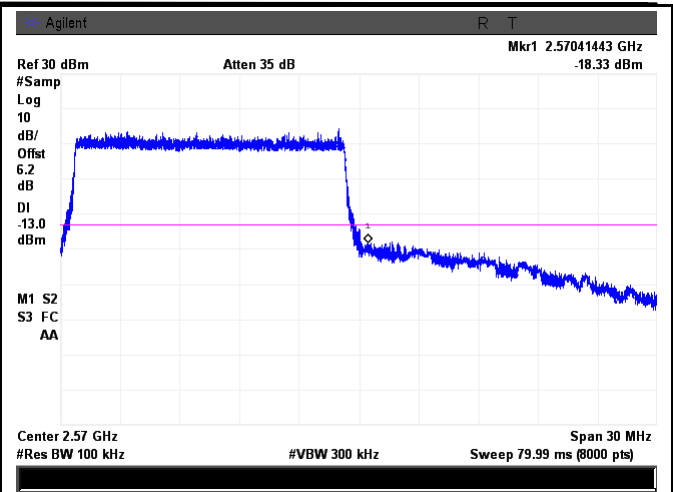

LTE Band 7 - High Channel 16QAM-15

Note: Offset=Cable loss (4.5) + 10log
(149/100)=4.5+1.7=6.2 dB

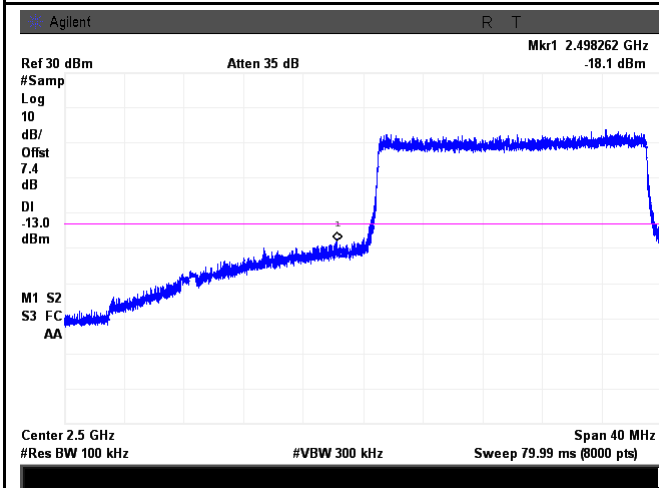

LTE Band 7 - Low Channel QPSK-20

Note: Offset=Cable loss (4.5) + 10log
(195.1/100)=4.5+2.9=7.4 dB

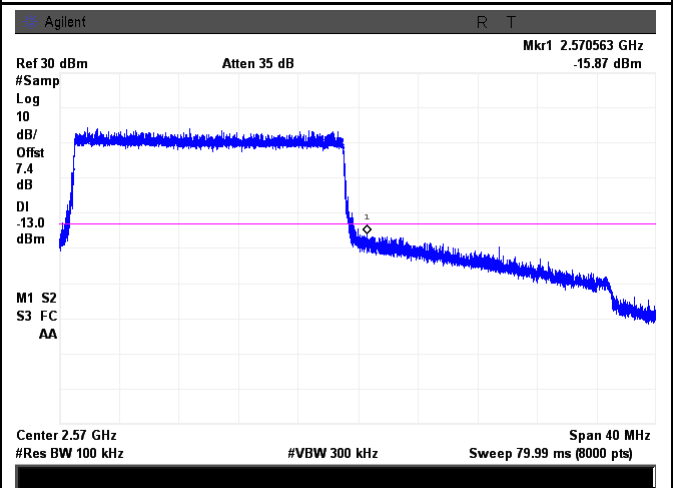

LTE Band 7 - High Channel QPSK-20

Note: Offset=Cable loss (4.5) + 10log
(195.3/100)=4.5+2.9=7.4 dB

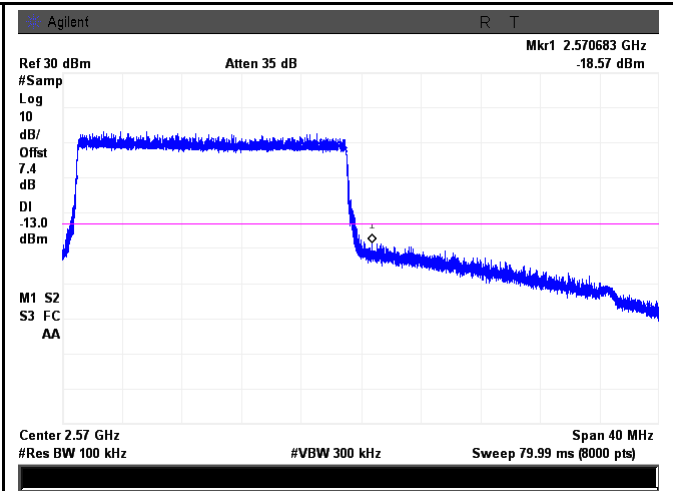
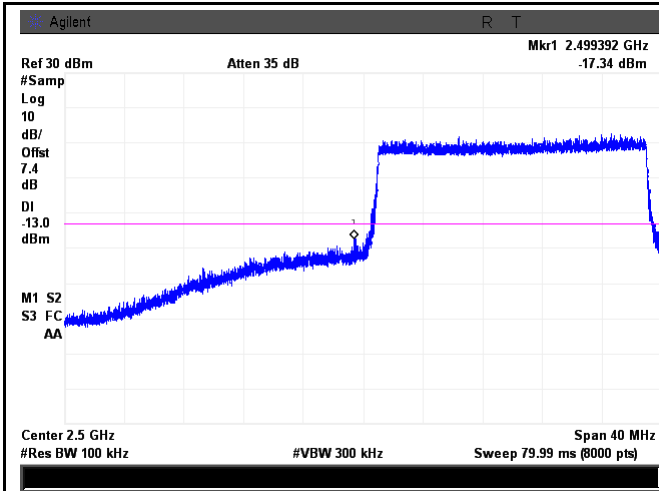

LTE Band 7 - Low Channel 16QAM-20

LTE Band 7 - High Channel 16QAM-20

Note: Offset=Cable loss (4.5) + 10log
 (193.9/100)=4.5+2.9=7.4 dB

Note: Offset=Cable loss (4.5) + 10log
 (193.1/100)=4.5+2.9=7.4 dB

6.9 Frequency Stability

Temperature	25°C
Relative Humidity	57%
Atmospheric Pressure	1024mbar
Test date :	December 24, 2015
Tested By :	Winnie Zhang

Requirement(s):

Spec	Item	Requirement	Applicable																																
§2.1055, §22.355 & §24.235 § 27.5(h); § 27.54	a)	<p>According to §22.355, the carrier frequency of each transmitter in the Public Mobile Services must be maintained within the tolerances given in Table below:</p> <p>Frequency Tolerance for Transmitters in the Public Mobile Services</p> <table border="1"> <thead> <tr> <th>Frequency Range (MHz)</th> <th>Base, fixed (ppm)</th> <th>Mobile ≤ 3 watts (ppm)</th> <th>Mobile ≤ 3 watts (ppm)</th> </tr> </thead> <tbody> <tr> <td>25 to 50</td> <td>20.0</td> <td>20.0</td> <td>50.0</td> </tr> <tr> <td>to 450</td> <td>5.0</td> <td>5.0</td> <td>50.0</td> </tr> <tr> <td>450 to 512</td> <td>2.5</td> <td>5.0</td> <td>5 0</td> </tr> <tr> <td>821 to 896</td> <td>1.5</td> <td>2.5</td> <td>2.5</td> </tr> <tr> <td>928 to 929.</td> <td>5.0</td> <td>N/A</td> <td>N/A</td> </tr> <tr> <td>929 to 960.</td> <td>1.5</td> <td>N/A</td> <td>N/A</td> </tr> <tr> <td>2110 to 2220</td> <td>10.0</td> <td>N/A</td> <td>N/A</td> </tr> </tbody> </table> <p>According to §24.235, the frequency stability shall be sufficient to ensure that the fundamental emissions stay within the authorized frequency block.</p> <p>According to §27.54, The frequency stability shall be sufficient to ensure that the fundamental emissions stay within the authorized bands of operation.</p>	Frequency Range (MHz)	Base, fixed (ppm)	Mobile ≤ 3 watts (ppm)	Mobile ≤ 3 watts (ppm)	25 to 50	20.0	20.0	50.0	to 450	5.0	5.0	50.0	450 to 512	2.5	5.0	5 0	821 to 896	1.5	2.5	2.5	928 to 929.	5.0	N/A	N/A	929 to 960.	1.5	N/A	N/A	2110 to 2220	10.0	N/A	N/A	<input checked="" type="checkbox"/>
		Frequency Range (MHz)	Base, fixed (ppm)	Mobile ≤ 3 watts (ppm)	Mobile ≤ 3 watts (ppm)																														
		25 to 50	20.0	20.0	50.0																														
		to 450	5.0	5.0	50.0																														
		450 to 512	2.5	5.0	5 0																														
		821 to 896	1.5	2.5	2.5																														
		928 to 929.	5.0	N/A	N/A																														
		929 to 960.	1.5	N/A	N/A																														
2110 to 2220	10.0	N/A	N/A																																

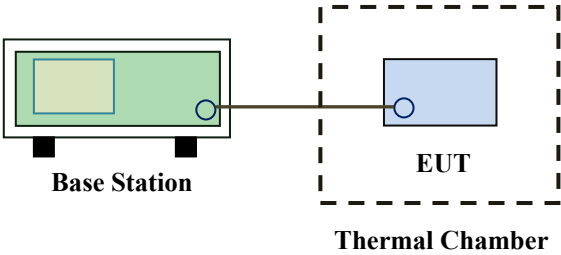
Test setup	 <p>The diagram illustrates the test setup. On the left, a green rectangular box labeled 'Base Station' is shown with a smaller green box inside it. A horizontal line connects a small circle on the right side of the Base Station to another small circle on the left side of a blue rectangular box labeled 'EUT'. The EUT and its connecting line are enclosed within a dashed rectangular box labeled 'Thermal Chamber'.</p>
Procedure	<p>A communication link was established between EUT and base station. The frequency error was monitored and measured by base station under variation of ambient temperature and variation of primary supply voltage.</p> <p>Limit: The frequency stability of the transmitter shall be maintained within $\pm 0.00025\%$ ($\pm 2.5\text{ppm}$) of the center frequency.</p>
Remark	<p>Frequency Stability versus Temperature: The Frequency tolerance of the carrier signal shall be maintained within 2.5ppm of the operating frequency over a temperature variation of -10°C to $+55^{\circ}\text{C}$ at normal supply voltage.</p>
Result	<p><input checked="" type="checkbox"/> Pass <input type="checkbox"/> Fail</p>

Test Data Yes N/A
 Test Plot Yes (See below) N/A

LTE Band 2 (Part 24E) result

Middle Channel, $f_0 = 1880$ MHz				
Temperature (°C)	Power Supplied (V _{DC})	Frequency Error (Hz)	Frequency Error (ppm)	Limit (ppm)
-10	3.7	-5	0.0027	2.5
0		-6	0.0032	2.5
10		-7	0.0037	2.5
20		-4	0.0021	2.5
30		-3	0.0016	2.5
40		-8	0.0043	2.5
50		-9	0.0048	2.5
55		-11	0.0059	2.5
25		4.2	-9	0.0048
	3.5	-10	0.0053	2.5

LTE Band 4 (Part 27) result

Middle Channel, $f_0 = 1732.5$ MHz				
Temperature (°C)	Power Supplied (V _{DC})	Frequency Error (Hz)	Frequency Error (ppm)	Limit (ppm)
-10	3.7	-11	0.0063	2.5
0		-12	0.0069	2.5
10		-10	0.0058	2.5
20		-15	0.0087	2.5
30		-14	0.0081	2.5
40		-13	0.0075	2.5
50		-11	0.0063	2.5
55		-16	0.0092	2.5
25		4.2	-12	0.0069
	3.5	-14	0.0081	2.5

LTE Band 5 (Part 22H) result

Middle Channel, $f_0 = 1732.5$ MHz				
Temperature (°C)	Power Supplied (V _{DC})	Frequency Error (Hz)	Frequency Error (ppm)	Limit (ppm)
-10	3.7	10	0.0120	2.5
0		8	0.0096	2.5
10		6	0.0072	2.5
20		9	0.0108	2.5
30		7	0.0084	2.5
40		5	0.0060	2.5
50		10	0.0120	2.5
55		12	0.0143	2.5
25	4.2	10	0.0120	2.5
	3.5	13	0.0155	2.5

LTE Band 7 (Part 27) result

Middle Channel, $f_0 = 2535$ MHz				
Temperature (°C)	Power Supplied (V _{DC})	Frequency Error (Hz)	Frequency Error (ppm)	Limit (ppm)
-10	3.7	-9	0.0036	2.5
0		-7	0.0028	2.5
10		-10	0.0039	2.5
20		-11	0.0043	2.5
30		-12	0.0047	2.5
40		-14	0.0055	2.5
50		-8	0.0032	2.5
55		-13	0.0051	2.5
25	4.2	-8	0.0032	2.5
	3.5	-11	0.0043	2.5

LTE Band 12 (Part 27) result

Middle Channel, $f_0 = 707.5\text{MHz}$				
Temperature (°C)	Power Supplied (V _{DC})	Frequency Error (Hz)	Frequency Error (ppm)	Limit (ppm)
-10	3.7	-8	0.0043	2.5
0		-6	0.0032	2.5
10		-9	0.0048	2.5
20		-10	0.0053	2.5
30		-11	0.0059	2.5
40		-13	0.0069	2.5
50		-7	0.0037	2.5
55		-12	0.0064	2.5
25		4.2	-10	0.0053
	3.5	-12	0.0064	2.5

LTE Band 17 (Part 27) result

Middle Channel, $f_0 = 710\text{MHz}$				
Temperature (°C)	Power Supplied (V _{DC})	Frequency Error (Hz)	Frequency Error (ppm)	Limit (ppm)
-10	3.7	6	0.0070	2.5
0		7	0.0113	2.5
10		11	0.0141	2.5
20		9	0.0056	2.5
30		3	0.0028	2.5
40		10	0.0155	2.5
50		12	0.0197	2.5
55		14	0.0028	2.5
25		4.2	10	0.0127
	3.5	14	0.0183	2.5

Annex A. TEST INSTRUMENT

Instrument	Model	Serial #	Cal Date	Cal Due	In use
RF Conducted Test					
Agilent ESA-E SERIES SPECTRUM ANALYZER	E4407B	MY45108319	09/16/2015	09/15/2016	<input checked="" type="checkbox"/>
Power Splitter	1#	1#	09/01/2015	08/31/2016	<input checked="" type="checkbox"/>
Universal Radio Communication Tester	CMU200	121393	09/25/2015	09/24/2016	<input checked="" type="checkbox"/>
Wideband Radio Communication Tester	CMW500	120906	03/28/2015	03/27/2016	<input checked="" type="checkbox"/>
Temperature/Humidity Chamber	UHL-270	001	10/09/2015	10/08/2016	<input checked="" type="checkbox"/>
DC Power Supply	E3640A	MY40004013	09/17/2015	09/16/2016	<input checked="" type="checkbox"/>
Radiated Emissions					
EMI test receiver	ESL6	100262	09/17/2015	09/16/2016	<input checked="" type="checkbox"/>
OPT 010 AMPLIFIER (0.1-1300MHz)	8447E	2727A02430	09/01/2015	08/31/2016	<input checked="" type="checkbox"/>
Microwave Preamplifier (0.5 ~ 18GHz)	PAM-118	443008	09/01/2015	08/31/2016	<input checked="" type="checkbox"/>
Bilog Antenna (30MHz~6GHz)	JB6	A110712	09/21/2015	09/20/2016	<input checked="" type="checkbox"/>
Bilog Antenna (30MHz~2GHz)	JB1	A112017	09/21/2015	09/20/2016	<input checked="" type="checkbox"/>
Double Ridge Horn Antenna (1 ~18GHz)	AH-118	71259	09/24/2015	09/23/2016	<input checked="" type="checkbox"/>
Double Ridge Horn Antenna (1 ~18GHz)	AH-118	71283	09/24/2015	09/23/2016	<input checked="" type="checkbox"/>
SYNTHESIZED SIGNAL GENERATOR	8665B	3744A01293	09/17/2015	09/16/2016	<input checked="" type="checkbox"/>
Tunable Notch Filter	3NF-800/1000-S	AA4	09/01/2015	08/31/2016	<input checked="" type="checkbox"/>
Tunable Notch Filter	3NF-1000/2000-S	AM 4	09/01/2015	08/31/2016	<input checked="" type="checkbox"/>

Annex B. EUT And Test Setup Photographs

Annex B.i. Photograph: EUT External Photo



Whole Package View

Adapter - Front View

EUT - Front View

EUT - Rear View



EUT - Top View



EUT - Bottom View

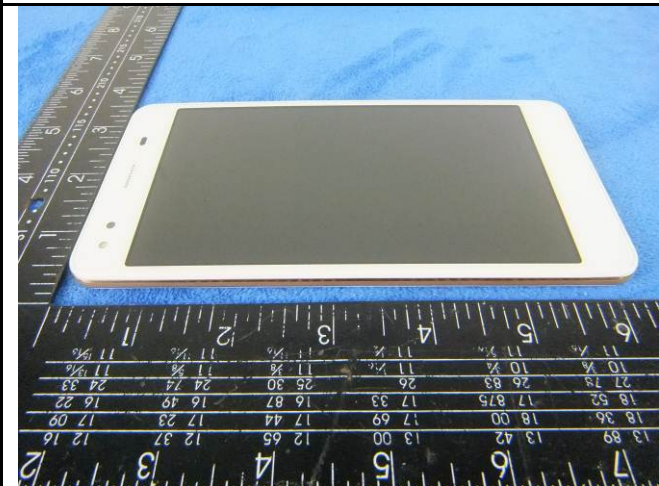

EUT - Left View

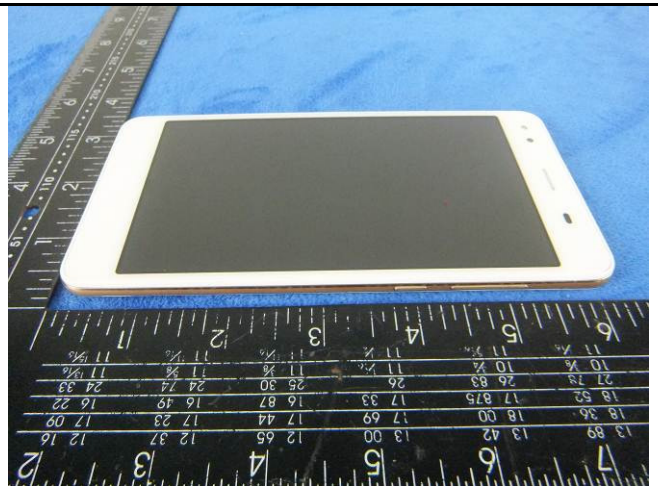

EUT - Right View

Annex B.ii. Photograph: EUT Internal Photo



Cover Off - Top View 1



Cover Off - Top View 2

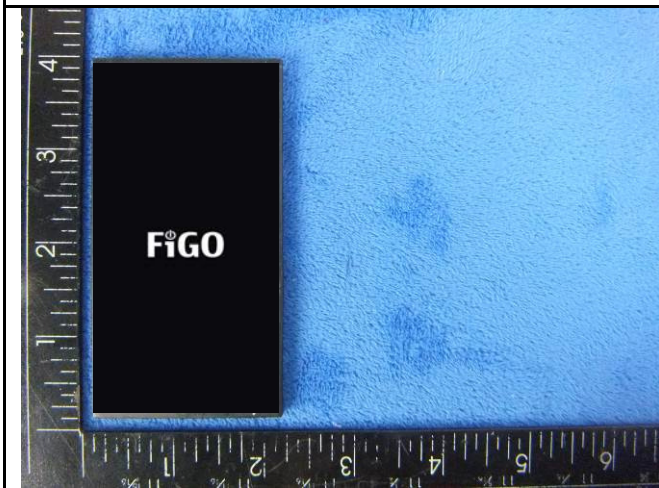

Battery - Front View



Battery - Rear View

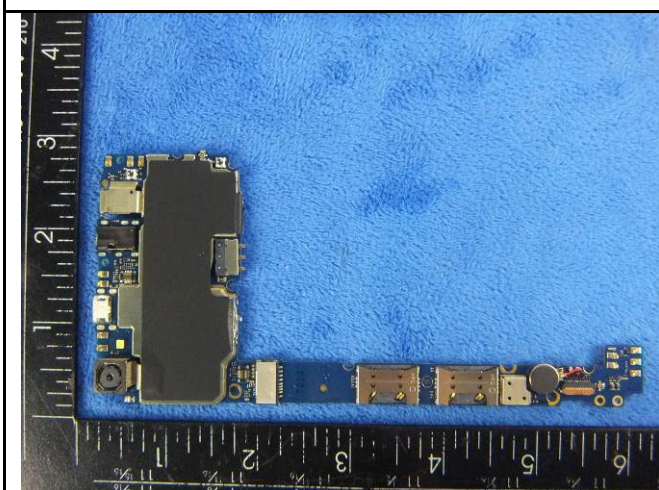

Mainboard with Shielding - Front View

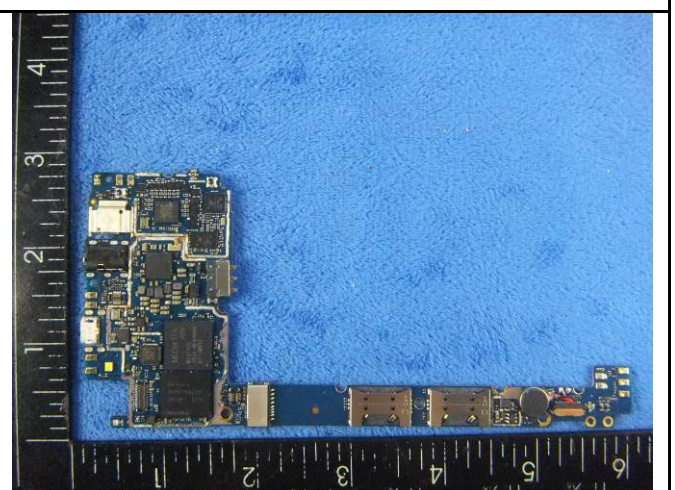

Mainboard without Shielding - Front View

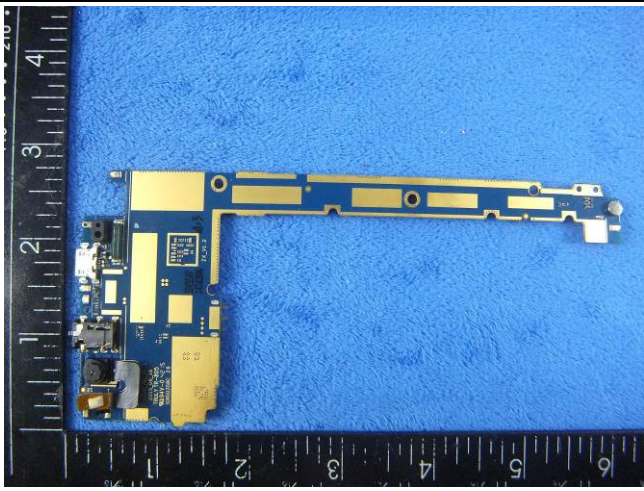

Mainboard – Rear View



LCD – Front View

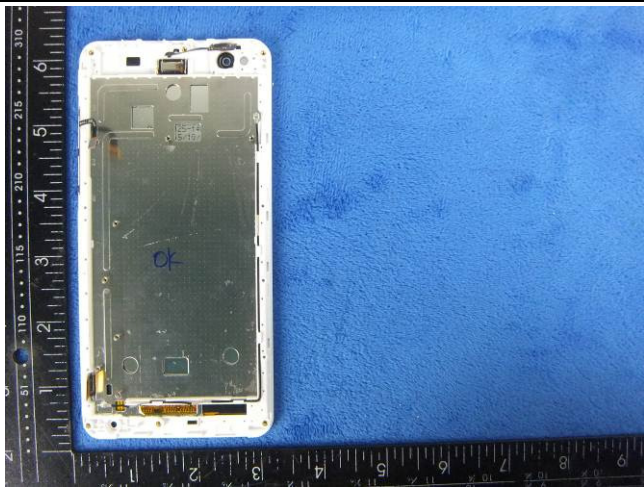

LCD – Rear View

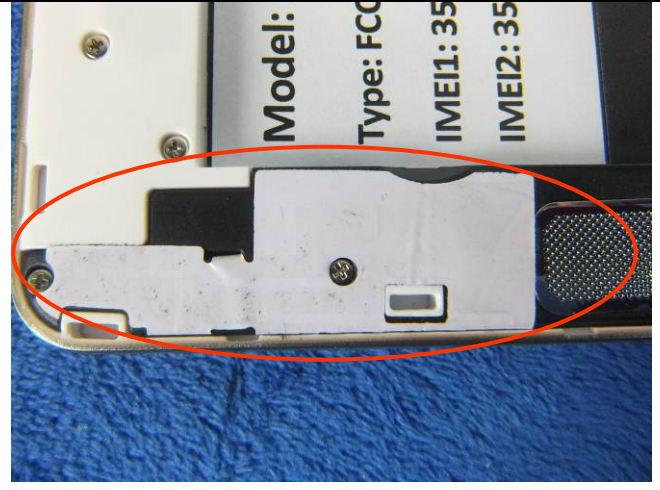

GSM/PCS/UMTS-FDD/LTE Antenna View

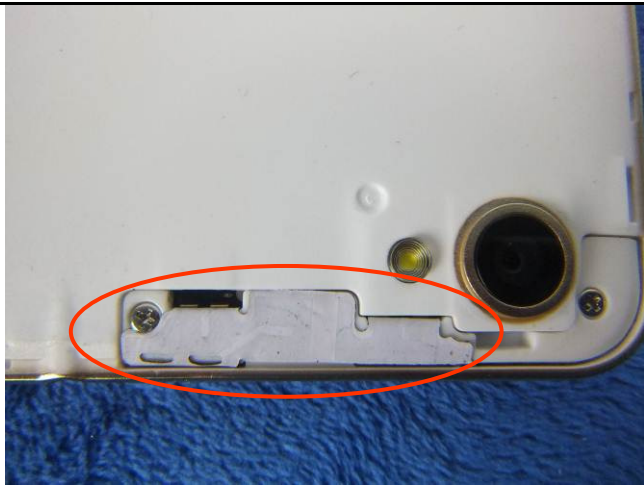

WIFI/BT/BLE - Antenna View

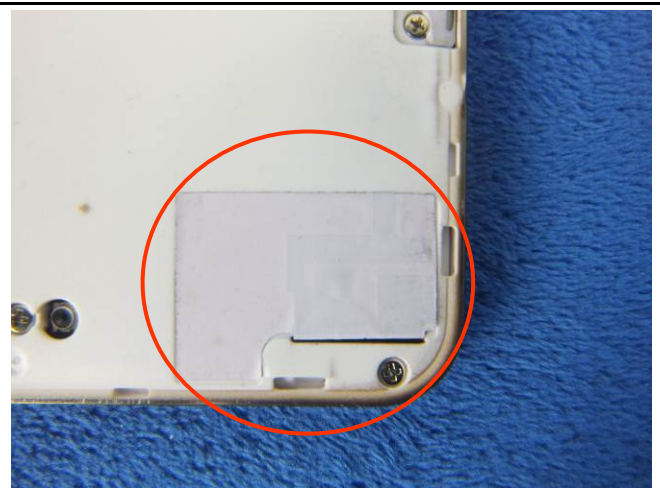

GPS - Antenna View

Annex B.iii. Photograph: Test Setup Photo

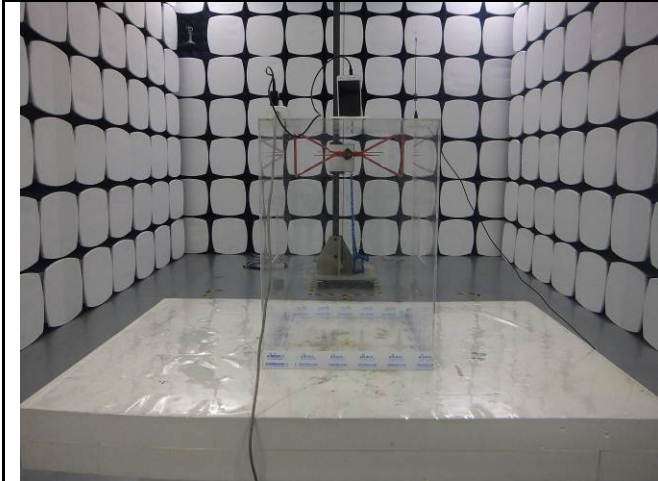

Radiated Spurious Emissions Test Setup Below 1GHz

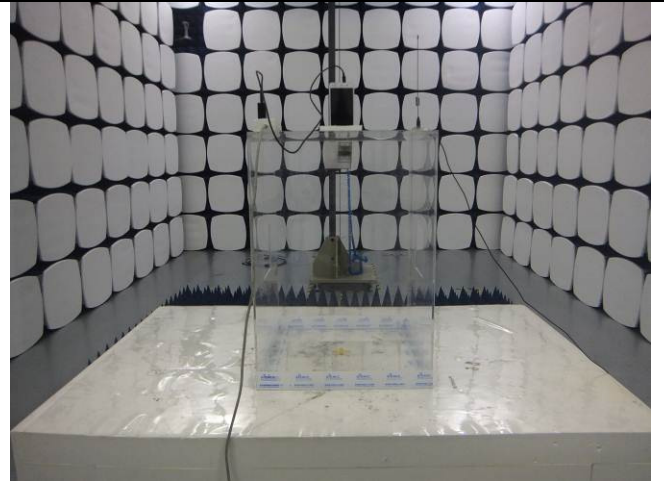

Radiated Spurious Emissions Test Setup Above
1GHz

Annex C. TEST SETUP AND SUPPORTING EQUIPMENT

Annex C.ii. TEST SET UP BLOCK

Block Configuration Diagram for Radiated Emissions

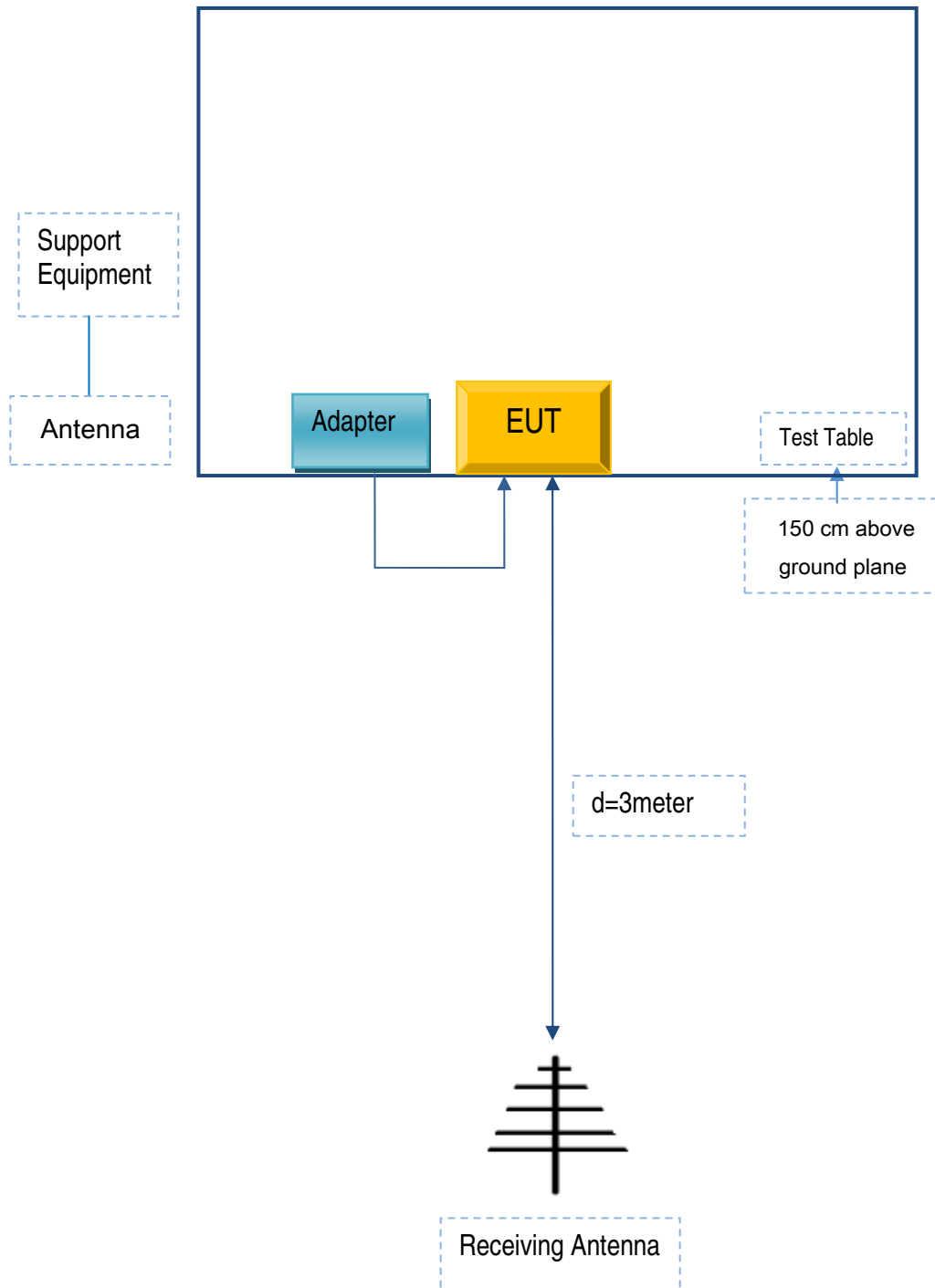

Annex C. ii. SUPPORTING EQUIPMENT DESCRIPTION

The following is a description of supporting equipment and details of cables used with the EUT.

Supporting Equipment:

Manufacturer	Equipment Description	Model	Serial No
Telecell Mobile (H.K) Co. Ltd.	Adapter	SC/8WA050150US	SR0037241

Supporting Cable:

Cable type	Shield Type	Ferrite Core	Length	Serial No
USB Cable	Un-shielding	No	0.8m	SR0037241

Test Report	15071166-FCC-R5
Page	146 of 148

Annex C.ii. EUT OPERATING CONKITIONS

N/A

Test Report	15071166-FCC-R5
Page	147 of 148

Annex D. User Manual / Block Diagram / Schematics / Partlist

Please see attachment

Test Report	15071166-FCC-R5
Page	148 of 148

Annex E. DECLARATION OF SIMILARITY

N/A