



## Test Report

Prepared for: Sugarland Holdings Group, LLC

Model: CMB-5B215

Description: Consumer Mobile 50db Booster

FCC ID: 2ADWV-CMB-5B215

To

FCC Part 20

Date of Issue: May 6, 2015

On the behalf of the applicant: Sugarland Holdings Group, LLC  
8275 S. Eastern Avenue  
Suite 563  
Las Vegas, NV 89123

Attention of: Robert Skilton, Compliance Coordinator  
Ph: (775) 299-3305  
E-Mail: [rs@airgoon.com](mailto:rs@airgoon.com)

Prepared By  
Compliance Testing, LLC  
1724 S. Nevada Way  
Mesa, AZ 85204  
(480) 926-3100 phone / (480) 926-3598 fax  
[www.compliancetesting.com](http://www.compliancetesting.com)  
Project No: p1520007

**Mike Graffeo**  
Project Test Engineer

This report may not be reproduced, except in full, without written permission from Compliance Testing.  
All results contained herein relate only to the sample tested.

### Test Report Revision History

Revision	Date	Revised By	Reason for Revision
1.0	February 20, 2015	Mike Graffeo	Original Document
2.0	April 27, 2015	Greg Corbin	Updated plots on pages 26, 42, updated tables on pages 55, 85, 86.
3.0	May 6, 2015	Amanda Reed	Updated FCC ID

## Table of Contents

<b><u>Description</u></b>	<b><u>Page</u></b>
Standard Test Conditions and Engineering Practices	5
Test Result Summary	6
Authorized Frequency Band	7
Maximum Power and Gain	13
Intermodulation	16
Out-of-Band Emissions	22
Conducted Spurious Emissions	53
Noise Limits	76
Uplink Inactivity	83
Variable Gain	84
Occupied Bandwidth	90
Oscillation Detection	121
Radiated Spurious	138
Test Equipment Utilized	141

## ILAC / A2LA

Compliance Testing, LLC, has been accredited in accordance with the recognized International Standard ISO/IEC 17025:2005. This accreditation demonstrates technical competence for a defined scope and the operation of a laboratory quality management system (refer to the joint ISO-ILAC-IAF Communiqué dated January 2009).

The tests results contained within this test report all fall within our scope of accreditation, unless noted below.

Please refer to <http://www.compliancetesting.com/labscope.html> for current scope of accreditation.

Testing Certificate Number: **2152.01**



FCC Site Reg. #349717

IC Site Reg. #2044A-2

**Non-accredited tests contained in this report:**

**N/A**

## Test and Measurement Data

Sub-part  
 2.1033(c)(14):

All tests and measurement data shown were performed in accordance with FCC Rules and Regulations, Part 2, Subpart J and the following individual Parts: 20.21 in conjunction with latest version of KDB 935210.

## Standard Test Conditions and Engineering Practices

Except as noted herein, the following conditions and procedures were observed during the testing:

In accordance with ANSI/C63.4-2009, and unless otherwise indicated in the specific measurement results, the ambient temperature of the actual EUT was maintained within the range of 10° to 40°C (50° to 104°F), unless the particular equipment requirements specified testing over a different temperature range. Also, unless otherwise indicated, the humidity levels were in the range of 10% to 90% relative humidity.

Environmental Conditions		
Temp (°C)	Humidity (%)	Pressure (mbar)
24.9 – 31.0	33.5 – 63.0	985.5 - 943.0

Measurement results, unless otherwise noted, are worst-case measurements.

## EUT Description

**Model:** CMB-5B215

**Description:** Consumer Mobile 50dB Booster

**Firmware:** N/A

**Accessories:** Power adaptor supplied from customer

**Serial Number:** N/A

### Additional Information:

The EUT is a Mobile, bi-directional amplifier for the boosting of cellular phone signals and data communication devices. The following frequency bands and emission types are utilized. Special test modes were utilized at times

Frequency Band (MHz)					
<b>Uplink</b>	698 - 716	776 - 787	824 - 849	1850 – 1910	1710 – 1755
<b>Downlink</b>	728 - 746	746 - 757	869 - 894	1930 - 1990	2110 - 2155
<b>Modulation Type</b>	LTE		GSM, CDMA, EDGE, HSPA, EVDO, LTE		CDMA, HSPA, LTE, EDGE, EVDO

Emission Designators					
<b>CDMA</b>	<b>HSPA</b>	<b>LTE</b>	<b>EVDO</b>	<b>EDGE</b>	<b>GSM</b>
F9W	F9W	G7D	F9W	G7W	GXW

The modulation types and emission designators listed in the tables represent the modulations that the cell phone providers use for each frequency band. GSM, CDMA, and WCDMA represent all the modulation types (phase and amplitude or a combination thereof) utilized within the industry. EDGE, HSPA, LTE etc. are all protocols or multiplexing techniques using the base modulations.

## EUT Operation during Tests

The EUT was in a normal operating condition.

## Test Result Summary

Specification	Test Name	Pass, Fail, N/A	Comments
20.21(e)(3)	Authorized Frequency Band	Pass	
20.21(e)(8)(i)(B) 20.21(e)(8)(i)(C) 20.21(e)(8)(i)(D)	Maximum Power and Gain	Pass	
20.21(e)(8)(i)(F)	Intermodulation	Pass	
20.21(e)(8)(i)(E)	Out-of-Band Emissions	Pass	
2.1051 22.917(a) 24.238(a)	Conducted Spurious Emissions	Pass	
20.21(e)(8)(i)(A) 20.21(e)(8)(I)	Noise Limits	N/A	Per the test data on page 32, the noise is below -70dBm/MHz ("Transmit Power OFF Mode") therefore is by default compliant to the Variable Uplink Noise Power Tests, Variable Downlink Noise Power Tests, and Noise timing tests. These tests are not applicable.
20.21(e)(8)(i)(I)	Uplink Inactivity	N/A	per rule 20.21e... if noise is less than -70dBm/MHz ("Transmit Power OFF Mode") then EUT will not shut off, therefore this test will not be performed
20.21(e)(8)(i)(C)(1) 20.21(e)(8)(i)(C)(H) 20.21(e)(8)(i)(C)(2)(iii)(mobile)	Variable Gain	Pass	
2.1049	Occupied Bandwidth	Pass	
20.21(e)(8)(ii)(A)	Oscillation Detection	Pass	
2.1053	Radiated Spurious	Pass	
20.21(e)(8)(i)(B)	Spectrum Block Filtering	N/A	This only applies to devices utilizing spectrum block filtering

**Authorized Frequency Band**

**Engineer:** Mike Graffeo

**Test Date:** 2/16/15

**Test Procedure**

The EUT was connected to a spectrum analyzer through an attenuator with the losses being input into the spectrum analyzer as a combination of reference level offset and correction factor as needed to ensure accurate readings. A signal generator was utilized to produce a CW input signal tuned to the center channel of the operational band. The RF input level was increased to a point just prior to the AGC being in control of the power. The Signal generator was set to sweep across 2X the operational band of the EUT while the spectrum analyzer was set to MAX HOLD. Two markers were placed at the edges of the operational band and a third marker was placed at the highest point within the band no closer than 2.5 MHz from the band edge.

**Test Setup**

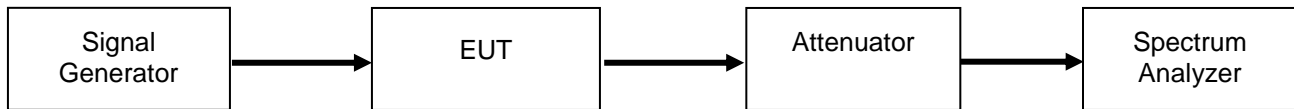

### Uplink Test Results

#### 698 - 716 MHz Band

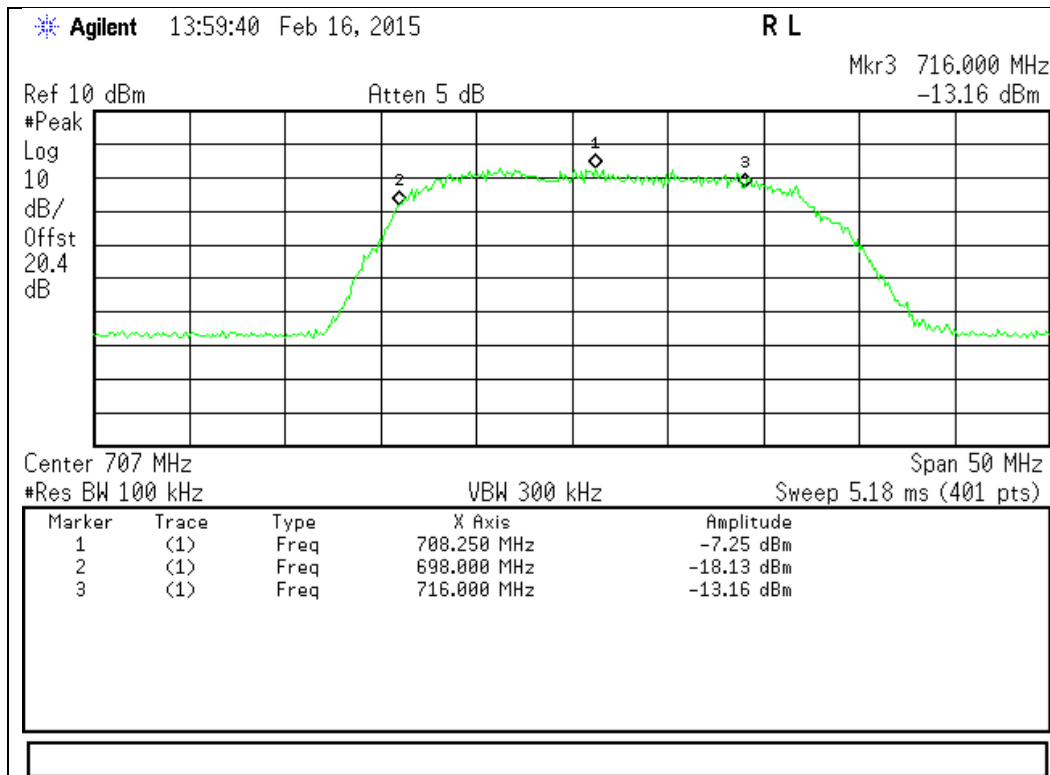

#### 776 - 787 MHz Band

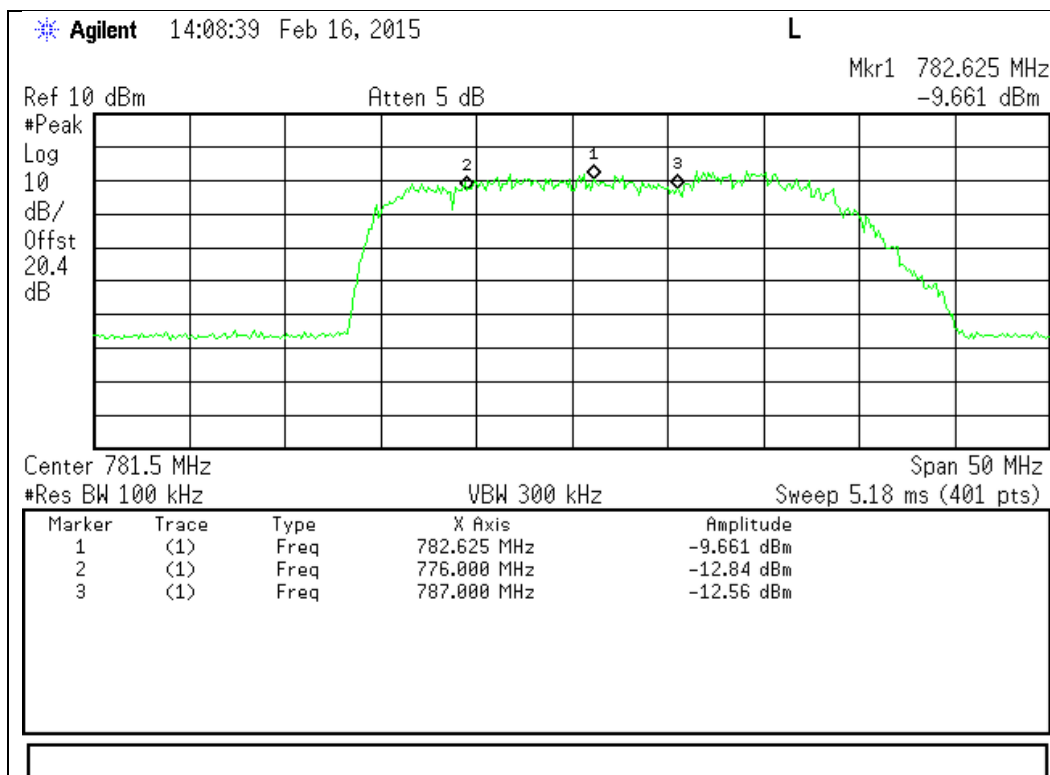



824 - 849 MHz Band

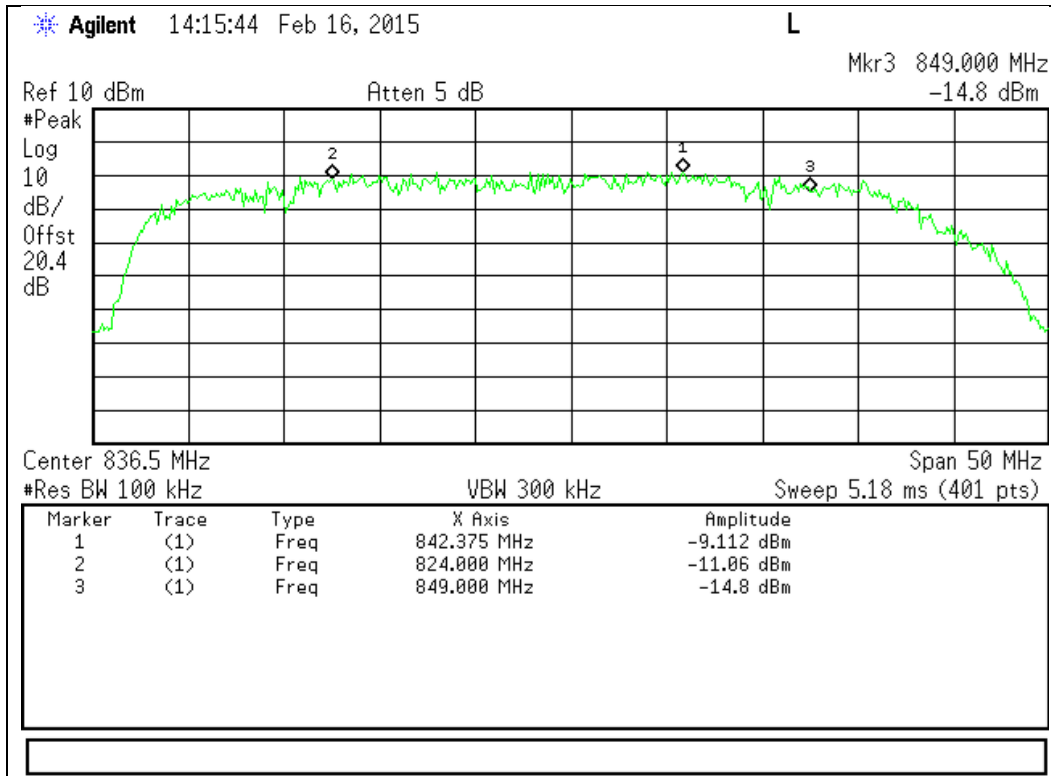

1710 - 1755 MHz Band

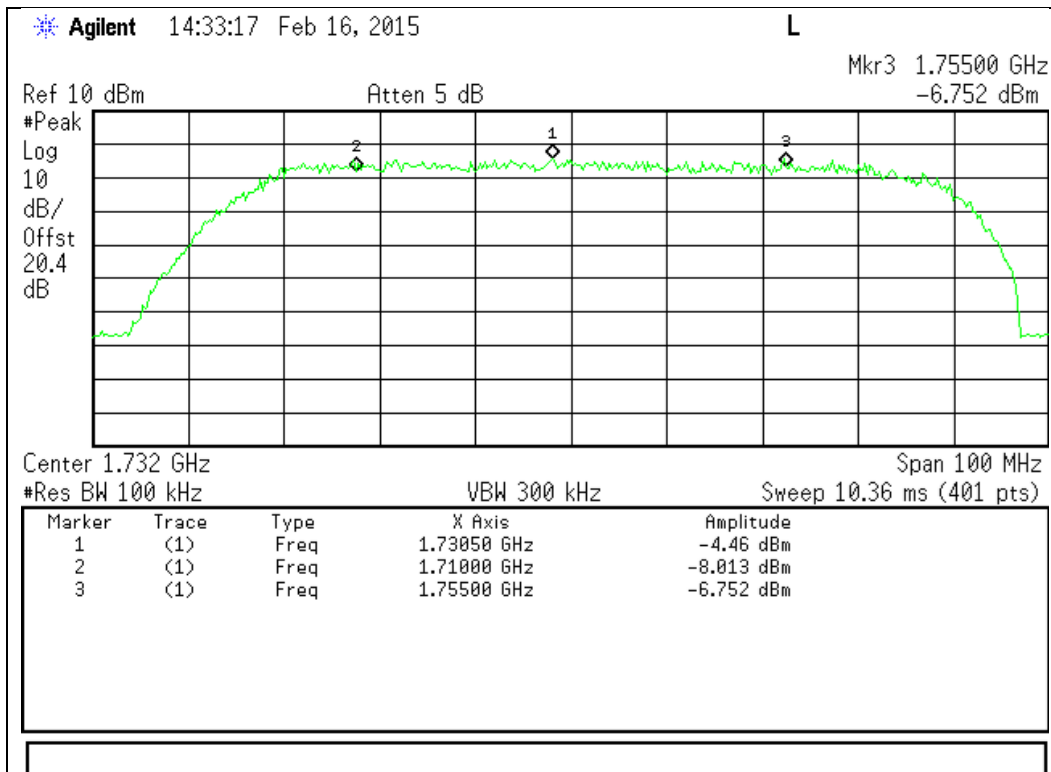

1850 - 1910 MHz Band

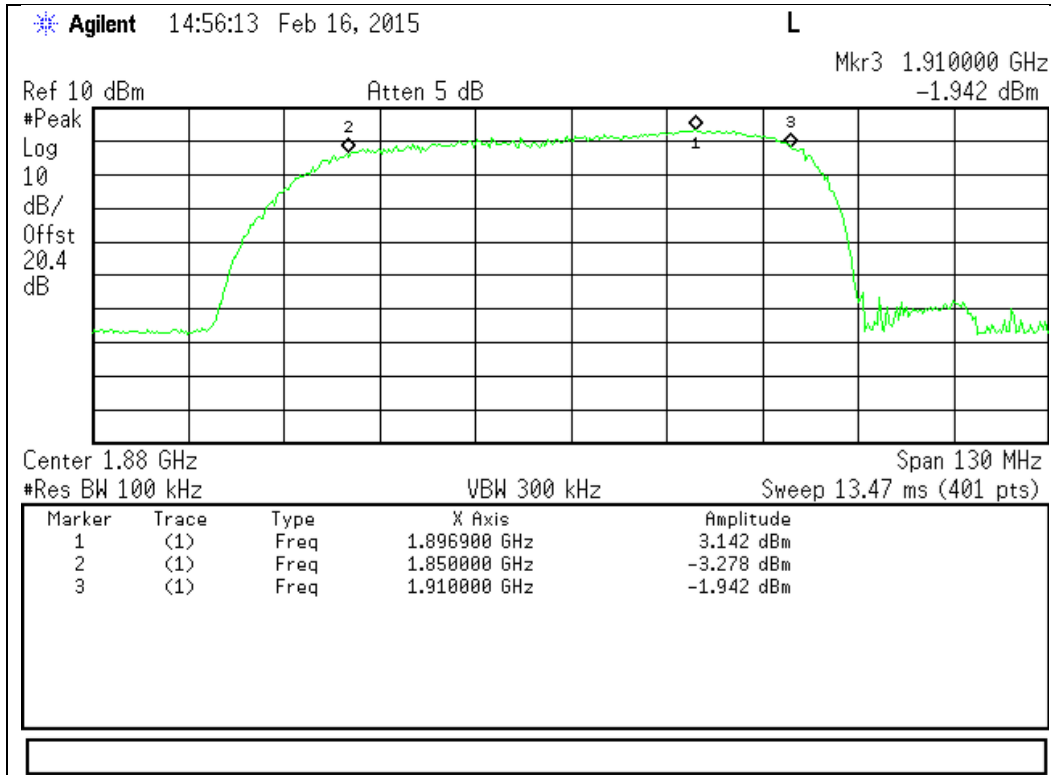

Downlink Test Results

728 - 746 MHz Band

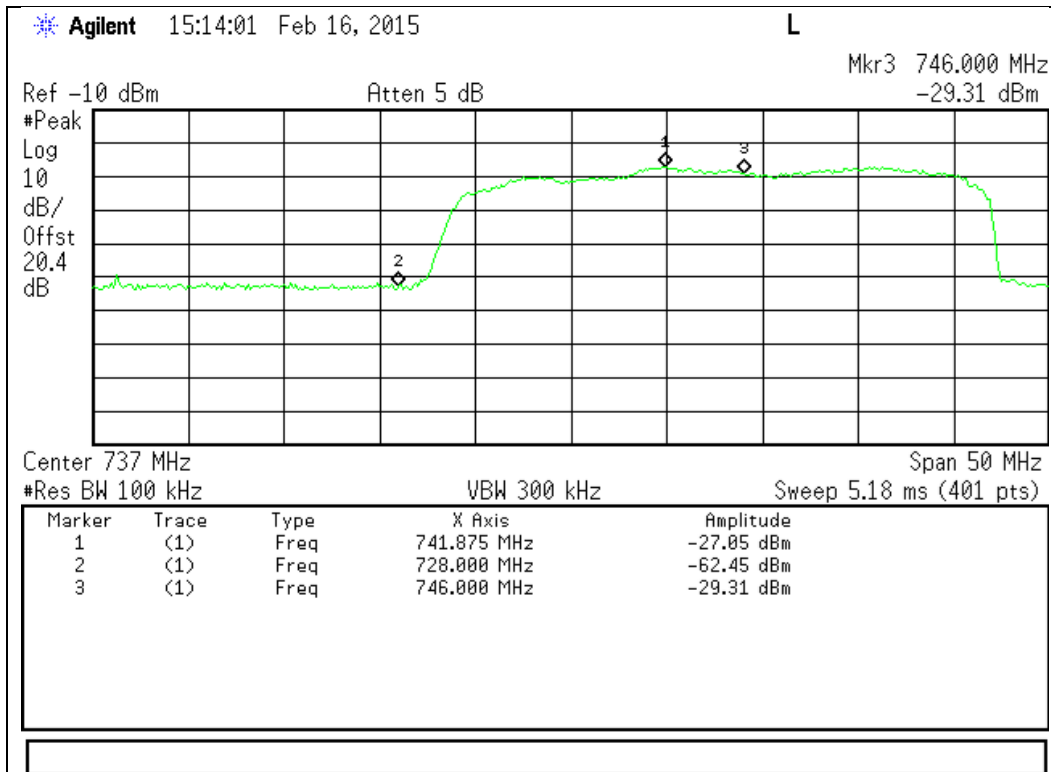

746 - 757 MHz Band

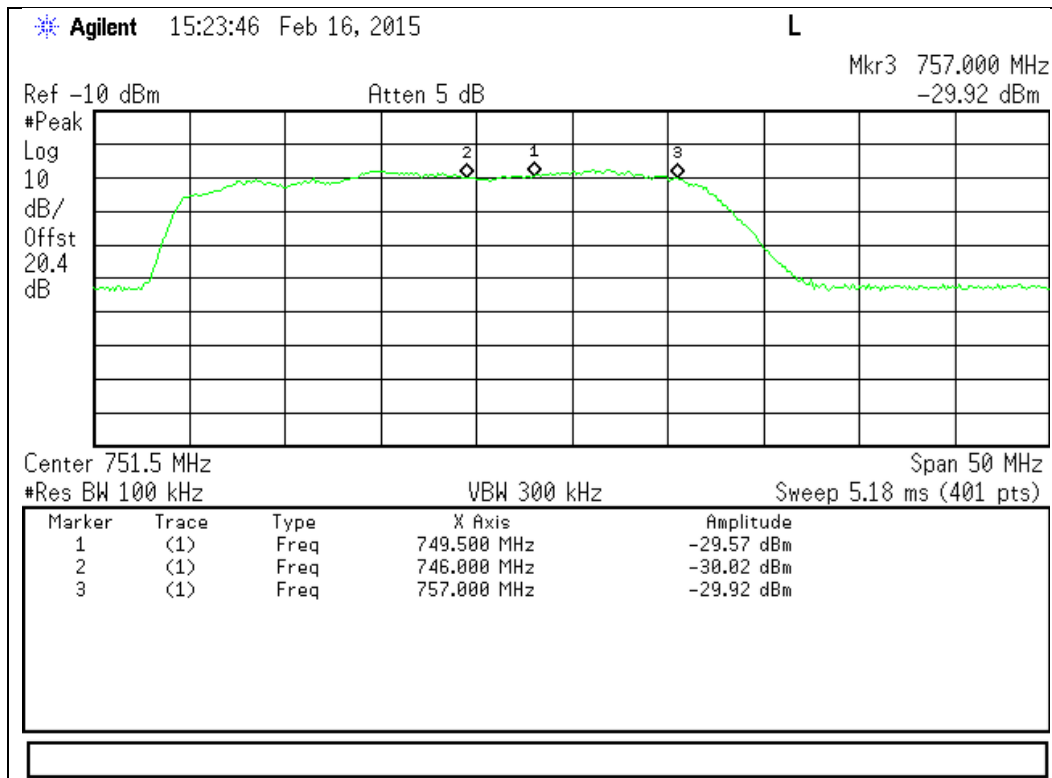

869 - 894 MHz Band

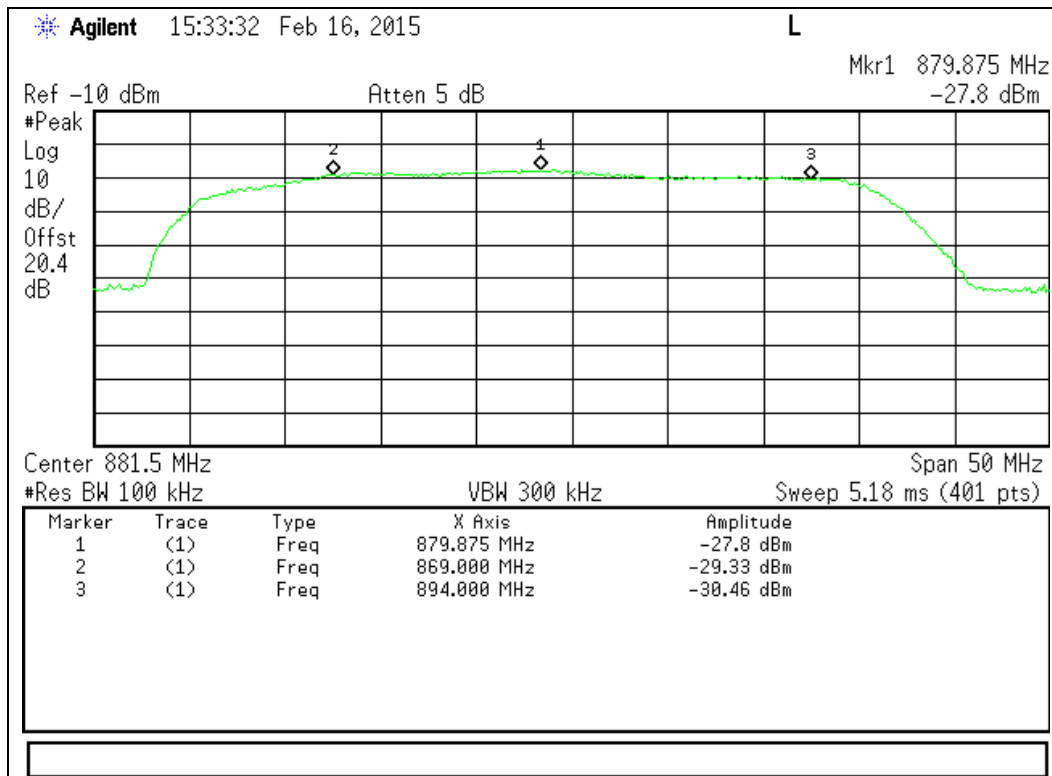

1930 - 1990 MHz Band

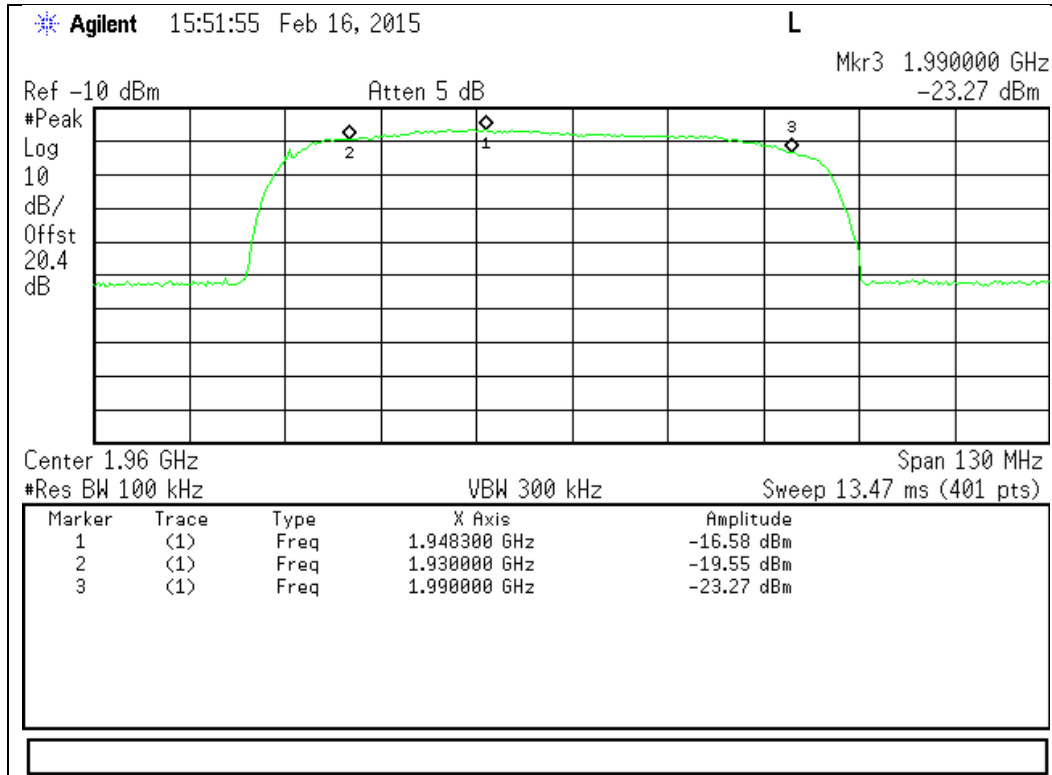

2110 - 2155 MHz Band

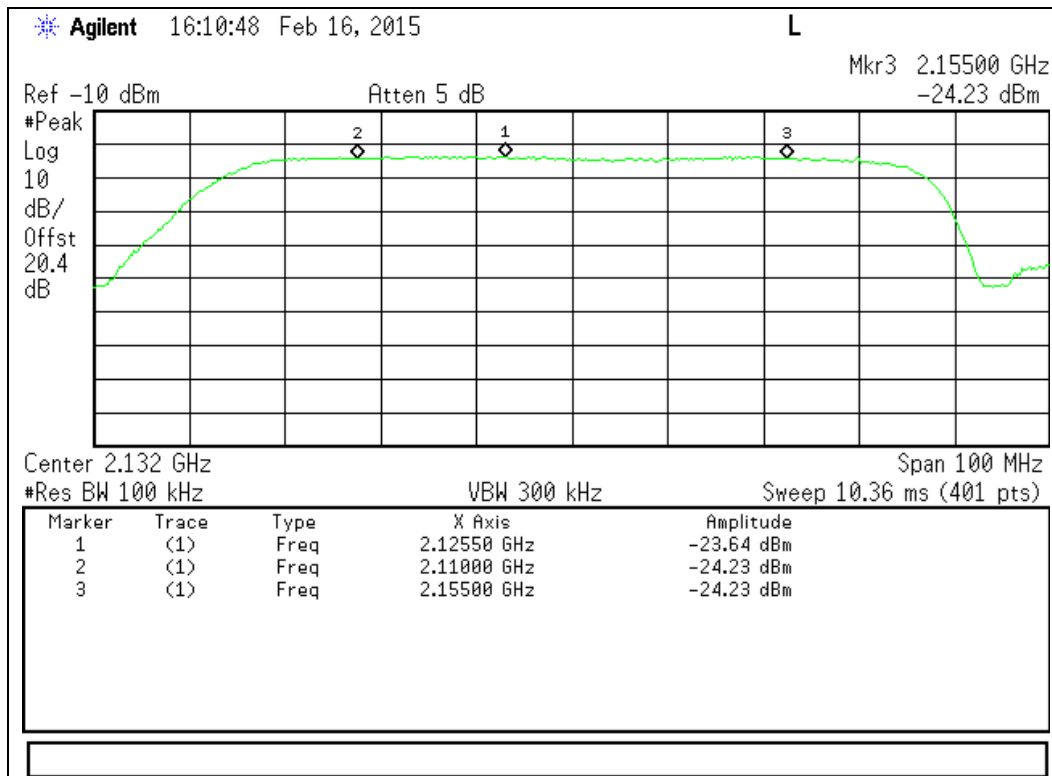

## Maximum Power and Gain

**Engineer:** Mike Graffeo

**Test Date:** 2/16/15

### Test Procedure

The EUT was connected to a spectrum analyzer through an attenuator with the losses being input into the spectrum analyzer as a combination of reference level offset and correction factor as needed to ensure accurate readings. The spectrum analyzer and signal generator were tuned to the frequency with the highest power level in the band, as determined by the Authorized Frequency Band test. The RF input level was increased to a point just prior to the AGC being in control of the power for both pulsed single time slot GSM modulation and 4.1 MHz AWGN modulation. The maximum power was measured and verified to meet the minimum and maximum levels allowed, with the maximum gain being computed from these values. The uplink and downlink gain under each condition were verified to be within 9 dB of each other.

For Mobile installations the gain is fixed at 50 dB.

### Test Setup

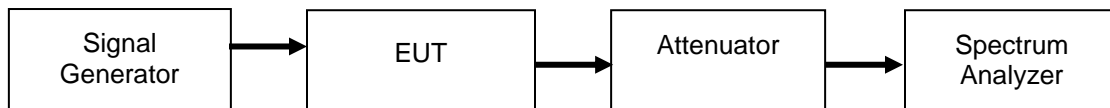

### Uplink Power Test Results

Frequency Band (MHz)	Input Level (dBm)	Output Power (dBm)	Lower Limit (dBm)	Upper Limit (dBm)	Result
698 - 716 MHz Pulsed GSM	-22.6	26.51	17	30	Pass
698 - 716 MHz AWGN	-26.9	21.83	17	30	Pass
776 - 787 MHz Pulsed GSM	-23.7	25.57	17	30	Pass
776 - 787 MHz AWGN	-27.5	21.97	17	30	Pass
824 - 849 MHz Pulsed GSM	-23.9	25.25	17	30	Pass
824 - 849 MHz AWGN	-27.2	21.79	17	30	Pass
1710 - 1755 MHz Pulsed GSM	-23.4	25.64	17	30	Pass
1710 - 1755 MHz AWGN	-28.6	19.50	17	30	Pass
1850 - 1910 MHz Pulsed GSM	-23.5	25.32	17	30	Pass
1850 - 1910 MHz AWGN	-25.3	20.21	17	30	Pass

### Downlink Power Test Results

Frequency Band (MHz)	Input Level (dBm)	Output Power (dBm)	Upper Limit (dBm)	Result
728 - 746 MHz Pulsed GSM	-34.2	14.90	17	Pass
728 - 746 MHz AWGN	-37.2	10.94	17	Pass
746 - 757 MHz Pulsed GSM	-33.1	15.24	17	Pass
746 - 757 MHz AWGN	-36.1	10.73	17	Pass
869 - 894 MHz Pulsed GSM	-32.2	15.44	17	Pass
869 - 894 MHz AWGN	-33.9	11.66	17	Pass
1930 - 1990 MHz Pulsed GSM	-30.2	16.01	17	Pass
1930 - 1990 MHz AWGN	-35.1	11.63	17	Pass
2110 - 2155 MHz Pulsed GSM	-32.9	11.65	17	Pass
2110 - 2155 MHz AWGN	-36.6	10.92	17	Pass

### Uplink and Downlink Gain Test Results

Modulation	Uplink Frequency (MHz)	Downlink Frequency (MHz)	Uplink Gain (dB)	Uplink Limit (dB)	Downlink Gain (dB)	Downlink Limit (dB)	Delta (dB)	Limit (dB)	Margin (dB)
Pulsed GSM	708.25	741.88	49.11	50	49.1	50	0.01	9	-8.99
AWGN	708.25	741.88	48.73	50	48.1	50	0.59	9	-8.41
Pulsed GSM	782.63	749.5	49.27	50	48.3	50	0.93	9	-8.07
AWGN	782.63	749.5	49.47	50	46.8	50	2.64	9	-6.36
Pulsed GSM	842.38	879.88	49.15	50	47.6	50	1.51	9	-7.49
AWGN	842.38	879.88	48.99	50	45.6	50	3.43	9	-5.57
Pulsed GSM	1730.5	2125.5	49.04	50	44.6	50	4.49	9	-4.51
AWGN	1730.5	2125.5	48.10	50	47.5	50	0.58	9	-8.42
Pulsed GSM	1896.9	1948.3	48.82	50	46.2	50	2.61	9	-6.39
AWGN	1896.9	1948.3	45.51	50	46.7	50	1.22	9	-7.78

### EIRP Uplink Power Calculations

Frequency Band (MHz)	Conducted Output Power (dBm)	Highest Antenna Gain (dBi)	EIRP (dBm)	EIRP (Watts)	Limit (Watts)	Result
728 - 746	26.5	2.06	28.56	0.717	1.0	Pass
746 - 757	25.6	1.97	27.57	0.571	1.0	Pass
869 - 894	25.3	0.95	26.25	0.421	1.0	Pass
1930 - 1990	25.6	0.84	26.44	0.440	1.0	Pass
2110 - 2155	25.3	-0.77	24.53	0.284	1.0	Pass

### EIRP Downlink Power Calculations

Frequency Band (MHz)	Conducted Output Power (dBm)	Highest Antenna Gain (dBi)	EIRP (dBm)	EIRP (Watts)	Limit (Watts)	Result
728 - 746	14.9	1.17	16.07	0.040	0.05	Pass
746 - 757	15.2	0.97	16.17	0.042	0.05	Pass
869 - 894	15.4	1.17	16.57	0.045	0.05	Pass
1930 - 1990	16.0	0.94	16.94	0.049	0.05	Pass
2110 - 2155	11.7	2.49	14.19	0.026	0.05	Pass

## Intermodulation

**Engineer:** Mike Graffeo

**Test Date:** 2/17/15

### Test Procedure

The EUT was connected to a spectrum analyzer through an attenuator. Two signal generators were utilized to produce two CW signals 600 kHz apart and centered in the operational band. Attenuator and cable insertion loss correction factors were input to either the signal generator or the spectrum analyzer as required to ensure that accurate measurements were recorded. The input power was set at the maximum allowable power and the RMS intermodulation products were measured to ensure they were less than -19 dBm in a 3 kHz RBW. The uplink and downlink intermodulation products were plotted, with the levels being listed in the summary tables.

### Test Setup

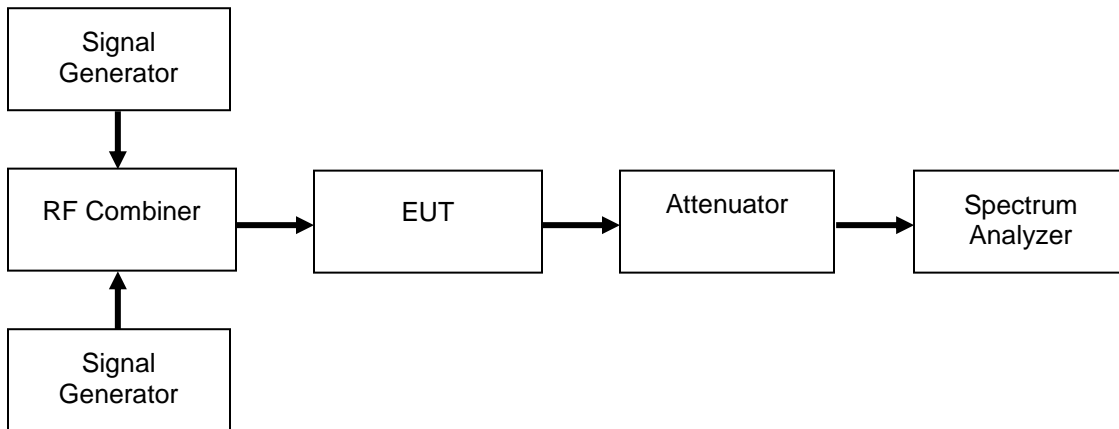

### Uplink Test Results

Frequency Band (MHz)	Intermodulation Level (dBm)	Limit (dBm)	Result
698 - 716 MHz	-34.28	-19	Pass
776 - 787 MHz	-30.97	-19	Pass
824 - 849 MHz	-30.93	-19	Pass
1710 - 1755 MHz	-25.27	-19	Pass
1850 - 1910 MHz	-34.28	-19	Pass

### Downlink Test Results

Frequency Band (MHz)	Intermodulation Level (dBm)	Limit (dBm)	Result
728 - 746 MHz	-27.05	-19	Pass
746 - 757 MHz	-40.42	-19	Pass
869 - 894 MHz	-43.28	-19	Pass
1930 - 1990 MHz	-31.72	-19	Pass
2110 - 2155 MHz	-38.64	-19	Pass



### Uplink Test Results

#### 698 - 716 MHz Band

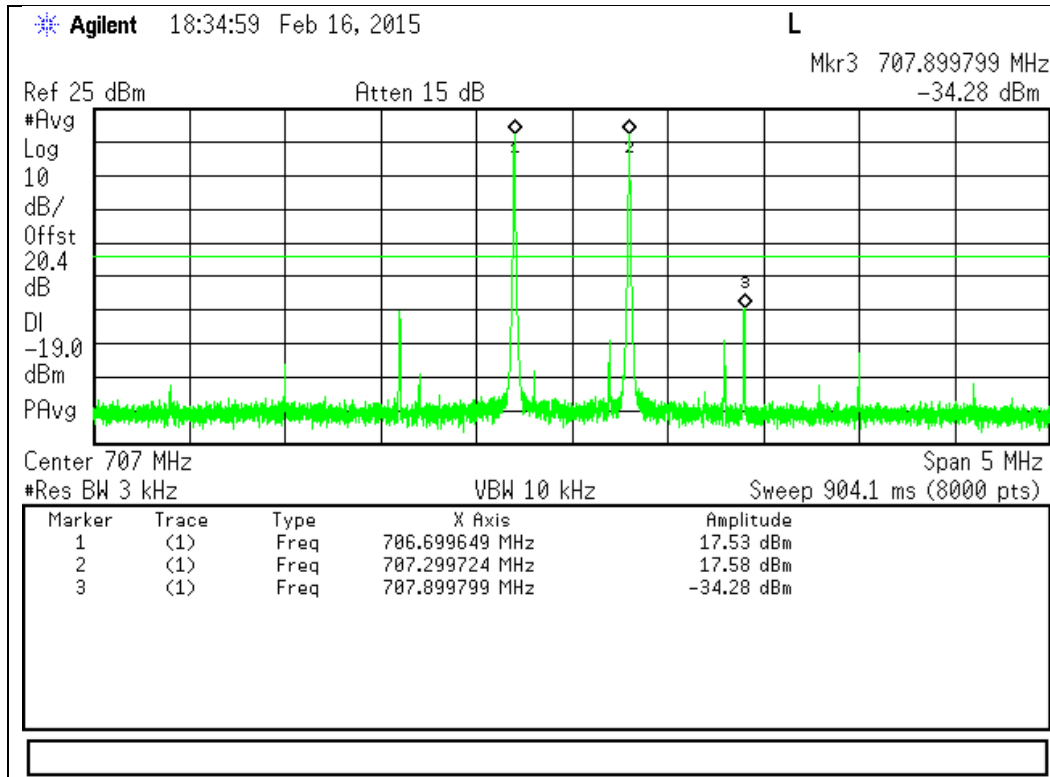

#### 776 - 787 MHz Band

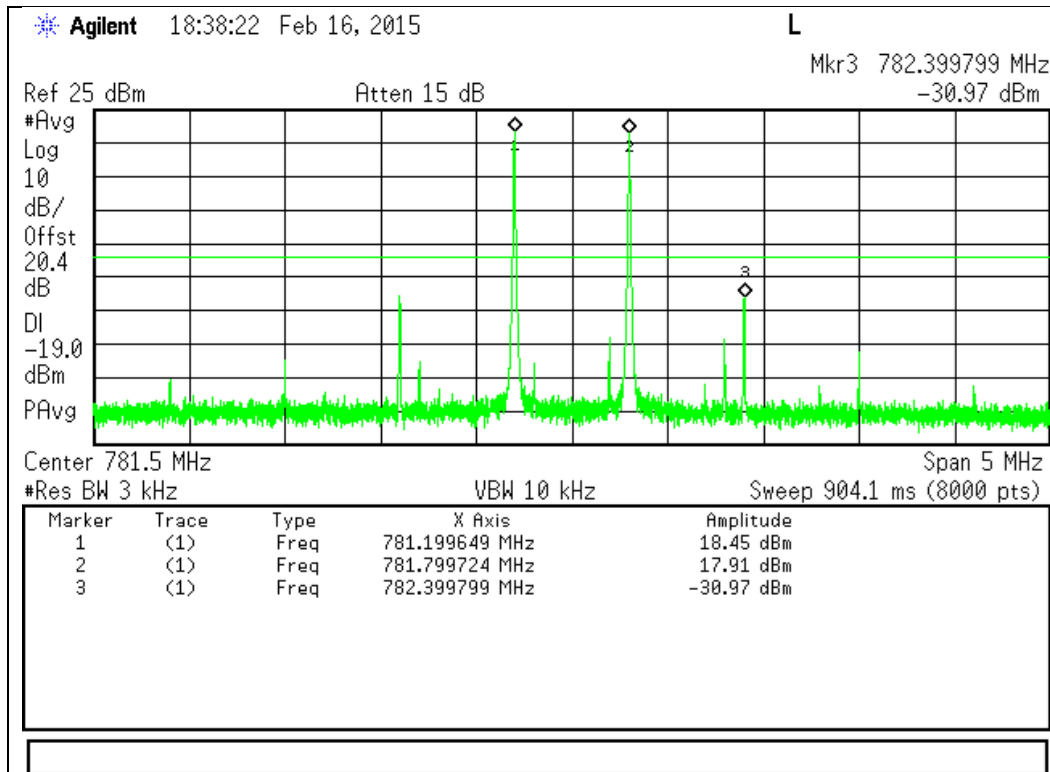

824 - 849 MHz Band

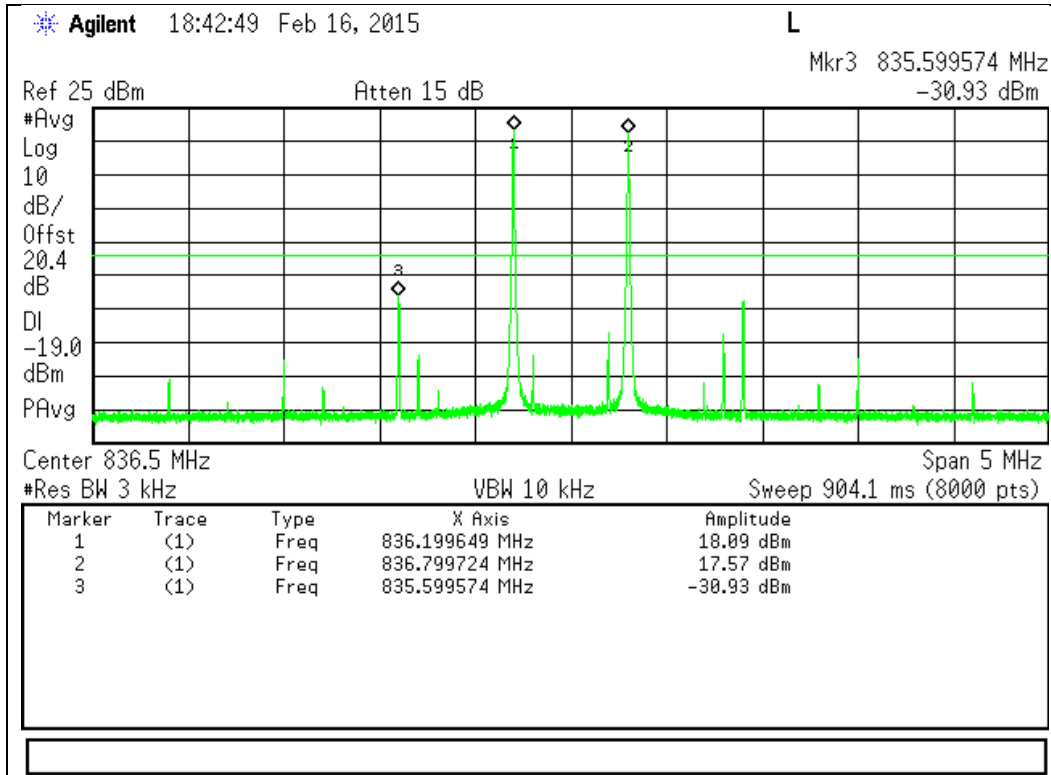

1710 - 1755 MHz Band

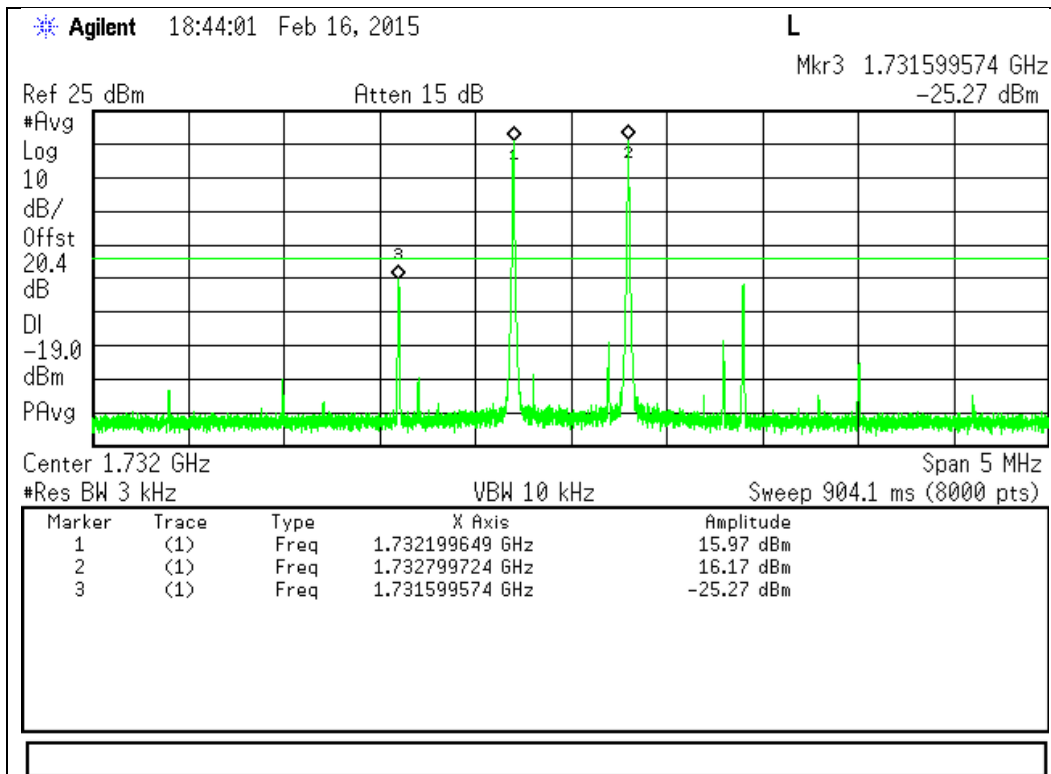

1850 - 1910 MHz Band

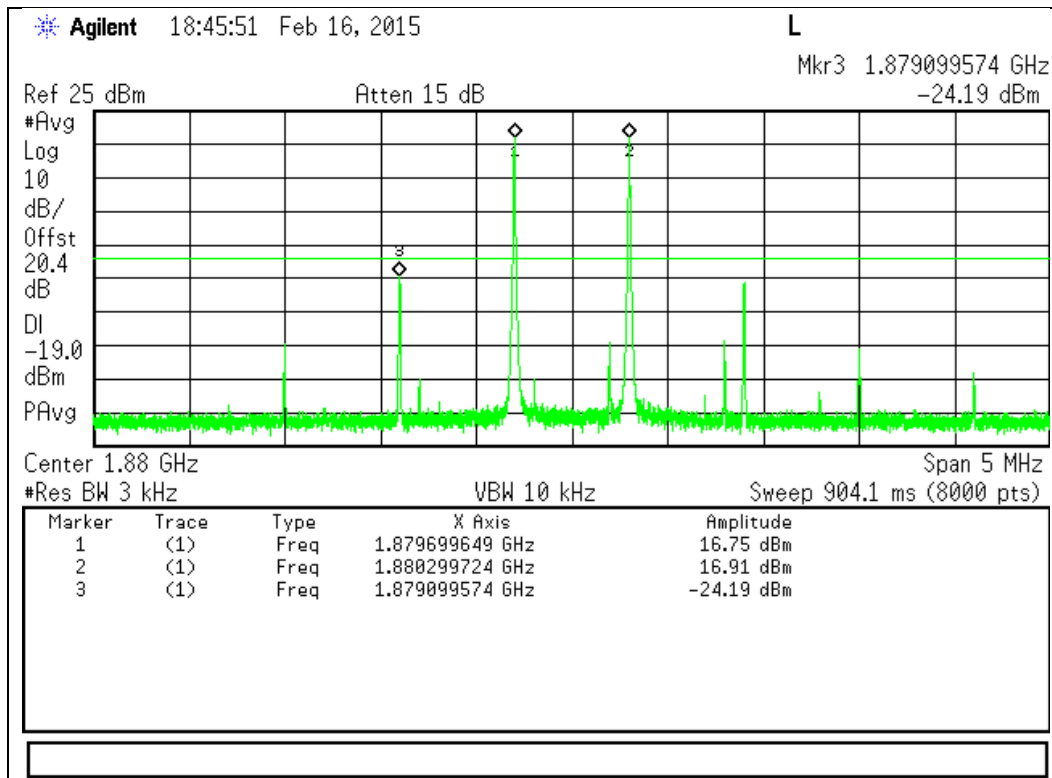

Downlink Test Results

728 - 746 MHz Band

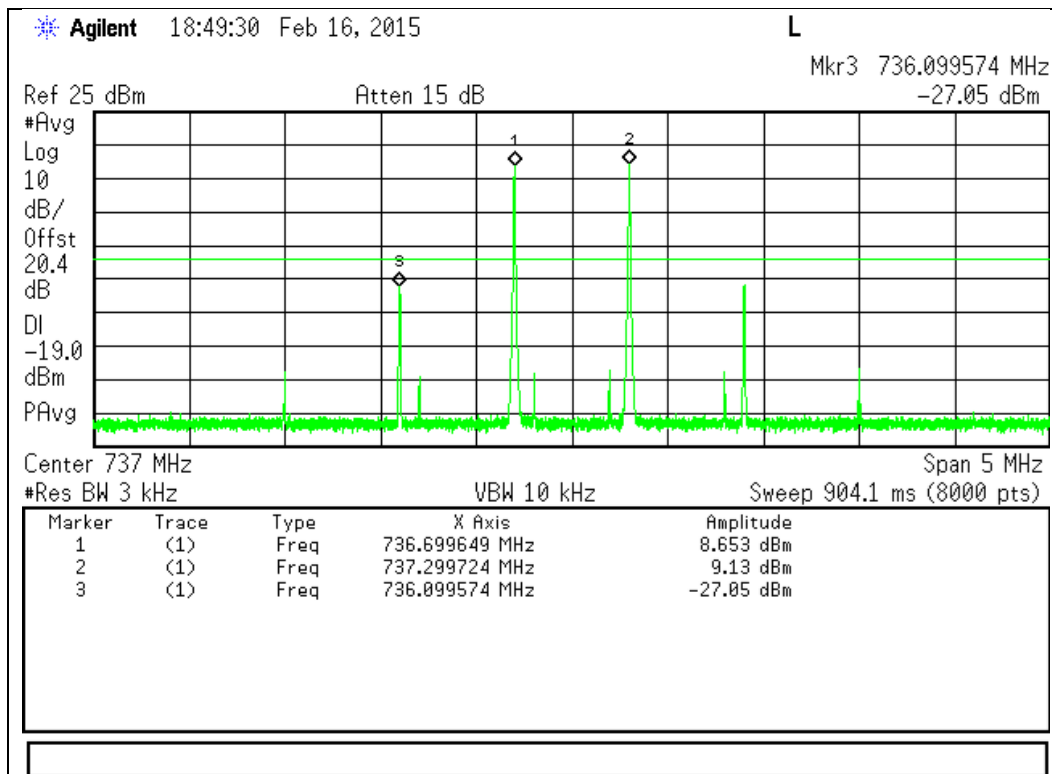

746 - 757 MHz Band

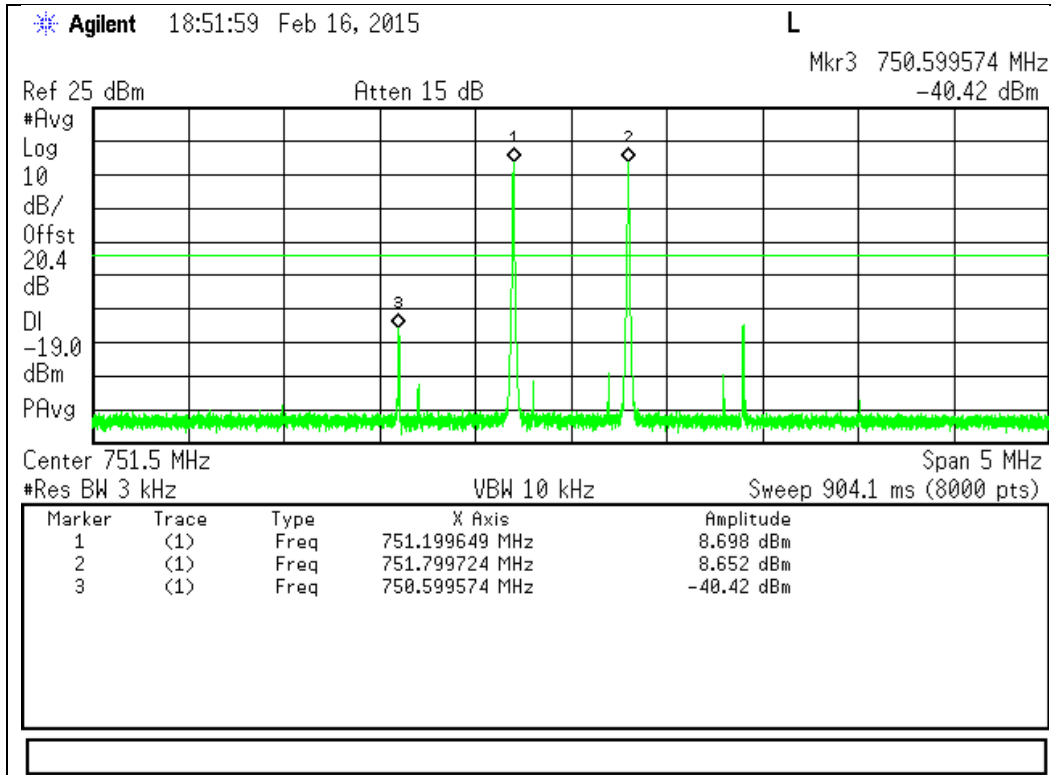

869 - 894 MHz Band

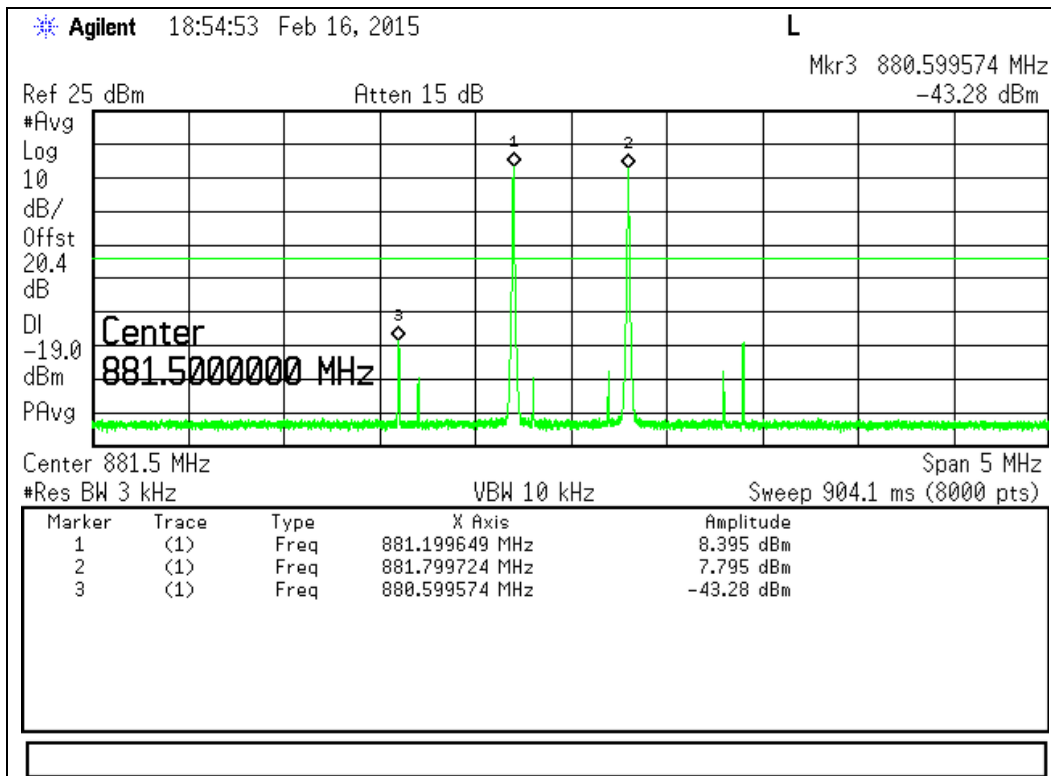

1930 - 1990 MHz Band

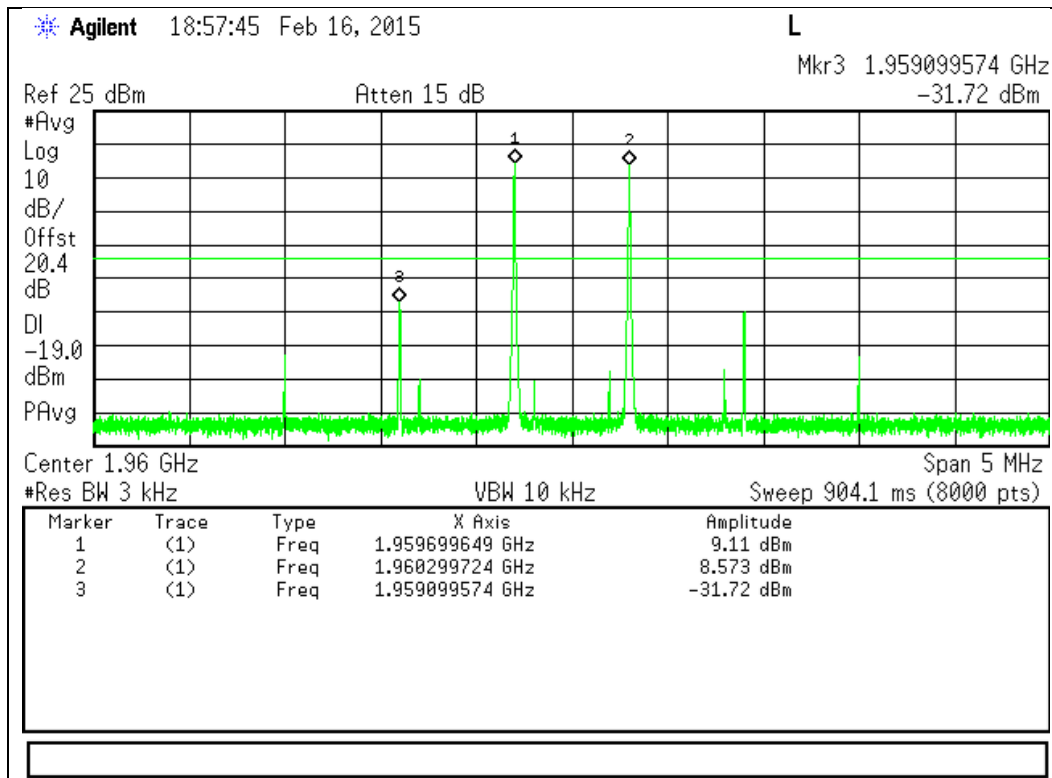

2110 - 2155 MHz Band

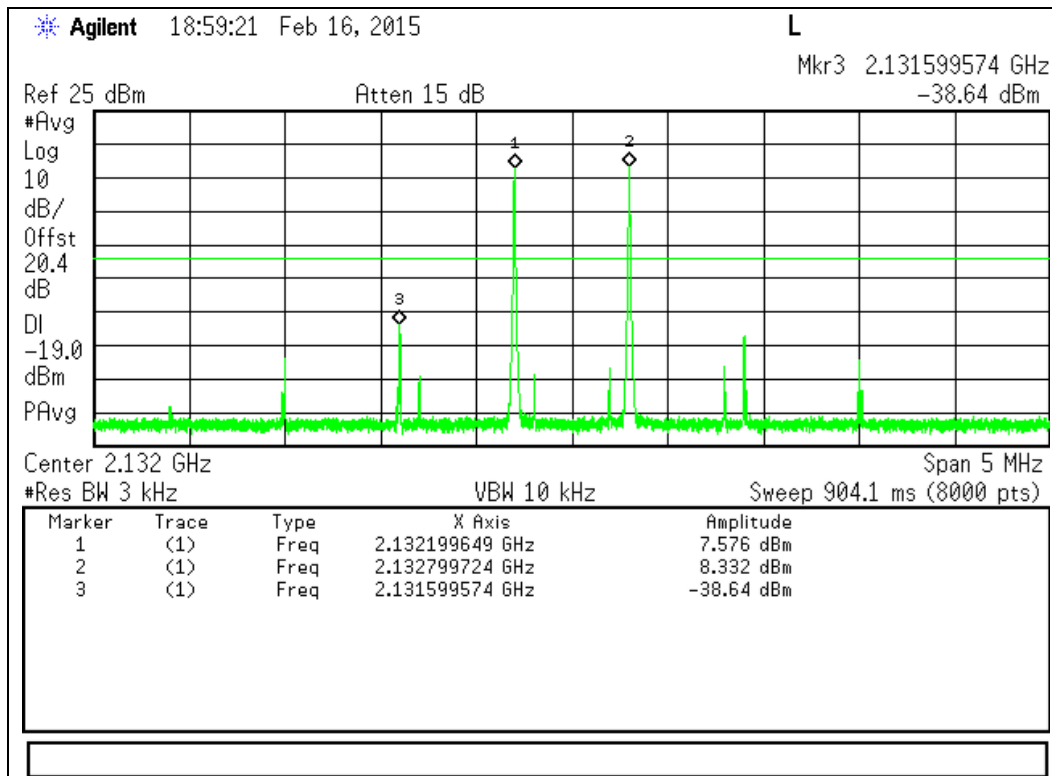

## Out-of-Band Emissions

**Engineer:** Mike Graffeo

**Test Date:** 2/18/15

### Test Procedure

The EUT was connected to a spectrum analyzer through an attenuator with the losses being input into the spectrum analyzer as a combination of reference level offset and correction factor in order to ensure accurate readings. A signal generator was utilized to produce the following signals: GSM, CDMA, and WCDMA. The signal generator was tuned to the lowest allowable upper and lower channel within the EUT operational band for each respective modulation type. The RF input level was increased to a point just prior to the AGC being in control of the power. For each modulation type the Out of Band Emissions were measured to ensure they met the limits.

The following formula was used for calculating the limits:

$$\text{Limit} = P1 - 6 - (43 + 10\text{Log}(P2)) = -19\text{dBm}$$

P1 = power in dBm

P2 = power in Watts

### Test Setup

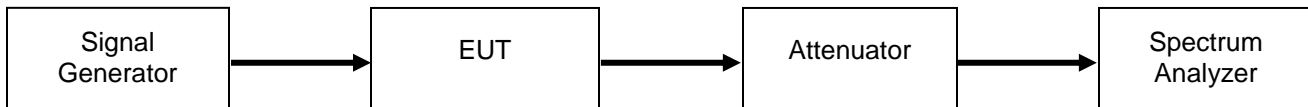

### GSM Uplink Test Plots

#### 698 - 716 MHz Band

#### Lower Band Edge

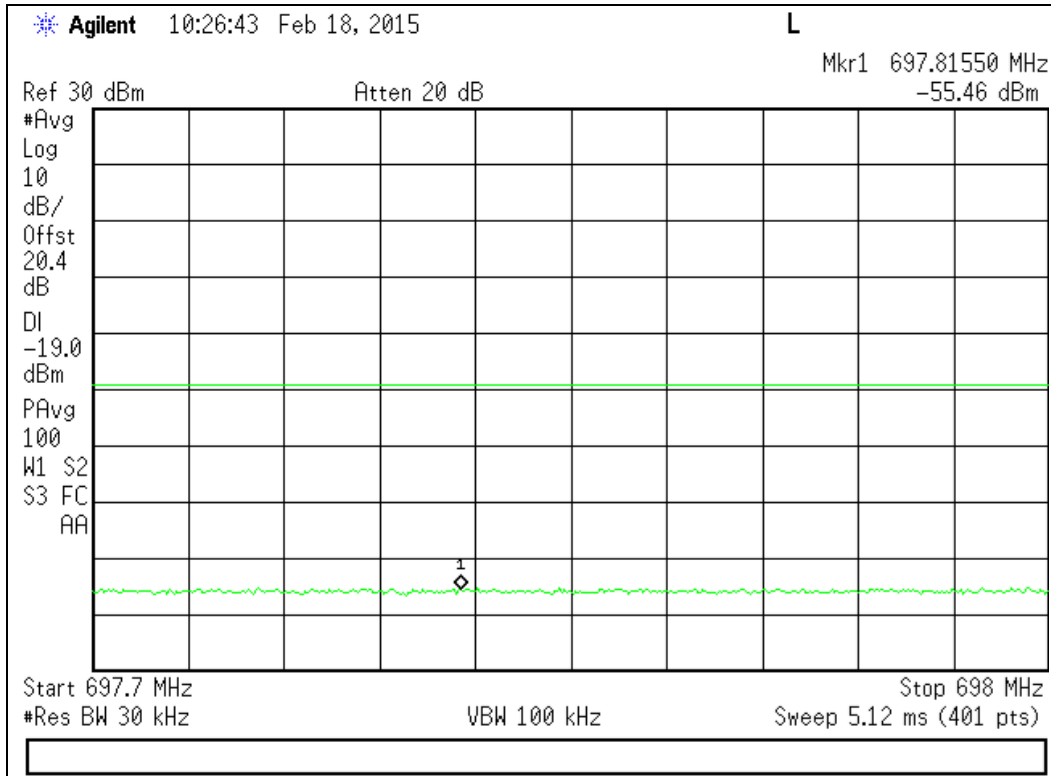

#### Upper Band Edge

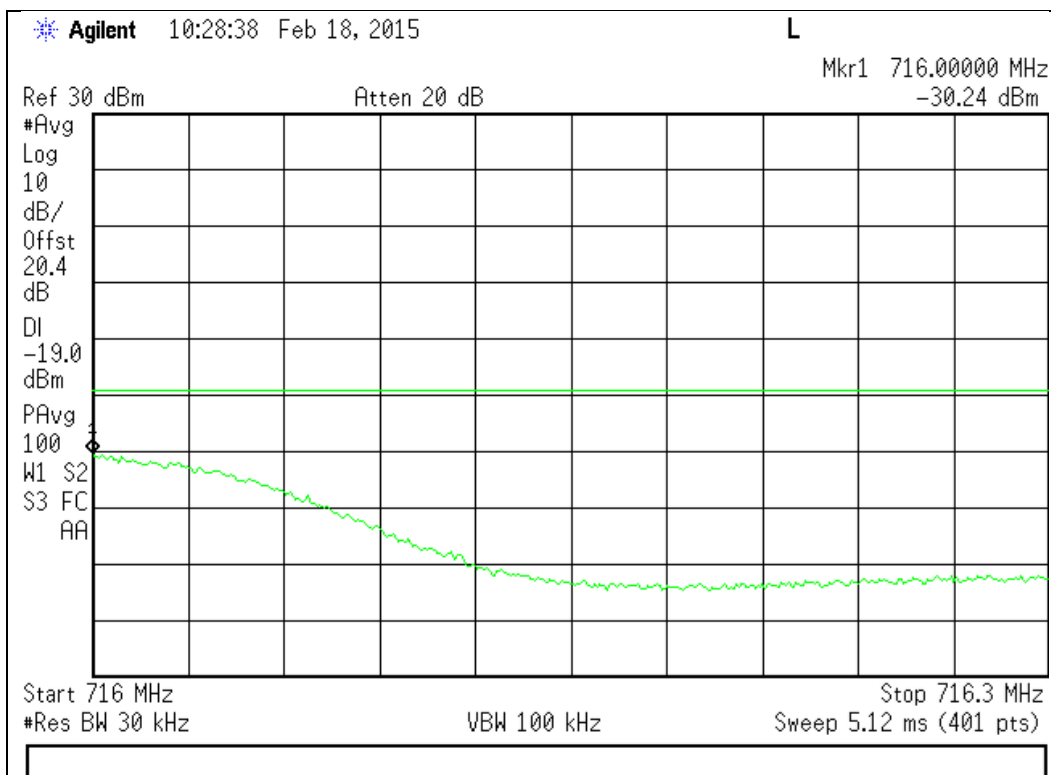

776 - 787 MHz Band

Lower Band Edge

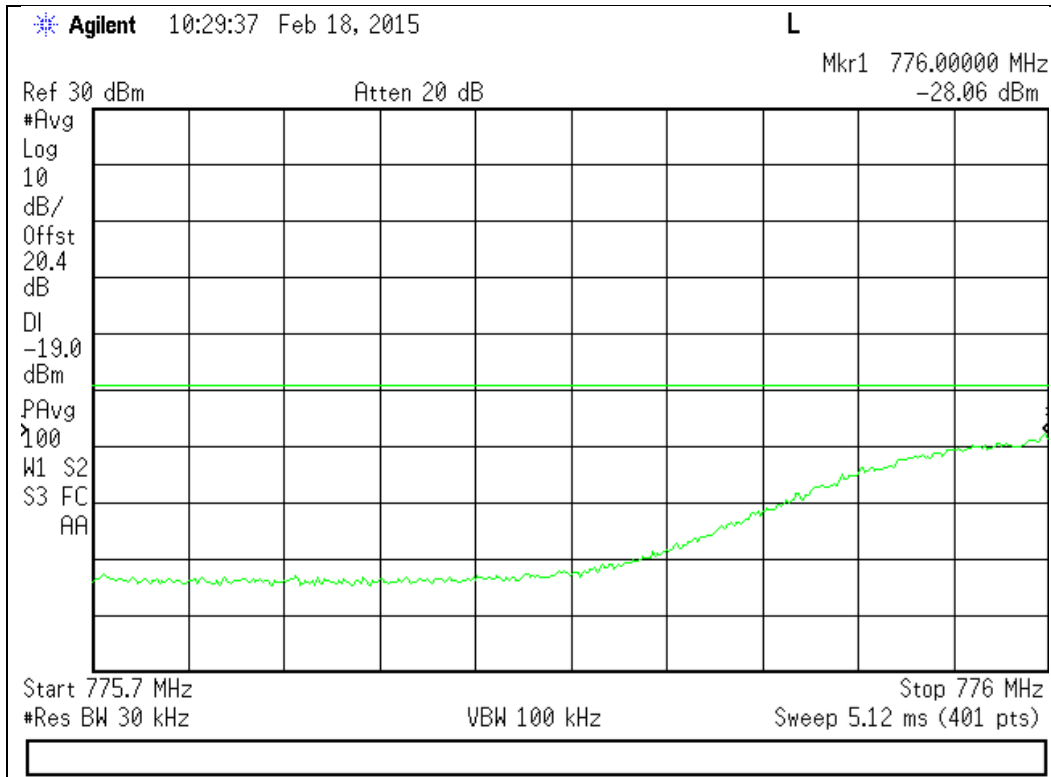

Upper Band Edge

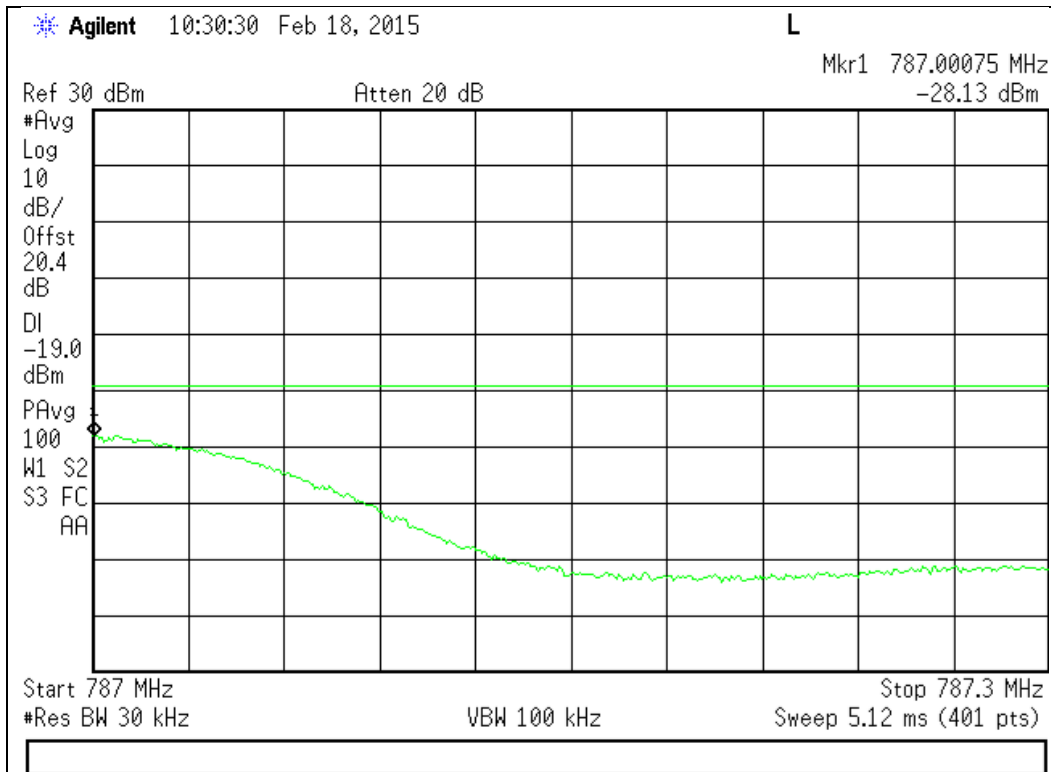



824 - 849 MHz Band

Lower Band Edge

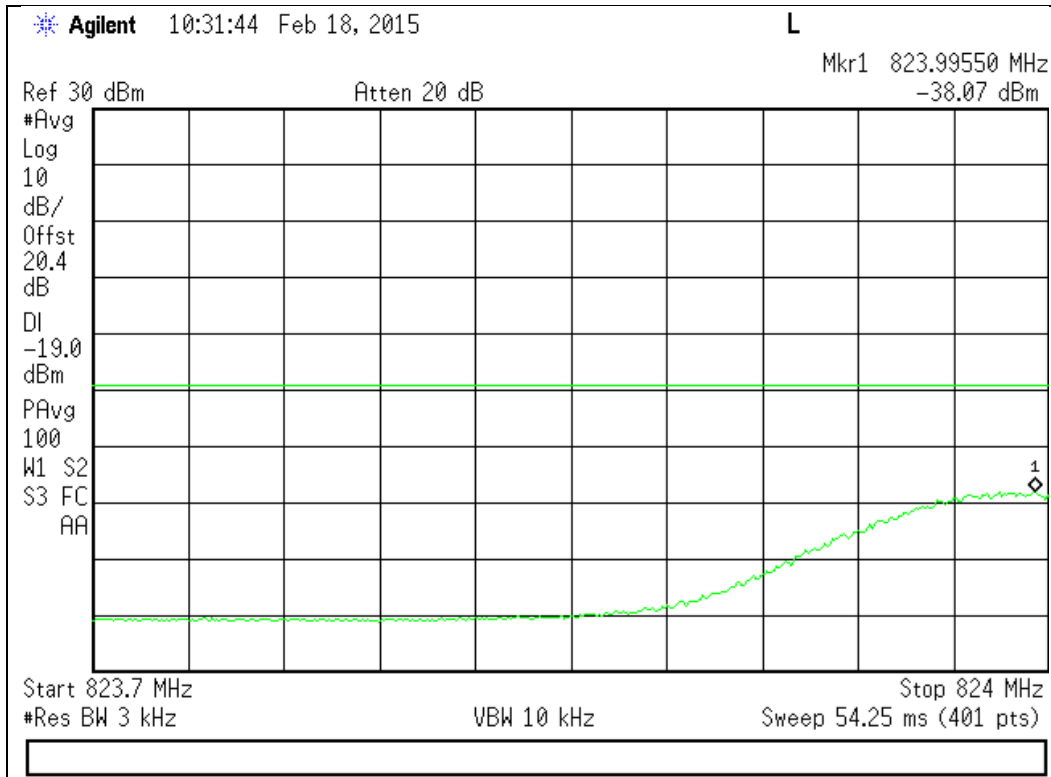

Upper Band Edge

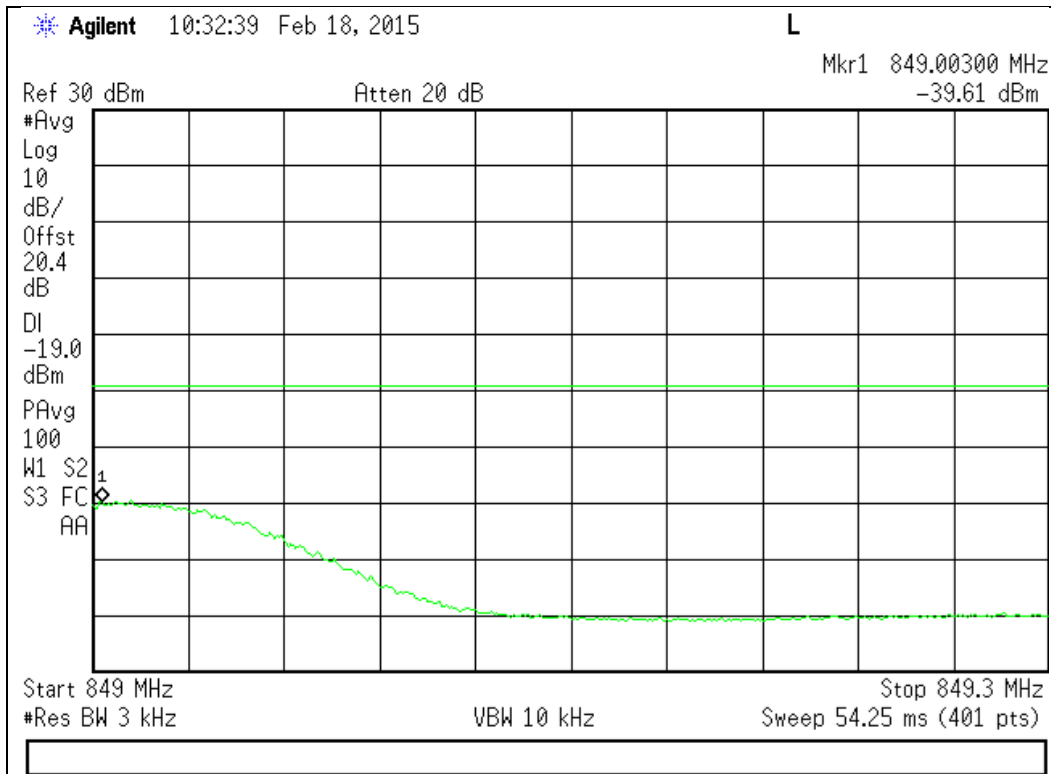

1710 - 1755 MHz Band

Lower Band Edge

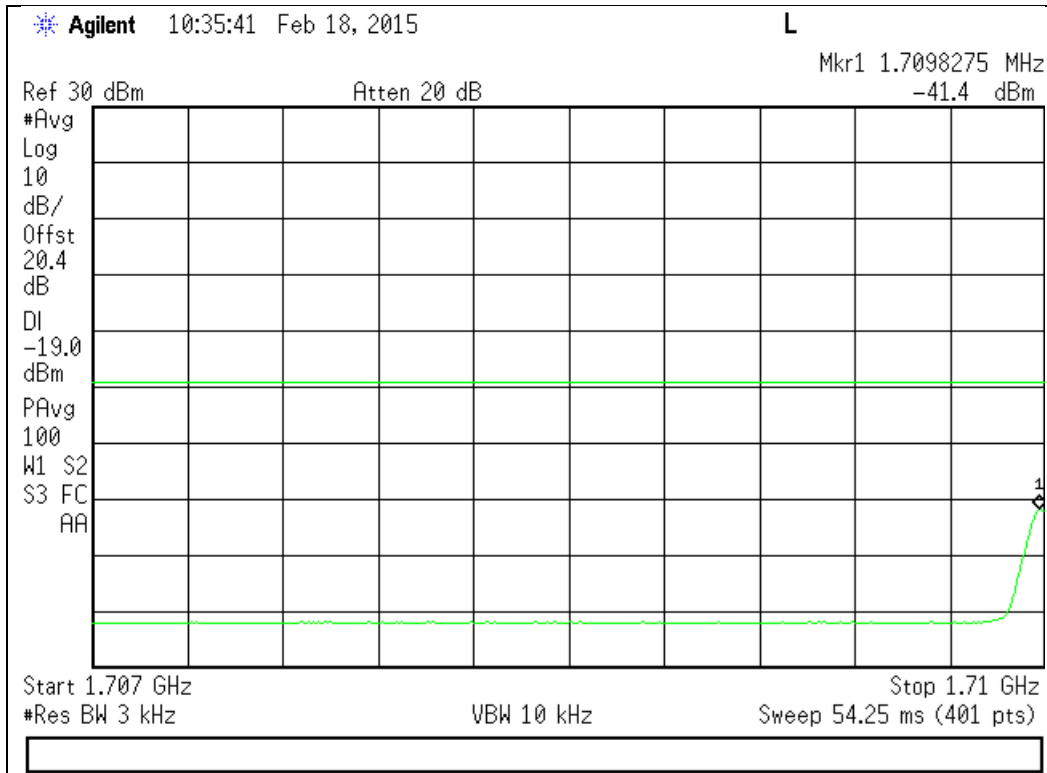

Upper Band Edge

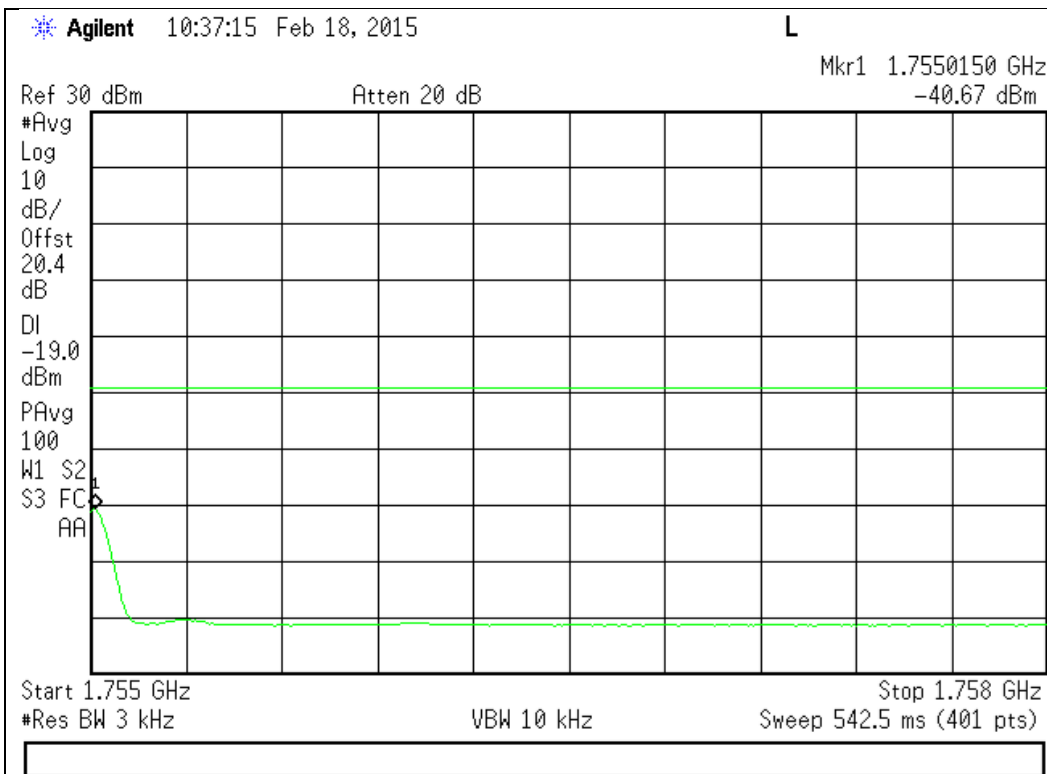

1850 - 1910 MHz Band

Lower Band Edge

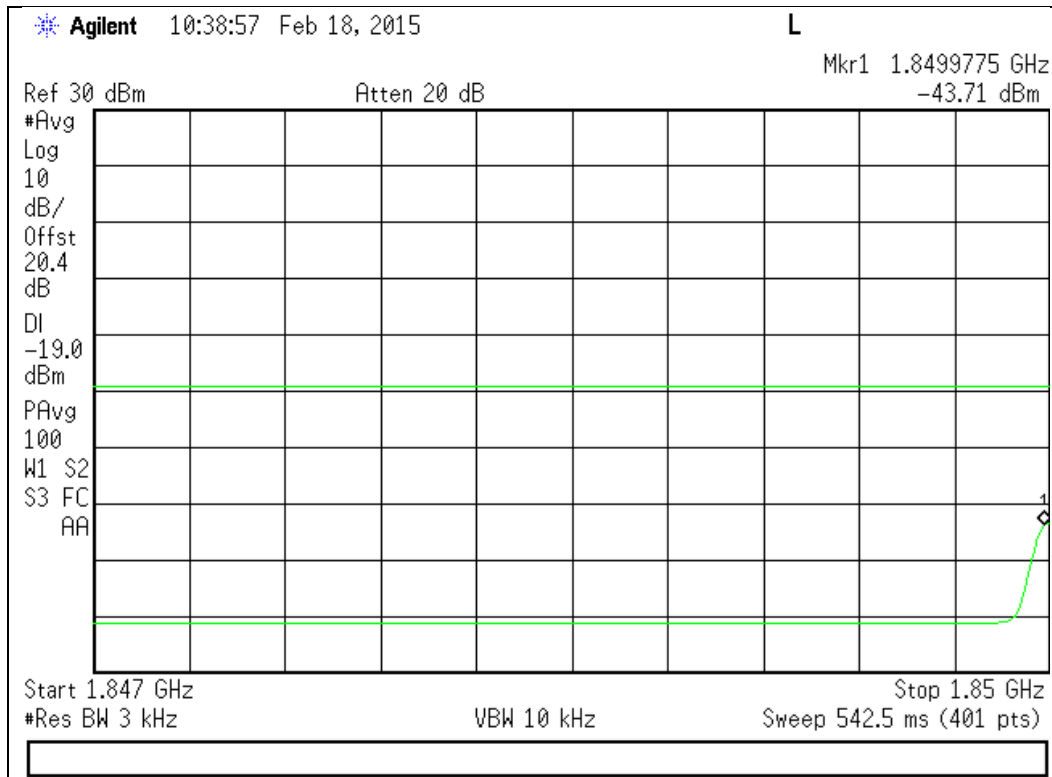

Upper Band Edge

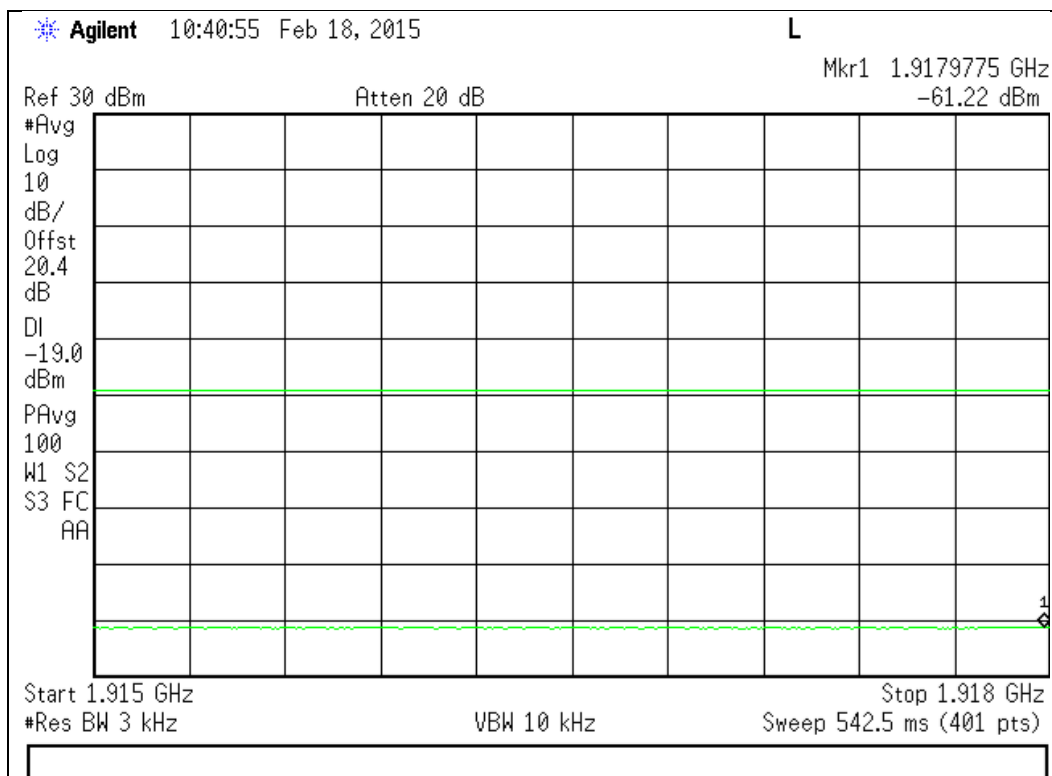

### CDMA Uplink Test Plots

#### 698 - 716 MHz Band

#### Lower Band Edge

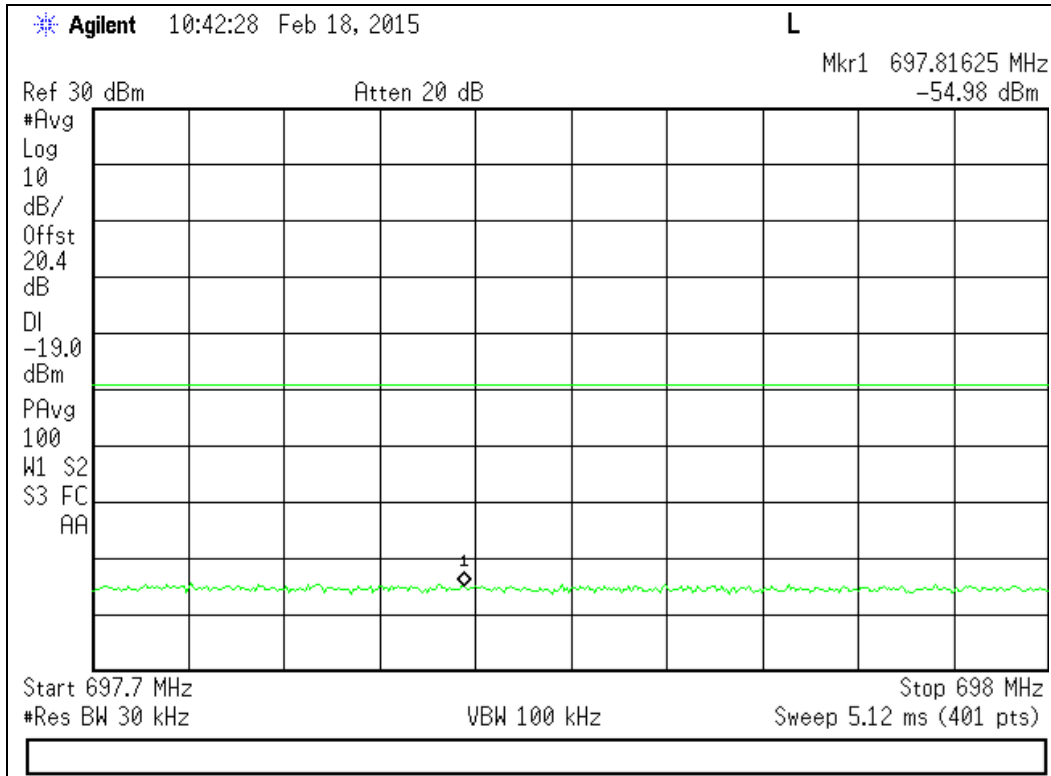

#### Upper Band Edge

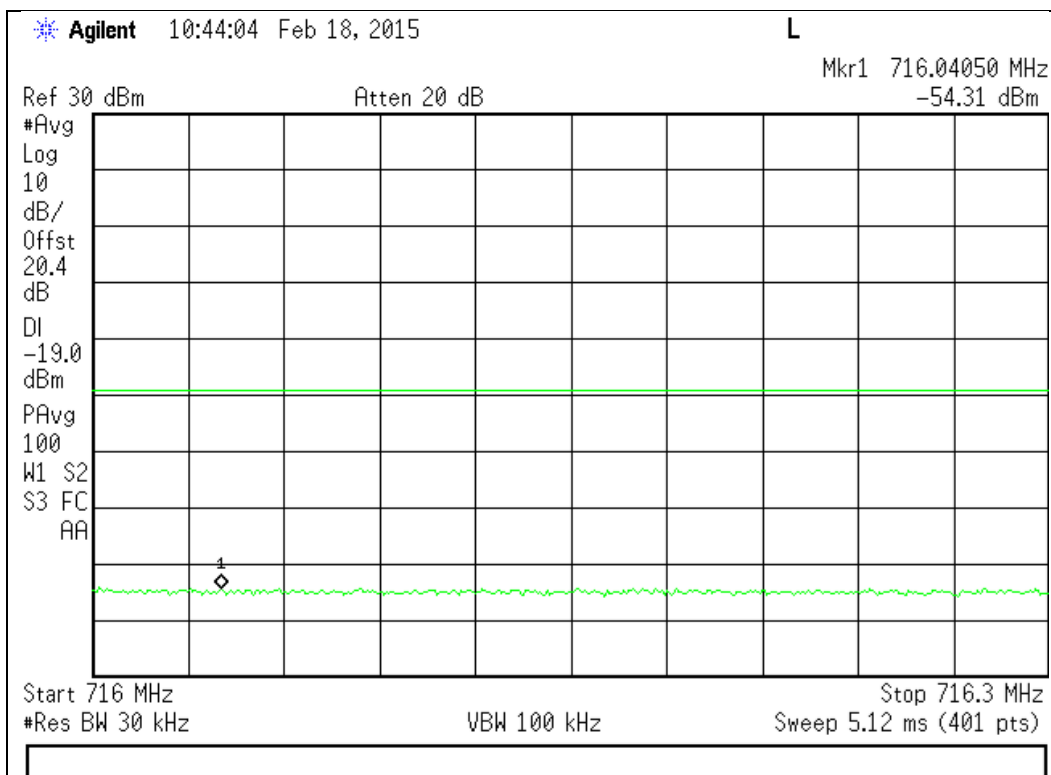

776 - 787 MHz Band

Lower Band Edge

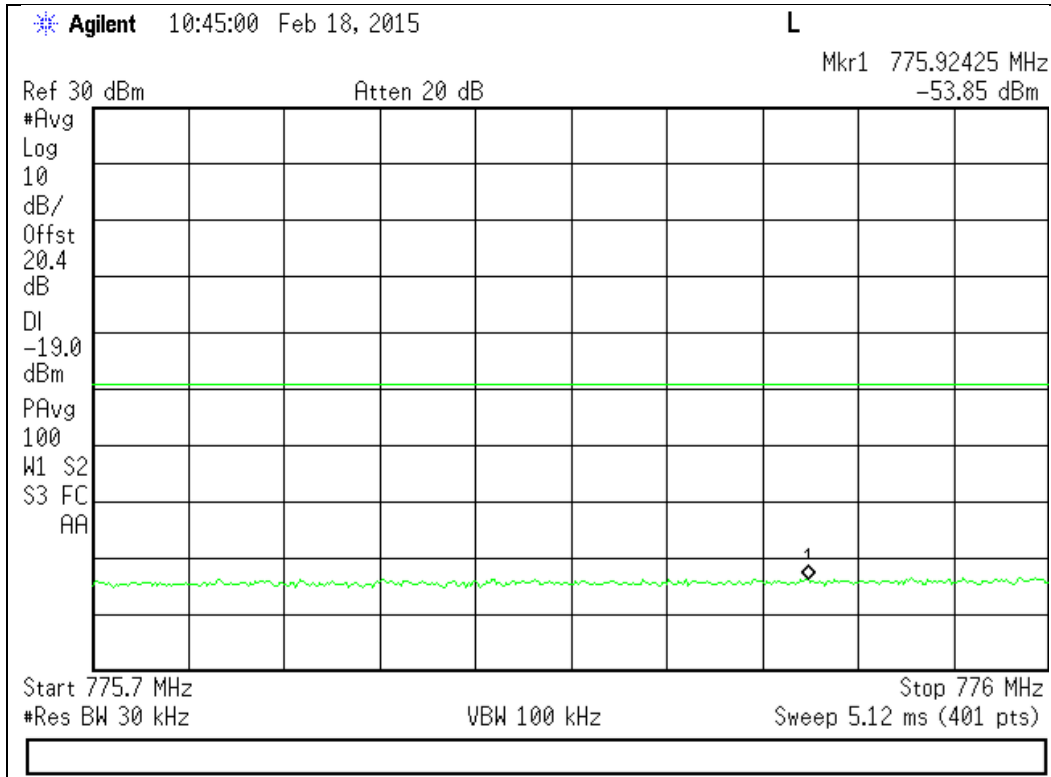

Upper Band Edge

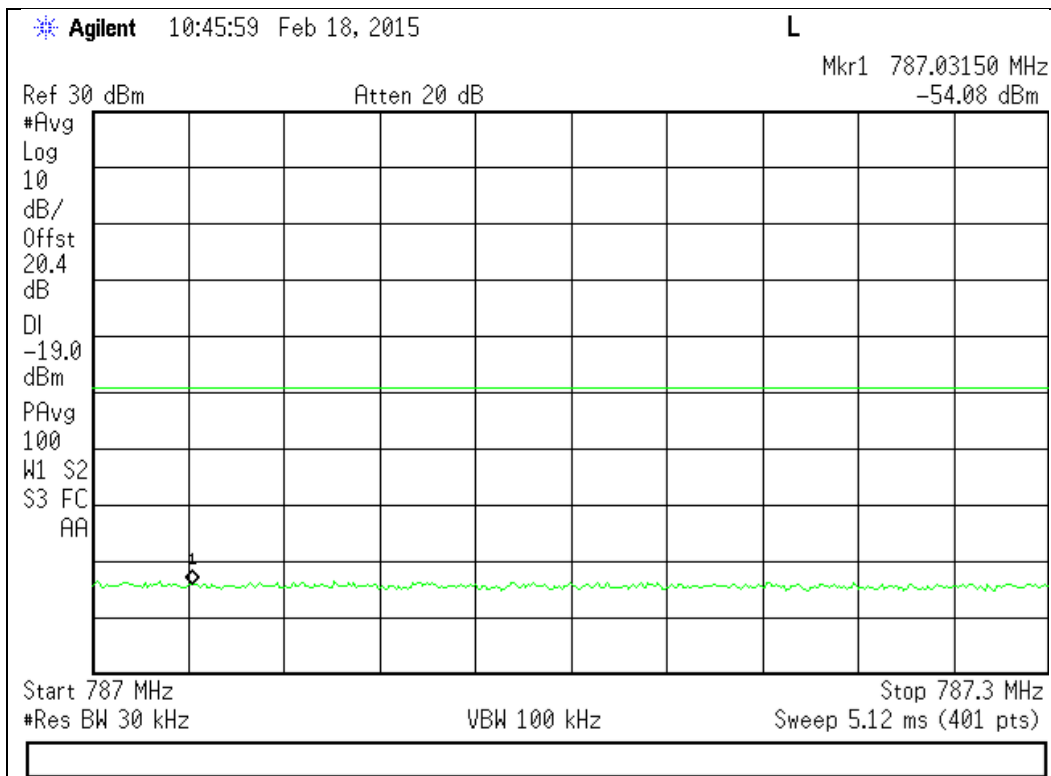

824 - 849 MHz Band

Lower Band Edge

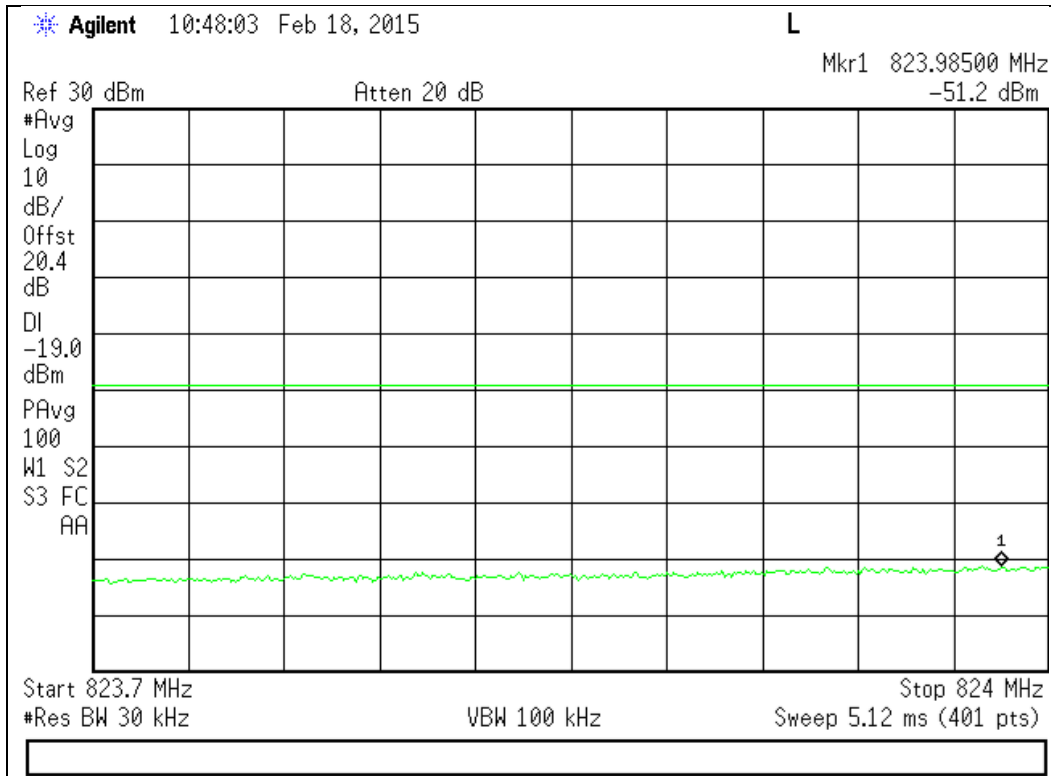

Upper Band Edge

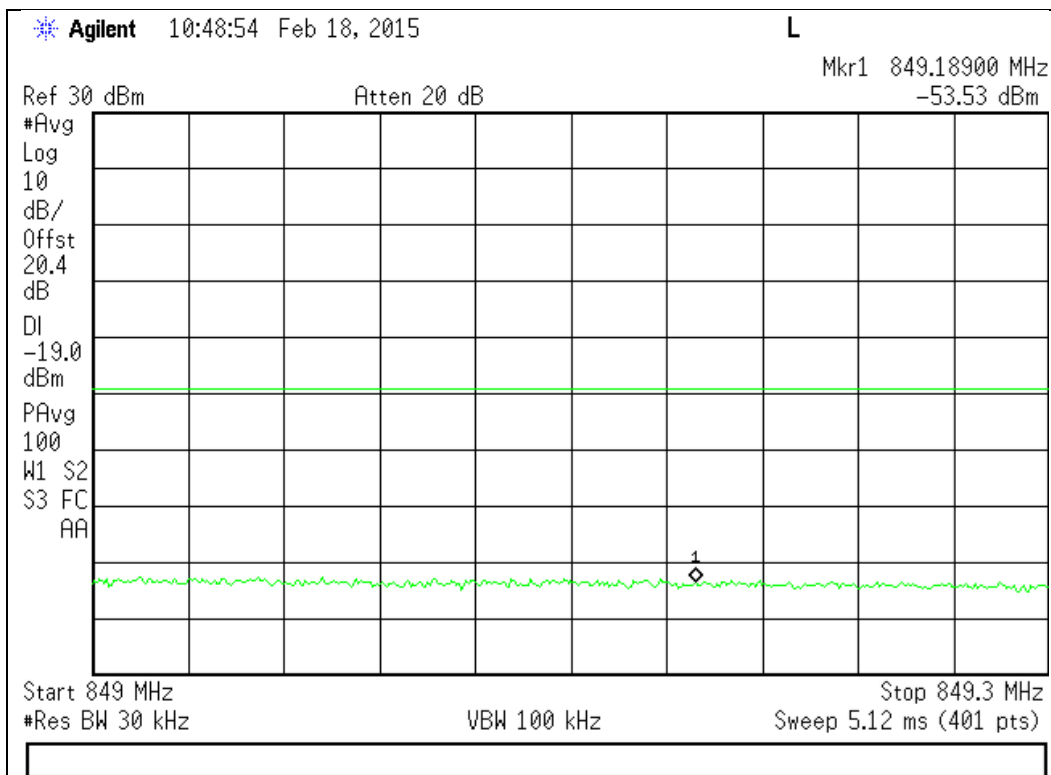

1710 - 1755 MHz Band

Lower Band Edge

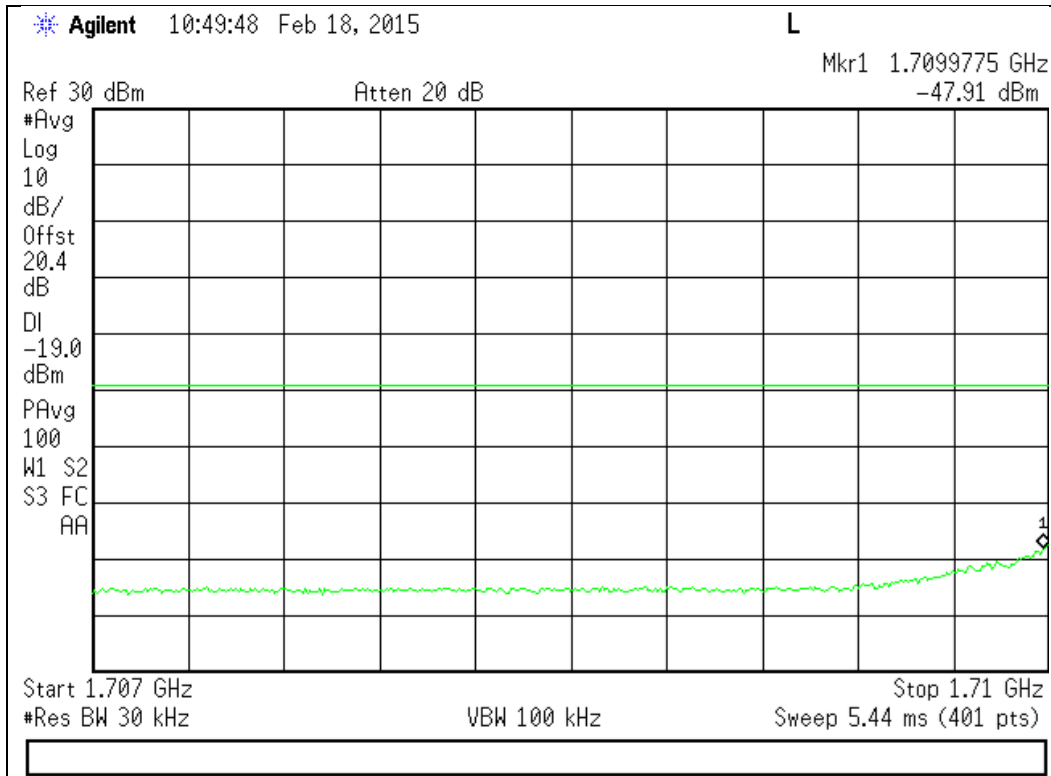

Upper Band Edge

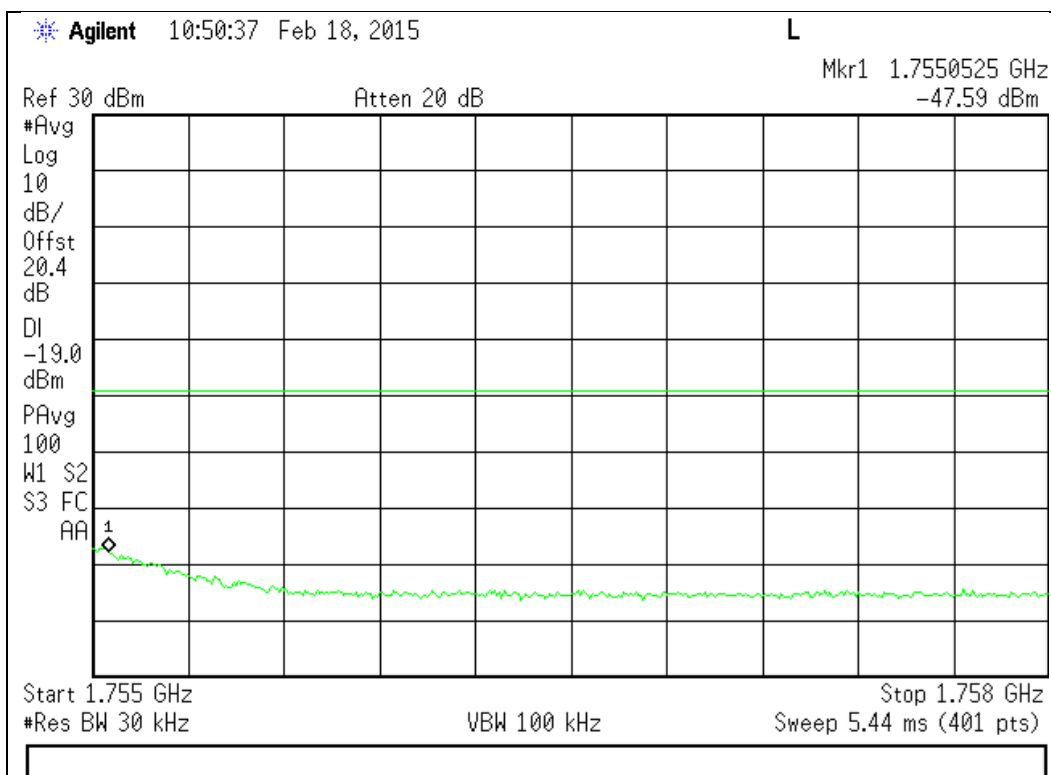

1850 - 1910 MHz Band

Lower Band Edge

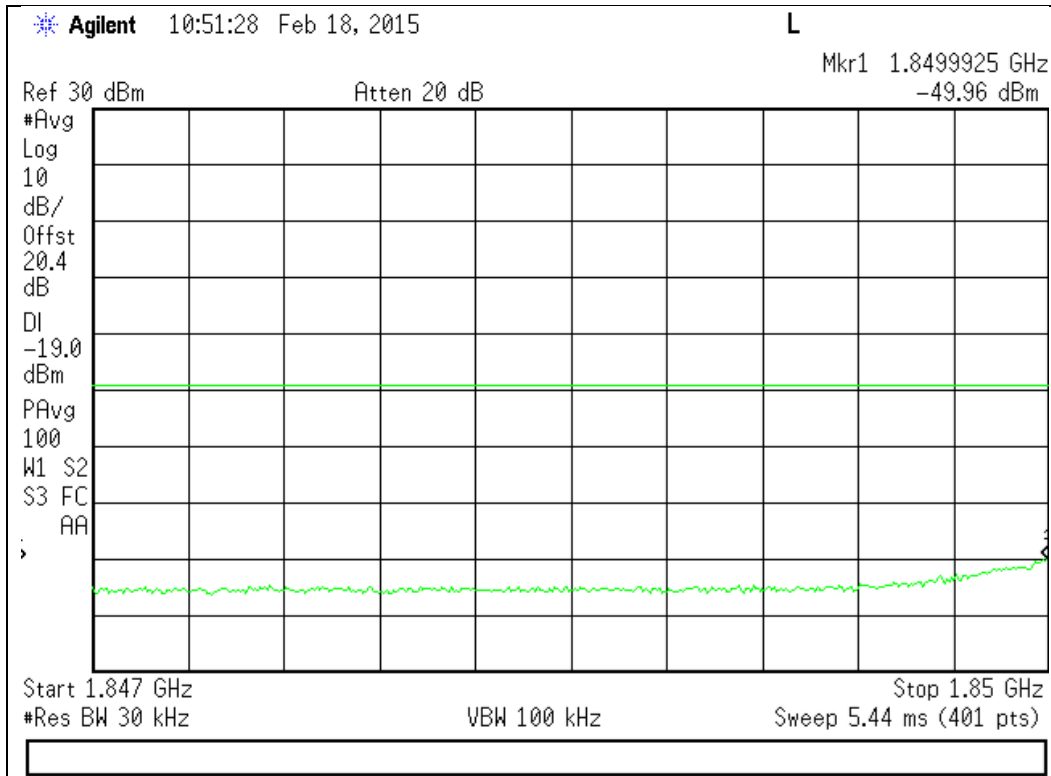

Upper Band Edge

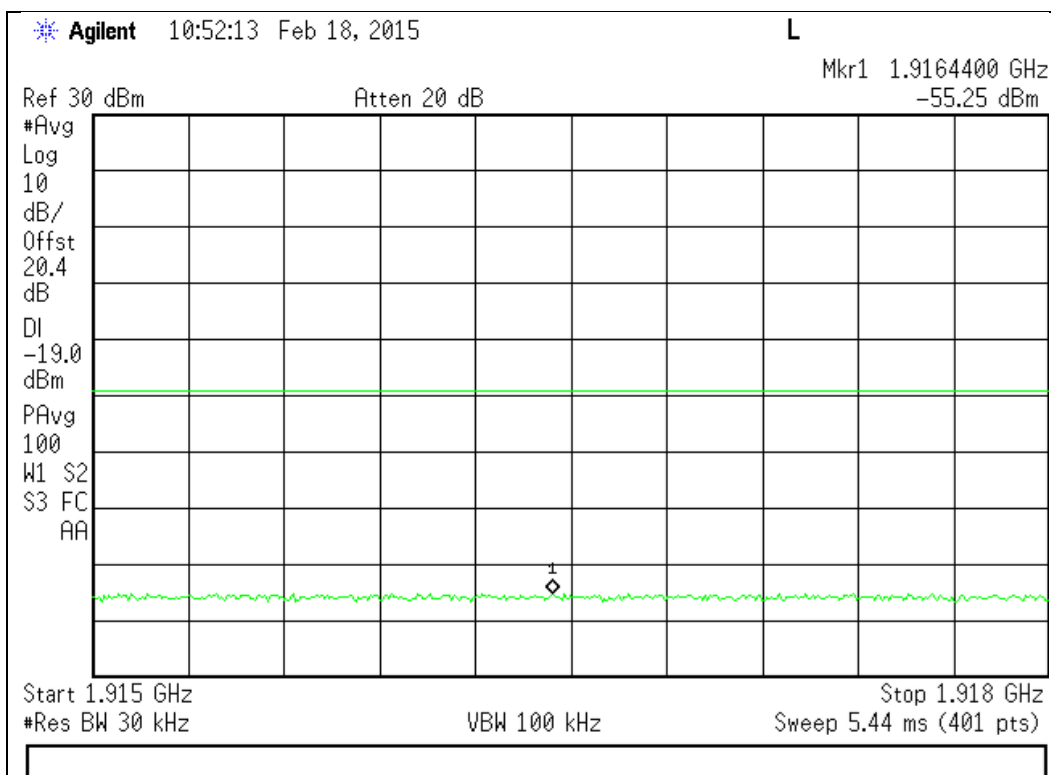



### WCDMA Uplink Test Plots 698 - 716 MHz Band Lower Band Edge

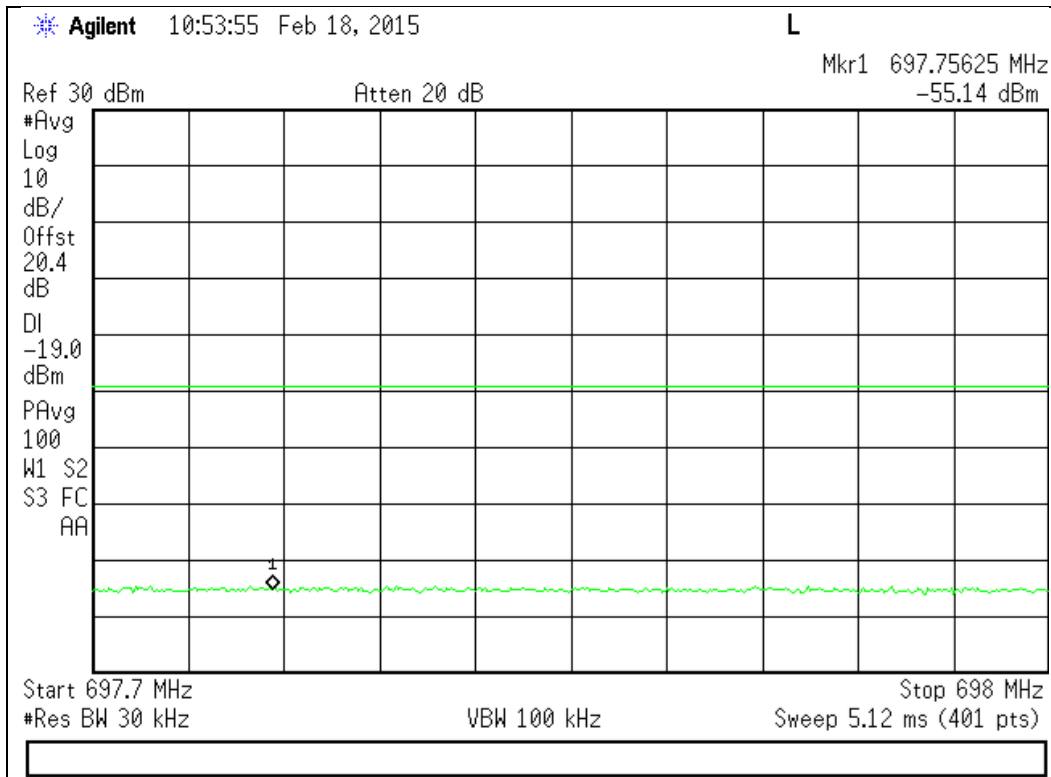

### Upper Band Edge

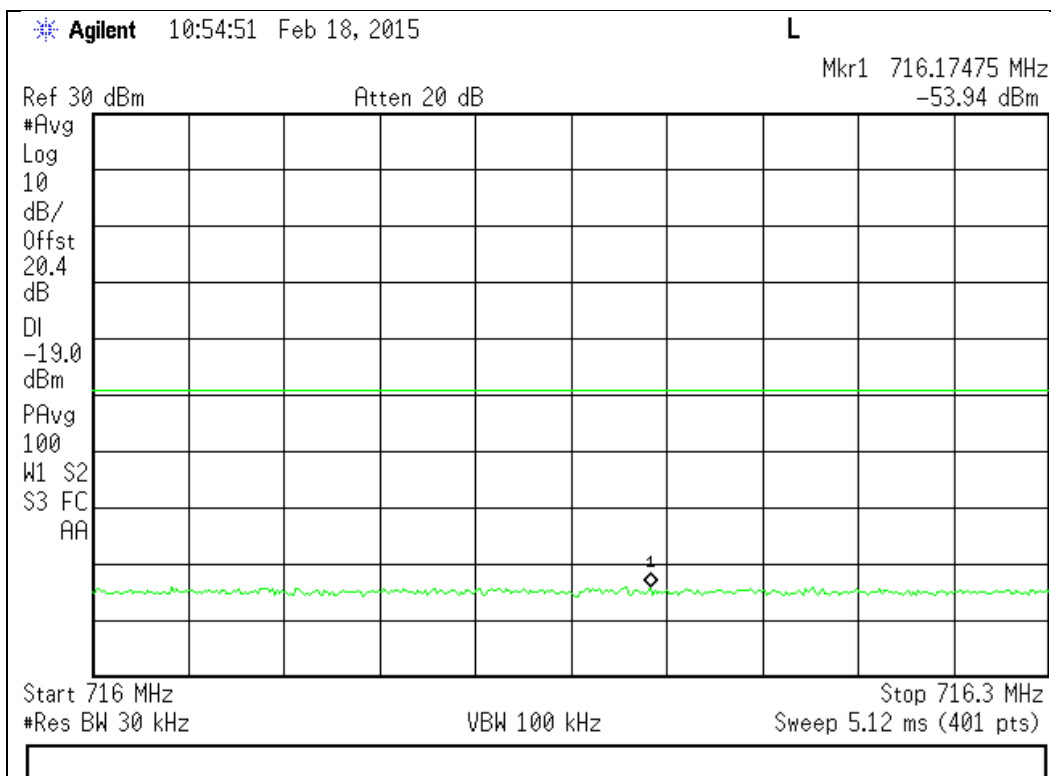

776 - 787 MHz Band

Lower Band Edge

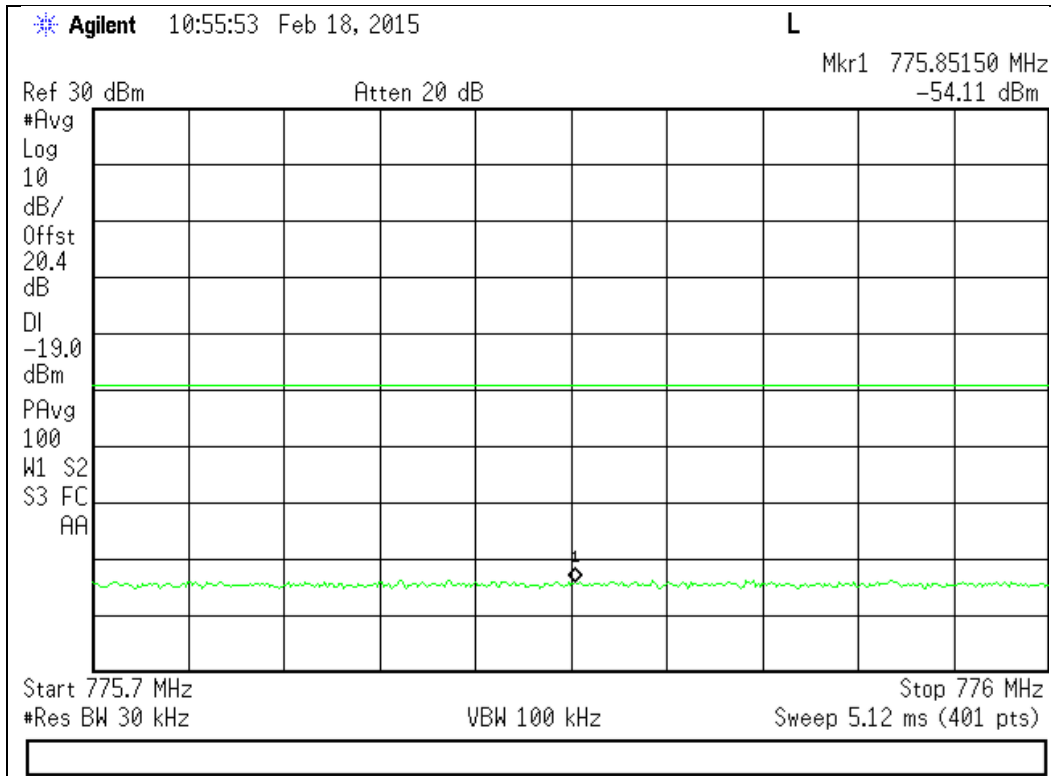

Upper Band Edge

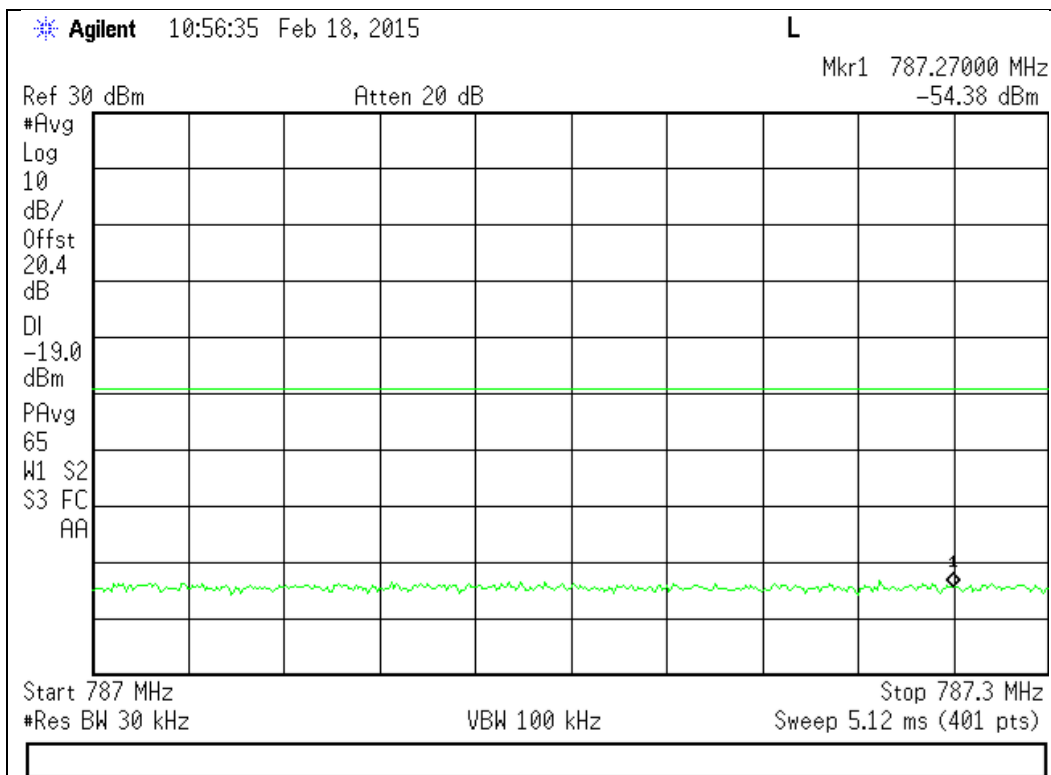

824 - 849 MHz Band

Lower Band Edge

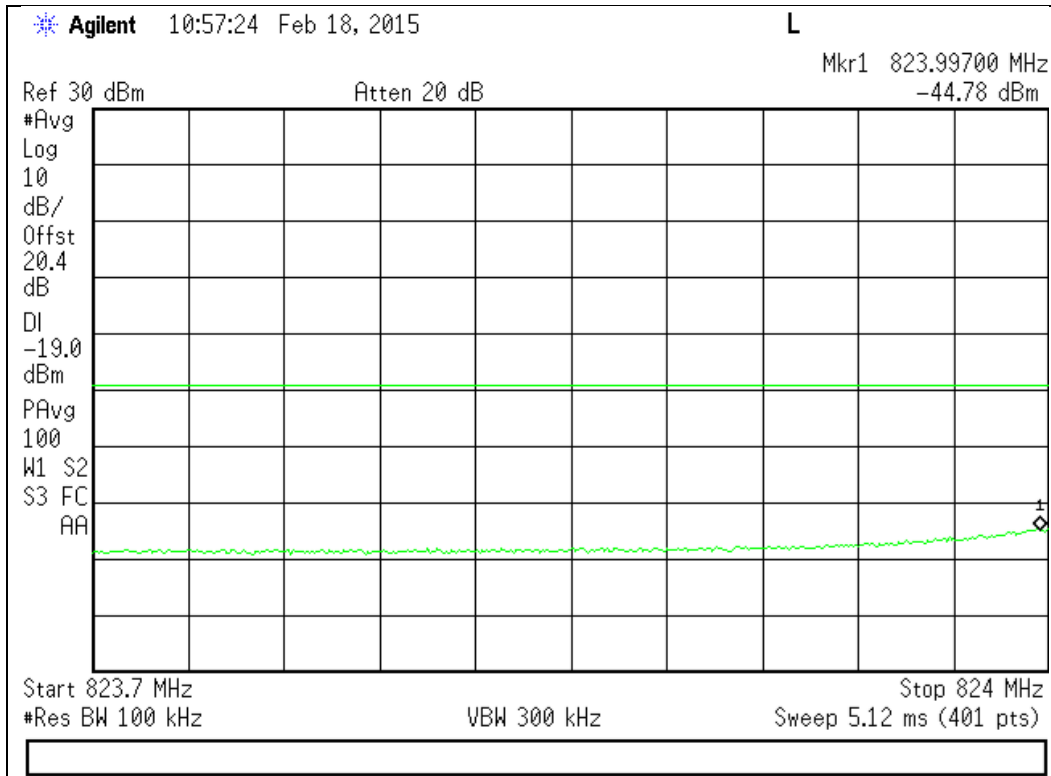

Upper Band Edge

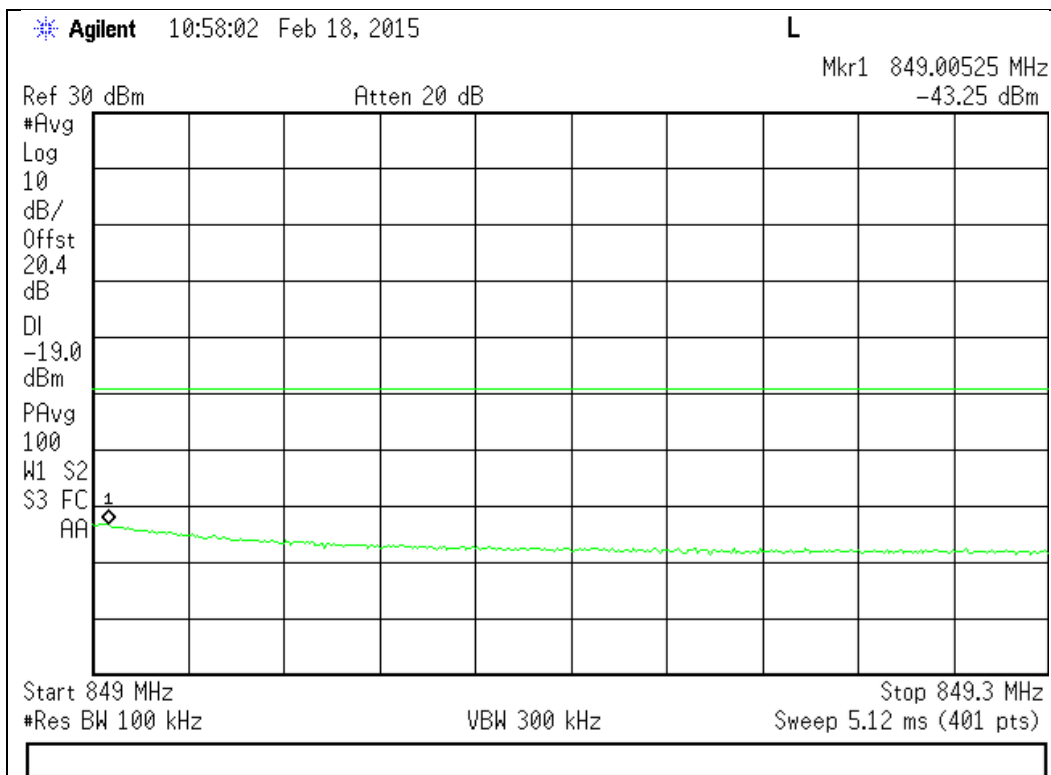

1710 - 1755 MHz Band

Lower Band Edge

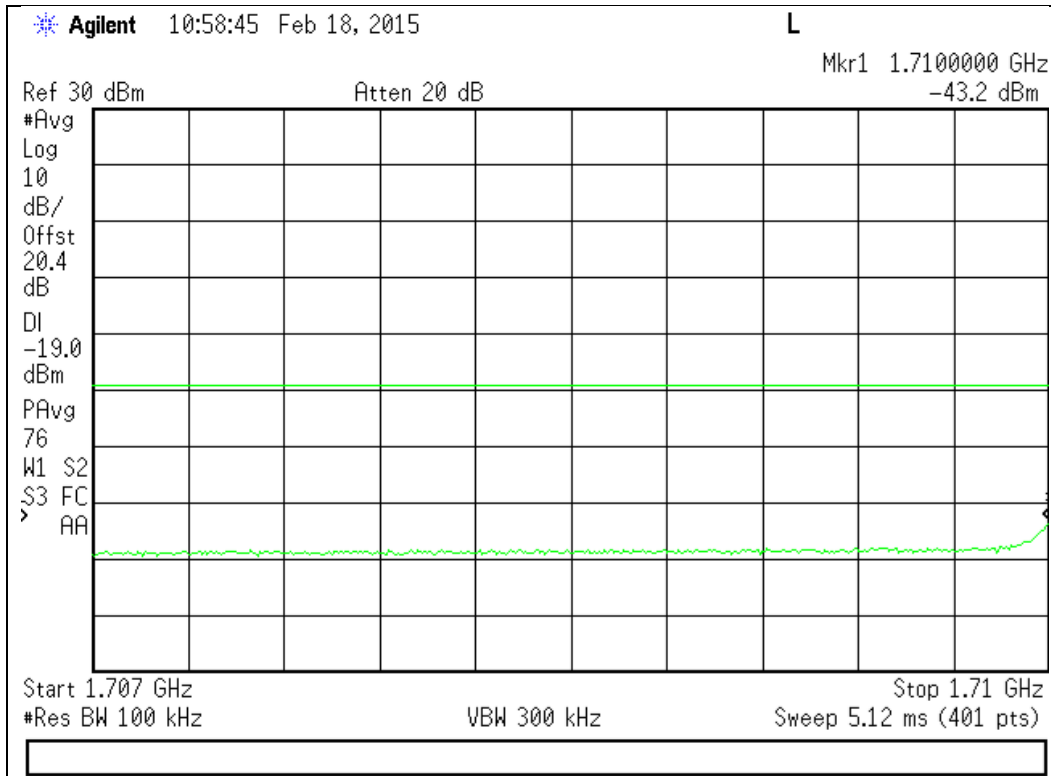

Upper Band Edge

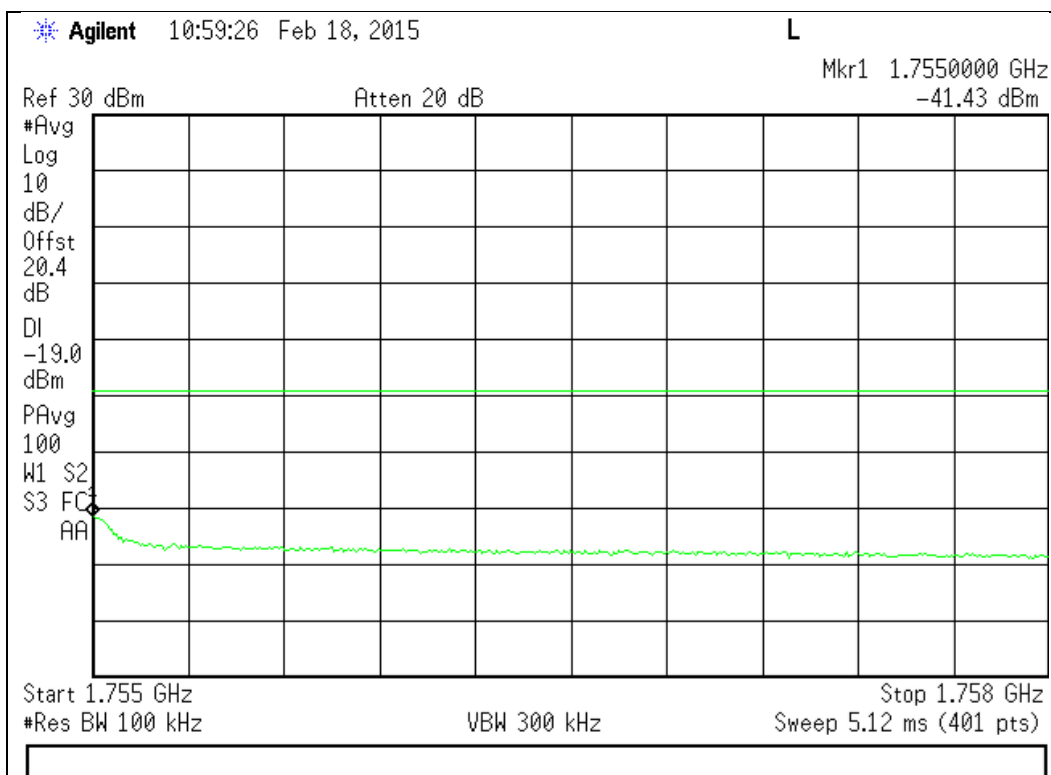

1850 - 1910 MHz Band

Lower Band Edge

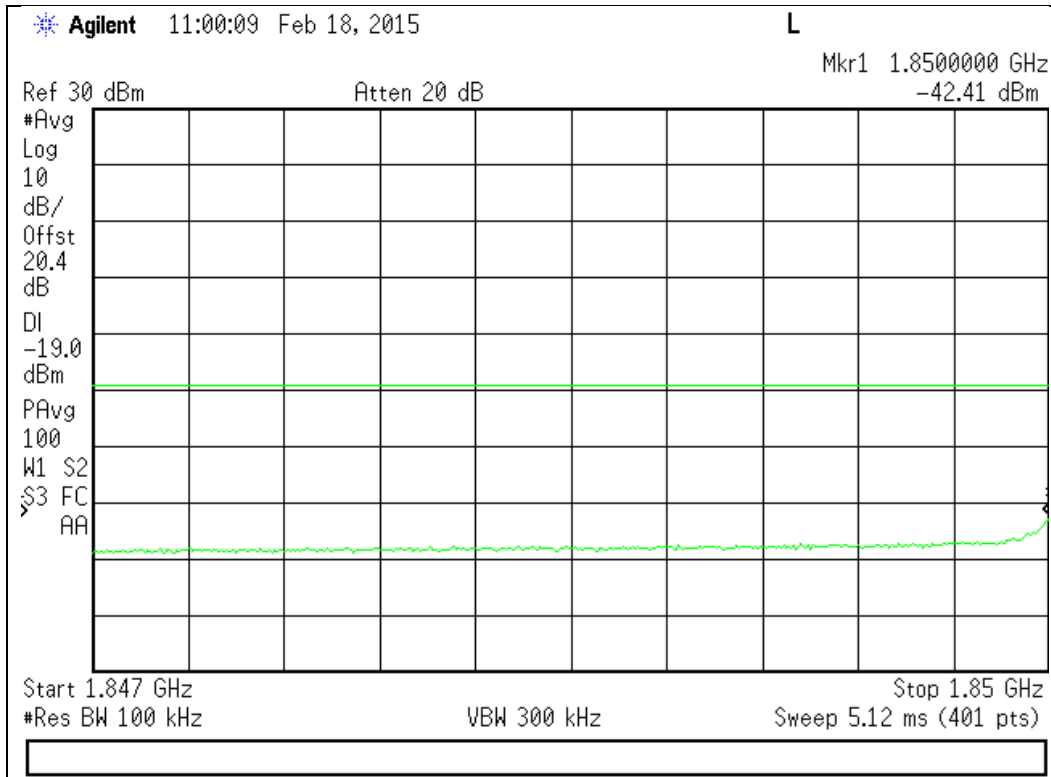

Upper Band Edge

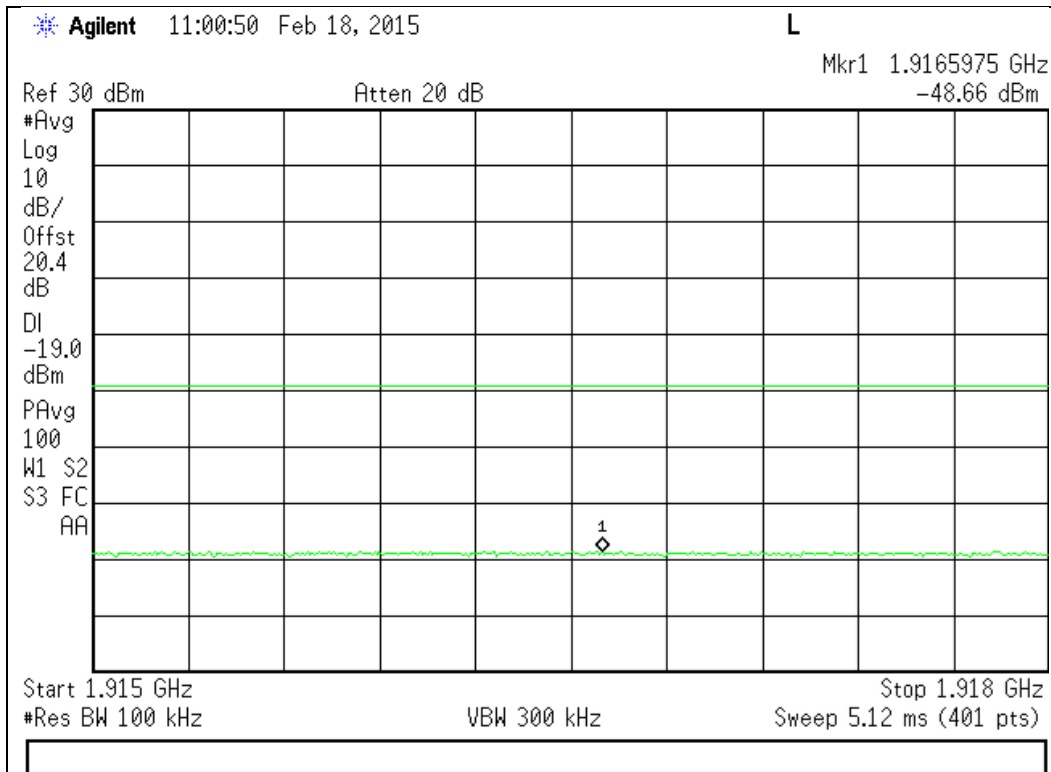

**GSM Downlink Test Plots**  
**728 - 746 MHz Band**  
**Lower Band Edge**

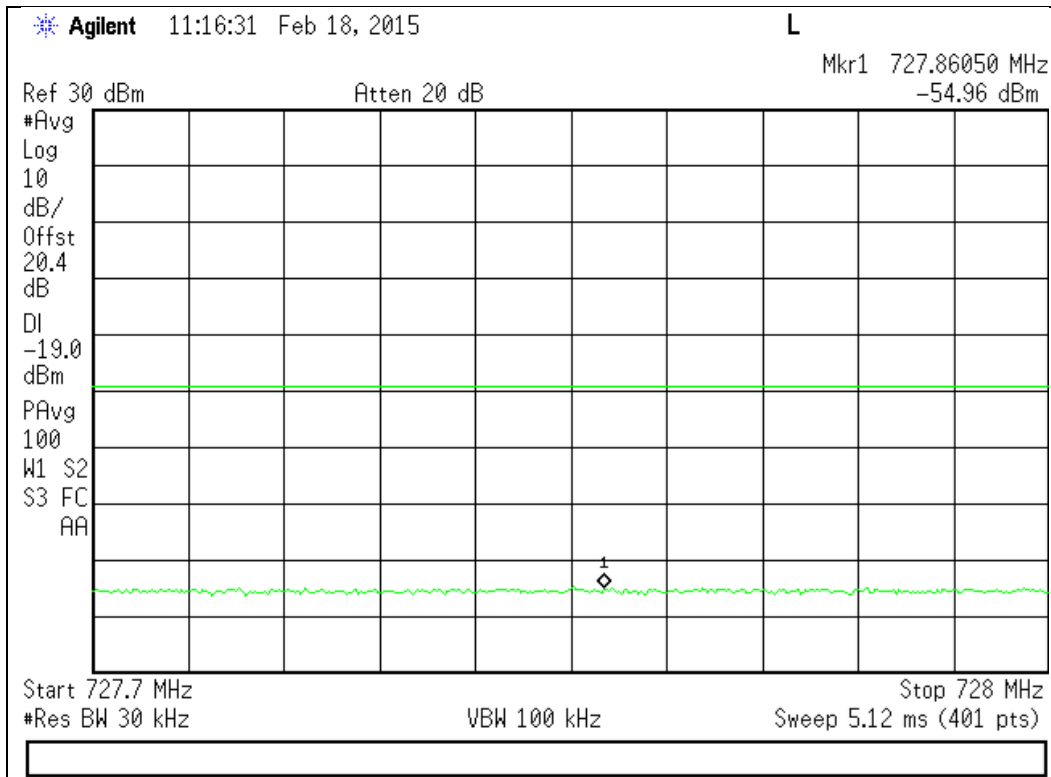

**Upper Band Edge**

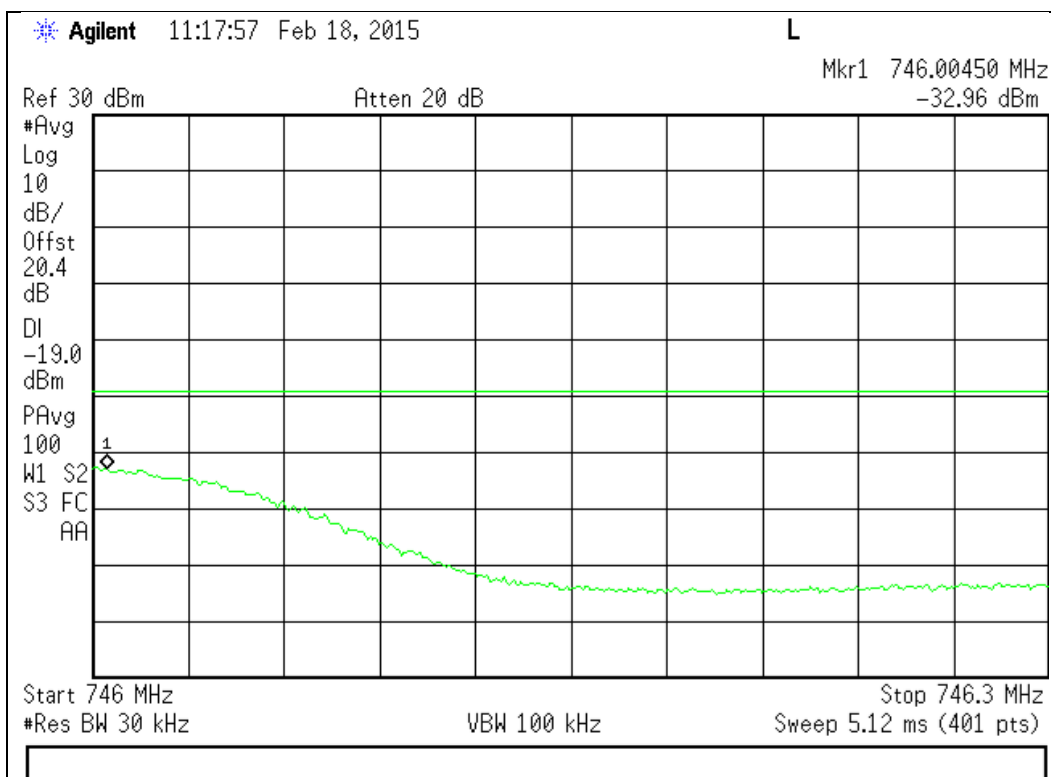

746 - 757 MHz Band

Lower Band Edge

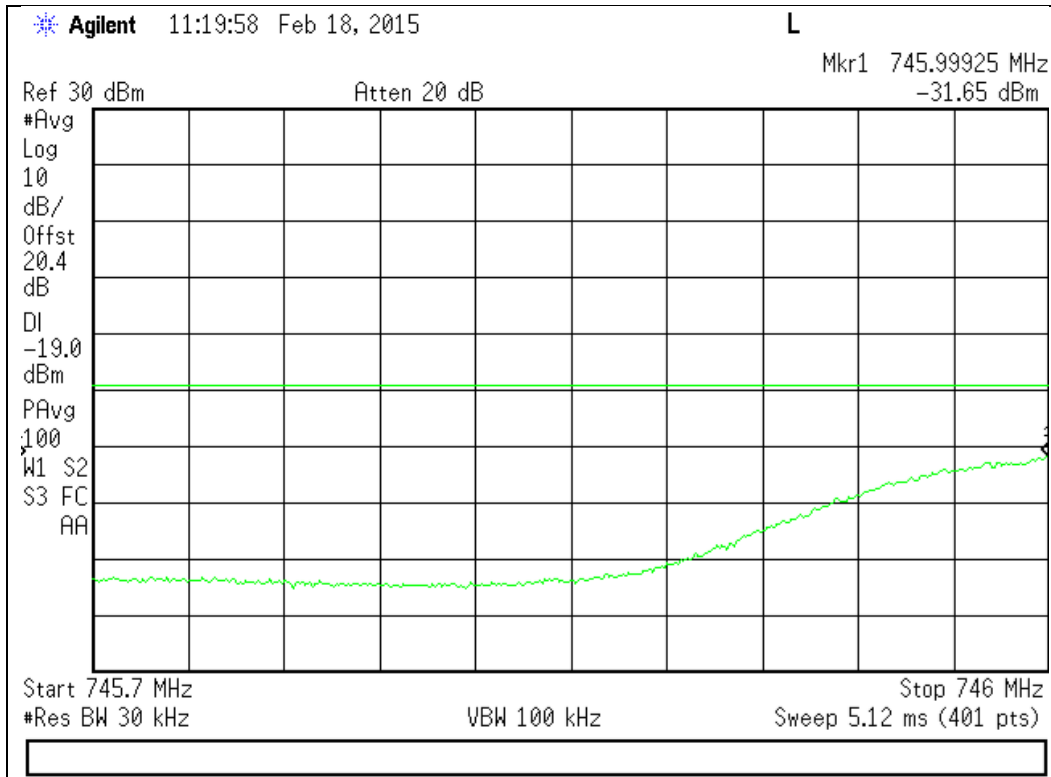

Upper Band Edge

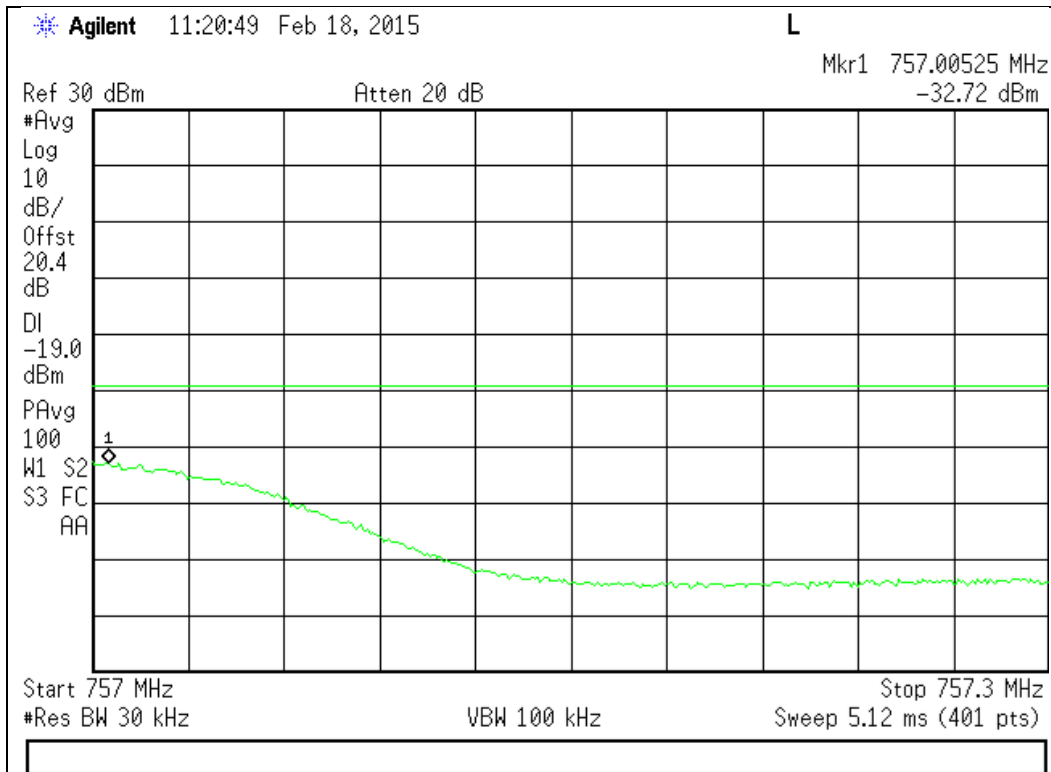

869 - 894 MHz Band

Lower Band Edge

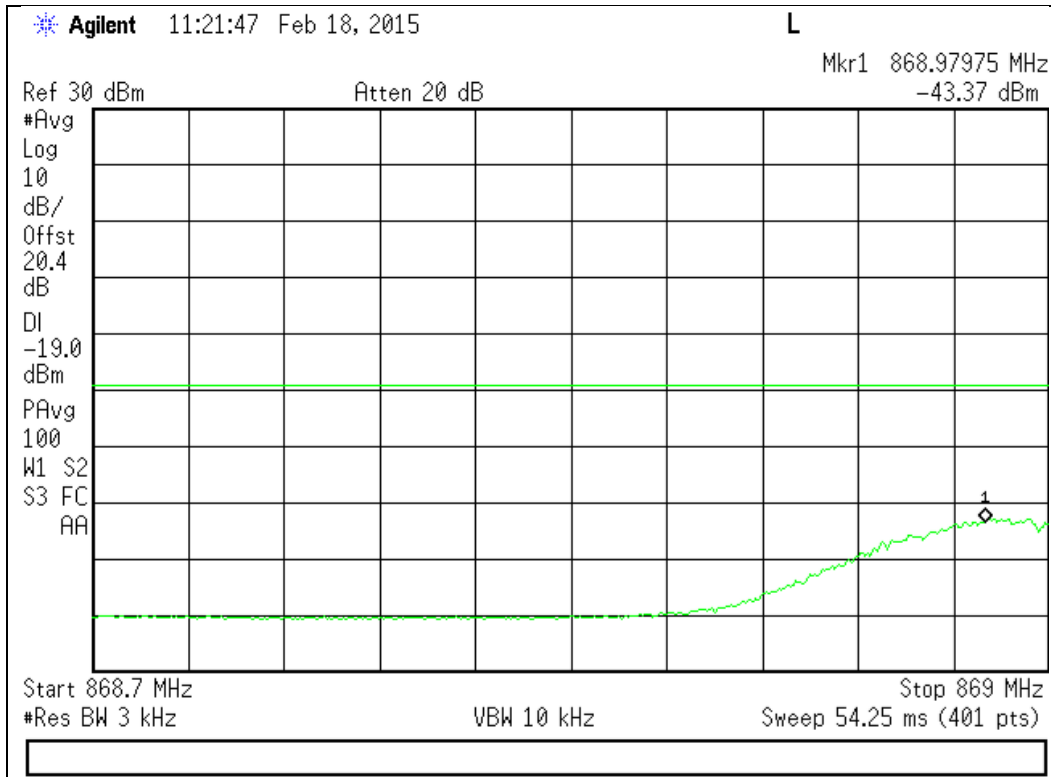

Upper Band Edge

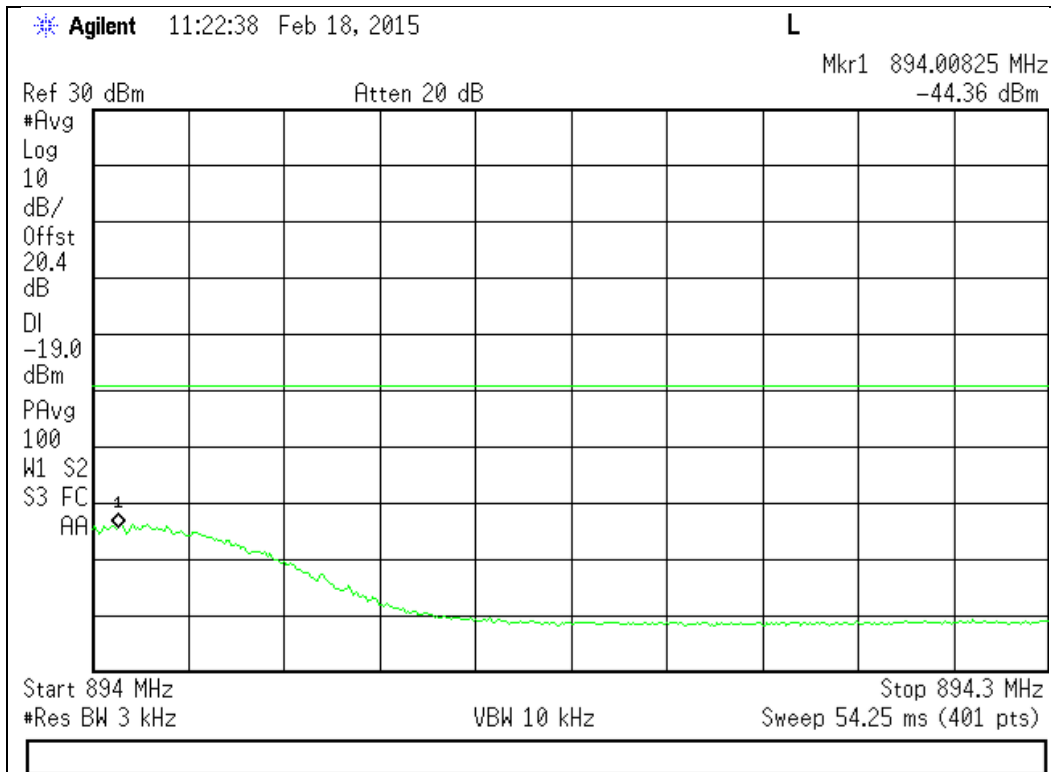



1930 - 1990 MHz Band

Lower Band Edge

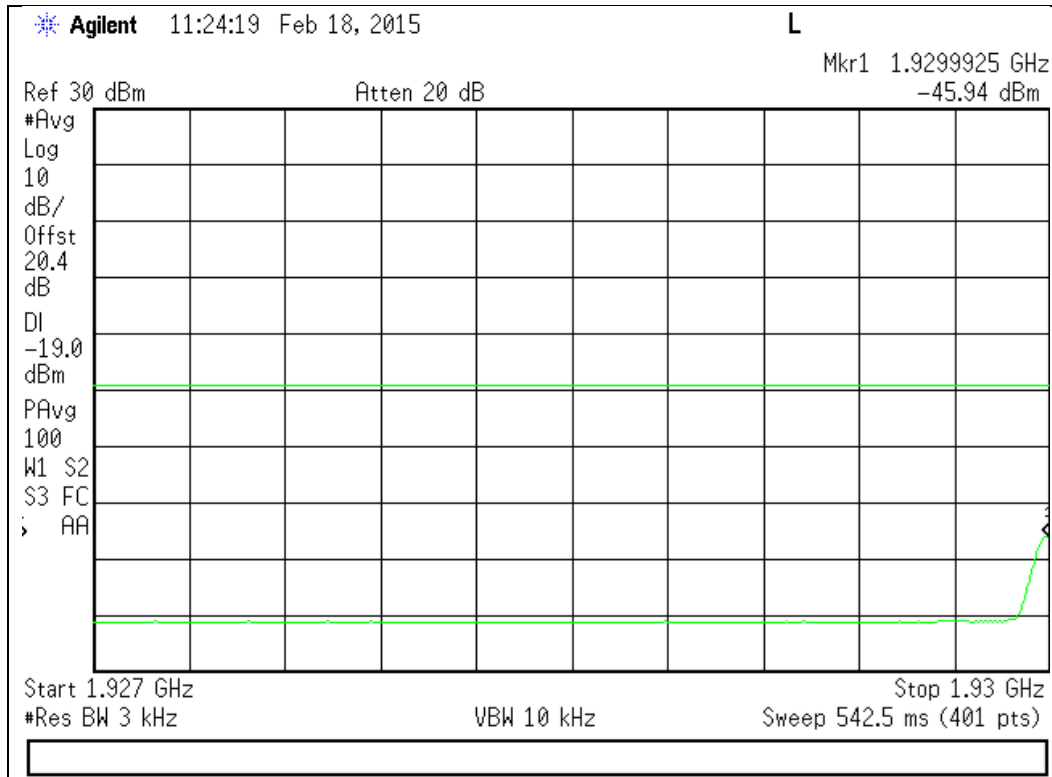

Upper Band Edge

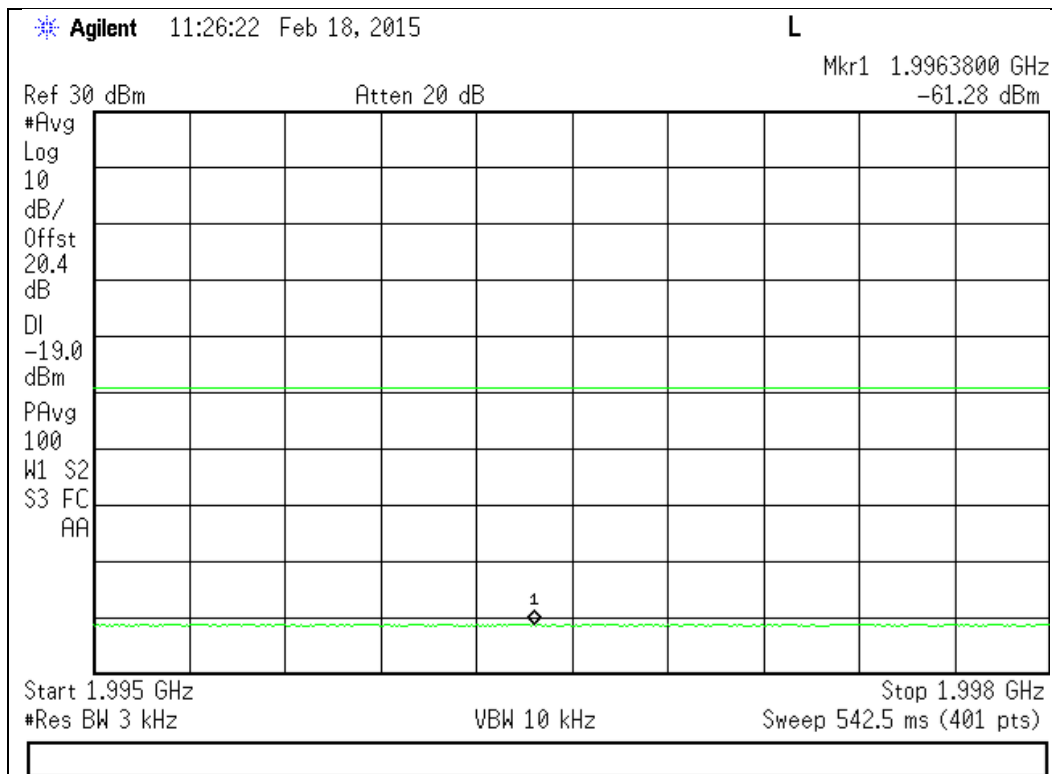

2110 - 2155 MHz Band

Lower Band Edge

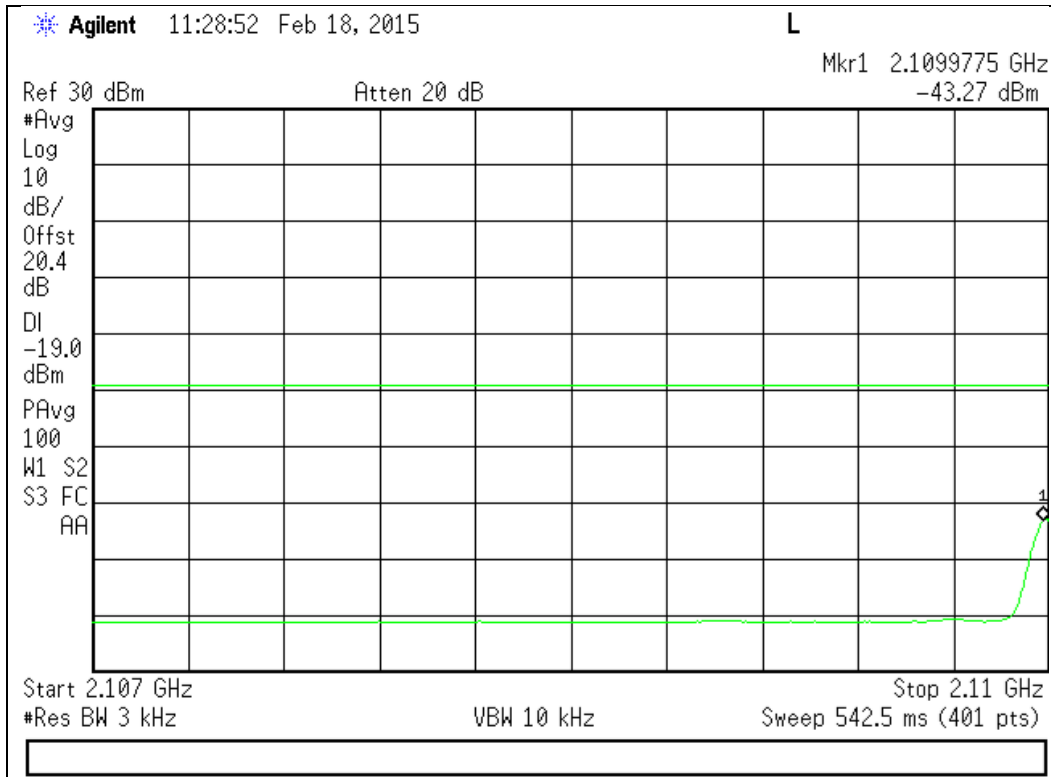

Upper Band Edge

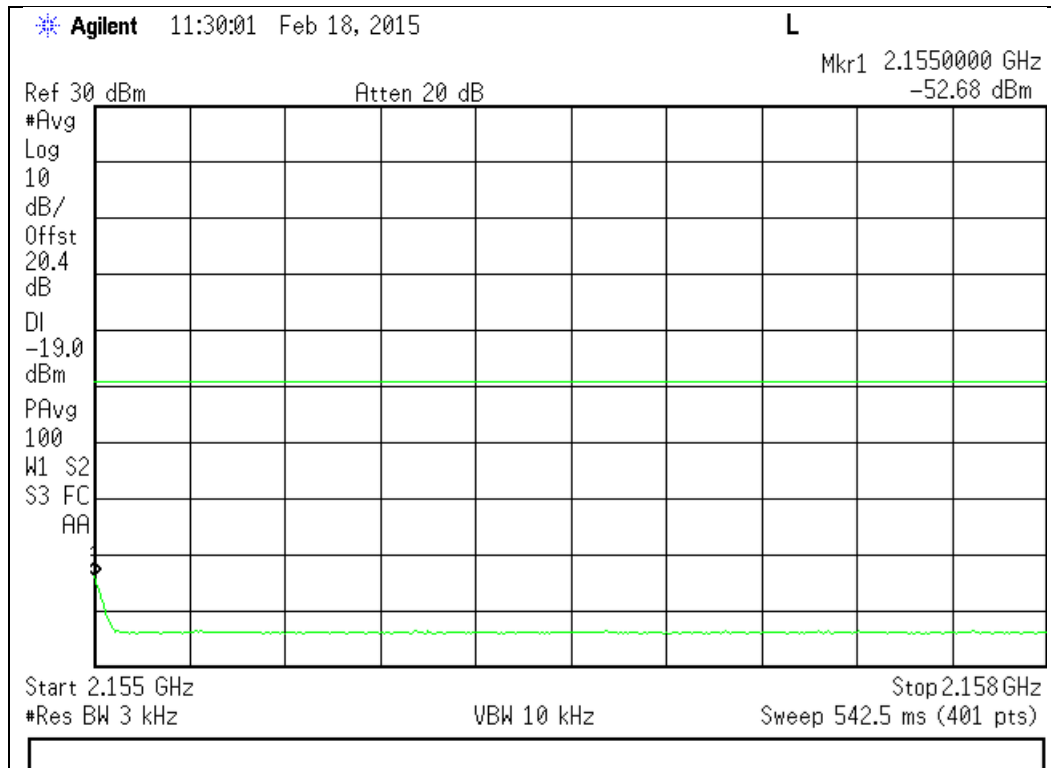

CDMA Downlink Test Plots

728 - 746 MHz Band

Lower Band Edge

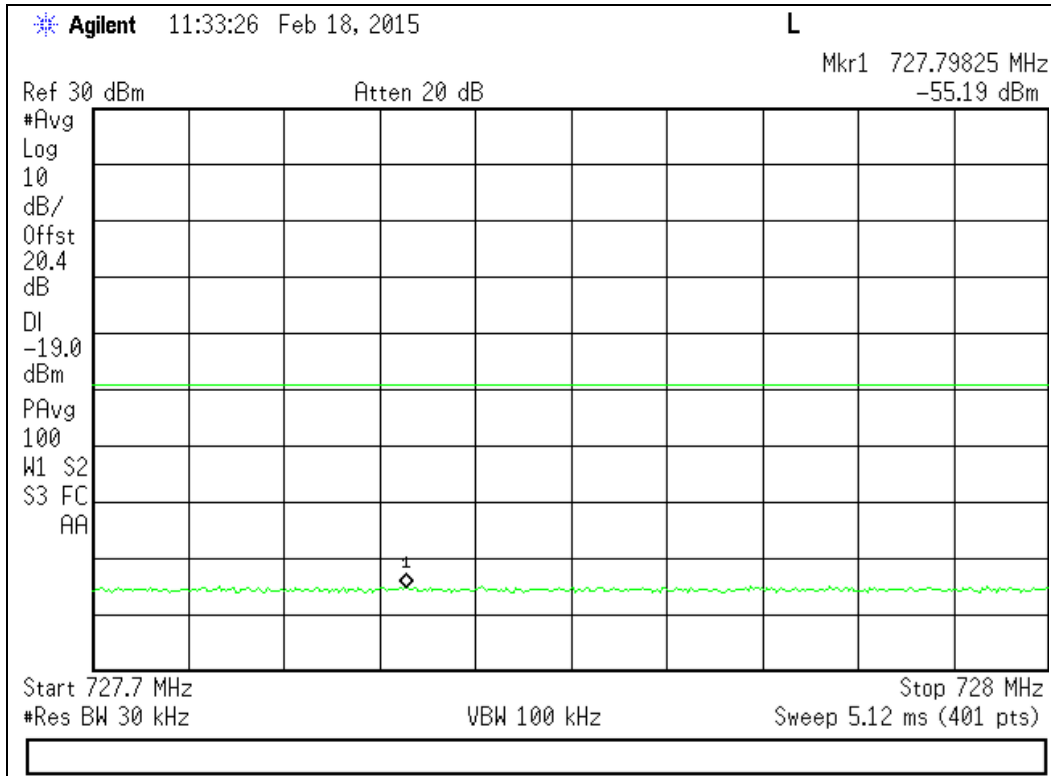

Upper Band Edge

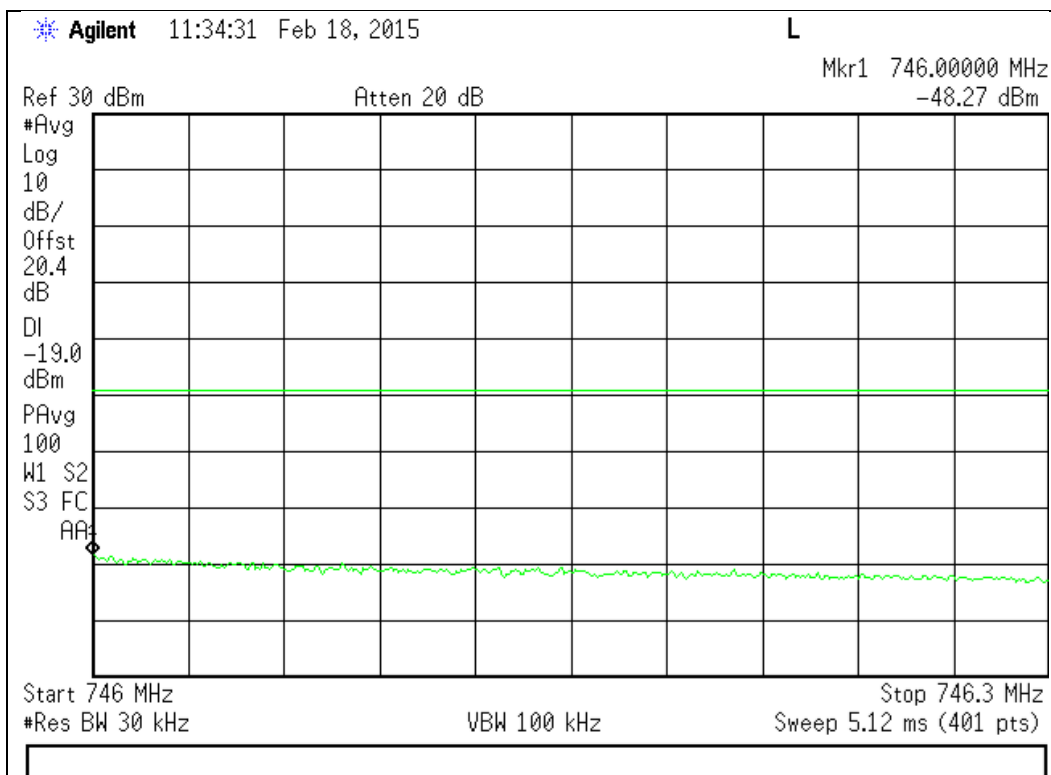

746 - 757 MHz Band

Lower Band Edge

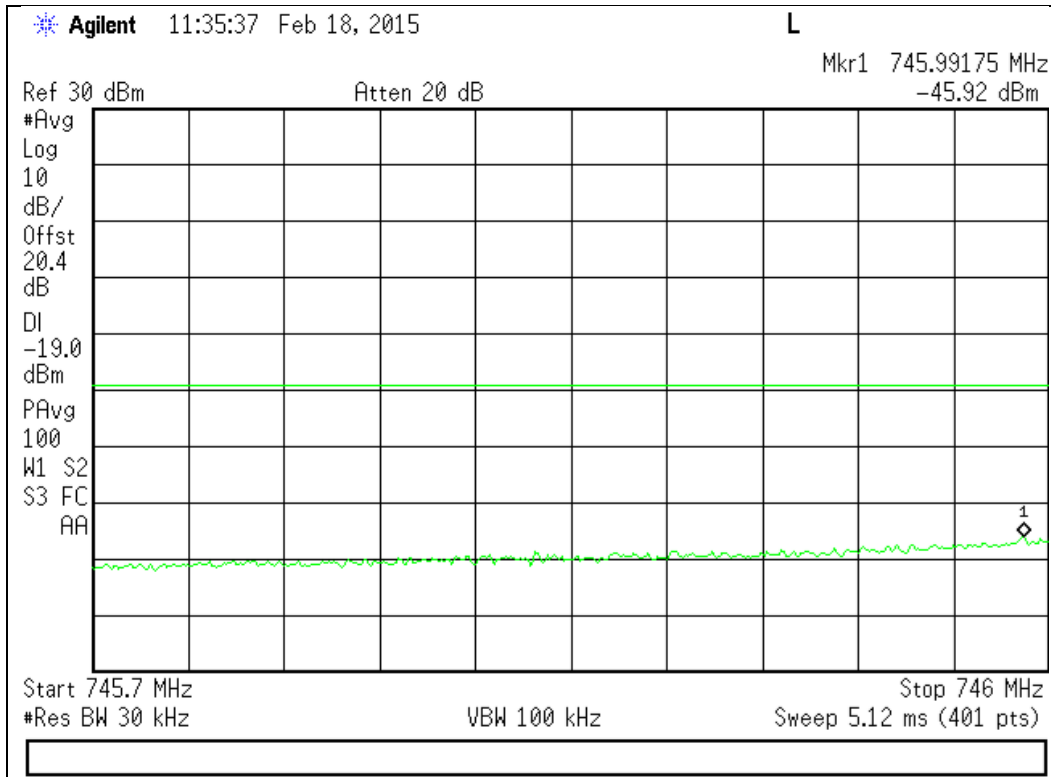

Upper Band Edge

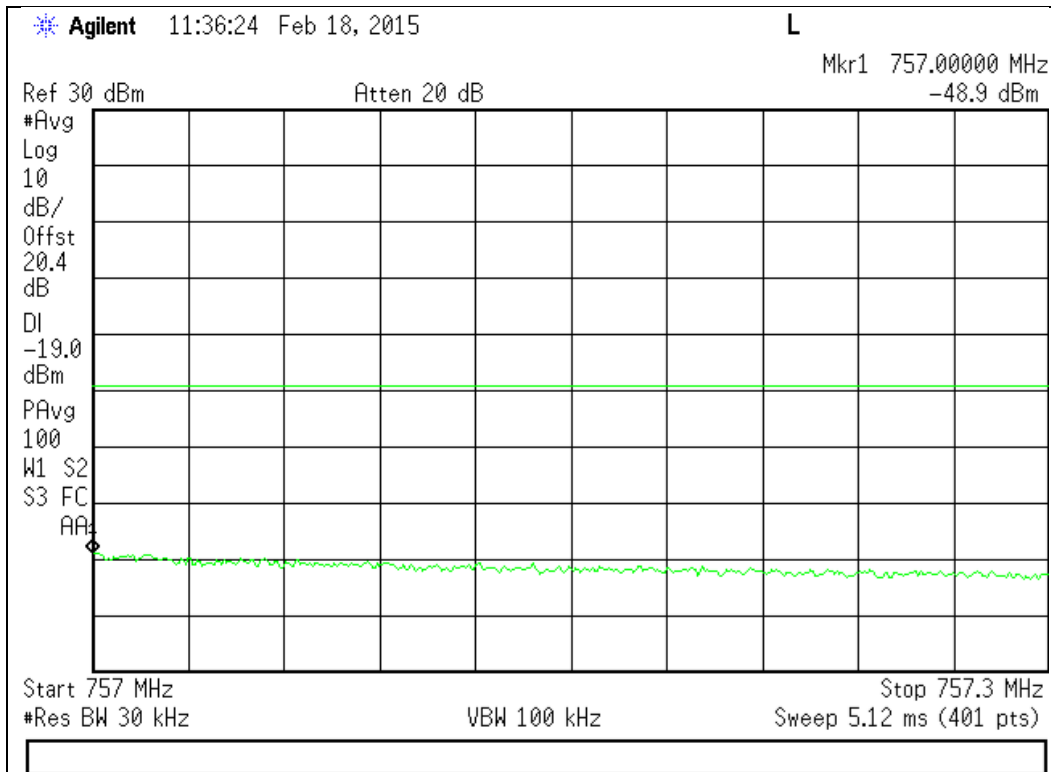

869 - 894 MHz Band

Lower Band Edge

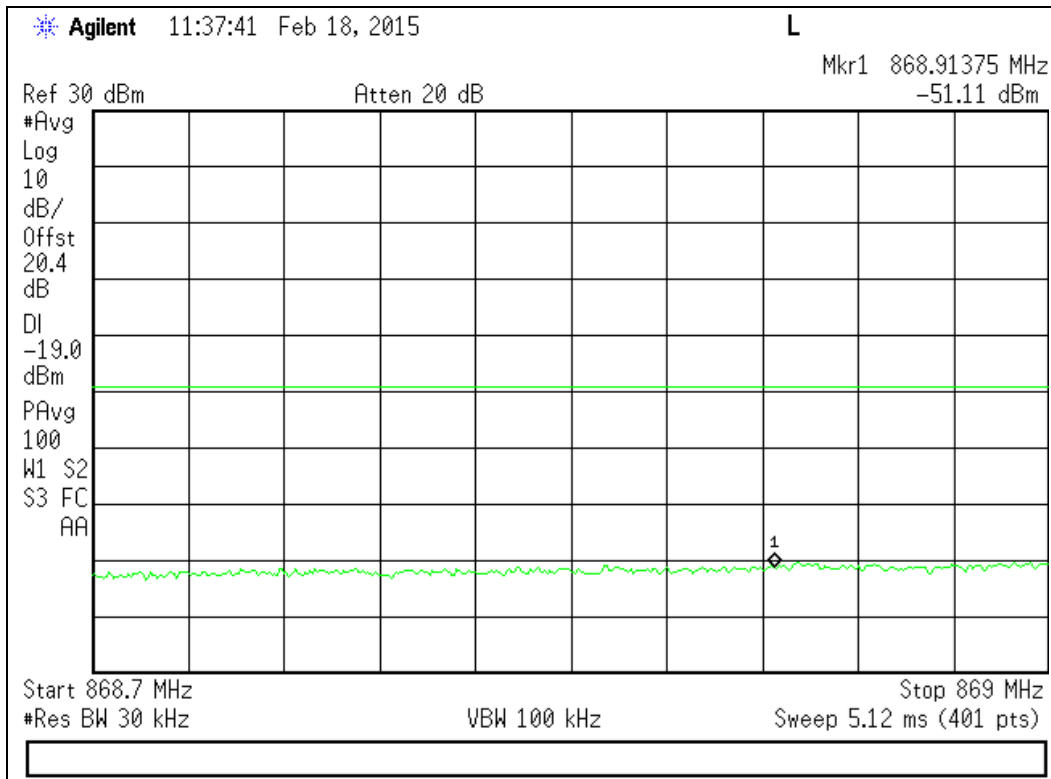

Upper Band Edge

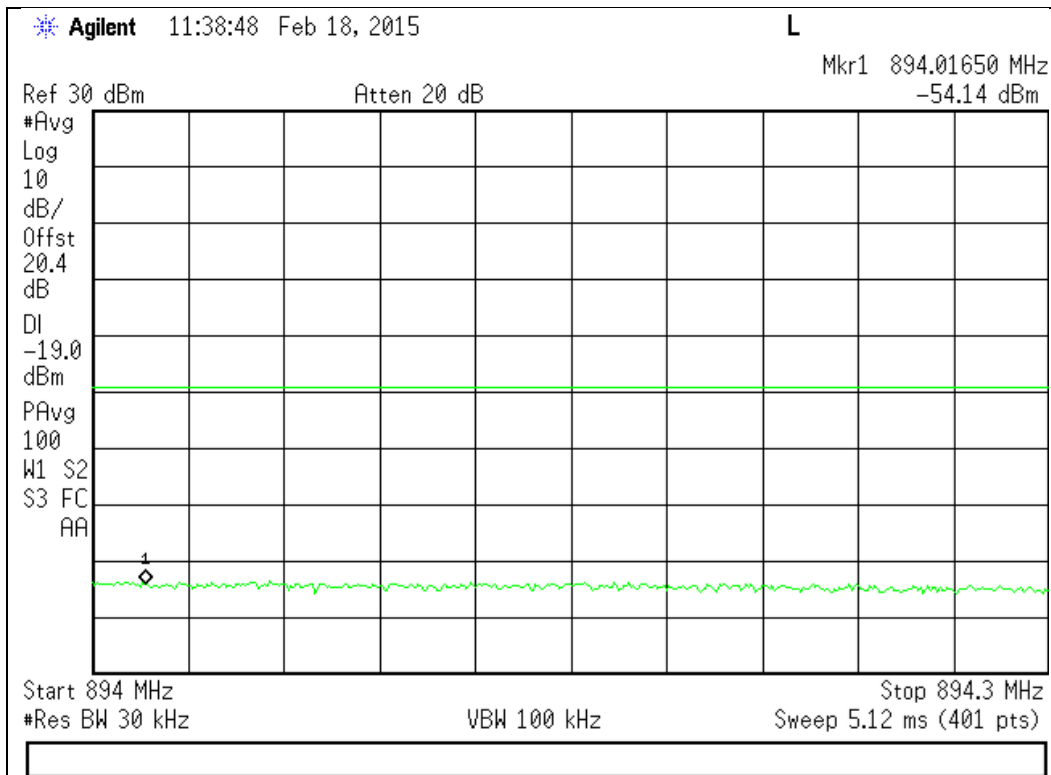

1930 - 1990 MHz Band

Lower Band Edge

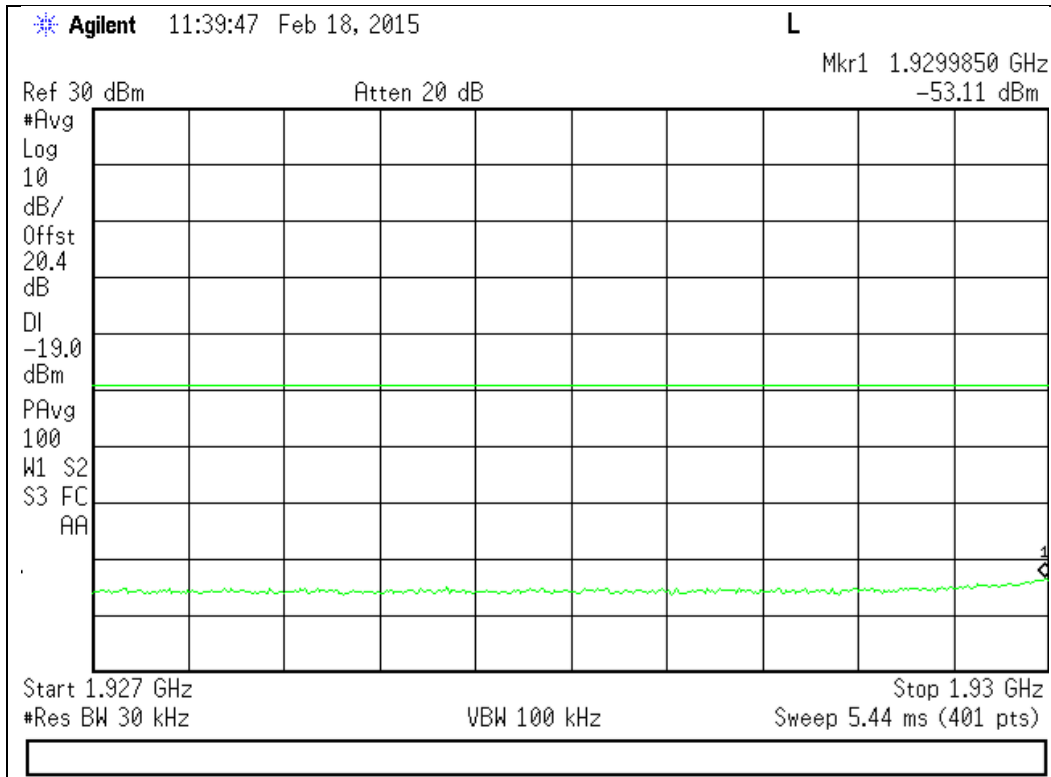

Upper Band Edge

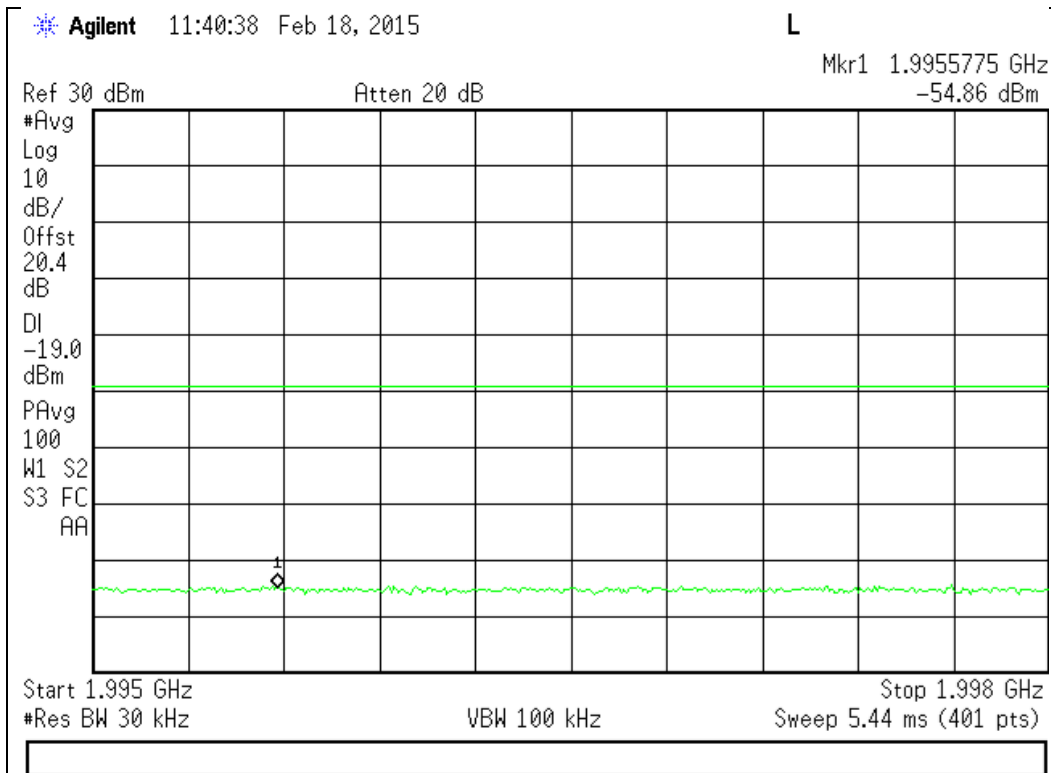

2110 - 2155 MHz Band

Lower Band Edge

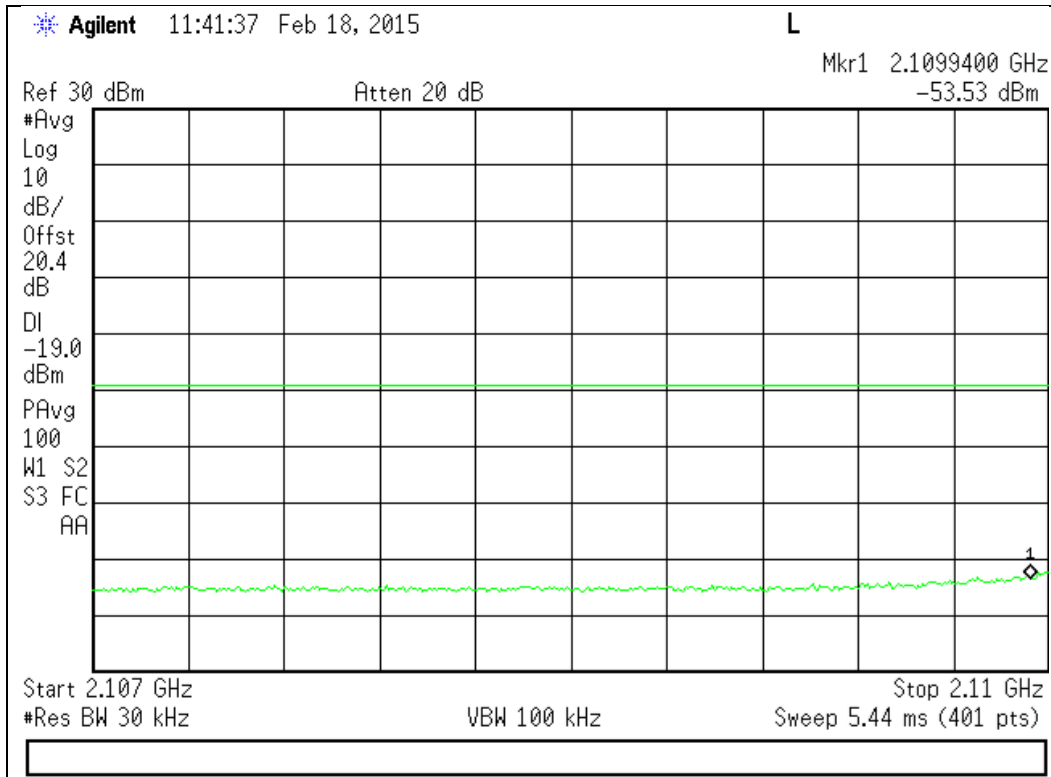

Upper Band Edge

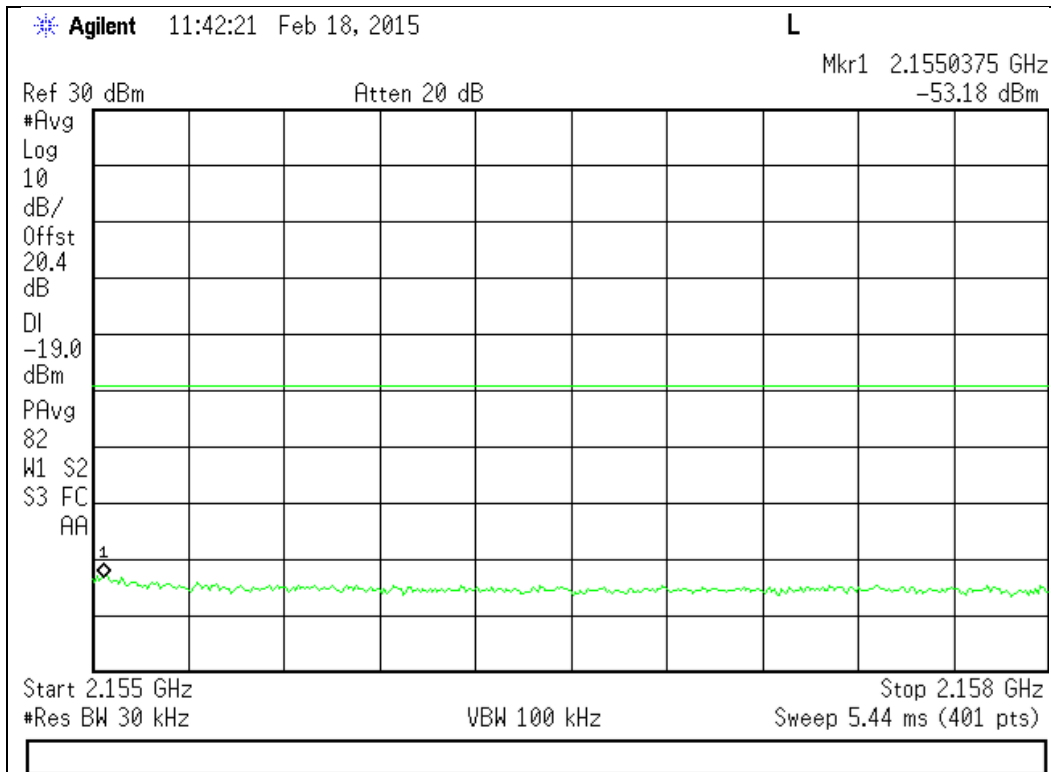

**WCDMA Downlink Test Plots**  
**728 - 746 MHz Band**  
**Lower Band Edge**

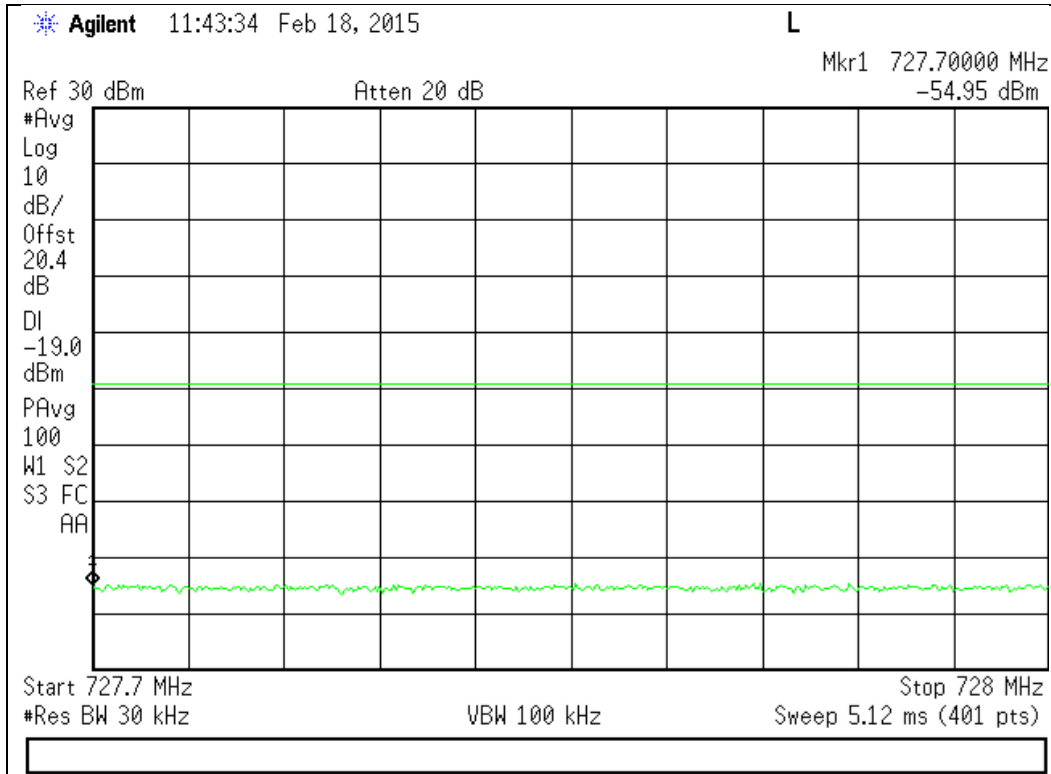

**Upper Band Edge**

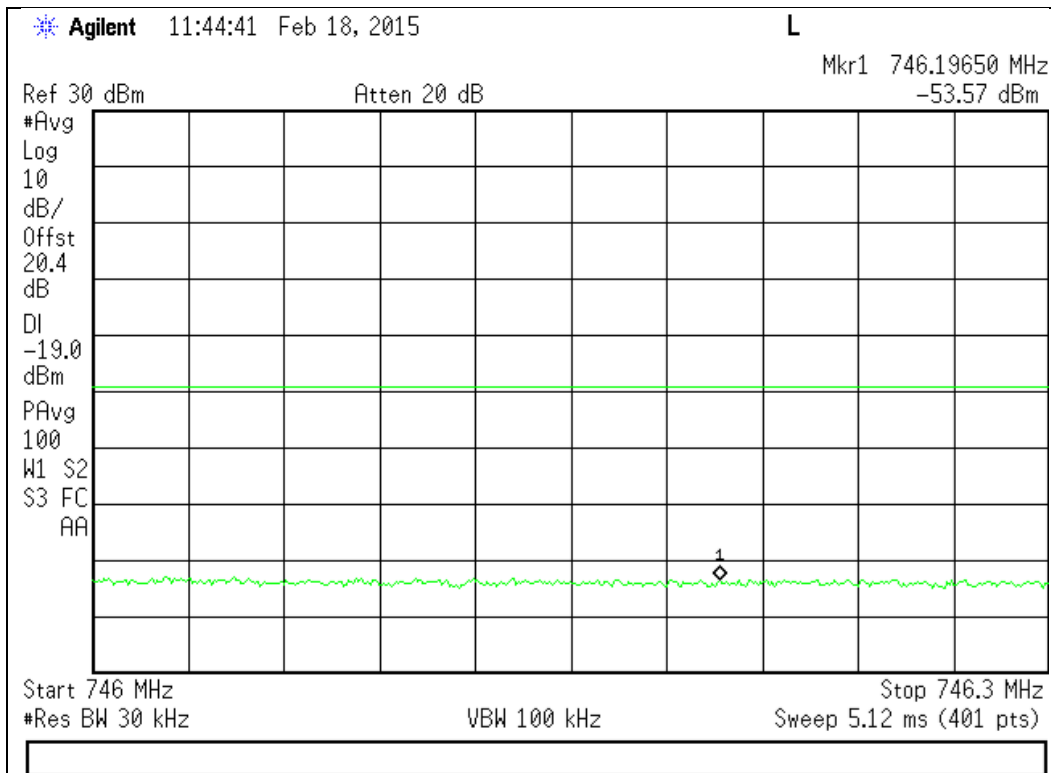



746 - 757 MHz Band

Lower Band Edge

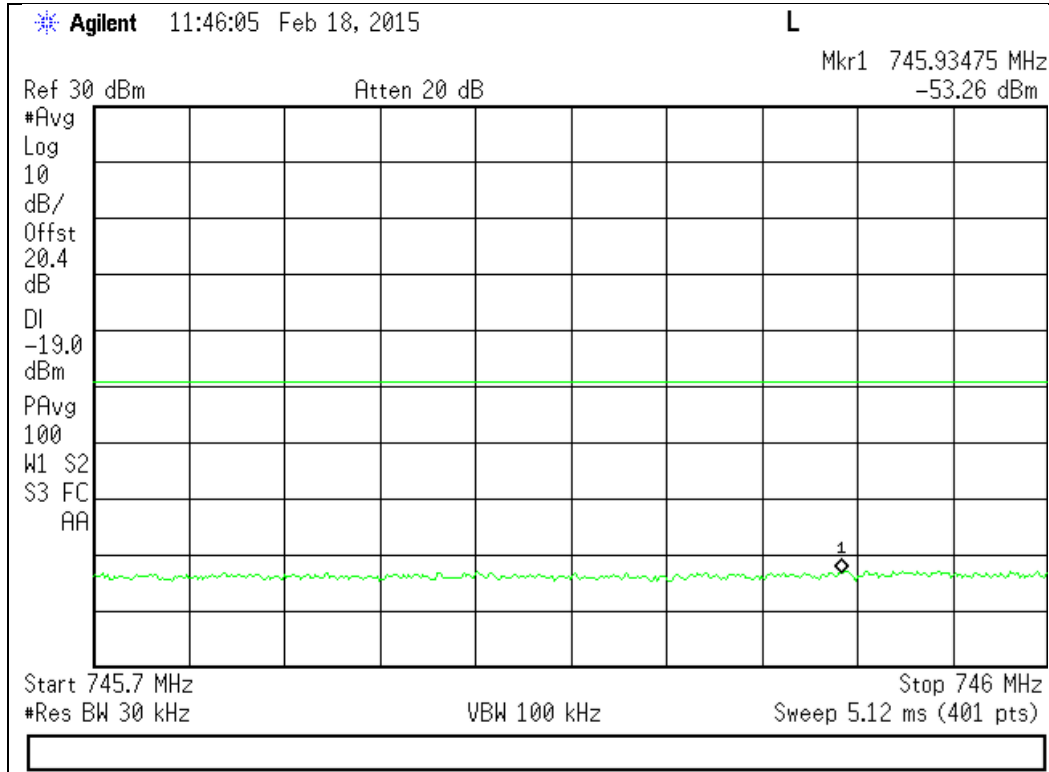

Upper Band Edge

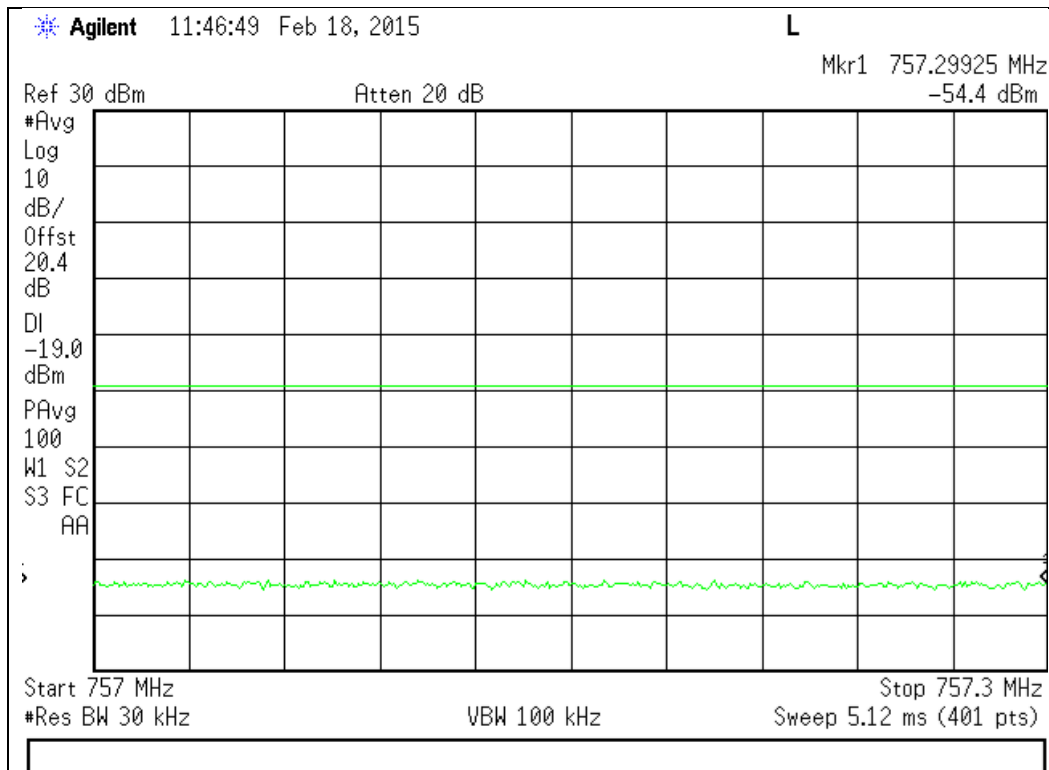

869 - 894 MHz Band

Lower Band Edge

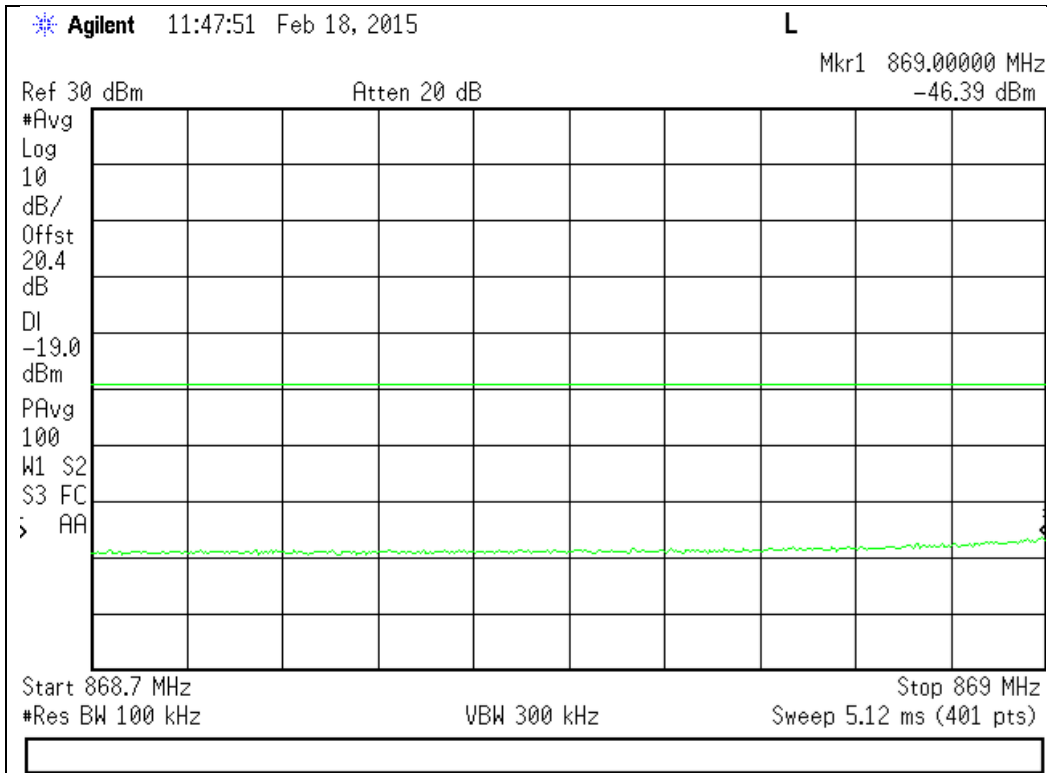

Upper Band Edge

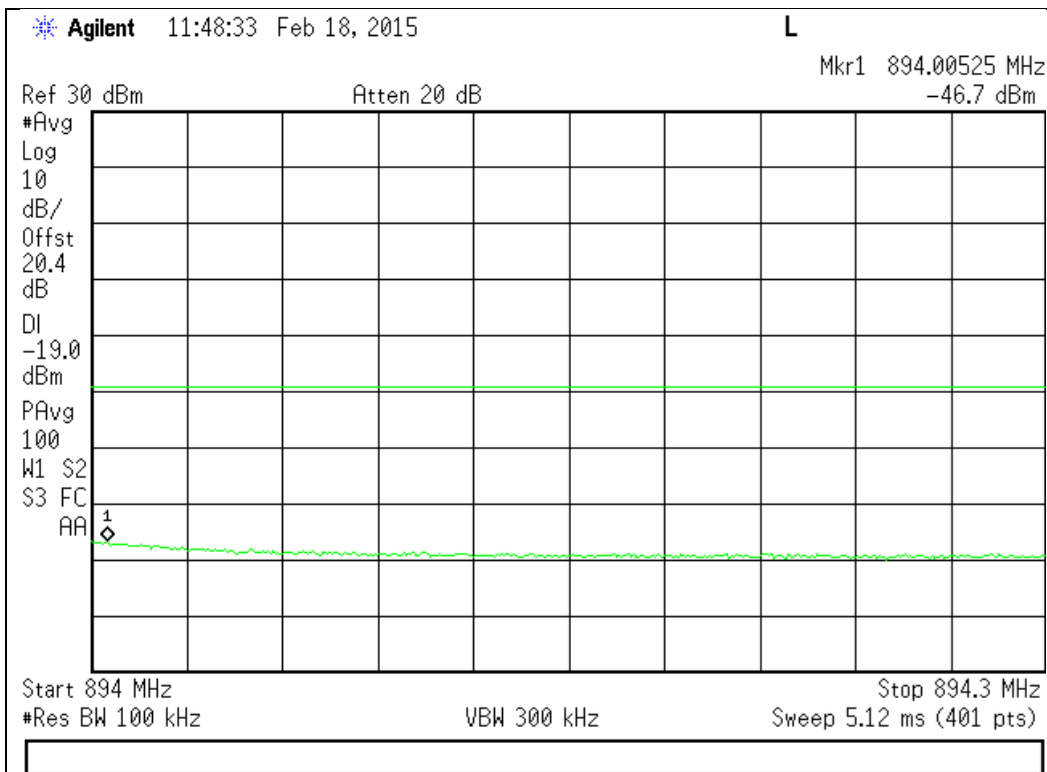

1930 - 1990 MHz Band

Lower Band Edge

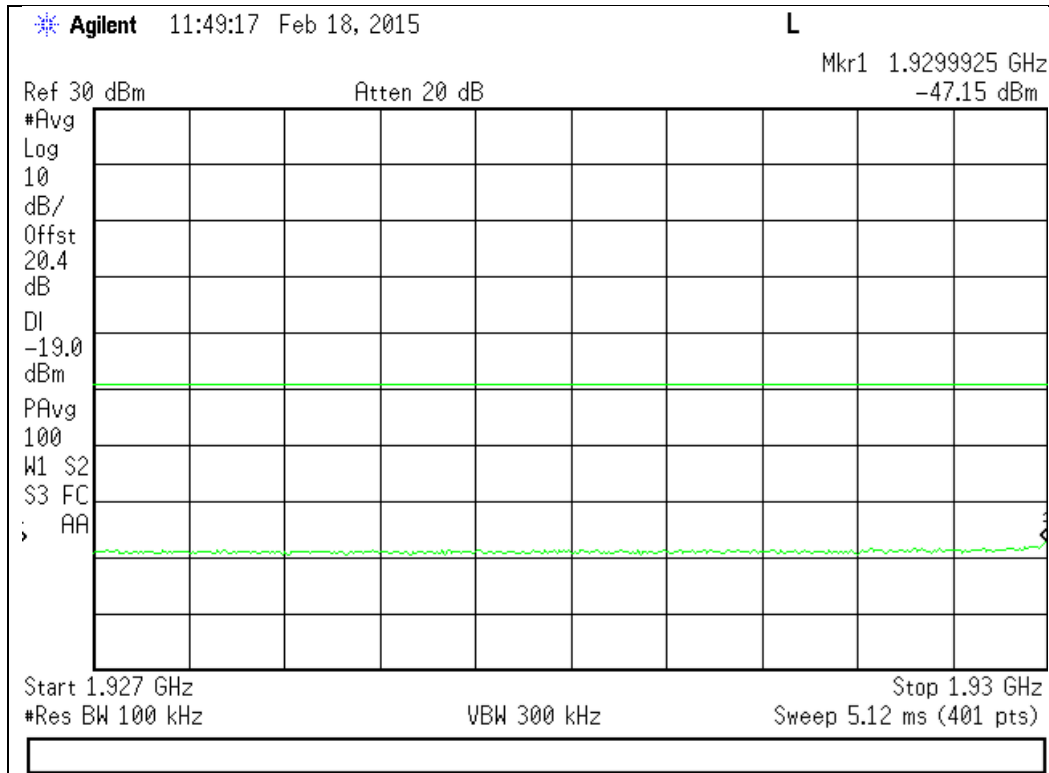

Upper Band Edge

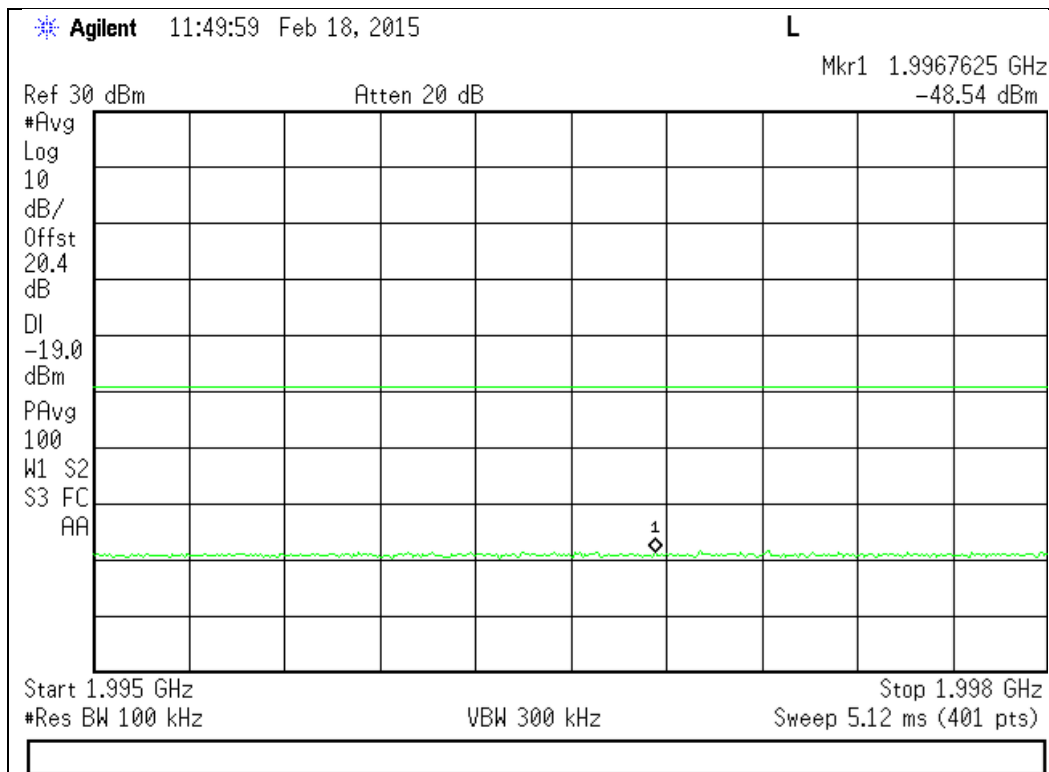

2110 - 2155 MHz Band

Lower Band Edge

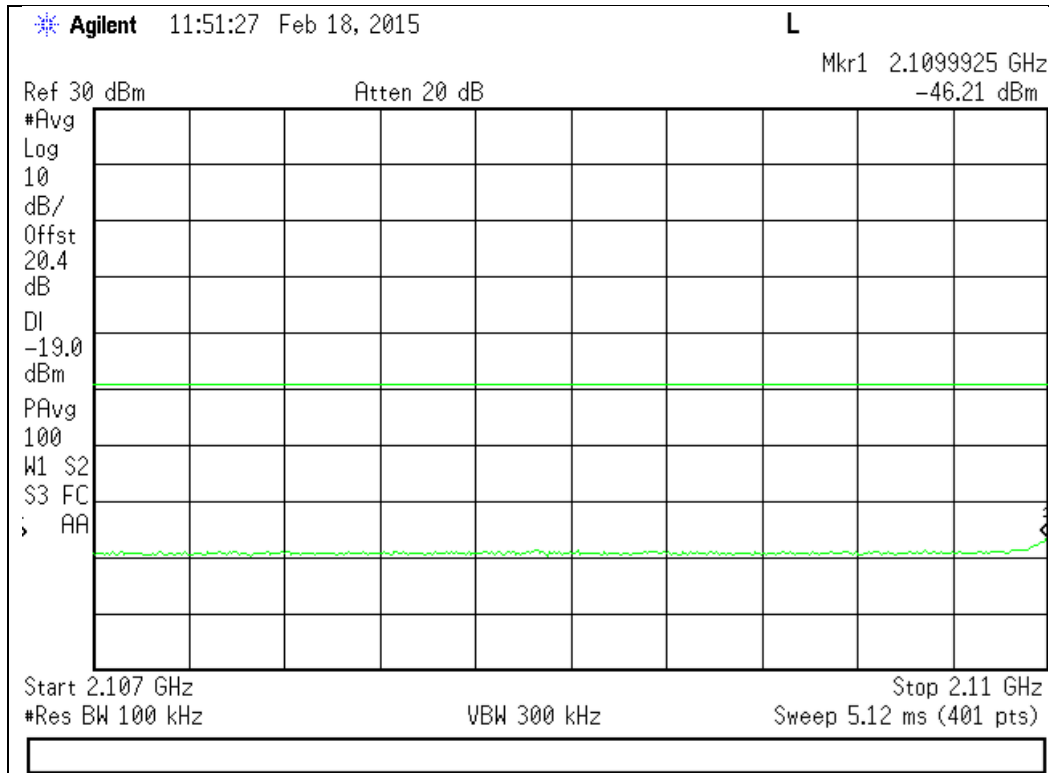

Upper Band Edge

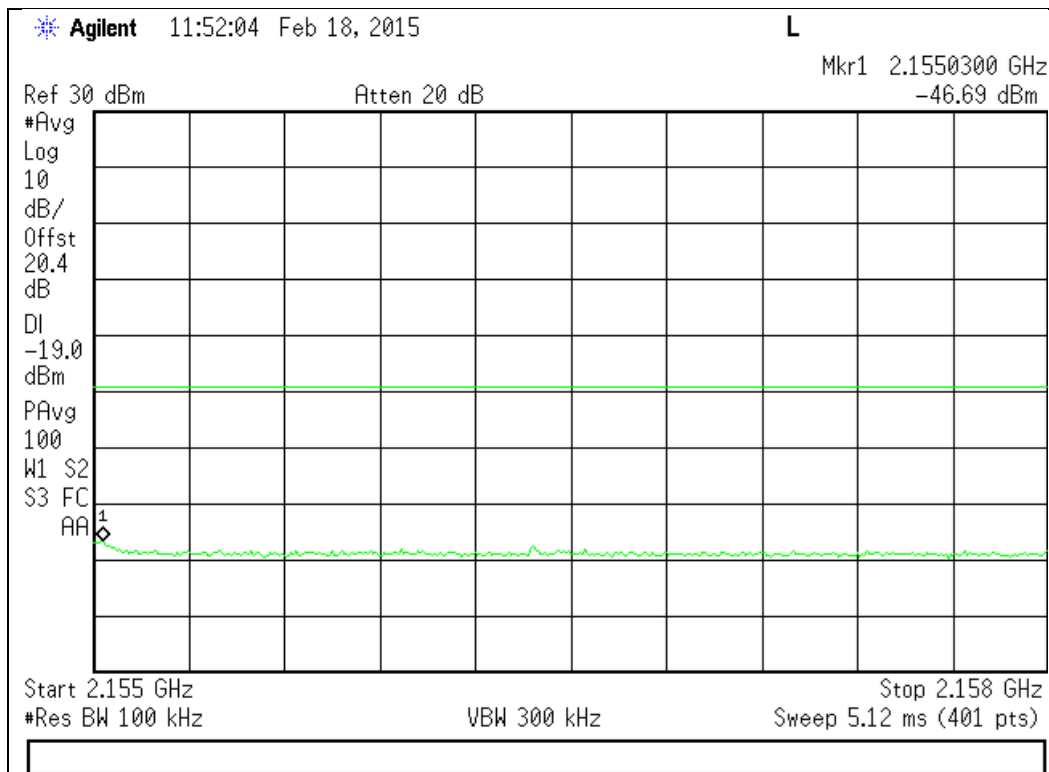

## Conducted Spurious Emissions

**Engineer:** Mike Graffeo

**Test Date:** 2/18/15

### Test Procedure

The EUT was connected to a spectrum analyzer through an attenuator, with the losses being input into the spectrum analyzer as a combination of reference level offset and correction factor as needed to ensure accurate readings. A signal generator was utilized to produce a 4.1 MHz AWGN signal operating at the maximum allowable power. The conducted spurious emissions from 9 kHz to 10 times the highest tunable frequency for each operational band were measured (excluding the band defined by the Out of band emissions test). The emissions were plotted and the highest level was recorded in the summary table.

The following formulas are used for calculating the limits.

Conducted Spurious Emissions Limit =  $P1 - (43 + 10\text{Log}(P2)) = -13 \text{ dBm}$

P1 = power in dBm

P2 = power in Watts

### Test Setup

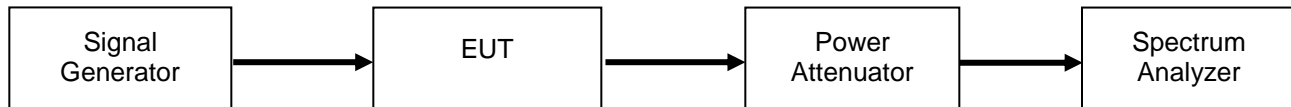

For the 746 – 758 downlink and 776 – 788 Uplink bands of operation, the following additional spurious emissions requirements apply.

**FCC 27.53(c)**

For operations in the 746-758 MHz band and the 776-788 MHz band, the power of any emission outside the licensee's frequency band(s) of operation shall be attenuated below the transmitter power (P) within the licensed band(s) of operation, measured in watts, in accordance with the following:

- (4) On all frequencies between 763-775 MHz and 793-805 MHz, by a factor not less than  $65 + 10 \log (P)$  dB in a 6.25 kHz band segment, for mobile and portable stations;

The test is performed using a 10 kHz RBW. Since the limit is referenced to a 6.25 kHz BW, the following correction factor is applied to the measured data.

BW correction Factor =  $10\log B1/B2$

BW correction Factor =  $10\log 6.25 / 10 = - 2.0$  dB

Final Value (dBm) = conducted measurement +BW correction factor

**776 – 787 MHz Uplink Band**

Spurious Frequency Range (MHz)	Measured Frequency (MHz)	Measured Value (dBm)	Bandwidth Correction Factor (dB)	Final Value (dBm)	Limit (dBm)	Margin (dB)
763 – 775	774.99	-60.58	-2.0	-62.62	-35	-27.62
793 – 805	793.23	-63.08	-2.0	-65.12	-35	-30.12

**746 - 757 MHz Downlink Band**

Spurious Frequency Range (MHz)	Measured Frequency (MHz)	Measured Value (dBm)	Bandwidth Correction Factor (dB)	Final Value (dBm)	Limit (dBm)	Margin (dB)
763 – 775	765.59	-66.39	-2.0	-68.43	-35	-33.43
793 – 805	794.3	-65.79	-2.0	-67.83	-35	-32.83

**FCC 27.53(f)**

For operations in the 746-758 MHz, 775-788 MHz, and 805-806 MHz bands, emissions in the band 1559-1610 MHz shall be limited to -70 dBW/MHz equivalent isotropically radiated power (EIRP) for wideband signals, and -80 dBW EIRP for discrete emissions of less than 700 Hz bandwidth. For the purpose of equipment authorization, a transmitter shall be tested with an antenna that is representative of the type that will be used with the equipment in normal operation.

Since the limit is referenced to EIRP, the final data is computed using the Conducted Spurious Emission data and adding the BW correction factor plus the final gain/loss data from the antenna kitting information supplied by the manufacturer.

For the Narrowband measurement, the test is performed using a 10 kHz RBW. Since the limit is referenced to a 700 Hz BW, the following correction factor is applied to the measured data.

BW correction Factor =  $10\log B1/B2$

BW correction Factor =  $10\log 700 / 10000 = -11.55 \text{ dB}$

Final Value (dBm) = conducted measurement + BW correction factor + final gain/loss from Antenna Kitting document

The Limit for discreet (narrowband) emissions is -80dBW (-50 dBm) in 700 MHz BW.

The Limit for (wideband Emissions) is -70 dBW (-40 dBm) in a 1 MHz BW.

**776 – 787 MHz Uplink Band**

Spurious Frequency Range (MHz)	Measured Frequency (MHz)	Measured Value (dBm)	Bandwidth Correction Factor (dB)	Gain/Loss from Antenna Kitting Information (dB)	Final Value (dBm)	Limit (dBm)	Margin (dB)
1559 – 1610 (Wideband)	1562.02	-43.74	0	1.66	-42.08	-40	-2.08
1559 – 1610 (Narrowband)	1489.8	-63.62	-11.55	1.66	-73.51	-50	-23.51

**746 - 757 MHz Downlink Band**

Spurious Frequency Range (MHz)	Measured Frequency (MHz)	Measured Value (dBm)	Bandwidth Correction Factor (dB)	Gain/Loss from Antenna Kitting Information (dB)	Final Value (dBm)	Limit (dBm)	Margin (dB)
1559 – 1610 (Wideband)	1597.04	-43.88	0	-1.61	-45.49	-40	-5.49
1559 – 1610 (Narrowband)	1591.22	-61.59	-11.55	-1.61	-74.75	-50	-24.75

### Uplink Test Plots

#### 698 - 716 MHz Band

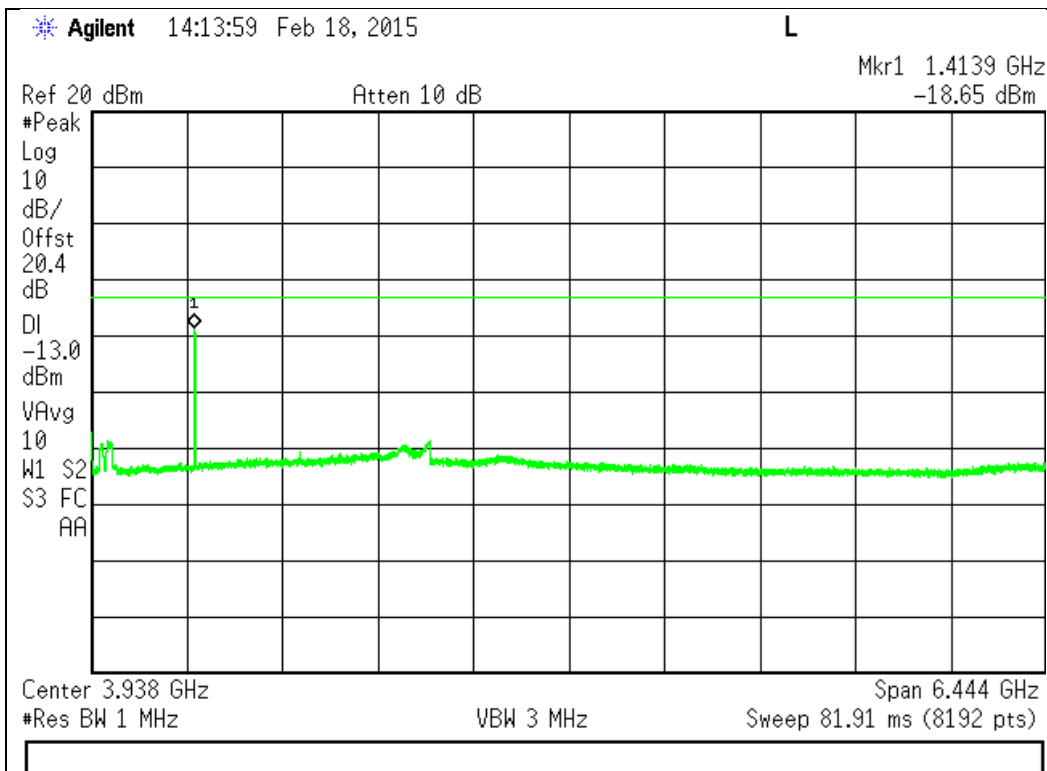
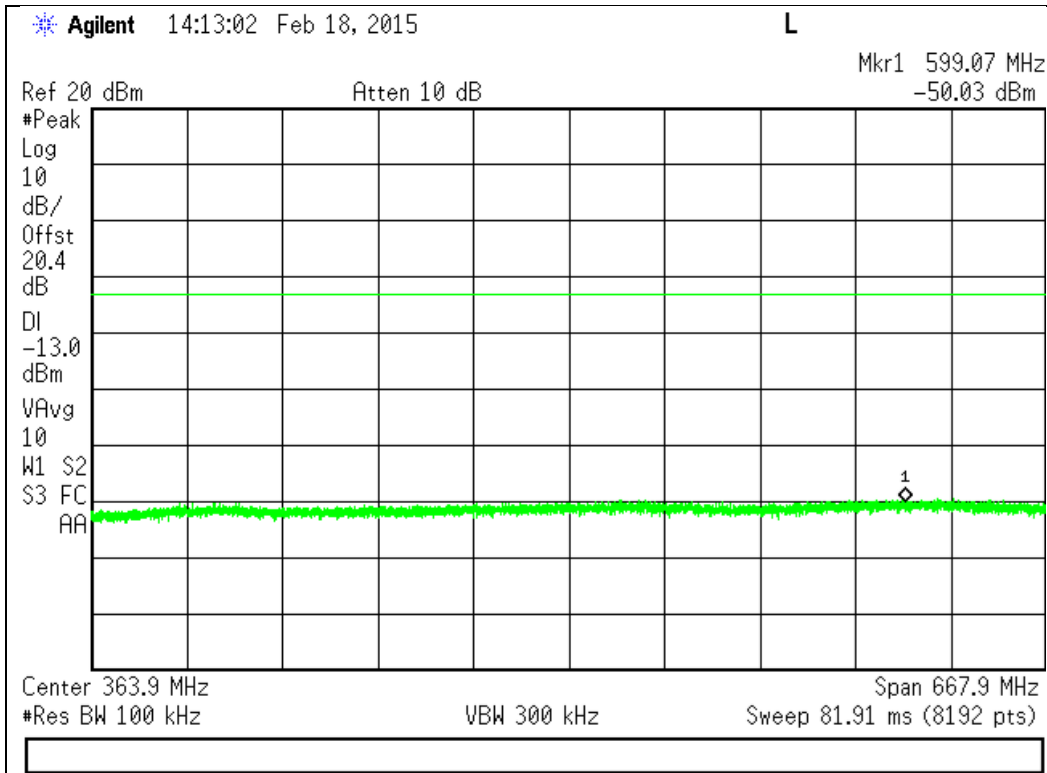



776 - 787 MHz Band

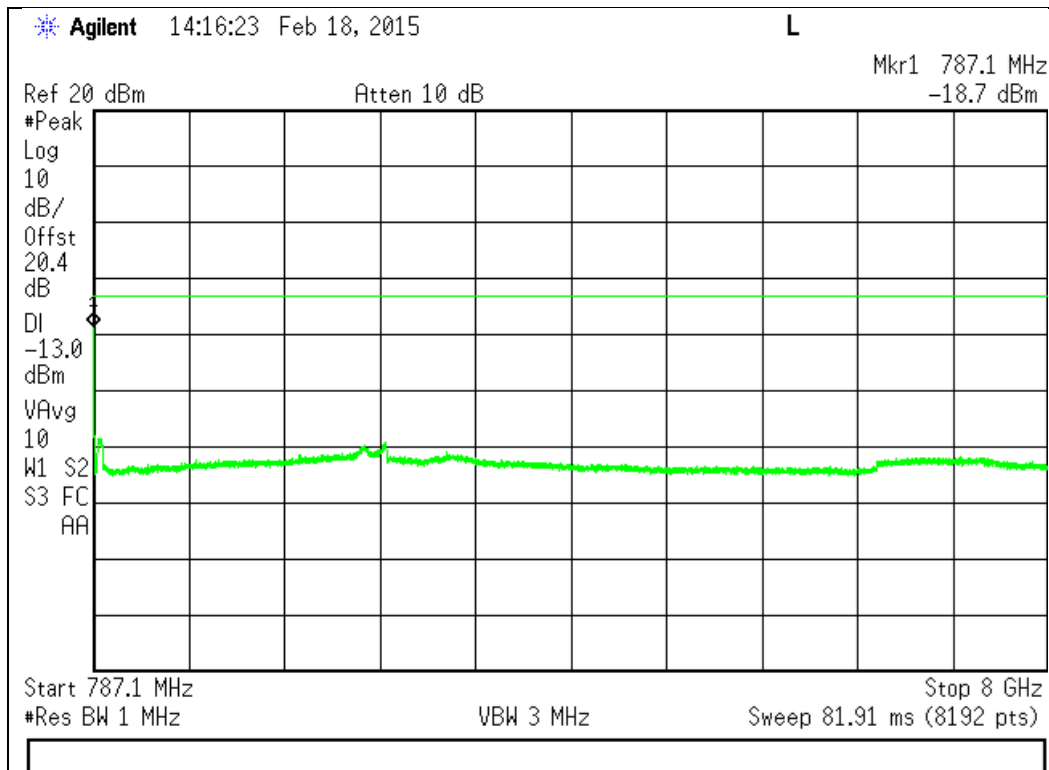
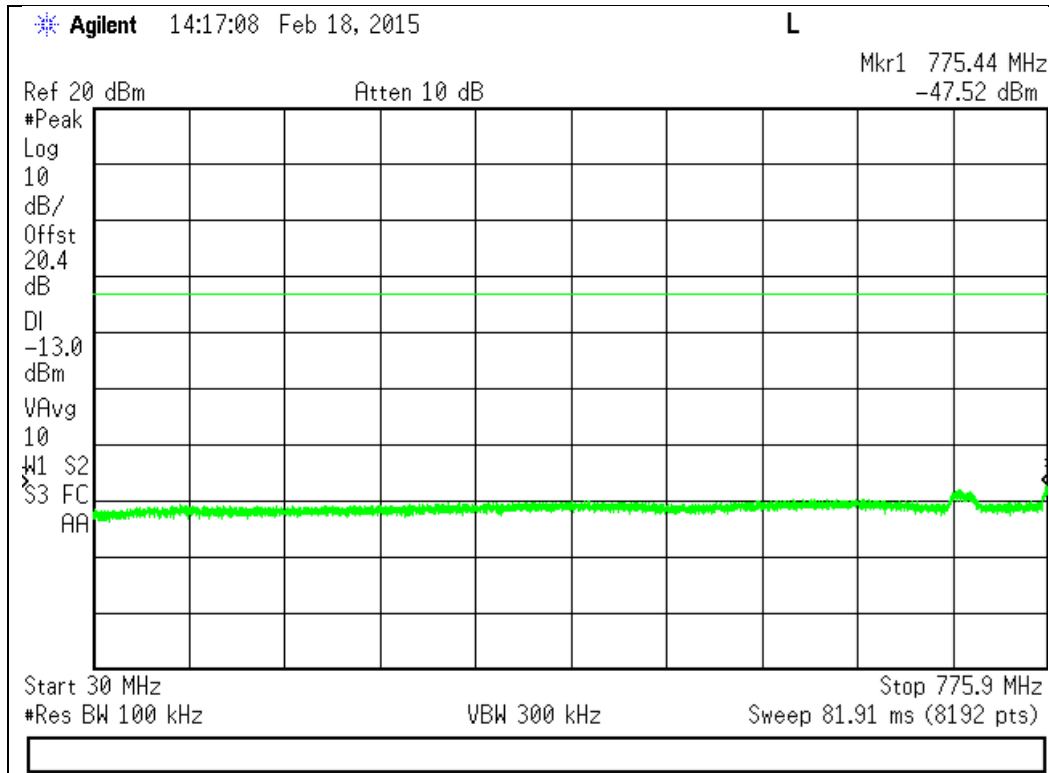

824 - 849 MHz Band

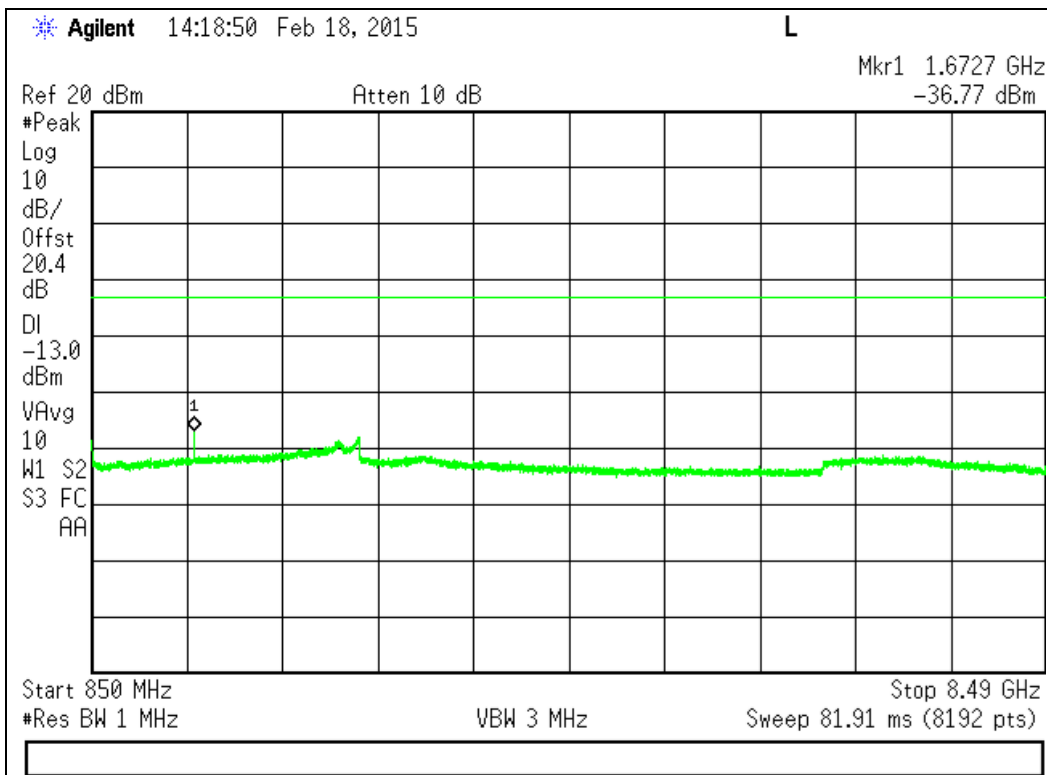
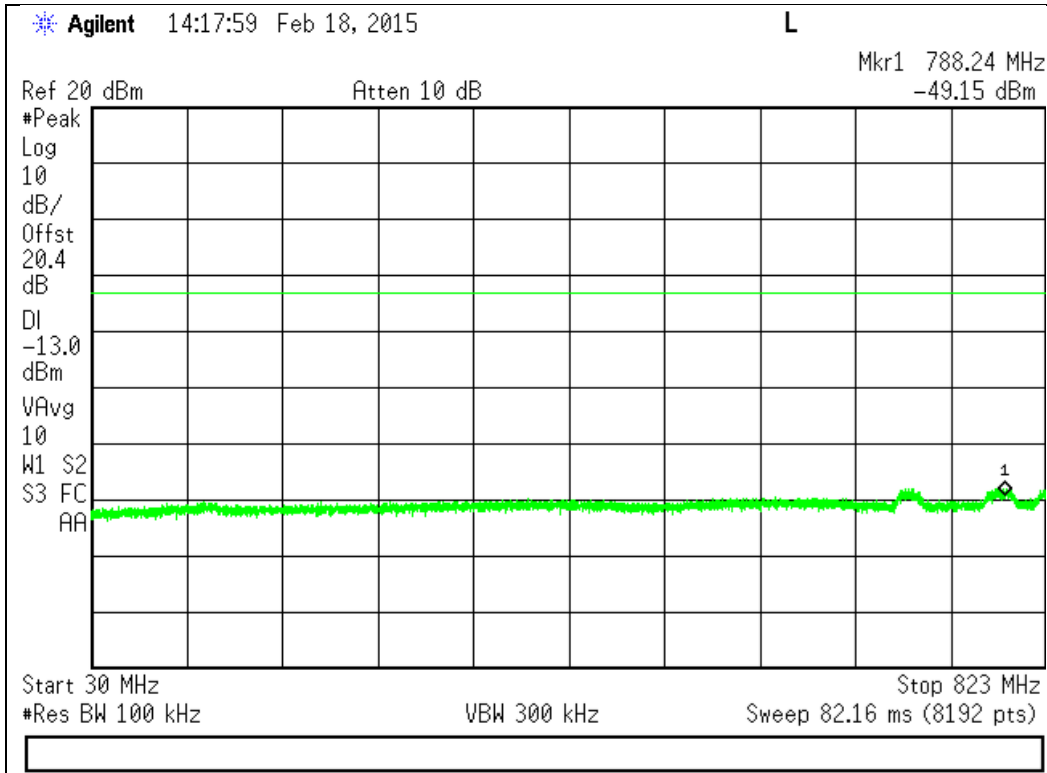

1710 - 1755 MHz Band

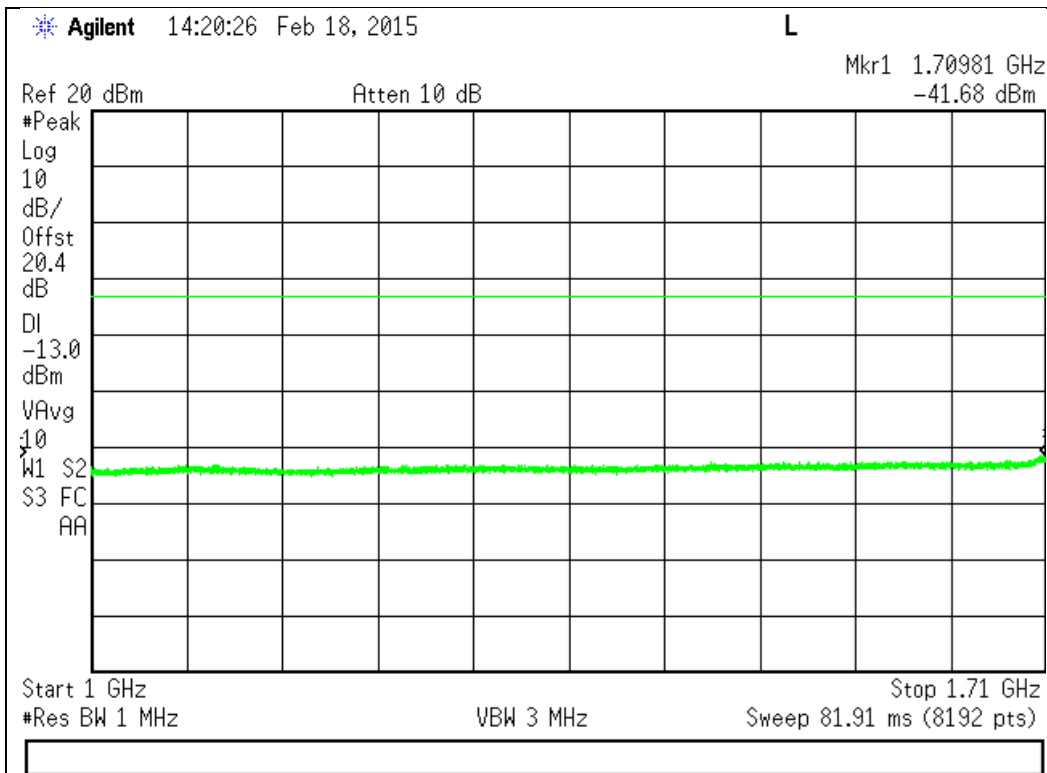
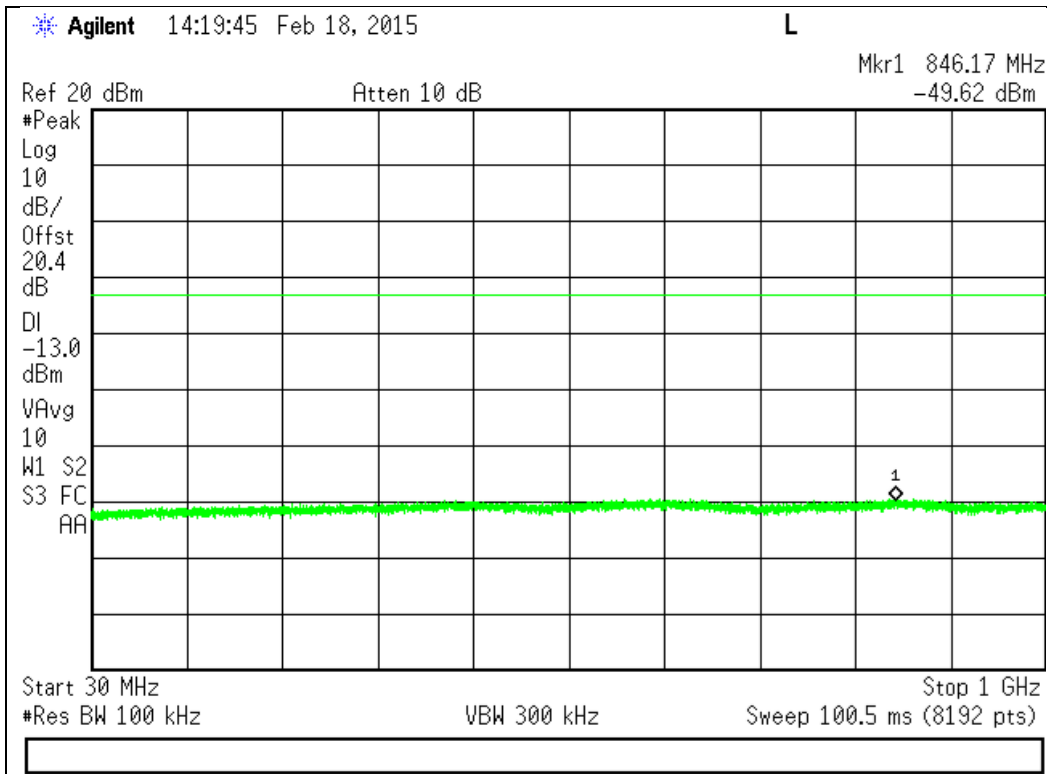

1710 - 1755 MHz Band (cont)

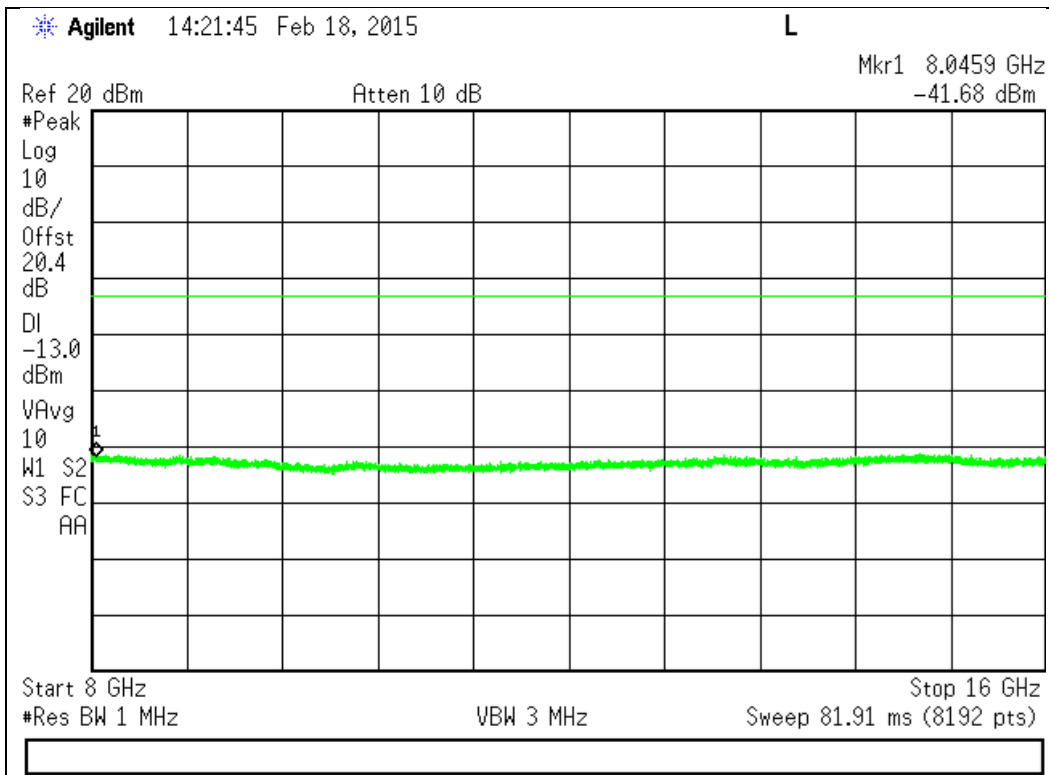
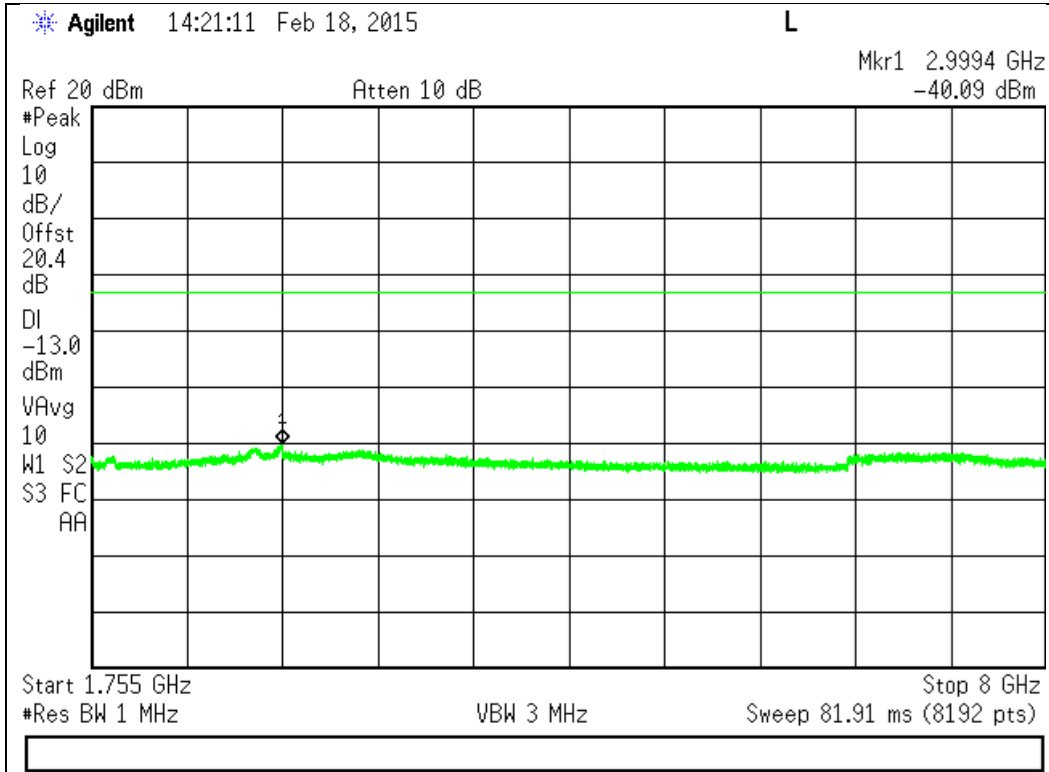

1710 - 1755 MHz Band (cont)

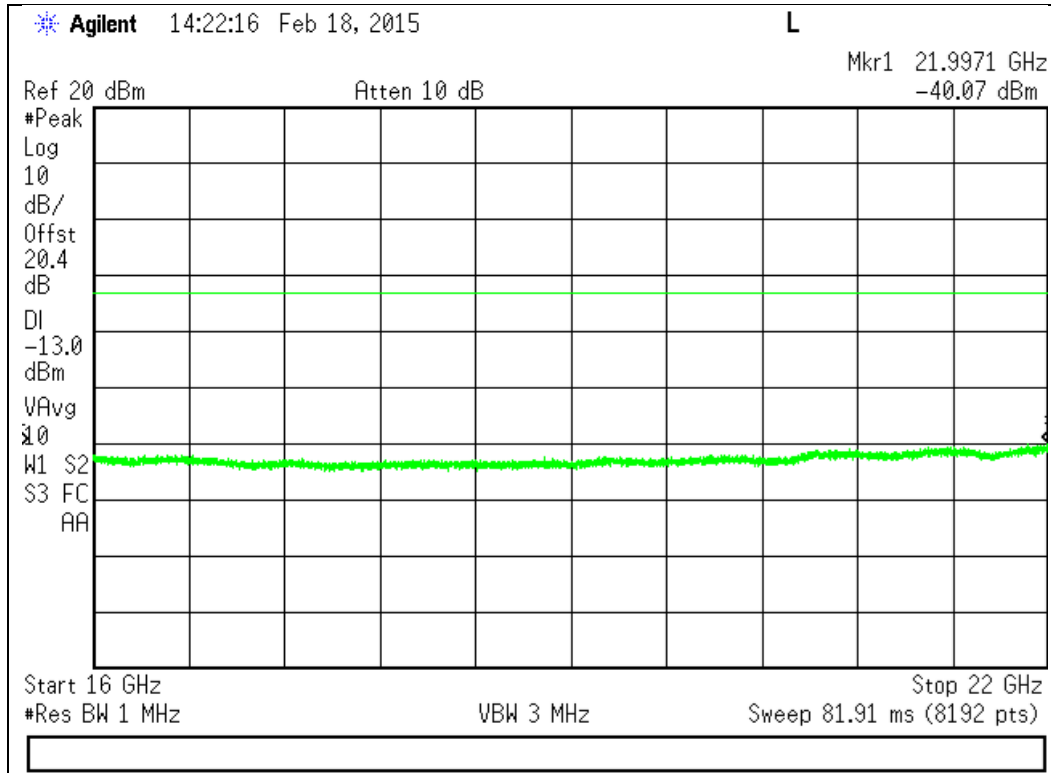

1850 - 1910 MHz Band

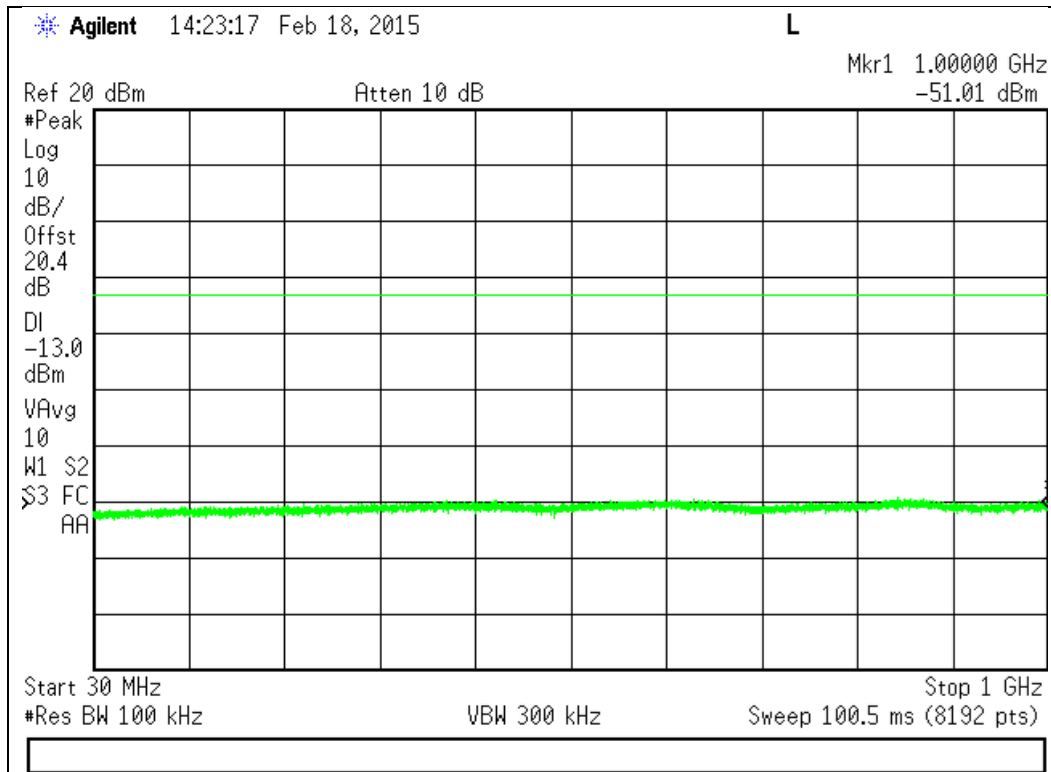

1850 - 1910 MHz Band (cont)

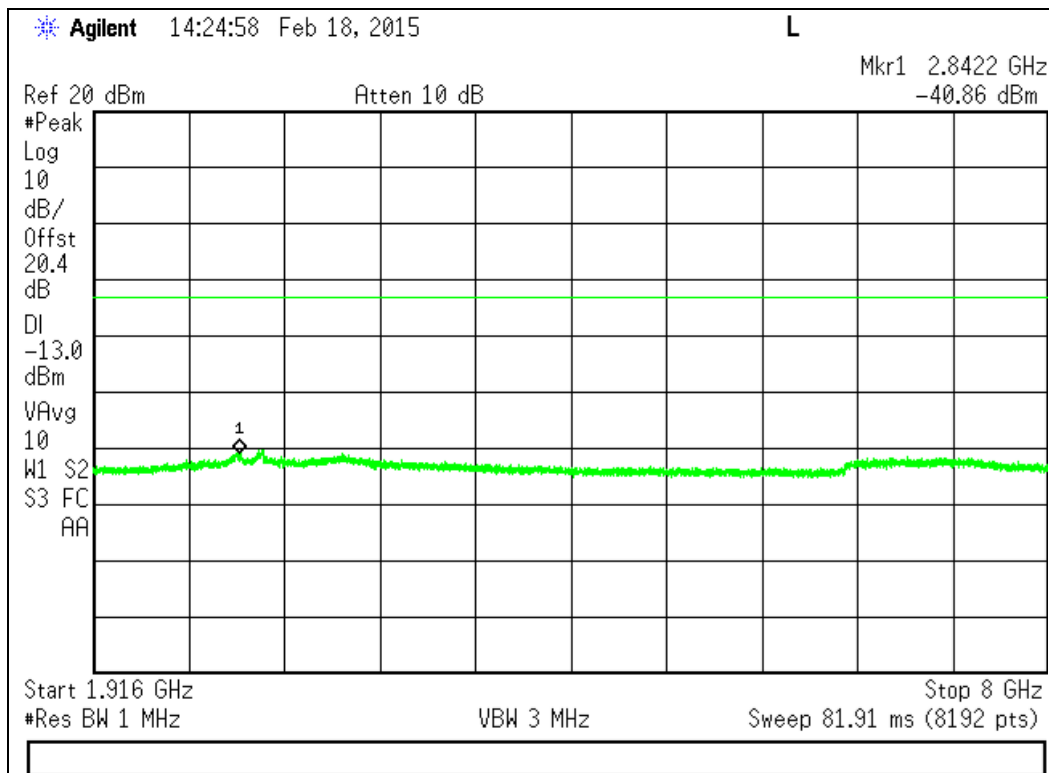
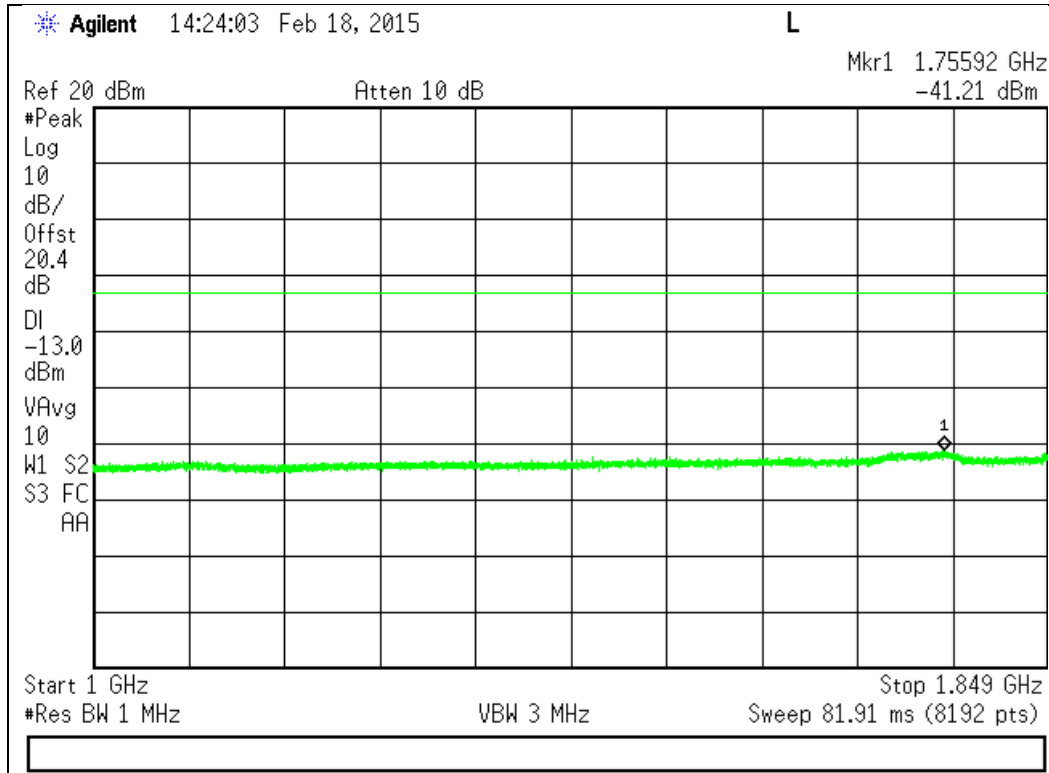

1850 - 1910 MHz Band (cont)

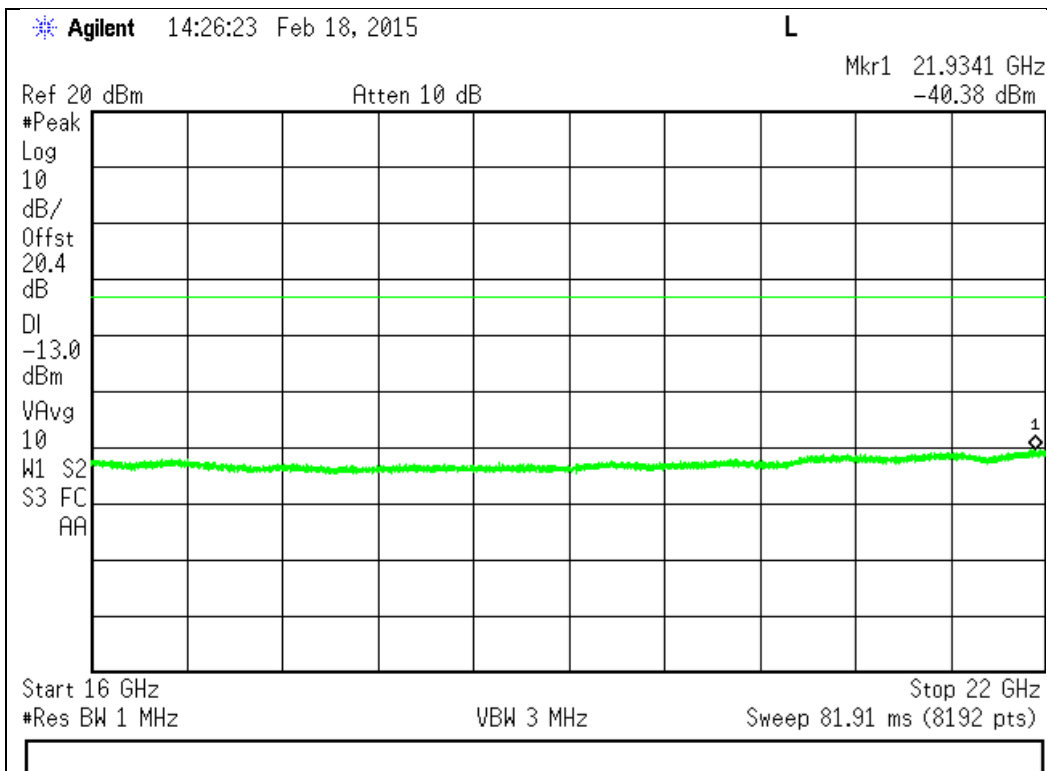
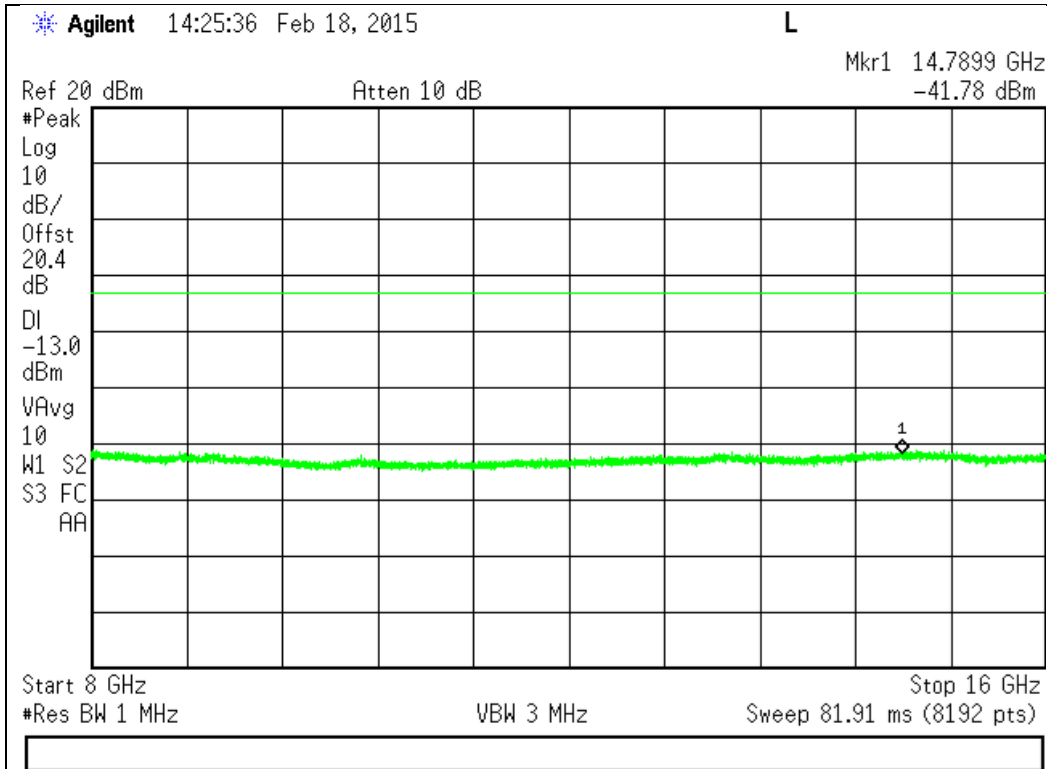

Downlink Test Plots

728 - 746 MHz Band

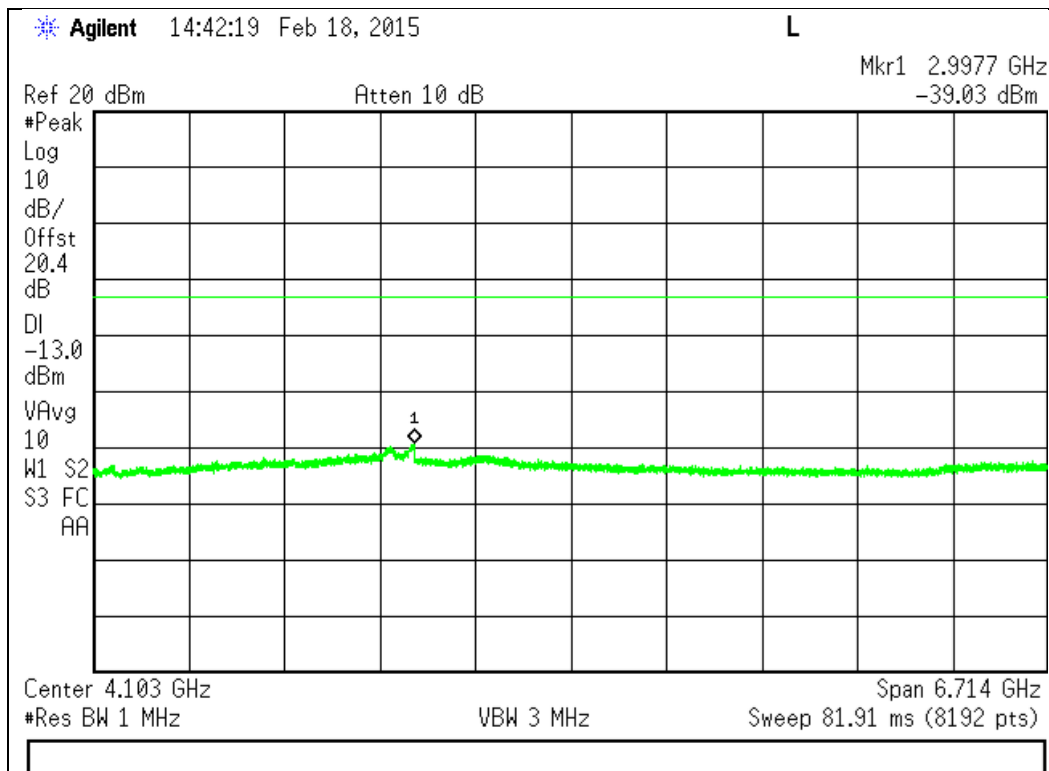
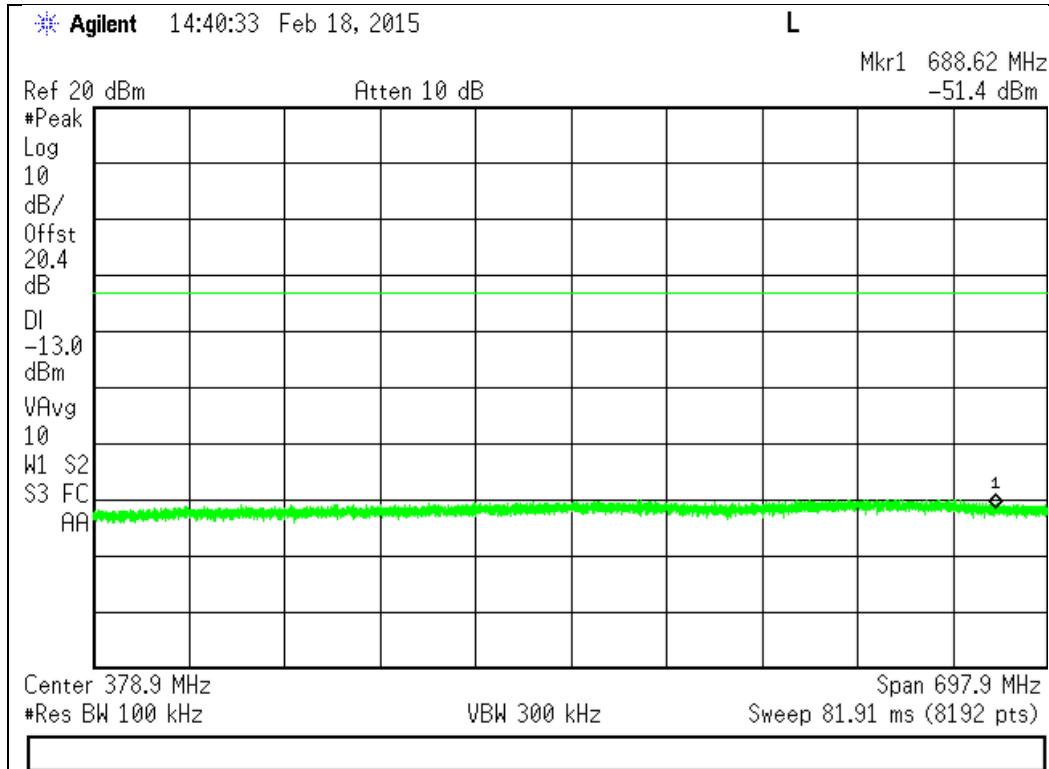



746 - 757 MHz Band

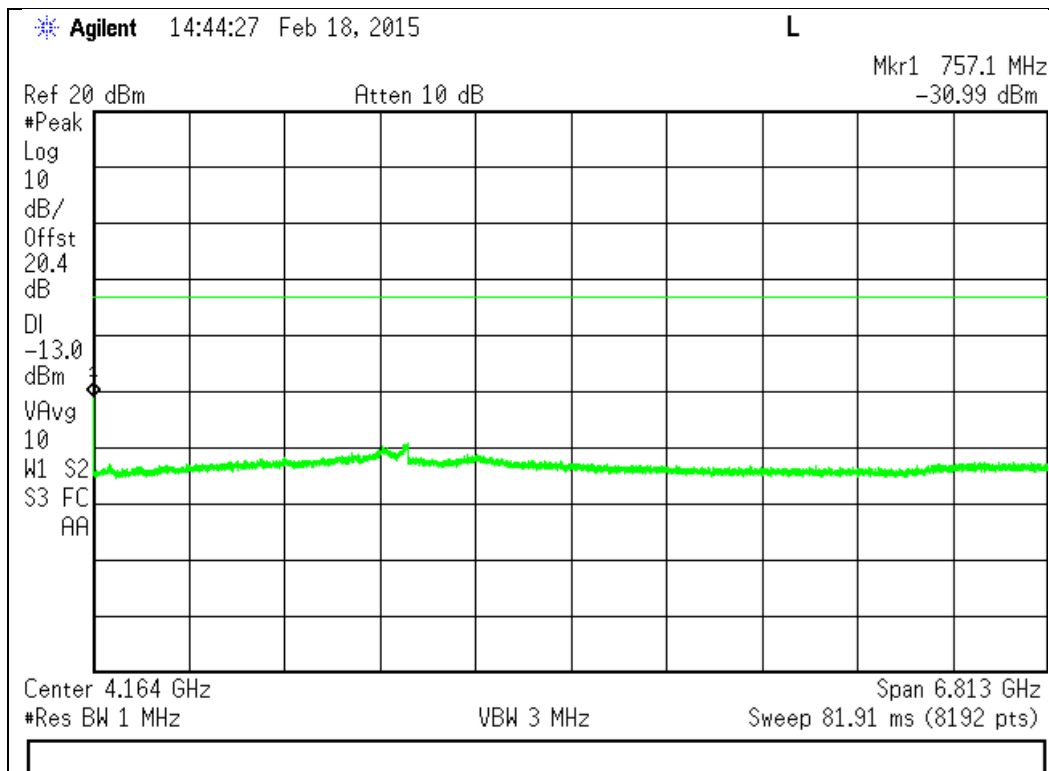
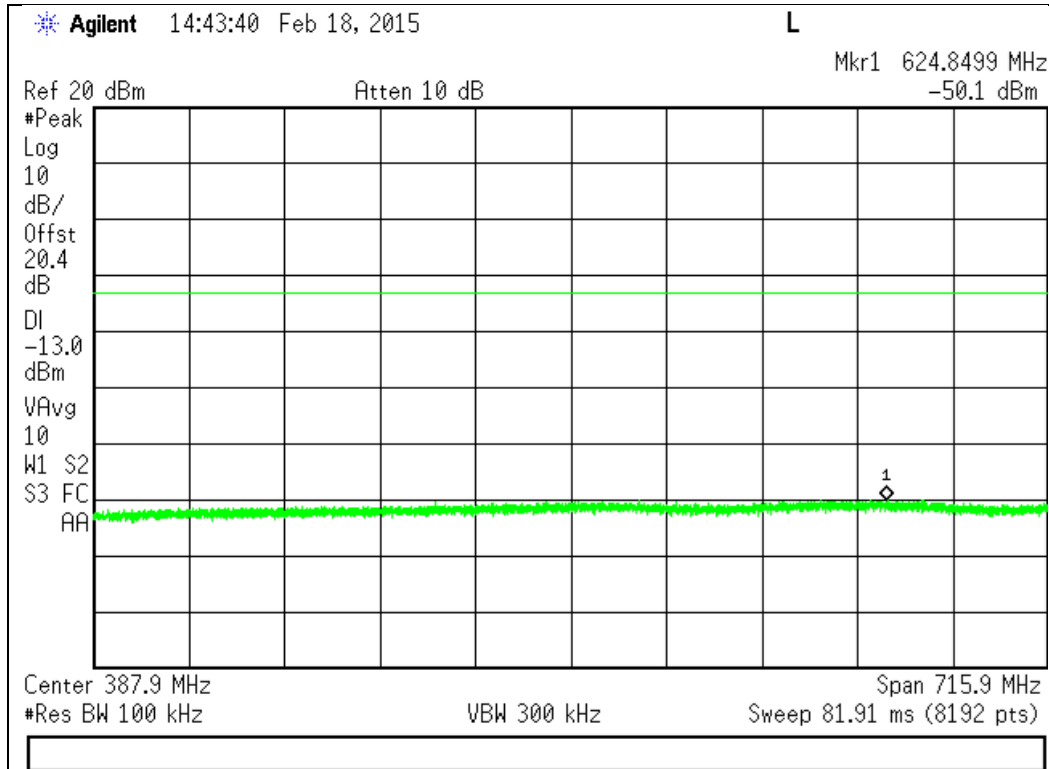

869 - 894 MHz Band

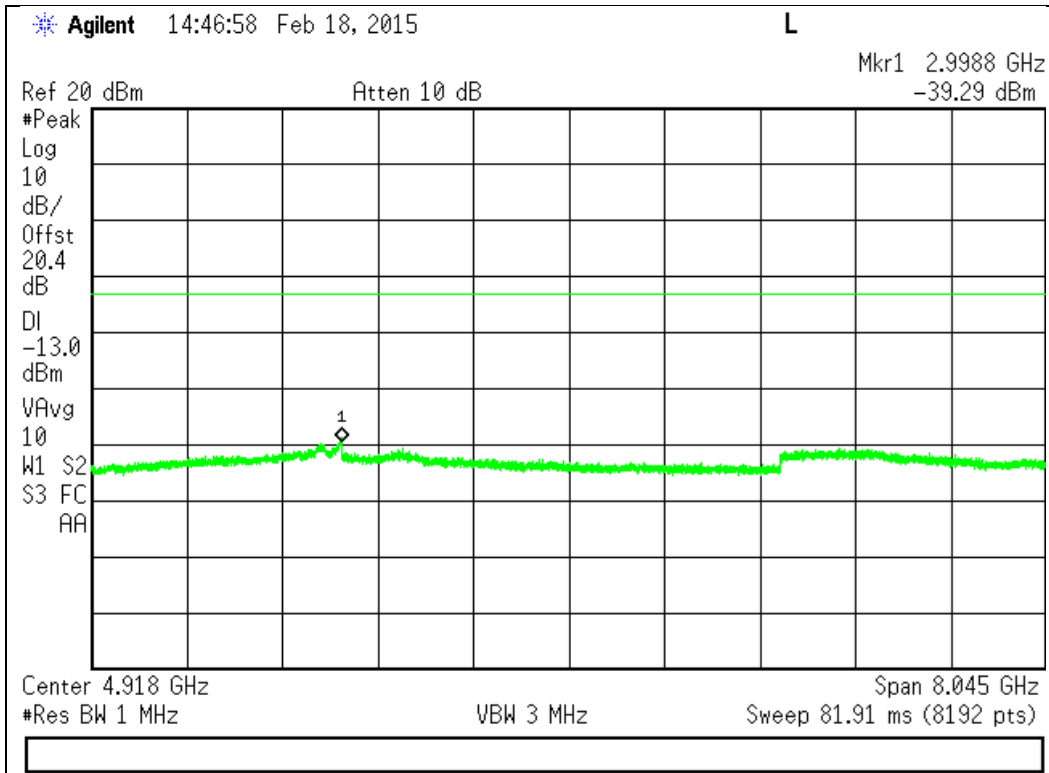
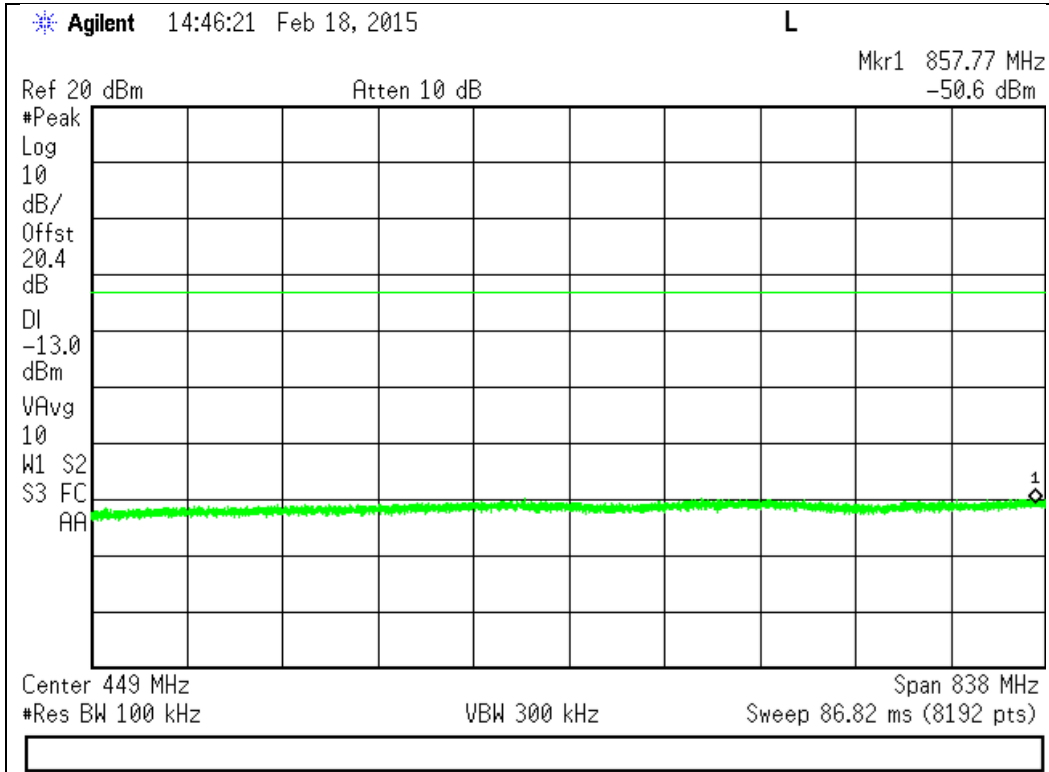

1930 - 1990 MHz Band

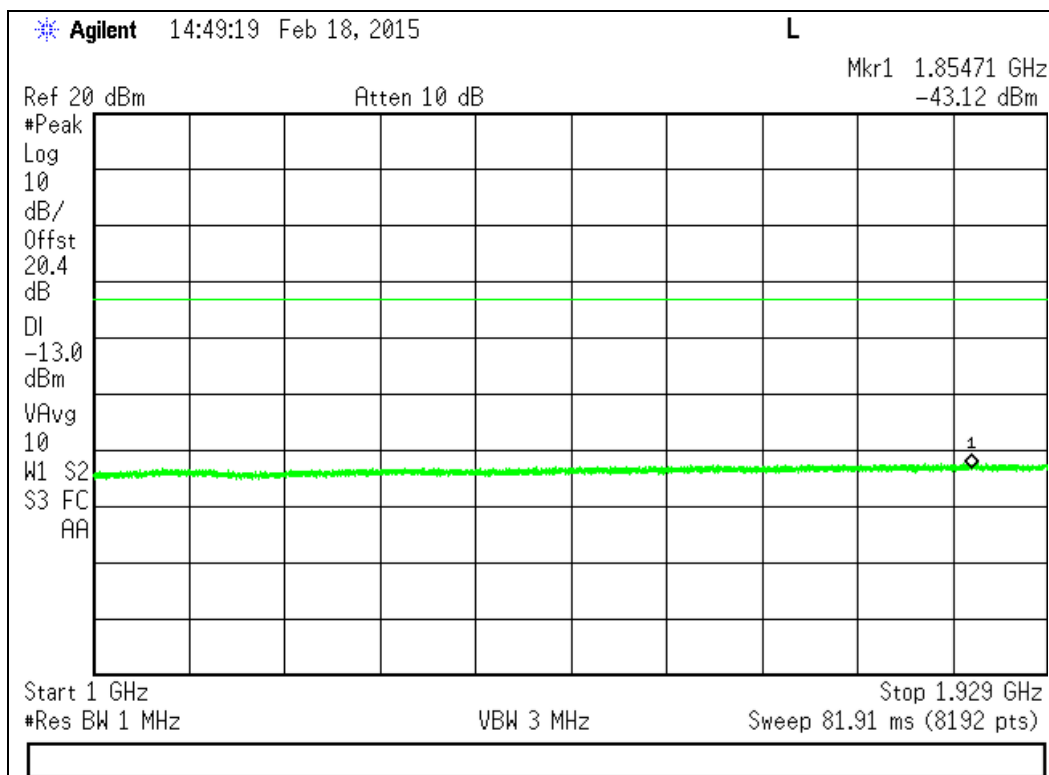
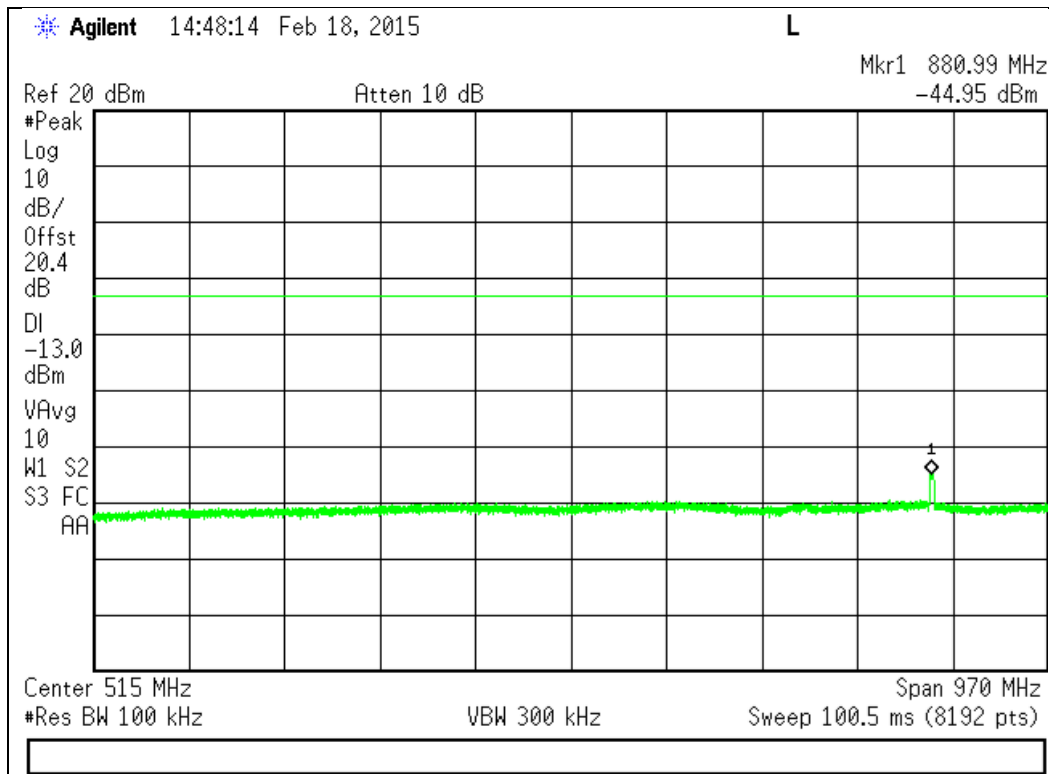

1930 - 1990 MHz Band (cont)

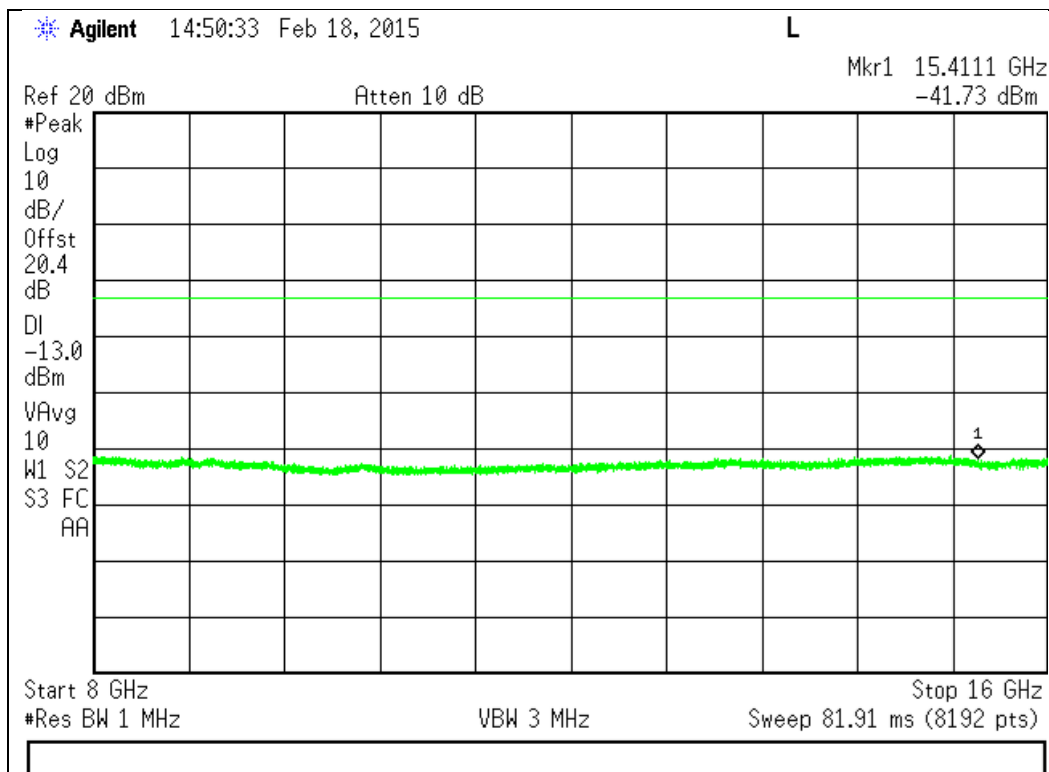
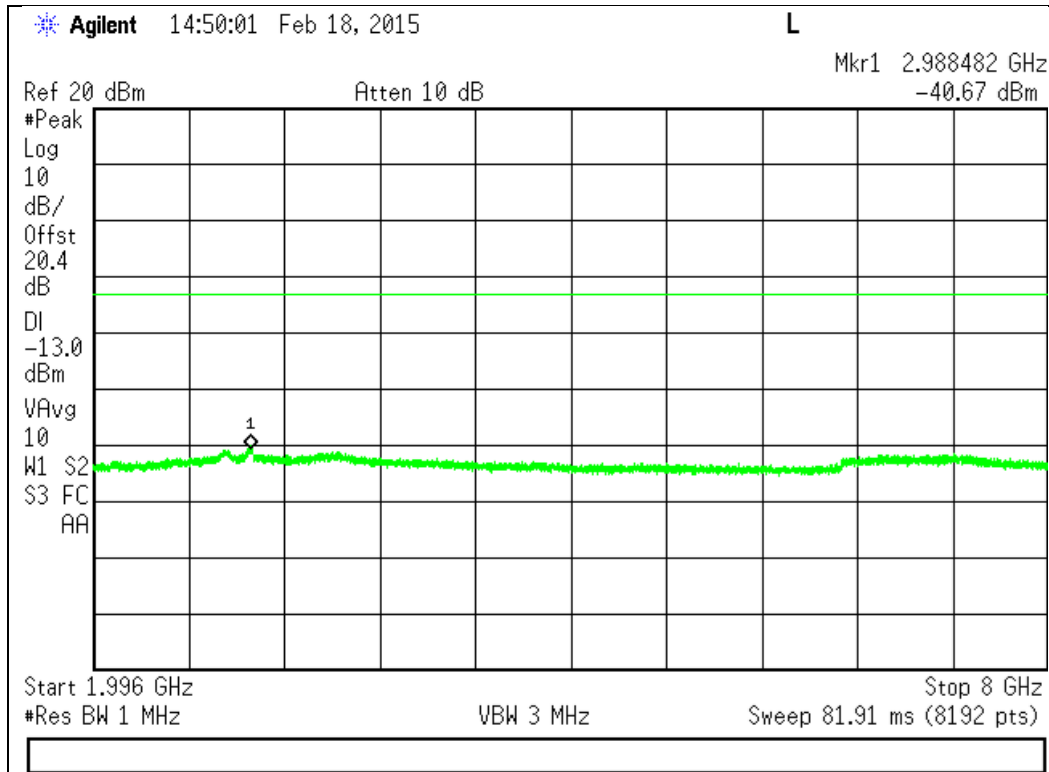

1930 - 1990 MHz Band (cont)

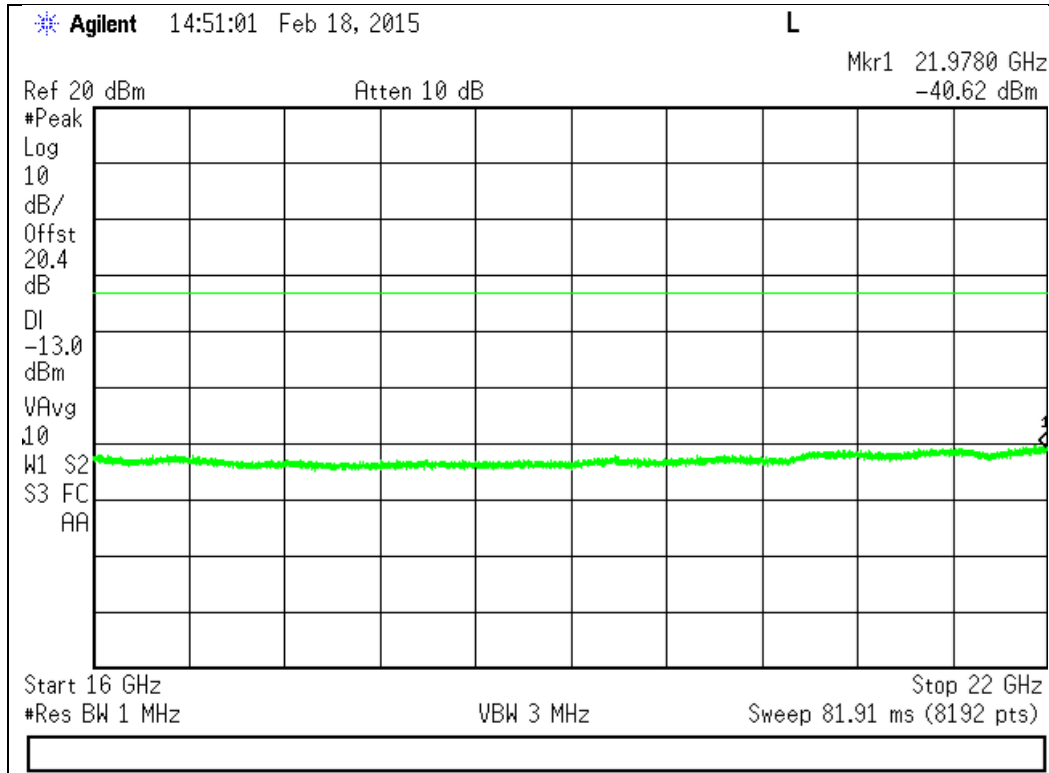

2110 - 2155 MHz Band

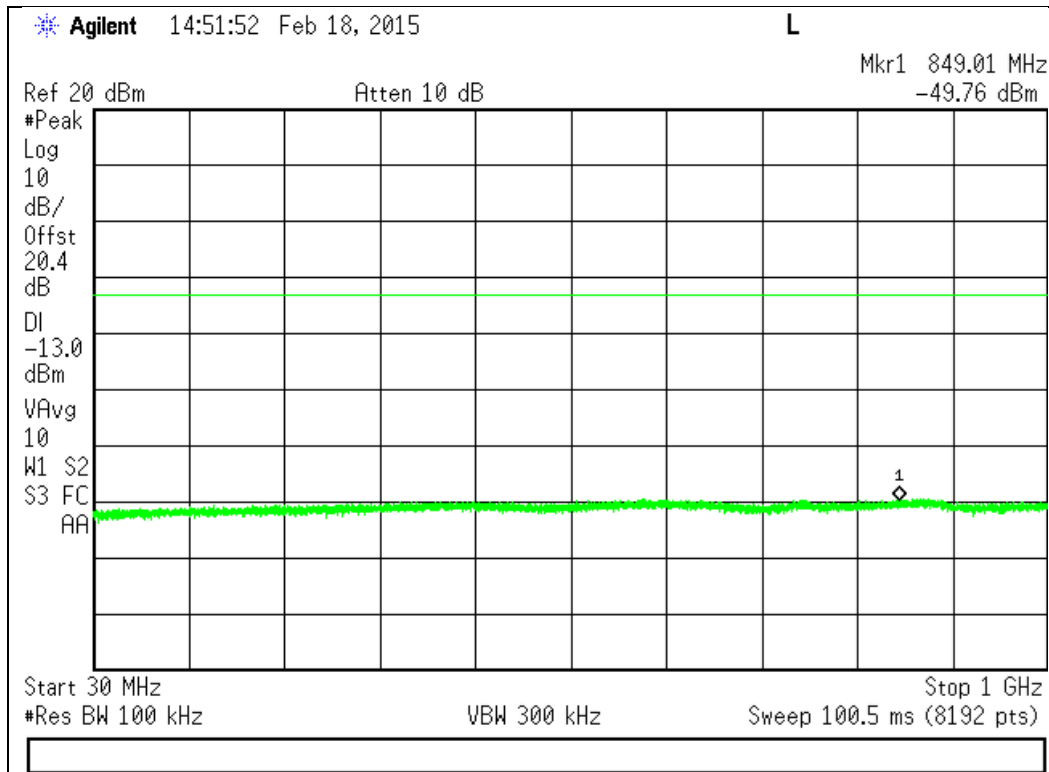

**2110 - 2155 MHz Band (cont)**

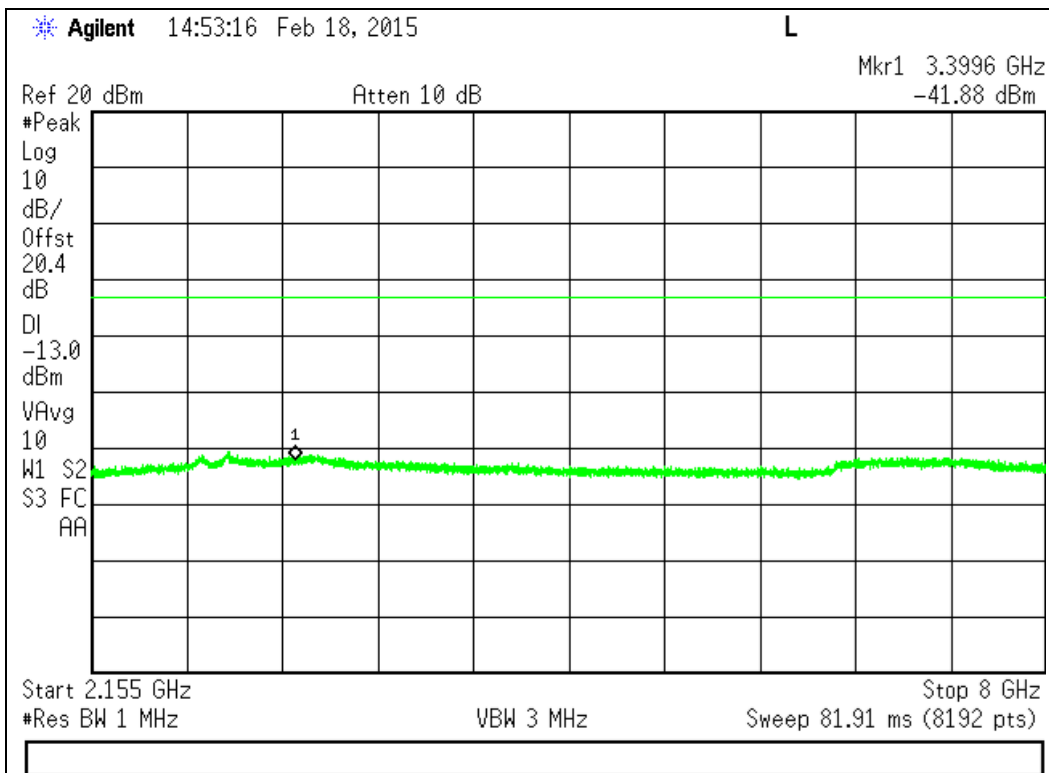
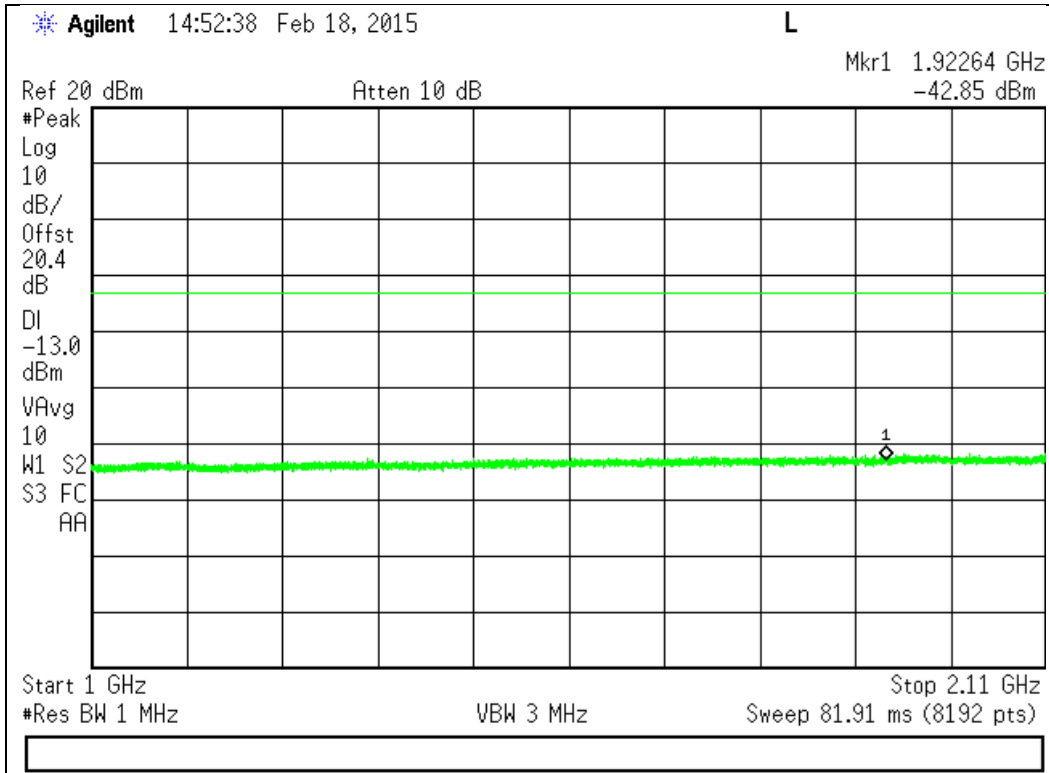

2110 - 2155 MHz Band (cont)

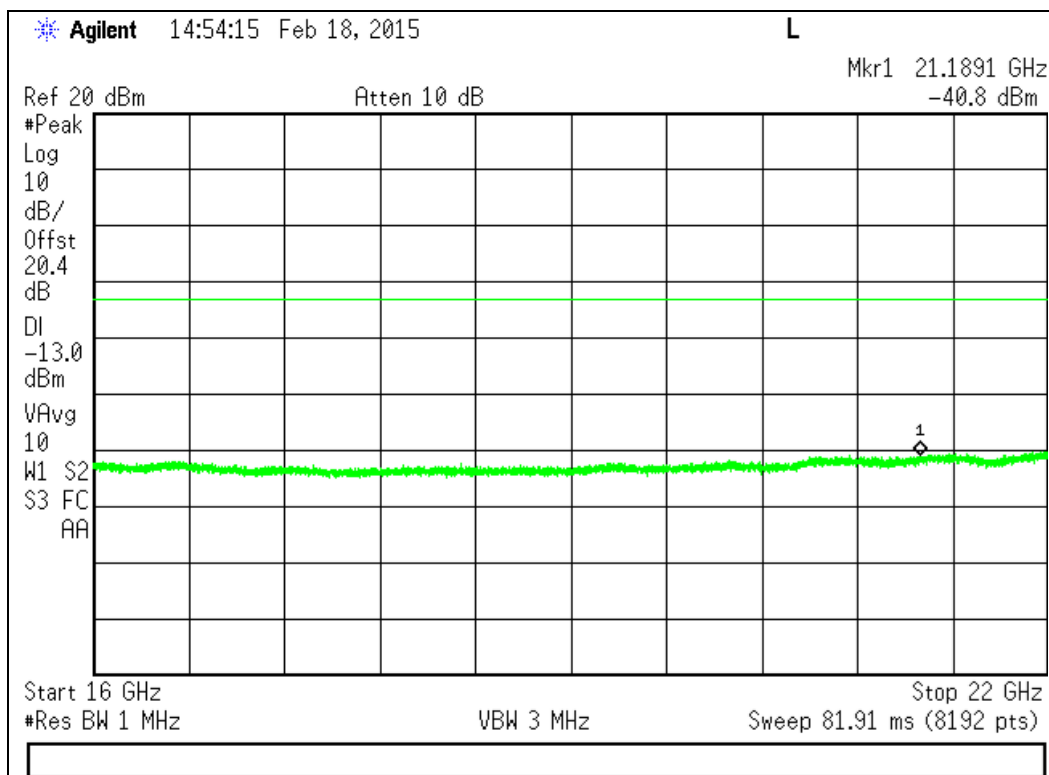
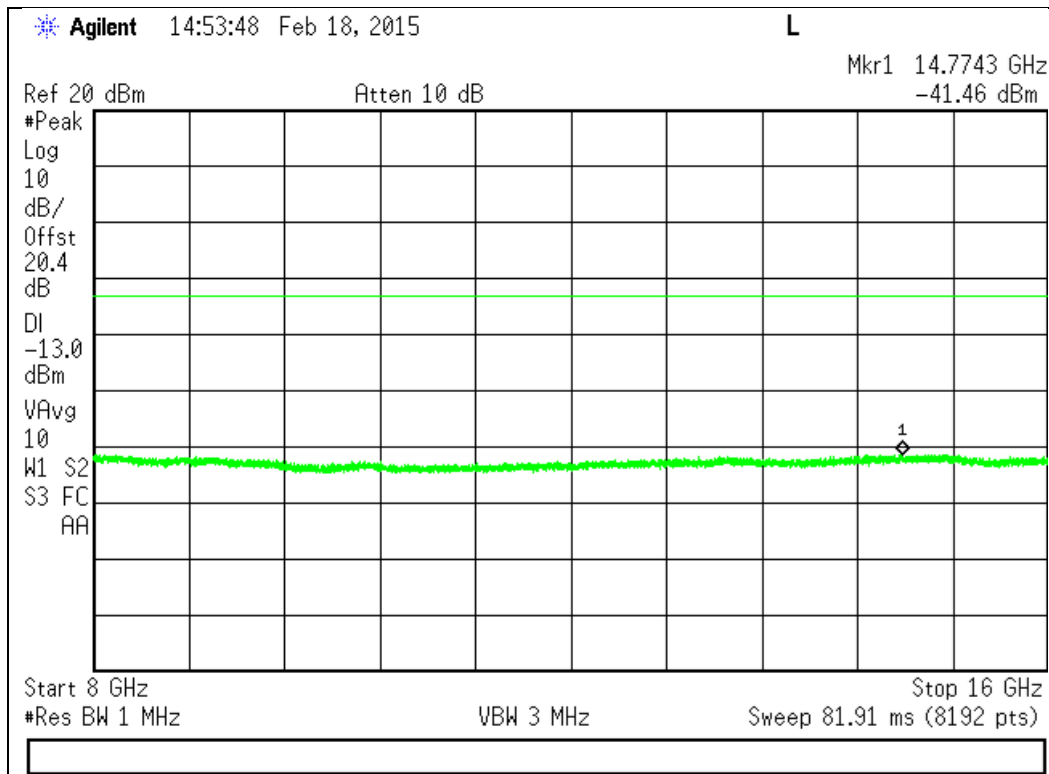

**776 – 787 MHz Uplink Test Plots for the  
763 - 775 MHz Frequency Range**

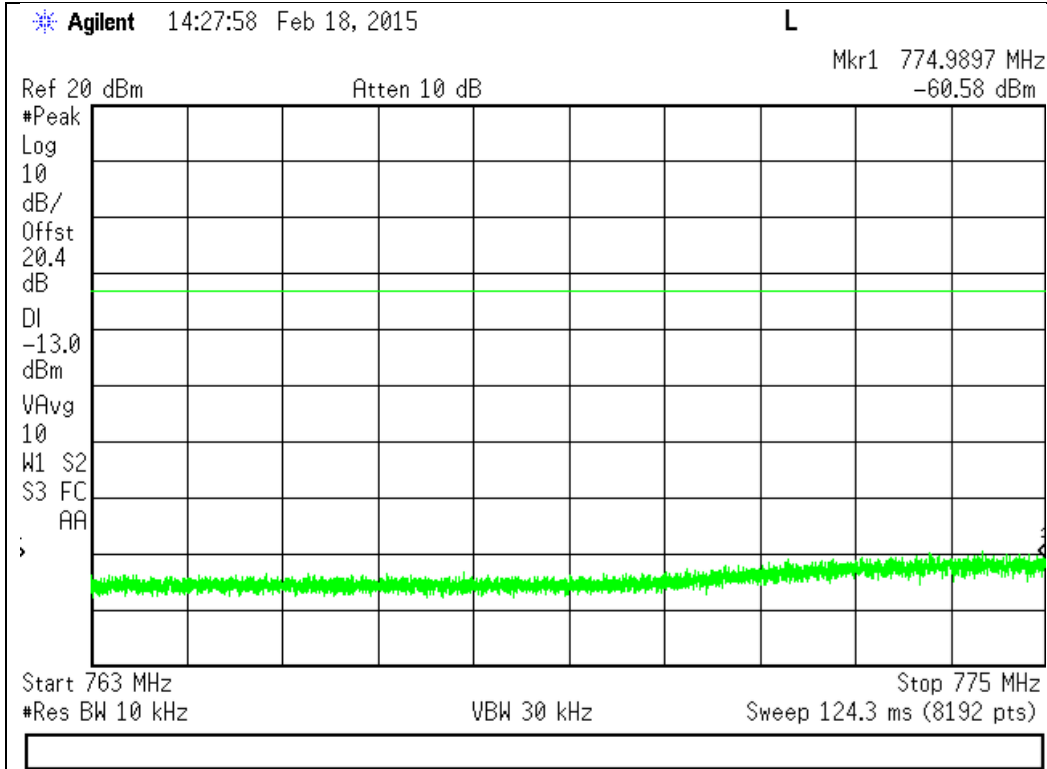

**793 - 805 MHz Frequency Range**

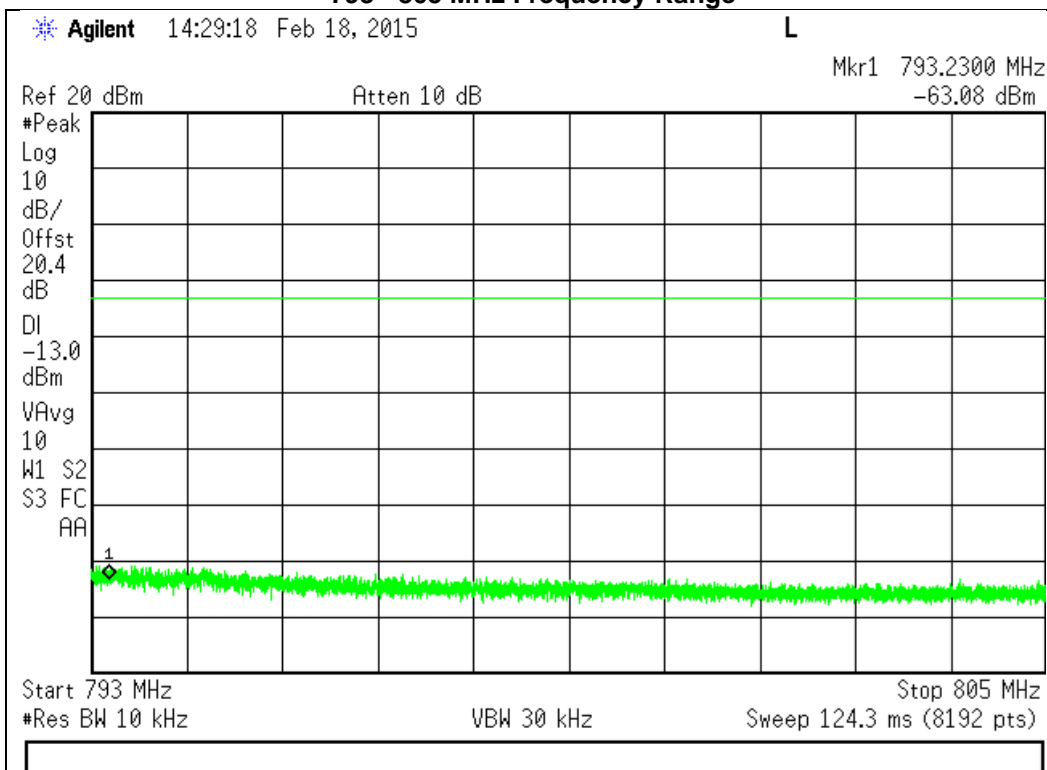



776 – 787 MHz Uplink Test Plots for the

1559 - 1610 MHz Frequency Range (Wideband)

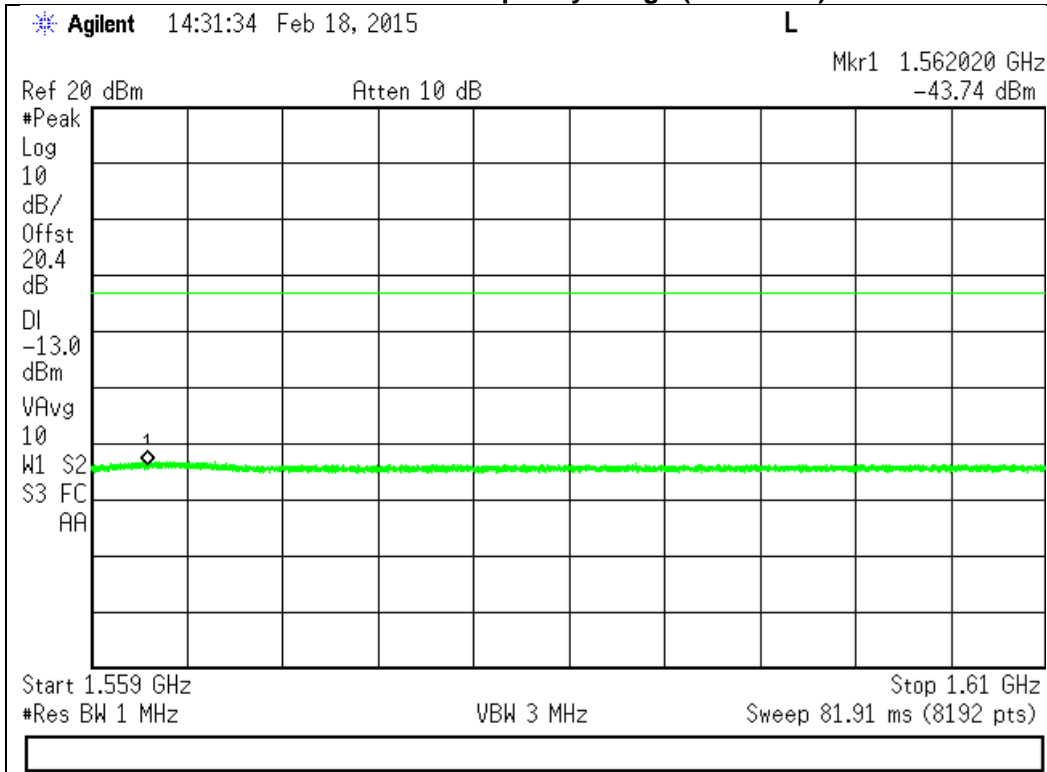

1559 - 1610 MHz Frequency Range (Narrowband)

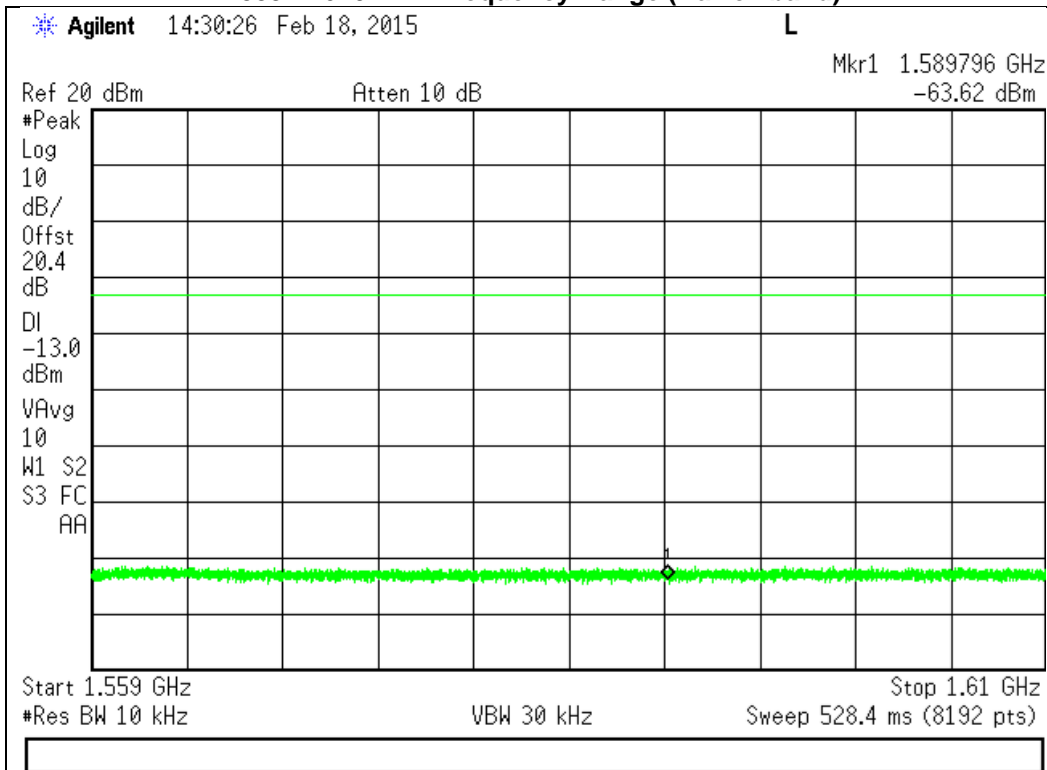

**746 – 757 MHz Downlink Test Plots for the**

**763 - 775 MHz Frequency Range**

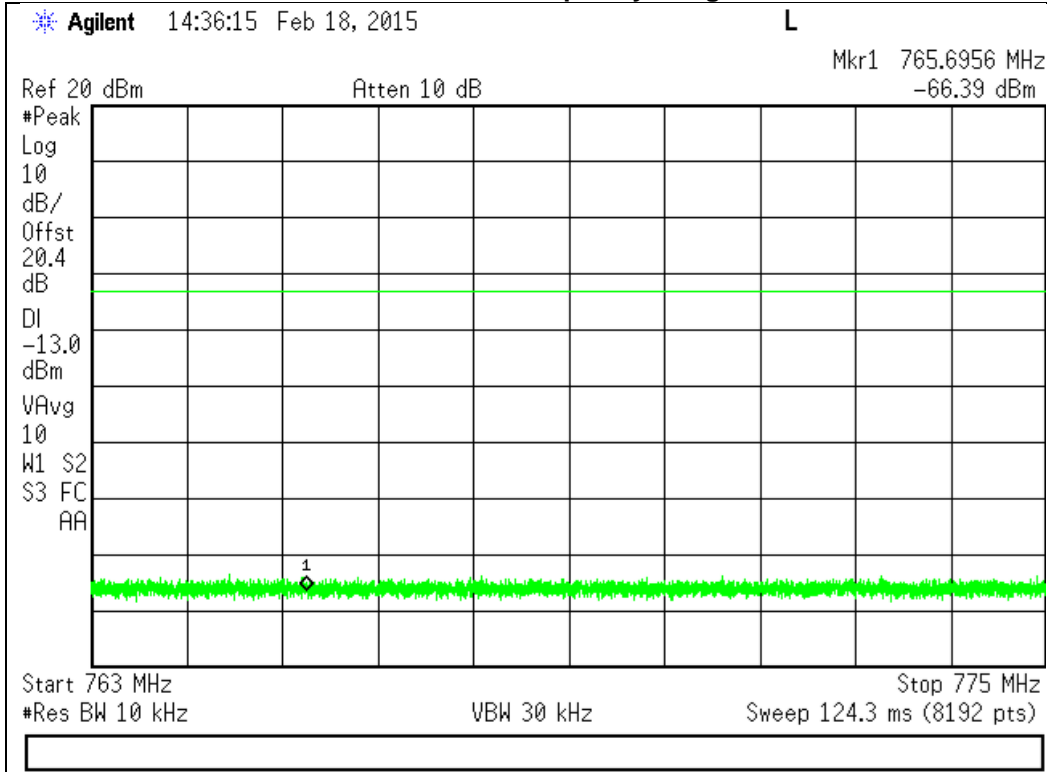

**793 - 805 MHz Frequency Range**

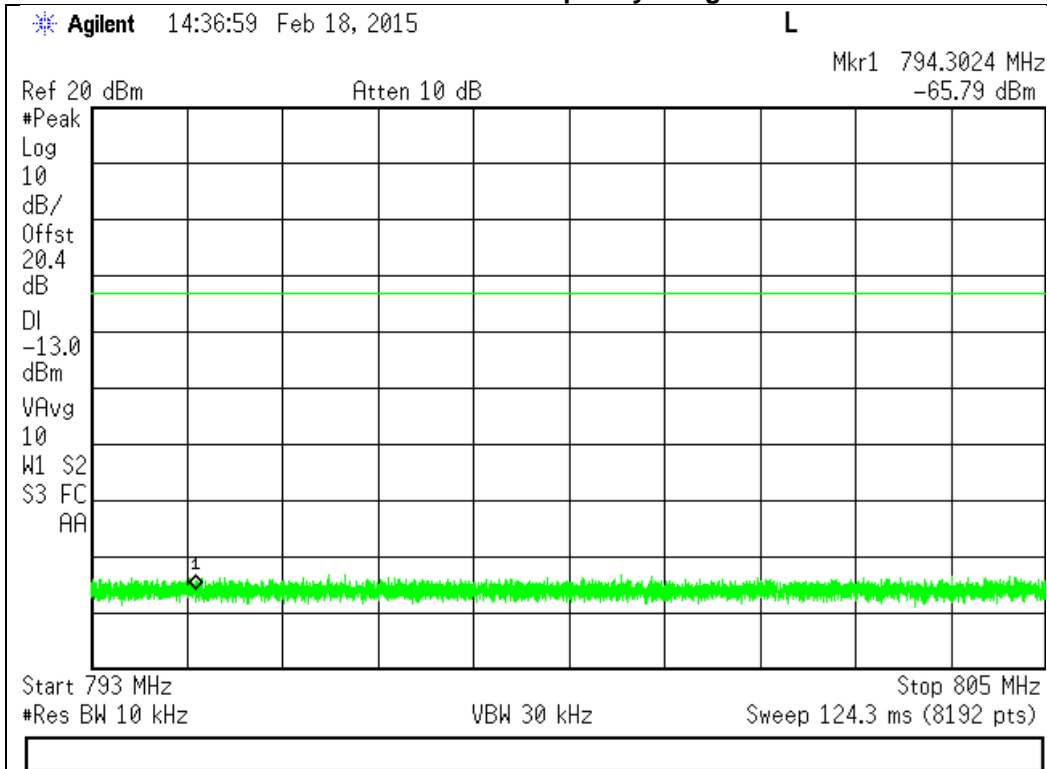

746 – 757 MHz Downlink Test Plots for the

1559 - 1610 MHz Frequency Range (Wideband)

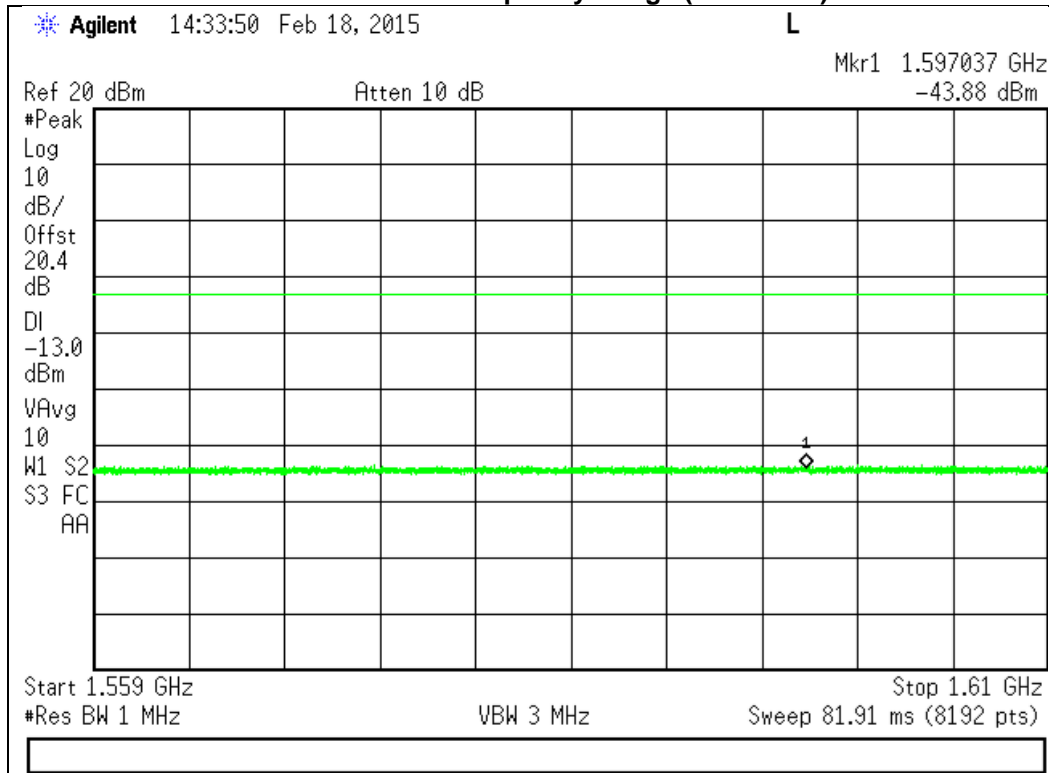

1559 - 1610 MHz Frequency Range (Narrowband)

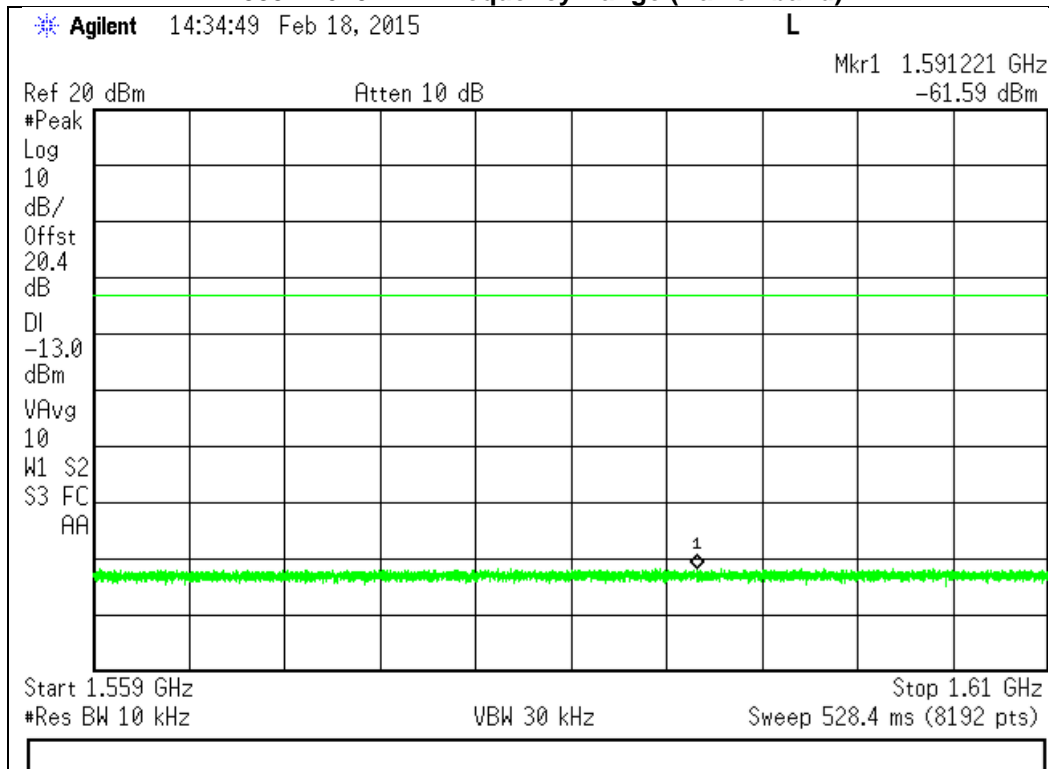

**Noise Limits**

**Engineer:** Mike Graffeo

**Test Date:** 2/17/15

**Test Procedure**

The EUT was connected to a spectrum analyzer through an attenuator with the losses being input into the spectrum analyzer as a combination of reference level offset and correction factor as necessary to ensure that accurate readings were obtained. A series of tests were performed: the maximum uplink and downlink noise, the variable noise for the uplink and in the presence of a downlink signal, and the variable uplink noise timing. The detailed procedures from KDB 935210 D03 Signal Booster Measurement v02r01 were followed.

For Mobile installations the Noise limit is fixed at -59 dBm.

**Test Setup**

**Maximum Noise Power**



**Variable Uplink Noise Power and Timing**

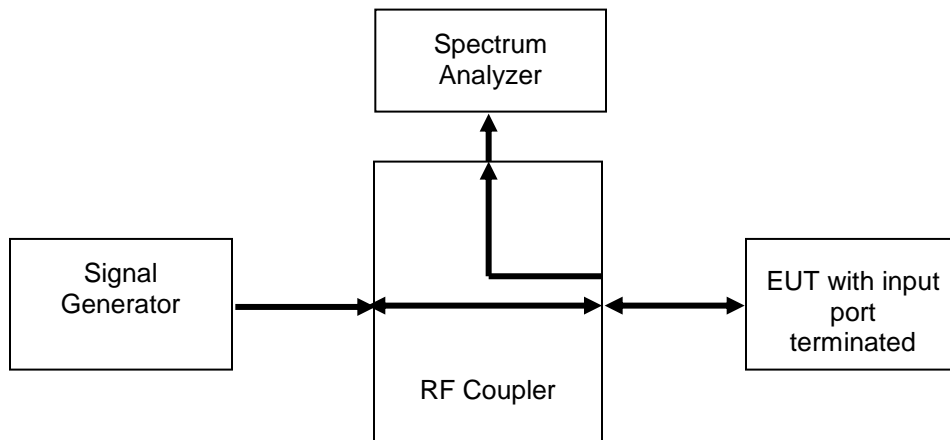

### Maximum Uplink Noise Test Results

Frequency Band (MHz)	Measured Noise (dBm)	Limit (dBm)	Margin (dB)	Result
698 - 716	-75.61	-59.0	-16.6	Pass
776 - 787	-74.63	-59.0	-15.6	Pass
824 - 849	-73.36	-59.0	-14.4	Pass
1710 - 1755	-74.49	-59.0	-15.5	Pass
1850 - 1910	-75.33	-59.0	-16.3	Pass

### Maximum Downlink Noise Test Results

Frequency Band (MHz)	Measured Noise (dBm)	Limit (dBm)	Margin (dB)	Result
728 - 746	-78.48	-59.0	-19.5	Pass
746 - 757	-78.36	-59.0	-19.4	Pass
869 - 894	-78.08	-59.0	-19.1	Pass
1930 - 1990	-78.36	-59.0	-19.4	Pass
2110 - 2155	-78.46	-59.0	-19.5	Pass

Maximum Uplink Noise Test Plots

698 - 716 MHz Band

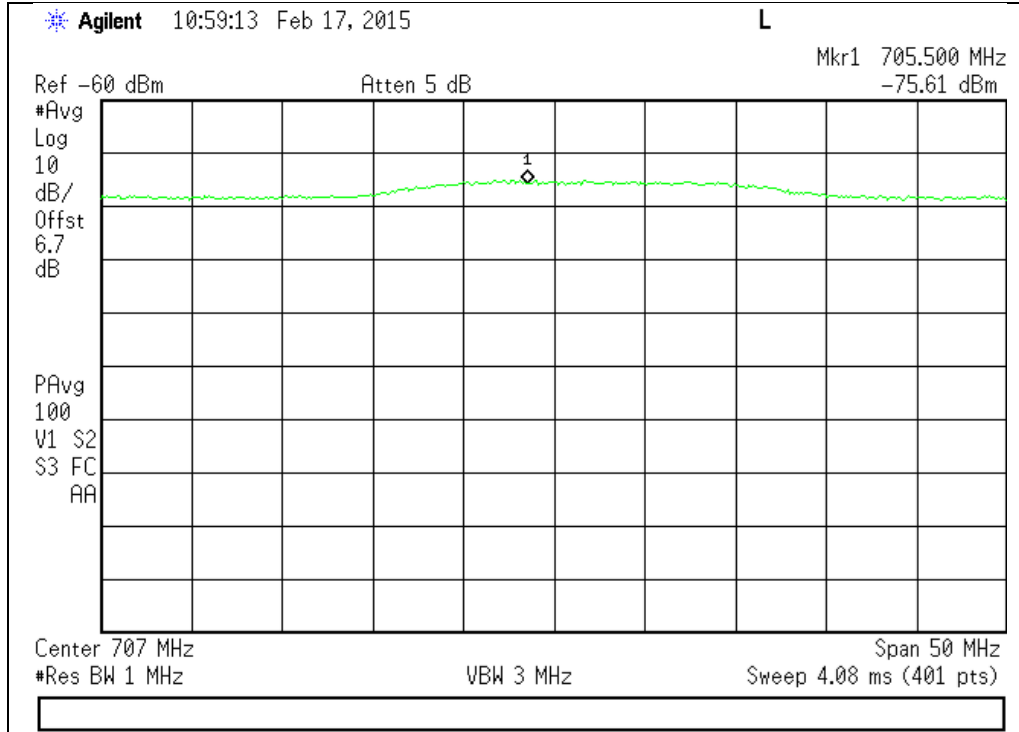

776 - 787 MHz Band

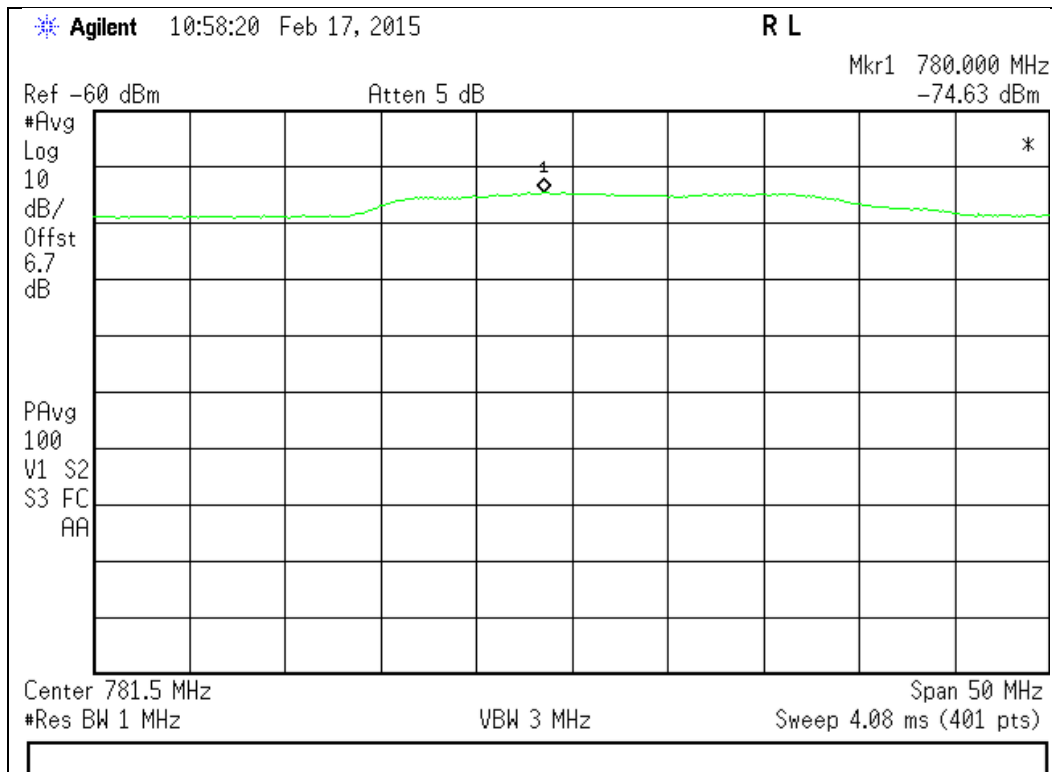

824 - 849 MHz Band

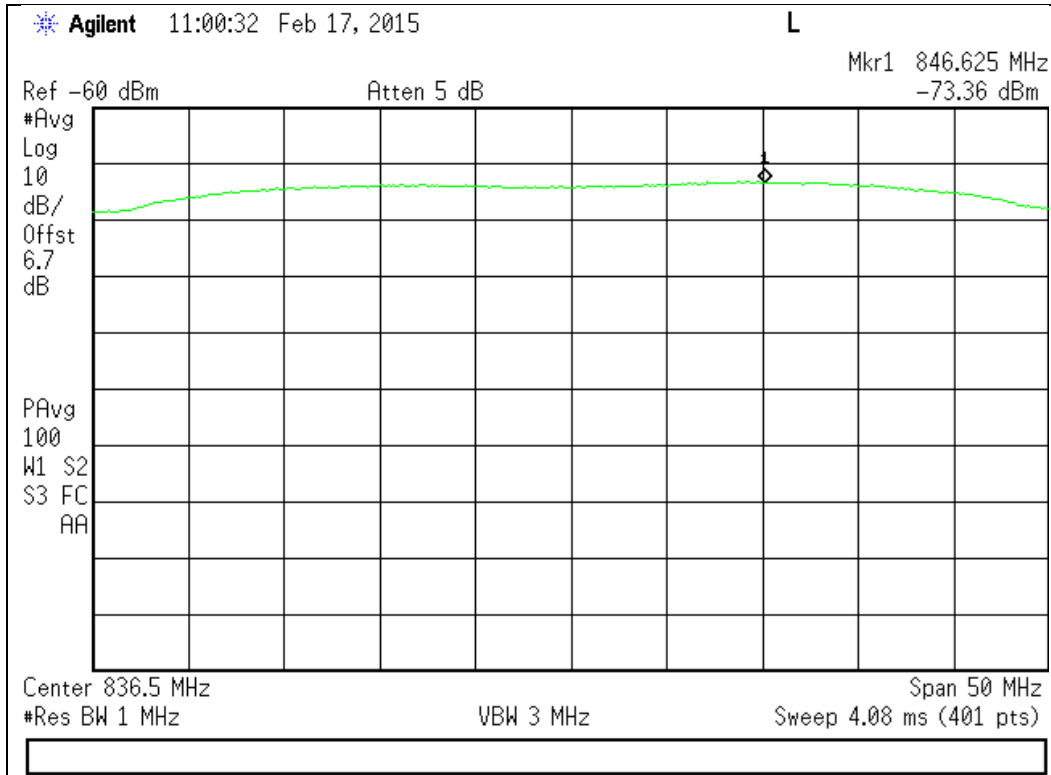

1710 - 1755 MHz Band

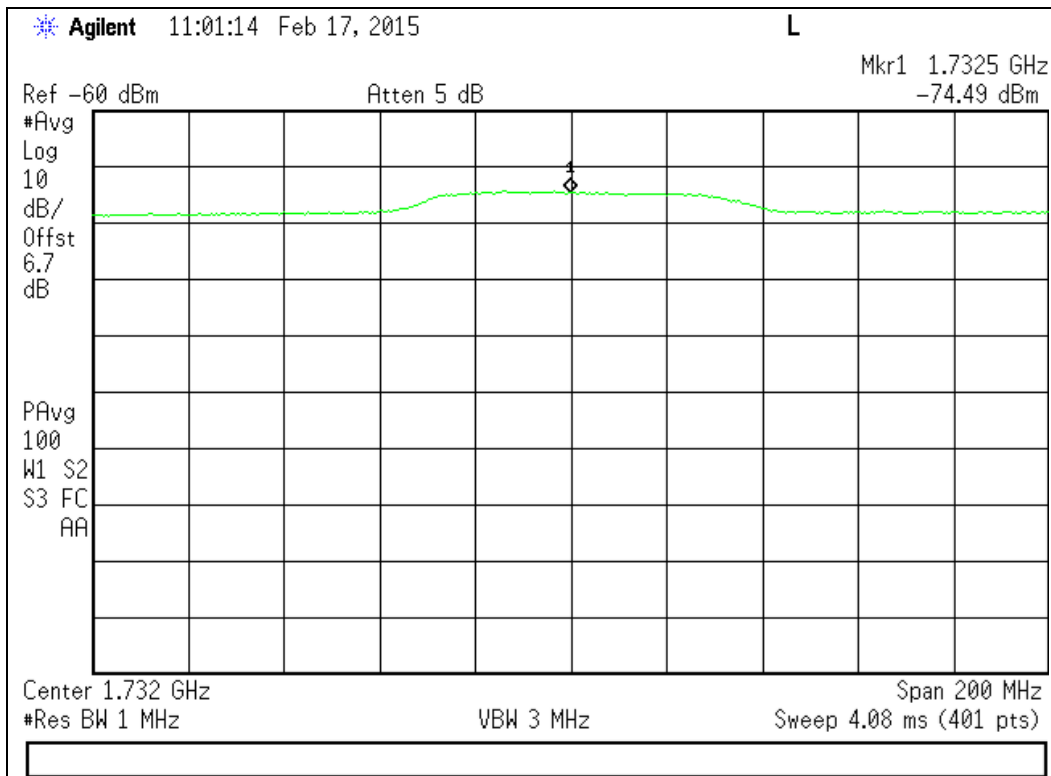

1850 - 1910 MHz Band

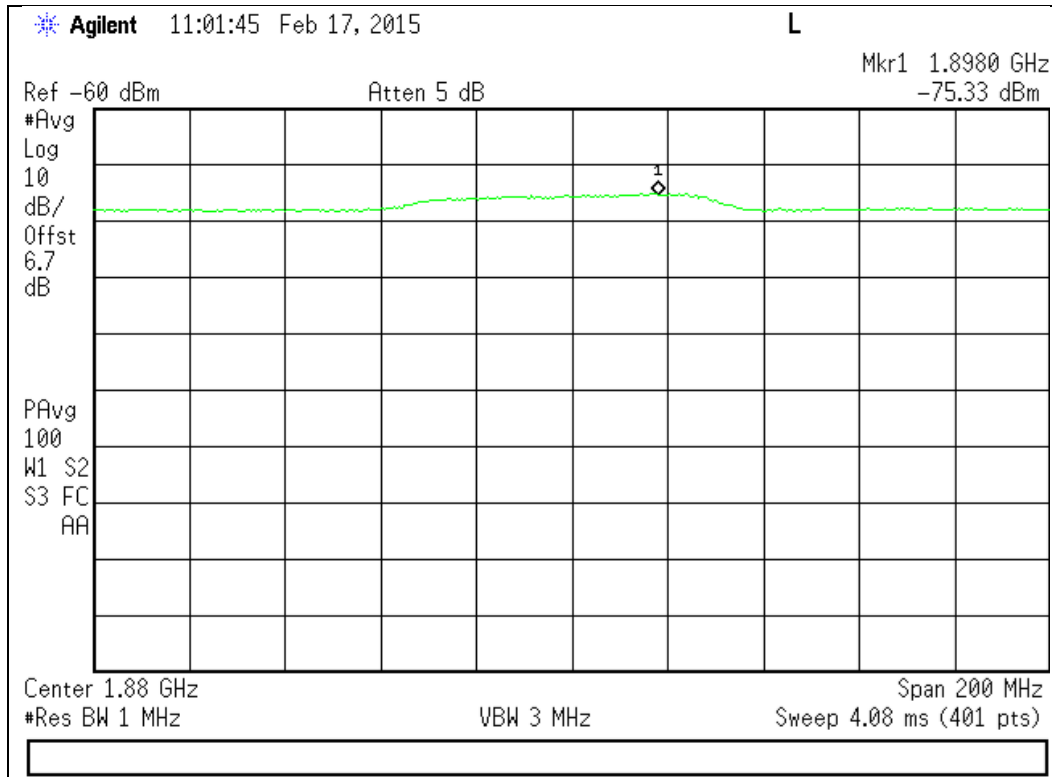

Maximum Downlink Noise Test Plots

728 - 746 MHz Band

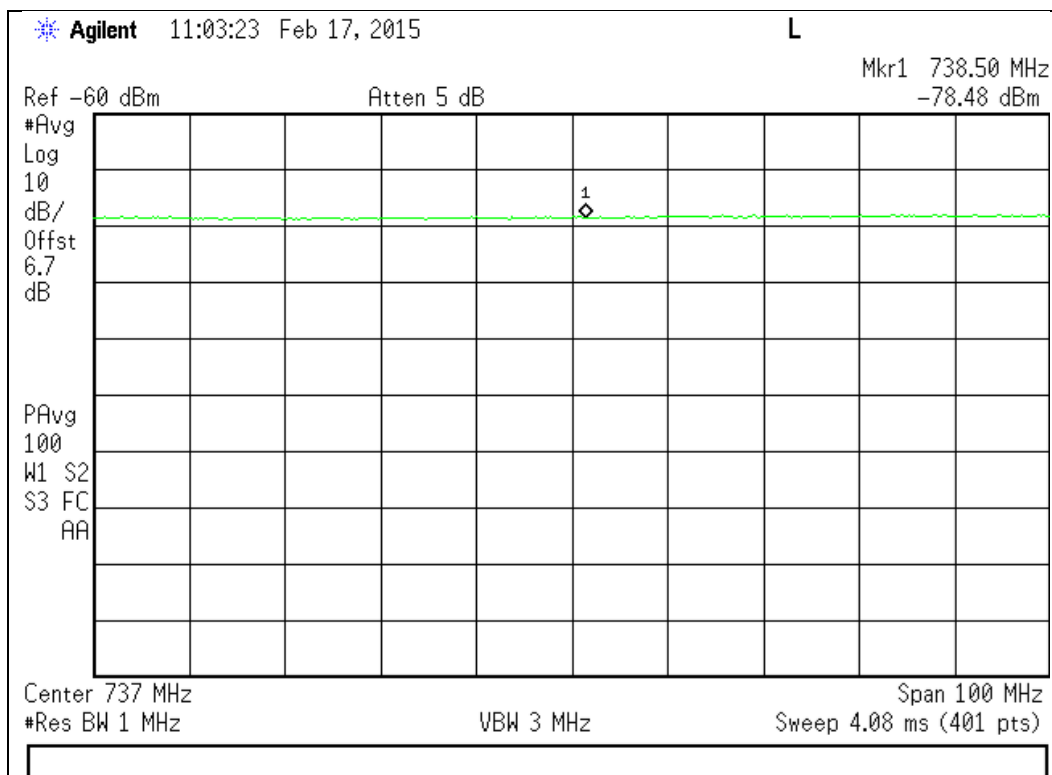



746 - 757 MHz Band

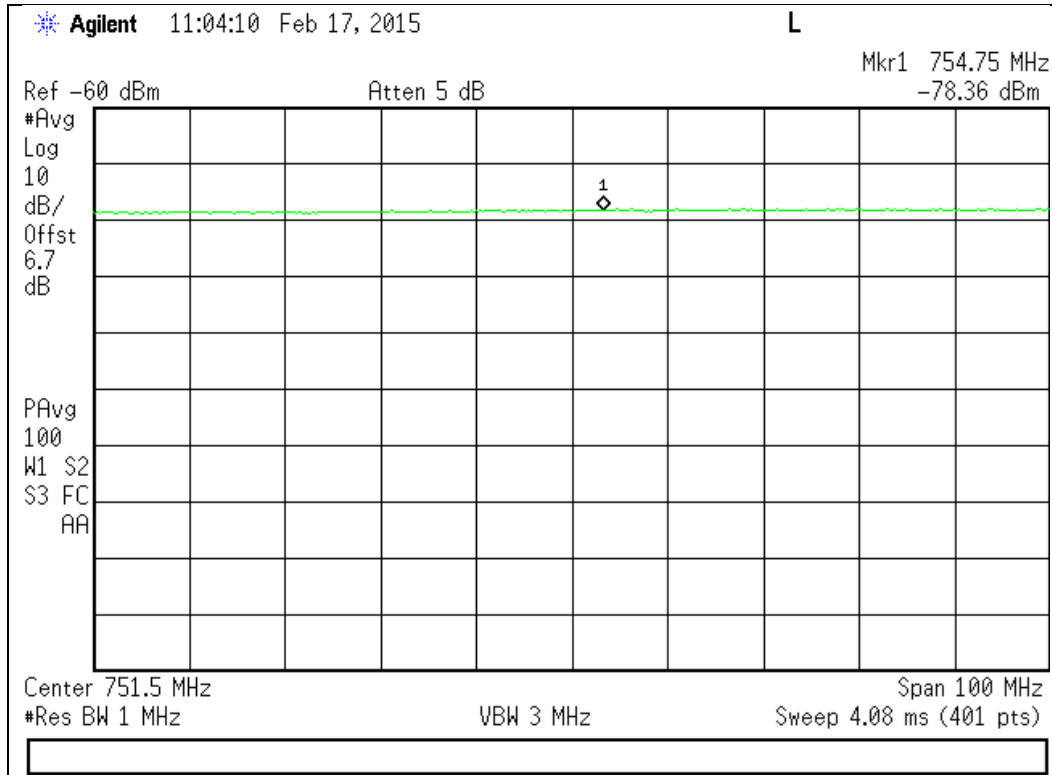

869 - 894 MHz Band

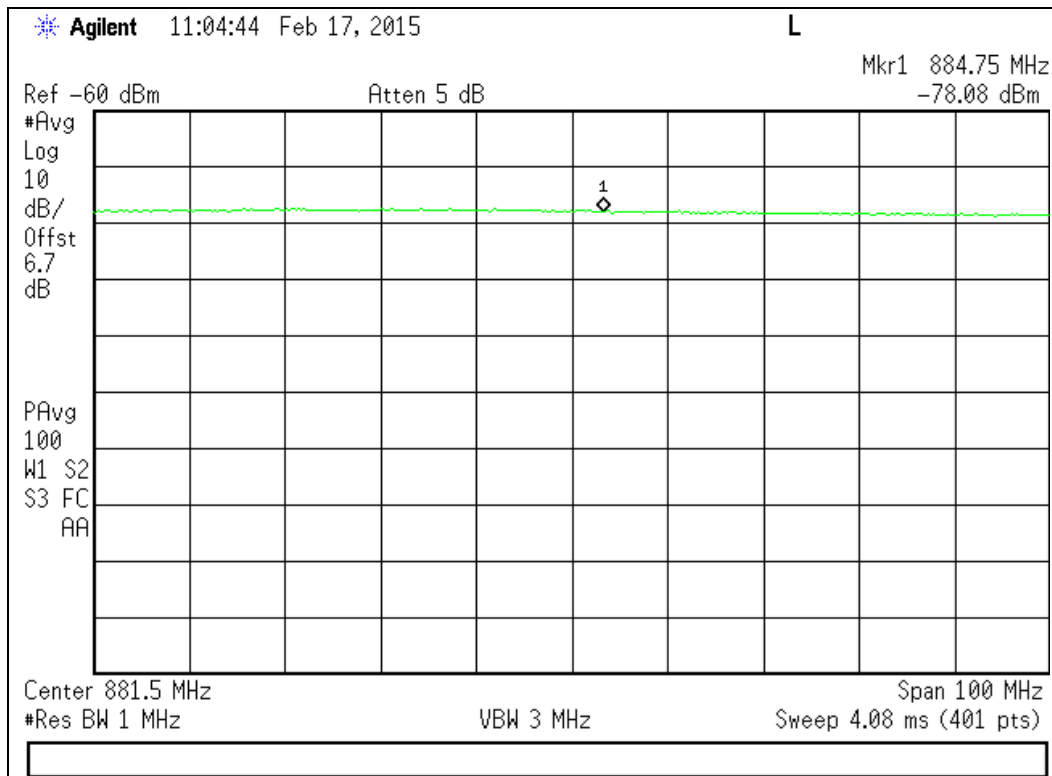

**1930 - 1990 MHz Band**

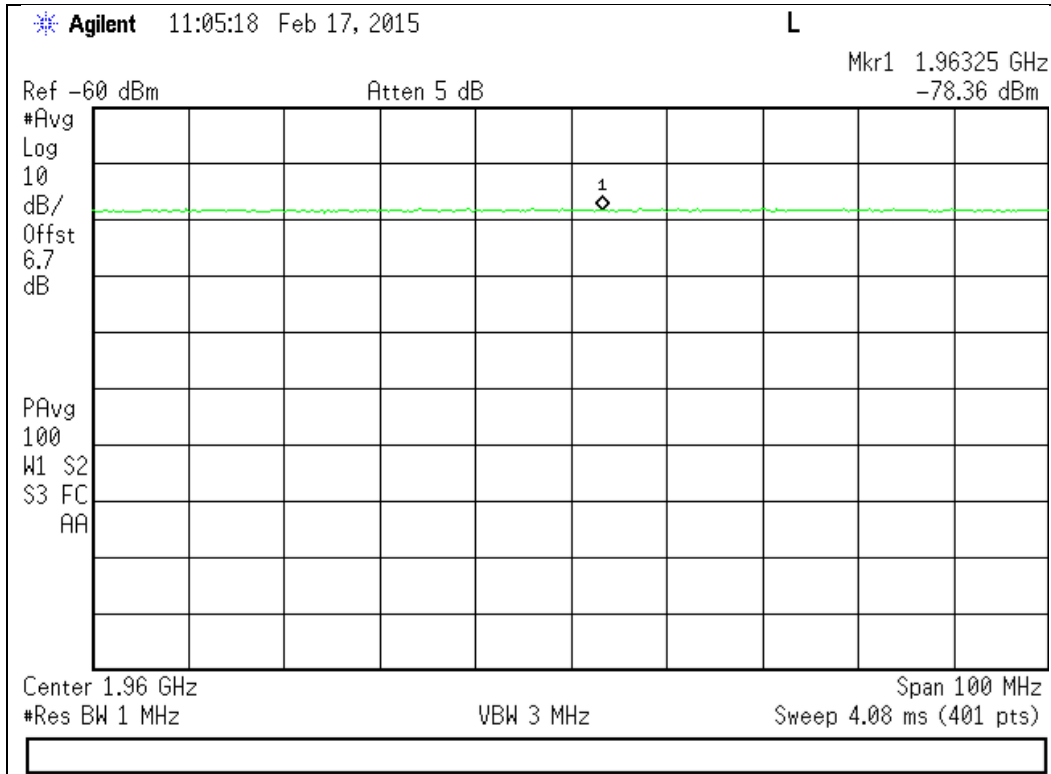

**2110 - 2155 MHz Band**

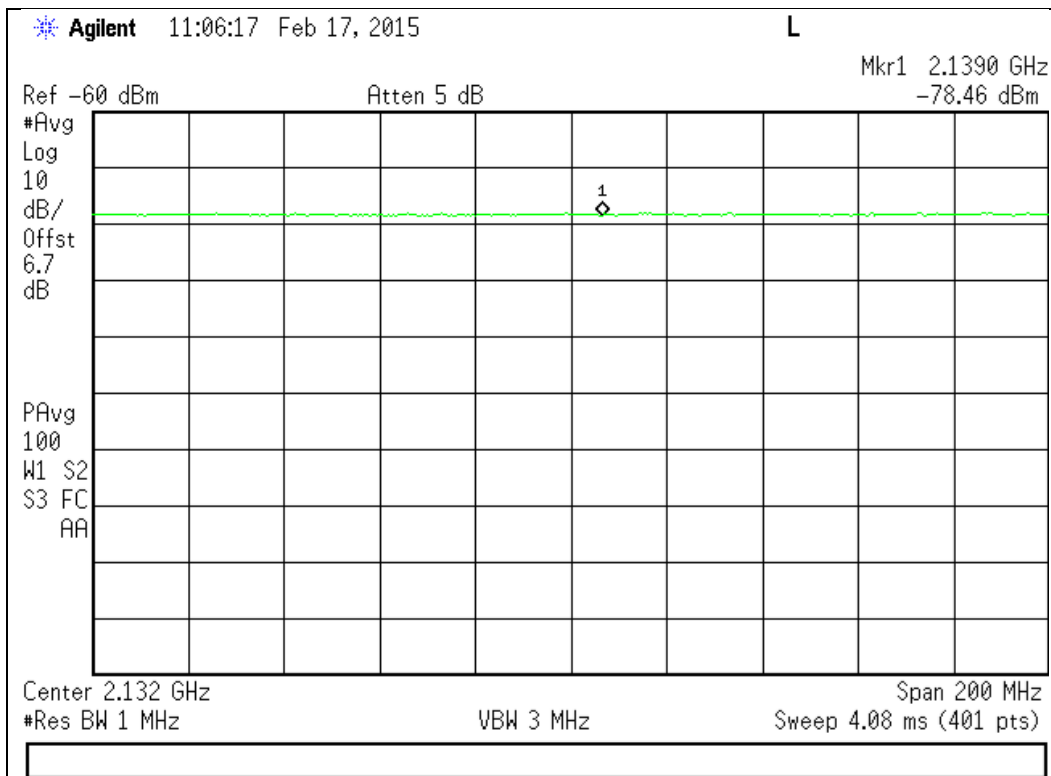

## Uplink Inactivity

**Engineer:** Mike Graffeo

**Test Date:** NA

### Test Procedure

The EUT was connected directly to a spectrum analyzer set to operate in the center of the EUT operational uplink and downlink bands. The span was set to 0 Hz with a sweep time of 330 seconds and MAX HOLD operation. The EUT was powered on and the time for the uplink to return to an inactive state was measured using the DELTA MARKER method to ensure that it was less than 300 seconds. The noise level after the return to an inactive state was less than -70 dBm/MHz

### Test Setup

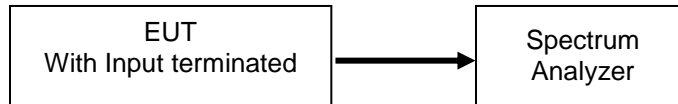

### Uplink Test Results

Frequency Band (MHz)	Measured Time (Seconds)	Limit (Seconds)	Result
698 - 716	NA **	300	Pass
776 - 787	NA	300	Pass
824 - 849	NA	300	Pass
1710 - 1755	NA	300	Pass
1850 - 1910	NA	300	Pass

**\*\* Note:**

The booster idle state noise level is below the -70 dBm requirement, so the booster is not required to lower its noise level during the inactive state

**Variable Gain**

**Engineer:** Mike Graffeo

**Test Date:** 2/17/15

**Test Procedure**

The EUT was connected to a spectrum analyzer through an attenuator with the losses being input into the spectrum analyzer as a combination of reference level offset and correction factor in order to ensure accurate readings were obtained. The uplink gain in the presence of a downlink signal was measured for each operational uplink band using the detailed procedures from The detailed procedures from KDB 935210 D03 Signal Booster Measurement v02r01 were followed..

The following formula is used for calculating the limits:

$$\text{Variable Gain} = -34 \text{ dB} - \text{RSSI} + \text{MSCL}$$

Mobile Booster maximum gain = 50dB

**Test Setup**

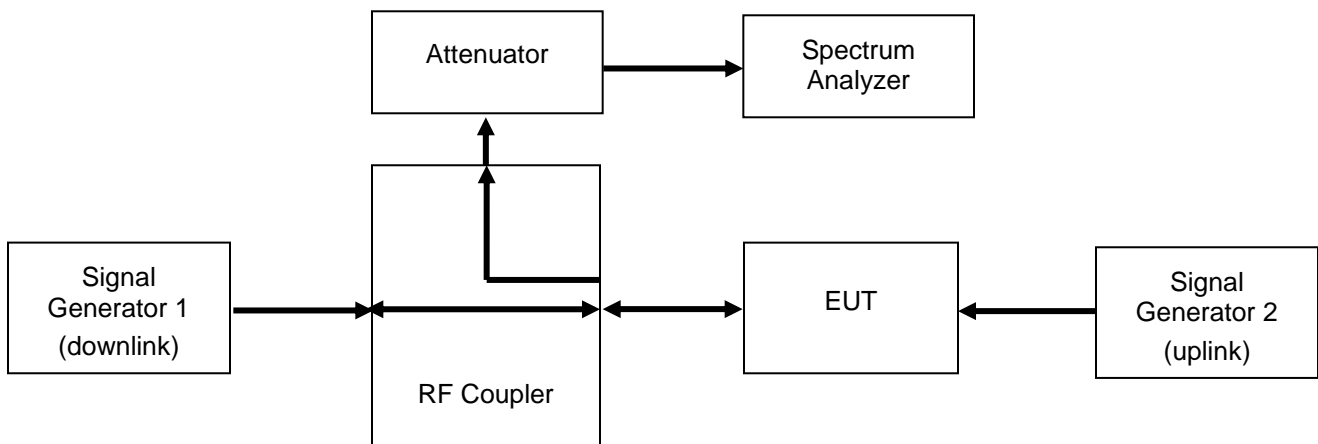

## Uplink Variable Gain Test Results

### 698 - 716 MHz

RSSI (dBm)	MSCL (dB)	Gain Limit (dBm)	P(in) (dBm)	P(out) (dBm)	Gain (dB)	Margin (dB)
-59.0	28.7	50.0	-31.9	17.9	49.8	-0.2
-58.0	28.7	50.0	-31.9	17.9	49.8	-0.2
-57.0	28.7	50.0	-31.9	17.9	49.8	-0.2
-56.0	28.7	50.0	-31.9	17.9	49.8	-0.2
-53.0	28.7	47.7	-31.9	15.5	47.4	-0.3
-52.0	28.7	46.7	-31.9	14.5	46.4	-0.3

### 776 - 787 MHz

RSSI (dBm)	MSCL (dB)	Gain Limit (dBm)	P(in) (dBm)	P(out) (dBm)	Gain (dB)	Margin (dB)
-56.0	28.2	50.0	-32.5	16.5	49.0	-1.0
-55.0	28.2	49.2	-32.5	16.5	49.0	-0.2
-54.0	28.2	48.2	-32.5	15.3	47.8	-0.4
-53.0	28.2	47.2	-32.5	14.0	46.5	-0.7
-52.0	28.2	46.2	-32.5	13.2	45.7	-0.5
-56.0	28.2	50.0	-32.5	16.5	49.0	-1.0

### 824 - 849 MHz

RSSI (dBm)	MSCL (dB)	Gain Limit (dBm)	P(in) (dBm)	P(out) (dBm)	Gain (dB)	Margin (dB)
-56.0	26.90	48.90	-32.2	15.5	47.7	-1.2
-55.0	26.90	47.90	-32.2	15.5	47.7	-0.2
-54.0	26.90	46.90	-32.2	14.4	46.6	-0.3
-53.0	26.90	45.90	-32.2	13.2	45.4	-0.5
-52.0	26.90	44.90	-32.2	11.0	43.2	-1.7
-56.0	26.90	48.90	-32.2	15.5	47.7	-1.2

### Uplink Variable Gain Test Results (Cont)

#### 1710 - 1755 MHz

RSSI (dBm)	MSCL (dB)	Gain Limit (dBm)	P(in) (dBm)	P(out) (dBm)	Gain (dB)	Margin (dB)
-49.0	32.6	47.6	-33.6	11.6	45.2	-2.4
-48.0	32.6	46.6	-33.6	11.6	45.2	-1.4
-47.0	32.6	45.6	-33.6	11.6	45.2	-0.4
-46.0	32.6	44.6	-33.6	10.5	44.1	-0.5
-45.0	32.6	43.6	-33.6	8.5	42.1	-1.5
-49.0	32.6	47.6	-33.6	11.6	45.2	-2.4

#### 1850 – 1910 MHz

RSSI (dBm)	MSCL (dB)	Gain Limit (dBm)	P(in) (dBm)	P(out) (dBm)	Gain (dB)	Margin (dB)
-54.0	31.80	50.00	-30.3	17.3	47.6	-2.4
-53.0	31.80	50.00	-30.3	17.3	47.6	-2.4
-52.0	31.80	49.80	-30.3	17.3	47.6	-2.2
-51.0	31.80	48.80	-30.3	16.8	47.1	-1.7
-50.0	31.80	47.80	-30.3	16.2	46.5	-1.3
-54.0	31.80	50.00	-30.3	17.3	47.6	-2.4

\*RSSI dependent region

### Uplink Gain Timing Test Results

Frequency Band (MHz)	Measured Timing (ms)	Limit (ms)	Result
698 - 716	23.25	1000.0	Pass
776 - 787	62.25	1000.0	Pass
824 - 849	15.56	1000.0	Pass
1710 - 1755	23.25	1000.0	Pass
1850 - 1910	23.25	1000.0	Pass

### Uplink Gain Timing Plots

#### 698 - 716 MHz Band

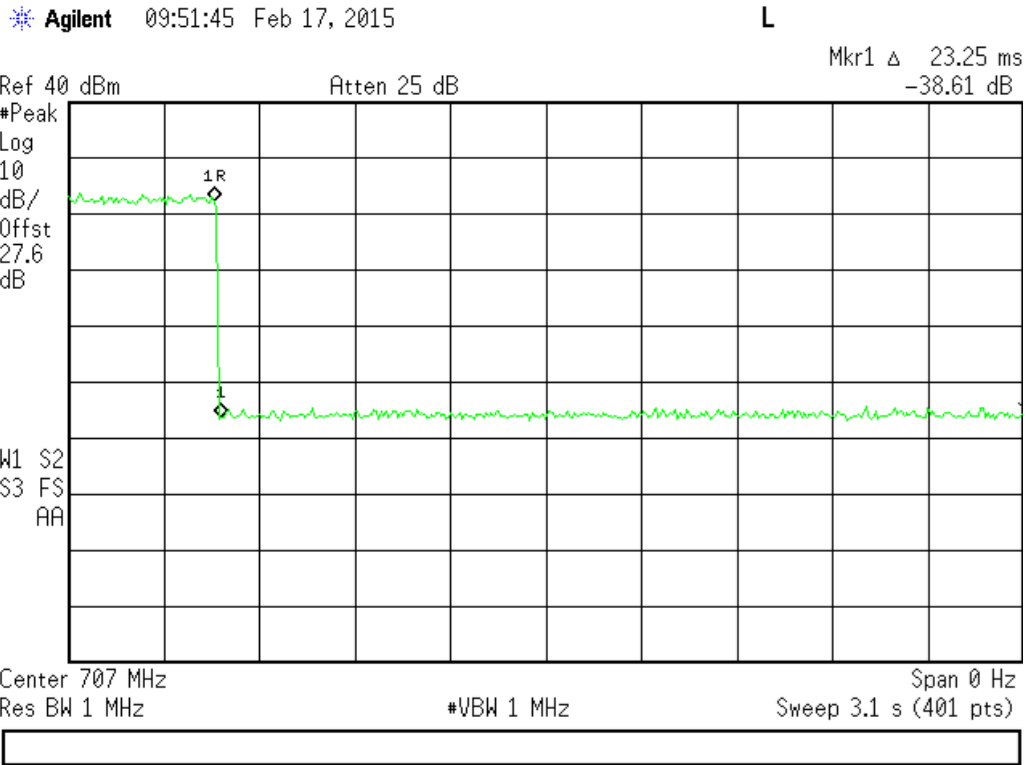

#### 776 - 787 MHz Band

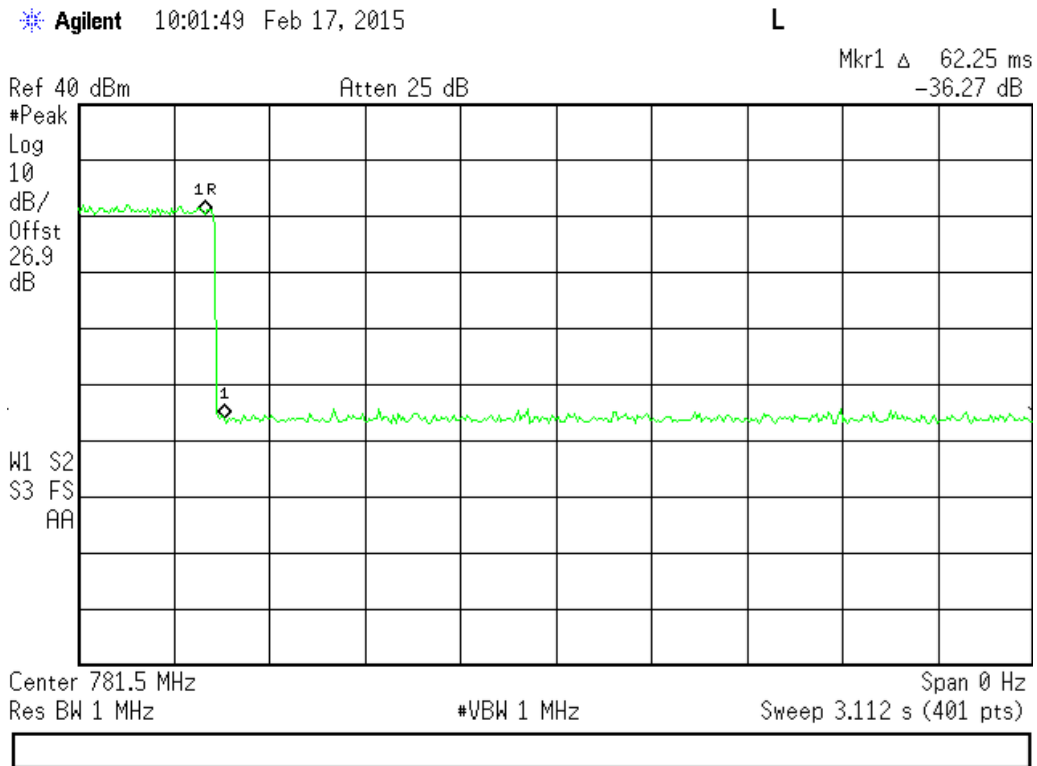

**824 - 849 MHz Band**

Agilent 10:05:04 Feb 17, 2015

L

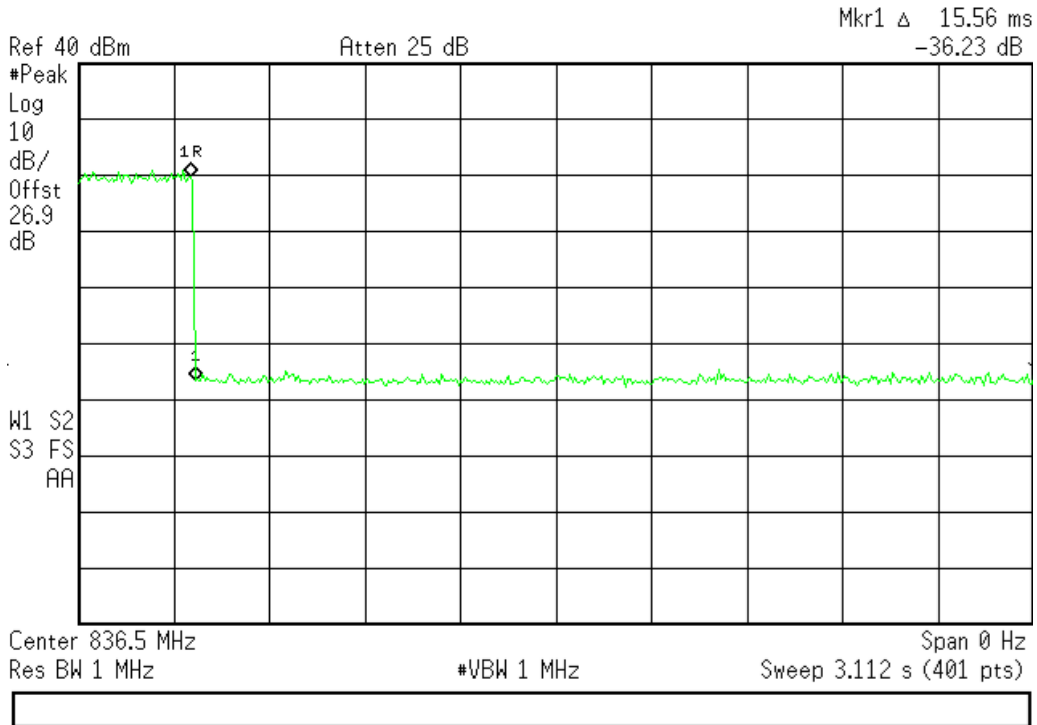

**1710 - 1755 MHz Band**

Agilent 10:09:22 Feb 17, 2015

L

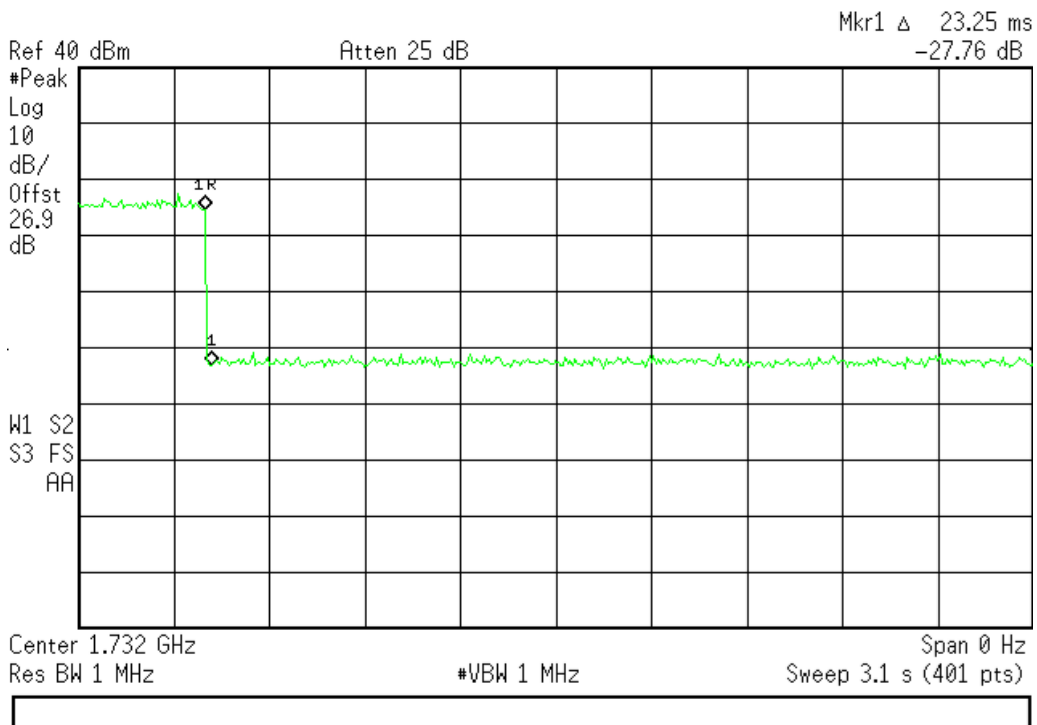



**1850 - 1910 MHz Band**

Agilent 10:10:30 Feb 17, 2015

L

Mkr1 Δ 23.25 ms  
-27.32 dB

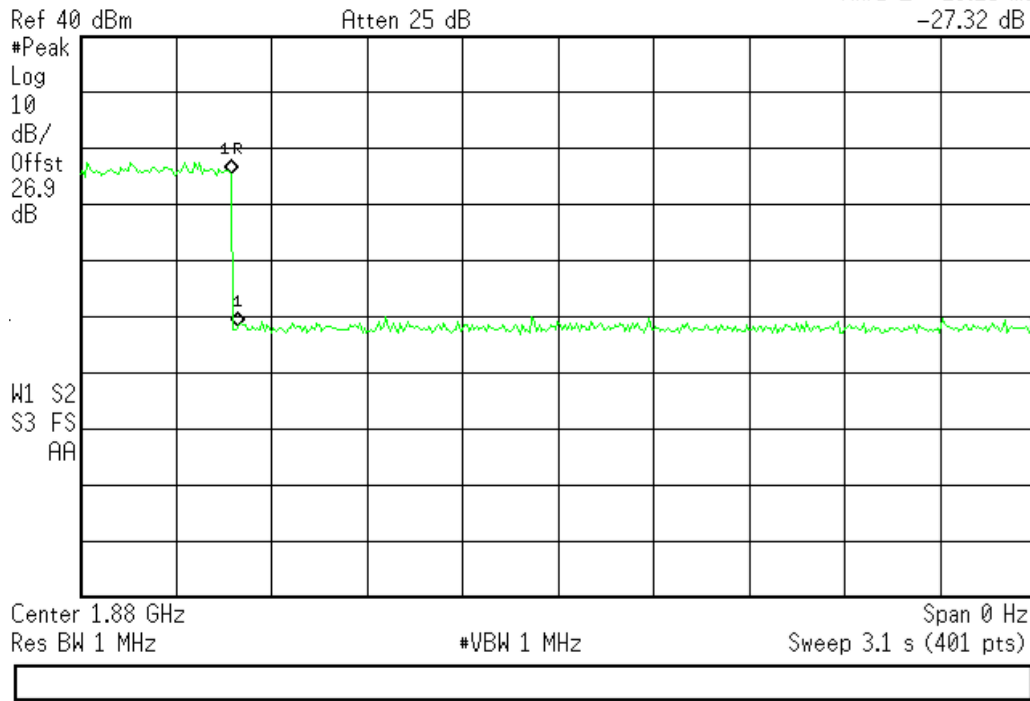

**Occupied Bandwidth**

**Engineer:** Mike Graffeo

**Test Date:** 2/17/15

**Test Procedure**

The EUT was connected to a spectrum analyzer through an attenuator with the losses being input into the spectrum analyzer as a combination of reference level offset and correction factor as required to ensure that accurate readings were obtained. A signal generator was utilized to produce the following signals: GSM, CDMA, and WCDMA. The signal generator was tuned to the center channel of each of the EUT operational uplink and downlink bands with the RF level set at a point just prior to the AGC being in control of the power. For each modulation type, the input and output signal was measured and plotted to ensure that the signals were similar.

**Test Setup**

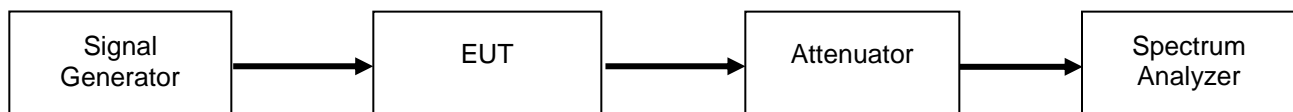

### GSM Uplink Test Plots

#### 698 - 716 MHz Band

#### Input

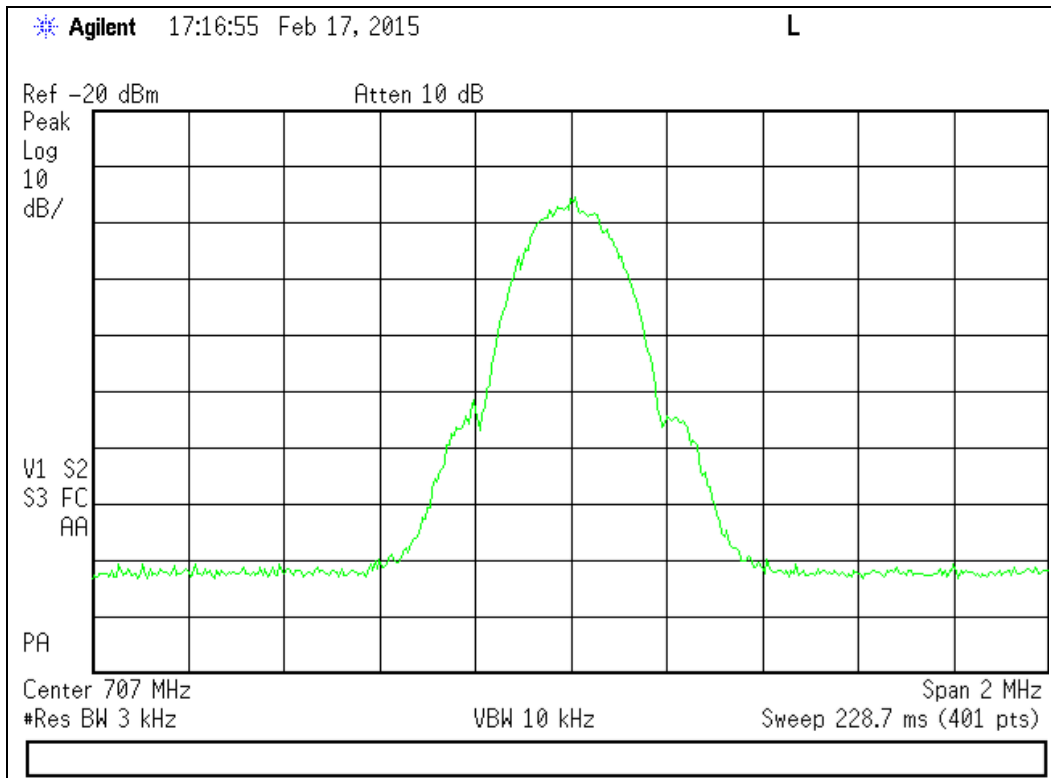

#### Output

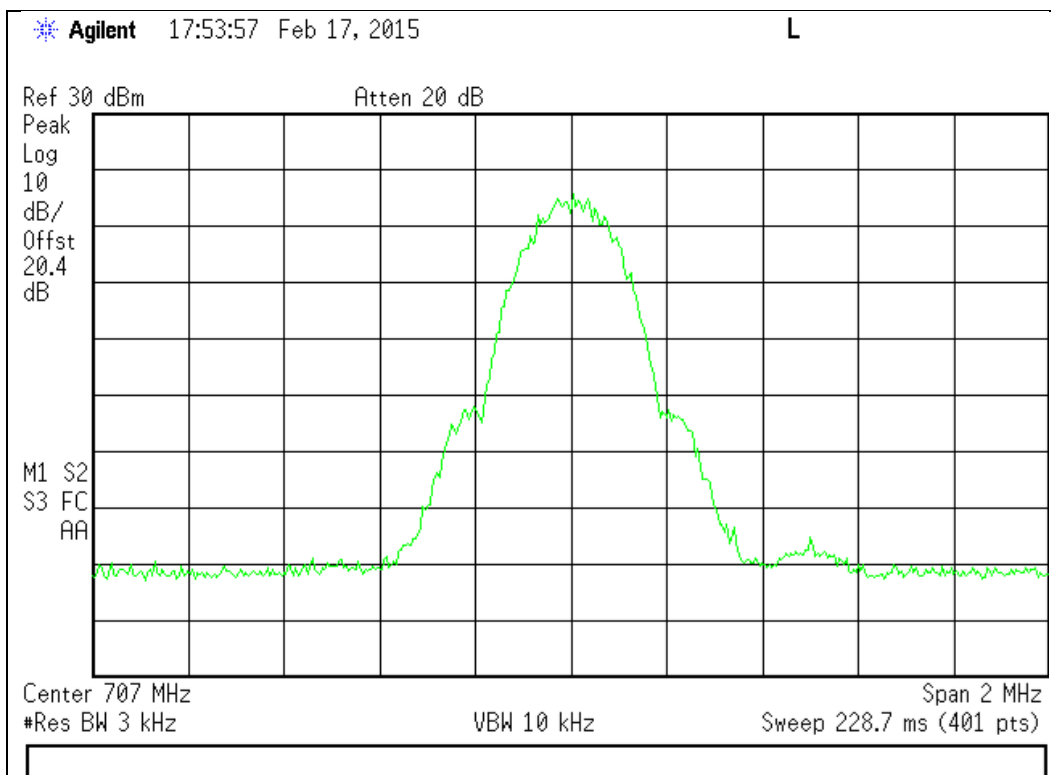

776 - 787 MHz Band

Input

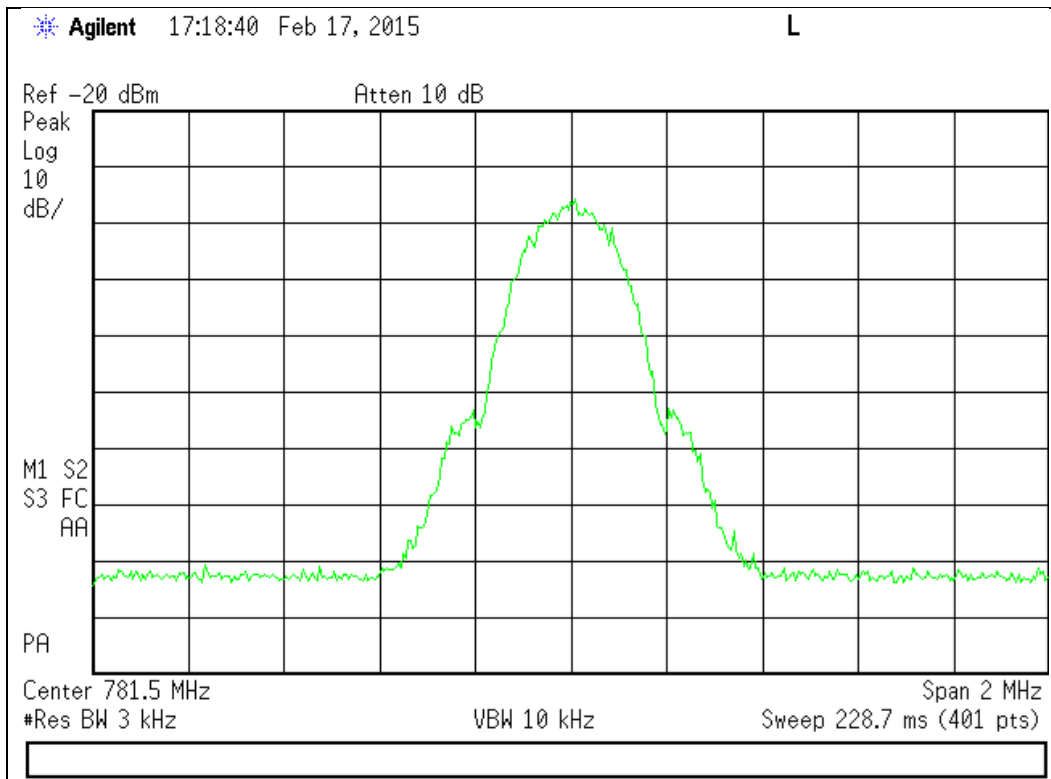

Output

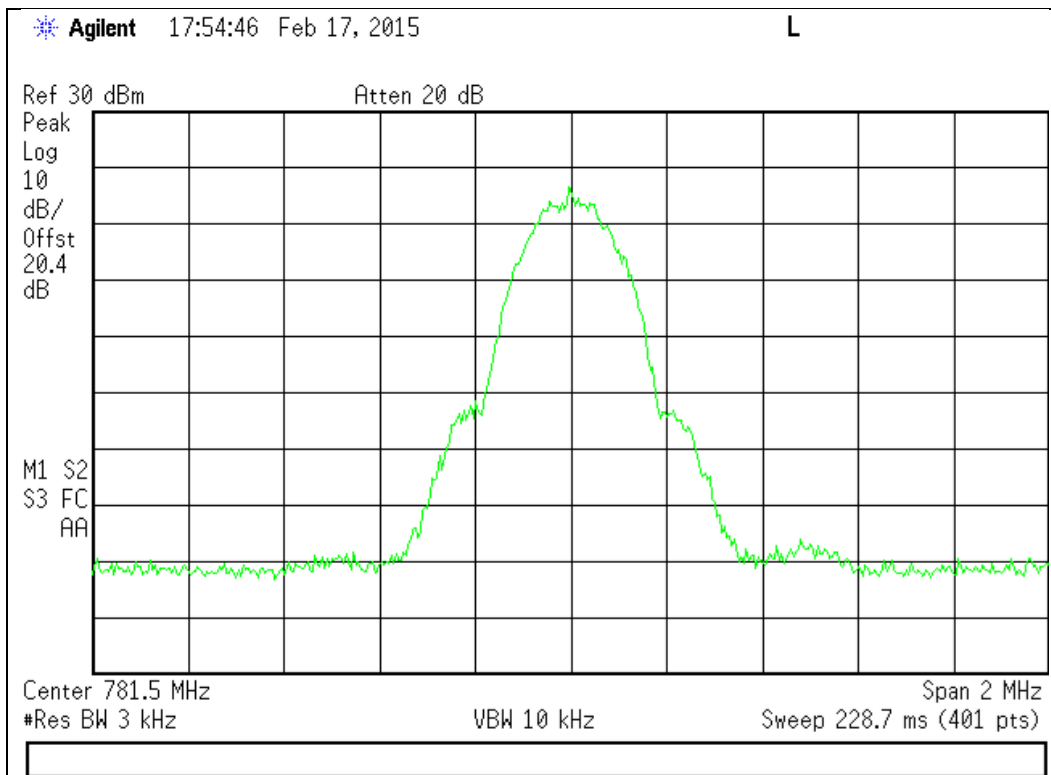

824 - 849 MHz Band

Input

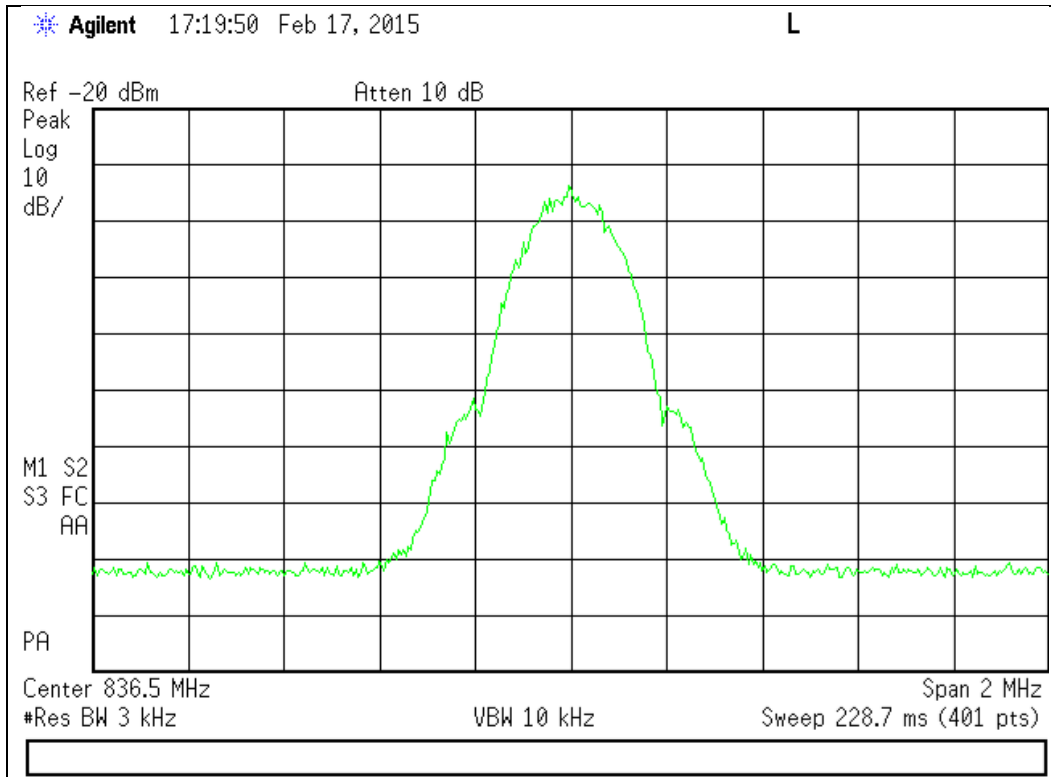

Output

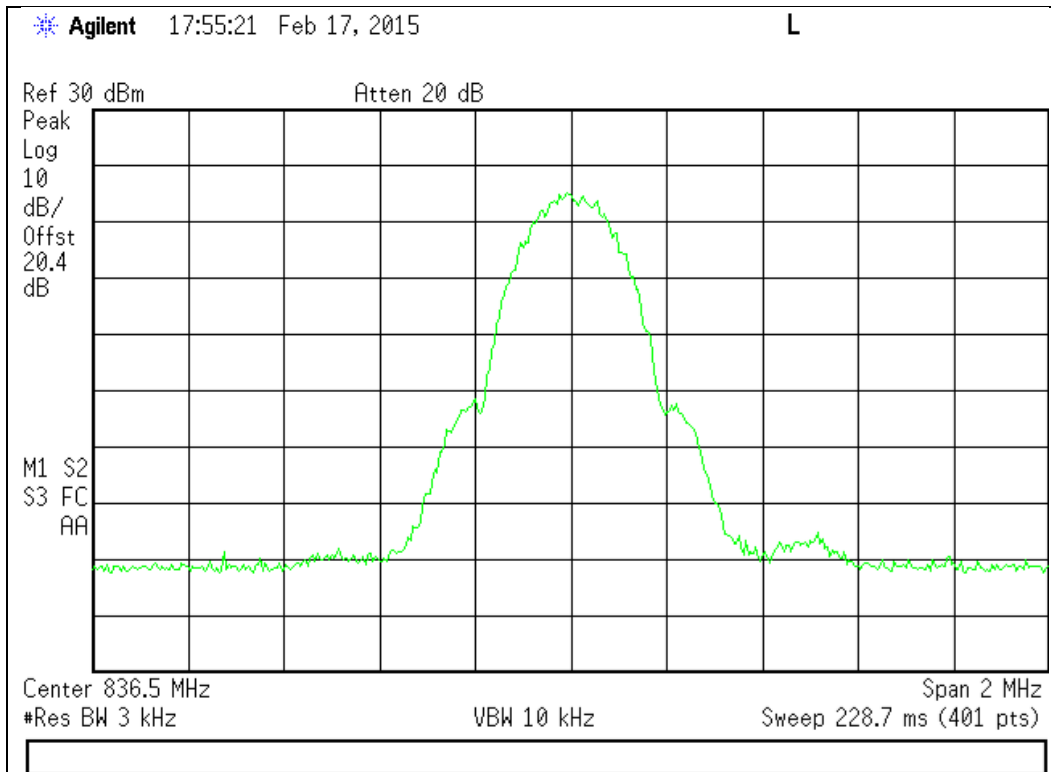

1710 - 1755 MHz Band

Input

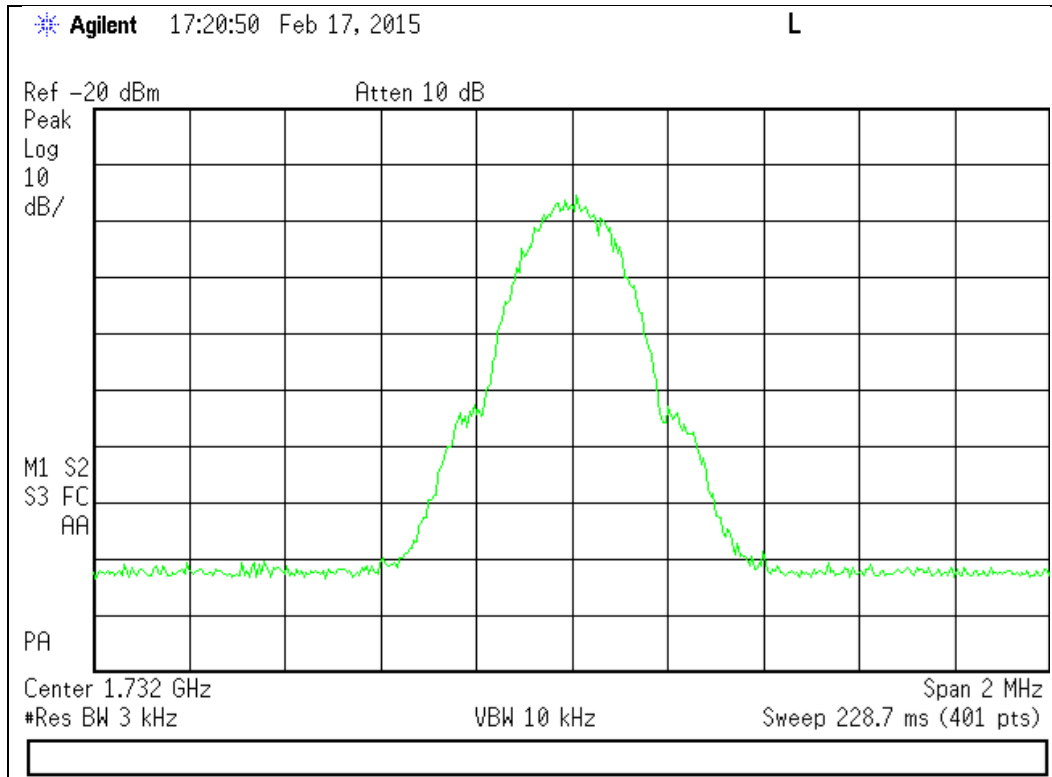

Output

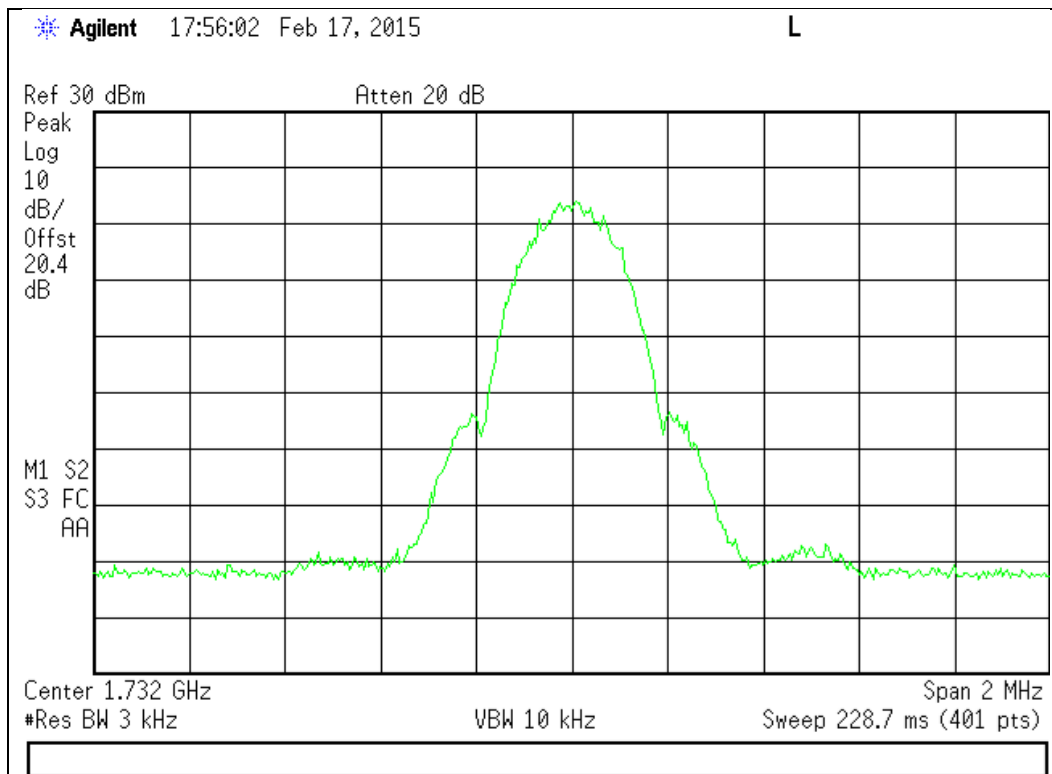

1850 - 1910 MHz Band

Input

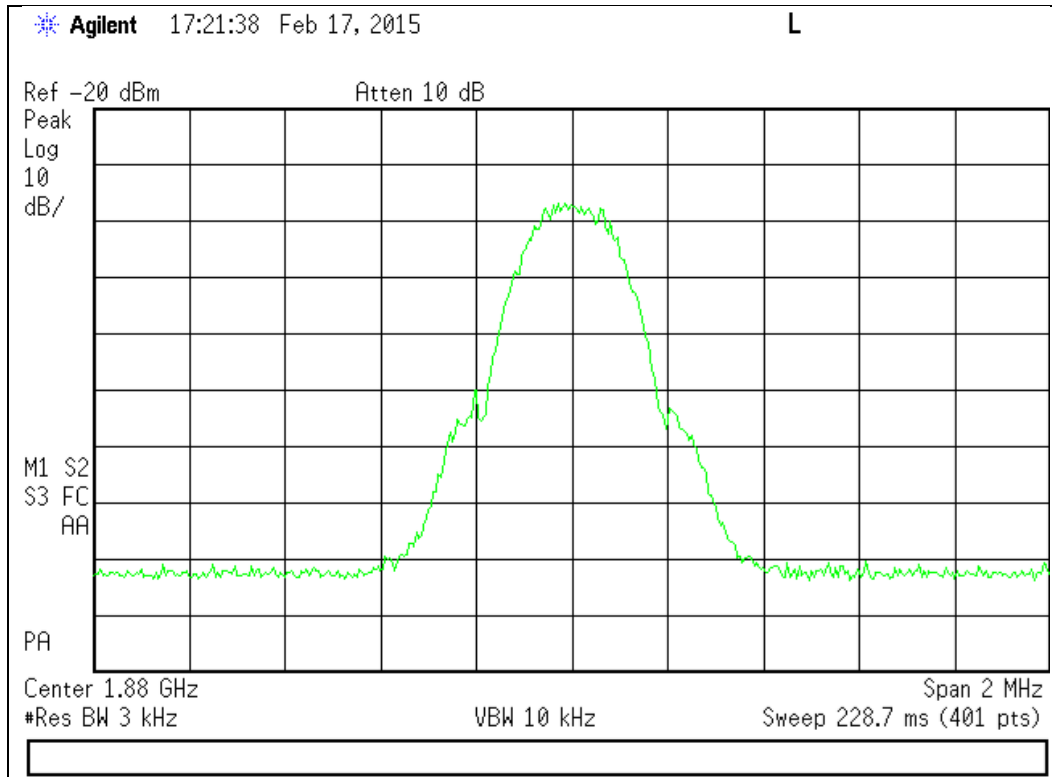

Output

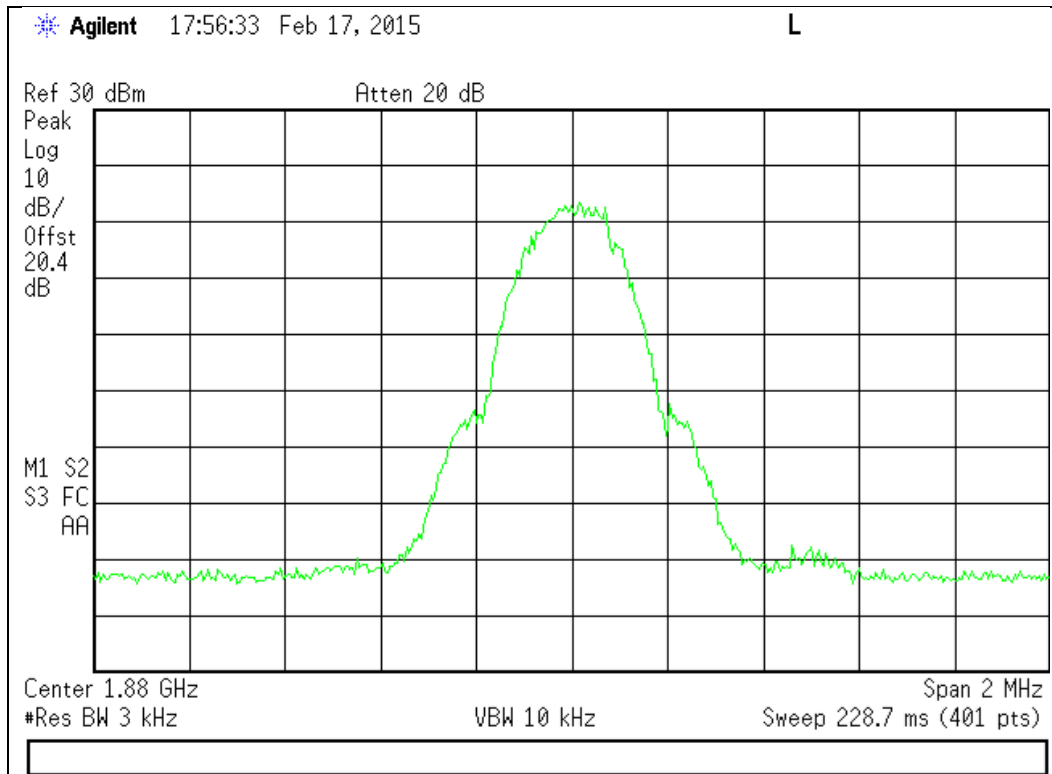

### GSM Downlink Test Plots

#### 728 - 746 MHz Band

#### Input

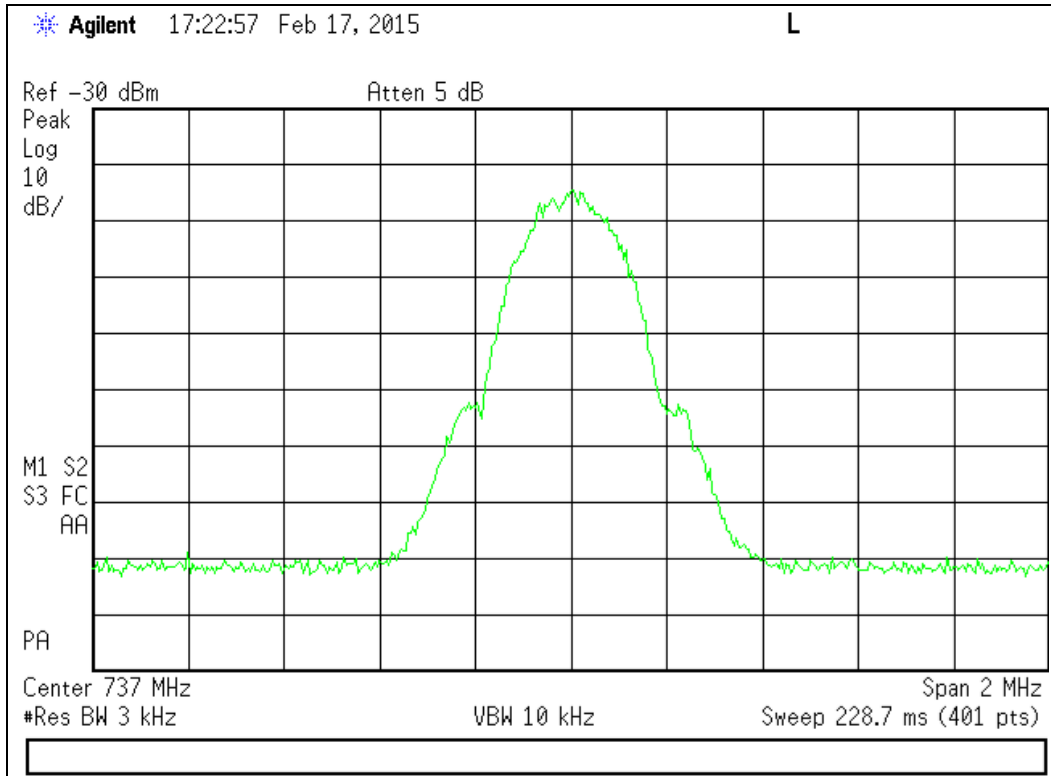

#### Output

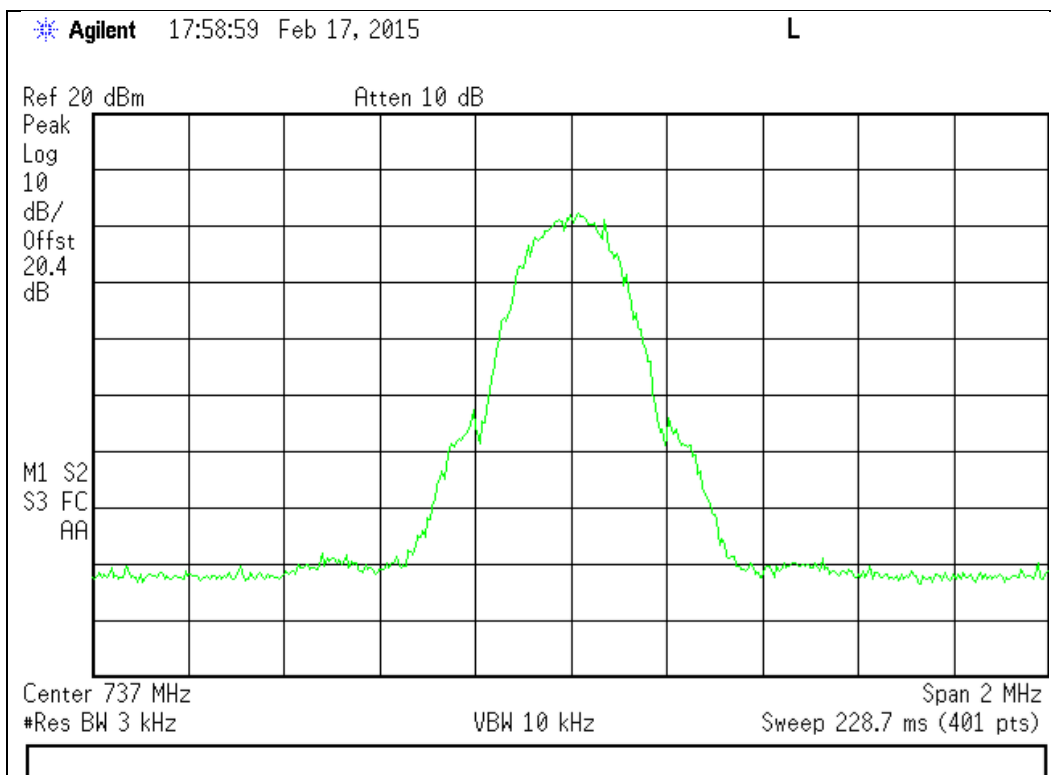



746 - 757 MHz Band

Input

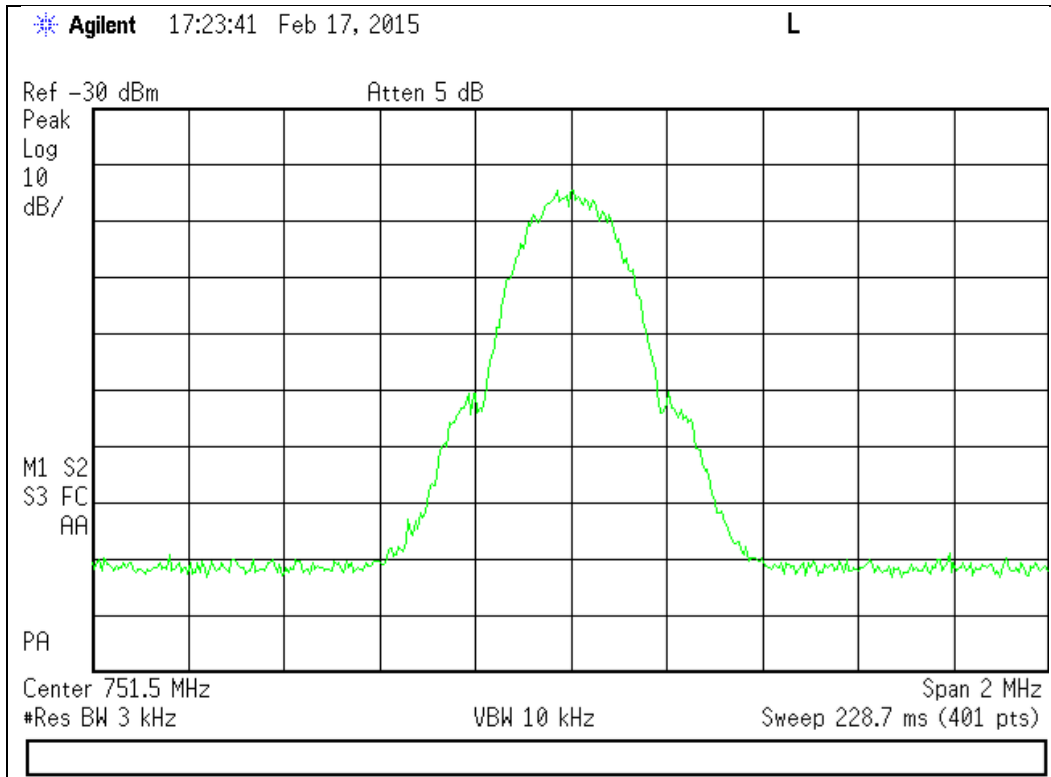

Output

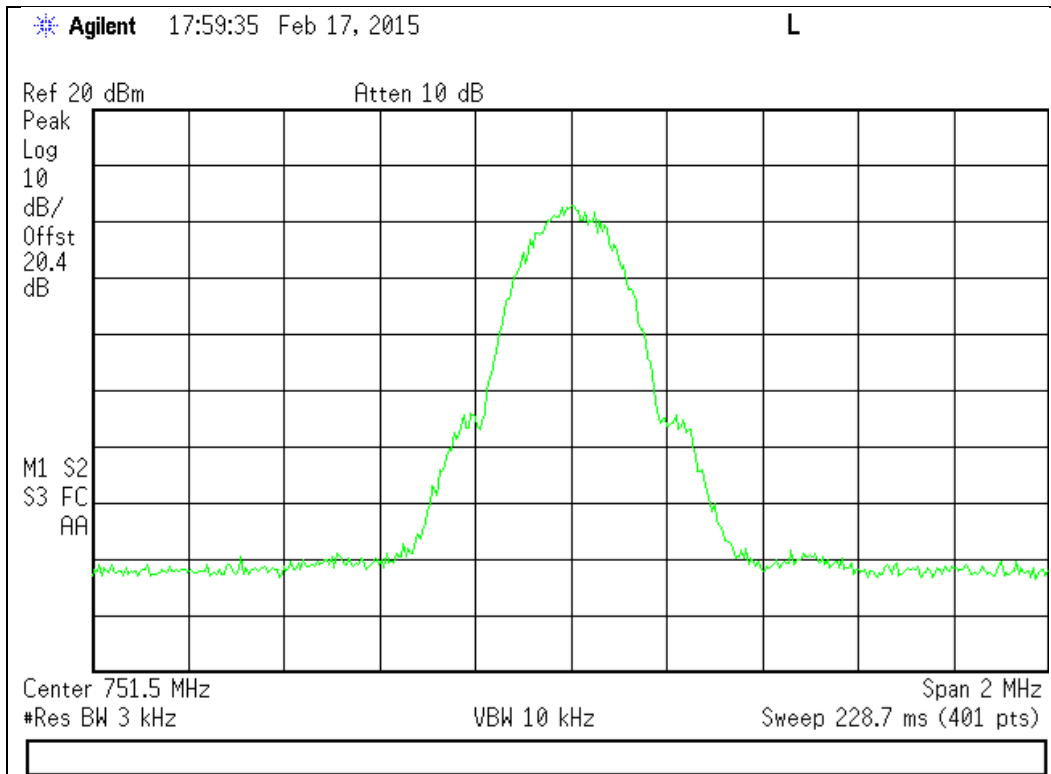

869 - 894 MHz Band

Input

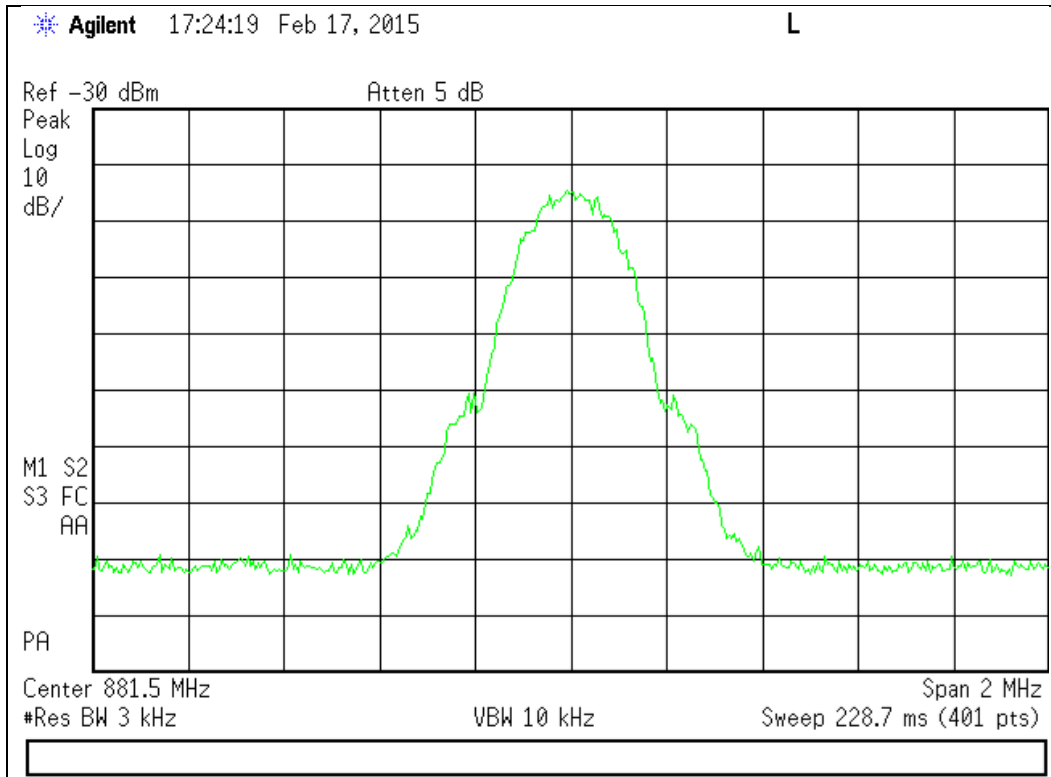

Output

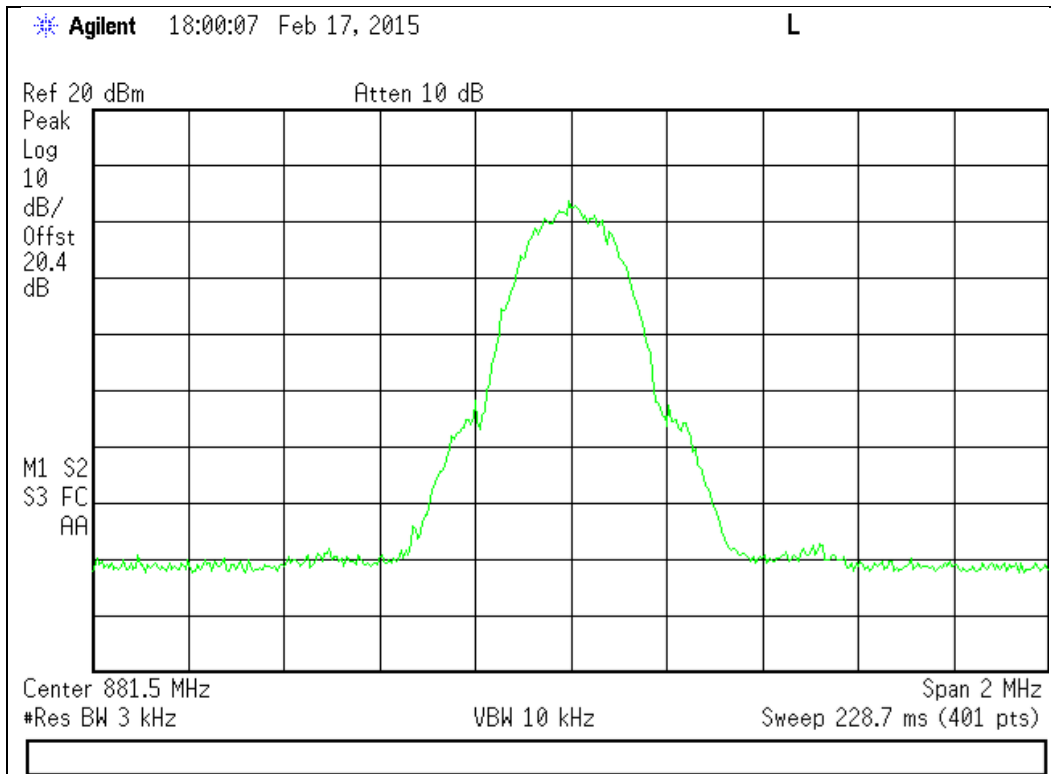

1930 - 1990 MHz Band

Input

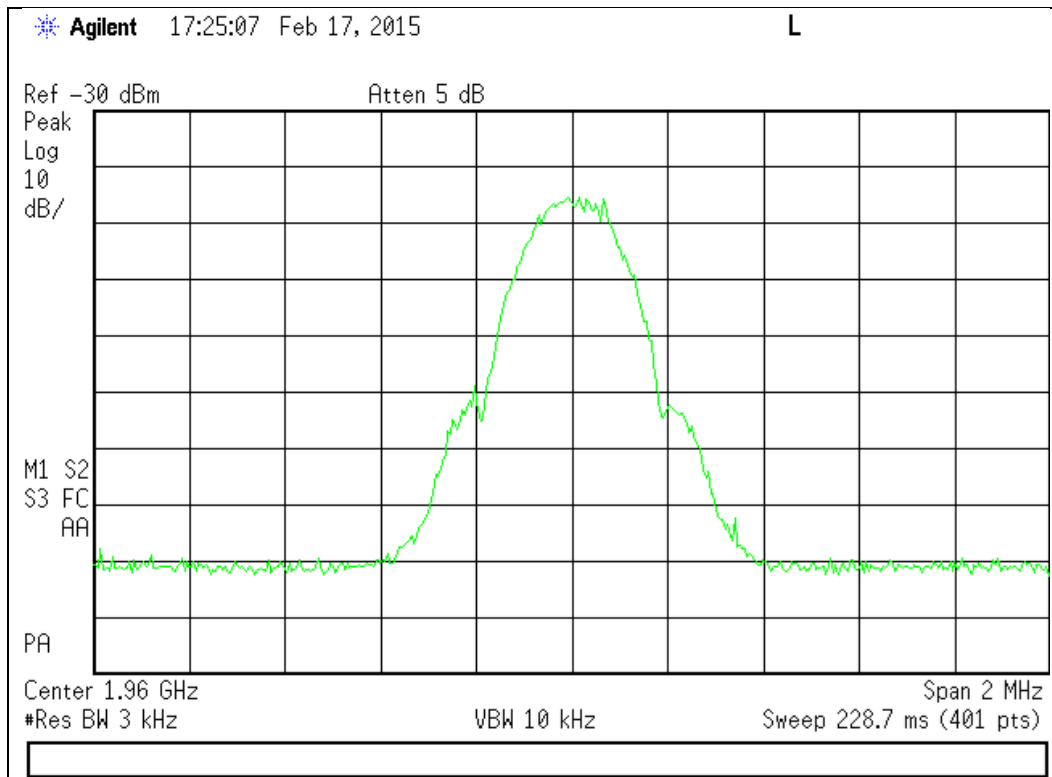

Output

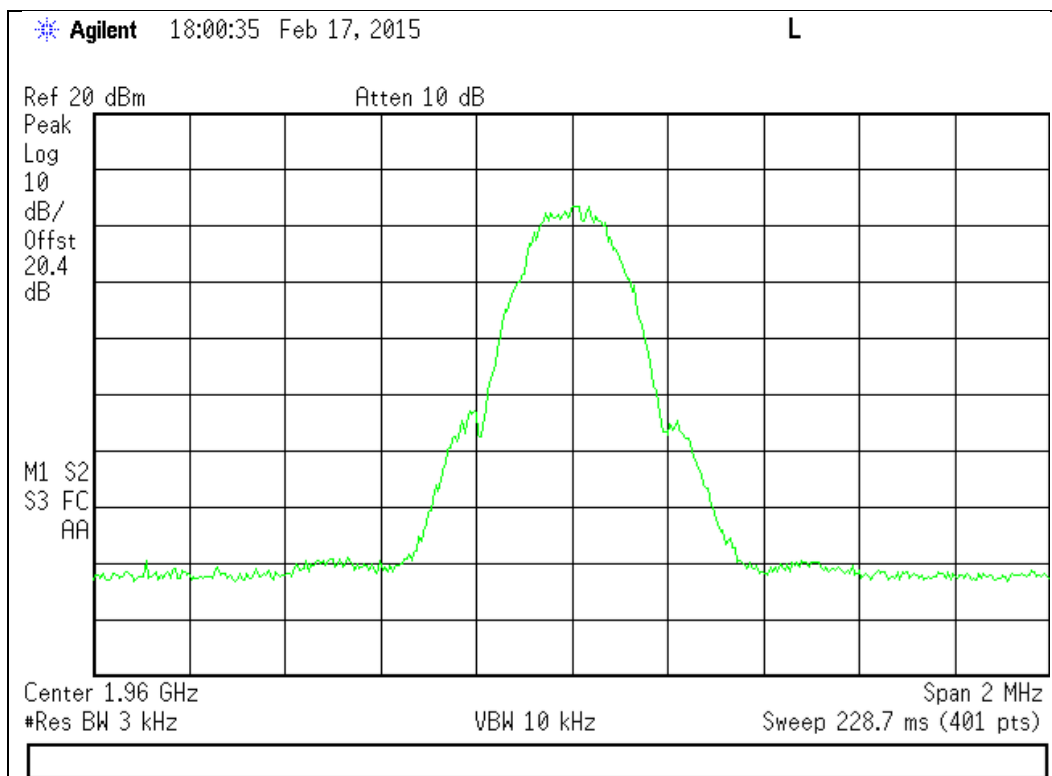

2110 - 2155 MHz Band

Input

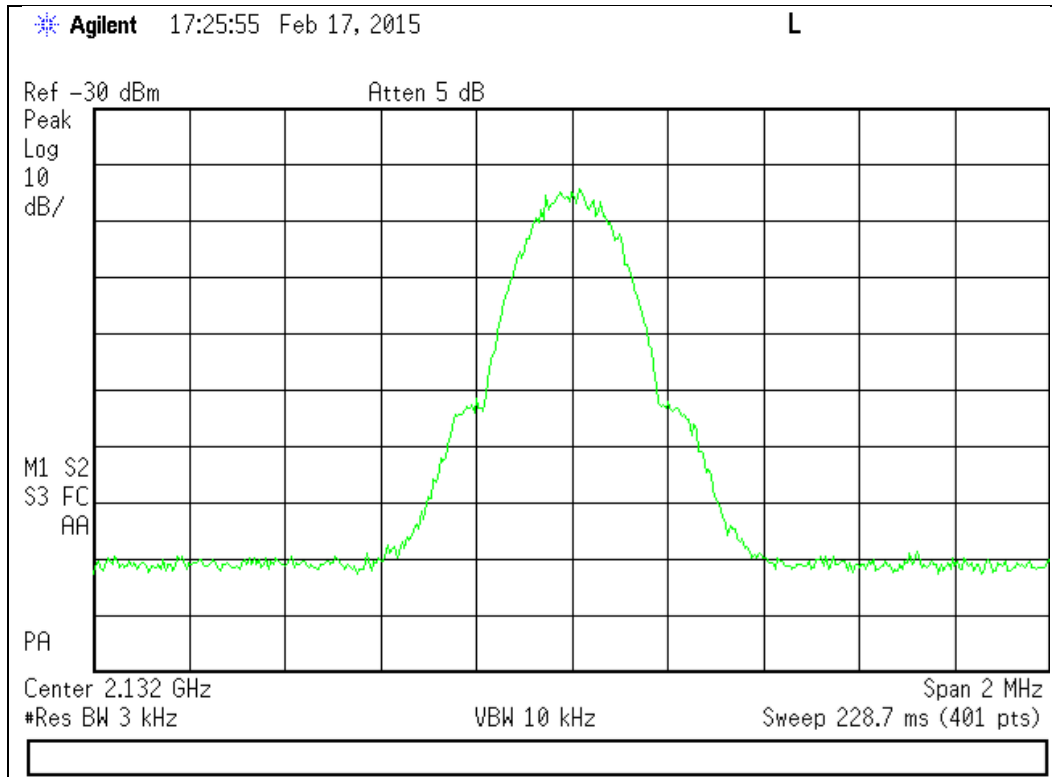

Output

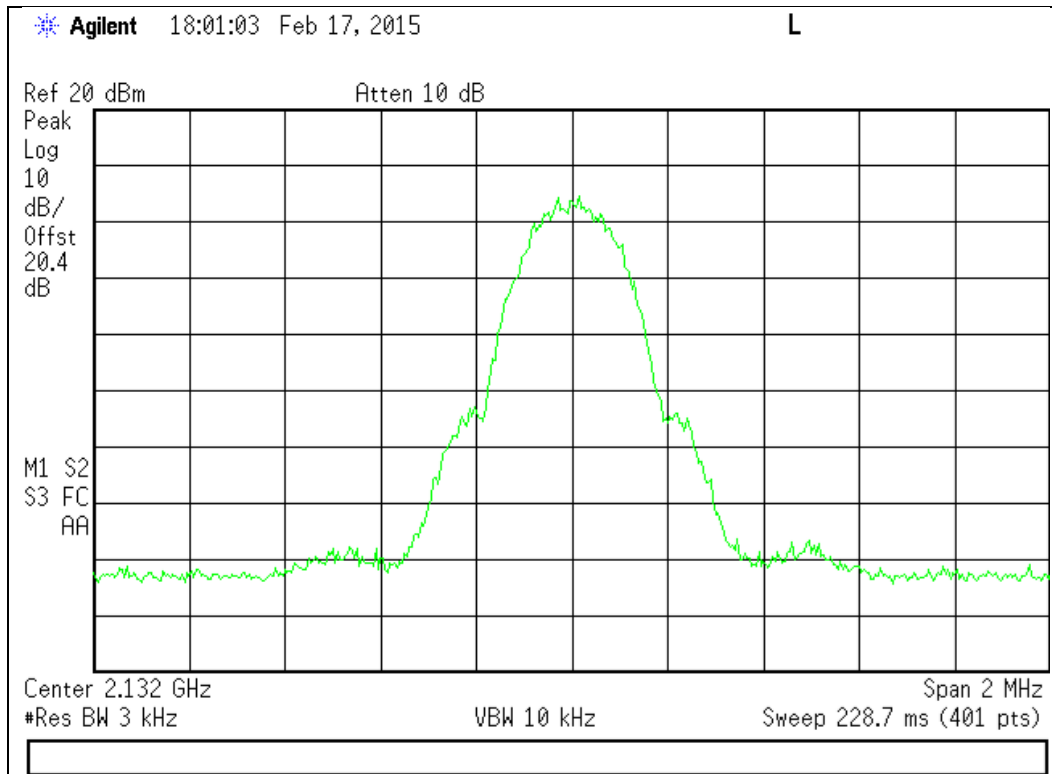

### CDMA Uplink Test Plots

698 - 716 MHz Band

#### Input

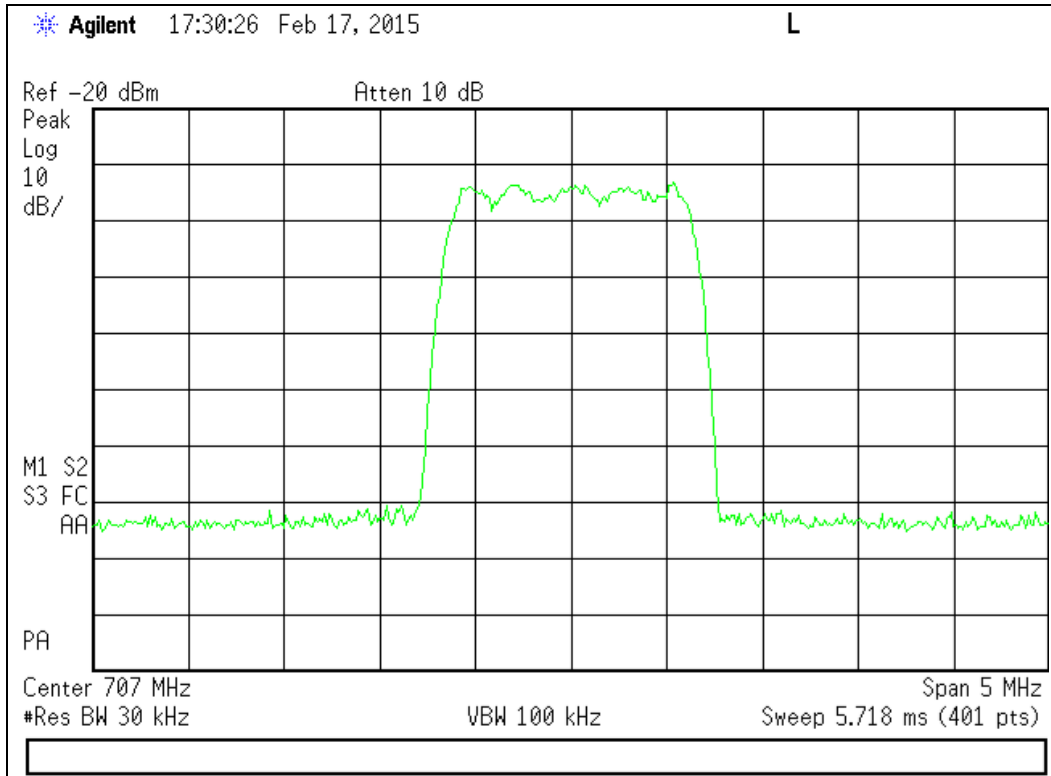

#### Output

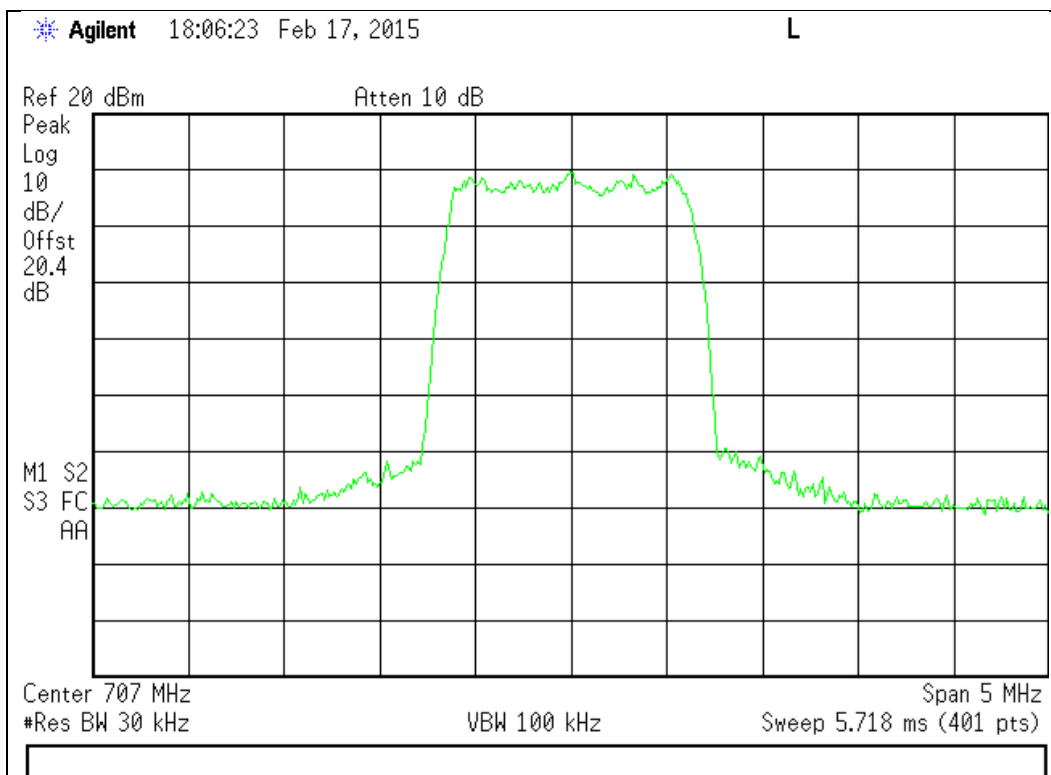

776 - 787 MHz Band

Input

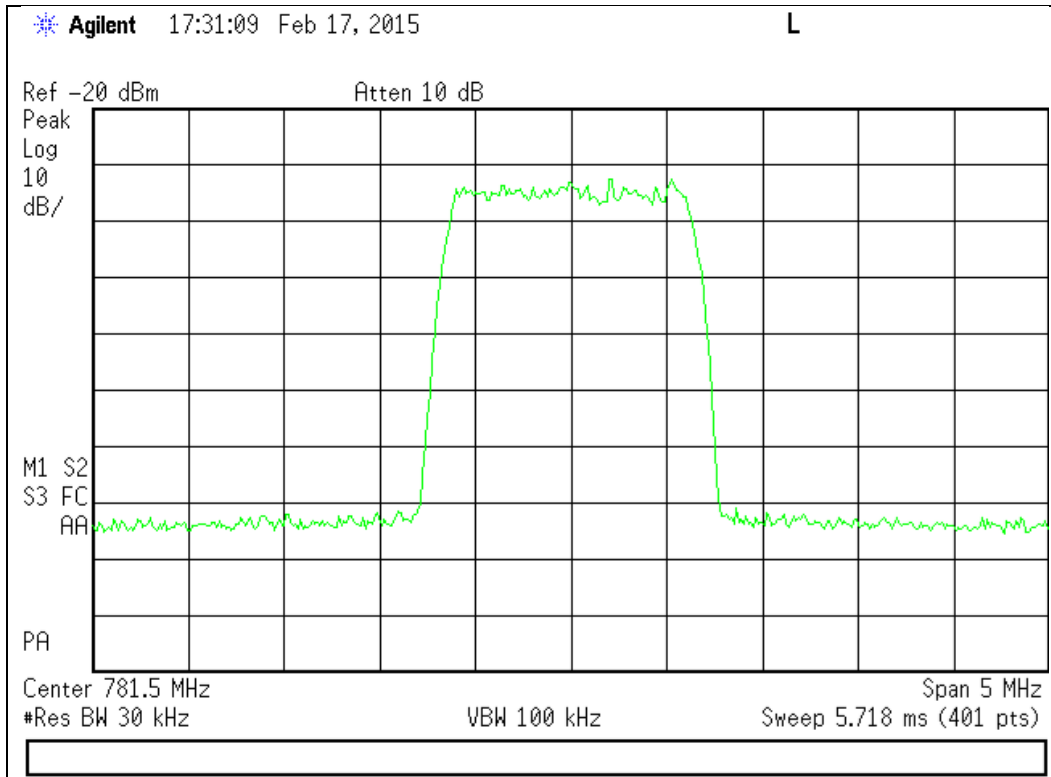

Output

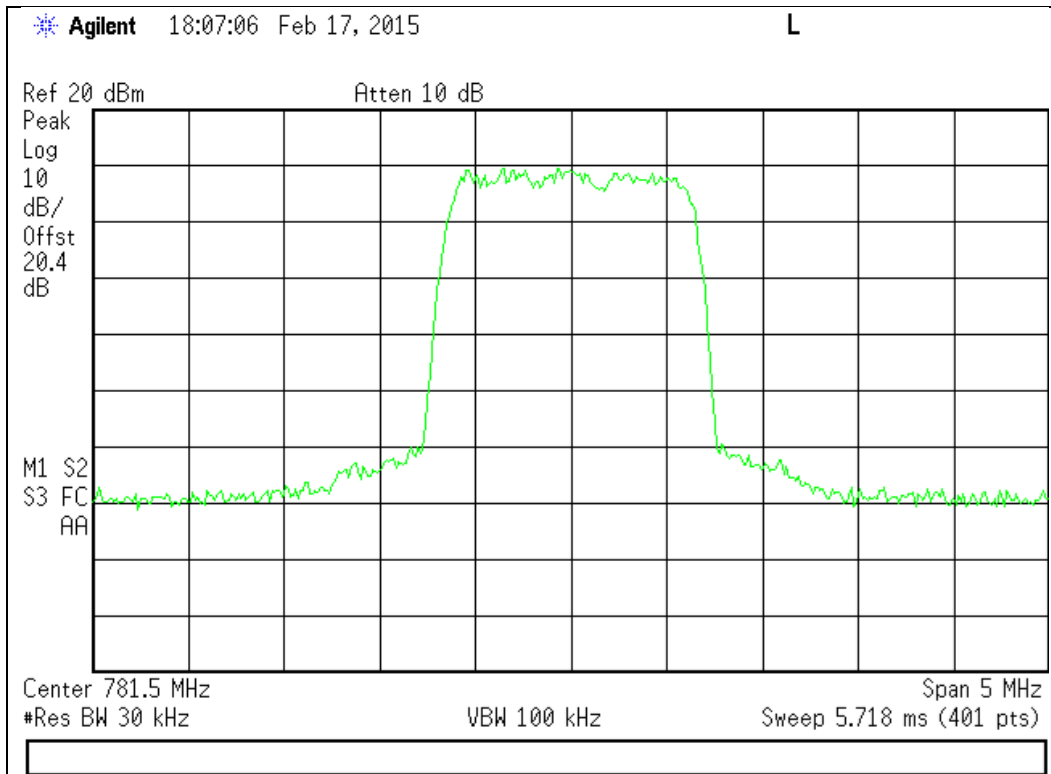

824 - 849 MHz Band

Input

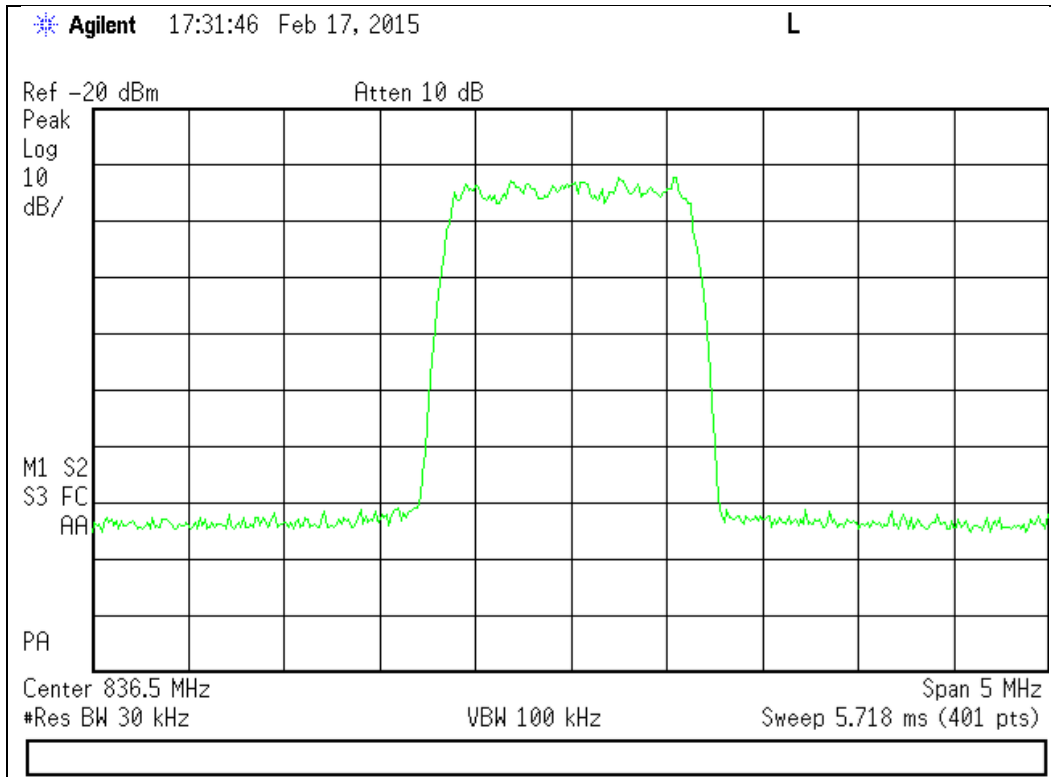

Output

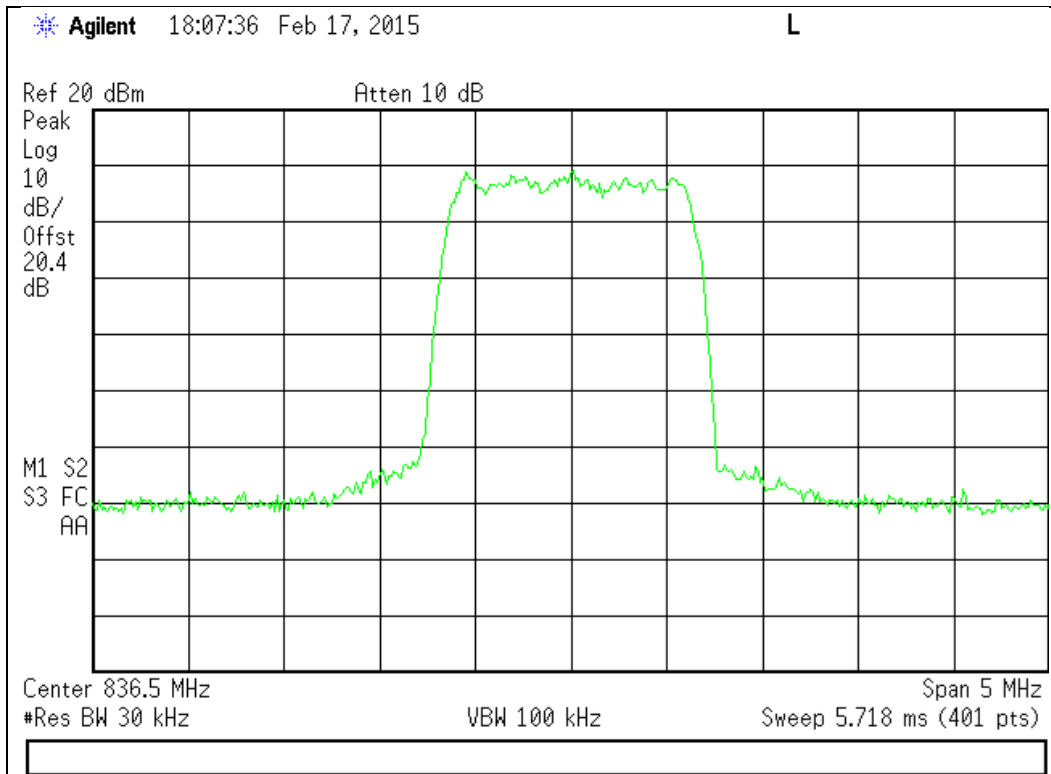

1710 - 1755 MHz Band

Input

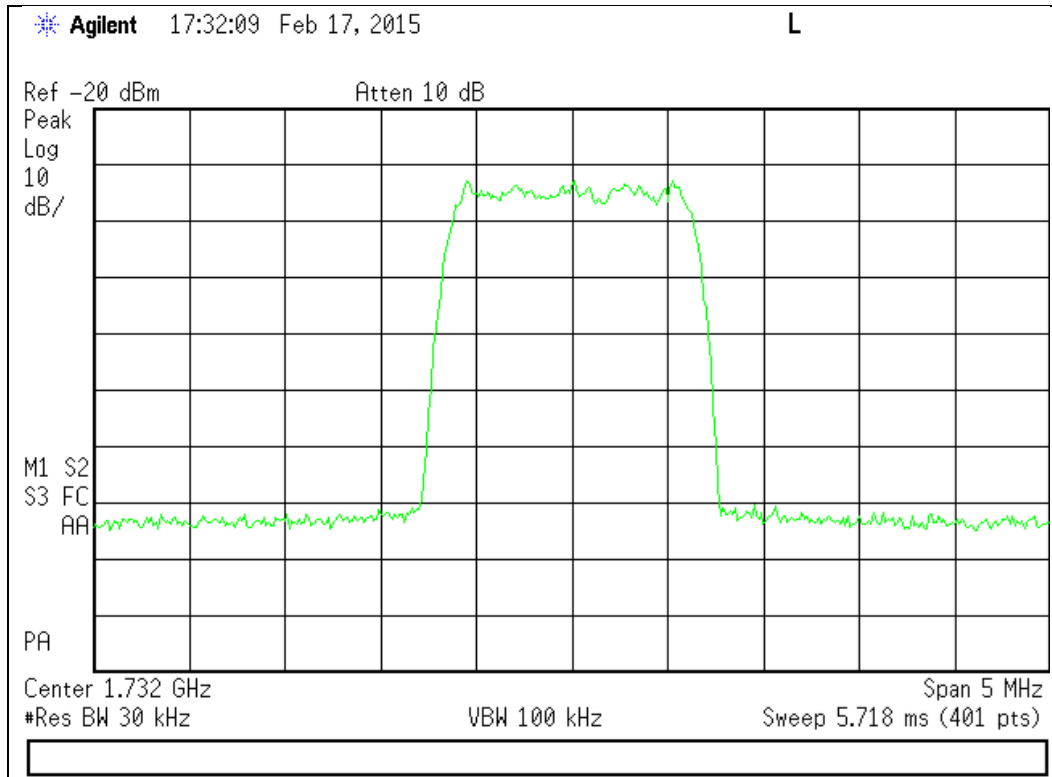

Output

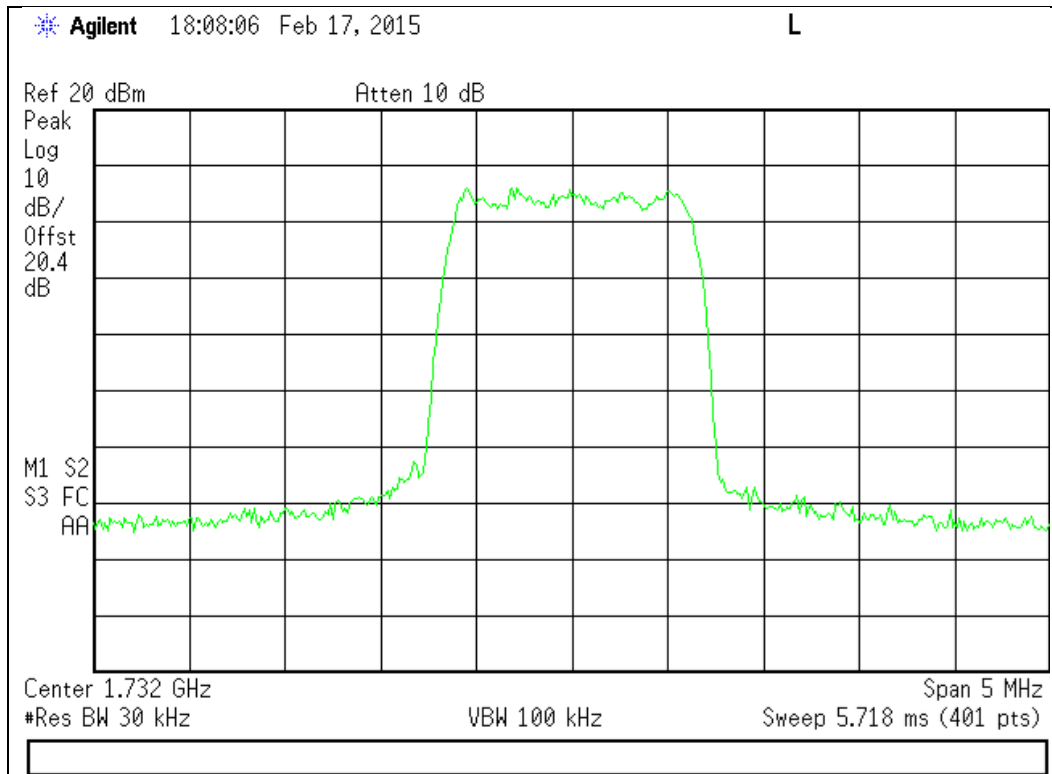



1850 - 1910 MHz Band

Input

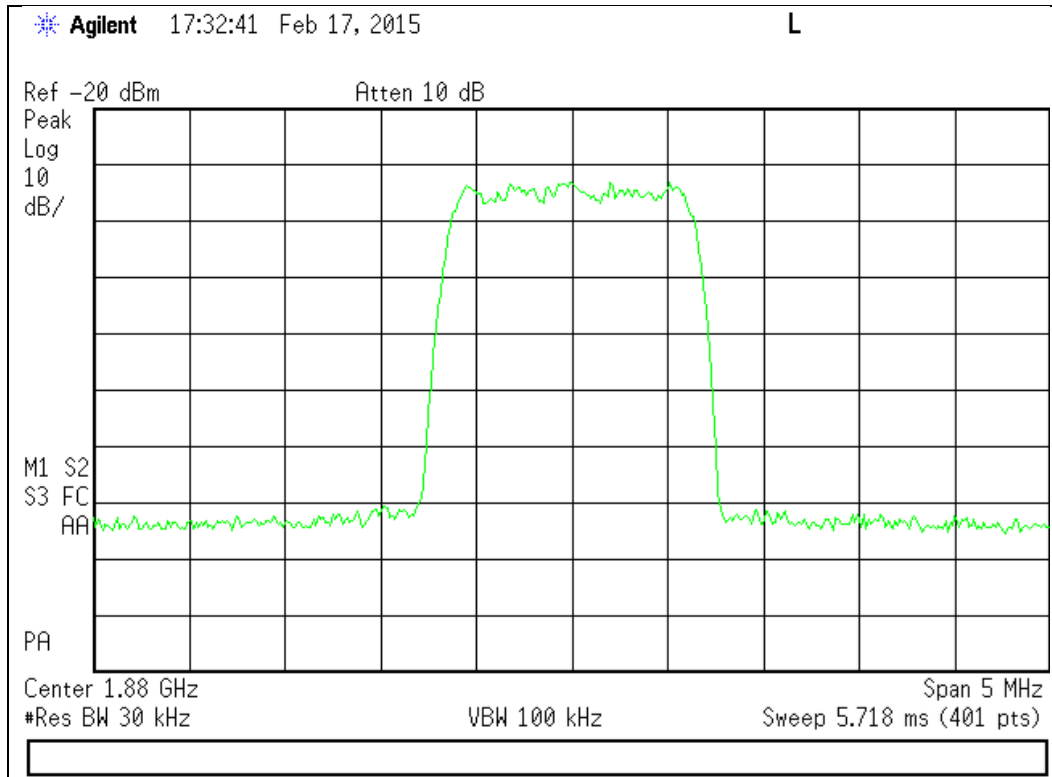

Output

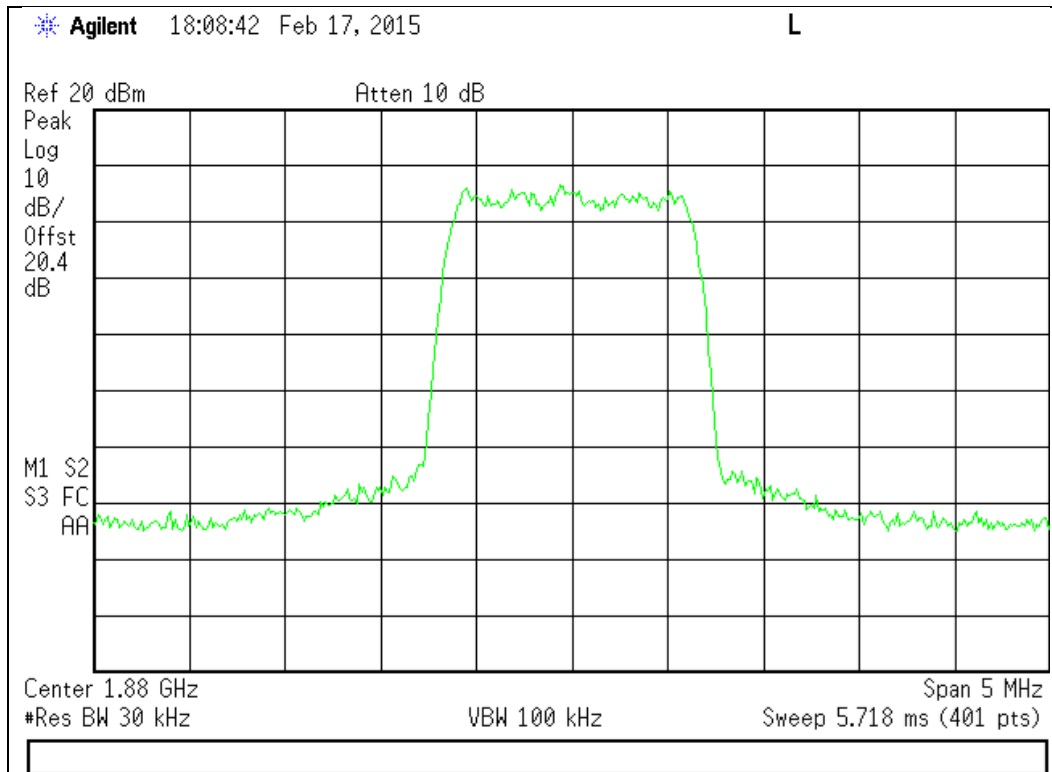

CDMA Downlink Test Plots

728 - 746 MHz Band

Input

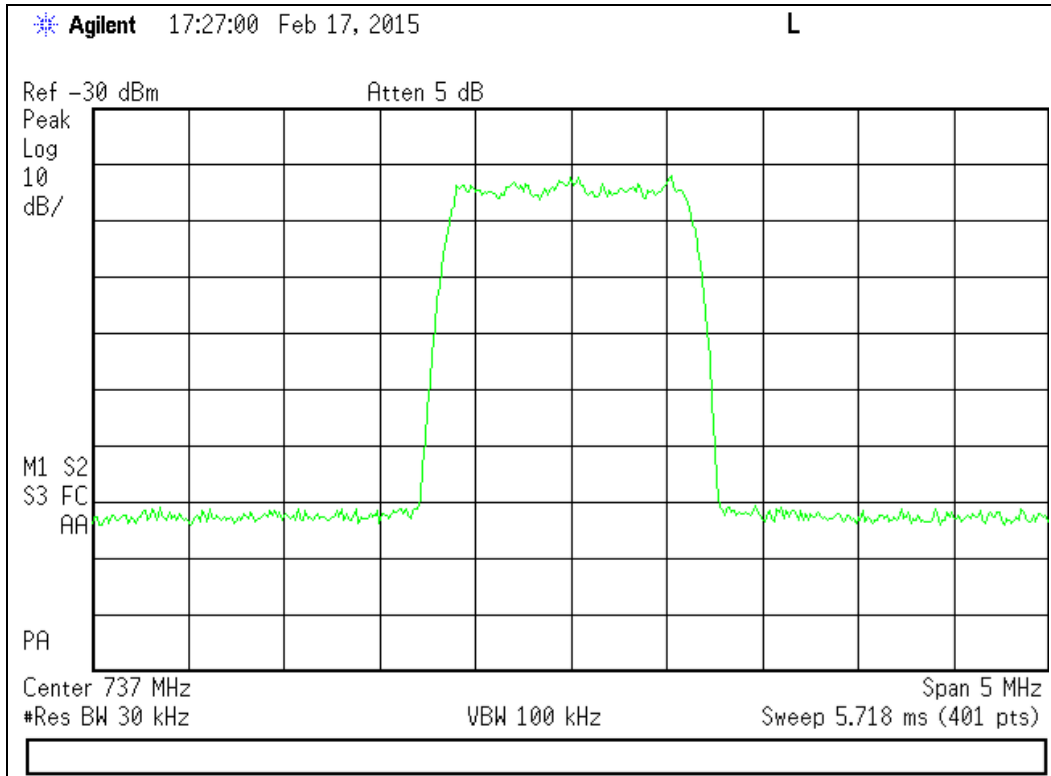

Output

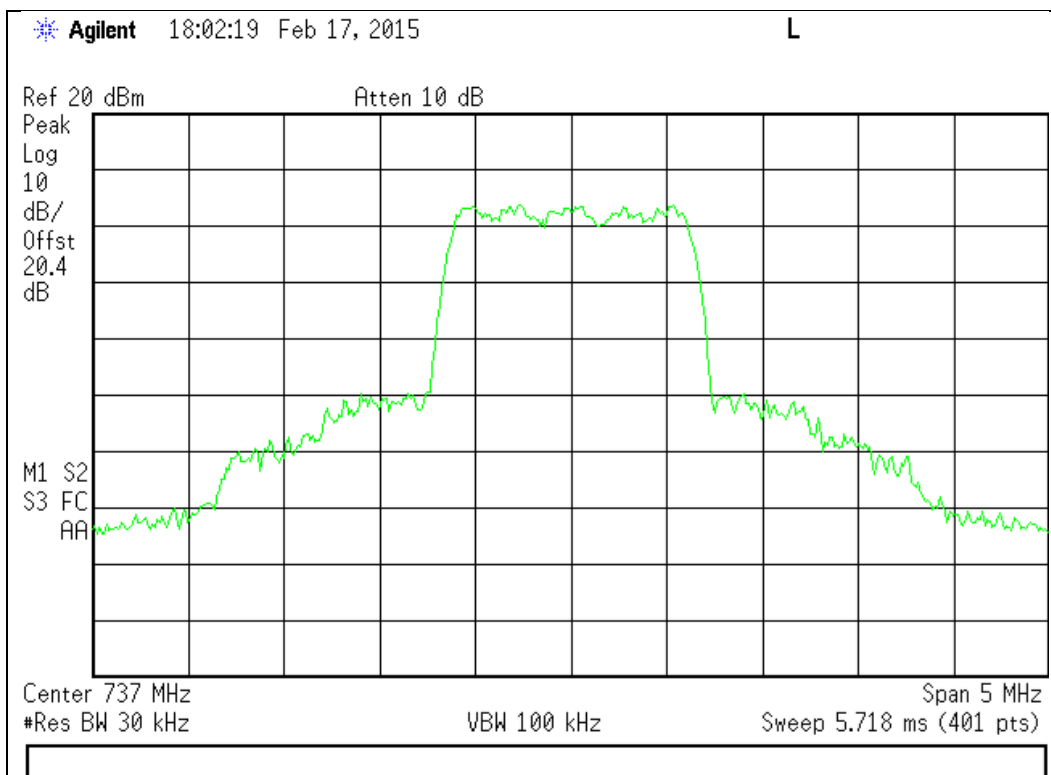

746 - 757 MHz Band

Input

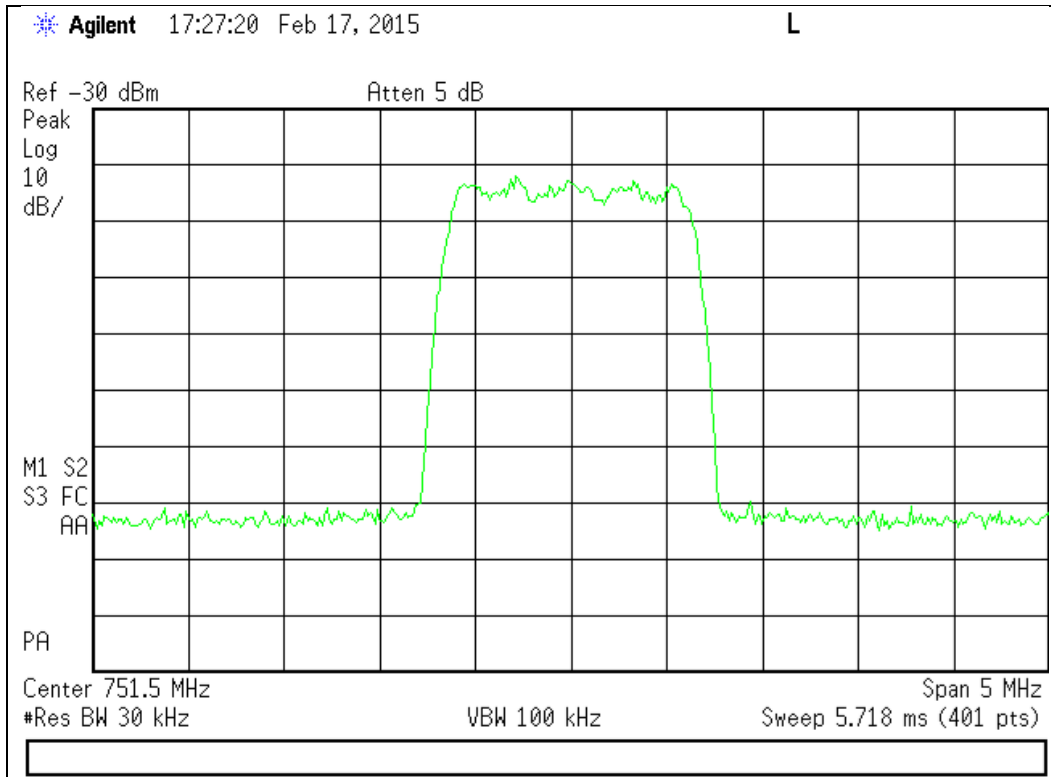

Output

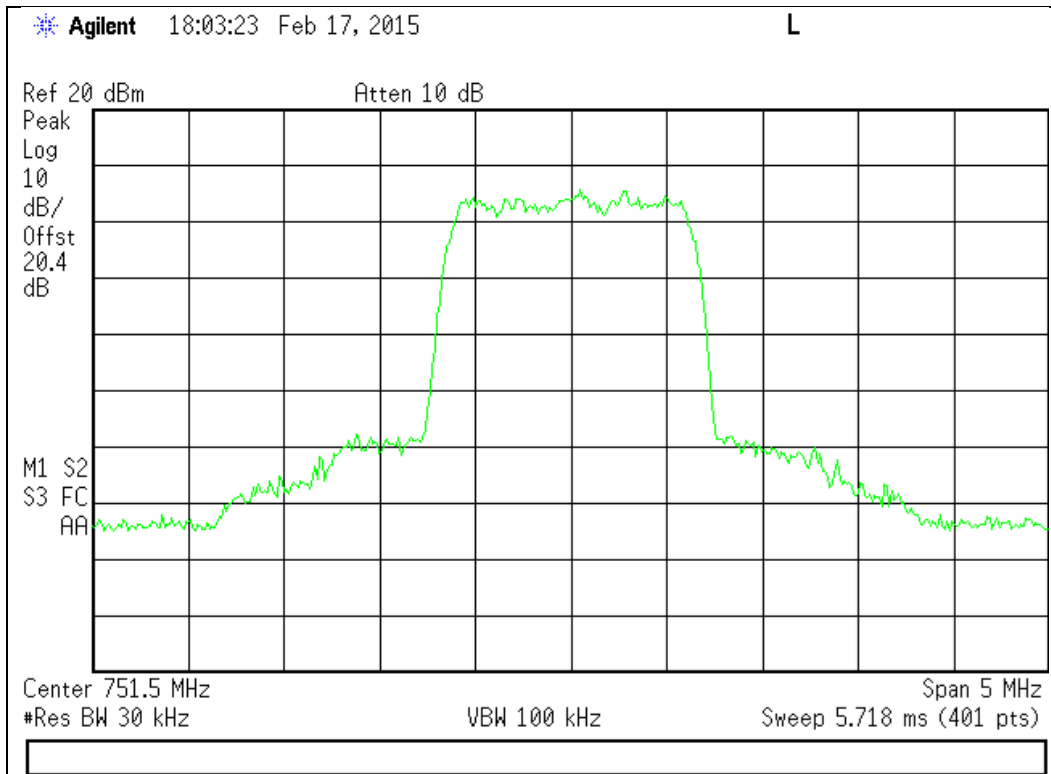

869 - 894 MHz Band

Input

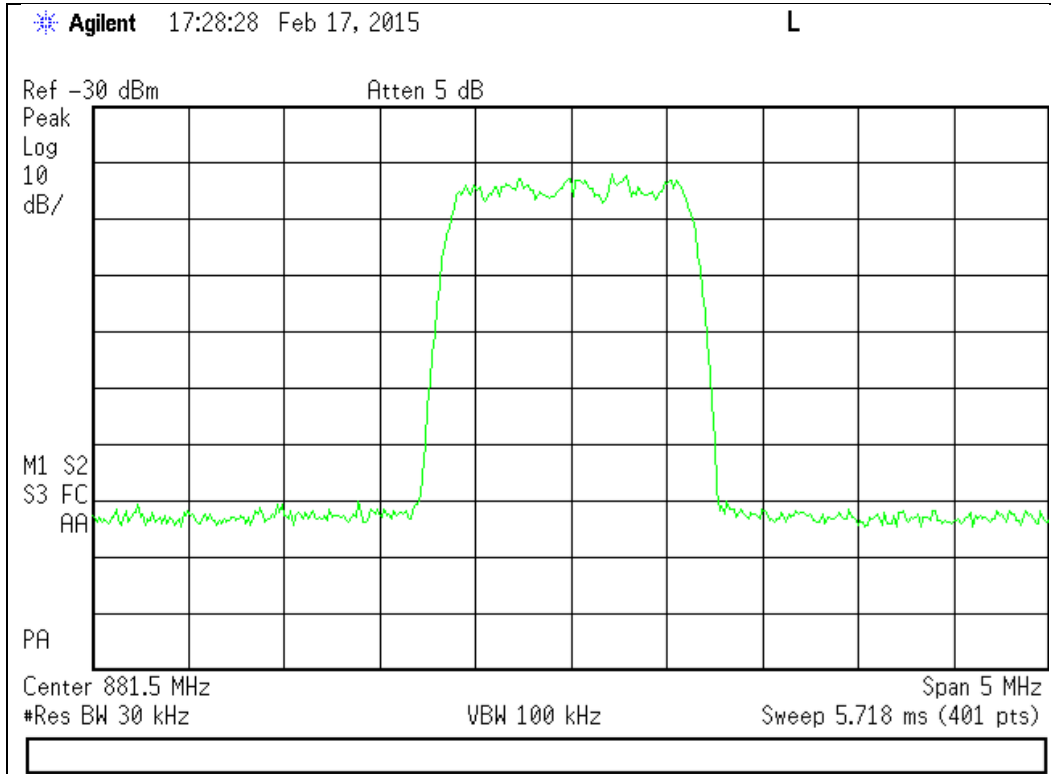

Output

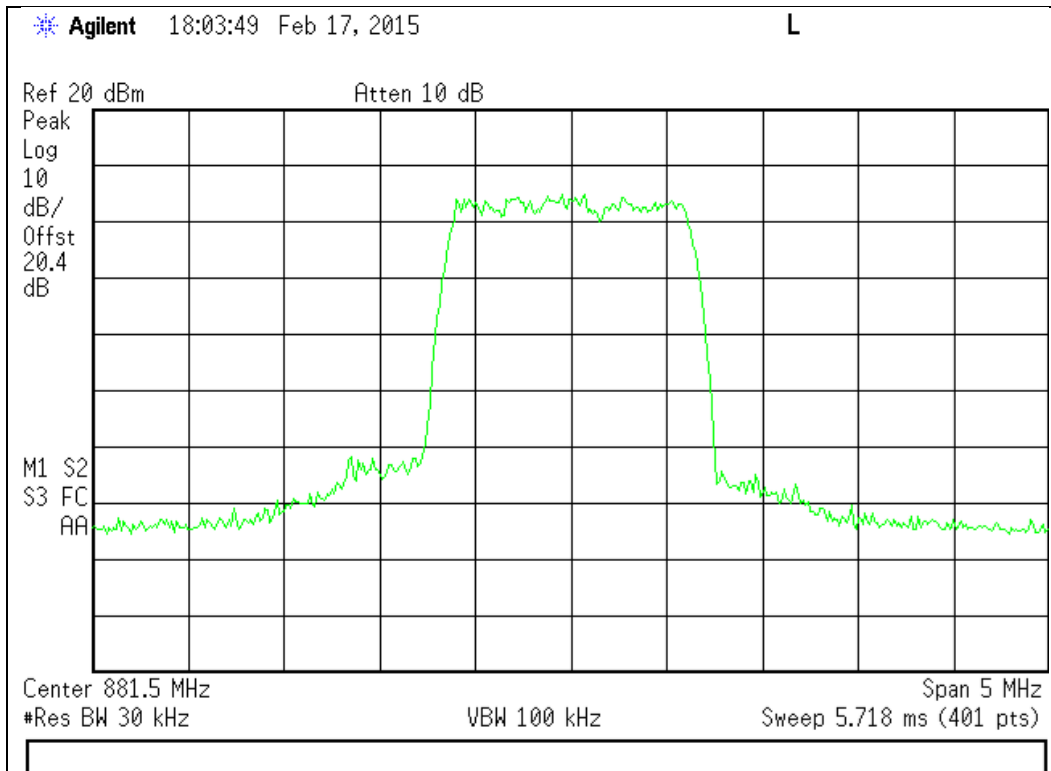

1930 - 1990 MHz Band

Input

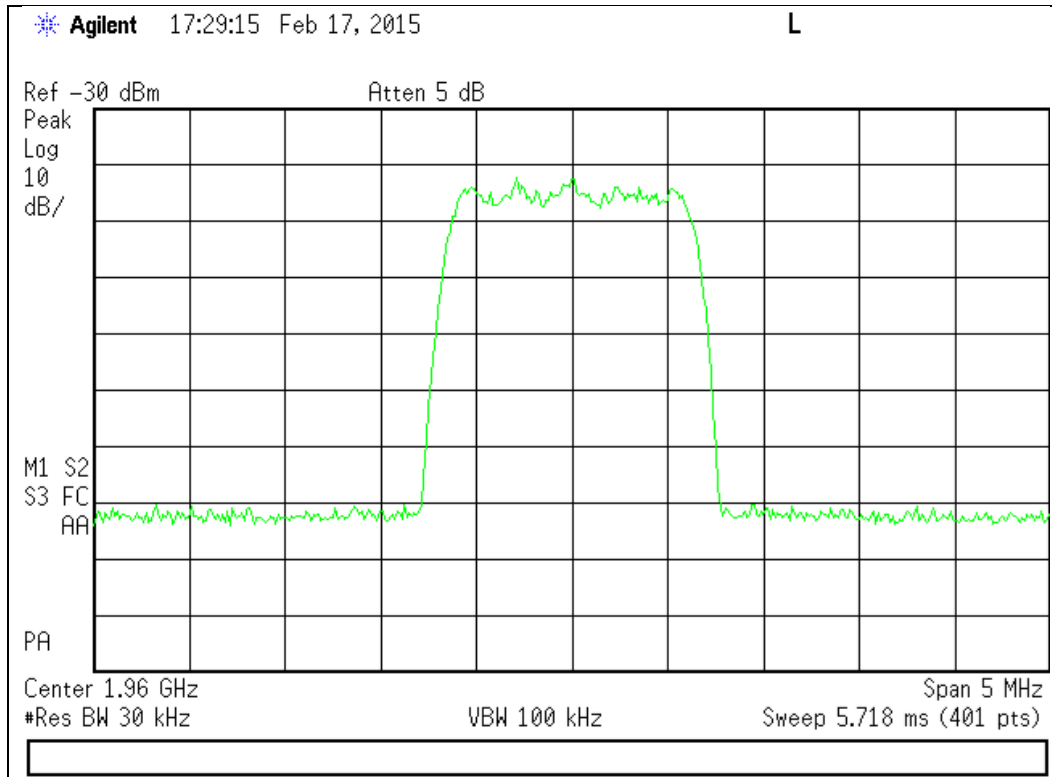

Output

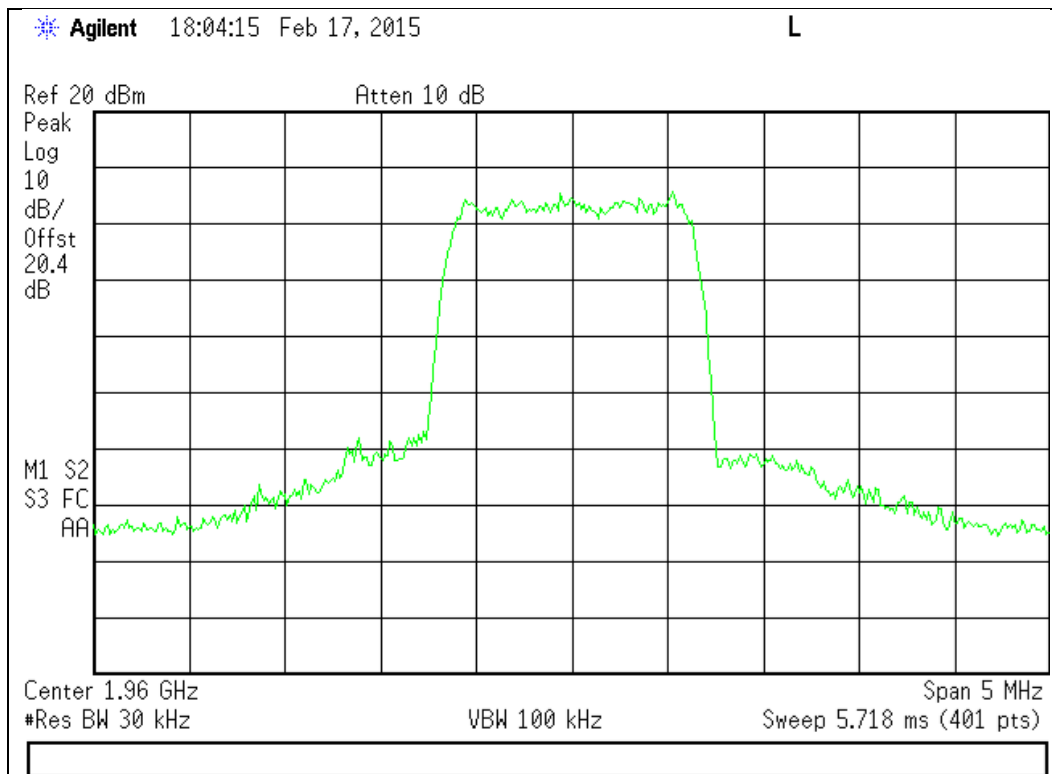

2110 - 2155 MHz Band

Input

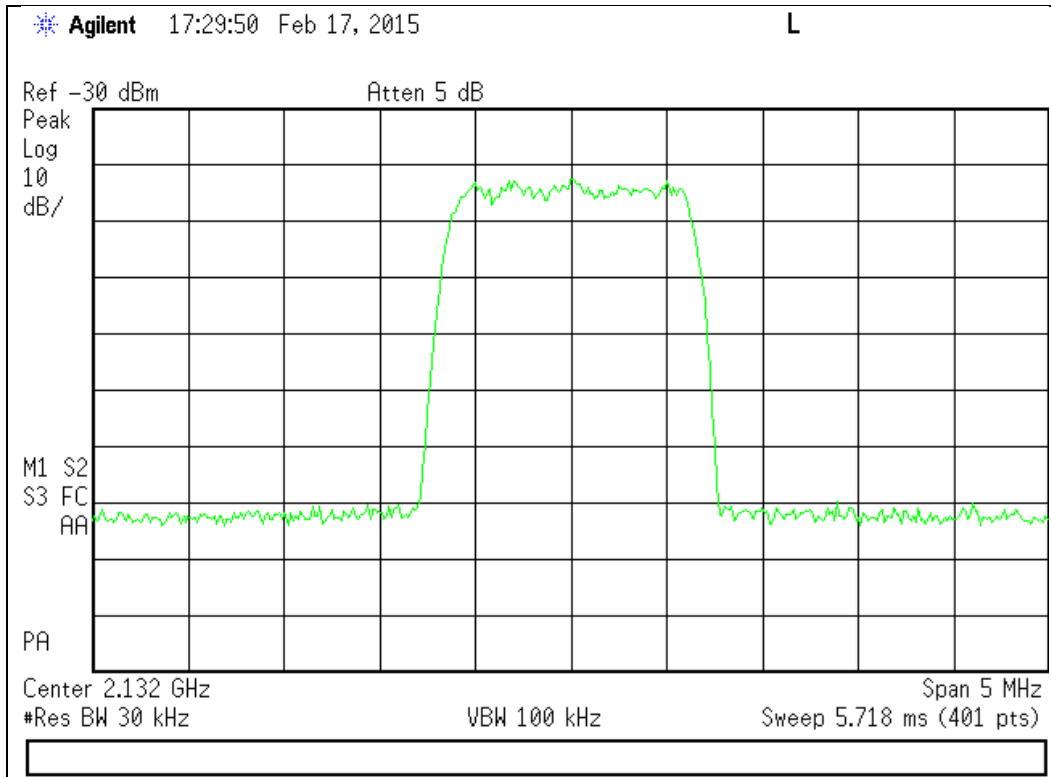

Output

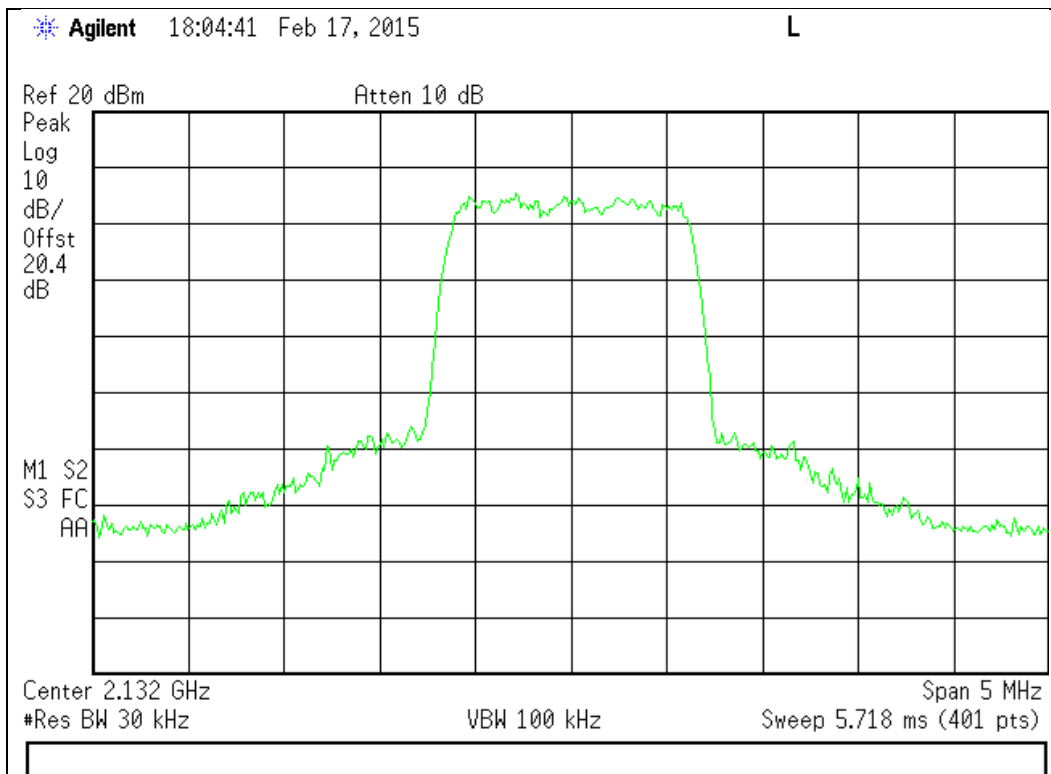

### WCDMA Uplink Test Plots

698 - 716 MHz Band

Input

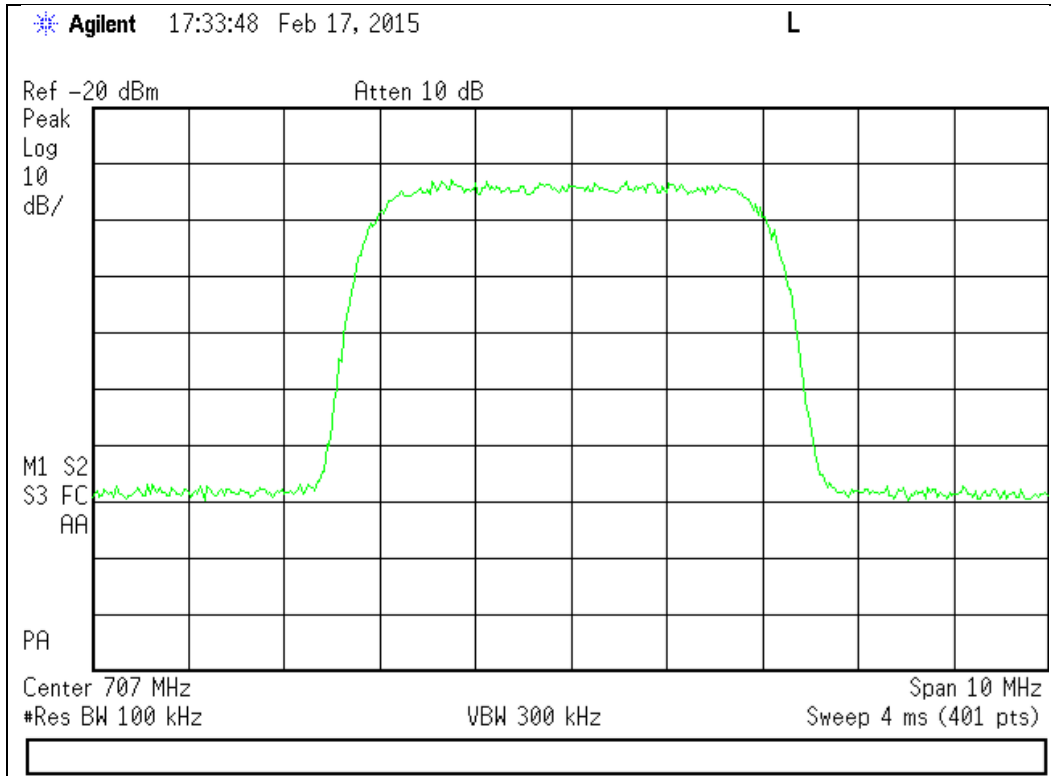

Output

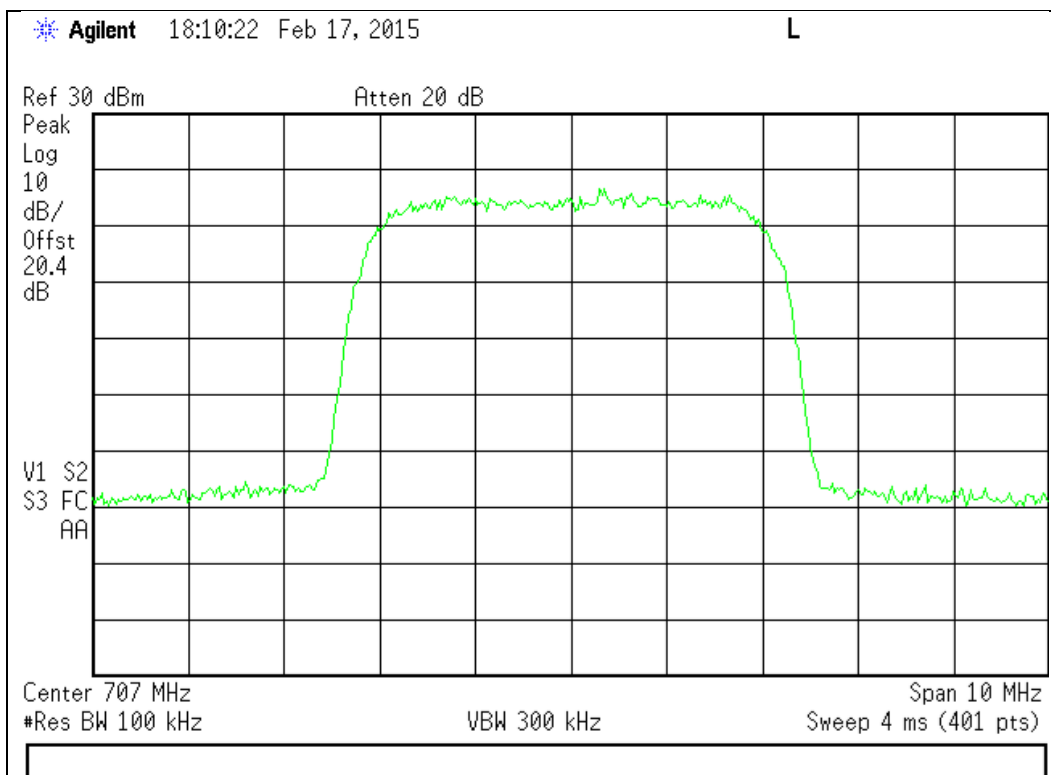

776 - 787 MHz Band

Input

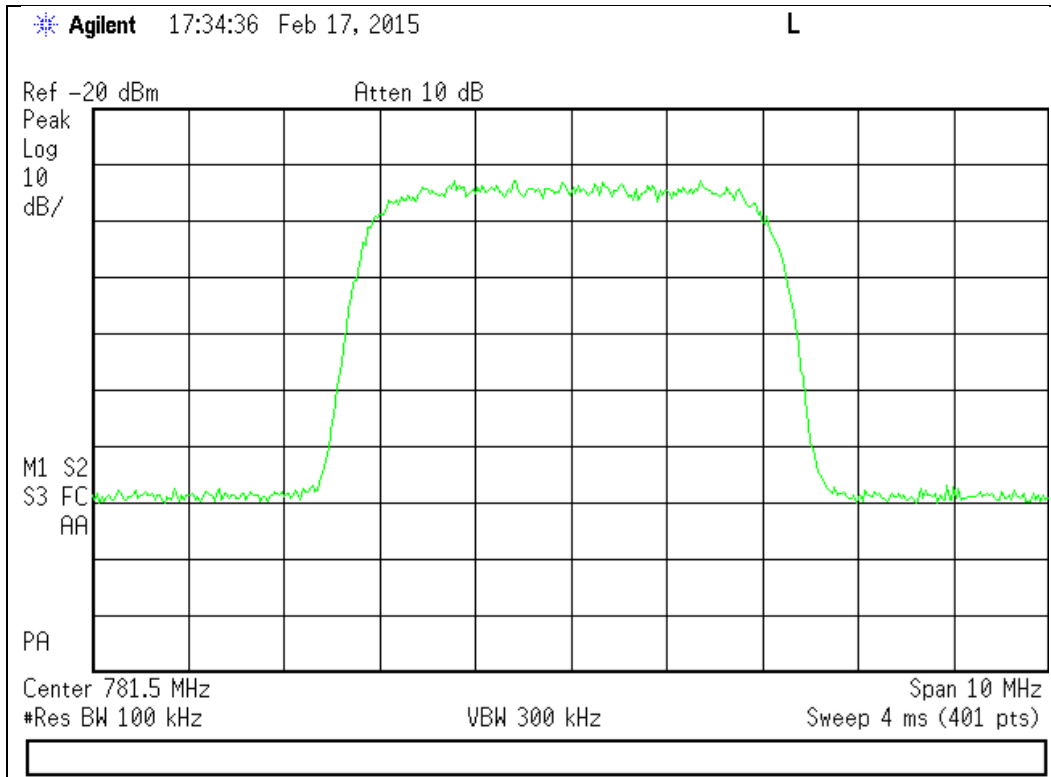

Output

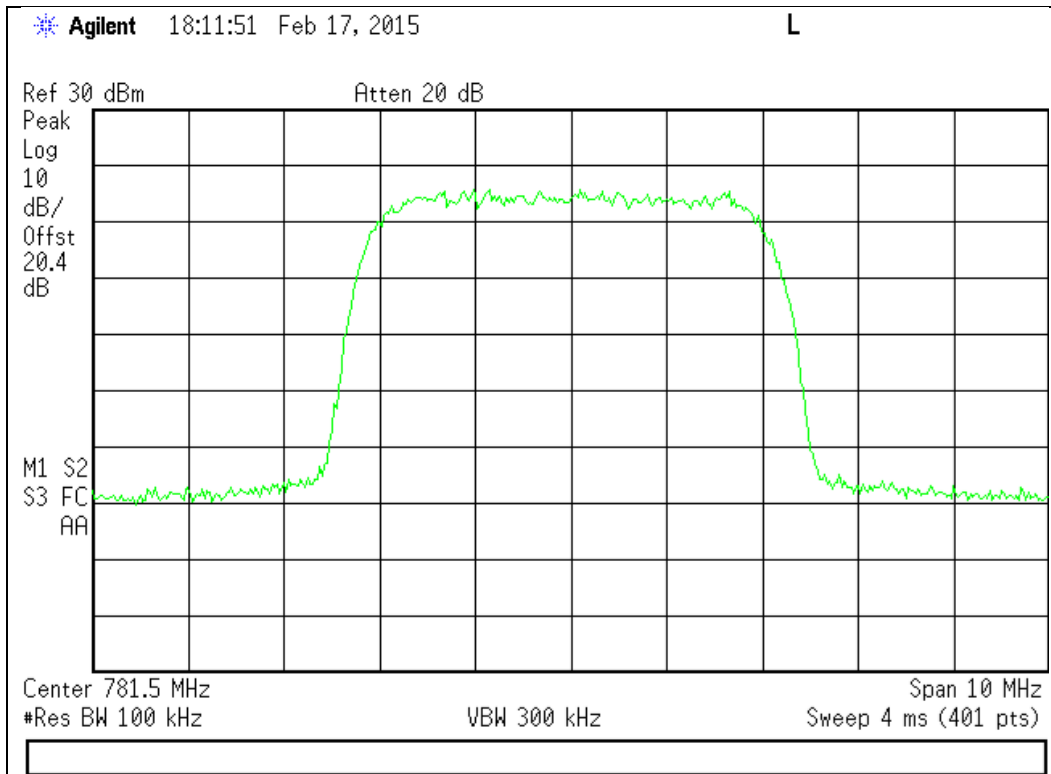



824 - 849 MHz Band

Input

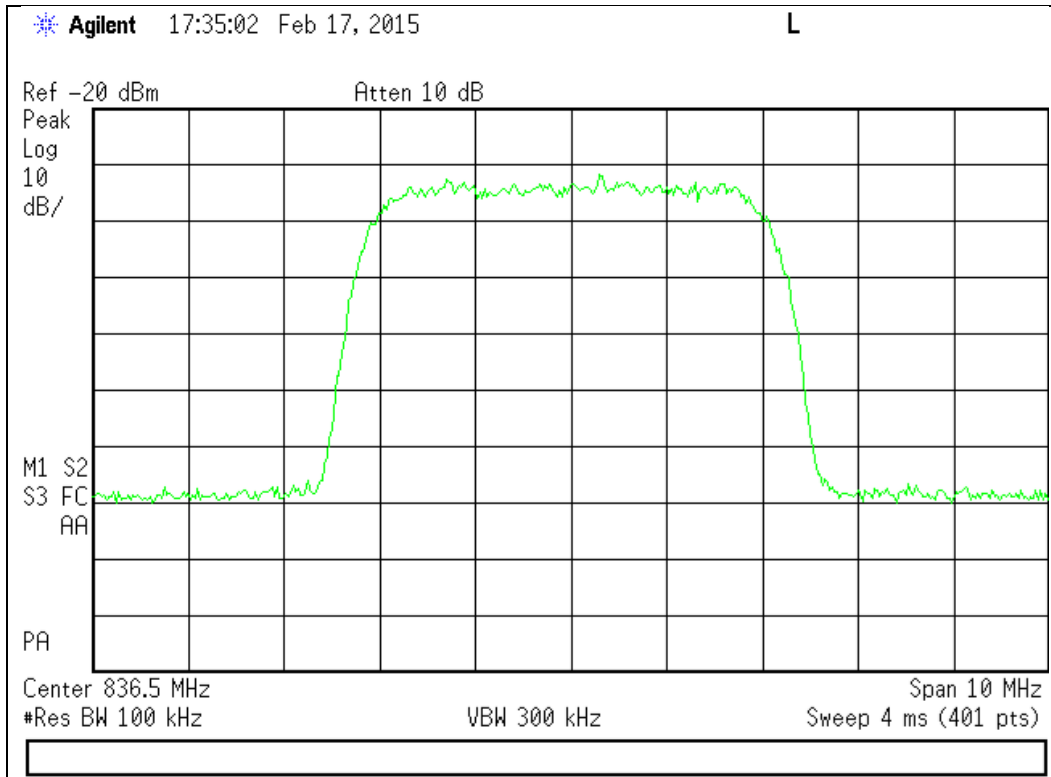

Output

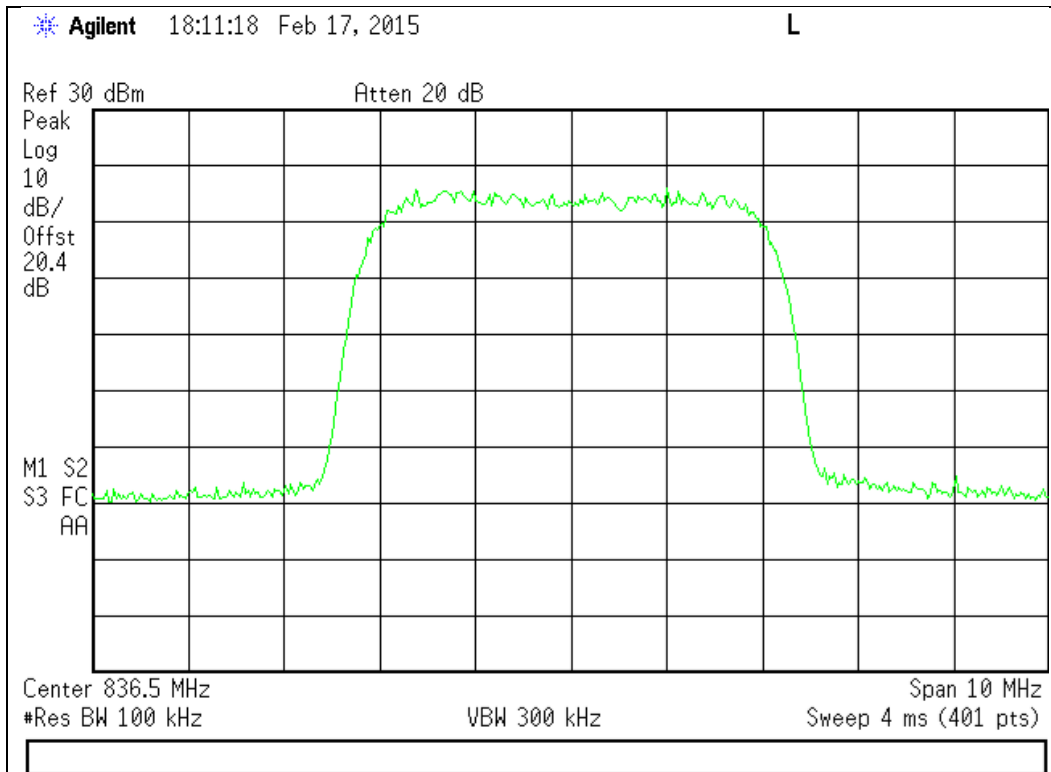

1710 - 1755 MHz Band

Input

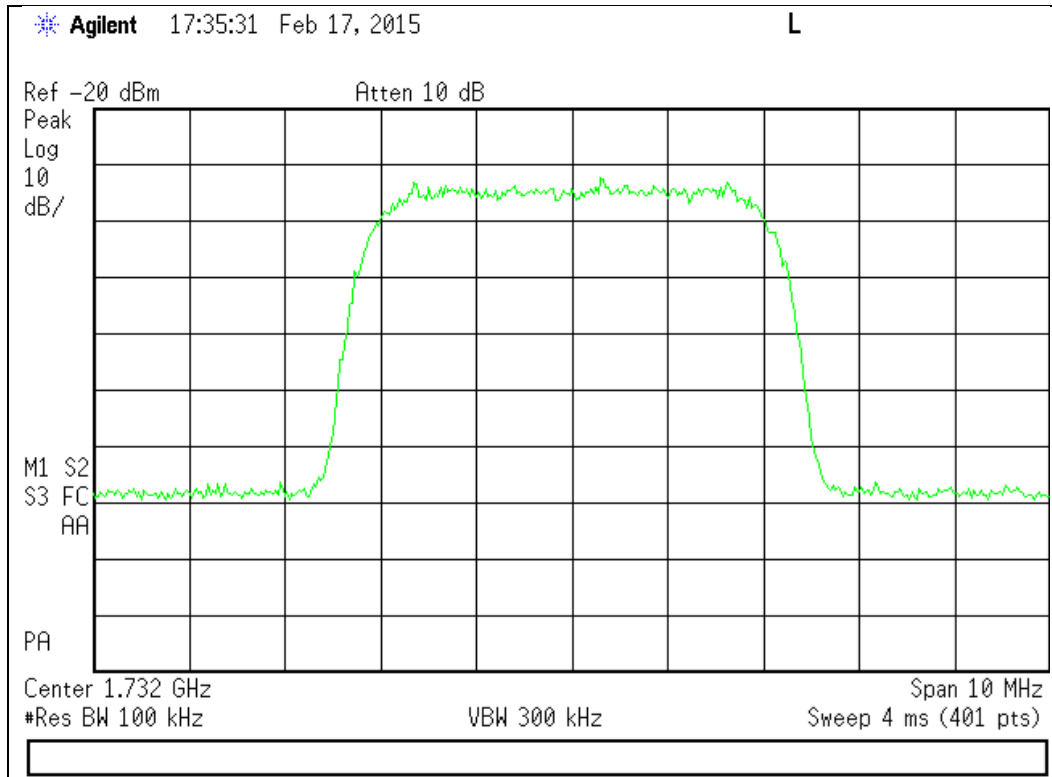

Output

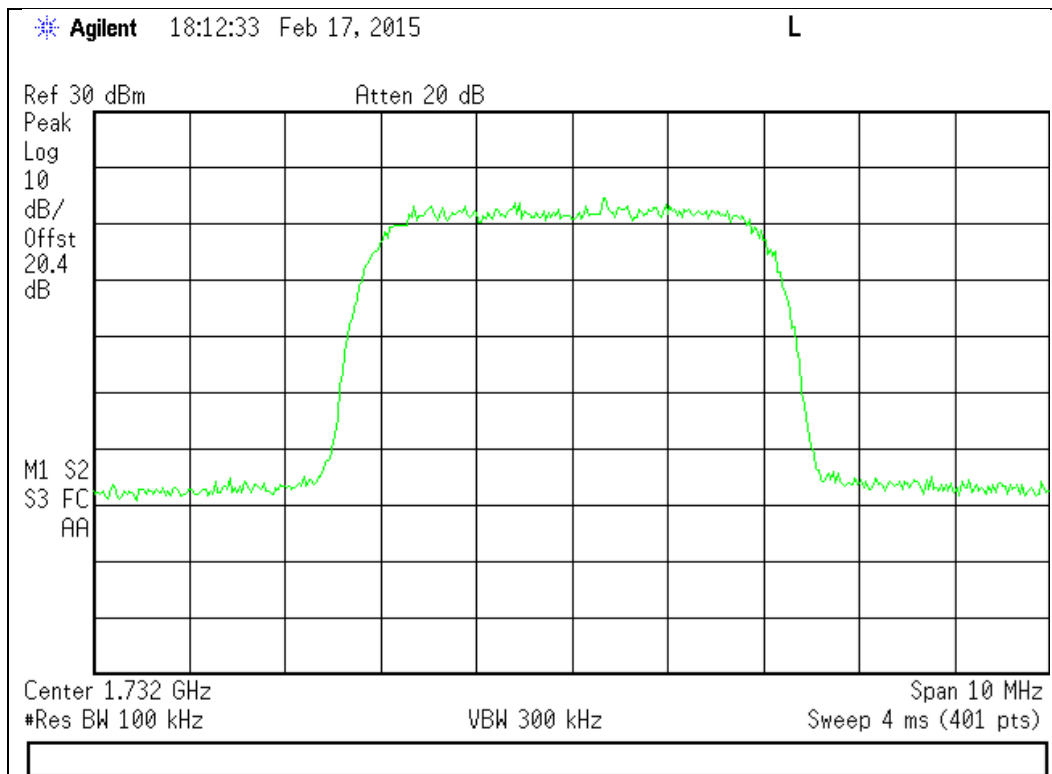

1850 - 1910 MHz Band

Input

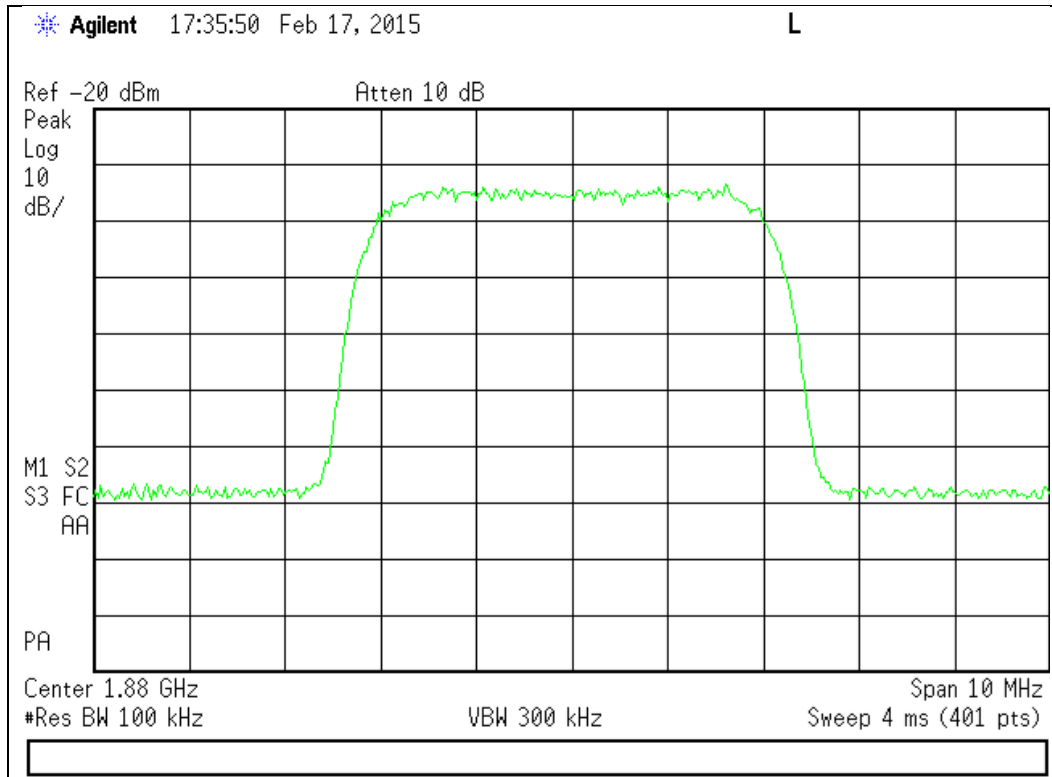

Output

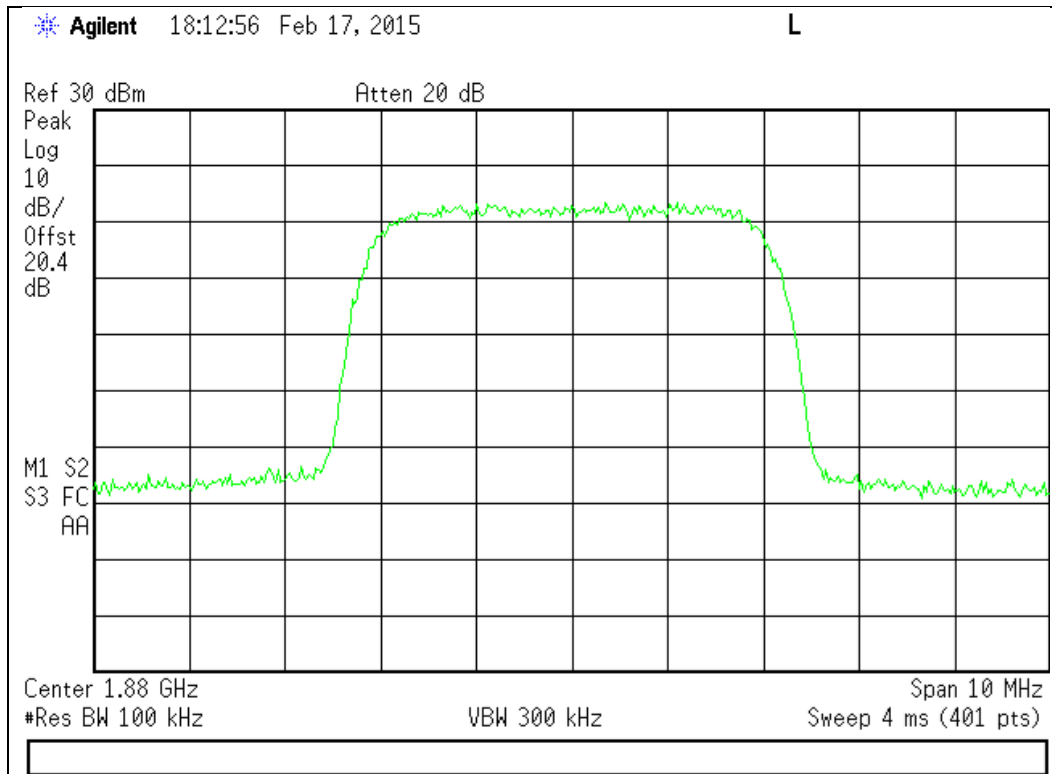

### WCDMA Downlink Test Plots

#### 728 - 746 MHz Band

#### Input

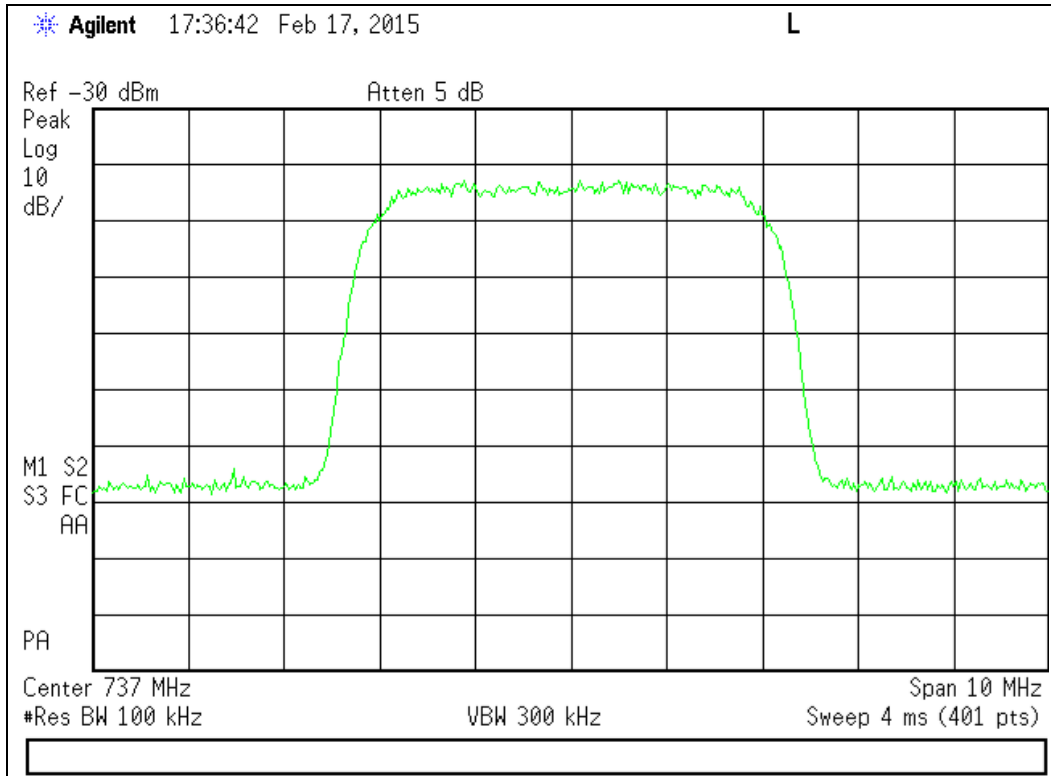

#### Output

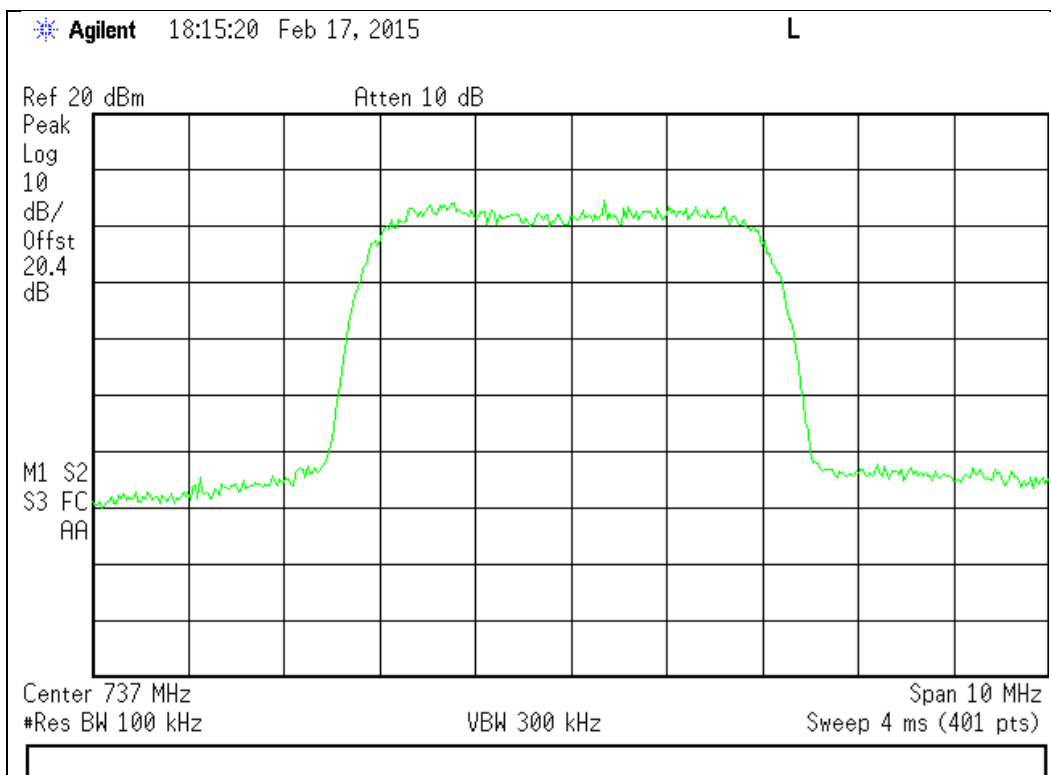

746 - 757 MHz Band

Input

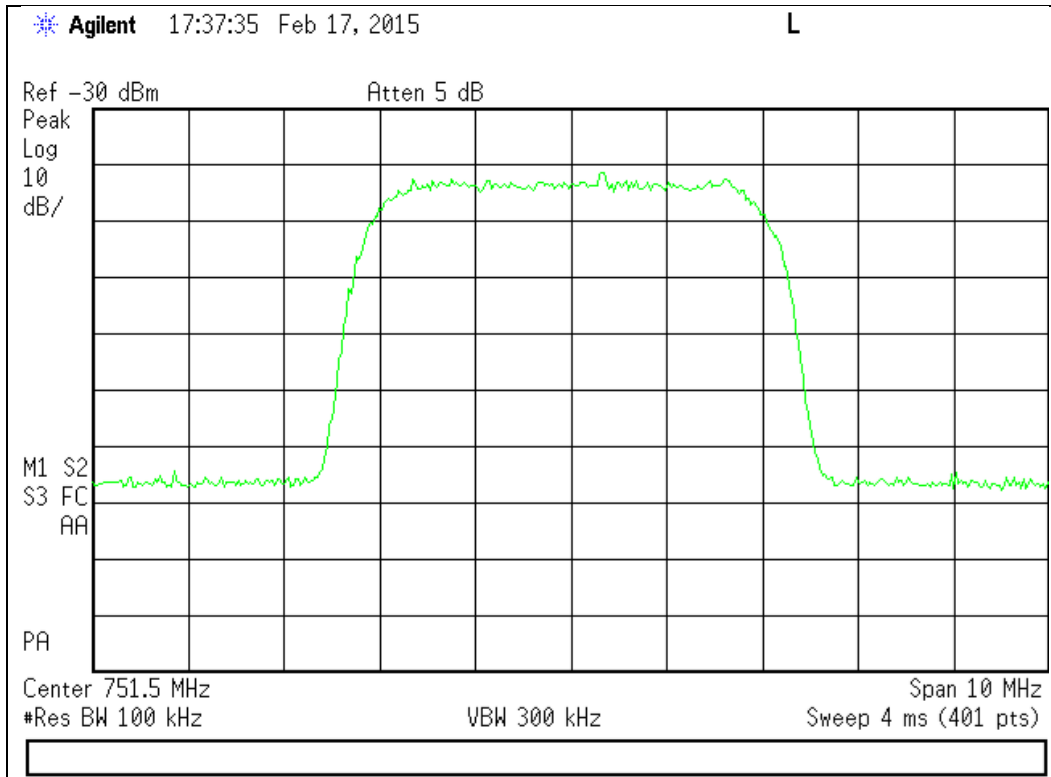

Output

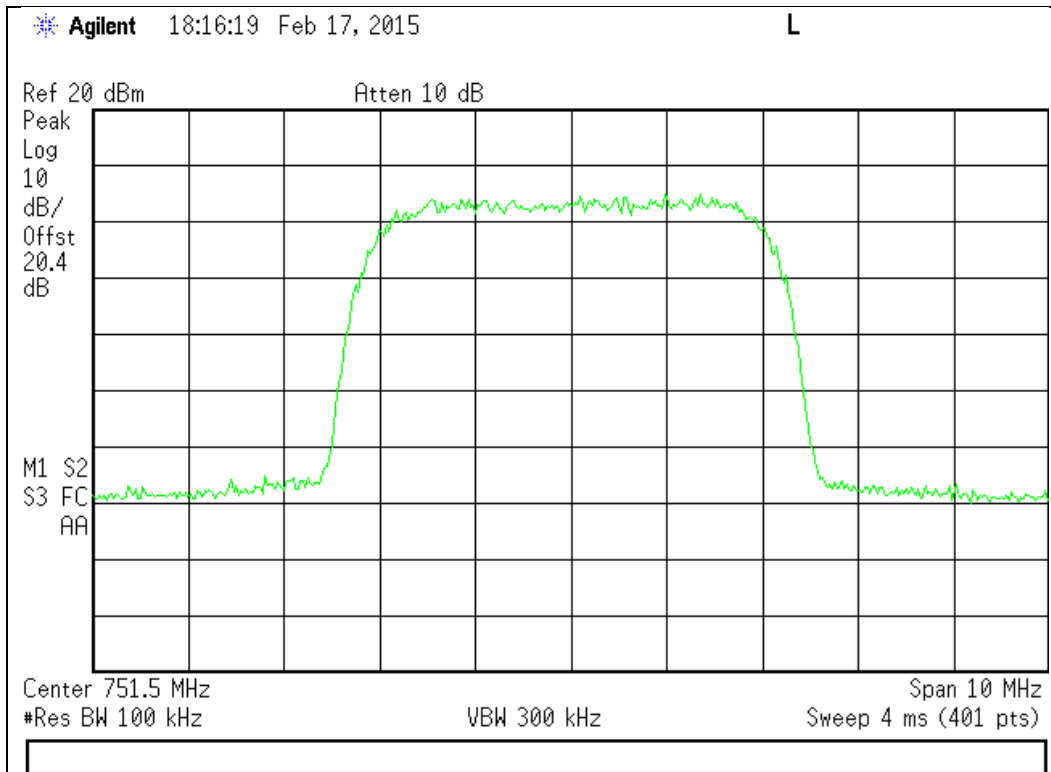

869 - 894 MHz Band

Input

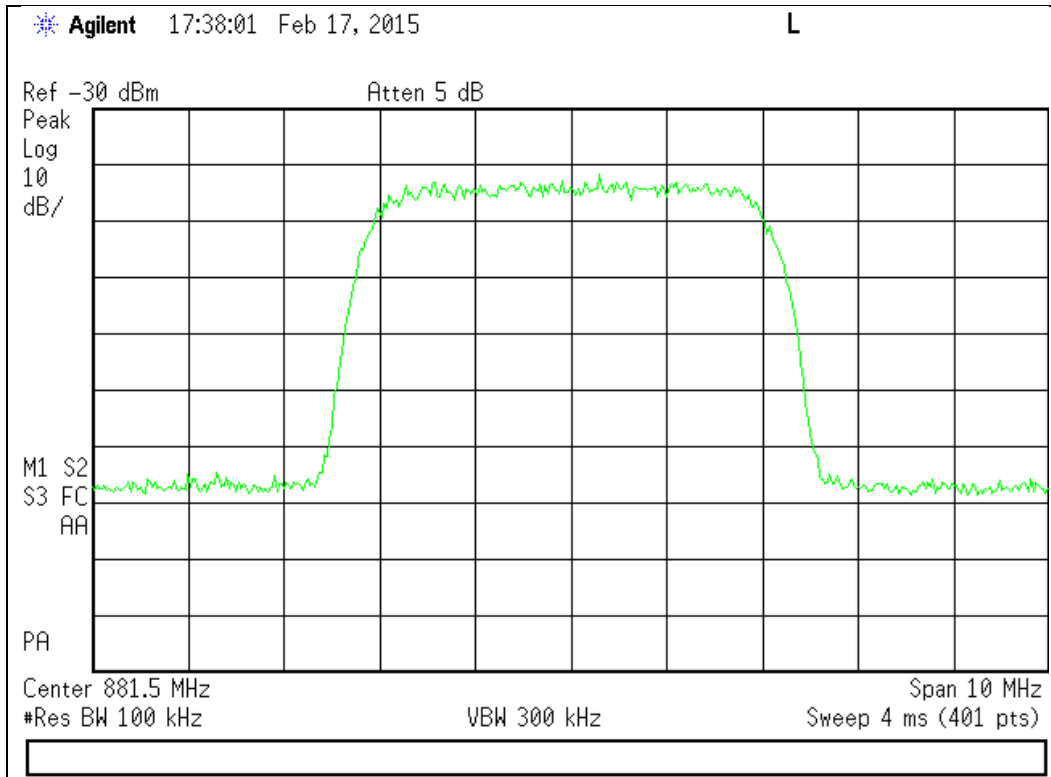

Output

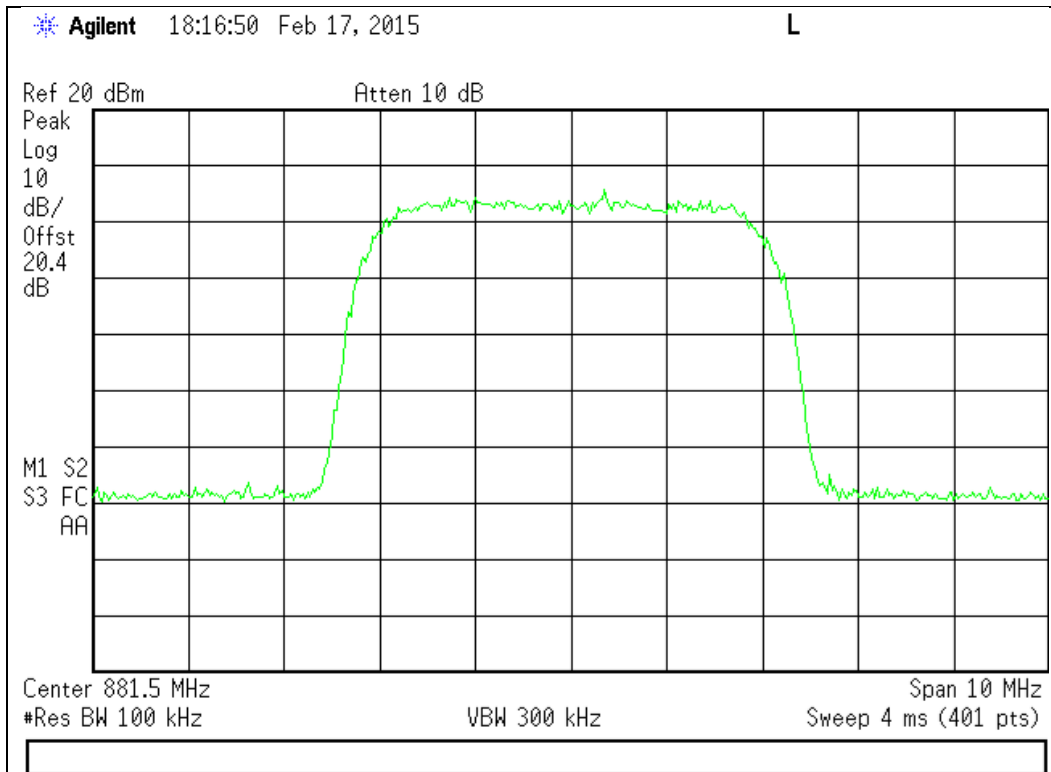

1930 - 1990 MHz Band

Input

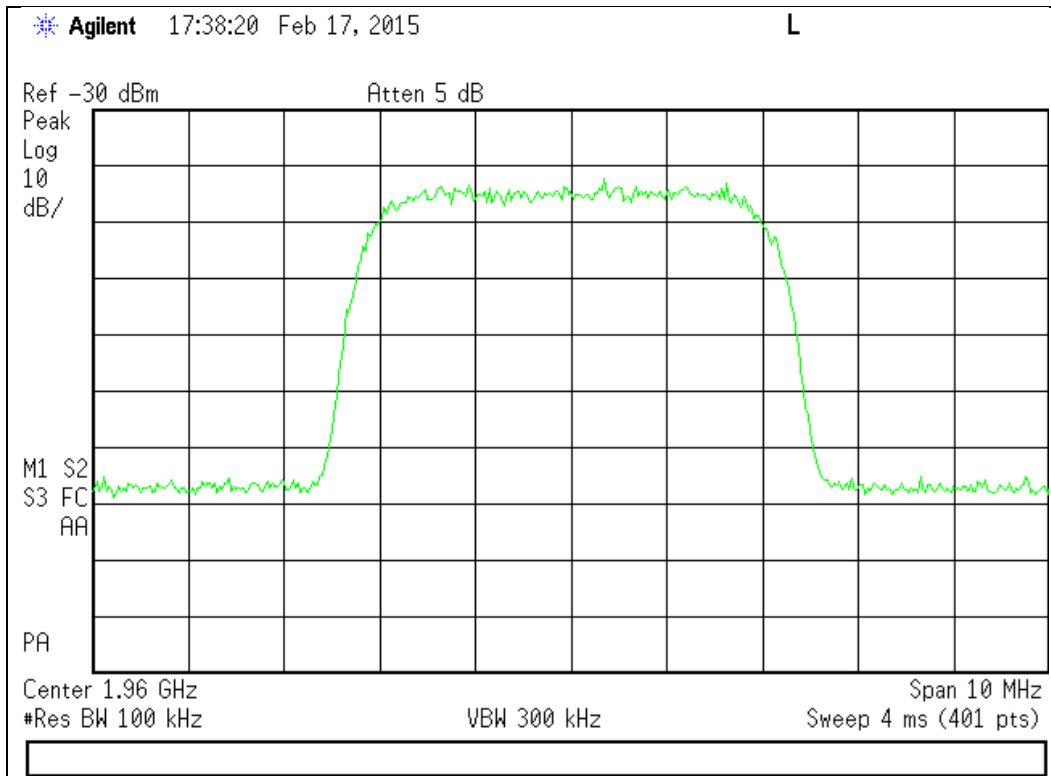

Output

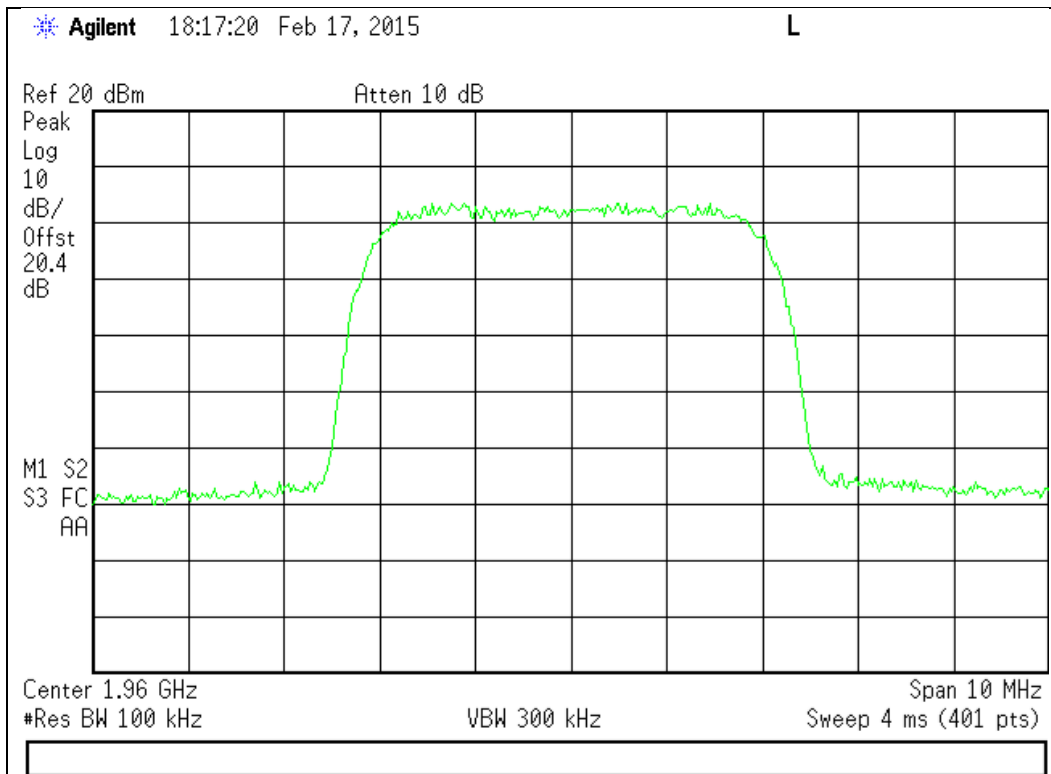

2110 - 2155 MHz Band

Input

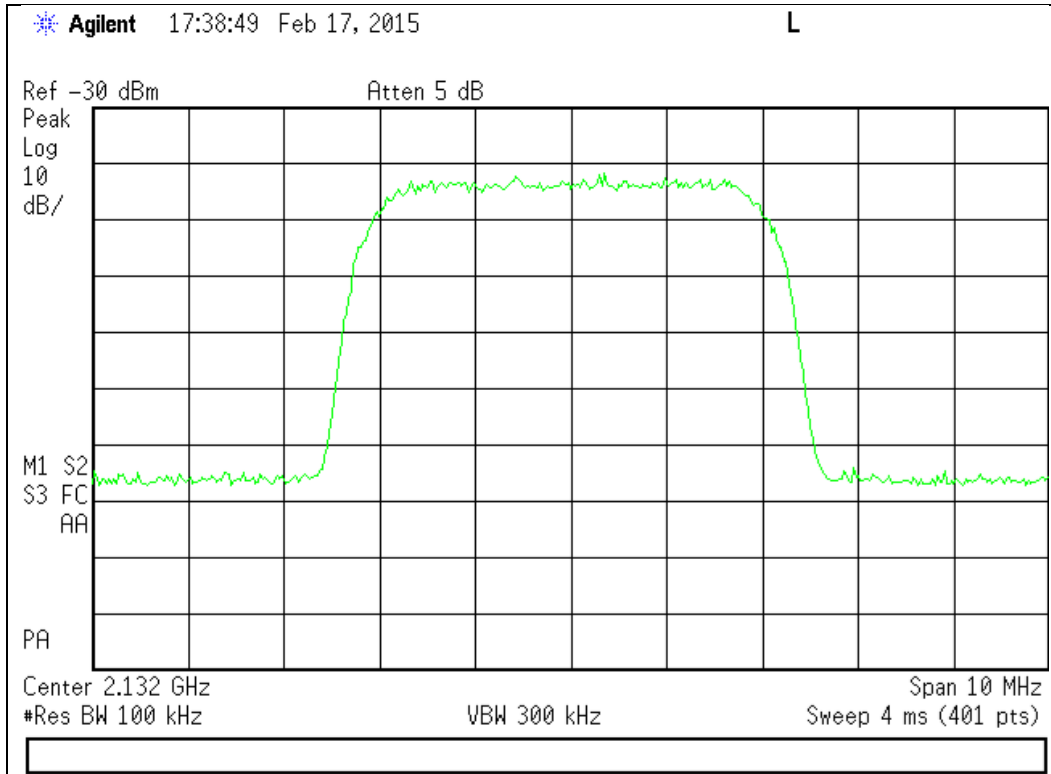

Output

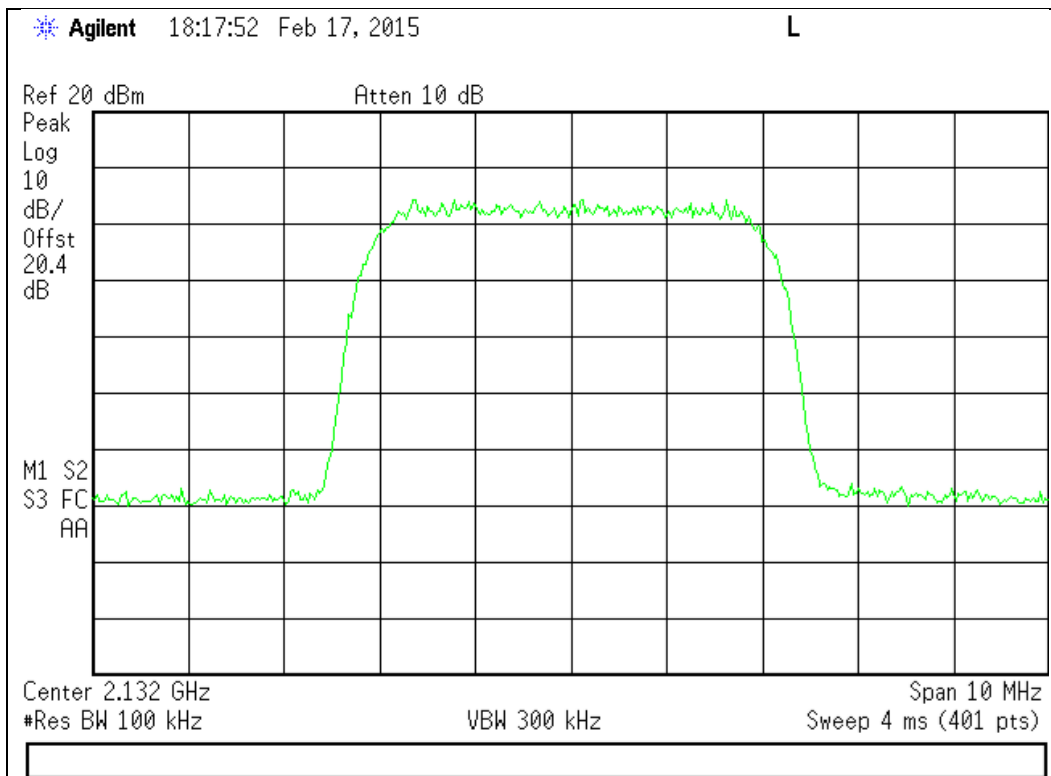



## Oscillation Detection

Engineer: Mike Graffeo

Test Date: 2/17/15

### Test Procedure

The EUT was connected to a spectrum analyzer set for 0 Hz operation. The EUT uplink and downlink were fed back upon each other through a selectable band pass filter and variable attenuator. The EUT uplink and downlink were tested to ensure that the presence of oscillation was detected and that the EUT output turned off within 300 mS for the Uplink and 1 second for the Downlink and remained off for 1 minute. A EUT with test software was utilized to ensure that the EUT only had a maximum of 5 attempts at restart from oscillation before permanently shutting off.

### Test Setup

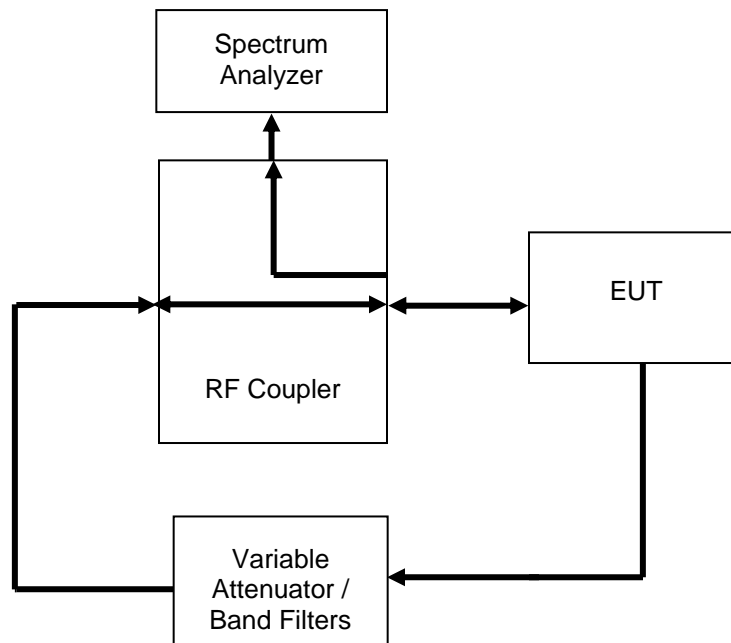

### Uplink Detection Time Test Results

Frequency Band (MHz)	Measured Time (mS)	Limit (mS)	Result
698 - 716	14.5	300	Pass
776 - 787	13.0	300	Pass
824 - 849	14.5	300	Pass
1710 - 1755	15.5	300	Pass
1850 - 1910	142.0	300	Pass

### Downlink Detection Time Test Results

Frequency Band (MHz)	Measured Time (mS)	Limit (mS)	Result
728 - 746	525.0	1000	Pass
746 - 757	93.5	1000	Pass
869 - 894	770.0	1000	Pass
1930 - 1990	239.3	1000	Pass
2110 - 2155	132.0	1000	Pass

### Uplink Restart Time Test Results

Frequency Band (MHz)	Measured Time (S)	Limit (S)	Result
698 - 716	EUT shut off **	≥60	Pass
776 - 787	EUT shut off	≥60	Pass
824 - 849	EUT shut off	≥60	Pass
1710 - 1755	EUT shut off	≥60	Pass
1850 - 1910	EUT shut off	≥60	Pass

### Downlink Restart Time Test Results

Frequency Band (MHz)	Measured Time (S)	Limit (S)	Result
728 - 746	EUT shut off	≥60	Pass
746 - 757	EUT shut off	≥60	Pass
869 - 894	EUT shut off	≥60	Pass
1930 - 1990	EUT shut off	≥60	Pass
2110 - 2155	EUT shut off	≥60	Pass

### Uplink Restart Count Test Results

Frequency Band (MHz)	Restarts	Limit	Result
698 - 716	EUT shut off	≤5	Pass
776 - 787	EUT shut off	≤5	Pass
824 - 849	EUT shut off	≤5	Pass
1710 - 1755	EUT shut off	≤5	Pass
1850 - 1910	EUT shut off	≤5	Pass

### Downlink Restart Count Test Results

Frequency Band (MHz)	Restarts	Limit	Result
728 - 746	EUT shut off	≤5	Pass
746 - 757	EUT shut off	≤5	Pass
869 - 894	EUT shut off	≤5	Pass
1930 - 1990	EUT shut off	≤5	Pass
2110 - 2155	EUT shut off	≤5	Pass

\*\* Note:

The EUT shuts down after detecting oscillation and does not try to restart, therefore there are no restart counts..

### Uplink Detection Time Test Results

#### 698 - 716 MHz Band

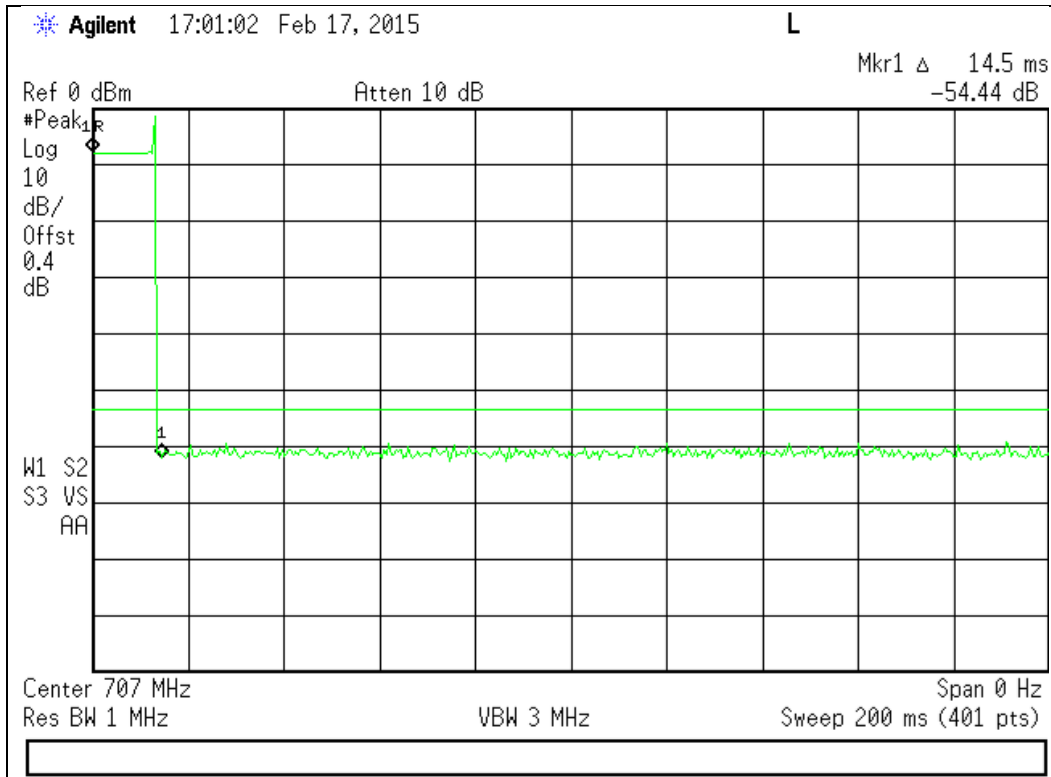

#### 776 - 787 MHz Band

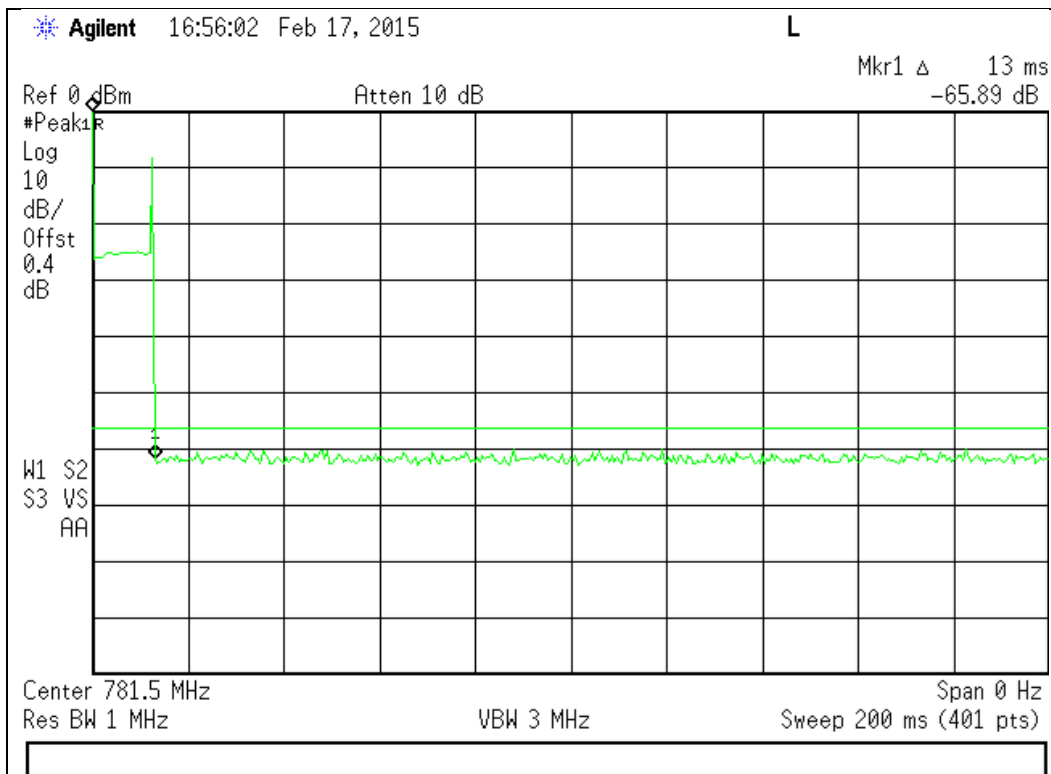

824 - 849 MHz Band

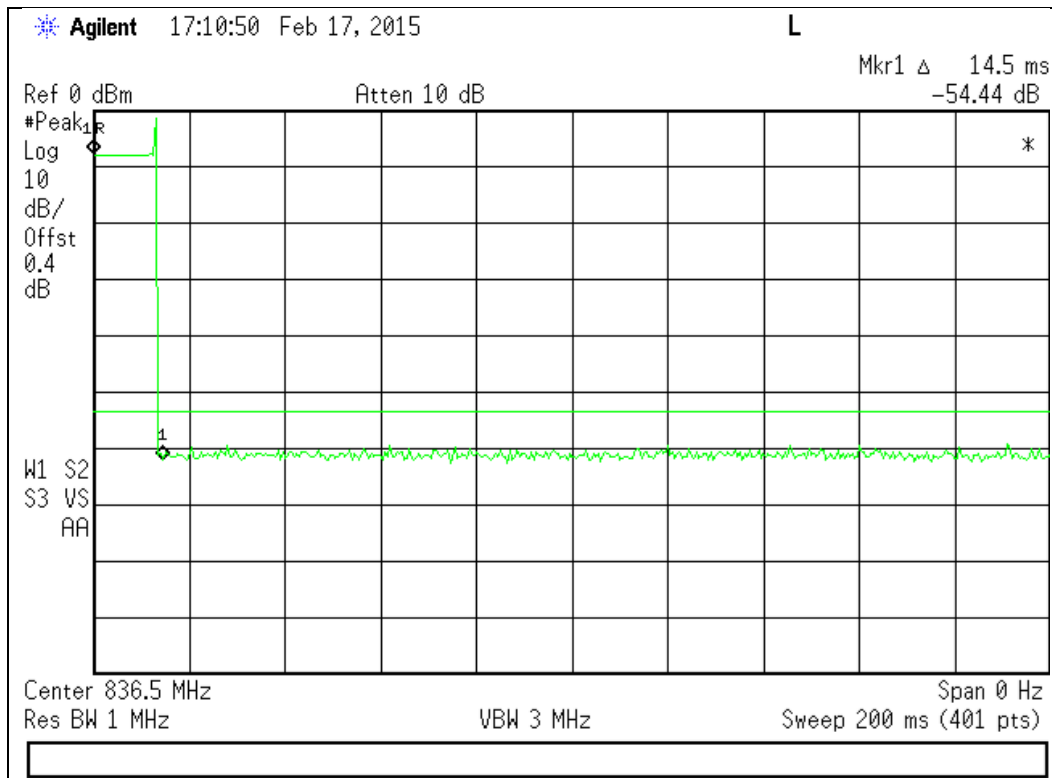

1710 - 1755 MHz Band

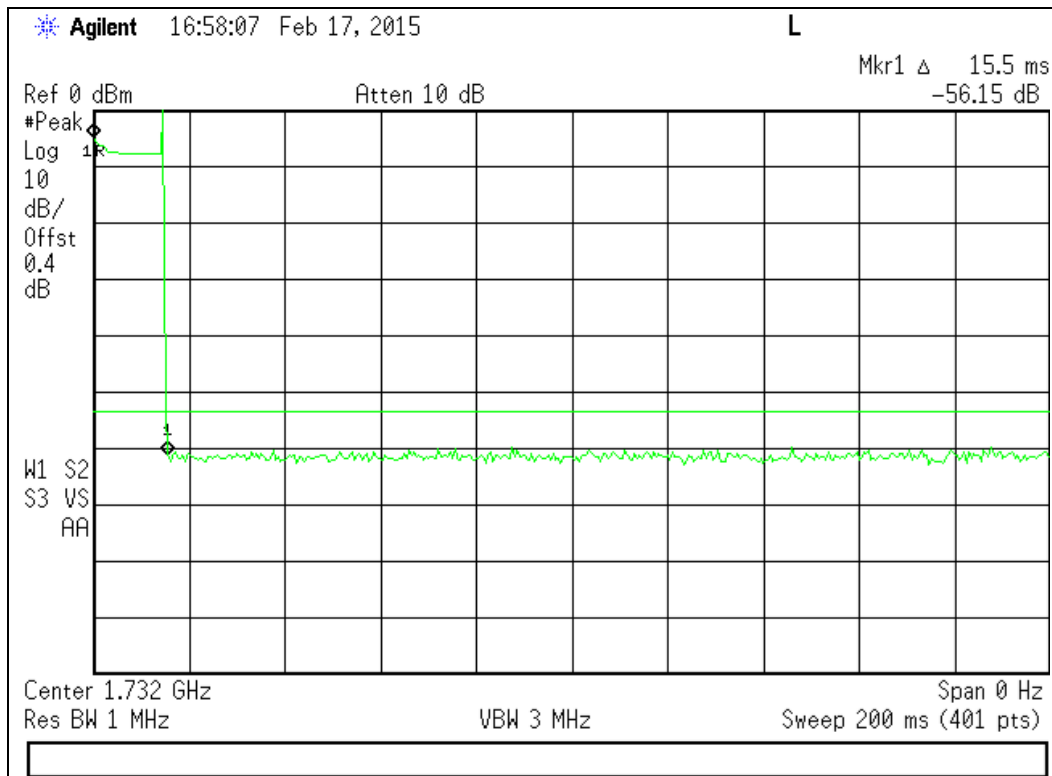

1850 - 1910 MHz Band

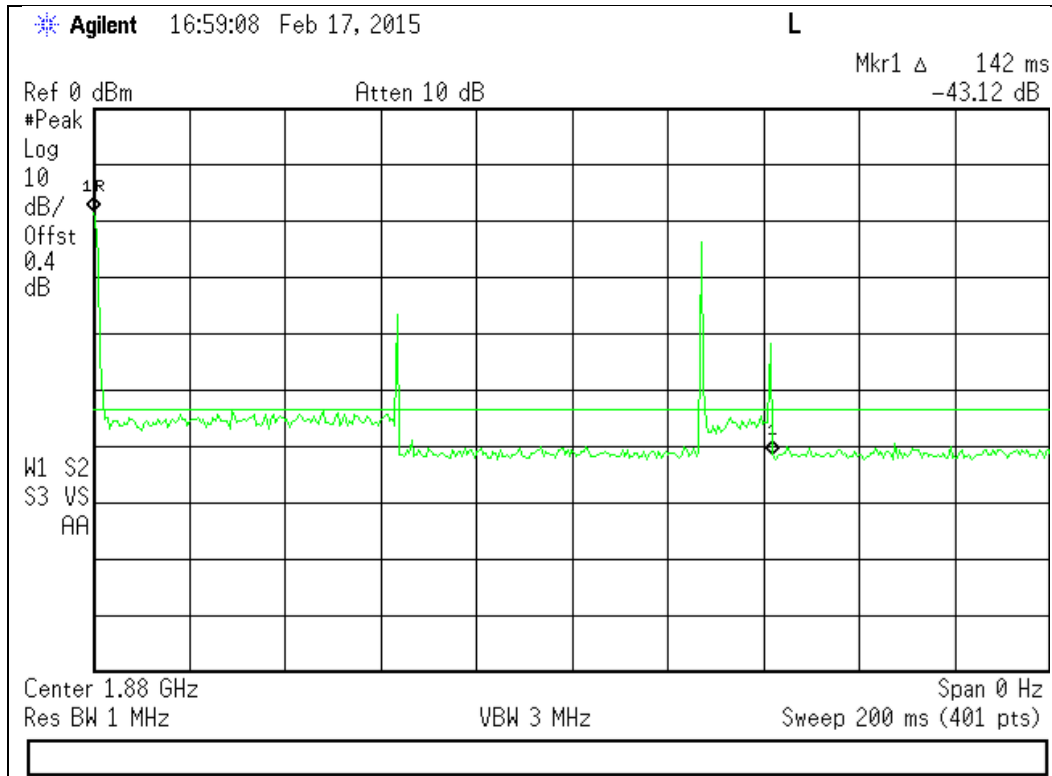

Uplink Restart Time Test Results

698 - 716 MHz Band

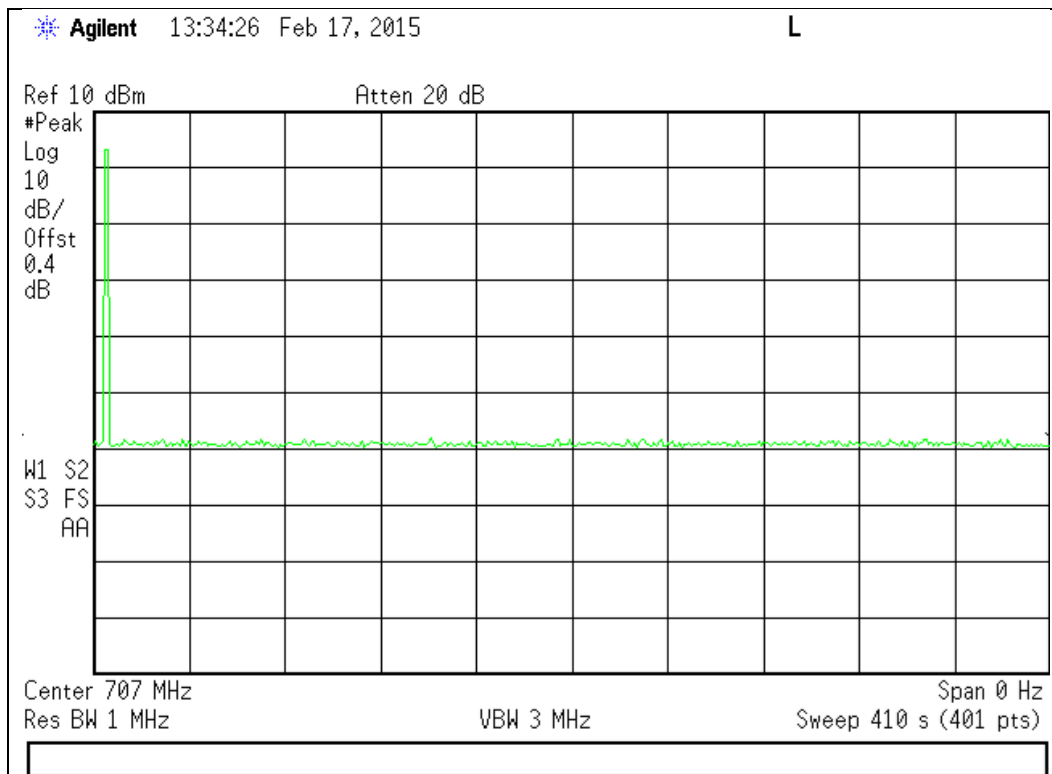

776 - 787 MHz Band

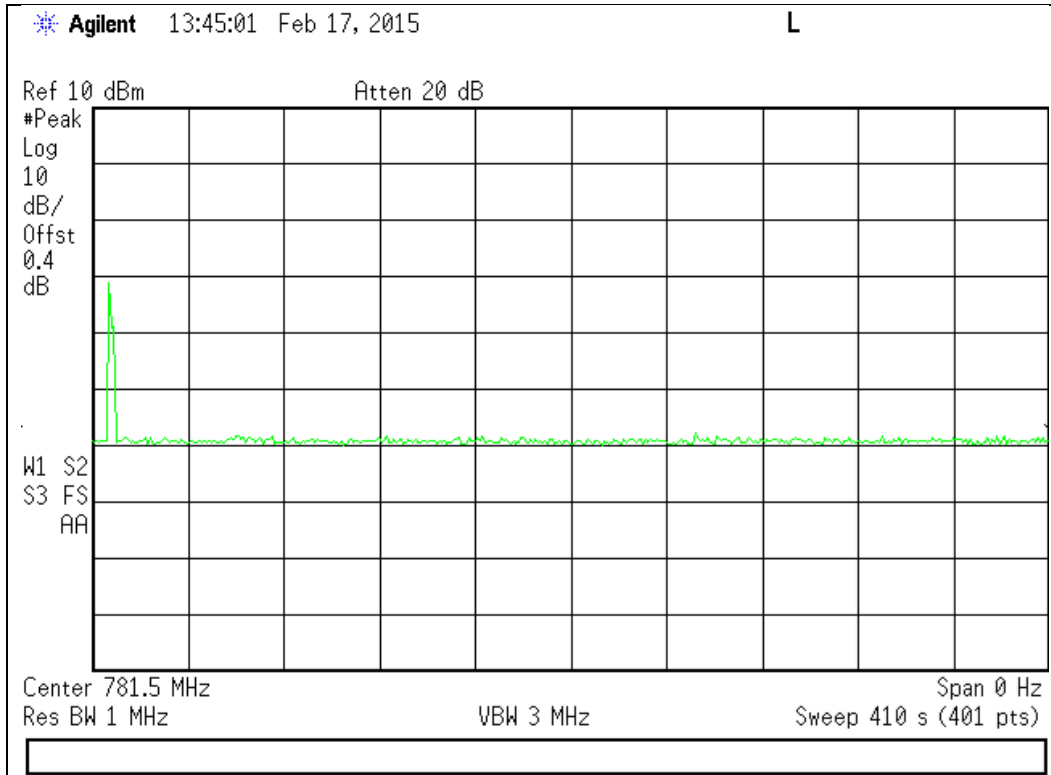

824 - 849 MHz Band

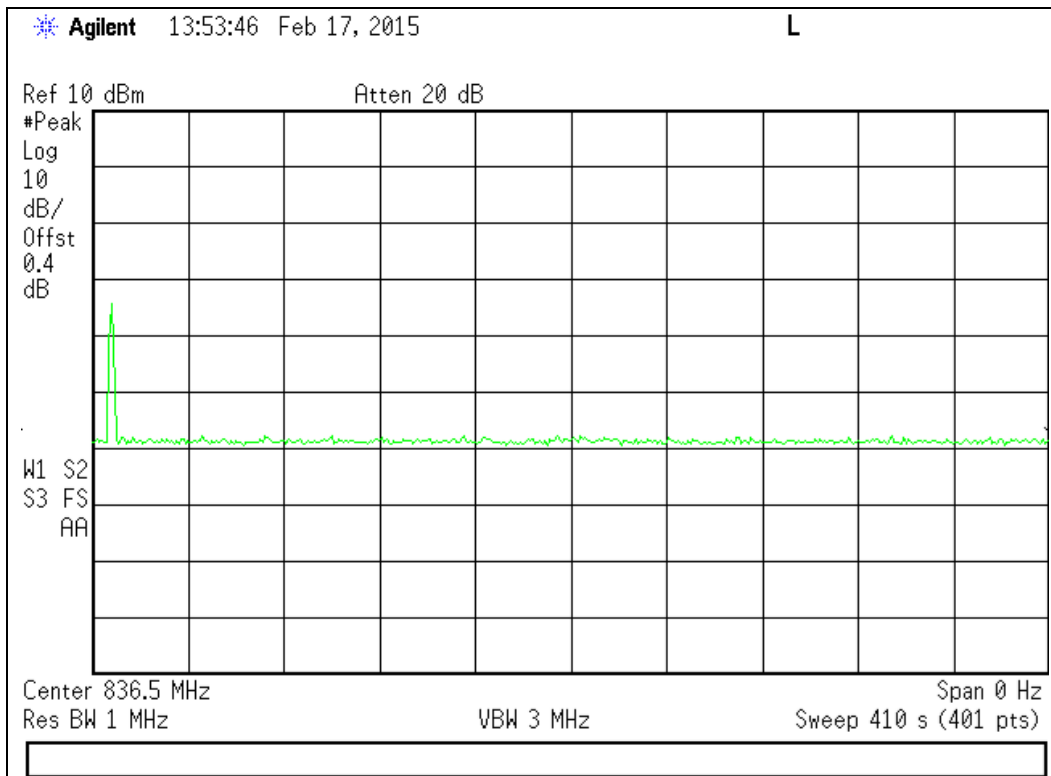

1710 - 1755 MHz Band

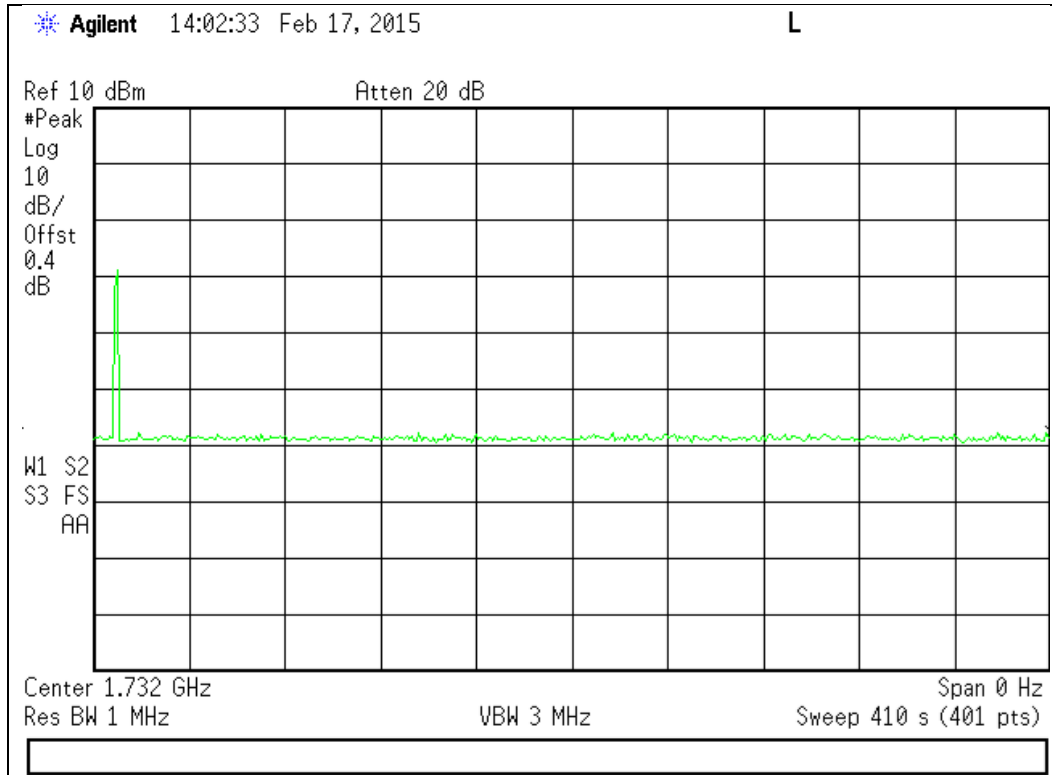

1850 - 1910 MHz Band

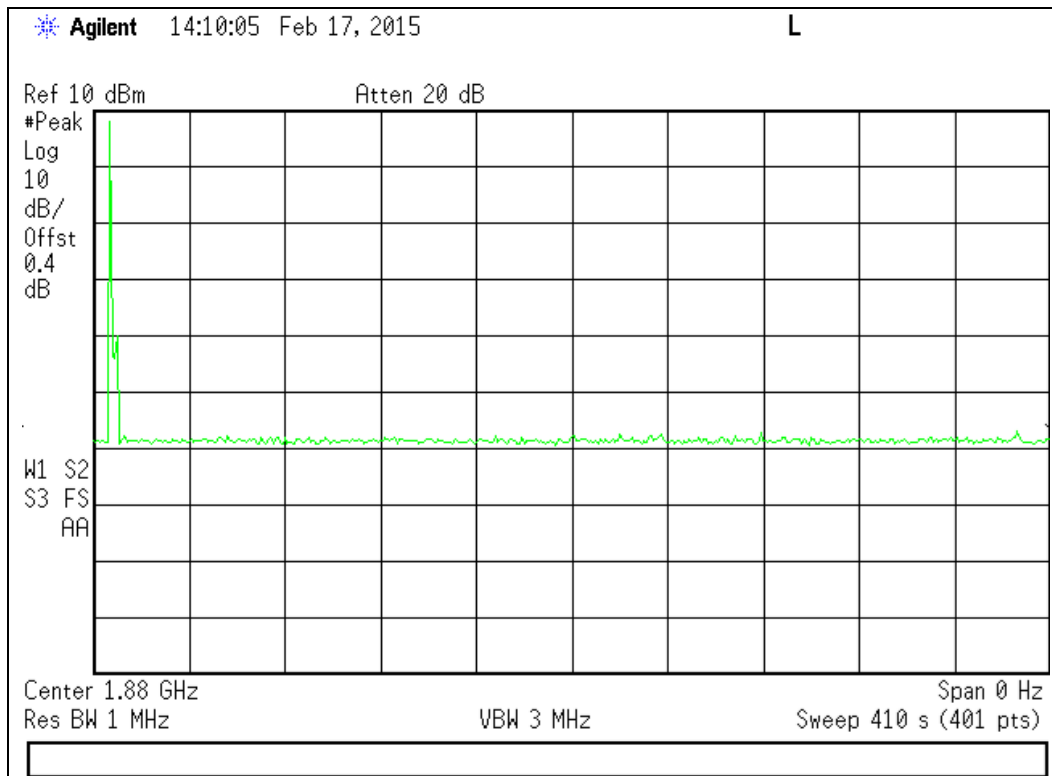

### Uplink Restart Count Test Results

#### 698 - 716 MHz Band

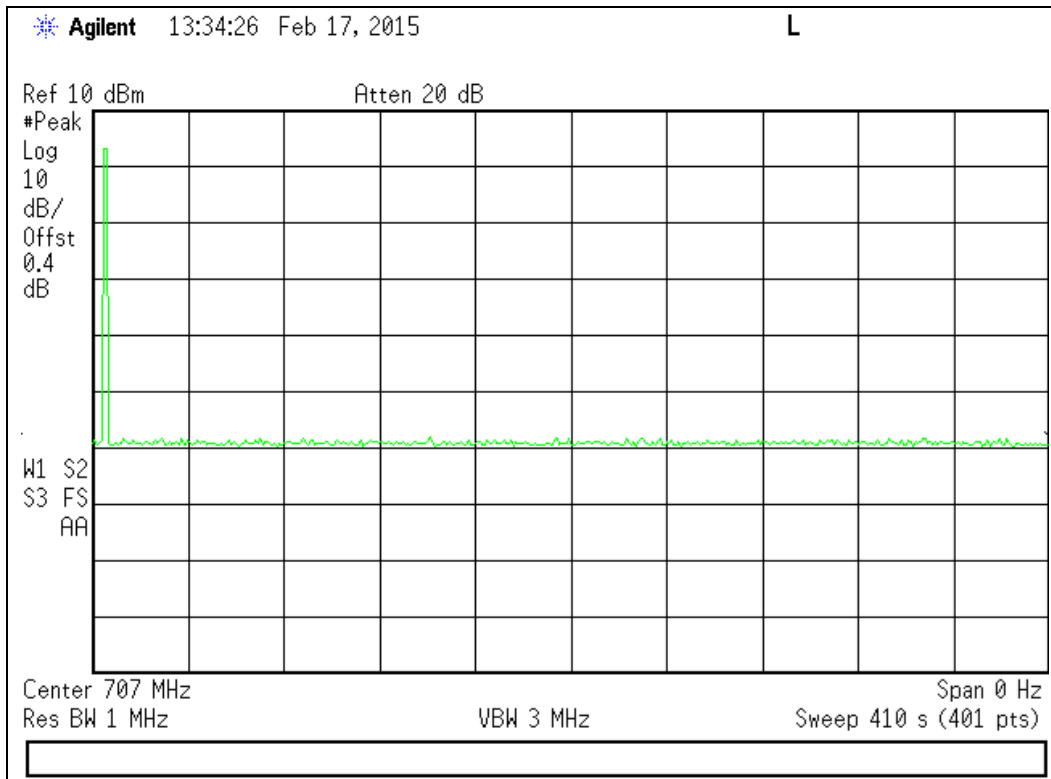

#### 776 - 787 MHz Band

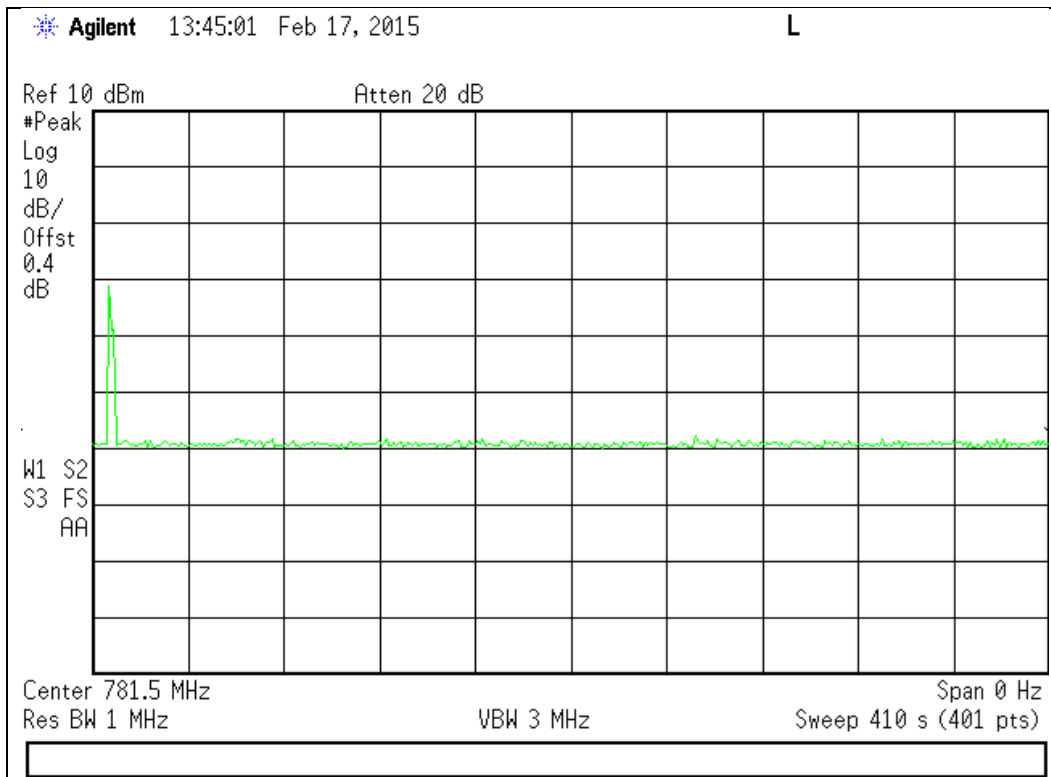



824 - 849 MHz Band

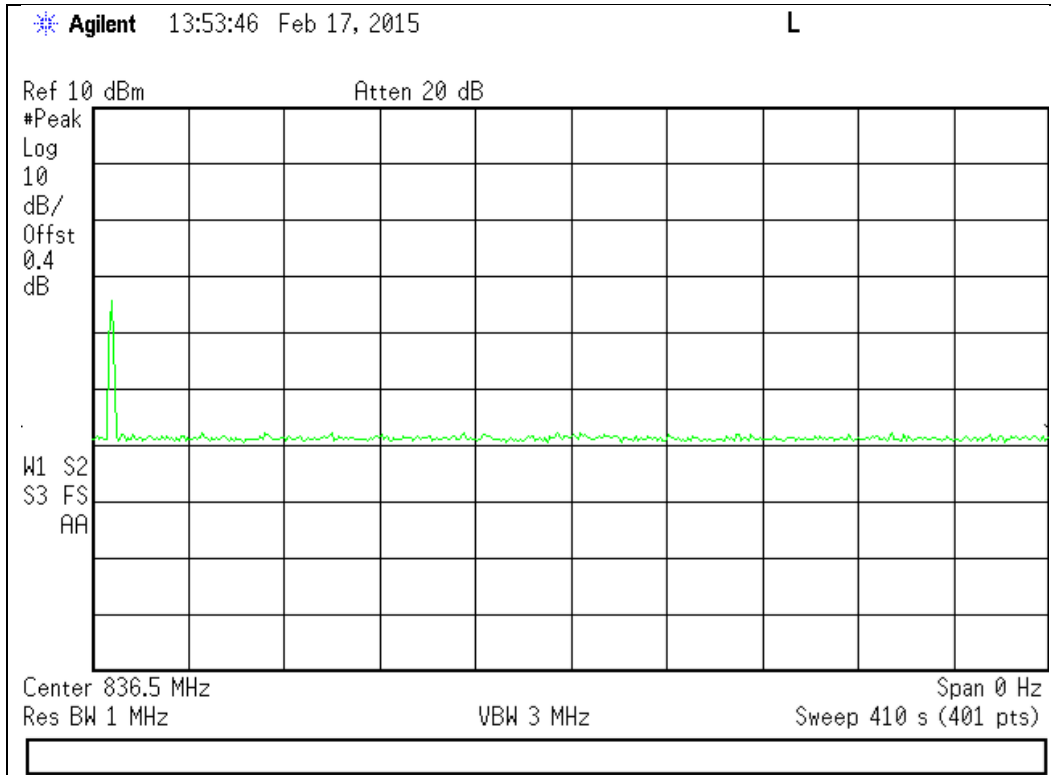

1710 - 1755 MHz Band

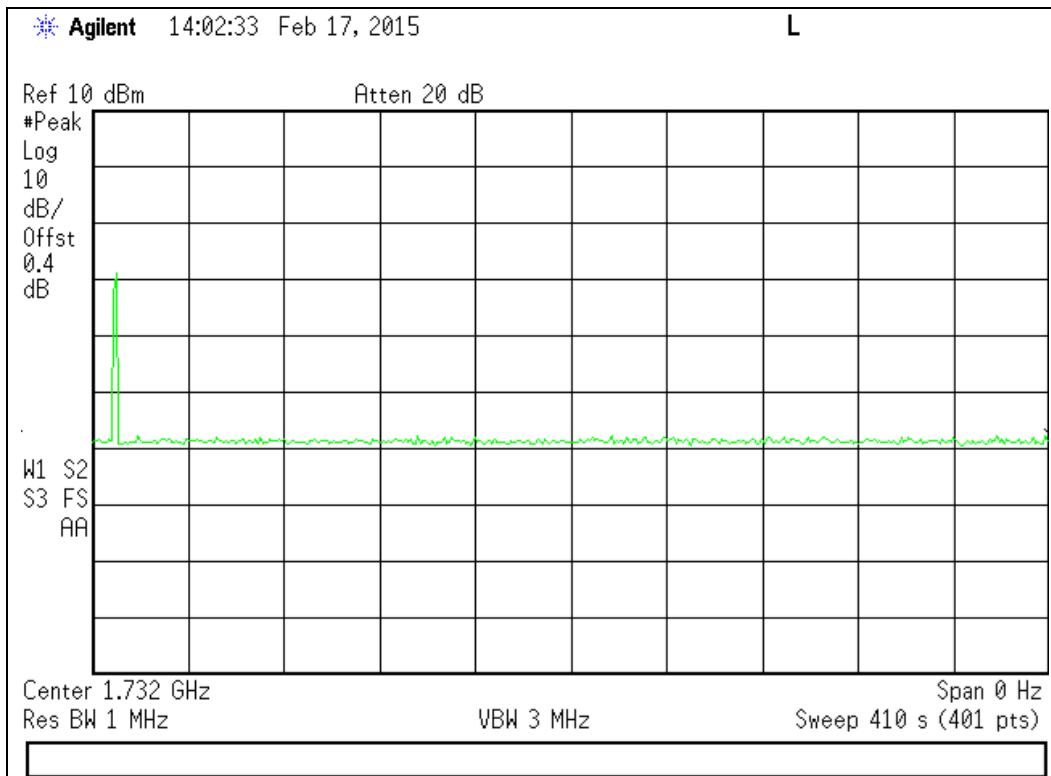

1850 - 1910 MHz Band

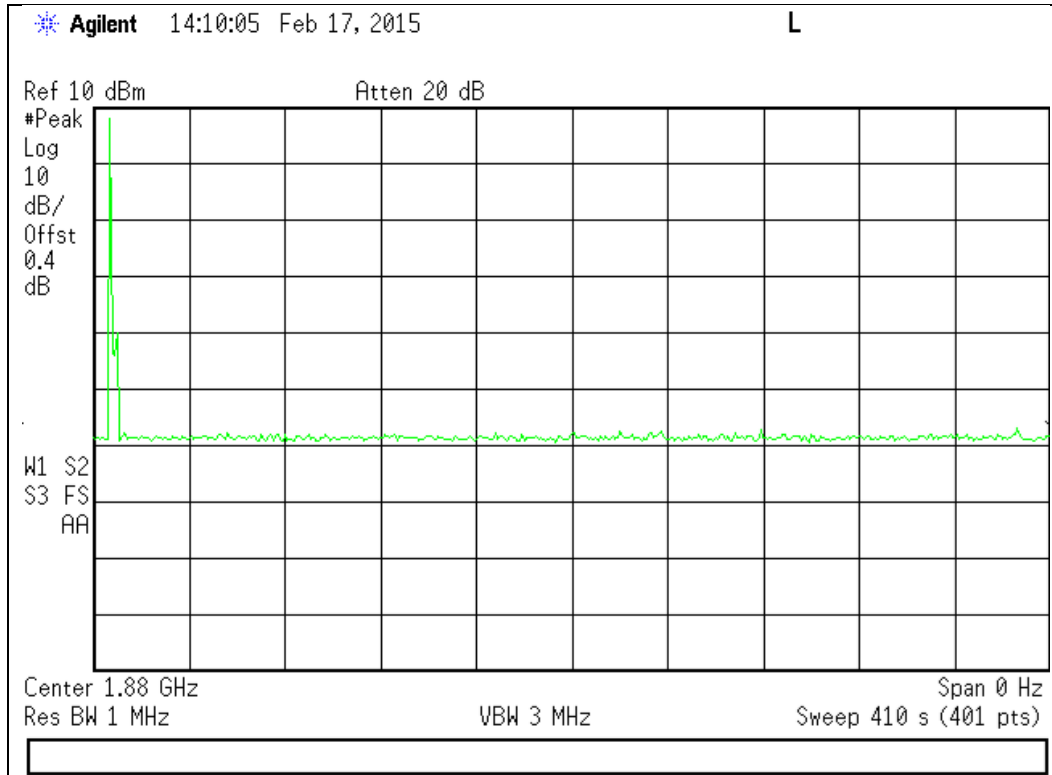

Downlink Detection Time Test Results

728 - 746 MHz Band

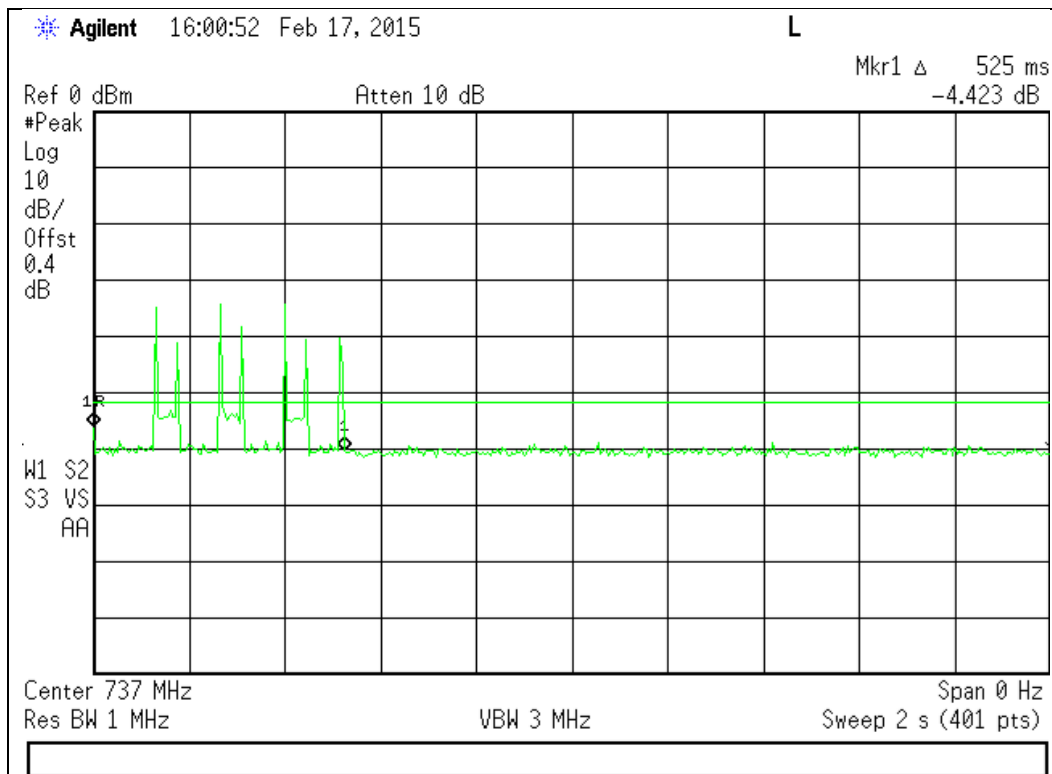

746 - 757 MHz Band

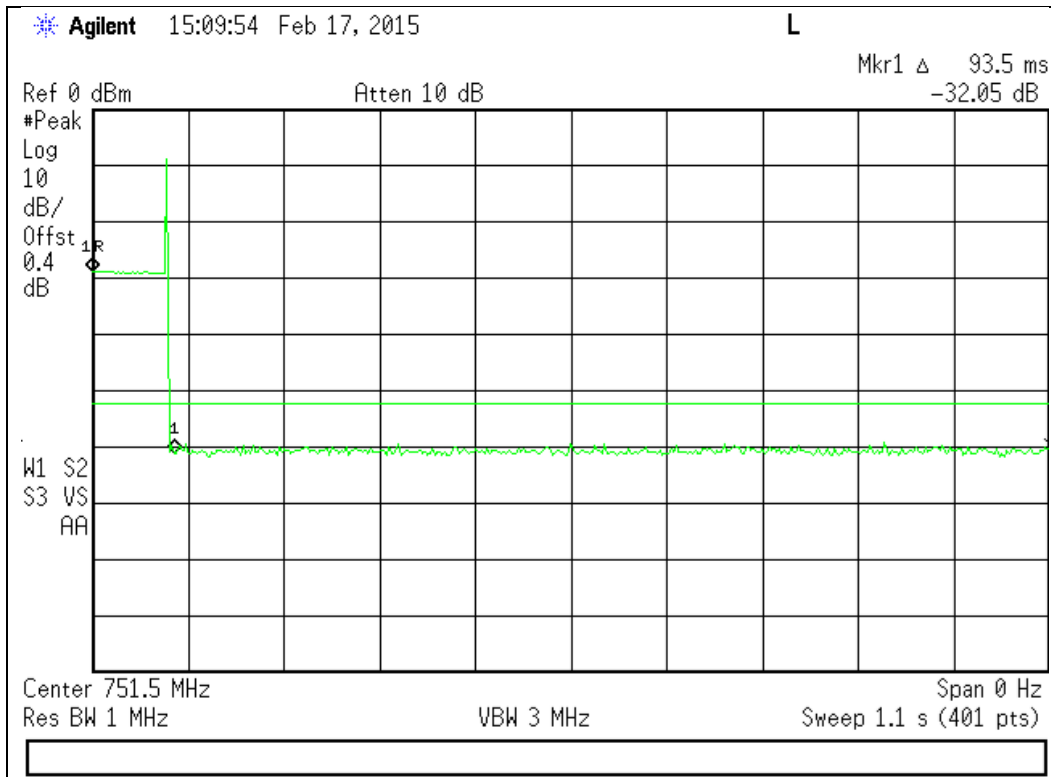

869 - 894 MHz Band

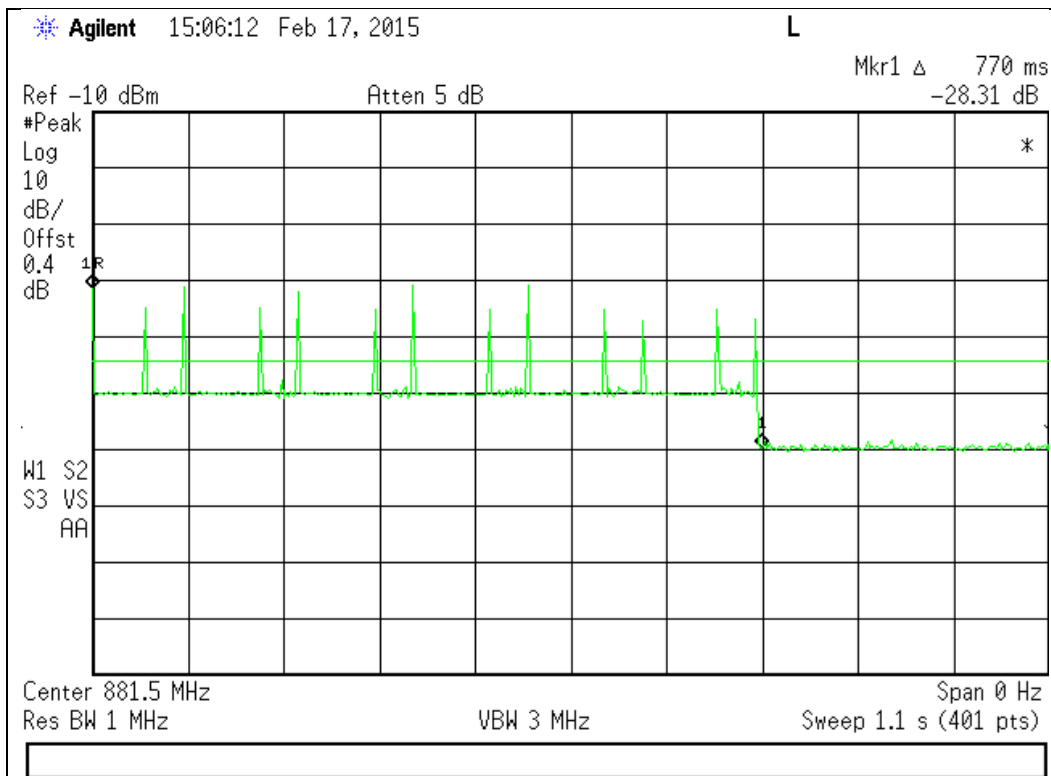

1930 - 1990 MHz Band

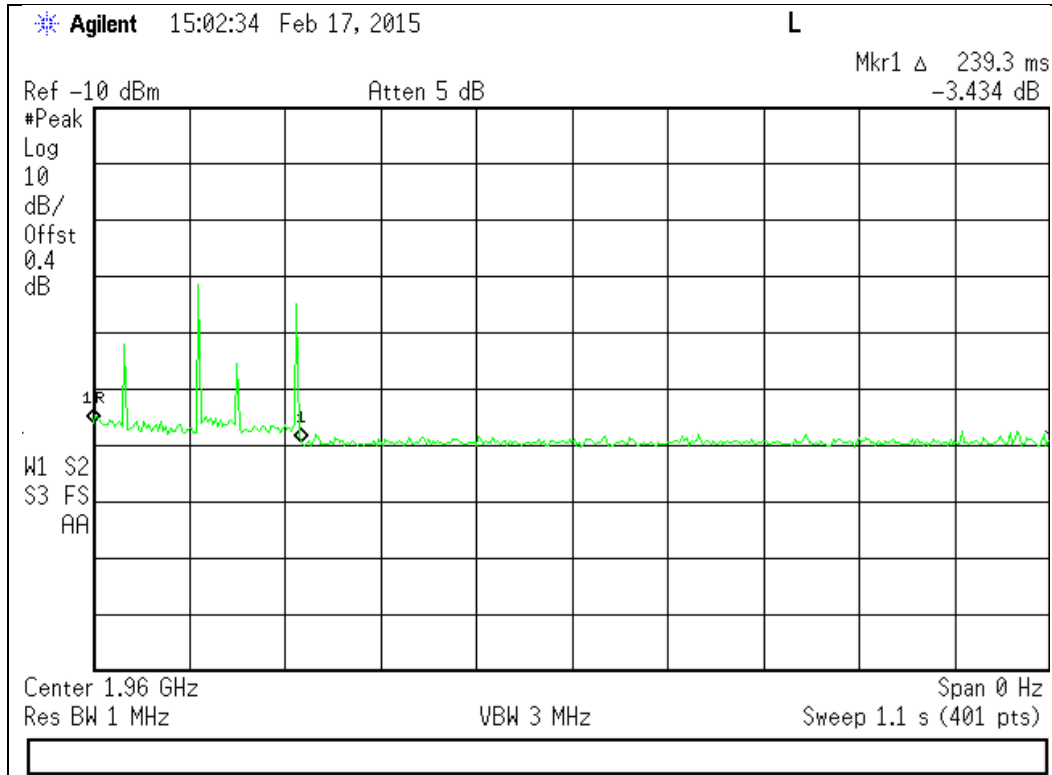

2110 - 2155 MHz Band

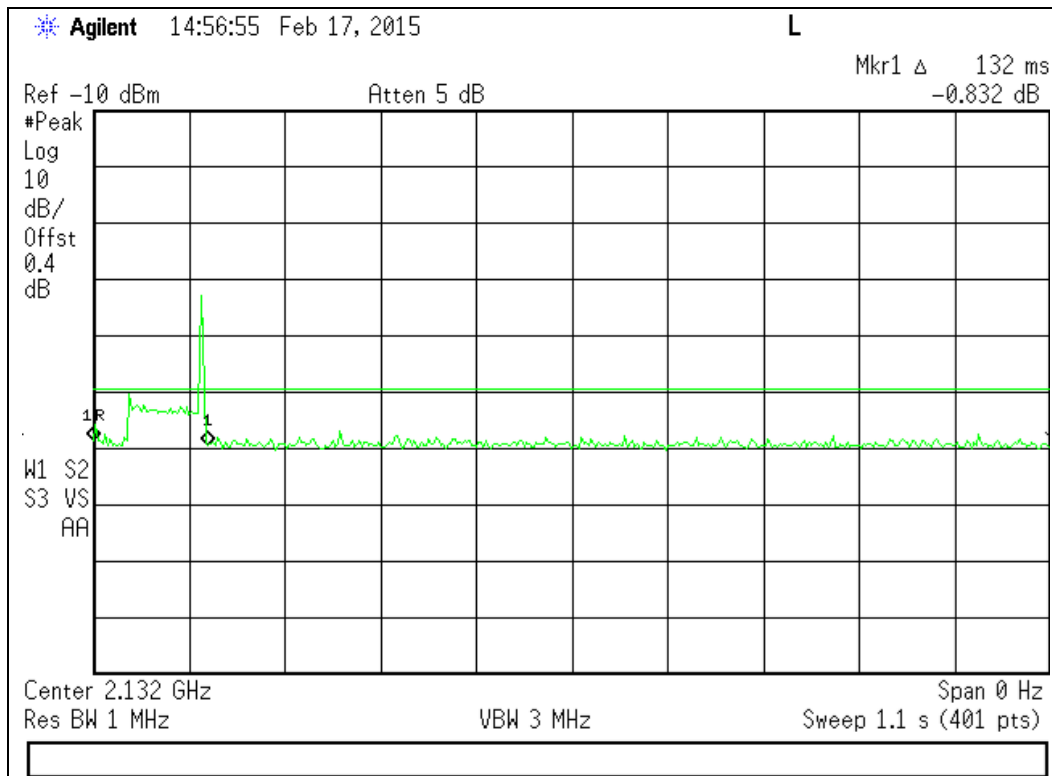

### Downlink Restart Time Test Results

#### 728 - 746 MHz Band

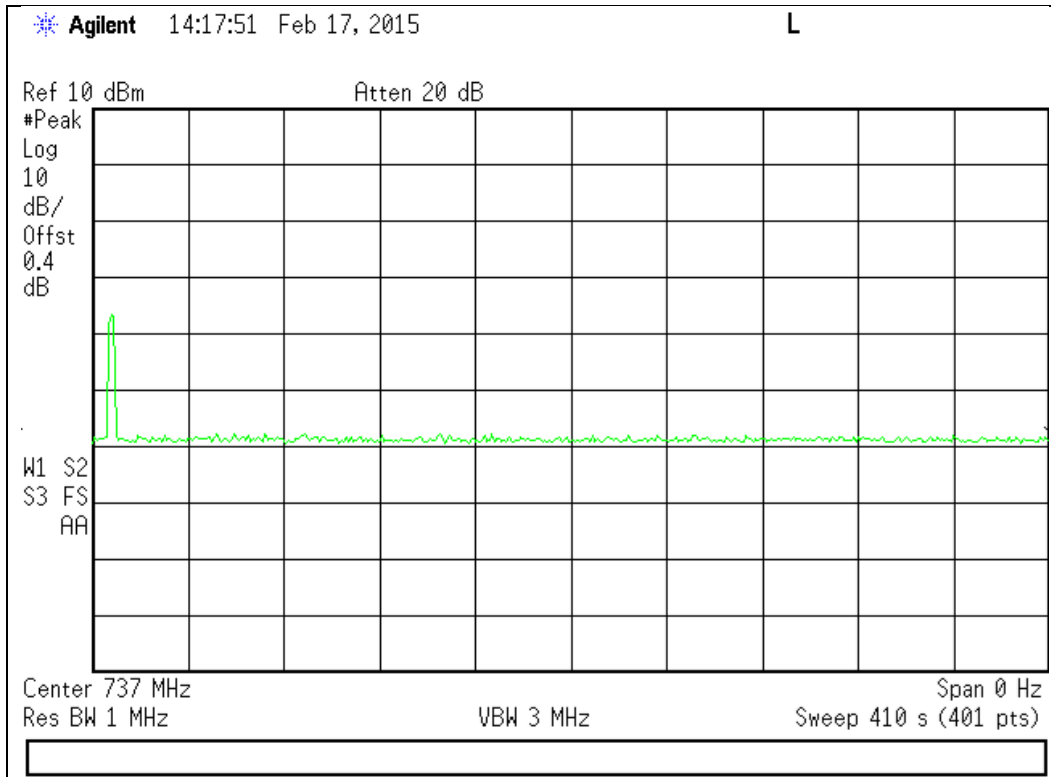

#### 746 - 757 MHz Band

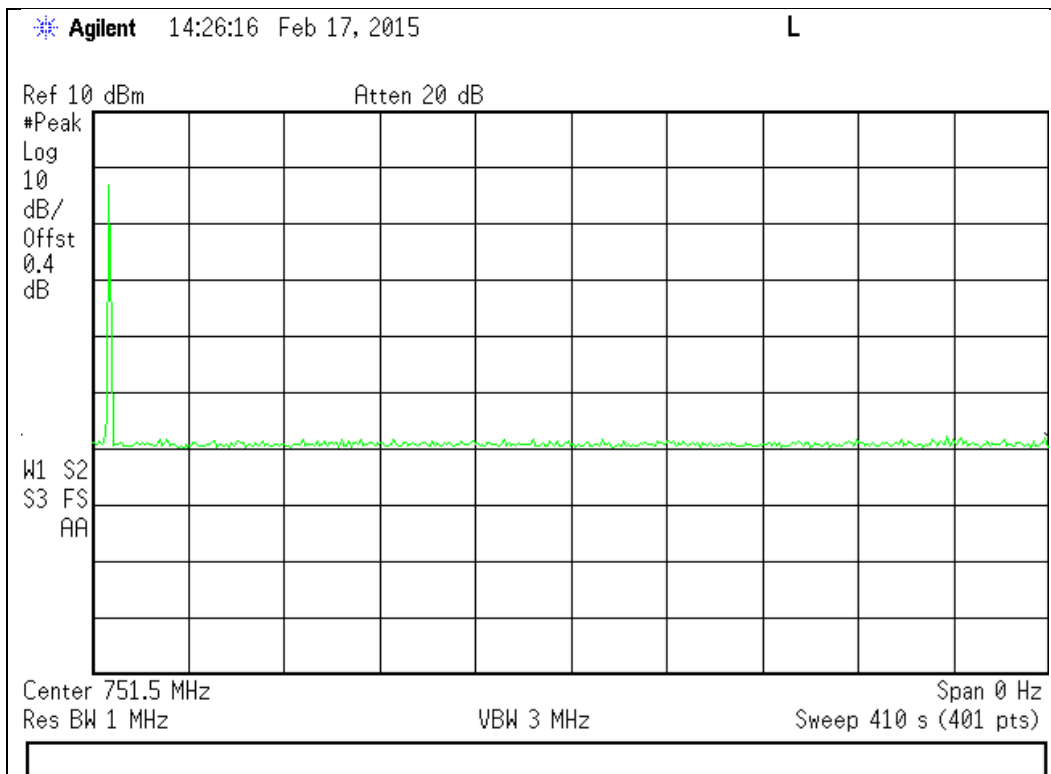

869 - 894 MHz Band

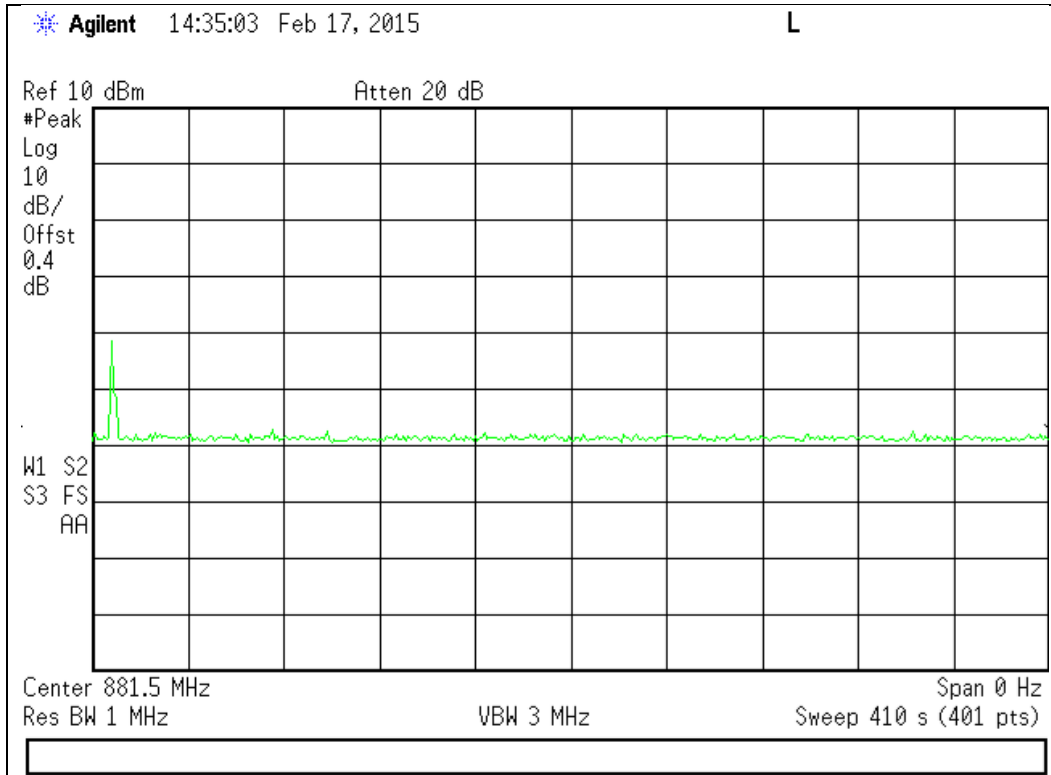

1930 - 1990 MHz Band

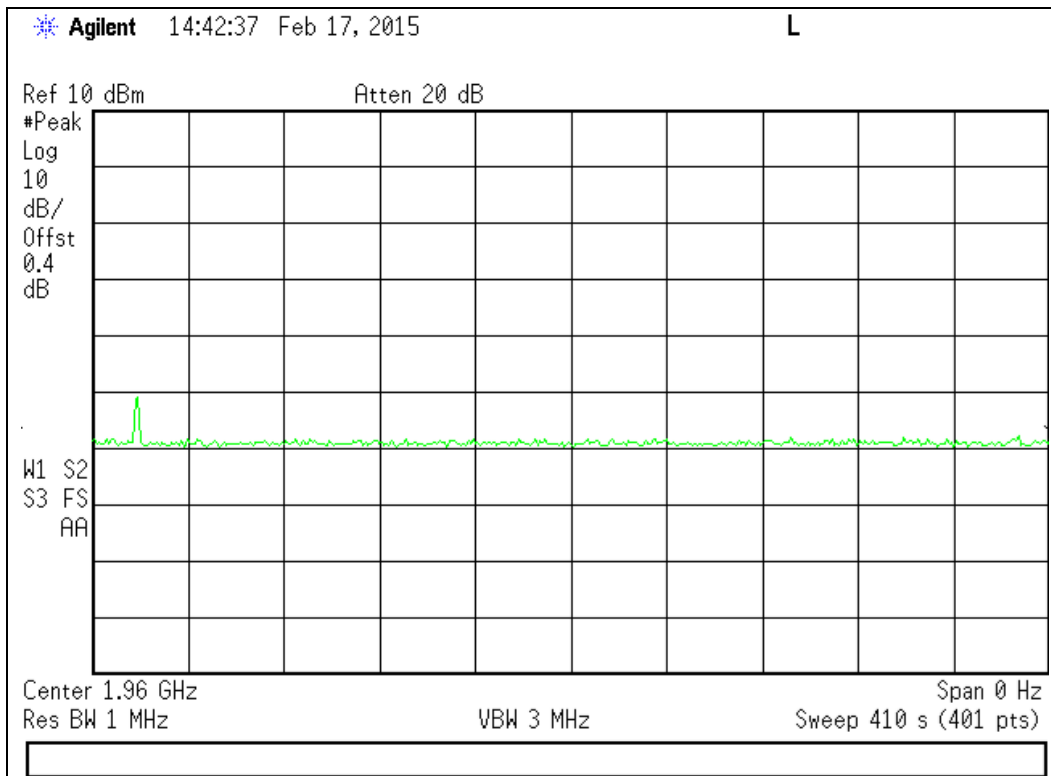

2110 - 2155 MHz Band

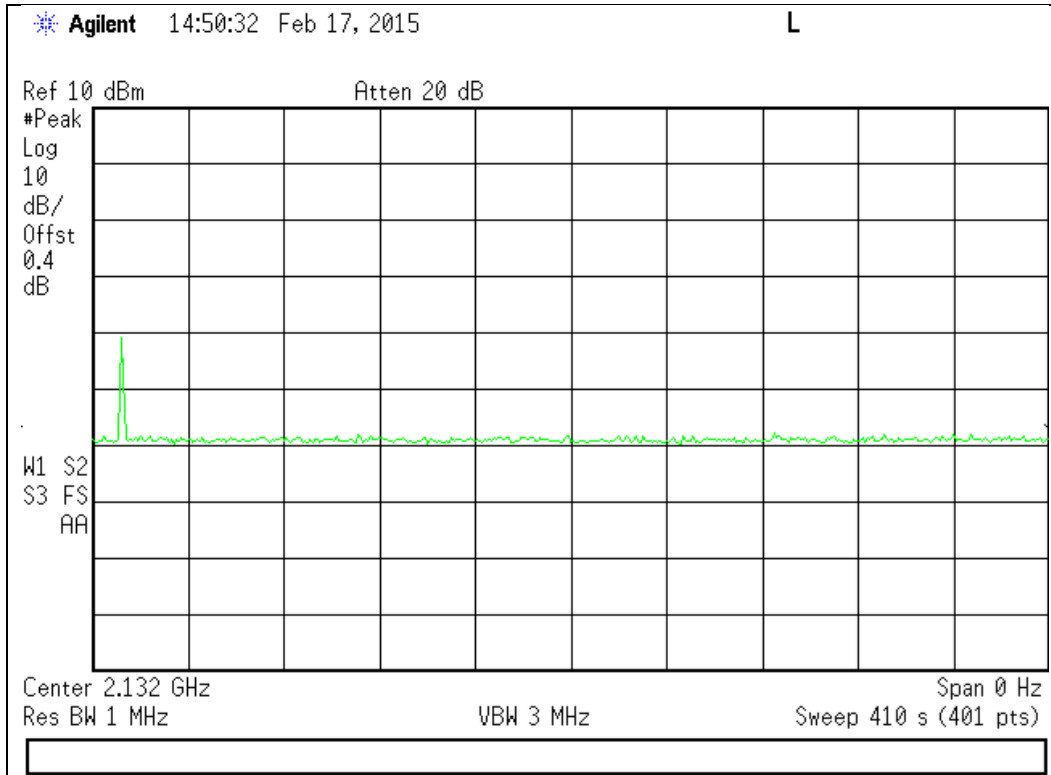

Downlink Restart Count Test Results

728 - 746 MHz Band

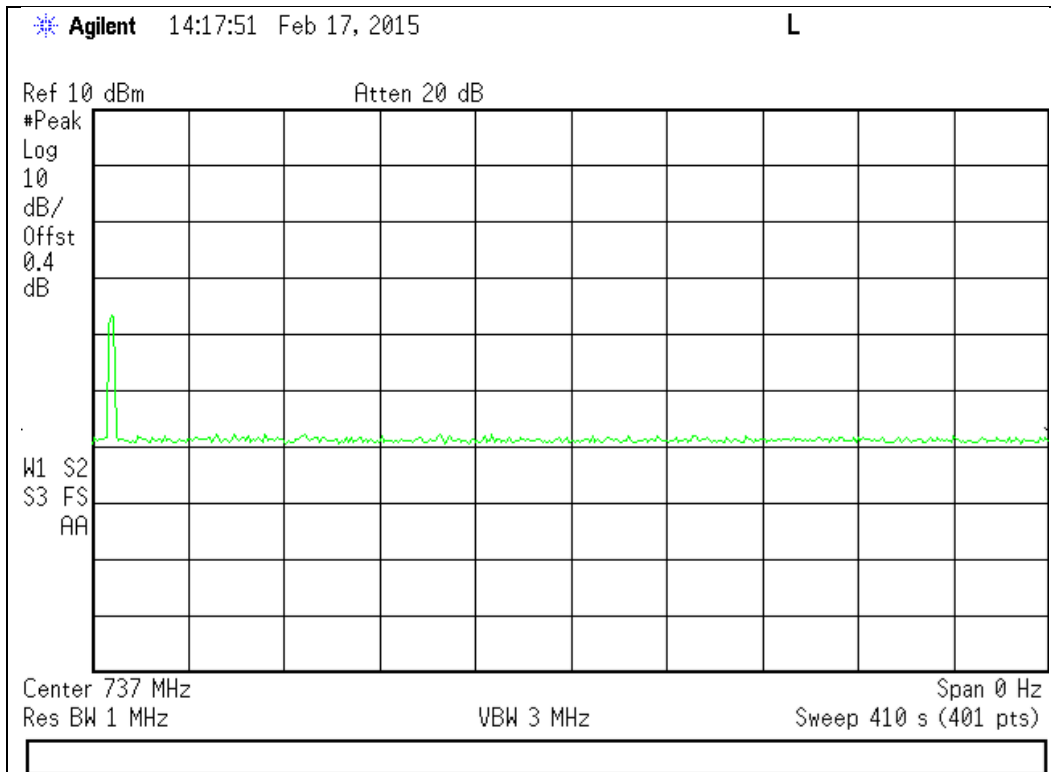

746 - 757 MHz Band

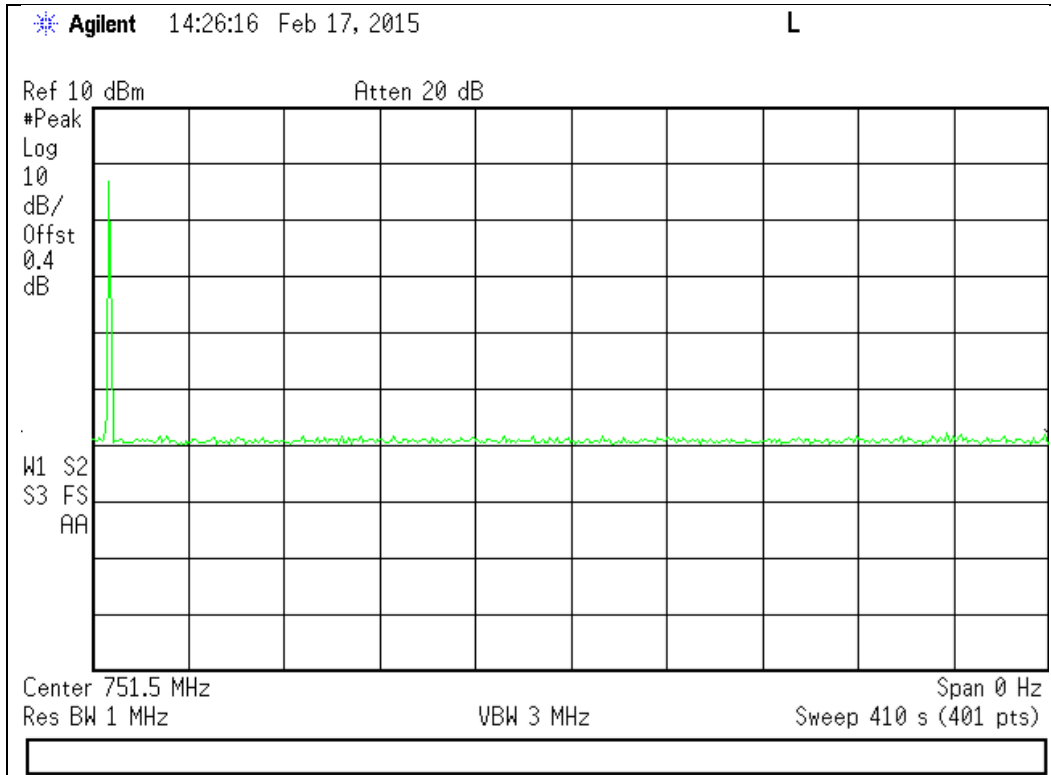

869 - 894 MHz Band

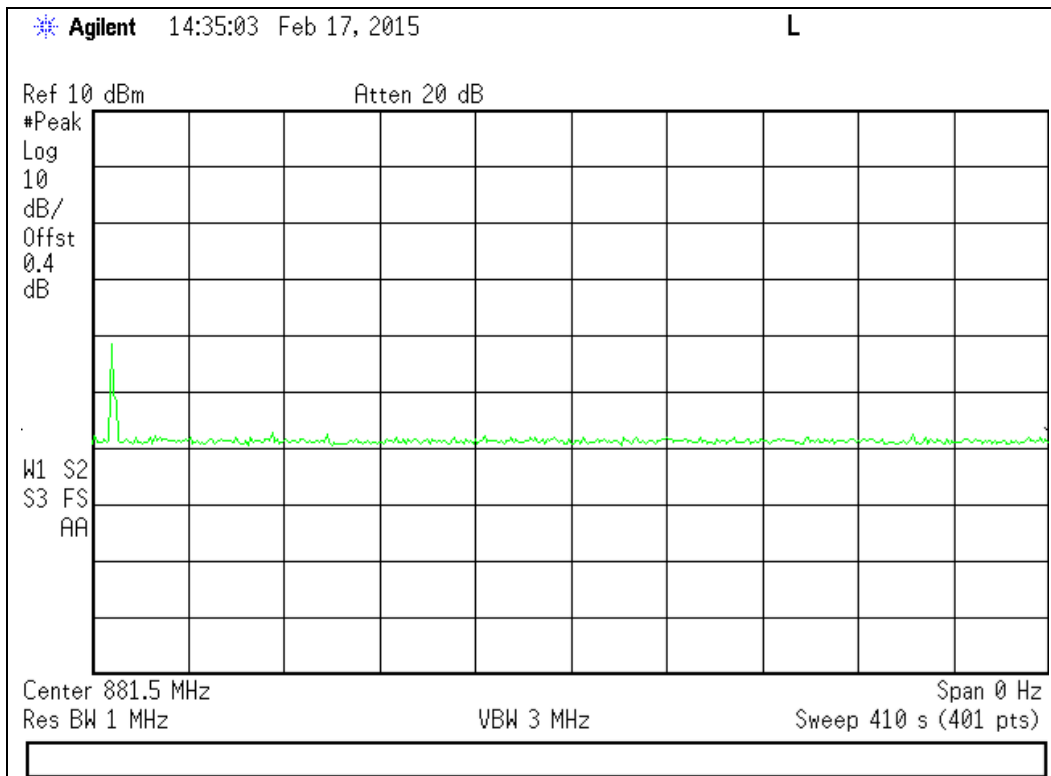



1930 - 1990 MHz Band

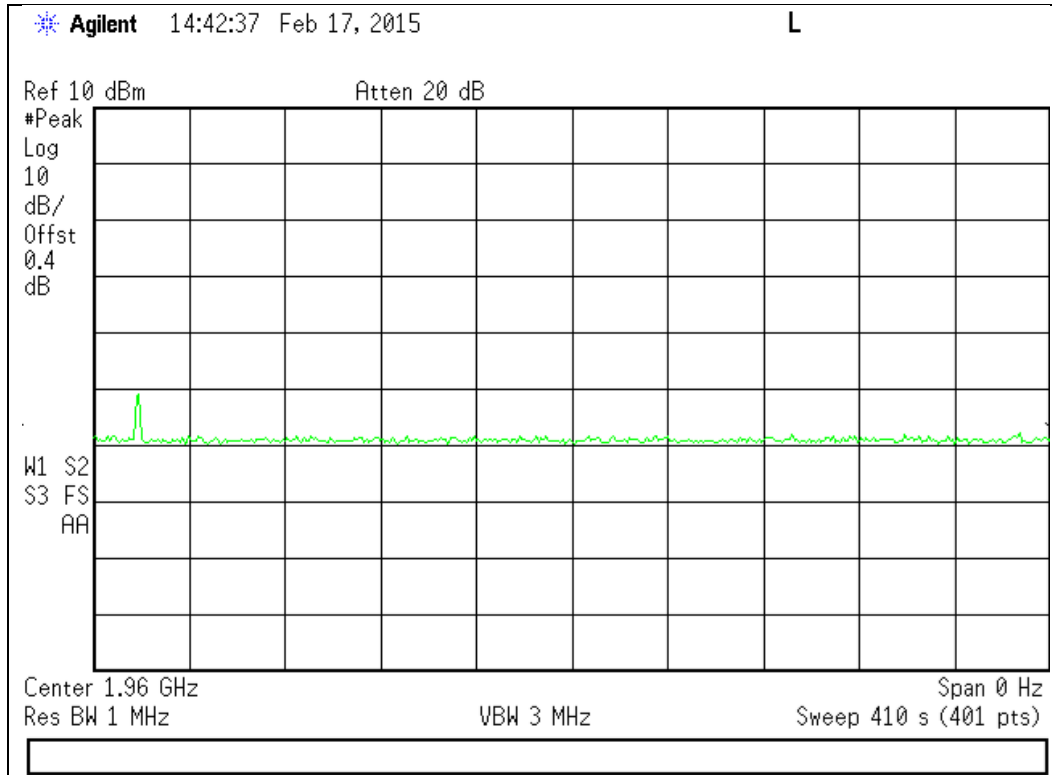

2110 - 2155 MHz Band

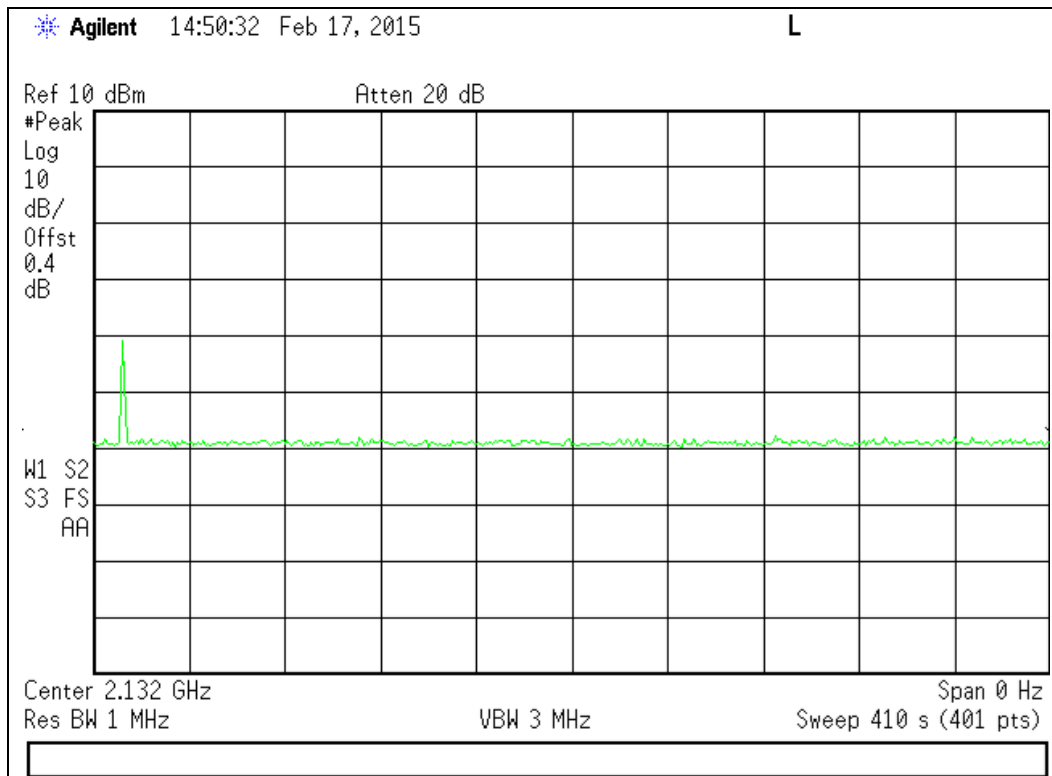

## Radiated Spurious

**Engineer:** Mike Graffeo

**Test Date:** 2/18/15

### Test Procedure

The EUT was tested in a semi-anechoic chamber with the turntable set 3m from the receiving antenna. A spectrum analyzer was used to verify that the EUT met the requirements for Radiated Emissions. The EUT was tested by rotating it 360 degrees with the antenna in both the vertical and horizontal orientation while raised from 1 to 4 meters to ensure that the signal levels were maximized. All cable and antenna correction factors were input into the spectrum analyzer ensuring an accurate measurement in ERP/EIRP with the resultant power in dBm. A signal generator was used to provide a CW signal centered in each operational uplink and downlink band. The EUT output was terminated into a 50 Ohm non-radiating load.

The following formula was used for calculating the limits:

Radiated Spurious Emissions Limit =  $P1 - (43 + 10\text{Log}(P2)) = -13\text{dBm}$

P1 = power in dBm

P2 = power in Watts

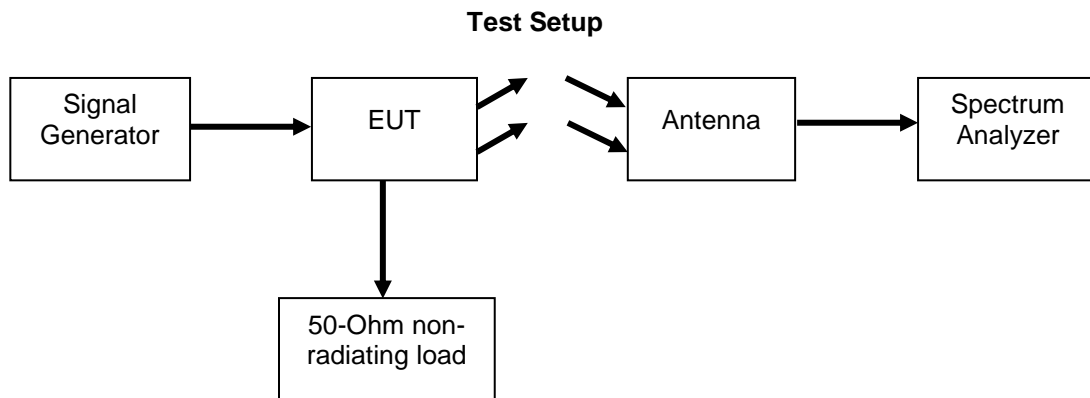

## Uplink Test Results

### 698 - 716 MHz Band 707 MHz Tuned Frequency

Measured Frequency (MHz)	Measured Level (dBm)	Limit (dBm)	Result
1414	-98.34	-13	Pass
2121	-93.18	-13	Pass
2828	-98.47	-13	Pass

### 776 - 787 MHz Band 781.5 MHz Tuned Frequency

Measured Frequency (MHz)	Measured Level (dBm)	Limit (dBm)	Result
1563	-96.57	-13	Pass
2344.5	-92.15	-13	Pass
3126	-97.72	-13	Pass

### 824 - 849 MHz Band 836.5 MHz Tuned Frequency

Measured Frequency (MHz)	Measured Level (dBm)	Limit (dBm)	Result
1673	-94.96	-13	Pass
2509.5	-91.93	-13	Pass
3344	-97.22	-13	Pass

### 1710 - 1755 MHz Band 1732.5 MHz Tuned Frequency

Measured Frequency (MHz)	Measured Level (dBm)	Limit (dBm)	Result
3465	-97.20	-13	Pass
5197.5	-94.28	-13	Pass
6830	-87.33	-13	Pass

### 1850 - 1910 MHz Band 1880 MHz Tuned Frequency

Measured Frequency (MHz)	Measured Level (dBm)	Limit (dBm)	Result
3760	-89.81	-13	Pass
5640	-83.07	-13	Pass
7520	-75.74	-13	Pass

## Downlink Test Results

### 728 - 746 MHz Band 737 MHz Tuned Frequency

Measured Frequency (MHz)	Measured Level (dBm)	Limit (dBm)	Result
1474	-87.99	-13	Pass
2211	-84.88	-13	Pass
2948	-80.47	-13	Pass

### 746 - 757 MHz Band 751.5 MHz Tuned Frequency

Measured Frequency (MHz)	Measured Level (dBm)	Limit (dBm)	Result
1503	-88.40	-13	Pass
2254.5	-85.94	-13	Pass
3006	-87.86	-13	Pass

### 869 - 894 MHz Band 881.5 MHz Tuned Frequency

Measured Frequency (MHz)	Measured Level (dBm)	Limit (dBm)	Result
1763	-87.48	-13	Pass
2644.5	-84.47	-13	Pass
3526	-89.01	-13	Pass

### 1930 - 1990 MHz Band 1960 MHz Tuned Frequency

Measured Frequency (MHz)	Measured Level (dBm)	Limit (dBm)	Result
	-87.48		
3920	-81.33	-13	Pass
5880	-82.87	-13	Pass
7840	-88.81	-13	Pass

### 2110 - 2155 MHz Band 2132.5 MHz Tuned Frequency

Measured Frequency (MHz)	Measured Level (dBm)	Limit (dBm)	Result
4265	-79.41	-13	Pass
6397.5	-81.82	-13	Pass
8530	-86.55	-13	Pass

No other emissions were detected. All emissions were lower than -13 dBm.  
 All emissions were system noise floor.

### Test Equipment Utilized

Description	Manufacturer	Model #	CT Asset #	Last Cal Date	Cal Due Date
Horn Antenna, Amplified	ARA	DRG-118/A	i00271	5/8/14	5/8/16
Bi-Log Antenna	Schaffner	CBL 6111D	i00349	10/8/13	10/8/15
Humidity / Temp Meter	Newport	IBTHX-W-5	i00282	3/24/14	3/24/15
Voltmeter	Fluke	75III	i00320	3/24/14	3/24/15
Spectrum Analyzer	Agilent	E4407B	i00331	6/13/2014	6/13/2016
Non-radiating load	Termaline	8201	i00334	Verified on: 1/10/15	
Signal Generator	Keysight (Agilent)	E4438C	I00457	9/26/2014	9/26/2016
RF Directional Coupler	Meca	CS06-1.500V	i00412	Verified on: 1/10/15	

In addition to the above listed equipment standard RF connectors and cables were utilized in the testing of the described equipment. Prior to testing these components were tested to verify proper operation.

END OF TEST REPORT