

TEST REPORT

Report No.: BCTC2108606153-1E

Applicant: Digiview Technology Limited

Product Name: Wireless charger

Model/Type Ref.: W25-C

Tested Date: 2021-08-31 to 2021-11-24

Issued Date: 2021-11-24



Shenzhen BCTC Testing Co., Ltd.



FCC ID:2ADWNW25-C

Product Name: Wireless charger
Trademark: bhipo
Model/Type Ref.: W25-C
Prepared For: Digiview Technology Limited
Address: Room 509, 5/F Tian Shu Block, Xinggang Tongchuanghui,
No.6099 Baoan Avenue, Baoan District, Shenzhen,
GuangDong, China
Manufacturer: Digiview Technology Limited
Address: Room 509, 5/F Tian Shu Block, Xinggang Tongchuanghui,
No.6099 Baoan Avenue, Baoan District, Shenzhen,
GuangDong, China
Prepared By: Shenzhen BCTC Testing Co., Ltd.
Address: 1-2/F., Building B, Pengzhou Industrial Park, No.158, Fuyuan 1st
Road, Tangwei, Fuhai Subdistrict, Bao'an District, Shenzhen,
Guangdong, China
Sample Received Date: 2021-08-31
Sample tested Date: 2021-08-31 to 2021-11-24
Issue Date: 2021-11-24
Report No.: BCTC2108606153-1E
Test Standards FCC Part15.209
ANSI C63.10-2013
Test Results PASS

Tested by:

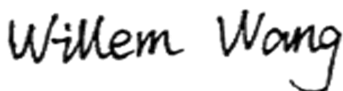
Willem Wang/Project Handler

Approved by:

Zero Zhou/Reviewer

The test report is effective only with both signature and specialized stamp. This result(s) shown in this report refer only to the sample(s) tested. Without written approval of Shenzhen BCTC Testing Co., Ltd, this report can't be reproduced except in full. The tested sample(s) and the sample information are provided by the client.

TABLE OF CONTENT

Test Report Declaration	Page
1. VERSION.....	4
2. TEST SUMMARY.....	5
3. MEASUREMENT UNCERTAINTY.....	6
4. PRODUCT INFORMATION AND TEST SETUP.....	7
4.1 Product Information.....	7
4.2 Test Setup Configuration.....	7
4.3 Support Equipment.....	7
4.5 Test Mode.....	8
5. TEST FACILITY AND TEST INSTRUMENT USED.....	9
5.1 Test Facility.....	9
5.2 Test Instrument Used.....	9
6. CONDUCTED EMISSIONS.....	11
6.1 Block Diagram Of Test Setup.....	11
6.2 Limit.....	11
6.3 Test procedure.....	11
6.4 EUT operating Conditions.....	11
6.5 Test Result.....	12
7. RADIATED EMISSIONS.....	14
7.1 Block Diagram Of Test Setup.....	14
7.2 Limit.....	15
7.3 Test procedure.....	15
7.4 Test Result.....	17
8. BANDWIDTH.....	20
8.1 Block Diagram Of Test Setup.....	20
8.2 Test procedure.....	20
8.3 Test Result.....	21
9. ANTENNA REQUIREMENT.....	22
9.1 Limit.....	22
9.2 Test Result.....	22
10. EUT PHOTOGRAPHS.....	23
11. EUT TEST SETUP PHOTOGRAPHS.....	24

(Note: N/A means not applicable)

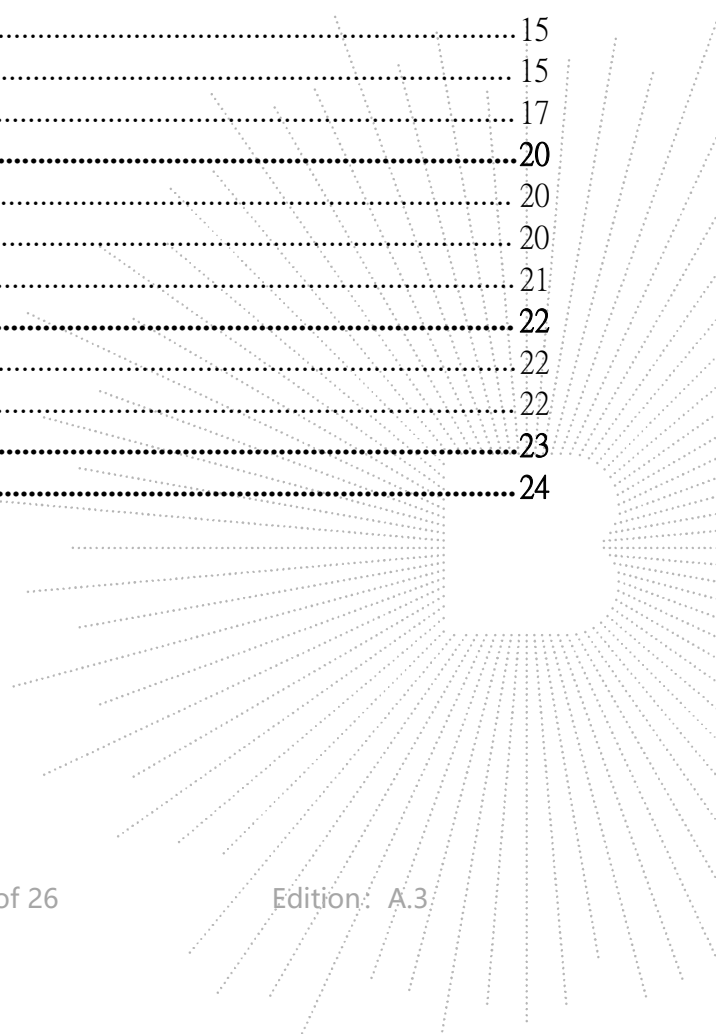

1. VERSION

Report No.	Issue Date	Description	Approved
BCTC2108606153-1E	2021-11-24	Original	Valid

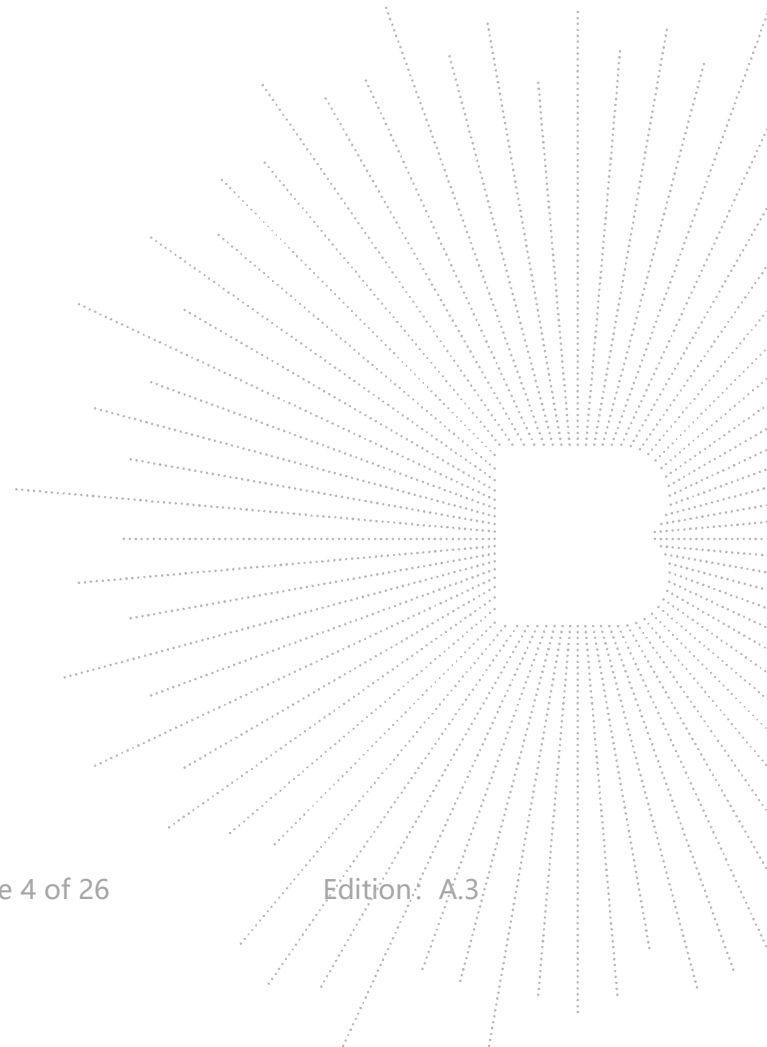

2. TEST SUMMARY

The Product has been tested according to the following specifications:

No.	Test Parameter	Clause No	Results
1	Conducted Emission	15.207	PASS
2	Radiated Emission	15.209	PASS
3	Bandwidth	15.215	PASS
4	Antenna Requirement	15.203	PASS

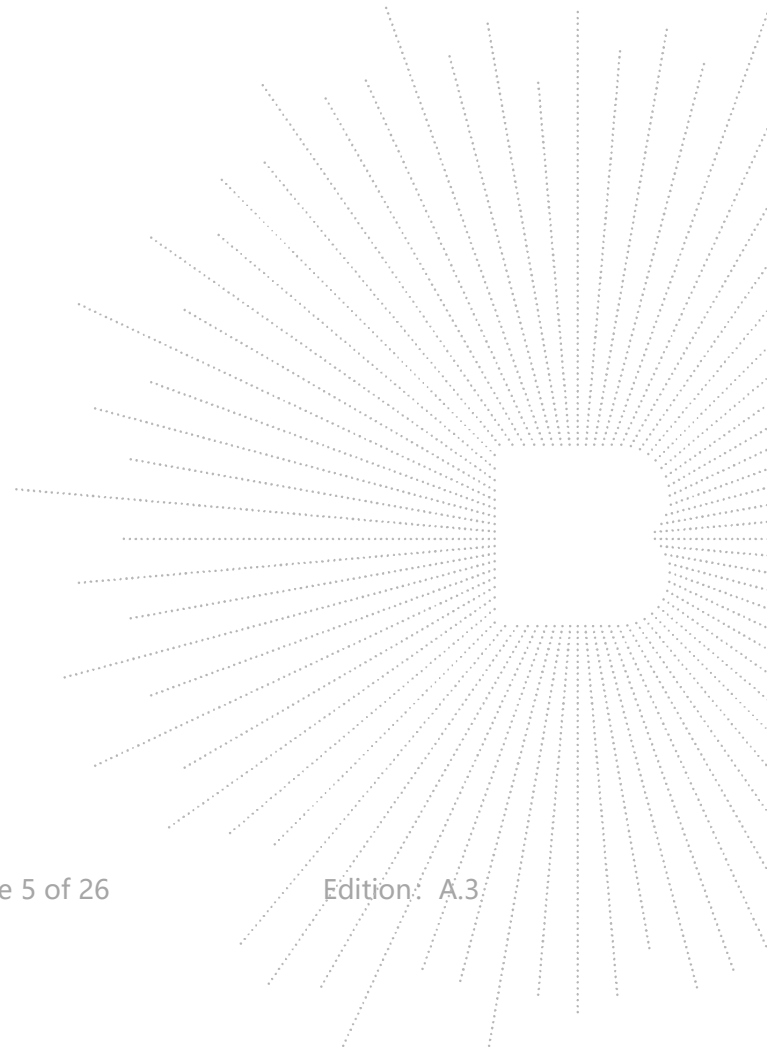

3. MEASUREMENT UNCERTAINTY

Where relevant, the following measurement uncertainty levels have been estimated for tests performed on the Product as specified in CISPR 16-4-2. This uncertainty represents an expanded uncertainty expressed at approximately the 95% confidence level using a coverage factor of $k=2$.

No.	Item	Uncertainty
1	3m chamber Radiated spurious emission(30MHz-1GHz)	U=4.3dB
2	Conducted Emission (150kHz-30MHz)	U=3.2dB
3	humidity uncertainty	U=5.3%
4	Temperature uncertainty	U=0.59°C

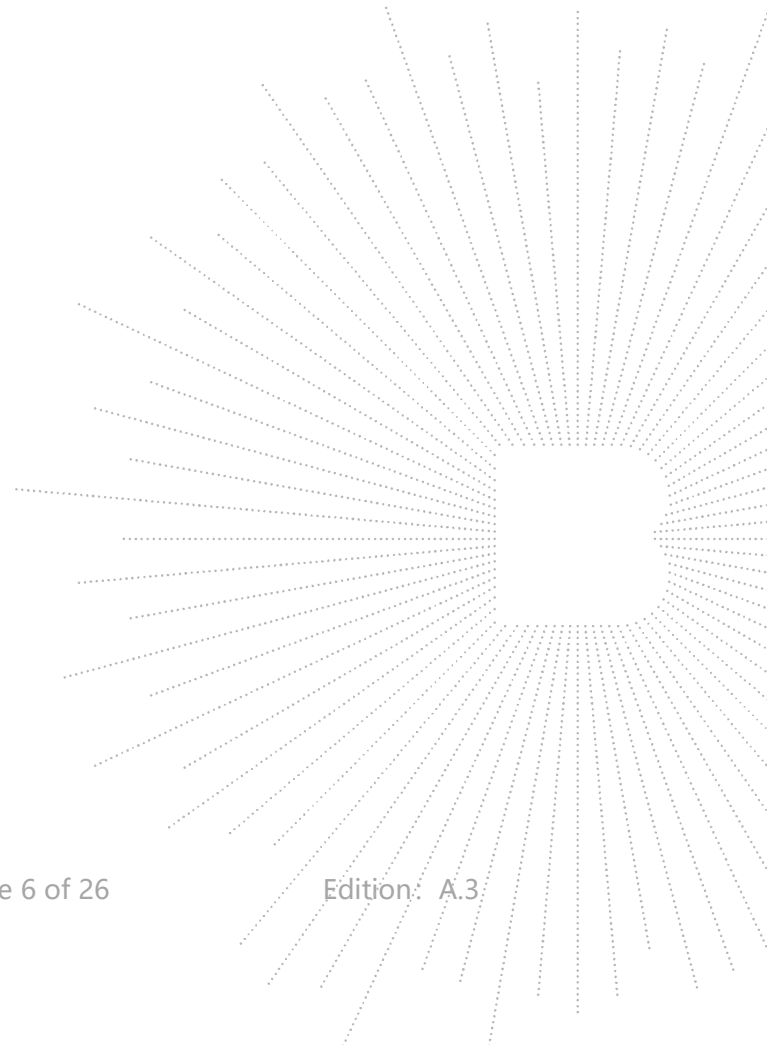

4. PRODUCT INFORMATION AND TEST SETUP

4.1 Product Information

Model/Type Ref.:	W25-C
Model differences:	N/A
Product Description:	Wireless charger
Operation Frequency:	115kHz-205kHz
Antenna installation:	loop coil antenna
Ratings:	INPUT: DC 9V 1.2A; OUTPUT: 7.5W DC 9V 1.5A; OUTPUT: 10W DC 9V 2.4A; OUTPUT: 15W

4.2 Test Setup Configuration

See test photographs attached in *EUT TEST SETUP PHOTOGRAPHS* for the actual connections between Product and support equipment.

Conducted Emission/Radiated Spurious Emission:

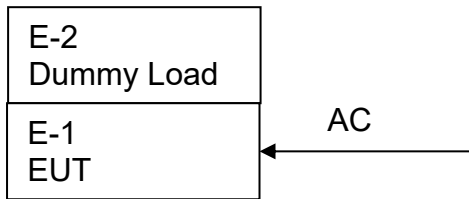

4.3 Support Equipment

No.	Device Type	Brand	Model	Series No.	Data Cable	Remark
E-1	Wireless charger	bhipo	W25-C	N/A	N/A	EUT
E-2	Dummy load	N/A	DL01	N/A	N/A	Auxiliary

Notes:

1. All the equipment/cables were placed in the worst-case configuration to maximize the emission during the test.
2. Grounding was established in accordance with the manufacturer's requirements and conditions for the intended use.

4.5 Test Mode

To investigate the maximum EMI emission characteristics generated from EUT, the test system was pre-scanning tested based on the consideration of following EUT operation mode or test configuration mode which possibly have effect on EMI emission level. Each of these EUT operation mode(s) or test configuration mode(s) mentioned above was evaluated respectively.

Test Modes 1	Wireless charging (7.5W)
Test Modes 2	Wireless charging (10W)
Test Modes 3	Wireless charging (15W)

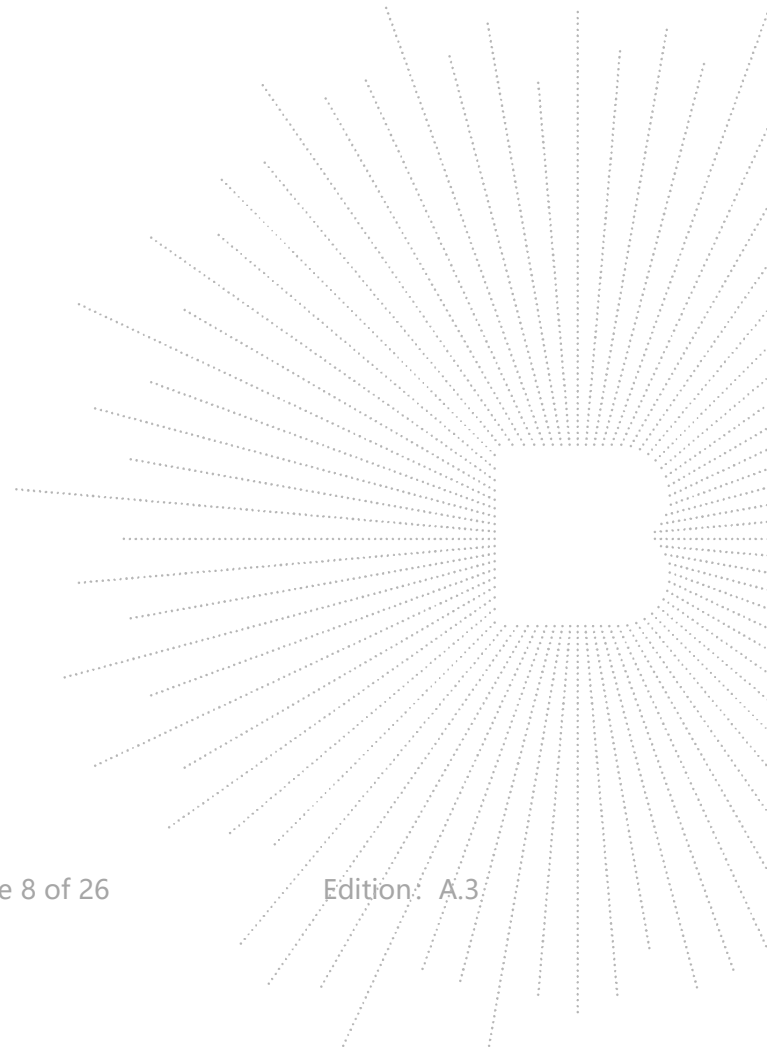

5. TEST FACILITY AND TEST INSTRUMENT USED

5.1 Test Facility

All measurement facilities used to collect the measurement data are located at Shenzhen BCTC Testing Co., Ltd. Address:1-2/F., Building B, Pengzhou Industrial Park, No.158, Fuyuan 1st Road, Tangwei, Fuhai Subdistrict, Bao'an District, Shenzhen, Guangdong, China. The site and apparatus are constructed in conformance with the requirements of ANSI C63.4 and CISPR 16-1-1 other equivalent standards.

FCC Test Firm Registration Number: 712850

IC Registered No.: 23583

5.2 Test Instrument Used

Conducted emissions Test					
Equipment	Manufacturer	Model#	Serial#	Last Cal.	Next Cal.
Receiver	R&S	ESR3	102075	May 28, 2021	May 27, 2022
LISN	R&S	ENV216	101375	May 28, 2021	May 27, 2022
ISN	HPX	ISN T800	S1509001	May 28, 2021	May 27, 2022
Software	Frad	EZ-EMC	EMC-CON 3A1	\	\

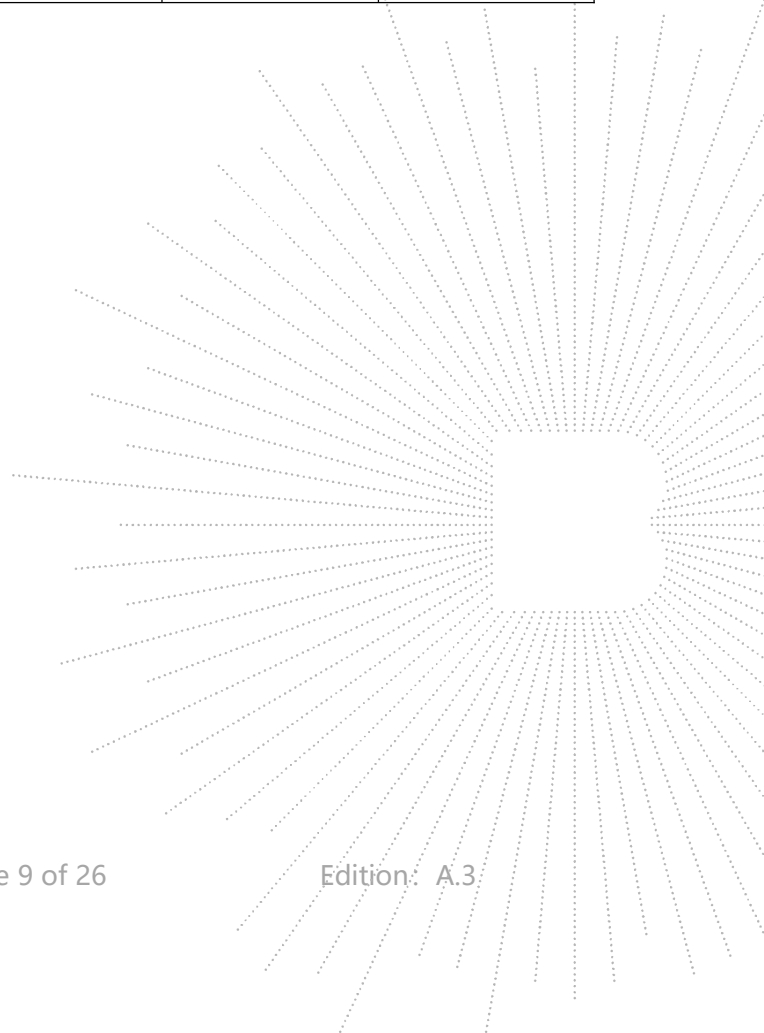

Radiated emissions Test (966 chamber)					
Equipment	Manufacturer	Model#	Serial#	Last Cal.	Next Cal.
966 chamber	ChengYu	966 Room	966	Jun. 06. 2020	Jun. 05, 2023
Receiver	R&S	ESR3	102075	May 28, 2021	May 27, 2022
Receiver	R&S	ESRP	101154	May 28, 2021	May 27, 2022
Amplifier	SKET	LAPA_01G 18G-45dB	\	May 28, 2021	May 27, 2022
Amplifier	Schwarzbeck	BBV9744	9744-0037	May 28, 2021	May 27, 2022
TRILOG Broadband Antenna	schwarzbeck	VULB 9163	VULB9163- 942	Jun. 01, 2021	May 31, 2022
Horn Antenna	SCHWARZBE CK	BBHA9120 D	1201	Jun. 02, 2021	Jun. 01, 2022
Horn Antenna (18GHz-40 GHz)	SCHWARZBE CK	BBHA9170	822	Jun. 15, 2021	Jun. 14, 2022
Amplifier (18GHz-40 GHz)	MITEQ	TTA1840-3 5-HG	2034381	May 28, 2021	May 27, 2022
Loop Antenna (9KHz-30M Hz)	SCHWARZBE CK	FMZB1519 B	014	Jun. 02, 2021	Jun. 01, 2022
RF cables1 (9kHz-30MH z)	Huber+Suhnar	9kHz-30M Hz	B1702988- 0008	May 28, 2021	May 27, 2022
RF cables2 (30MHz-1G Hz)	Huber+Suhnar	30MHz-1G Hz	1486150	May 28, 2021	May 27, 2022
RF cables3 (1GHz-40G Hz)	Huber+Suhnar	1GHz-40G Hz	1607106	May 28, 2021	May 27, 2022
Power Metter	Keysight	E4419B	\	May 28, 2021	May 27, 2022
Power Sensor (AV)	Keysight	E9 300A	\	May 28, 2021	May 27, 2022
Signal Analyzer 20kHz-26.5 GHz	KEYSIGHT	N9020A	MY491000 60	May 28, 2021	May 27, 2022
Spectrum Analyzer 9kHz-40G Hz	R&S	FSP40	100363	May 28, 2021	May 27, 2022
Software	Frad	EZ-EMC	FA-03A2 RE	\	\

6. CONDUCTED EMISSIONS

6.1 Block Diagram Of Test Setup

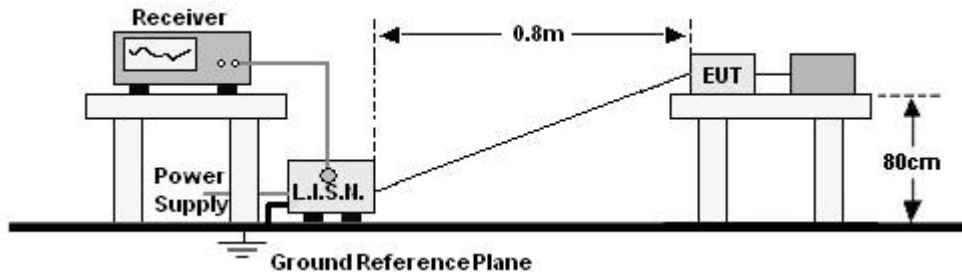

6.2 Limit

FREQUENCY (MHz)	Limit (dBuV)	
	Quas-peak	Average
0.15 -0.5	66 - 56 *	56 - 46 *
0.50 -5.0	56.00	46.00
5.0 -30.0	60.00	50.00

Notes:
 1. *Decreasing linearly with logarithm of frequency.
 2. The lower limit shall apply at the transition frequencies.

6.3 Test procedure

Receiver Parameters	Setting
Attenuation	10 dB
Start Frequency	0.15 MHz
Stop Frequency	30 MHz
IF Bandwidth	9 kHz

a. The Product was placed on a nonconductive table 0.8 m above the horizontal ground reference plane, and 0.4 m from the vertical ground reference plane, and connected to the main through Line Impedance Stability Network (L.I.S.N).

b. The RBW of the receiver was set at 9 kHz in 150 kHz ~ 30MHz with Peak and AVG detector in Max Hold mode. Run the receiver's pre-scan to record the maximum disturbance generated from Product in all power lines in the full band.

c. For each frequency whose maximum record was higher or close to limit, measure its QP and AVG values and record.

6.4 EUT operating Conditions

The EUT was configured for testing in a typical fashion (as a customer would normally use it). The EUT has been programmed to continuously transmit during test. This operating condition was tested and used to collect the included data.

6.5 Test Result

Temperature:	26 °C	Relative Humidity:	54%
Pressure:	101kPa	Phase :	L
Test Voltage :	AC 120V/60Hz	Test Mode:	The Worst Mode: Wireless charging (15W)

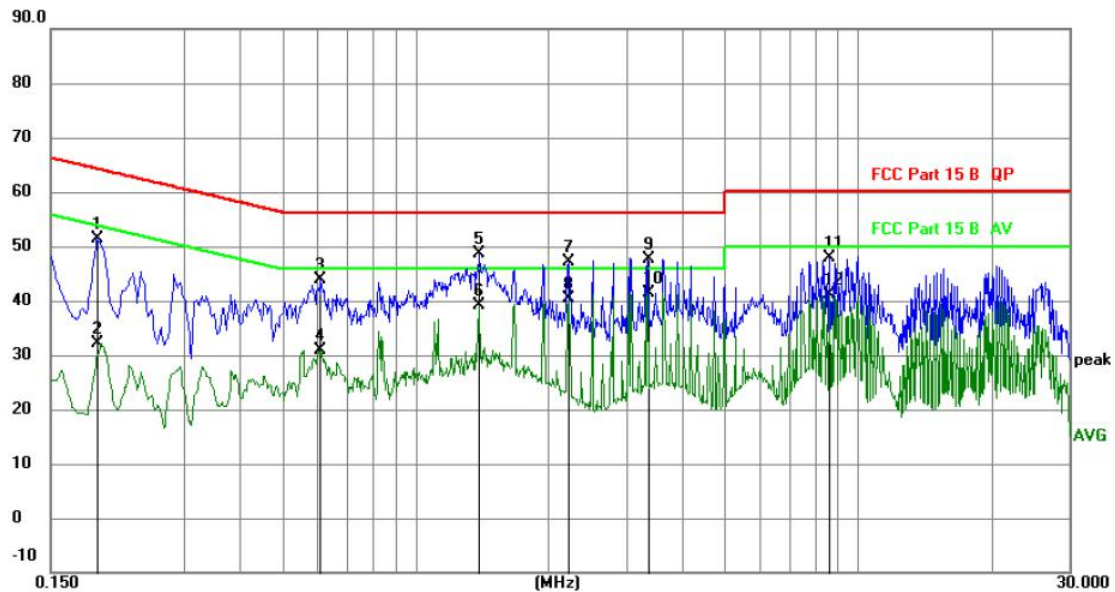

Remark:

1. All readings are Quasi-Peak and Average values.
2. Factor = Insertion Loss + Cable Loss.

No.	Mk.	Freq.	Reading Level	Correct Factor	Measurement	Limit	Over	Detector	Comment
		MHz		dB	dBuV	dBuV	dB		
1		0.1905	31.80	19.61	51.41	64.01	-12.60	QP	
2		0.1905	12.60	19.61	32.21	54.01	-21.80	AVG	
3		0.6045	24.37	19.62	43.99	56.00	-12.01	QP	
4		0.6045	11.16	19.62	30.78	46.00	-15.22	AVG	
5		1.3920	29.04	19.63	48.67	56.00	-7.33	QP	
6		1.3920	19.48	19.63	39.11	46.00	-6.89	AVG	
7		2.2244	27.49	19.64	47.13	56.00	-8.87	QP	
8		2.2244	20.70	19.64	40.34	46.00	-5.66	AVG	
9		3.3585	27.85	19.67	47.52	56.00	-8.48	QP	
10	*	3.3585	21.81	19.67	41.48	46.00	-4.52	AVG	
11		8.6280	28.08	19.77	47.85	60.00	-12.15	QP	
12		8.6280	21.39	19.77	41.16	50.00	-8.84	AVG	

Temperature:	26 °C	Relative Humidity:	54%
Pressure:	101kPa	Phase:	N
Test Voltage :	AC 120V/60Hz	Test Mode:	The Worst Mode: Wireless charging (15W)

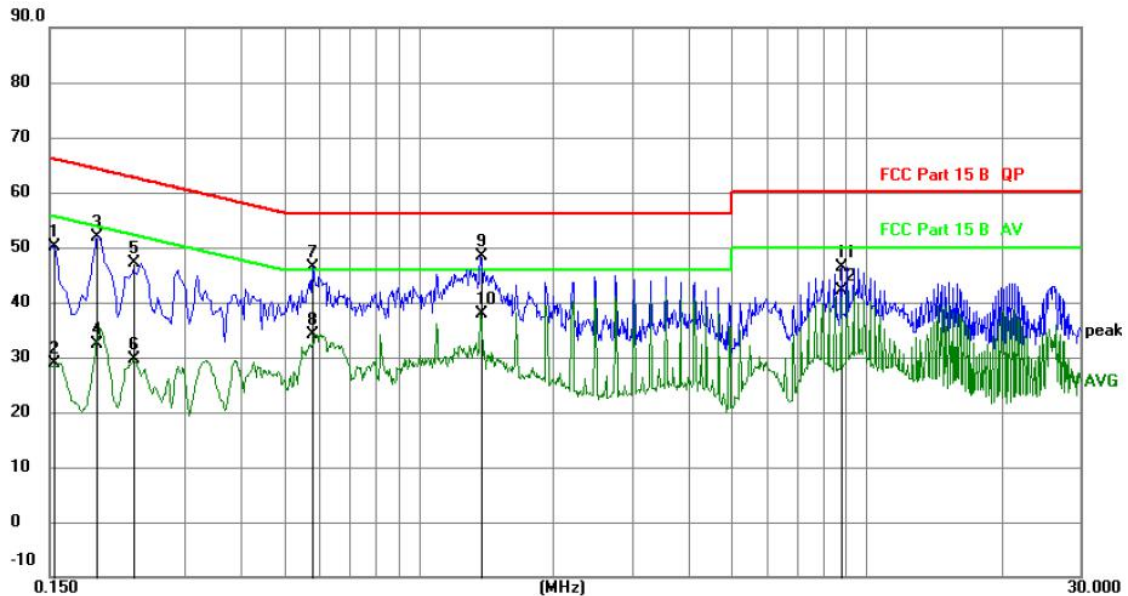
Remark:

1. All readings are Quasi-Peak and Average values.
2. Factor = Insertion Loss + Cable Loss.

No.	Mk.	Freq. MHz	Reading Level	Correct Factor dB	Measure- ment dBuV	Limit dBuV	Over dB	Detector	Comment
1		0.1539	30.61	19.61	50.22	65.79	-15.57	QP	
2		0.1539	9.33	19.61	28.94	55.79	-26.85	AVG	
3		0.1904	32.37	19.61	51.98	64.02	-12.04	QP	
4		0.1904	12.77	19.61	32.38	54.02	-21.64	AVG	
5		0.2304	27.55	19.61	47.16	62.44	-15.28	QP	
6		0.2304	10.04	19.61	29.65	52.44	-22.79	AVG	
7		0.5792	26.74	19.62	46.36	56.00	-9.64	QP	
8		0.5792	14.60	19.62	34.22	46.00	-11.78	AVG	
9	*	1.3738	28.67	19.63	48.30	56.00	-7.70	QP	
10		1.3738	18.33	19.63	37.96	46.00	-8.04	AVG	
11		8.7757	26.60	19.78	46.38	60.00	-13.62	QP	
12		8.7757	22.40	19.78	42.18	50.00	-7.82	AVG	

7. RADIATED EMISSIONS

7.1 Block Diagram Of Test Setup

(A) Radiated Emission Test-Up Frequency Below 30MHz

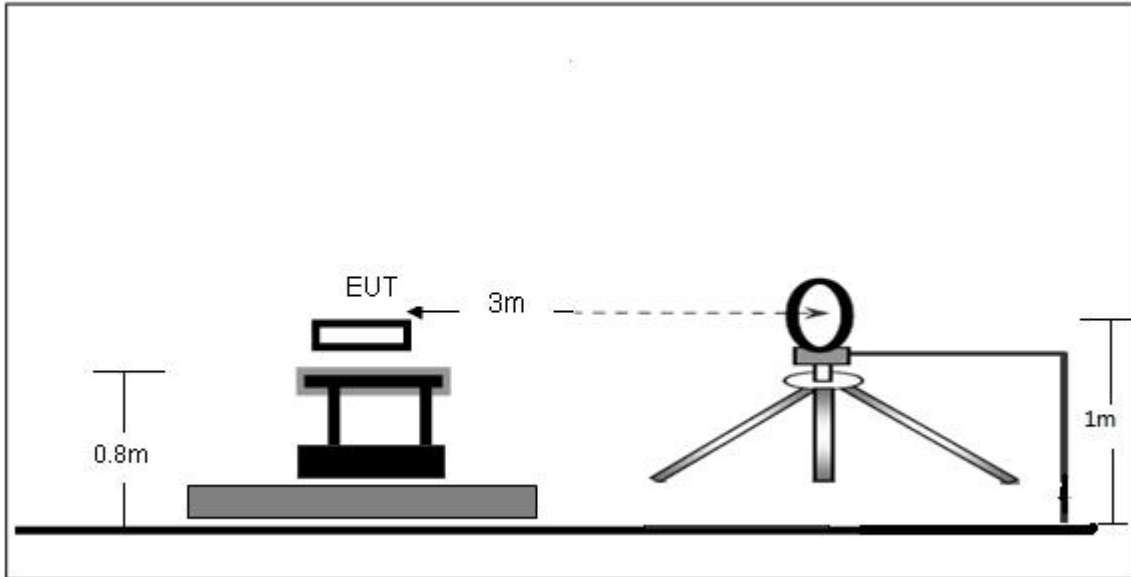

(B) Radiated Emission Test-Up Frequency 30MHz~1GHz

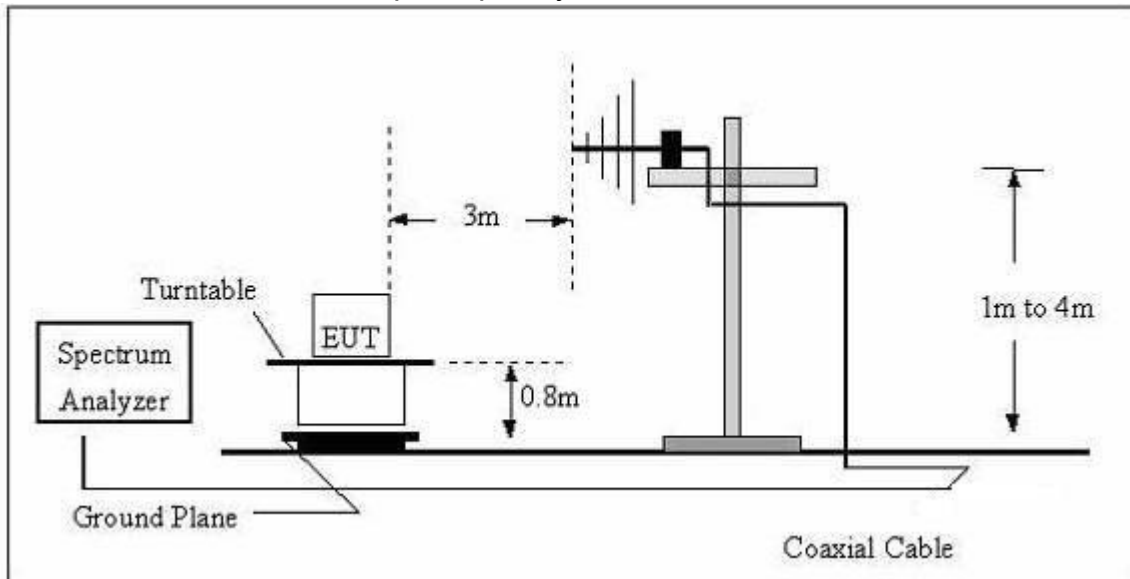

7.2 Limit

FCC §15.209; §15.205.

Test Standard	FCC Part15 C Section 15.209 and 15.205				
Test Limit	Frequency (MHz)	Field strength (microvolt/meter)	Limit (dBuV/m)	Remark	Measurement distance (m)
	0.009MHz~0.490MHz	2400/F(kHz)	-	-	300
	0.490MHz~1.705MHz	24000/F(kHz)	-	-	30
	1.705MHz~30MHz	30	-	-	30
	30MHz~88MHz	100	40.0	Quasi-peak	3
	88MHz~216MHz	150	43.5	Quasi-peak	3
	216MHz~960MHz	200	46.0	Quasi-peak	3
	960MHz~1000MHz	500	54.0	Quasi-peak	3
	Above 1000MHz	500	54.0	Average	3
-		74.0	Peak	3	

7.3 Test procedure

Receiver Parameter	Setting
Attenuation	Auto
9kHz~150kHz	RBW 200Hz for QP
150kHz~30MHz	RBW 9kHz for QP
30MHz~1000MHz	RBW 120kHz for QP

Below 1GHz test procedure as below:

- The EUT was placed on the top of a rotating table 0.8 meters above the ground at a 3 meter semi-anechoic chamber. The table was rotated 360 degrees to determine the position of the highest radiation.
- The EUT was set 3 meters away from the interference-receiving antenna, which was mounted on the top of a variable-height antenna tower.
- The antenna height is varied from one meter to four meters above the ground to determine the maximum value of the field strength. Both horizontal and vertical polarizations of the antenna are set to make the measurement.
- For each suspected emission, the EUT was arranged to its worst case and then the antenna was tuned to heights from 1 meter to 4 meters (for the test frequency of below 30MHz, the antenna was tuned to heights 1 meter) and the rotatable table was turned from 0 degrees to 360 degrees to find the maximum reading.
- The test-receiver system was set to Peak Detect Function and Specified Bandwidth with Maximum Hold Mode.

f. If the emission level of the EUT in peak mode was 10dB lower than the limit specified, then testing could be stopped and the peak values of the EUT would be reported. Otherwise the emissions that did not have 10dB margin would be re-tested one by one using peak, quasi-peak or average method as specified and then reported in a data sheet.

Above 1GHz test procedure as below:

g. Different between above is the test site, change from Semi- Anechoic Chamber to fully Anechoic Chamber and change form table 0.8 metre to 1.5 metre(Above 18GHz the distance is 1 meter and table is 1.5 metre).

h. Test the EUT in the lowest channel ,the middle channel ,the Highest channel.

Note:

Both horizontal and vertical antenna polarities were tested and performed pretest to three orthogonal axis. The worst case emissions were reported.

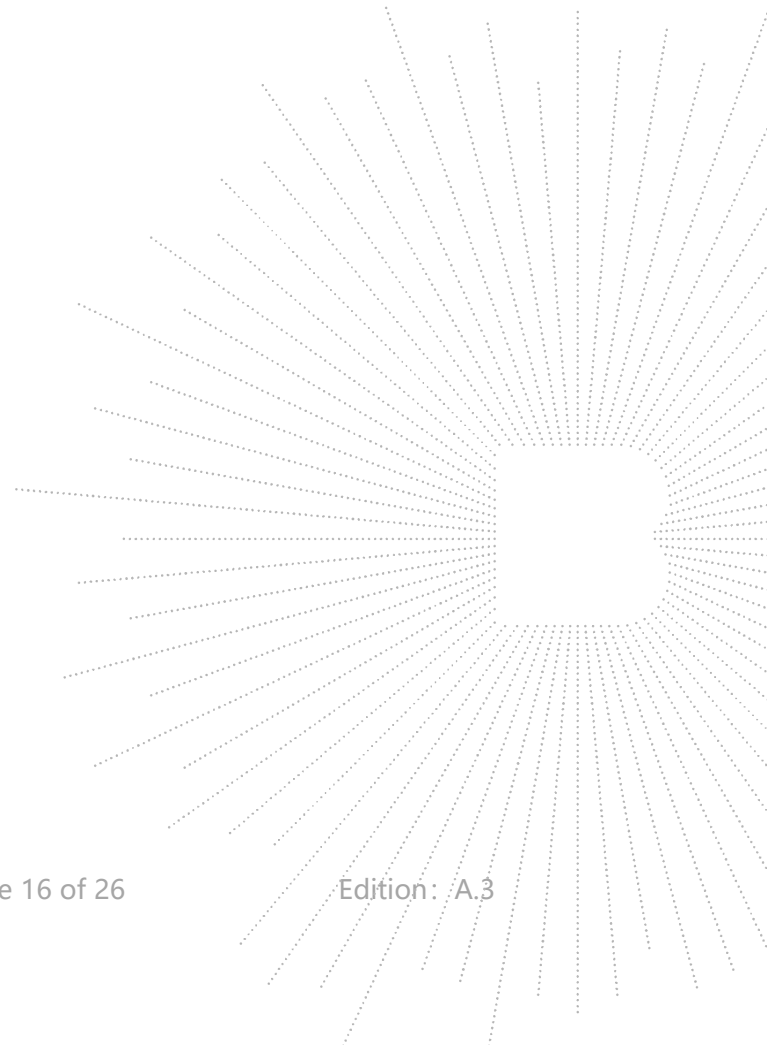

7.4 Test Result

9kHz-30MHz

Temperature:	26°C	Relative Humidity:	24%
Pressure:	101 kPa	Test Voltage :	AC 120V/60Hz
Test Mode:	The Worst Mode: Wireless charging (15W)	Polarization :	--

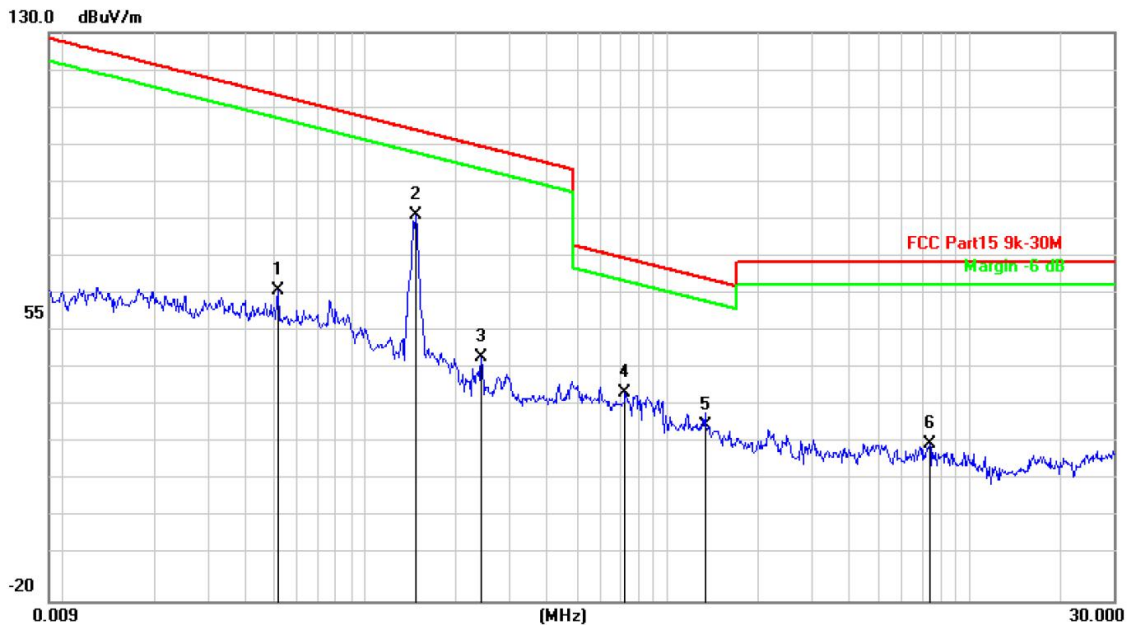

Frequency (MHz)	Meter Reading (dBμV)	Factor (dB)	Emission Level (dBμV/m)	Limits (dBμV/m)	Margin (dB)	Detector Type
0.0514	72.65	-10.64	62.01	133.39	-71.38	PK
0.0514	63.25	-10.64	52.61	113.39	-60.78	AV
0.1466	91.88	-10.02	81.86	124.28	-42.42	PK
0.1466	80.57	-10.02	70.55	104.28	-33.73	AV
0.2424	54.42	-10.26	44.16	119.91	-75.75	PK
0.2424	46.38	-10.26	36.12	99.91	-63.79	AV
0.7246	45.3	-10.25	35.05	70.41	-35.36	QP
1.3423	36.56	-10.21	26.35	65.07	-38.72	QP
7.3733	30.92	-9.59	21.33	69.54	-48.21	QP

Note:

Pre-scan in the all of mode, the worst case in of was recorded.

Factor = antenna factor + cable loss – pre-amplifier.

Margin = Emission Level- Limit.

Between 30MHz – 1GHz

Temperature:	26°C	Relative Humidity:	54%
Pressure:	101 kPa	Test Voltage :	AC 120V/60Hz
Test Mode:	The Worst Mode: Wireless charging (15W)	Polarization :	Horizontal

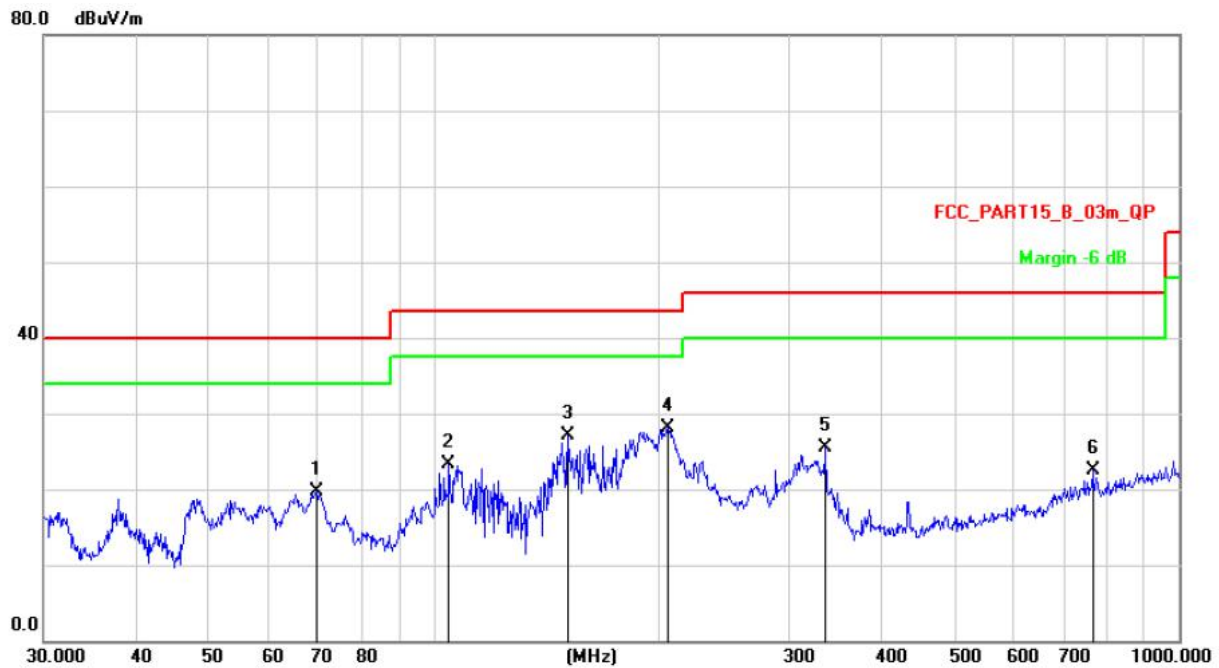

Remark:

Factor = Antenna Factor + Cable Loss – Pre-amplifier.

No.	Mk.	Freq.	Reading Level	Correct Factor	Measurement	Limit	Over	Detector
		MHz	dBuV	dB	dBuV/m	dB/m	dB	
1		69.8450	37.88	-18.15	19.73	40.00	-20.27	QP
2		104.9033	39.89	-16.60	23.29	43.50	-20.21	QP
3		151.5972	46.58	-19.40	27.18	43.50	-16.32	QP
4	*	206.3976	44.31	-16.15	28.16	43.50	-15.34	QP
5		336.0352	38.15	-12.61	25.54	46.00	-20.46	QP
6		766.0571	26.56	-4.12	22.44	46.00	-23.56	QP

Temperature:	26°C	Relative Humidity:	54%
Pressure:	101 kpa	Test Voltage :	AC 120V/60Hz
Test Mode:	The Worst Mode: Wireless charging (15W)	Polarization :	Vertical

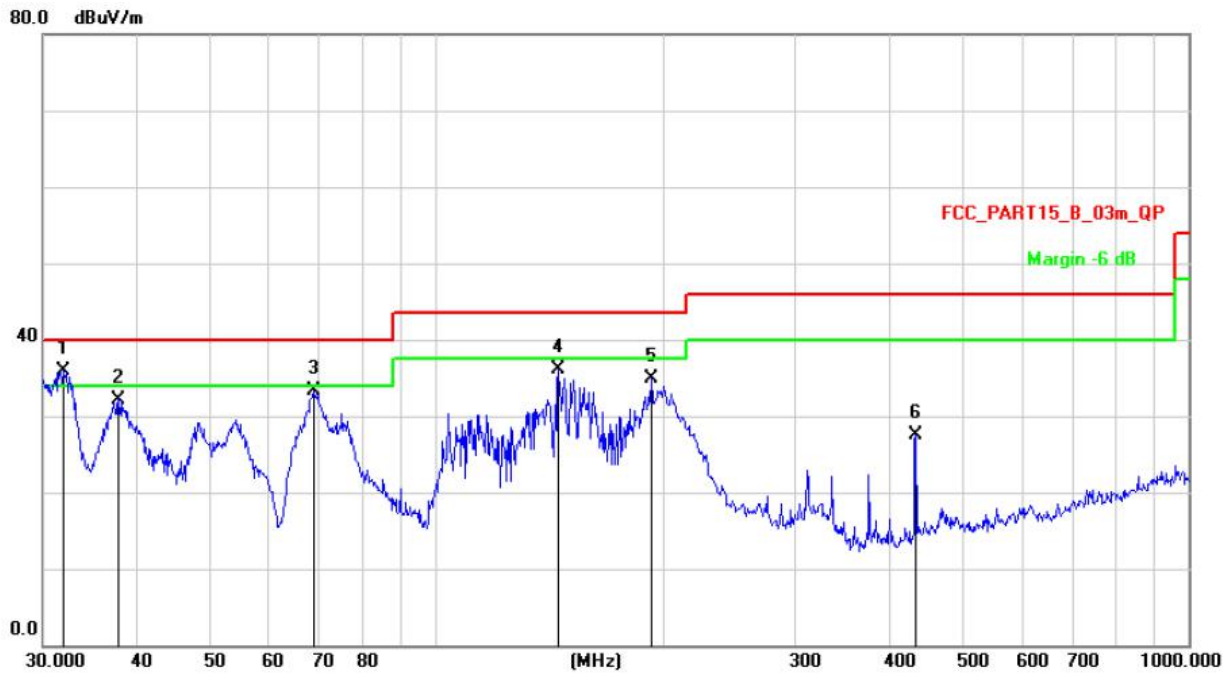

Remark:

Factor = Antenna Factor + Cable Loss – Pre-amplifier.

No.	Mk.	Freq. MHz	Reading Level dBuV	Correct Factor dB	Measure- ment dBuV/m	Limit dB/m	Over dB	Detector
1	*	31.9546	52.80	-16.91	35.89	40.00	-4.11	QP
2		37.8121	48.02	-15.82	32.20	40.00	-7.80	QP
3		68.6310	51.11	-17.88	33.23	40.00	-6.77	QP
4		145.3506	55.23	-19.20	36.03	43.50	-7.47	QP
5		193.0945	51.73	-16.74	34.99	43.50	-8.51	QP
6		434.0651	37.88	-10.33	27.55	46.00	-18.45	QP

8. BANDWIDTH

8.1 Block Diagram Of Test Setup



8.2 Test procedure

1. Set RBW = 1%-5% OBW
2. Set the video bandwidth (VBW) $\geq 3 \times$ RBW.
3. Detector = Peak.
4. Trace mode = max hold.
5. Sweep = auto couple.
6. Allow the trace to stabilize.
7. Measure the maximum width of the emission that is constrained by the frequencies associated with the two outermost amplitude points (upper and lower frequencies) that are attenuated by 26 dB relative to the maximum level measured in the fundamental emission.

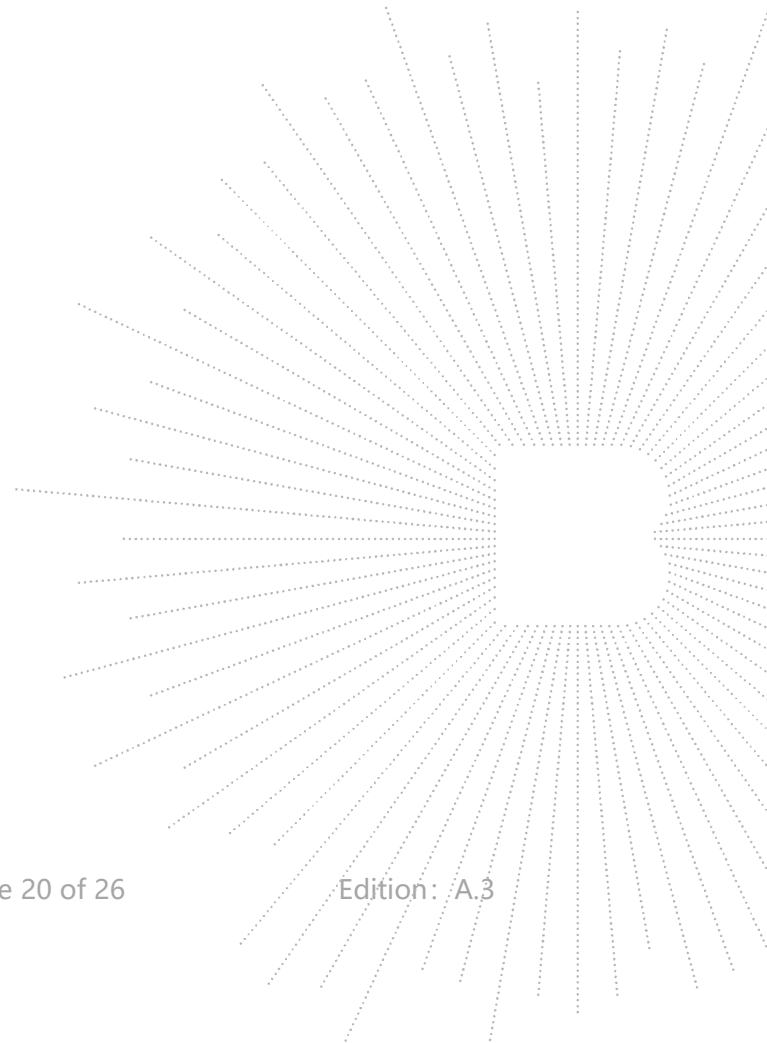

8.3 Test Result

Frequency (KHz)	20dB bandwidth (KHz)	99% bandwidth (KHz)	Result
127.22	0.013	0.011	Pass

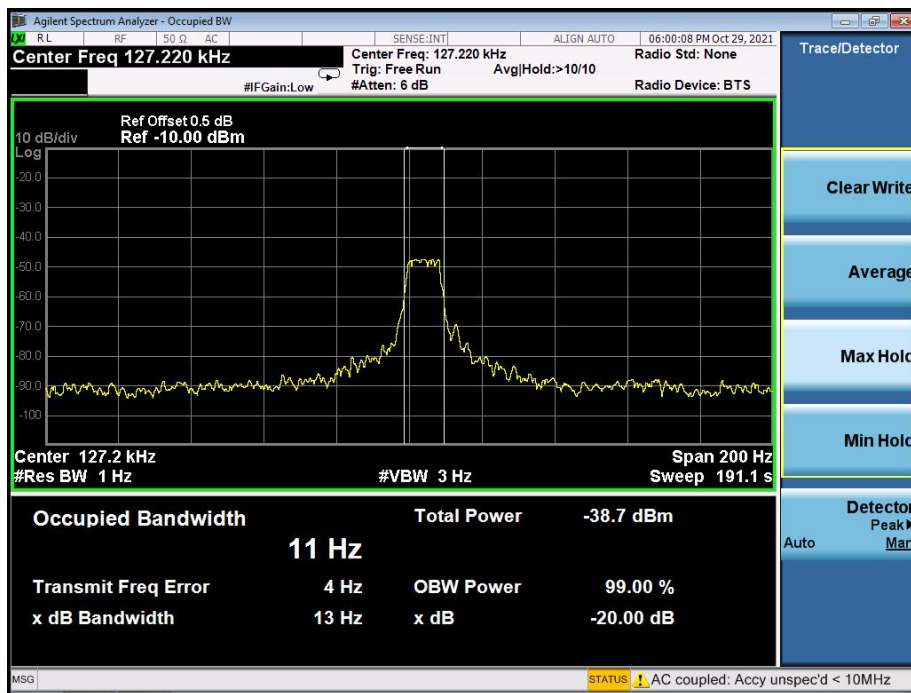

9. ANTENNA REQUIREMENT

9.1 Limit

15.203 requirement: For intentional device, according to 15.203: an intentional radiator shall be designed to ensure that no antenna other than that furnished by the responsible party shall be used with the device.

9.2 Test Result

The EUT antenna is loop coil antenna, fulfill the requirement of this section.

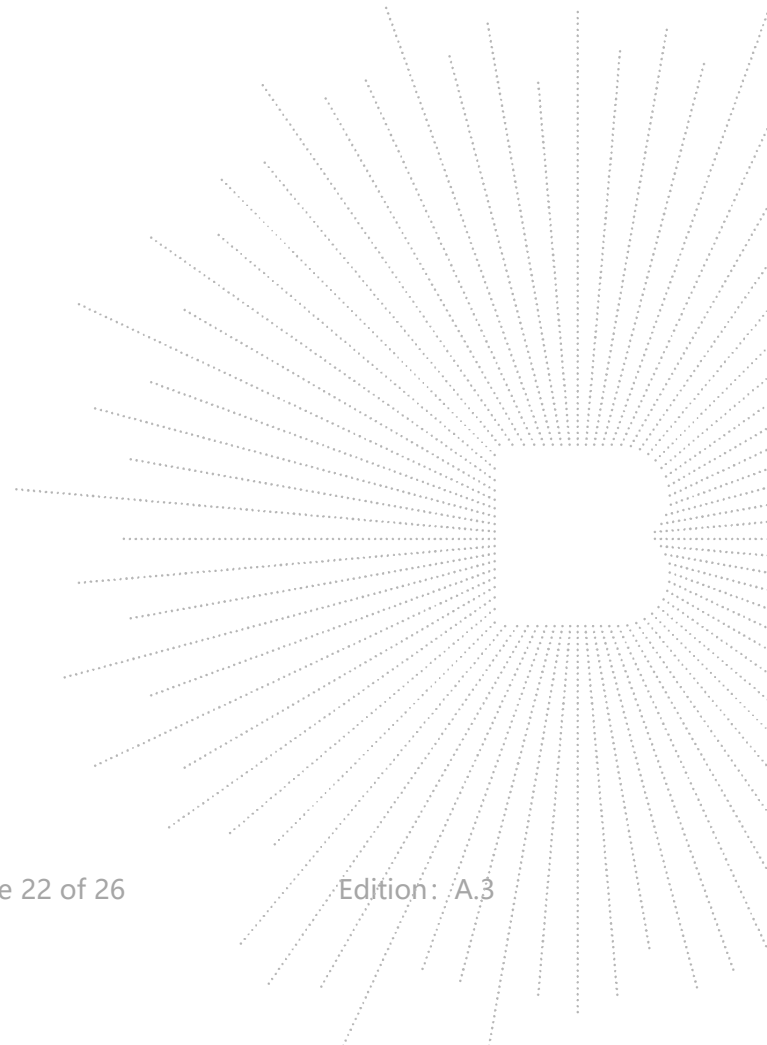

10. EUT PHOTOGRAPHS

EUT Photo 1

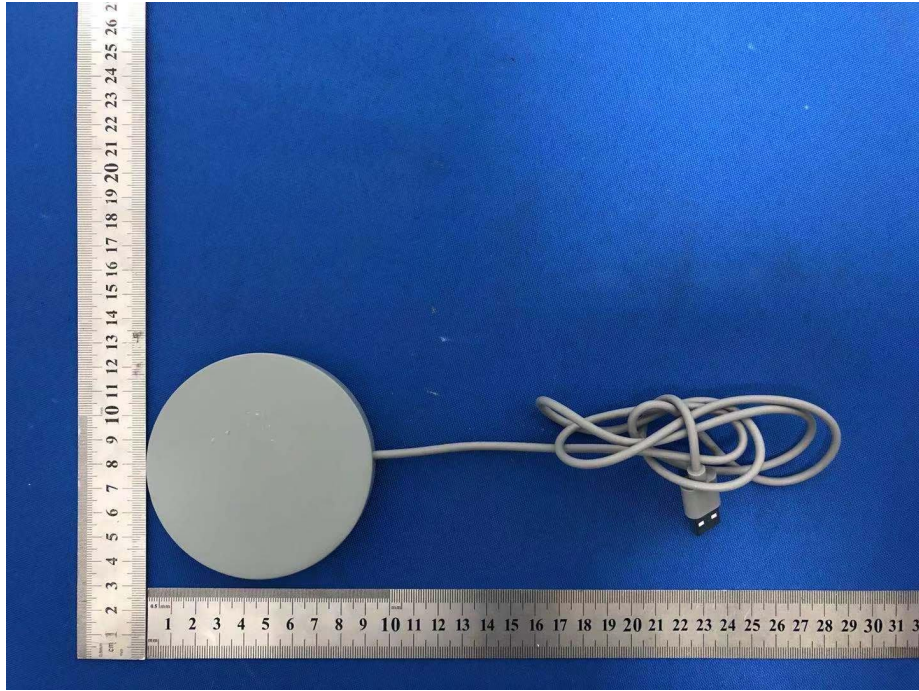

EUT Photo 2

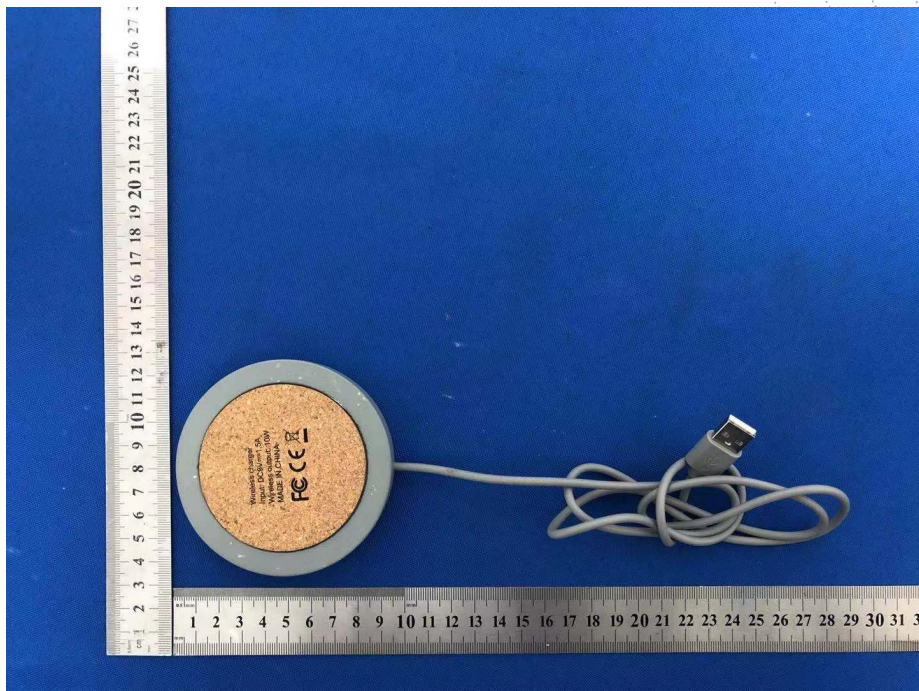

11. EUT TEST SETUP PHOTOGRAPHS

Conducted emissions

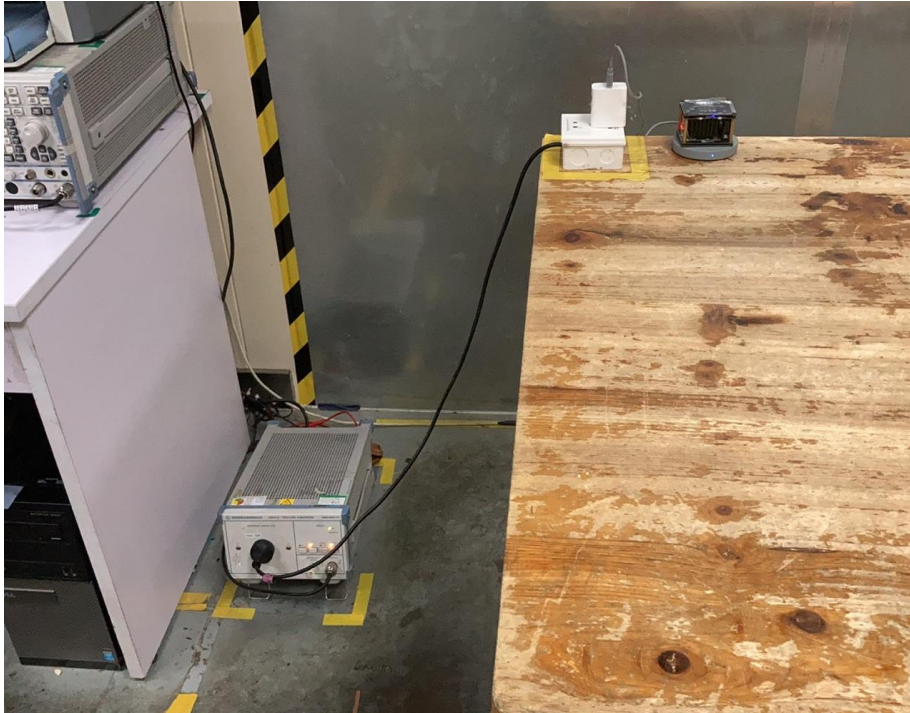

Radiated Measurement Photos



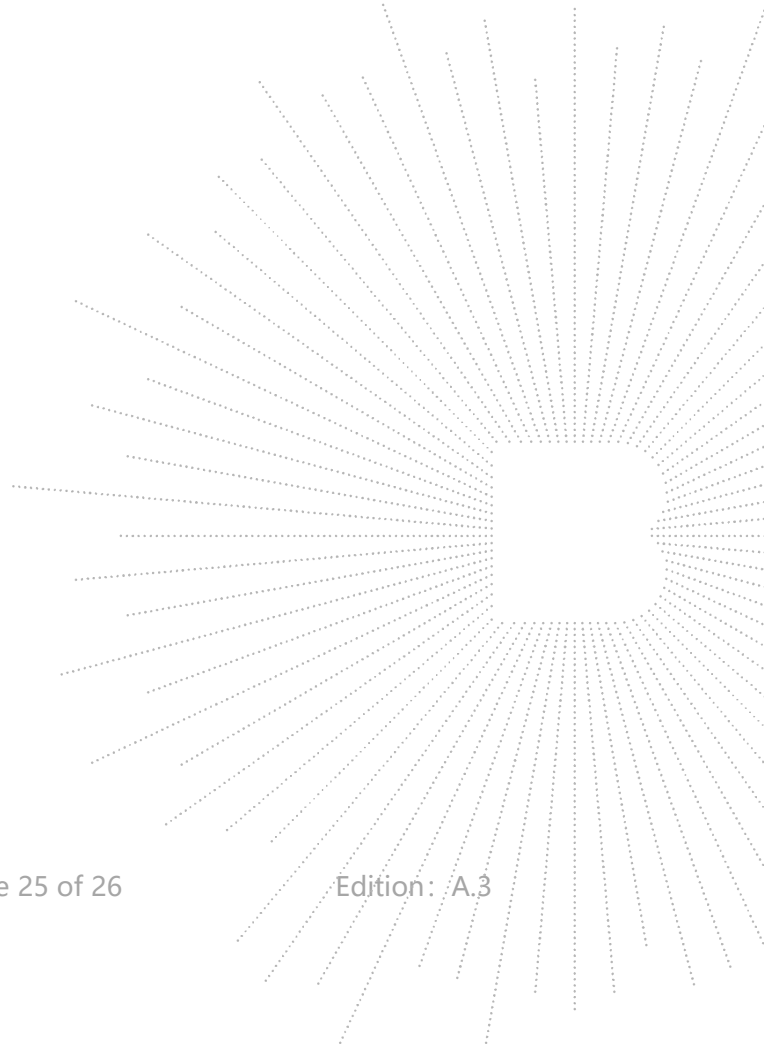
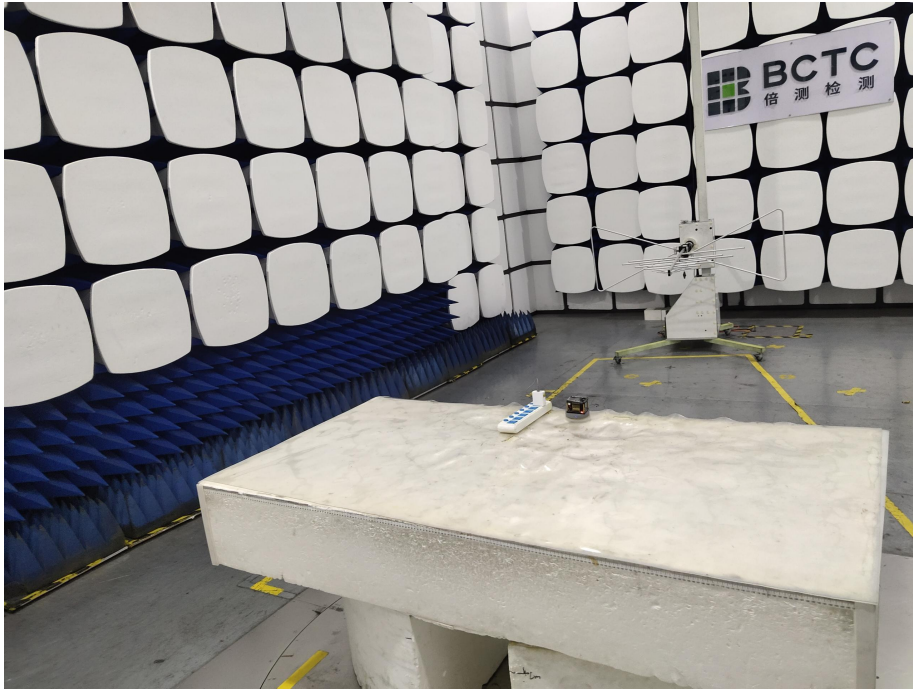

STATEMENT

- 1.The equipment lists are traceable to the national reference standards.
- 2.The test report can not be partially copied unless prior written approval is issued from our lab.
- 3.The test report is invalid without stamp of laboratory.
- 4.The test report is invalid without signature of person(s) testing and authorizing.
- 5.The test process and test result is only related to the Unit Under Test.
- 6.The quality system of our laboratory is in accordance with ISO/IEC17025.
- 7.If there is any objection to report, the client should inform issuing laboratory within 15 days from the date of receiving test report.

Address:

1-2/F., Building B, Pengzhou Industrial Park, No.158, Fuyuan 1st Road, Tangwei, Fuhai Subdistrict, Bao'an District, Shenzhen, Guangdong, China

TEL: 400-788-9558

P.C.: 518103

FAX: 0755-33229357

Website: <http://www.chnbctc.com>

E-Mail: bctc@bctc-lab.com.cn

***** END *****

