

FCC Test Report

Report No.: RF160513C14

FCC ID: 2ADWC-AI6060H

Test Model: AI6060H

Received Date: May 13, 2016

Test Date: Jun. 27, 2016 ~ Jul. 02, 2016

Issued Date: Jul. 11, 2016

Applicant: AcSiP Technology Corporation

Address: 3F.-1, No.207, Fusing Rd., Taoyuan Dist., Taoyuan City 33066, Taiwan
(R.O.C)

Issued By: Bureau Veritas Consumer Products Services (H.K.) Ltd., Taoyuan Branch

Lab Address: No. 47-2, 14th Ling, Chia Pau Vil., Lin Kou Dist., New Taipei City, Taiwan
(R.O.C)

Test Location (1): No. 19, Hwa Ya 2nd Rd, Wen Hwa Tsuen, Kwei Shan Hsiang, Taoyuan
Hsien 333, Taiwan, R.O.C.

Test Location (2): No.215, Sec. 3, Beixin Rd., Xindian Dist., New Taipei City 231, Taiwan,
R.O.C



This report is for your exclusive use. Any copying or replication of this report to or for any other person or entity, or use of our name or trademark, is permitted only with our prior written permission. This report sets forth our findings solely with respect to the test samples identified herein. The results set forth in this report are not indicative or representative of the quality or characteristics of the lot from which a test sample was taken or any similar or identical product unless specifically and expressly noted. Our report includes all of the tests requested by you and the results thereof based upon the information that you provided to us. You have 60 days from date of issuance of this report to notify us of any material error or omission caused by our negligence, provided, however, that such notice shall be in writing and shall specifically address the issue you wish to raise. A failure to raise such issue within the prescribed time shall constitute your unqualified acceptance of the completeness of this report, the tests conducted and the correctness of the report contents. Unless specific mention, the uncertainty of measurement has been explicitly taken into account to declare the compliance or non-compliance to the specification.

Table of Contents

Release Control Record	4
1 Certificate of Conformity	5
2 Summary of Test Results	6
2.1 Measurement Uncertainty	6
2.2 Modification Record	6
3 General Information	7
3.1 General Description of EUT	7
3.2 Description of Test Modes.....	7
3.2.1 Test Mode Applicability and Tested Channel Detail	8
3.3 Duty Cycle of Test Signal	10
3.4 Description of Support Units	11
3.4.1 Configuration of System under Test	11
3.5 General Description of Applied Standards.....	11
4 Test Types and Results	12
4.1 Radiated Emission and Bandedge Measurement	12
4.1.1 Limits of Radiated Emission and Bandedge Measurement	12
4.1.2 Test Instruments	13
4.1.3 Test Procedures.....	14
4.1.4 Deviation from Test Standard	14
4.1.5 Test Set Up	15
4.1.6 EUT Operating Conditions.....	15
4.1.7 Test Results	16
4.2 Conducted Emission Measurement.....	26
4.2.1 Limits of Conducted Emission Measurement	26
4.2.2 Test Instruments	26
4.2.3 Test Procedures.....	27
4.2.4 Deviation from Test Standard	27
4.2.5 Test Setup.....	27
4.2.6 EUT Operating Conditions.....	27
4.2.7 Test Results	28
4.3 6 dB Bandwidth Measurement.....	30
4.3.1 Limits of 6 dB Bandwidth Measurement.....	30
4.3.2 Test Setup.....	30
4.3.3 Test Instruments	30
4.3.4 Test Procedure	30
4.3.5 Deviation from Test Standard	30
4.3.6 EUT Operating Conditions.....	30
4.3.7 Test Result	31
4.4 Conducted Output Power Measurement	33
4.4.1 Limits of Conducted Output Power Measurement.....	33
4.4.2 Test Setup.....	33
4.4.3 Test Instruments	33
4.4.4 Test Procedures.....	33
4.4.5 Deviation from Test Standard	33
4.4.6 EUT Operating Conditions.....	33
4.4.7 Test Results	34
4.5 Power Spectral Density Measurement	35
4.5.1 Limits of Power Spectral Density Measurement.....	35
4.5.2 Test Setup.....	35
4.5.3 Test Instruments	35
4.5.4 Test Procedure	35
4.5.5 Deviation from Test Standard	35
4.5.6 EUT Operating Condition	35

4.5.7 Test Results	36
4.6 Conducted Out of Band Emission Measurement	38
4.6.1 Limits of Conducted Out of Band Emission Measurement.....	38
4.6.2 Test Setup.....	38
4.6.3 Test Instruments	38
4.6.4 Test Procedure	38
4.6.5 Deviation from Test Standard	38
4.6.6 EUT Operating Condition	38
4.6.7 Test Results	39
5 Pictures of Test Arrangements.....	45
Appendix – Information on the Testing Laboratories	46

Release Control Record

Issue No.	Description	Date Issued
RF160513C14	Original Release	Jul. 11, 2016

1 Certificate of Conformity

Product: 802.11b/g/n IoT Module

Brand: AcSiP

Test Model: AI6060H

Sample Status: Identical Prototype

Applicant: AcSiP Technology Corporation

Test Date: Jun. 27, 2016 ~ Jul. 02, 2016

Standards: 47 CFR FCC Part 15, Subpart C (Section 15.247)
ANSI C63.10:2013

The above equipment has been tested by **Bureau Veritas Consumer Products Services (H.K.) Ltd., Taoyuan Branch**, and found compliance with the requirement of the above standards. The test record, data evaluation & Equipment Under Test (EUT) configurations represented herein are true and accurate accounts of the measurements of the sample's EMC characteristics under the conditions specified in this report.

Prepared by : Vera Huang, **Date:** Jul. 11, 2016

Vera Huang / Specialist

Approved by : Stanley Wu, **Date:** Jul. 11, 2016

Stanley Wu / Assistant Manager

2 Summary of Test Results

47 CFR FCC Part 15, Subpart C (Section 15.247)			
FCC Clause	Test Item	Result	Remarks
15.207	AC Power Conducted Emission	Pass	Meet the requirement of limit. Minimum passing margin is -6.66 dB at 0.18516 MHz.
15.205 / 15.209 / 15.247(d)	Radiated Emissions and Band Edge Measurement	Pass	Meet the requirement of limit. Minimum passing margin is -1.02 dB at 2390 MHz.
15.247(d)	Antenna Port Emission	Pass	Meet the requirement of limit.
15.247(a)(2)	6 dB Bandwidth	Pass	Meet the requirement of limit.
15.247(b)	Conducted power	Pass	Meet the requirement of limit.
15.247(e)	Power Spectral Density	Pass	Meet the requirement of limit.
15.203	Antenna Requirement	Pass	No antenna connector is used.

2.1 Measurement Uncertainty

Where relevant, the following measurement uncertainty levels have been estimated for tests performed on the EUT:

The listed uncertainties are the worst case uncertainty for the entire range of measurement. Please note that the uncertainty values are provided for informational purposes only and are not used in determining the PASS/FAIL results.

Measurement	Frequency	Expanded Uncertainty (k=2) (\pm)
Conducted Emissions at mains ports	150 kHz ~ 30 MHz	2.44 dB
Radiated Emissions up to 1 GHz	30 MHz ~ 200 MHz	2.0153 dB
	200 MHz ~ 1000 MHz	2.0224 dB
Radiated Emissions above 1 GHz	1 GHz ~ 18 GHz	1.0121 dB
	18 GHz ~ 40 GHz	1.1508 dB

2.2 Modification Record

There were no modifications required for compliance.

3 General Information

3.1 General Description of EUT

Product	802.11b/g/n IoT Module
Brand	AcSiP
Test Model	AI6060H
Power Supply Rating	3.3 Vdc
Modulation Type	CCK, DQPSK, DBPSK for DSSS 64QAM, 16QAM, QPSK, BPSK for OFDM
Modulation Technology	DSSS, OFDM
Transfer Rate	802.11b: 11.0 / 5.5 / 2.0 / 1.0 Mbps 802.11g: 54.0 / 48.0 / 36.0 / 24.0 / 18.0 / 12.0 / 9.0 / 6.0 Mbps 802.11n: up to MCS7
Operating Frequency	2412 ~ 2462 MHz
Number of Channel	11 for 802.11b, 802.11g, 802.11n (HT20)
Output Power	162.93 mW
Antenna Type	PIFA antenna with -2.5 dBi gain
Antenna Connector	N/A
Accessory Device	N/A
Data Cable Supplied	N/A

Note:

- The EUT provides one completed transmitter and one receiver.

Modulation Mode	TX Function
802.11b	1TX
802.11g	1TX
802.11n (HT20)	1TX

- The above EUT information is declared by manufacturer and for more detailed features description, please refer to the manufacturer's specifications or user's manual.

3.2 Description of Test Modes

11 channels are provided for 802.11b, 802.11g and 802.11n (HT20):

Channel	Frequency (MHz)	Channel	Frequency (MHz)
1	2412	7	2442
2	2417	8	2447
3	2422	9	2452
4	2427	10	2457
5	2432	11	2462
6	2437		

3.2.1 Test Mode Applicability and Tested Channel Detail

EUT Configure Mode	Applicable To				Description
	RE \geq 1G	RE<1G	PLC	APCM	
-	√	√	√	√	-

Where **RE \geq 1G**: Radiated Emission above 1 GHz **RE<1G**: Radiated Emission below 1 GHz
PLC: Power Line Conducted Emission **APCM**: Antenna Port Conducted Measurement

NOTE: The EUT had been pre-tested on the positioned of each 3 axis. The worst case was found when positioned on **X-plane**.
NOTE: “-” means no effect.

Radiated Emission Test (Above 1 GHz):

- Pre-Scan has been conducted to determine the worst-case mode from all possible combinations between available modulations, data rates and antenna ports (if EUT with antenna diversity architecture).
- Following channel(s) was (were) selected for the final test as listed below.

EUT Configure Mode	Mode	Available Channel	Tested Channel	Modulation Technology	Modulation Type	Data Rate (Mbps)
-	802.11b	1 to 11	1, 6, 11	DSSS	DBPSK	1.0
-	802.11g	1 to 11	1, 6, 11	OFDM	BPSK	6.0
-	802.11n (HT20)	1 to 11	1, 6, 11	OFDM	BPSK	MCS0

Radiated Emission Test (Below 1 GHz):

- Pre-Scan has been conducted to determine the worst-case mode from all possible combinations between available modulations, data rates and antenna ports (if EUT with antenna diversity architecture).
- Following channel(s) was (were) selected for the final test as listed below.

EUT Configure Mode	Mode	Available Channel	Tested Channel	Modulation Technology	Modulation Type	Data Rate (Mbps)
-	802.11n (HT20)	1 to 11	1	OFDM	BPSK	MCS0

Power Line Conducted Emission Test:

- Pre-Scan has been conducted to determine the worst-case mode from all possible combinations between available modulations, data rates and antenna ports (if EUT with antenna diversity architecture).
- Following channel(s) was (were) selected for the final test as listed below.

EUT Configure Mode	Mode	Available Channel	Tested Channel	Modulation Technology	Modulation Type	Data Rate (Mbps)
-	802.11n (HT20)	1 to 11	1	OFDM	BPSK	MCS0

Bandedge Measurement:

- Pre-Scan has been conducted to determine the worst-case mode from all possible combinations between available modulations, data rates and antenna ports (if EUT with antenna diversity architecture).
- Following channel(s) was (were) selected for the final test as listed below.

EUT Configure Mode	Mode	Available Channel	Tested Channel	Modulation Technology	Modulation Type	Data Rate (Mbps)
-	802.11b	1 to 11	1, 11	DSSS	DBPSK	1.0
-	802.11g	1 to 11	1, 11	OFDM	BPSK	6.0
-	802.11n (HT20)	1 to 11	1, 11	OFDM	BPSK	MCS0

Antenna Port Conducted Measurement:

- This item includes all test value of each mode, but only includes spectrum plot of worst value of each mode.
- Pre-Scan has been conducted to determine the worst-case mode from all possible combinations between available modulations, data rates and antenna ports (if EUT with antenna diversity architecture).
- Following channel(s) was (were) selected for the final test as listed below.

EUT Configure Mode	Mode	Available Channel	Tested Channel	Modulation Technology	Modulation Type	Data Rate (Mbps)
-	802.11b	1 to 11	1, 6, 11	DSSS	DBPSK	1.0
-	802.11g	1 to 11	1, 6, 11	OFDM	BPSK	6.0
-	802.11n (HT20)	1 to 11	1, 6, 11	OFDM	BPSK	MCS0

Test Condition:

Applicable To	Environmental Conditions	Input Power	Tested by
RE \geq 1G	25 deg. C, 65 % RH	120 Vac, 60 Hz	Karl Lee
RE<1G	25 deg. C, 65 % RH	120 Vac, 60 Hz	Karl Lee
PLC	25 deg. C, 65 % RH	120 Vac, 60 Hz	Toby Tian
APCM	25 deg. C, 65 % RH	3.3 Vdc	Wayne Lin

3.3 Duty Cycle of Test Signal

802.11b: Duty cycle of test signal is 100 %

802.11g: Duty cycle of test signal is 100 %

802.11n (HT20): Duty cycle of test signal is 100 %

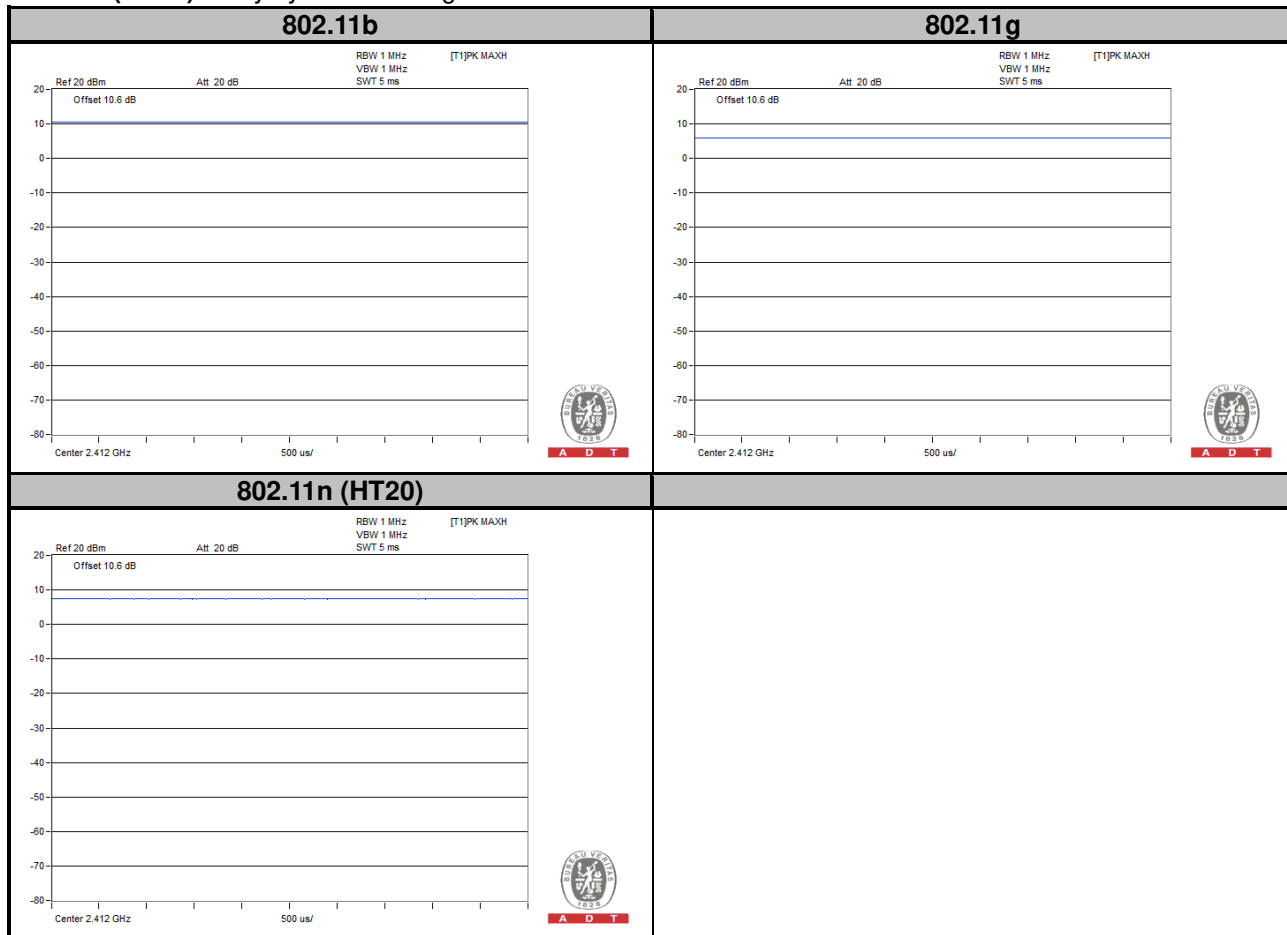

3.4 Description of Support Units

The EUT has been tested as an independent unit together with other necessary accessories or support units. The following support units or accessories were used to form a representative test configuration during the tests.

No.	Product	Brand	Model No.	Serial No.	FCC ID
1.	Notebook	N/A	N/A	N/A	N/A
2.	Jig Board	N/A	N/A	N/A	N/A

No.	Signal Cable Description Of The Above Support Units
1.	1.8m non-shielded cable
2.	N/A

3.4.1 Configuration of System under Test

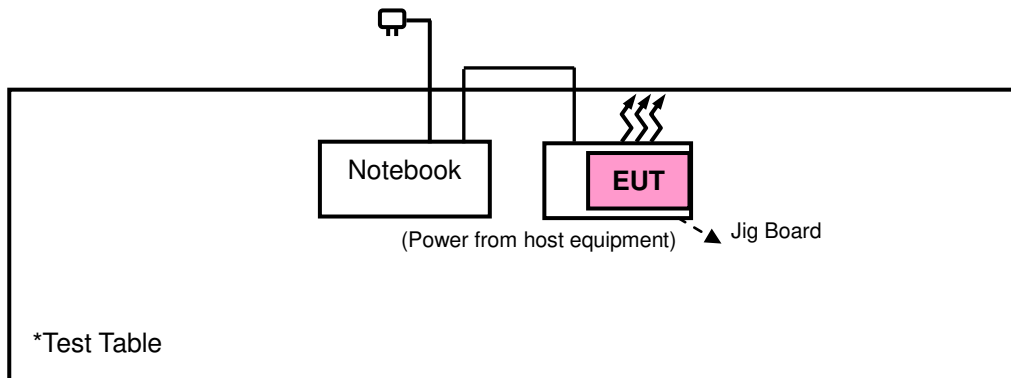

3.5 General Description of Applied Standards

The EUT is a RF Product. According to the specifications of the manufacturer, it must comply with the requirements of the following standards:

FCC Part 15, Subpart C (15.247)

558074 D01 DTS Meas Guidance v03r05

ANSI C63.10-2013

All test items have been performed and recorded as per the above standards.

NOTE: The EUT has been verified to comply with the requirements of FCC Part 15, Subpart B, Class B (DoC). The test report has been issued separately.

4 Test Types and Results

4.1 Radiated Emission and Bandedge Measurement

4.1.1 Limits of Radiated Emission and Bandedge Measurement

Radiated emissions which fall in the restricted bands must comply with the radiated emission limits specified as below table. Other emissions shall be at least 20 dB below the highest level of the desired power:

Frequencies (MHz)	Field Strength (microvolts/meter)	Measurement Distance (meters)
0.009 ~ 0.490	2400/F (kHz)	300
0.490 ~ 1.705	24000/F (kHz)	30
1.705 ~ 30.0	30	30
30 ~ 88	100	3
88 ~ 216	150	3
216 ~ 960	200	3
Above 960	500	3

NOTE:

1. The lower limit shall apply at the transition frequencies.
2. Emission level (dBuV/m) = 20 log Emission level (uV/m).
3. For frequencies above 1000 MHz, the field strength limits are based on average detector, however, the peak field strength of any emission shall not exceed the maximum permitted average limits, specified above by more than 20 dB under any condition of modulation.

4.1.2 Test Instruments

Description & Manufacturer	Model No.	Serial No.	Date of Calibration	Due Date of Calibration
Test Receiver Agilent Technologies	N9038A	MY51210203	Jan. 21, 2016	Jan. 20, 2017
Spectrum Analyzer ROHDE & SCHWARZ	FSU43	101261	Dec. 17, 2015	Dec. 16, 2016
BILOG Antenna SCHWARZBECK	VULB9168	9168-472	Jan. 07, 2016	Jan. 06, 2017
HORN Antenna ETS-Lindgren	3117	00143293	Jan. 04, 2016	Jan. 03, 2017
HORN Antenna SCHWARZBECK	BBHA 9170	9170-480	Jan. 04, 2016	Jan. 03, 2017
Loop Antenna	EM-6879	269	Jul. 31, 2015	Jul. 30, 2016
Agilent Communications Tester-Wireless	8960 Series 10	MY53201073	Jul. 03, 2015	Jul. 02, 2017
Preamplifier Agilent	310N	187246	Aug. 03, 2015	Aug. 02, 2016
Preamplifier Agilent	83017A	MY39501373	Aug. 03, 2015	Aug. 02, 2016
Power Meter Anritsu	ML2495A	1232002	Sep. 21, 2015	Sep. 20, 2016
Power Sensor Anritsu	MA2411B	1207325	Sep. 21, 2015	Sep. 20, 2016
RF signal cable ETS-LINDGREN	5D-FB	Cable-RF1-01 (RFC-SMS-100-S MS-120+MY1337 9/4)	Oct. 08, 2015	Oct. 07, 2016
RF signal cable ETS-LINDGREN	8D-FB	Cable-RF1-02 (RFC-SMS-100-N MS-120+8120_51 40_2911)	Oct. 08, 2015	Oct. 07, 2016
Software BV ADT	E3 8.130425b	NA	NA	NA
Antenna Tower MF	NA	NA	NA	NA
Turn Table MF	NA	NA	NA	NA
Antenna Tower & Turn Table Controller MF	MF-7802	NA	NA	NA

- Note: 1. The calibration interval of the above test instruments is 12 months and the calibrations are traceable to NML/ROC and NIST/USA.
2. The test was performed in HsinTien Chamber 1.
3. The horn antenna and preamplifier (model: 83017A) are used only for the measurement of emission frequency above 1 GHz if tested.
4. The FCC Site Registration No. is 149147.
5. The IC Site Registration No. is IC7450I-1.

4.1.3 Test Procedures

- a. The EUT was placed on the top of a rotating table 0.8 meters (for below 1 GHz) / 1.5 meters (for above 1 GHz) above the ground at 3 meter chamber room for test. The table was rotated 360 degrees to determine the position of the highest radiation.
- b. The EUT was set 3 meters away from the interference-receiving antenna, which was mounted on the top of a variable-height antenna tower.
- c. The height of antenna is varied from one meter to four meters above the ground to determine the maximum value of the field strength. Both horizontal and vertical polarizations of the antenna are set to make the measurement.
- d. For each suspected emission, the EUT was arranged to its worst case and then the antenna was tuned to heights from 1 meter to 4 meters and the rotatable table was turned from 0 degrees to 360 degrees to find the maximum reading.
- e. The test-receiver system was set to quasi-peak detect function and specified bandwidth with maximum hold mode when the test frequency is below 1 GHz.
- f. The test-receiver system was set to peak and average detected function and specified bandwidth with maximum hold mode when the test frequency is above 1 GHz. If the peak reading value also meets average limit, measurement with the average detector is unnecessary.

Note:

1. The resolution bandwidth and video bandwidth of test receiver/spectrum analyzer is 120 kHz for Quasi-peak detection (QP) at frequency below 1 GHz.
2. The resolution bandwidth of test receiver/spectrum analyzer is 1 MHz and the video bandwidth is 3 MHz for Peak detection (PK) at frequency above 1 GHz.
3. The resolution bandwidth of test receiver/spectrum analyzer is 1 MHz and the video bandwidth is 3 MHz for RMS Average (Duty cycle < 98 %) for Average detection (AV) at frequency above 1 GHz, then the measurement results was added to a correction factor ($10 \log(1/\text{duty cycle})$).
4. The resolution bandwidth of test receiver/spectrum analyzer is 1MHz and the video bandwidth is 10 Hz (Duty cycle ≥ 98 %) for Average detection (AV) at frequency above 1 GHz.
5. All modes of operation were investigated and the worst-case emissions are reported.

4.1.4 Deviation from Test Standard

No deviation.

4.1.5 Test Set Up

<Frequency Range below 1 GHz>

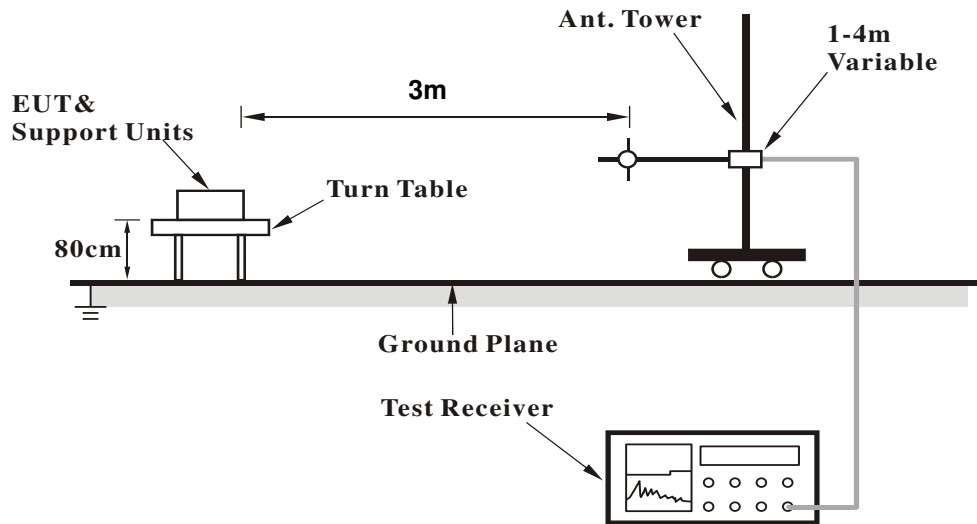

<Frequency Range above 1 GHz>

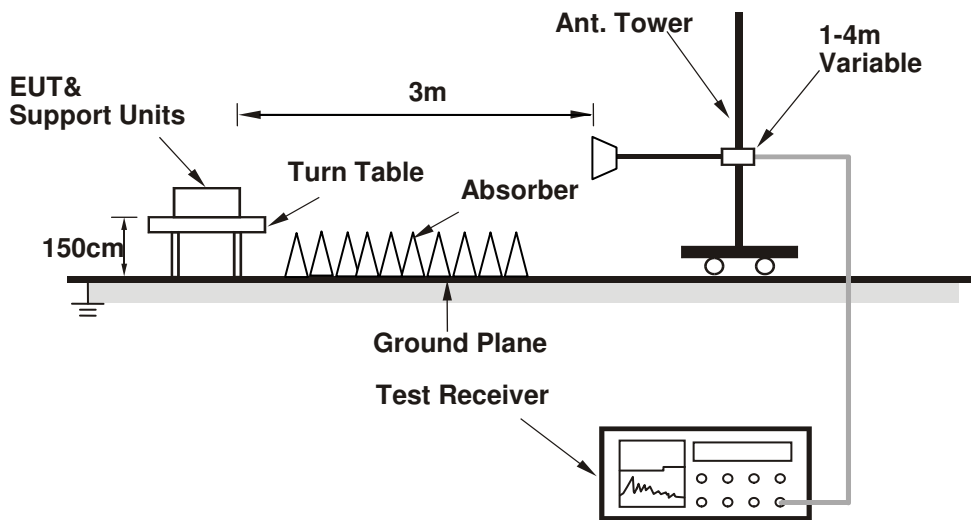

For the actual test configuration, please refer to the attached file (Test Setup Photo).

4.1.6 EUT Operating Conditions

- Placed the EUT on a testing table.
- Use the software to control the EUT under transmission condition continuously at specific channel frequency.

4.1.7 Test Results

Above 1 GHz Data :

802.11b

EUT Test Condition		Measurement Detail	
Channel	Channel 1	Frequency Range	1 GHz ~ 25 GHz
Input Power	120 Vac, 60 Hz	Detector Function	Peak (PK) Average (AV)
Environmental Conditions	25 deg. C, 65 % RH	Tested By	Karl Lee

Antennal Polarity & Test Distance: Horizontal at 3 m										
Frequency (MHz)	Emission Level (dBuV/m)	Read Level (dBuV)	Limit (dBuV/m)	Margin (dB)	Antenna Factor (dB/m)	Cable Loss (dB)	Preamp Factor (dB)	Antenna Height (cm)	Table Angle (Degree)	Remark
2388	51.08	49.37	54	-2.92	31.8	5.4	35.49	100	341	Average
2388	67.96	66.25	74	-6.04	31.8	5.4	35.49	100	341	Peak
2412	104.66	102.89			31.81	5.43	35.47	100	341	Average
2412	107.25	105.48			31.81	5.43	35.47	100	341	Peak
2496	40.08	38.06	54	-13.92	31.9	5.53	35.41	100	341	Average
2496	56.03	54.01	74	-17.97	31.9	5.53	35.41	100	341	Peak
4824	52.41	44.28	54	-1.59	33.97	8.26	34.1	186	333	Average
4824	59.56	51.43	74	-14.44	33.97	8.26	34.1	186	333	Peak

Antennal Polarity & Test Distance: Vertical at 3 m										
Frequency (MHz)	Emission Level (dBuV/m)	Read Level (dBuV)	Limit (dBuV/m)	Margin (dB)	Antenna Factor (dB/m)	Cable Loss (dB)	Preamp Factor (dB)	Antenna Height (cm)	Table Angle (Degree)	Remark
2390	49.7	47.97	54	-4.3	31.8	5.4	35.47	223	356	Average
2390	64.99	63.26	74	-9.01	31.8	5.4	35.47	223	356	Peak
2412	102.4	100.63			31.81	5.43	35.47	223	356	Average
2412	104.76	102.99			31.81	5.43	35.47	223	356	Peak
2494	40.78	38.76	54	-13.22	31.9	5.53	35.41	223	356	Average
2494	57.02	55	74	-16.98	31.9	5.53	35.41	223	356	Peak
4824	49.27	41.14	54	-4.73	33.97	8.26	34.1	226	319	Average
4824	57.44	49.31	74	-16.56	33.97	8.26	34.1	226	319	Peak

Remarks:

- Emission Level = Read Level + Antenna Factor + Cable Loss - Preamp Factor
Margin value = Emission level – Limit value
- 2412 MHz: Fundamental frequency.

EUT Test Condition		Measurement Detail	
Channel	Channel 6	Frequency Range	1 GHz ~ 25 GHz
Input Power	120 Vac, 60 Hz	Detector Function	Peak (PK) Average (AV)
Environmental Conditions	25 deg. C, 65 % RH	Tested By	Karl Lee

Antennal Polarity & Test Distance: Horizontal at 3 m										
Frequency (MHz)	Emission Level (dBuV/m)	Read Level (dBuV)	Limit (dBuV/m)	Margin (dB)	Antenna Factor (dB/m)	Cable Loss (dB)	Preamp Factor (dB)	Antenna Height (cm)	Table Angle (Degree)	Remark
2390	40.14	38.41	54	-13.86	31.8	5.4	35.47	130	341	Average
2390	60.77	59.04	74	-13.23	31.8	5.4	35.47	130	341	Peak
2437	105.19	103.34			31.85	5.46	35.46	130	341	Average
2437	107.83	105.98			31.85	5.46	35.46	130	341	Peak
2484	40.31	38.35	54	-13.69	31.88	5.5	35.42	130	341	Average
2484	59.89	57.93	74	-14.11	31.88	5.5	35.42	130	341	Peak
4874	50.28	42.09	54	-3.72	33.98	8.27	34.06	159	326	Average
4874	57.6	49.41	74	-16.4	33.98	8.27	34.06	159	326	Peak

Antennal Polarity & Test Distance: Vertical at 3 m										
Frequency (MHz)	Emission Level (dBuV/m)	Read Level (dBuV)	Limit (dBuV/m)	Margin (dB)	Antenna Factor (dB/m)	Cable Loss (dB)	Preamp Factor (dB)	Antenna Height (cm)	Table Angle (Degree)	Remark
2378	39.47	37.81	54	-14.53	31.78	5.37	35.49	218	356	Average
2378	55.71	54.05	74	-18.29	31.78	5.37	35.49	218	356	Peak
2437	101.3	99.45			31.85	5.46	35.46	218	356	Average
2437	104	102.15			31.85	5.46	35.46	218	356	Peak
2486	40.01	38.02	54	-13.99	31.88	5.53	35.42	218	356	Average
2486	56.85	54.86	74	-17.15	31.88	5.53	35.42	218	356	Peak
4874	48.29	40.1	54	-5.71	33.98	8.27	34.06	177	312	Average
4874	55.46	47.27	74	-18.54	33.98	8.27	34.06	177	312	Peak

Remarks:

- Emission Level = Read Level + Antenna Factor + Cable Loss - Preamp Factor
Margin value = Emission level – Limit value
- 2437 MHz: Fundamental frequency.

EUT Test Condition		Measurement Detail	
Channel	Channel 11	Frequency Range	1 GHz ~ 25 GHz
Input Power	120 Vac, 60 Hz	Detector Function	Peak (PK) Average (AV)
Environmental Conditions	25 deg. C, 65 % RH	Tested By	Karl Lee

Antennal Polarity & Test Distance: Horizontal at 3 m										
Frequency (MHz)	Emission Level (dBuV/m)	Read Level (dBuV)	Limit (dBuV/m)	Margin (dB)	Antenna Factor (dB/m)	Cable Loss (dB)	Preamp Factor (dB)	Antenna Height (cm)	Table Angle (Degree)	Remark
2326	39.39	37.88	54	-14.61	31.73	5.3	35.52	127	341	Average
2326	56.26	54.75	74	-17.74	31.73	5.3	35.52	127	341	Peak
2462	106.03	104.1			31.87	5.5	35.44	127	341	Average
2462	108.75	106.82			31.87	5.5	35.44	127	341	Peak
2484	47.34	45.38	54	-6.66	31.88	5.5	35.42	127	341	Average
2484	69.76	67.8	74	-4.24	31.88	5.5	35.42	127	341	Peak
4924	49.65	41.4	54	-4.35	33.99	8.28	34.02	167	342	Average
4924	56.97	48.72	74	-17.03	33.99	8.28	34.02	167	342	Peak
Antennal Polarity & Test Distance: Vertical at 3 m										
Frequency (MHz)	Emission Level (dBuV/m)	Read Level (dBuV)	Limit (dBuV/m)	Margin (dB)	Antenna Factor (dB/m)	Cable Loss (dB)	Preamp Factor (dB)	Antenna Height (cm)	Table Angle (Degree)	Remark
2382	39.38	37.69	54	-14.62	31.78	5.4	35.49	239	356	Average
2382	55.27	53.58	74	-18.73	31.78	5.4	35.49	239	356	Peak
2462	102.29	100.36			31.87	5.5	35.44	239	356	Average
2462	104.98	103.05			31.87	5.5	35.44	239	356	Peak
2484	44.02	42.06	54	-9.98	31.88	5.5	35.42	239	356	Average
2484	66.7	64.74	74	-7.3	31.88	5.5	35.42	239	356	Peak
4924	48.56	40.31	54	-5.44	33.99	8.28	34.02	114	329	Average
4924	56.24	47.99	74	-17.76	33.99	8.28	34.02	114	329	Peak

Remarks:

- Emission Level = Read Level + Antenna Factor + Cable Loss - Preamp Factor
Margin value = Emission level – Limit value
- 2462 MHz: Fundamental frequency.

802.11g

EUT Test Condition		Measurement Detail	
Channel	Channel 1	Frequency Range	1 GHz ~ 25 GHz
Input Power	120 Vac, 60 Hz	Detector Function	Peak (PK) Average (AV)
Environmental Conditions	25 deg. C, 65 % RH	Tested By	Karl Lee

Antennal Polarity & Test Distance: Horizontal at 3 m

Frequency (MHz)	Emission Level (dBuV/m)	Read Level (dBuV)	Limit (dBuV/m)	Margin (dB)	Antenna Factor (dB/m)	Cable Loss (dB)	Preamp Factor (dB)	Antenna Height (cm)	Table Angle (Degree)	Remark
2388	52.93	51.22	54	-1.07	31.8	5.4	35.49	101	341	Average
2388	66.17	64.46	74	-7.83	31.8	5.4	35.49	101	341	Peak
2412	97.53	95.76			31.81	5.43	35.47	101	341	Average
2412	106.52	104.75			31.81	5.43	35.47	101	341	Peak
2488	40.96	38.95	54	-13.04	31.9	5.53	35.42	101	341	Average
2488	56.44	54.43	74	-17.56	31.9	5.53	35.42	101	341	Peak
4824	43.28	35.15	54	-10.72	33.97	8.26	34.1	118	354	Average
4824	51.67	43.54	74	-22.33	33.97	8.26	34.1	118	354	Peak

Antennal Polarity & Test Distance: Vertical at 3 m

Frequency (MHz)	Emission Level (dBuV/m)	Read Level (dBuV)	Limit (dBuV/m)	Margin (dB)	Antenna Factor (dB/m)	Cable Loss (dB)	Preamp Factor (dB)	Antenna Height (cm)	Table Angle (Degree)	Remark
2388	50.28	48.57	54	-3.72	31.8	5.4	35.49	223	356	Average
2388	62.76	61.05	74	-11.24	31.8	5.4	35.49	223	356	Peak
2412	95.09	93.32			31.81	5.43	35.47	223	356	Average
2412	103.7	101.93			31.81	5.43	35.47	223	356	Peak
2494	40.86	38.84	54	-13.14	31.9	5.53	35.41	223	356	Average
2494	56.5	54.48	74	-17.5	31.9	5.53	35.41	223	356	Peak
4824	42.18	34.05	54	-11.82	33.97	8.26	34.1	136	324	Average
4824	50.17	42.04	74	-23.83	33.97	8.26	34.1	136	324	Peak

Remarks:

- Emission Level = Read Level + Antenna Factor + Cable Loss - Preamp Factor
Margin value = Emission level – Limit value
- 2412 MHz: Fundamental frequency.

EUT Test Condition		Measurement Detail	
Channel	Channel 6	Frequency Range	1 GHz ~ 25 GHz
Input Power	120 Vac, 60 Hz	Detector Function	Peak (PK) Average (AV)
Environmental Conditions	25 deg. C, 65 % RH	Tested By	Karl Lee

Antennal Polarity & Test Distance: Horizontal at 3 m										
Frequency (MHz)	Emission Level (dBuV/m)	Read Level (dBuV)	Limit (dBuV/m)	Margin (dB)	Antenna Factor (dB/m)	Cable Loss (dB)	Preamp Factor (dB)	Antenna Height (cm)	Table Angle (Degree)	Remark
2390	40.81	39.08	54	-13.19	31.8	5.4	35.47	130	341	Average
2390	56.53	54.8	74	-17.47	31.8	5.4	35.47	130	341	Peak
2437	97.95	96.1			31.85	5.46	35.46	130	341	Average
2437	106.94	105.09			31.85	5.46	35.46	130	341	Peak
2486	41.25	39.26	54	-12.75	31.88	5.53	35.42	130	341	Average
2486	56.37	54.38	74	-17.63	31.88	5.53	35.42	130	341	Peak
4874	42.26	34.07	54	-11.74	33.98	8.27	34.06	139	248	Average
4874	50.57	42.38	74	-23.43	33.98	8.27	34.06	139	248	Peak
Antennal Polarity & Test Distance: Vertical at 3 m										
Frequency (MHz)	Emission Level (dBuV/m)	Read Level (dBuV)	Limit (dBuV/m)	Margin (dB)	Antenna Factor (dB/m)	Cable Loss (dB)	Preamp Factor (dB)	Antenna Height (cm)	Table Angle (Degree)	Remark
2386	40.31	38.6	54	-13.69	31.8	5.4	35.49	218	356	Average
2386	57.28	55.57	74	-16.72	31.8	5.4	35.49	218	356	Peak
2437	94.57	92.72			31.85	5.46	35.46	218	356	Average
2437	103.27	101.42			31.85	5.46	35.46	218	356	Peak
2498	40.92	38.9	54	-13.08	31.9	5.53	35.41	218	356	Average
2498	57.08	55.06	74	-16.92	31.9	5.53	35.41	218	356	Peak
4874	41.55	33.36	54	-12.45	33.98	8.27	34.06	124	306	Average
4874	49.48	41.29	74	-24.52	33.98	8.27	34.06	124	306	Peak

Remarks:

- Emission Level = Read Level + Antenna Factor + Cable Loss - Preamp Factor
Margin value = Emission level – Limit value
- 2437 MHz: Fundamental frequency.

EUT Test Condition		Measurement Detail	
Channel	Channel 11	Frequency Range	1 GHz ~ 25 GHz
Input Power	120 Vac, 60 Hz	Detector Function	Peak (PK) Average (AV)
Environmental Conditions	25 deg. C, 65 % RH	Tested By	Karl Lee

Antennal Polarity & Test Distance: Horizontal at 3 m										
Frequency (MHz)	Emission Level (dBuV/m)	Read Level (dBuV)	Limit (dBuV/m)	Margin (dB)	Antenna Factor (dB/m)	Cable Loss (dB)	Preamp Factor (dB)	Antenna Height (cm)	Table Angle (Degree)	Remark
2376	40.18	38.52	54	-13.82	31.78	5.37	35.49	127	341	Average
2376	55.73	54.07	74	-18.27	31.78	5.37	35.49	127	341	Peak
2462	98.82	96.89			31.87	5.5	35.44	127	341	Average
2462	107.7	105.77			31.87	5.5	35.44	127	341	Peak
2484	50.53	48.57	54	-3.47	31.88	5.5	35.42	127	341	Average
2484	66.37	64.41	74	-7.63	31.88	5.5	35.42	127	341	Peak
4924	41.11	32.86	54	-12.89	33.99	8.28	34.02	116	343	Average
4924	49.62	41.37	74	-24.38	33.99	8.28	34.02	116	343	Peak
Antennal Polarity & Test Distance: Vertical at 3 m										
Frequency (MHz)	Emission Level (dBuV/m)	Read Level (dBuV)	Limit (dBuV/m)	Margin (dB)	Antenna Factor (dB/m)	Cable Loss (dB)	Preamp Factor (dB)	Antenna Height (cm)	Table Angle (Degree)	Remark
2378	40.18	38.52	54	-13.82	31.78	5.37	35.49	239	356	Average
2378	56.61	54.95	74	-17.39	31.78	5.37	35.49	239	356	Peak
2462	94.36	92.43			31.87	5.5	35.44	239	356	Average
2462	103.91	101.98			31.87	5.5	35.44	239	356	Peak
2484	47.06	45.1	54	-6.94	31.88	5.5	35.42	239	356	Average
2484	63.04	61.08	74	-10.96	31.88	5.5	35.42	239	356	Peak
4924	40.38	32.13	54	-13.62	33.99	8.28	34.02	127	286	Average
4924	48.82	40.57	74	-25.18	33.99	8.28	34.02	127	286	Peak

Remarks:

- Emission Level = Read Level + Antenna Factor + Cable Loss - Preamp Factor
Margin value = Emission level – Limit value
- 2462 MHz: Fundamental frequency.

802.11n (HT20)

EUT Test Condition		Measurement Detail	
Channel	Channel 1	Frequency Range	1 GHz ~ 25 GHz
Input Power	120 Vac, 60 Hz	Detector Function	Peak (PK) Average (AV)
Environmental Conditions	25 deg. C, 65 % RH	Tested By	Karl Lee

Antennal Polarity & Test Distance: Horizontal at 3 m

Frequency (MHz)	Emission Level (dBuV/m)	Read Level (dBuV)	Limit (dBuV/m)	Margin (dB)	Antenna Factor (dB/m)	Cable Loss (dB)	Preamp Factor (dB)	Antenna Height (cm)	Table Angle (Degree)	Remark
2390	52.98	51.25	54	-1.02	31.8	5.4	35.47	101	341	Average
2390	69.25	67.52	74	-4.75	31.8	5.4	35.47	101	341	Peak
2412	97.15	95.38			31.81	5.43	35.47	101	341	Average
2412	105.58	103.81			31.81	5.43	35.47	101	341	Peak
2498	40.9	38.88	54	-13.1	31.9	5.53	35.41	101	341	Average
2498	56.41	54.39	74	-17.59	31.9	5.53	35.41	101	341	Peak
4824	43.25	35.12	54	-10.75	33.97	8.26	34.1	154	265	Average
4824	50.97	42.84	74	-23.03	33.97	8.26	34.1	154	265	Peak

Antennal Polarity & Test Distance: Vertical at 3 m

Frequency (MHz)	Emission Level (dBuV/m)	Read Level (dBuV)	Limit (dBuV/m)	Margin (dB)	Antenna Factor (dB/m)	Cable Loss (dB)	Preamp Factor (dB)	Antenna Height (cm)	Table Angle (Degree)	Remark
2390	50.89	49.16	54	-3.11	31.8	5.4	35.47	223	356	Average
2390	66.23	64.5	74	-7.77	31.8	5.4	35.47	223	356	Peak
2412	94.75	92.98			31.81	5.43	35.47	223	356	Average
2412	103.28	101.51			31.81	5.43	35.47	223	356	Peak
2500	40.88	38.86	54	-13.12	31.9	5.53	35.41	223	356	Average
2500	56.53	54.51	74	-17.47	31.9	5.53	35.41	223	356	Peak
4824	44.99	36.86	54	-9.01	33.97	8.26	34.1	156	297	Average
4824	49.26	41.13	74	-24.74	33.97	8.26	34.1	156	297	Peak

Remarks:

- Emission Level = Read Level + Antenna Factor + Cable Loss - Preamp Factor
Margin value = Emission level – Limit value
- 2412 MHz: Fundamental frequency.

EUT Test Condition		Measurement Detail	
Channel	Channel 6	Frequency Range	1 GHz ~ 25 GHz
Input Power	120 Vac, 60 Hz	Detector Function	Peak (PK) Average (AV)
Environmental Conditions	25 deg. C, 65 % RH	Tested By	Karl Lee

Antennal Polarity & Test Distance: Horizontal at 3 m										
Frequency (MHz)	Emission Level (dBuV/m)	Read Level (dBuV)	Limit (dBuV/m)	Margin (dB)	Antenna Factor (dB/m)	Cable Loss (dB)	Preamp Factor (dB)	Antenna Height (cm)	Table Angle (Degree)	Remark
2390	40.8	39.07	54	-13.2	31.8	5.4	35.47	130	341	Average
2390	56.49	54.76	74	-17.51	31.8	5.4	35.47	130	341	Peak
2437	97.66	95.81			31.85	5.46	35.46	130	341	Average
2437	106.14	104.29			31.85	5.46	35.46	130	341	Peak
2498	41.24	39.22	54	-12.76	31.9	5.53	35.41	130	341	Average
2498	56.38	54.36	74	-17.62	31.9	5.53	35.41	130	341	Peak
4874	43.69	35.5	54	-10.31	33.98	8.27	34.06	154	224	Average
4874	51.67	43.48	74	-22.33	33.98	8.27	34.06	154	224	Peak
Antennal Polarity & Test Distance: Vertical at 3 m										
Frequency (MHz)	Emission Level (dBuV/m)	Read Level (dBuV)	Limit (dBuV/m)	Margin (dB)	Antenna Factor (dB/m)	Cable Loss (dB)	Preamp Factor (dB)	Antenna Height (cm)	Table Angle (Degree)	Remark
2330	40.15	38.61	54	-13.85	31.73	5.33	35.52	218	356	Average
2330	56.54	55	74	-17.46	31.73	5.33	35.52	218	356	Peak
2437	94.27	92.42			31.85	5.46	35.46	218	356	Average
2437	102.76	100.91			31.85	5.46	35.46	218	356	Peak
2498	40.97	38.95	54	-13.03	31.9	5.53	35.41	218	356	Average
2498	57.04	55.02	74	-16.96	31.9	5.53	35.41	218	356	Peak
4874	41.39	33.2	54	-12.61	33.98	8.27	34.06	158	311	Average
4874	50.05	41.86	74	-23.95	33.98	8.27	34.06	158	311	Peak

Remarks:

- Emission Level = Read Level + Antenna Factor + Cable Loss - Preamp Factor
Margin value = Emission level – Limit value
- 2437 MHz: Fundamental frequency.

EUT Test Condition		Measurement Detail	
Channel	Channel 11	Frequency Range	1 GHz ~ 25 GHz
Input Power	120 Vac, 60 Hz	Detector Function	Peak (PK) Average (AV)
Environmental Conditions	25 deg. C, 65 % RH	Tested By	Karl Lee

Antennal Polarity & Test Distance: Horizontal at 3 m										
Frequency (MHz)	Emission Level (dBuV/m)	Read Level (dBuV)	Limit (dBuV/m)	Margin (dB)	Antenna Factor (dB/m)	Cable Loss (dB)	Preamp Factor (dB)	Antenna Height (cm)	Table Angle (Degree)	Remark
2350	40.12	38.55	54	-13.88	31.74	5.33	35.5	127	341	Average
2350	56.41	54.84	74	-17.59	31.74	5.33	35.5	127	341	Peak
2462	98.5	96.57			31.87	5.5	35.44	127	341	Average
2462	106.85	104.92			31.87	5.5	35.44	127	341	Peak
2484	52.93	50.97	54	-1.07	31.88	5.5	35.42	127	341	Average
2484	69.06	67.1	74	-4.94	31.88	5.5	35.42	127	341	Peak
4924	42.69	34.44	54	-11.31	33.99	8.28	34.02	136	254	Average
4924	49.94	41.69	74	-24.06	33.99	8.28	34.02	136	254	Peak
Antennal Polarity & Test Distance: Vertical at 3 m										
Frequency (MHz)	Emission Level (dBuV/m)	Read Level (dBuV)	Limit (dBuV/m)	Margin (dB)	Antenna Factor (dB/m)	Cable Loss (dB)	Preamp Factor (dB)	Antenna Height (cm)	Table Angle (Degree)	Remark
2370	40.14	38.48	54	-13.86	31.78	5.37	35.49	239	356	Average
2370	56.13	54.47	74	-17.87	31.78	5.37	35.49	239	356	Peak
2462	95.14	93.21			31.87	5.5	35.44	239	356	Average
2462	103.17	101.24			31.87	5.5	35.44	239	356	Peak
2484	49.34	47.38	54	-4.66	31.88	5.5	35.42	239	356	Average
2484	65.73	63.77	74	-8.27	31.88	5.5	35.42	239	356	Peak
4924	41.23	32.98	54	-12.77	33.99	8.28	34.02	174	122	Average
4924	48.28	40.03	74	-25.72	33.99	8.28	34.02	174	122	Peak

Remarks:

- Emission Level = Read Level + Antenna Factor + Cable Loss - Preamp Factor
Margin value = Emission level – Limit value
- 2462 MHz: Fundamental frequency.

9 kHz ~ 30 MHz DATA:

The amplitude of spurious emissions attenuated more than 20 dB below the permissible value is not required to be report.

30 MHz ~ 1 GHz WORST-CASE DATA:

802.11n (HT20)

EUT Test Condition		Measurement Detail	
Channel	Channel 1	Frequency Range	30 MHz ~ 1 GHz
Input Power	120 Vac, 60 Hz	Detector Function	Peak (PK) Quasi-peak (QP)
Environmental Conditions	25 deg. C, 65 % RH	Tested By	Karl Lee

Antennal Polarity & Test Distance: Horizontal at 3 m										
Frequency (MHz)	Emission Level (dBuV/m)	Read Level (dBuV)	Limit (dBuV/m)	Margin (dB)	Antenna Factor (dB/m)	Cable Loss (dB)	Preamp Factor (dB)	Antenna Height (cm)	Table Angle (Degree)	Remark
83.73	32.86	55.22	40	-7.14	8.59	1.11	32.06	133	338	Peak
190.11	31.2	51.44	43.5	-12.3	10.4	1.61	32.25	104	144	Peak
210.09	33.21	52.51	43.5	-10.29	11.31	1.65	32.26	180	88	Peak
370	28.18	41.73	46	-17.82	16.32	2.26	32.13	137	229	Peak
617.8	22.99	30.43	46	-23.01	21.81	2.93	32.18	177	193	Peak
800.5	25.49	29.63	46	-20.51	24.6	3.32	32.06	180	5	Peak

Antennal Polarity & Test Distance: Vertical at 3 m										
Frequency (MHz)	Emission Level (dBuV/m)	Read Level (dBuV)	Limit (dBuV/m)	Margin (dB)	Antenna Factor (dB/m)	Cable Loss (dB)	Preamp Factor (dB)	Antenna Height (cm)	Table Angle (Degree)	Remark
84	26.67	48.96	40	-13.33	8.61	1.11	32.01	126	157	Peak
171.48	23.65	44.3	43.5	-19.85	10.07	1.52	32.24	171	248	Peak
210.09	25.46	44.76	43.5	-18.04	11.31	1.65	32.26	190	9	Peak
336.4	30	44.1	46	-16	15.8	2.19	32.09	160	336	Peak
479.9	21.65	32.29	46	-24.35	18.92	2.56	32.12	147	99	Peak
605.2	21.75	29.83	46	-24.25	21.24	2.87	32.19	188	169	Peak

Remarks:

- Emission Level = Read Level + Antenna Factor + Cable Loss - Preamp Factor
Margin value = Emission level – Limit value

4.2 Conducted Emission Measurement

4.2.1 Limits of Conducted Emission Measurement

Frequency (MHz)	Conducted Limit (dBuV)	
	Quasi-peak	Average
0.15 - 0.5	66 - 56	56 - 46
0.50 - 5.0	56	46
5.0 - 30.0	60	50

Note: 1. The lower limit shall apply at the transition frequencies.

2. The limit decreases in line with the logarithm of the frequency in the range of 0.15 to 0.50 MHz.

4.2.2 Test Instruments

Description & Manufacturer	Model No.	Serial No.	Date of Calibration	Due Date of Calibration
Test Receiver ROHDE & SCHWARZ	ESCS30	100289	Dec. 23, 2015	Dec. 22, 2016
RF signal cable (with 10dB PAD) Woken	5D-FB	Cable-cond2-01	Dec. 26, 2015	Dec. 25, 2016
LISN ROHDE & SCHWARZ (EUT)	ESH2-Z5	100100	Jan. 11, 2016	Jan. 10, 2017
LISN ROHDE & SCHWARZ (Peripheral)	ESH3-Z5	100312	Jul. 21, 2015	Jul. 20, 2016
Software ADT	BV ADT_Cond_ V7.3.7.3	NA	NA	NA

Note: 1. The calibration interval of the above test instruments is 12 months and the calibrations are traceable to NML/ROC and NIST/USA.

2. The test was performed in HwaYa Shielded Room 2.

3. The VCCI Site Registration No. is C-2047.

4.2.3 Test Procedures

- a. The EUT was placed 0.4 meters from the conducting wall of the shielded room with EUT being connected to the power mains through a line impedance stabilization network (LISN). Other support units were connected to the power mains through another LISN. The two LISNs provide 50 ohm/50 uH of coupling impedance for the measuring instrument.
- b. Both lines of the power mains connected to the EUT were checked for maximum conducted interference.
- c. The frequency range from 150 kHz to 30 MHz was searched. Emission levels under (Limit – 20 dB) was not recorded.

NOTE: All modes of operation were investigated and the worst-case emissions are reported.

4.2.4 Deviation from Test Standard

No deviation.

4.2.5 Test Setup

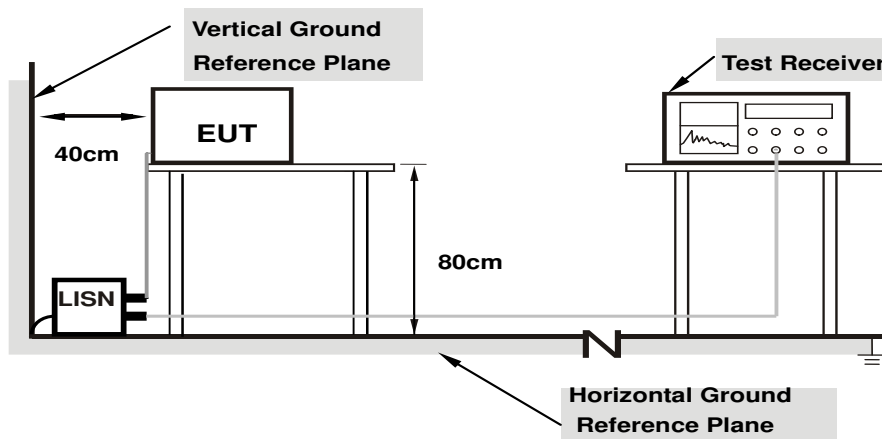

Note: 1. Support units were connected to second LISN.

For the actual test configuration, please refer to the attached file (Test Setup Photo).

4.2.6 EUT Operating Conditions

- a. Placed the EUT on a testing table.
- b. Use the software to control the EUT under transmission condition continuously at specific channel frequency.

4.2.7 Test Results

Frequency Range	150kHz ~ 30MHz	Detector Function & Resolution Bandwidth	Quasi-Peak (QP) / Average (AV), 9kHz
Input Power	120Vac, 60Hz	Environmental Conditions	25°C, 65%RH
Tested by	Toby Tian	Test Date	2016/7/2

Phase Of Power : Line (L)										
No	Frequency (MHz)	Correction Factor (dB)	Reading Value (dBuV)		Emission Level (dBuV)		Limit (dBuV)		Margin (dB)	
			Q.P.	AV.	Q.P.	AV.	Q.P.	AV.	Q.P.	AV.
1	0.15391	10.12	43.81	24.07	53.93	34.19	65.79	55.79	-11.86	-21.60
2	0.18516	10.15	47.44	26.76	57.59	36.91	64.25	54.25	-6.66	-17.34
3	0.27500	10.17	34.87	17.41	45.04	27.58	60.97	50.97	-15.93	-23.39
4	0.34141	10.18	29.15	12.78	39.33	22.96	59.17	49.17	-19.84	-26.21
5	0.43906	10.19	23.97	7.51	34.16	17.70	57.08	47.08	-22.92	-29.38
6	1.94922	10.28	21.77	11.60	32.05	21.88	56.00	46.00	-23.95	-24.12

Remarks:

1. Q.P. and AV. are abbreviations of quasi-peak and average individually.
2. The emission levels of other frequencies were very low against the limit.
3. Margin value = Emission level – Limit value
4. Correction factor = Insertion loss + Cable loss
5. Emission Level = Correction Factor + Reading Value

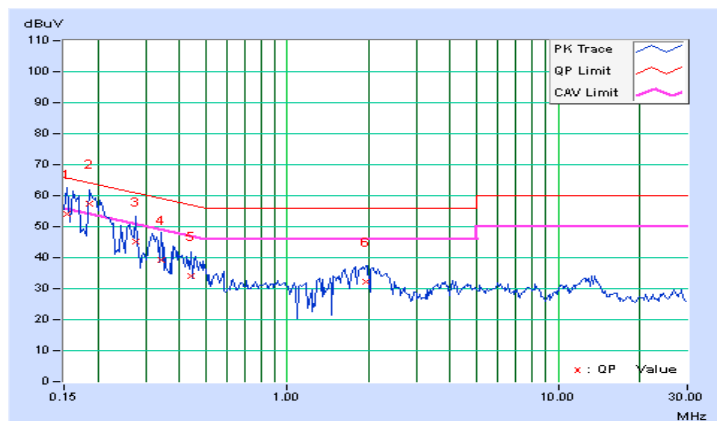

Frequency Range	150kHz ~ 30MHz	Detector Function & Resolution Bandwidth	Quasi-Peak (QP) / Average (AV), 9kHz
Input Power	120Vac, 60Hz	Environmental Conditions	25°C, 65%RH
Tested by	Toby Tian	Test Date	2016/7/2

Phase Of Power : Neutral (N)										
No	Frequency (MHz)	Correction Factor (dB)	Reading Value (dBuV)		Emission Level (dBuV)		Limit (dBuV)		Margin (dB)	
			Q.P.	AV.	Q.P.	AV.	Q.P.	AV.	Q.P.	AV.
1	0.18906	10.15	43.59	26.17	53.74	36.32	64.08	54.08	-10.34	-17.76
2	0.24766	10.17	34.24	17.71	44.41	27.88	61.84	51.84	-17.43	-23.96
3	0.29844	10.17	23.70	7.97	33.87	18.14	60.29	50.29	-26.42	-32.15
4	0.37656	10.19	24.96	9.72	35.15	19.91	58.35	48.35	-23.20	-28.44
5	0.44688	10.19	18.33	2.69	28.52	12.88	56.93	46.93	-28.41	-34.05
6	1.62891	10.27	19.91	10.46	30.18	20.73	56.00	46.00	-25.82	-25.27

Remarks:

1. Q.P. and AV. are abbreviations of quasi-peak and average individually.
2. The emission levels of other frequencies were very low against the limit.
3. Margin value = Emission level – Limit value
4. Correction factor = Insertion loss + Cable loss
5. Emission Level = Correction Factor + Reading Value

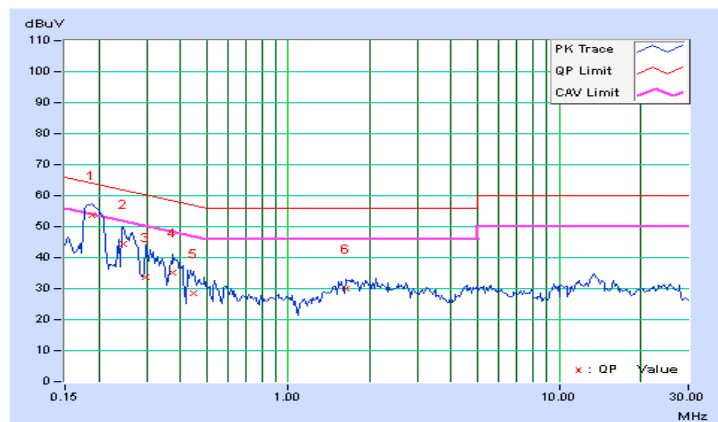

4.3 6 dB Bandwidth Measurement

4.3.1 Limits of 6 dB Bandwidth Measurement

The minimum of 6 dB Bandwidth Measurement is 0.5 MHz.

4.3.2 Test Setup

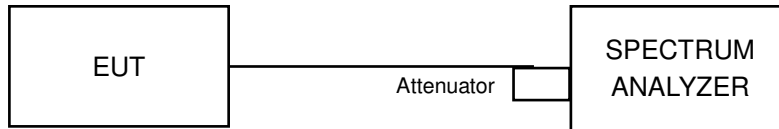

4.3.3 Test Instruments

Refer to section 4.1.2 to get information of above instrument.

4.3.4 Test Procedure

- Set resolution bandwidth (RBW) = 100 kHz
- Set the video bandwidth (VBW) $\geq 3 \times$ RBW, Detector = Peak.
- Trace mode = max hold.
- Sweep = auto couple.
- Measure the maximum width of the emission that is constrained by the frequencies associated with the two amplitude points (upper and lower) that are attenuated by 6 dB relative to the maximum level measured in the fundamental emission

4.3.5 Deviation from Test Standard

No deviation.

4.3.6 EUT Operating Conditions

The software provided by client to enable the EUT under transmission condition continuously at lowest, middle and highest channel frequencies individually.

4.3.7 Test Result

802.11b

Channel	Frequency (MHz)	6 dB Bandwidth (MHz)	Minimum Limit (MHz)	Pass / Fail
1	2412	9.58	0.5	Pass
6	2437	10.03	0.5	Pass
11	2462	10.03	0.5	Pass

802.11g

Channel	Frequency (MHz)	6 dB Bandwidth (MHz)	Minimum Limit (MHz)	Pass / Fail
1	2412	16.36	0.5	Pass
6	2437	16.38	0.5	Pass
11	2462	16.38	0.5	Pass

802.11n (HT20)

Channel	Frequency (MHz)	6 dB Bandwidth (MHz)	Minimum Limit (MHz)	Pass / Fail
1	2412	17.61	0.5	Pass
6	2437	17.62	0.5	Pass
11	2462	17.63	0.5	Pass

Spectrum Plot of Worst Value

802.11b

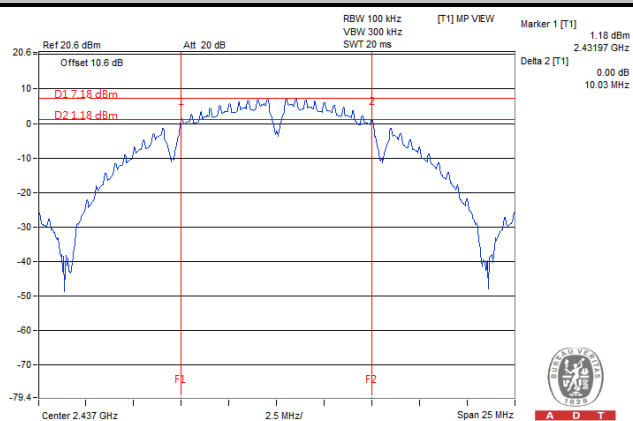

802.11g

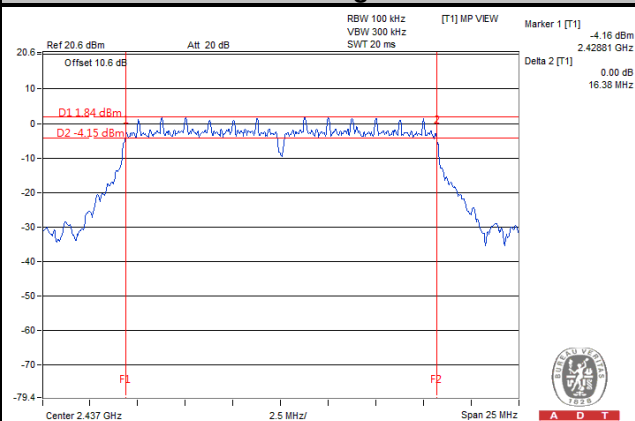

802.11n (HT20)

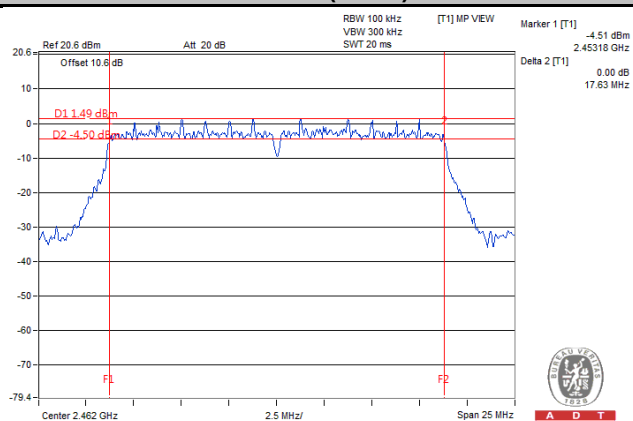

4.4 Conducted Output Power Measurement

4.4.1 Limits of Conducted Output Power Measurement

For systems using digital modulation in the 2400–2483.5 MHz bands: 1 Watt (30 dBm)

4.4.2 Test Setup

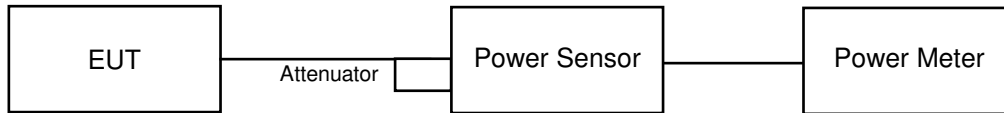

4.4.3 Test Instruments

Refer to section 4.1.2 to get information of above instrument.

4.4.4 Test Procedures

A peak power sensor was used on the output port of the EUT. A power meter was used to read the response of the peak power sensor. Record the power level.

4.4.5 Deviation from Test Standard

No deviation.

4.4.6 EUT Operating Conditions

The software provided by client to enable the EUT under transmission condition continuously at lowest, middle and highest channel frequencies individually.

4.4.7 Test Results

802.11b

Channel	Frequency (MHz)	Peak Power (mW)	Peak Power (dBm)	Limit (dBm)	Pass / Fail
1	2412	90.78	19.58	30	Pass
6	2437	87.70	19.43	30	Pass
11	2462	83.37	19.21	30	Pass

802.11g

Channel	Frequency (MHz)	Peak Power (mW)	Peak Power (dBm)	Limit (dBm)	Pass / Fail
1	2412	162.93	22.12	30	Pass
6	2437	156.31	21.94	30	Pass
11	2462	149.97	21.76	30	Pass

802.11n (HT20)

Channel	Frequency (MHz)	Peak Power (mW)	Peak Power (dBm)	Limit (dBm)	Pass / Fail
1	2412	162.55	22.11	30	Pass
6	2437	159.22	22.02	30	Pass
11	2462	149.97	21.76	30	Pass

4.5 Power Spectral Density Measurement

4.5.1 Limits of Power Spectral Density Measurement

The Maximum of Power Spectral Density Measurement is 8 dBm.

4.5.2 Test Setup

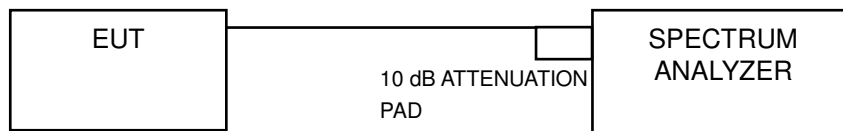

4.5.3 Test Instruments

Refer to section 4.1.2 to get information of above instrument.

4.5.4 Test Procedure

- Set analyzer center frequency to DTS channel center frequency.
- Set the span to 1.5 times the DTS bandwidth.
- Set the RBW to: $3 \text{ kHz} \leq \text{RBW} \leq 100 \text{ kHz}$.
- Set the VBW $\geq 3 \times \text{RBW}$.
- Detector = peak.
- Sweep time = auto couple.
- Trace mode = max hold.
- Allow trace to fully stabilize.
- Use the peak marker function to determine the maximum amplitude level within the RBW.

4.5.5 Deviation from Test Standard

No deviation.

4.5.6 EUT Operating Condition

The software provided by client to enable the EUT under transmission condition continuously at lowest, middle and highest channel frequencies individually.

4.5.7 Test Results

802.11b

Channel	Frequency (MHz)	PSD (dBm)	Limit (dBm)	Pass / Fail
1	2412	-8.79	8	Pass
6	2437	-9.01	8	Pass
11	2462	-9.16	8	Pass

802.11g

Channel	Frequency (MHz)	PSD (dBm)	Limit (dBm)	Pass / Fail
1	2412	-14.11	8	Pass
6	2437	-14.58	8	Pass
11	2462	-14.56	8	Pass

802.11n (HT20)

Channel	Frequency (MHz)	PSD (dBm)	Limit (dBm)	Pass / Fail
1	2412	-14.00	8	Pass
6	2437	-14.22	8	Pass
11	2462	-14.96	8	Pass

Spectrum Plot of Worst Value

802.11b

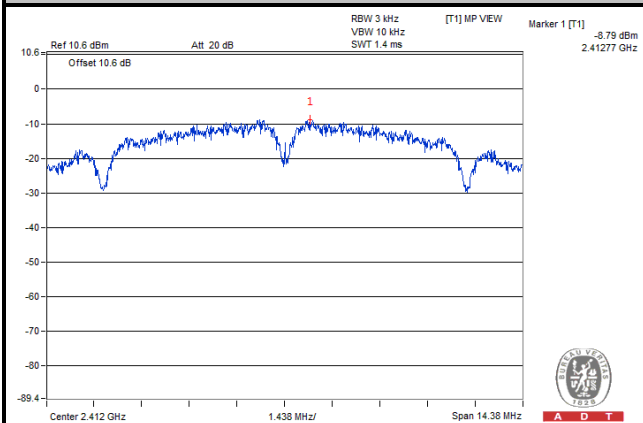

802.11g

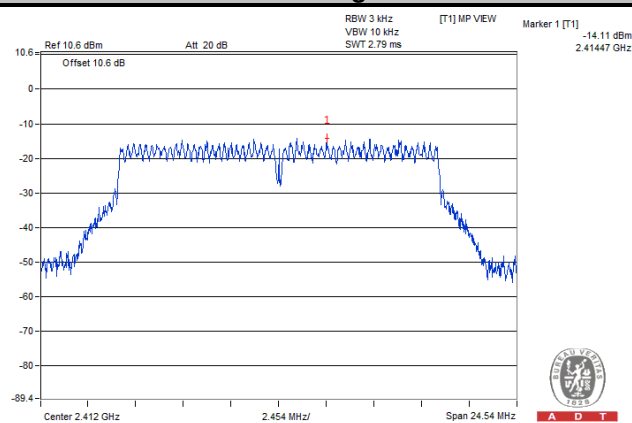

802.11n (HT20)

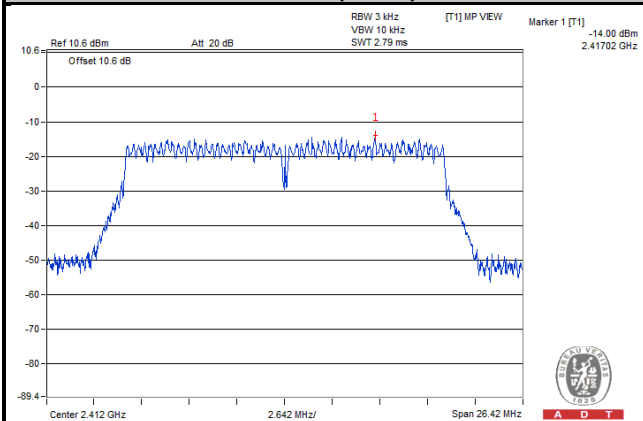

4.6 Conducted Out of Band Emission Measurement

4.6.1 Limits of Conducted Out of Band Emission Measurement

Below 20 dB of the highest emission level of operating band (in 100 kHz Resolution Bandwidth).

4.6.2 Test Setup

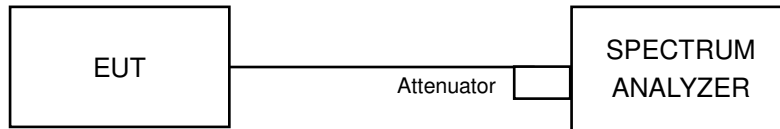

4.6.3 Test Instruments

Refer to section 4.1.2 to get information of above instrument.

4.6.4 Test Procedure

MEASUREMENT PROCEDURE REF

1. Set the RBW = 100 kHz.
2. Set the VBW \geq 300 kHz.
3. Detector = peak.
4. Sweep time = auto couple.
5. Trace mode = max hold.
6. Allow trace to fully stabilize.
7. Use the peak marker function to determine the maximum power level in any 100 kHz band segment within the fundamental EBW.

MEASUREMENT PROCEDURE OOB

1. Set RBW = 100 kHz.
2. Set VBW \geq 300 kHz.
3. Detector = peak.
4. Sweep = auto couple.
5. Trace Mode = max hold.
6. Allow trace to fully stabilize.
7. Use the peak marker function to determine the maximum amplitude level.

4.6.5 Deviation from Test Standard

No deviation.

4.6.6 EUT Operating Condition

The software provided by client to enable the EUT under transmission condition continuously at lowest, middle and highest channel frequencies individually.

4.6.7 Test Results

The spectrum plots are attached on the following images. D1 line indicates the highest level, and D2 line indicates the 20 dB offset below D1. It shows compliance with the requirement.

802.11b

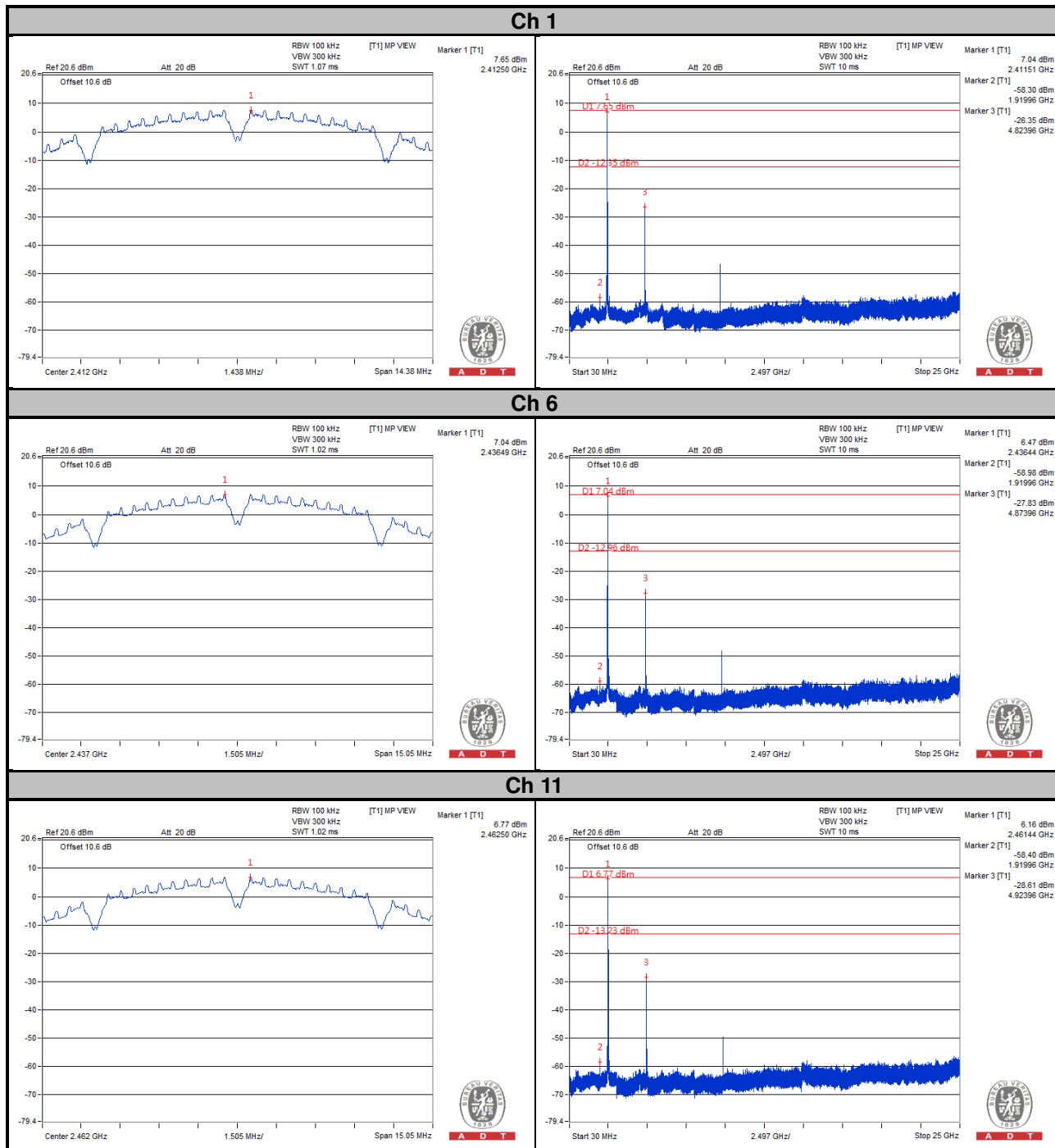

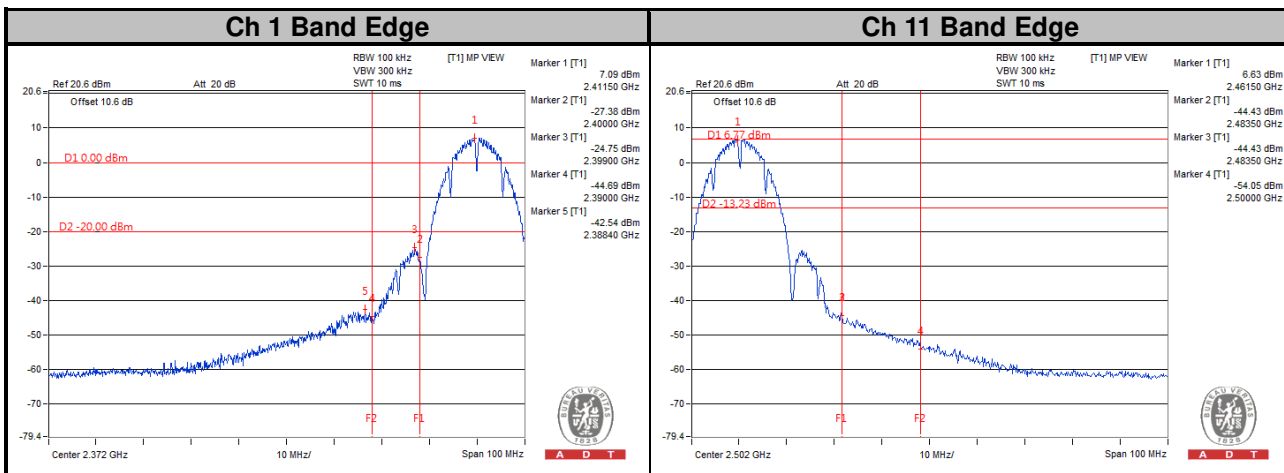

802.11g

Ch 1

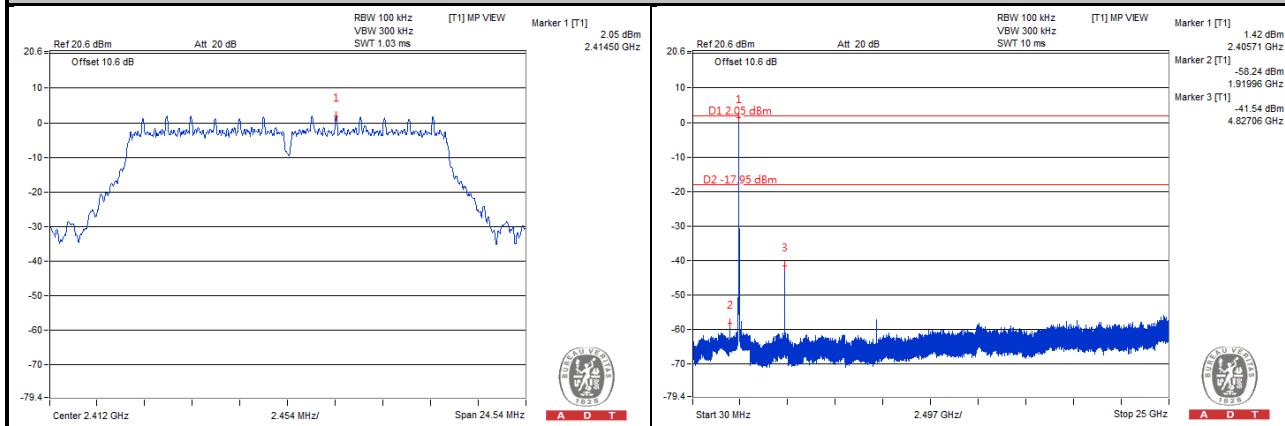

Ch 6

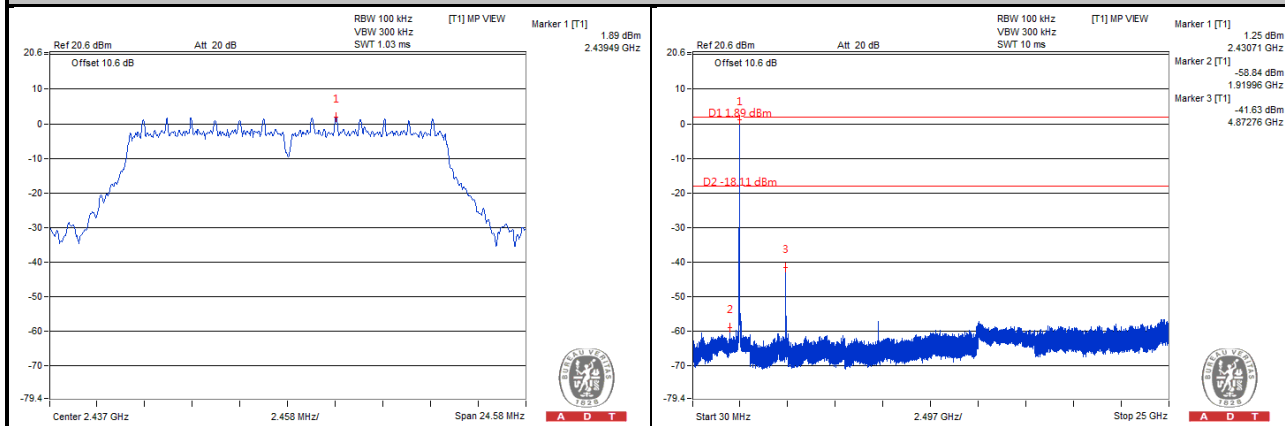

Ch 11

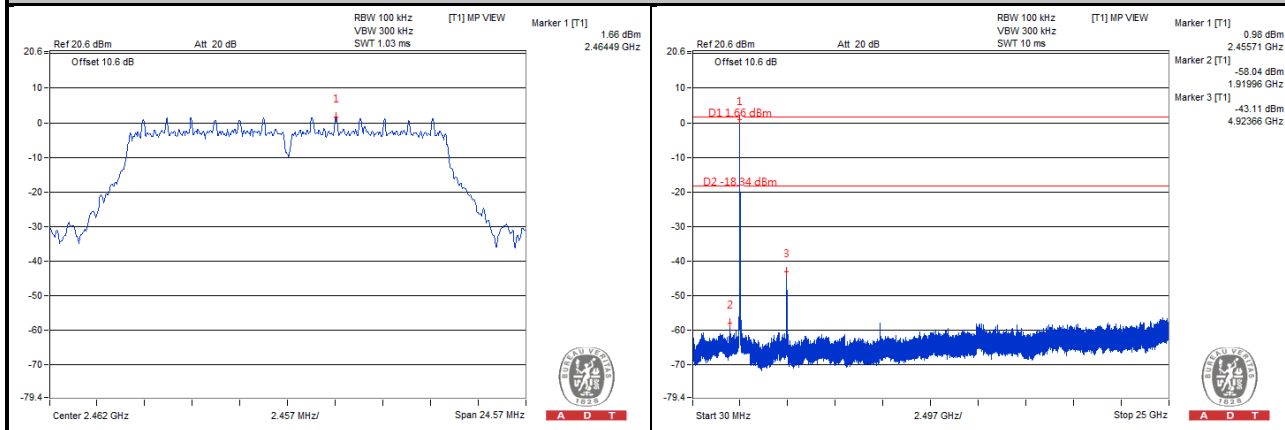

Ch 1 Band Edge

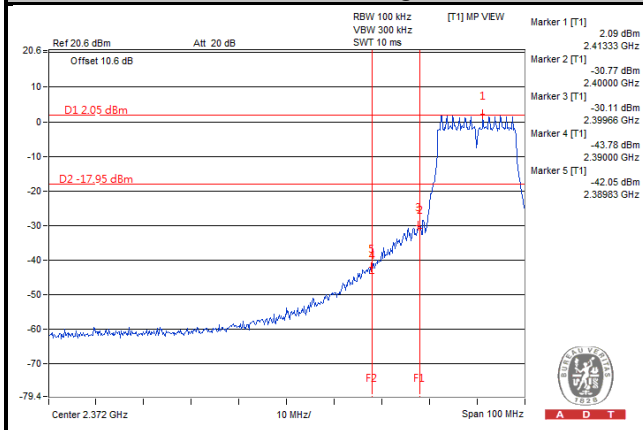

Ch 11 Band Edge

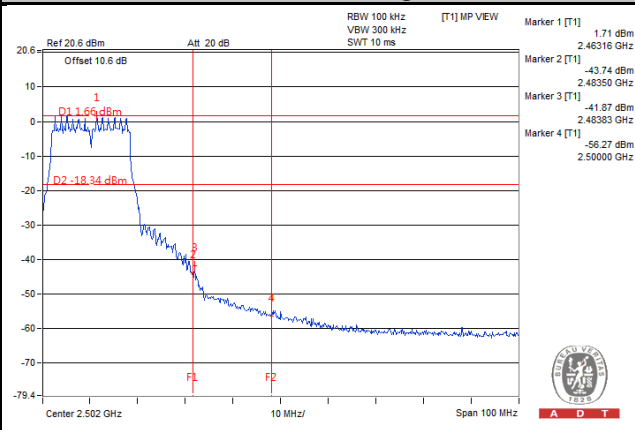

802.11n (HT20)

Ch 1

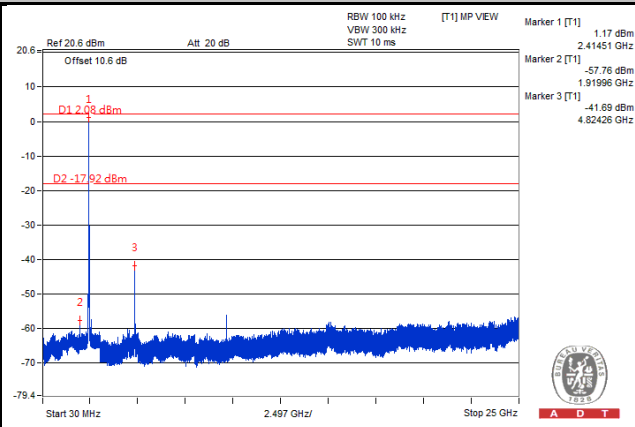
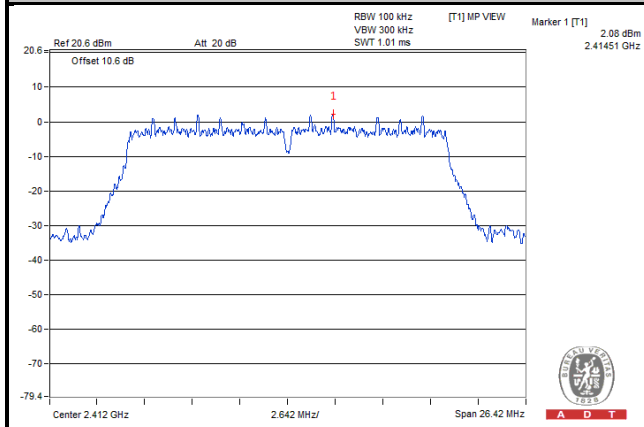

Ch 6

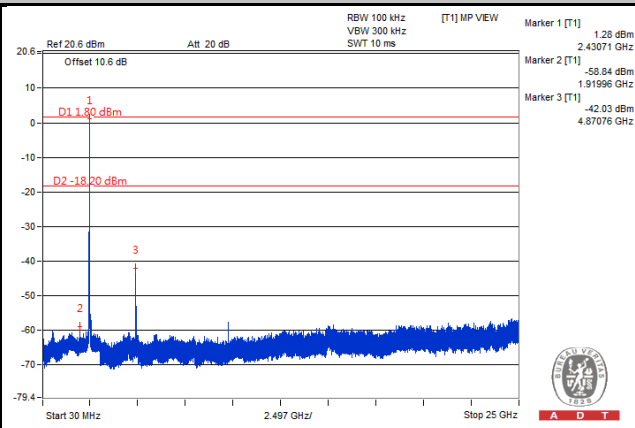
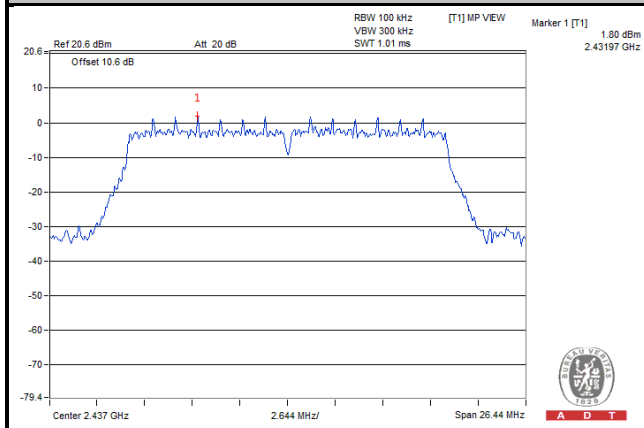

Ch 11

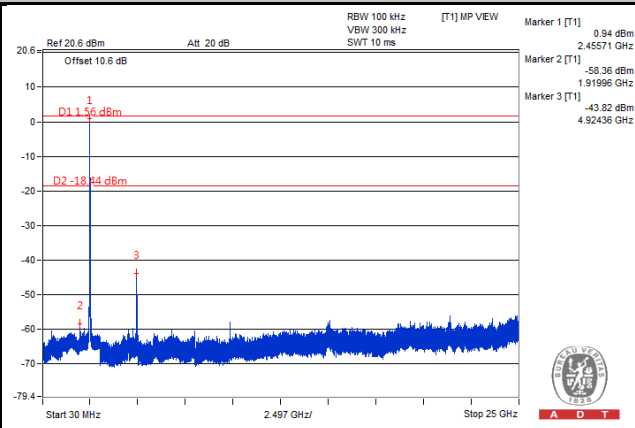
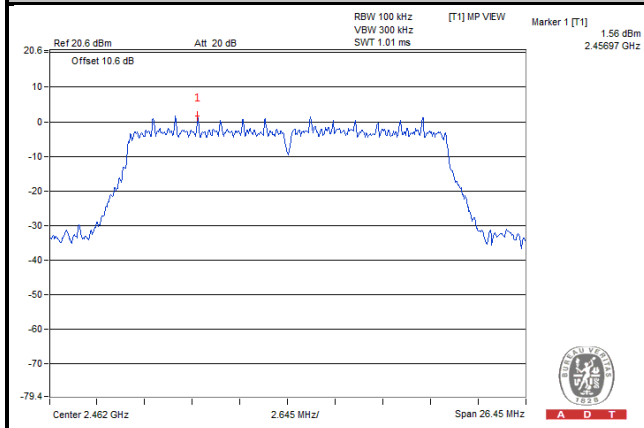

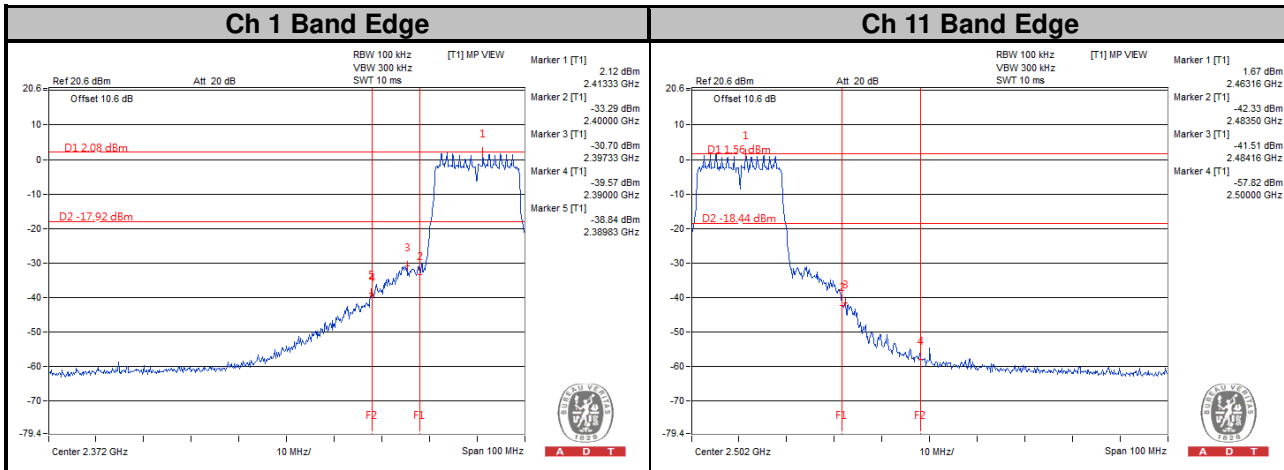

5 Pictures of Test Arrangements

Please refer to the attached file (Test Setup Photo).

Appendix – Information on the Testing Laboratories

We, Bureau Veritas Consumer Products Services (H.K.) Ltd., Taoyuan Branch, were founded in 1988 to provide our best service in EMC, Radio, Telecom and Safety consultation. Our laboratories are accredited and approved according to ISO/IEC 17025.

If you have any comments, please feel free to contact us at the following:

Linko EMC/RF Lab

Tel: 886-2-26052180

Fax: 886-2-26051924

Hsin Chu EMC/RF/Telecom Lab

Tel: 886-3-6668565

Fax: 886-3-6668323

Hwa Ya EMC/RF/Safety Lab

Tel: 886-3-3183232

Fax: 886-3-3270892

Email: service.adt@tw.bureauveritas.com

Web Site: www.bureauveritas-adt.com

The address and road map of all our labs can be found in our web site also.

--- END ---