



FCC Part 15C Test Report

FCC ID: 2ADUSL6

Product Name:	INMOTION E-SCOOTER
Trademark:	INMOTION
Model Name :	L6 L6X, L6XX.
Prepared For :	INMOTION TECHNOLOGIES CO., LTD
Address :	6TH FLOOR, BUILDING 8, TONGFUYU INDUSTRY CITY, XILI, NAN SHAN, SHEN ZHEN, CHINA 518055
Prepared By :	Shenzhen BCTC Technology Co., Ltd.
Address :	No.101, Yousong Road, Longhua New District, Shenzhen, China
Test Date:	May. 13 - May. 21, 2015
Date of Report :	May. 21, 2015
Report No.:	BCTC-15050053



VERIFICATION OF COMPLIANCE

Applicant's name..... : INMOTION TECHNOLOGIES CO., LTD
Address..... : 6TH FLOOR, BUILDING 8, TONGFUYU INDUSTRY CITY, XILI,
 NAN SHAN, SHEN ZHEN, CHINA 518055
Manufacture's Name..... : INMOTION TECHNOLOGIES CO., LTD
Address..... : 6TH FLOOR, BUILDING 8, TONGFUYU INDUSTRY CITY, XILI,
 NAN SHAN, SHEN ZHEN, CHINA 518055

Product description

Product name.....: INMOTION E-SCOOTER
Trademark: INMOTION
Model Name: L6
Test procedure FCC Part15.247
Standards ANSI C63.10-2013

This device described above has been tested by BCTC, and the test results show that the equipment under test (EUT) is in compliance with the FCC requirements. And it is applicable only to the tested sample identified in the report.

This report shall not be reproduced except in full, without the written approval of BCTC, this document may be altered or revised by BCTC, personal only, and shall be noted in the revision of the document.

Test Result..... : **Pass**

Testing Engineer : Eric Yang
 (Eric Yang)

Technical Manager : Sophie Lee
 (Sophia Lee)

Authorized Signatory : Carson Zhang
 (Carson. Zhang)



**Table of Contents**

	Page
1 . SUMMARY OF TEST RESULTS	6
1.1 TEST FACILITY	7
1.2 MEASUREMENT UNCERTAINTY	7
2 . GENERAL INFORMATION	8
2.1 GENERAL DESCRIPTION OF EUT	8
2.2 DESCRIPTION OF TEST MODES	10
2.3 TABLE OF PARAMETERS OF TEXT SOFTWARE SETTING	10
2.4 BLOCK DIGRAM SHOWING THE CONFIGURATION OF SYSTEM TESTED	11
2.5 DESCRIPTION OF SUPPORT UNITS(CONDUCTED MODE)	12
2.6 EQUIPMENTS LIST FOR ALL TEST ITEMS	13
3 . EMC EMISSION TEST	14
3.1 CONDUCTED EMISSION MEASUREMENT	14
3.1.1 POWER LINE CONDUCTED EMISSION LIMITS	14
3.1.2 TEST PROCEDURE	15
3.1.3 DEVIATION FROM TEST STANDARD	15
3.1.4 TEST SETUP	15
3.1.5 EUT OPERATING CONDITIONS	15
3.1.6 TEST RESULTS	16
3.2 RADIATED EMISSION MEASUREMENT	18
3.2.1 RADIATED EMISSION LIMITS	18
3.2.2 TEST PROCEDURE	19
3.2.3 DEVIATION FROM TEST STANDARD	19
3.2.4 TEST SETUP	20
3.2.5 EUT OPERATING CONDITIONS	21
3.2.6 TEST RESULTS	22
4 . NUMBER OF HOPPING CHANNEL	27
4.1 APPLIED PROCEDURES / LIMIT	27
4.1.1 TEST PROCEDURE	27
4.1.2 DEVIATION FROM STANDARD	27
4.1.3 TEST SETUP	27
4.1.4 EUT OPERATION CONDITIONS	27

**Table of Contents**

	Page
4.1.5 TEST RESULTS	28
5 . AVERAGE TIME OF OCCUPANCY	29
5.1 APPLIED PROCEDURES / LIMIT	29
5.1.1 TEST PROCEDURE	29
5.1.2 DEVIATION FROM STANDARD	29
5.1.3 TEST SETUP	30
5.1.4 EUT OPERATION CONDITIONS	30
5.1.5 TEST RESULTS	31
6 . HOPPING CHANNEL SEPARATION MEASUREMENT	37
6.1 APPLIED PROCEDURES / LIMIT	37
6.1.1 TEST PROCEDURE	37
6.1.2 DEVIATION FROM STANDARD	37
6.1.3 TEST SETUP	37
6.1.4 EUT OPERATION CONDITIONS	37
6.1.5 TEST RESULTS	38
7 . BANDWIDTH TEST	44
7.1 APPLIED PROCEDURES / LIMIT	44
7.1.1 TEST PROCEDURE	44
7.1.2 DEVIATION FROM STANDARD	44
7.1.3 TEST SETUP	44
7.1.4 EUT OPERATION CONDITIONS	44
7.1.5 TEST RESULTS	45
8 . PEAK OUTPUT POWER TEST	51
8.1 APPLIED PROCEDURES / LIMIT	51
8.1.1 TEST PROCEDURE	51
8.1.2 DEVIATION FROM STANDARD	51
8.1.3 TEST SETUP	51
8.1.4 EUT OPERATION CONDITIONS	51
8.1.5 TEST RESULTS	52
9 . 100 KHZ BANDWIDTH OF FREQUENCY BAND EDGE	59
9.1 DEVIATION FROM STANDARD	59
9.2 TEST SETUP	60



Table of Contents

	Page
9.3 EUT OPERATION CONDITIONS	60
9.4 TEST RESULTS	61
10 . ANTENNA REQUIREMENT	65
10.1 STANDARD REQUIREMENT	65
10.2 EUT ANTENNA	65
11 . EUT TEST PHOTO	66
APPENDIX-PHOTOGRAPHS OF EUT CONSTRUCTIONAL DETAILS	



1. SUMMARY OF TEST RESULTS

Test procedures according to the technical standards:

FCC Part15 (15.247) , Subpart C			
Standard Section	Test Item	Judgment	Remark
15.207	Conducted Emission	PASS	
15.247(a)(1)	Hopping Channel Separation	PASS	
15.247(b)(1)	Peak Output Power	PASS	
15.247(c)	Radiated Spurious Emission	PASS	
15.247(a)(iii)	Number of Hopping Frequency	PASS	
15.247(a)(iii)	Dwell Time	PASS	
15.247(a)(1)	Bandwidth	PASS	
15.205	Band Edge Emission	PASS	
15.203	Antenna Requirement	PASS	

NOTE:

(1) "N/A" denotes test is not applicable in this Test Report



1.1 TEST FACILITY

Shenzhen BCTC Technology Co., Ltd.
Add.:No.101,Yousong Road,Longhua New District, Shenzhen,China
FCC Registration No.:187086

1.2 MEASUREMENT UNCERTAINTY

The reported uncertainty of measurement $y \pm U$, where expanded uncertainty U is based on a standard uncertainty multiplied by a coverage factor of $k=2$, providing a level of confidence of approximately 95%.

No.	Item	Uncertainty
1	Conducted Emission Test	$\pm 1.38\text{dB}$
2	RF power,conducted	$\pm 0.16\text{dB}$
3	Spurious emissions,conducted	$\pm 0.21\text{dB}$
4	All emissions,radiated(<1G)	$\pm 4.68\text{dB}$
5	All emissions,radiated(>1G)	$\pm 4.89\text{dB}$
6	Temperature	$\pm 0.5^{\circ}\text{C}$
7	Humidity	$\pm 2\%$



2. GENERAL INFORMATION

2.1 GENERAL DESCRIPTION OF EUT

Equipment	INMOTION E-SCOOTER	
Trade Name	INMOTION	
Model Name	L6	
Serial Model	L6X, L6XX.	
Model Difference	All the same, Only model name is different.	
Product Description	The EUT is a INMOTION E-SCOOTER	
	Operation Frequency:	2402~2480 MHz
	Modulation Type:	BT(1Mbps): GFSK BT EDR(2Mbps): $\pi/4$ -DQPSK BT EDR(3Mbps): 8-DPSK
	Bit Rate of Transmitter	1Mbps/2Mbps/3Mbps
	Number Of Channel	79 CH
	Antenna Designation:	Please see Note 3.
	Output Power(Conducted):	BT(1Mbps): 1.689dBm BT EDR(2Mbps): 0.885dBm BT EDR(3Mbps): 0.871dBm
	Based on the application, features, or specification exhibited in User's Manual, the EUT is considered as an ITE/Computing Device. More details of EUT technical specification, please refer to the User's Manual.	
Channel List	Please refer to the Note 2.	
Adapter	Model: XVE-5460200 AC Power Input: 100-240V~, 50/60Hz, 2.5A Output: 54.6V --- 2.0A	
Battery	DC 48V ---	
Connecting I/O Port(s)	Please refer to the User's Manual	

Note:

1. For a more detailed features description, please refer to the manufacturer's specifications or the User's Manual.
- 2.

Channel List					
Channel	Frequency (MHz)	Channel	Frequency (MHz)	Channel	Frequency (MHz)
00	2402	27	2429	54	2456
01	2403	28	2430	55	2457



02	2404	29	2431	56	2458
03	2405	30	2432	57	2459
04	2406	31	2433	58	2460
05	2407	32	2434	59	2461
06	2408	33	2435	60	2462
07	2409	34	2436	61	2463
08	2410	35	2437	62	2464
09	2411	36	2438	63	2465
10	2412	37	2439	64	2466
11	2413	38	2440	65	2467
12	2414	39	2441	66	2468
13	2415	40	2442	67	2469
14	2416	41	2443	68	2470
15	2417	42	2444	69	2471
16	2418	43	2445	70	2472
17	2419	44	2446	71	2473
18	2420	45	2447	72	2474
19	2421	46	2448	73	2475
20	2422	47	2449	74	2476
21	2423	48	2450	75	2477
22	2424	49	2451	76	2478
23	2425	50	2452	77	2479
24	2426	51	2453	78	2480
25	2427	52	2454		
26	2428	53	2455		

3.

Table for Filed Antenna

Ant	Brand	Model Name	Antenna Type	Connector	Gain (dBi)	NOTE
1	N/A	N/A	PCB Antenna	N/A	0	BT Antenna



2.2 DESCRIPTION OF TEST MODES

To investigate the maximum EMI emission characteristics generates from EUT, the test system was pre-scanning tested base on the consideration of following EUT operation mode or test configuration mode which possible have effect on EMI emission level. Each of these EUT operation mode(s) or test configuration mode(s) mentioned above was evaluated respectively.

Pretest Mode	Description
Mode 1	CH00
Mode 2	CH39
Mode 3	CH78
Mode 4	Normal Link

For Conducted Emission	
Final Test Mode	Description
Mode 4	Normal Link

For Radiated Emission	
Final Test Mode	Description
Mode 1	CH00
Mode 2	CH39
Mode 3	CH78

Note:

- (1) The measurements are performed at the highest, middle, lowest available channels.
- (2) Fully-charged battery is used during the test
- (3)The data rate was set in 1Mbps for radiated emission due to the highest RF output power.

2.3 TABLE OF PARAMETERS OF TEXT SOFTWARE SETTING

During testing channel & power controlling software provided by the customer was used to control the operating channel as well as the output power level. The RF output power selection is for the setting of RF output power expected by the customer and is going to be fixed on the firmware of the final end product power parameters of FHSS

Test software Version	Test program: Broadcom		
Frequency	2402 MHz	2441 MHz	2480 MHz
Parameters(1/2/3Mbps)	DEF	DEF	DEF



2.4 BLOCK DIGRAM SHOWING THE CONFIGURATION OF SYSTEM TESTED

Conducted Emission Test

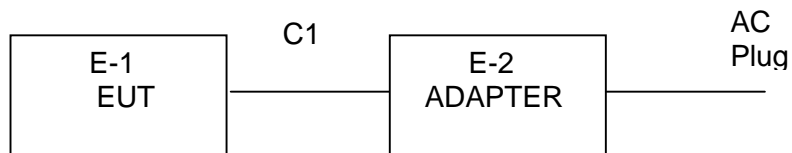

Radiated Spurious Emission Test

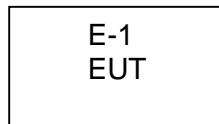



2.5 DESCRIPTION OF SUPPORT UNITS(CONDUCTED MODE)

The EUT has been tested as an independent unit together with other necessary accessories or support units. The following support units or accessories were used to form a representative test configuration during the tests.

Item	Equipment	Mfr/Brand	Model/Type No.	Series No.	Note
E-1	INMOTION E-SCOOTER	INMOTION	L6	N/A	EUT
E-2	Adapter	N/A	XVE-5460200	N/A	

Item	Shielded Type	Ferrite Core	Length	Note
C-1	NO	NO	1.5m	

Note:

- (1) The support equipment was authorized by Declaration of Confirmation.
- (2) For detachable type I/O cable should be specified the length in cm in 『Length』 column.
- (3) “YES” is means “shielded” “with core”; “NO” is means “unshielded” “without core”.



2.6 EQUIPMENTS LIST FOR ALL TEST ITEMS

Radiation Test equipment

Item	Kind of Equipment	Manufacturer	Type No.	Serial No.	Last calibration	Calibrated until	Calibration period
1	Spectrum Analyzer	Agilent	E4407B	MY45108040	2014.07.06	2015.07.05	1 year
2	Test Receiver	R&S	ESPI	101318	2014.06.07	2015.06.06	1 year
3	Bilog Antenna	TESEQ	CBL6111D	31216	2014.07.06	2015.07.05	1 year
4	50Ω Coaxial Switch	Anritsu	MP59B	6200264416	2014.06.07	2015.06.06	1 year
5	Spectrum Analyzer	ADVANTEST	R3132	150900201	2014.06.07	2015.06.06	1 year
6	Horn Antenna	EM	EM-AH-10180	2011071402	2014.07.06	2015.07.05	1 year
7	Horn Ant	Schwarzbeck	BBHA 9170	9170-181	2014.07.06	2015.07.05	1 year
8	Amplifier	EM	EM-30180	060538	2014.12.22	2015.12.21	1 year
9	Loop Antenna	ARA	PLA-1030/B	1029	2014.06.08	2015.06.07	1 year
10	Power Meter	R&S	NRVS	100696	2014.07.06	2015.07.05	1 year
11	Power Sensor	R&S	URV5-Z4	0395.1619.05	2014.07.06	2015.07.05	1 year
12	RF cables	R&S	R203	R20X	2014.07.06	2015.07.05	1 year

Conduction Test equipment

Item	Kind of Equipment	Manufacturer	Type No.	Serial No.	Last calibration	Calibrated until	Calibration period
1	Test Receiver	R&S	ESCI	101160	2014.06.06	2015.06.05	1 year
2	LISN	R&S	ENV216	101313	2014.08.24	2015.08.23	1 year
3	LISN	EMCO	3816/2	00042990	2014.08.24	2015.08.23	1 year
4	50Ω Coaxial Switch	Anritsu	MP59B	6200264417	2014.06.07	2015.06.06	1 year
5	Passive Voltage Probe	R&S	ESH2-Z3	100196	2014.06.07	2015.06.06	1 year
6	Absorbing clamp	R&S	MOS-21	100423	2014.06.08	2015.06.07	1 year
7	RF cables	R&S	R204	R20X	2014.07.06	2015.07.05	1 year



3. EMC EMISSION TEST

3.1 CONDUCTED EMISSION MEASUREMENT

3.1.1 POWER LINE CONDUCTED EMISSION Limits (Frequency Range 150KHz-30MHz)

FREQUENCY (MHz)	Class A (dBuV)		Class B (dBuV)		Standard
	Quasi-peak	Average	Quasi-peak	Average	
0.15 -0.5	79.00	66.00	66 - 56 *	56 - 46 *	CISPR
0.50 -5.0	73.00	60.00	56.00	46.00	CISPR
5.0 -30.0	73.00	60.00	60.00	50.00	CISPR

0.15 -0.5	79.00	66.00	66 - 56 *	56 - 46 *	FCC
0.50 -5.0	73.00	60.00	56.00	46.00	FCC
5.0 -30.0	73.00	60.00	60.00	50.00	FCC

Note:

- (1) The tighter limit applies at the band edges.
- (2) The limit of " * " marked band means the limitation decreases linearly with the logarithm of the frequency in the range.

The following table is the setting of the receiver

Receiver Parameters	Setting
Attenuation	10 dB
Start Frequency	0.15 MHz
Stop Frequency	30 MHz
IF Bandwidth	9 kHz



3.1.2 TEST PROCEDURE

- The EUT was placed 0.8 meters from the horizontal ground plane with EUT being connected to the power mains through a line impedance stabilization network (LISN). All other support equipments powered from additional LISN(s). The LISN provide 50 Ohm/ 50uH of coupling impedance for the measuring instrument.
- Interconnecting cables that hang closer than 40 cm to the ground plane shall be folded back and forth in the center forming a bundle 30 to 40 cm long.
- I/O cables that are not connected to a peripheral shall be bundled in the center. The end of the cable may be terminated, if required, using the correct terminating impedance. The overall length shall not exceed 1 m.
- LISN at least 80 cm from nearest part of EUT chassis.
- For the actual test configuration, please refer to the related Item –EUT Test Photos.

3.1.3 DEVIATION FROM TEST STANDARD

No deviation

3.1.4 TEST SETUP

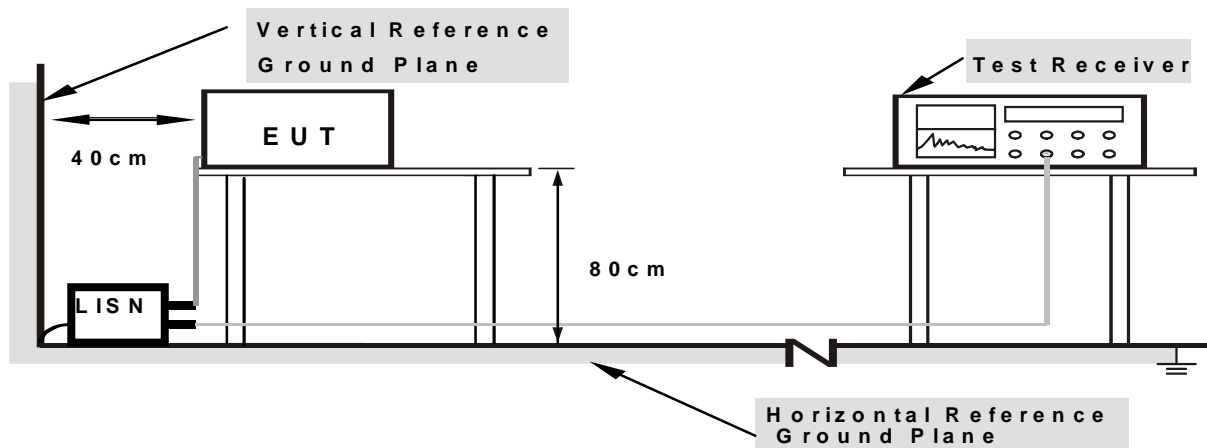

- Note: 1.Support units were connected to second LISN.
2.Both of LISNs (AMN) are 80 cm from EUT and at least 80 cm from other units and other metal planes

3.1.5 EUT OPERATING CONDITIONS

The EUT was configured for testing in a typical fashion (as a customer would normally use it). The EUT has been programmed to continuously transmit during test. This operating condition was tested and used to collect the included data.



3.1.6 TEST RESULTS

EUT :	INMOTION E-SCOOTER	Model Name :	L6
Temperature :	26 °C	Relative Humidity :	54%
Pressure :	1010hPa	Phase :	L
Test Voltage :	AC 120V/60Hz	Test Mode :	Mode 4

Frequency (MHz)	Meter Reading (dBμV)	Factor (dB)	Emission Level (dBμV)	Limits (dBμV)	Margin (dB)	Detector Type
0.1900	38.08	10.06	48.14	64.03	-15.89	QP
0.1900	30.26	10.06	40.32	54.03	-13.71	AVG
0.3180	25.91	10.10	36.01	59.76	-23.75	QP
0.3180	21.99	10.10	32.09	49.76	-17.67	AVG
0.5060	21.75	10.12	31.87	56.00	-24.13	QP
0.5060	19.86	10.12	29.98	46.00	-16.02	AVG
4.3020	22.26	10.16	32.42	56.00	-23.58	QP
4.3020	21.23	10.16	31.39	46.00	-14.61	AVG
17.2740	32.69	10.16	42.85	60.00	-17.15	QP
17.2740	22.87	10.16	33.03	50.00	-16.97	AVG
21.9580	39.92	10.18	50.10	60.00	-9.90	QP
21.9580	32.66	10.18	42.84	50.00	-7.16	AVG

Remark:

1. All readings are Quasi-Peak and Average values.
2. Factor = Insertion Loss + Cable Loss.

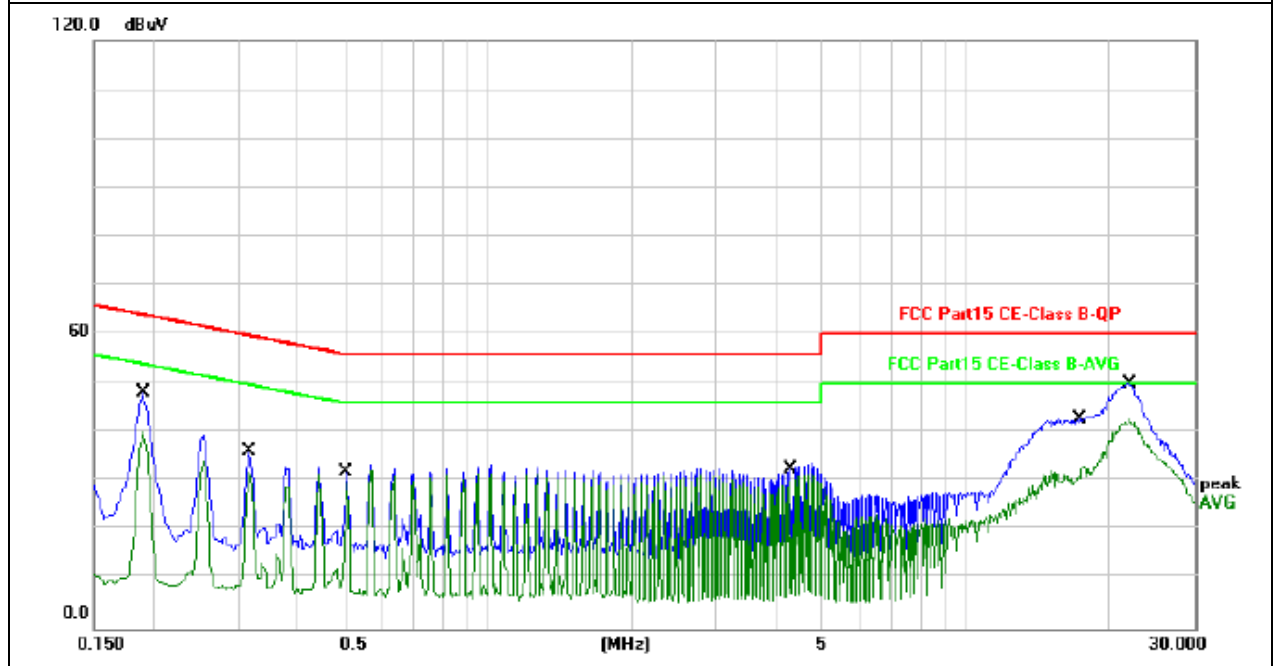



EUT :	INMOTION E-SCOOTER	Model Name. :	L6
Temperature :	26 °C	Relative Humidity :	54%
Pressure :	1010hPa	Phase :	N
Test Voltage :	AC 120V/60Hz	Test Mode :	Mode 4

Frequency (MHz)	Meter Reading (dBμV)	Factor (dB)	Emission Level (dBμV)	Limits (dBμV)	Margin (dB)	Detector Type
0.1900	39.52	10.06	49.58	64.03	-14.45	QP
0.1900	30.05	10.06	40.11	54.03	-13.92	AVG
0.2540	30.08	10.08	40.16	61.62	-21.46	QP
0.2540	23.93	10.08	34.01	51.62	-17.61	AVG
0.4420	23.44	10.11	33.55	57.02	-23.47	QP
0.4420	21.65	10.11	31.76	47.02	-15.26	AVG
1.8980	21.07	10.18	31.25	56.00	-24.75	QP
1.8980	19.80	10.18	29.98	46.00	-16.02	AVG
7.6540	23.85	10.10	33.95	60.00	-26.05	QP
7.6540	19.70	10.10	29.80	50.00	-20.20	AVG
21.5700	39.61	10.18	49.79	60.00	-10.21	QP
21.5700	31.69	10.18	41.87	50.00	-8.13	AVG

Remark:

1. All readings are Quasi-Peak and Average values.
2. Factor = Insertion Loss + Cable Loss.

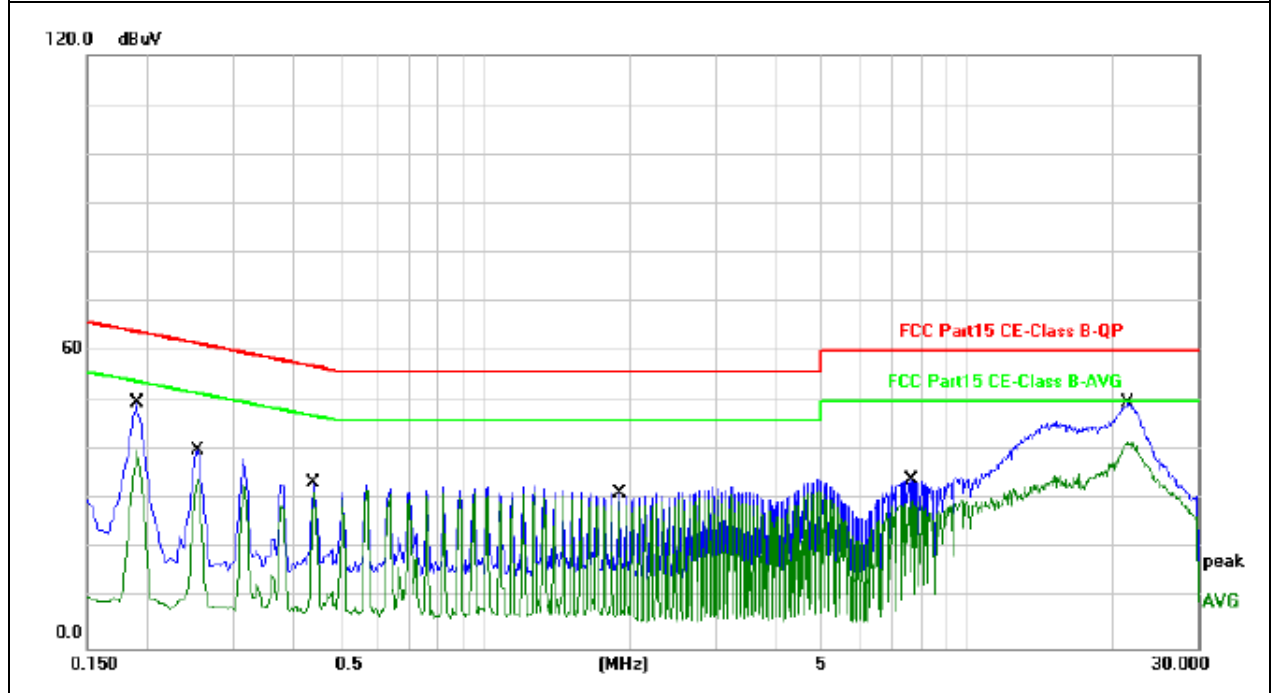



3.2 RADIATED EMISSION MEASUREMENT

3.2.1 RADIATED EMISSION LIMITS (Frequency Range 9kHz-1000MHz)

20dBc in any 100 kHz bandwidth outside the operating frequency band. In case the emission fall within the restricted band specified on 15.205(a), then the 15.209(a) limit in the table below has to be followed.

Frequencies (MHz)	Field Strength (microrvolts/meter)	Measurement Distance (meters)
0.009~0.490	2400/F(KHz)	300
0.490~1.705	24000/F(KHz)	30
1.705~30.0	30	30
30~88	100	3
88~216	150	3
216~960	200	3
Above 960	500	3

LIMITS OF RADIATED EMISSION MEASUREMENT (Above 1000MHz)

FREQUENCY (MHz)	Class A (dBuV/m) (at 3M)		Class B (dBuV/m) (at 3M)	
	PEAK	AVERAGE	PEAK	AVERAGE
Above 1000	80	60	74	54

Notes:

- (1) The limit for radiated test was performed according to FCC PART 15C.
- (2) The tighter limit applies at the band edges.
- (3) Emission level (dBuV/m)=20log Emission level (uV/m).

FREQUENCY RANGE OF RADIATED MEASUREMENT (For unintentional radiators)

Highest frequency generated or Upper frequency of measurement used in the device or on which the device operates or tunes (MHz)	Range (MHz)
Below 1.705	30
1.705 – 108	1000
108 – 500	2000
500 – 1000	5000
Above 1000	5 th harmonic of the highest frequency or 40 GHz, whichever is lower



Spectrum Parameter	Setting
Attenuation	Auto
Start Frequency	1000 MHz
Stop Frequency	10th carrier harmonic
RB / VB (emission in restricted band)	1 MHz / 1 MHz for Peak, 1 MHz / 10Hz for Average

Receiver Parameter	Setting
Attenuation	Auto
Start ~ Stop Frequency	9kHz~150kHz / RB 200Hz for QP
Start ~ Stop Frequency	150kHz~30MHz / RB 9kHz for QP
Start ~ Stop Frequency	30MHz~1000MHz / RB 120kHz for QP

3.2.2 TEST PROCEDURE

- a. The measuring distance of at 3 m shall be used for measurements at frequency up to 1GHz. For frequencies above 1GHz, any suitable measuring distance may be used.
- b. The EUT was placed on the top of a rotating table 0.8 meters above the ground at a 3 meter open area test site. The table was rotated 360 degrees to determine the position of the highest radiation.
- c. The height of the equipment or of the substitution antenna shall be 0.8 m; above 1GHz, the height was 1.5m, the height of the test antenna shall vary between 1 m to 4 m. Both horizontal and vertical polarizations of the antenna are set to make the measurement.
- d. The initial step in collecting conducted emission data is a spectrum analyzer peak detector mode pre-scanning the measurement frequency range. Significant peaks are then marked and then Quasi Peak detector mode re-measured.
- e. If the Peak Mode measured value compliance with and lower than Quasi Peak Mode Limit, the EUT shall be deemed to meet QP Limits and then no additional QP Mode measurement performed.
- f. For the actual test configuration, please refer to the related Item –EUT Test Photos.

Note:

Both horizontal and vertical antenna polarities were tested and performed pretest to three orthogonal axis. The worst case emissions were reported

3.2.3 DEVIATION FROM TEST STANDARD

No deviation

3.2.4 TEST SETUP

(A) Radiated Emission Test-Up Frequency Below 30MHz

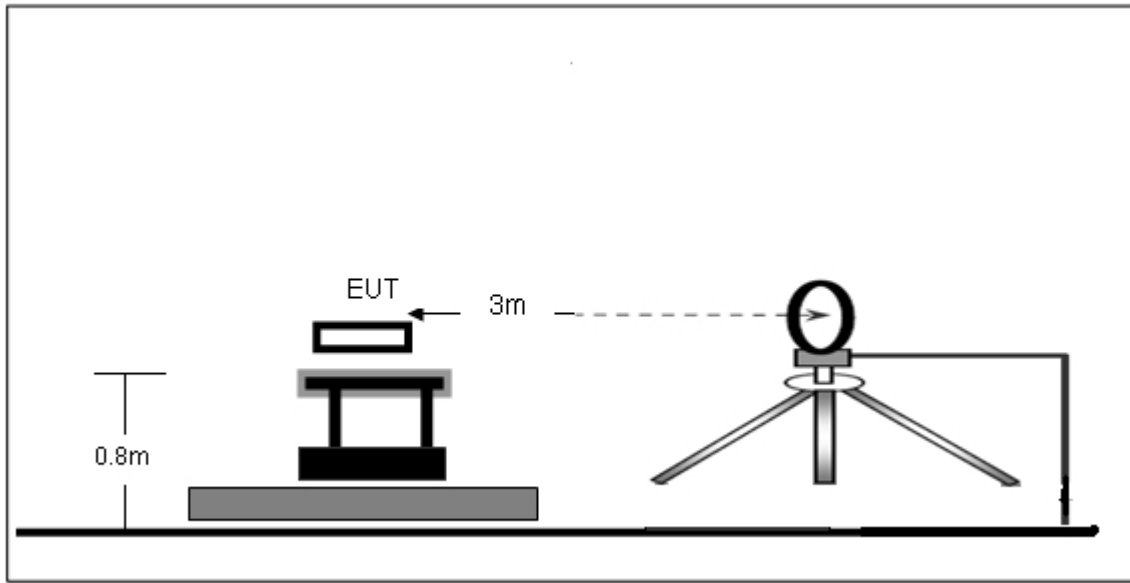

(B) Radiated Emission Test-Up Frequency 30MHz~1GHz

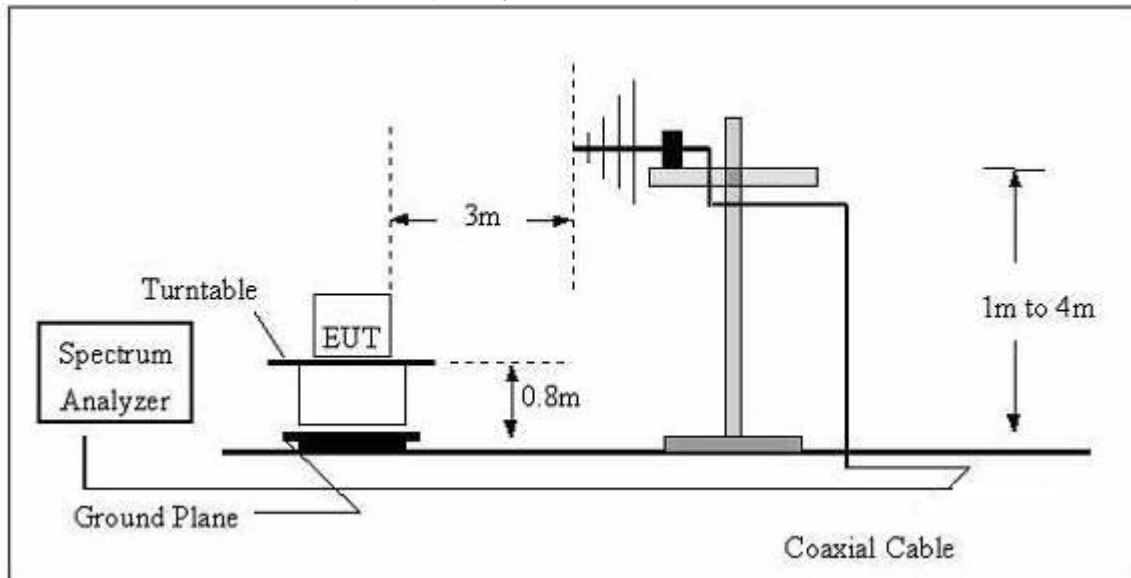

(C) Radiated Emission Test-Up Frequency Above 1GHz

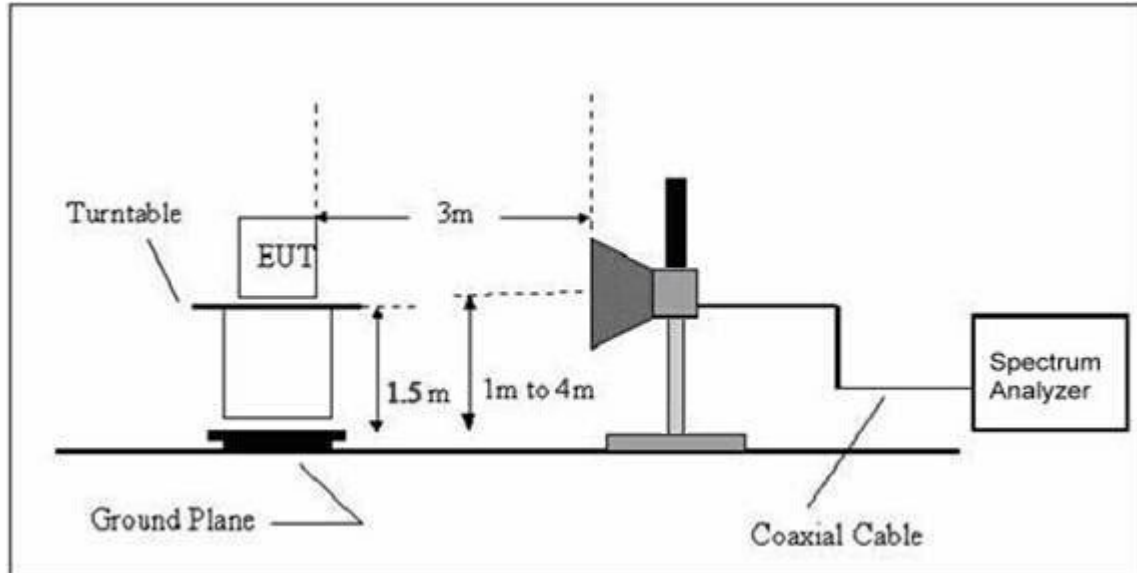
**3.2.5 EUT OPERATING CONDITIONS**

The EUT tested system was configured as the statements of 2.4 Unless otherwise a special operating condition is specified in the follows during the testing.



3.2.6 TEST RESULTS

Radiated Spurious Emission (Below 30MHz)

EUT :	INMOTION E-SCOOTER	Model Name :	L6
Temperature :	20 °C	Relative Humidity :	48%
Pressure :	1010 hPa	Polarization :	---
Test Voltage :	By Battery		
Test Mode :	TX		

Freq.	Reading	Limit	Margin	State
(MHz)	(dBuV/m)	(dBuV/m)	(dB)	P/F
--	--	--	--	PASS
--	--	--	--	PASS

NOTE:

The amplitude of spurious emissions which are attenuated by more than 20dB below the permissible value has no need to be reported.

Distance extrapolation factor = $40 \log(\text{specific distance}/\text{test distance})$ (dB);

Limit line = specific limits(dBuv) + distance extrapolation factor.



Radiated Spurious Emission (Between 30MHz – 1GHz)

EUT :	INMOTION E-SCOOTER	Model Name :	L6
Temperature :	26 °C	Relative Humidity :	54%
Pressure :	1010 hPa	Polarization :	Horizontal
Test Voltage :	By Battery		
Test Mode :	TX		

Frequency (MHz)	Meter Reading (dBµV)	Factor (dB)	Emission Level (dBµV/m)	Limits (dBµV/m)	Margin (dB)	Detector Type
194.4534	43.74	-15.86	27.88	43.50	-15.62	QP
232.5318	44.82	-14.91	29.91	46.00	-16.09	QP
325.5958	48.94	-11.92	37.02	46.00	-8.98	QP
365.5391	40.44	-11.07	29.37	46.00	-16.63	QP
399.0302	38.94	-10.20	28.74	46.00	-17.26	QP
972.3374	29.04	-0.39	28.65	54.00	-25.35	QP

Remark:
 Factor = Antenna Factor + Cable Loss – Pre-amplifier.
 All interfaces was connected, and BT TX mode was link.

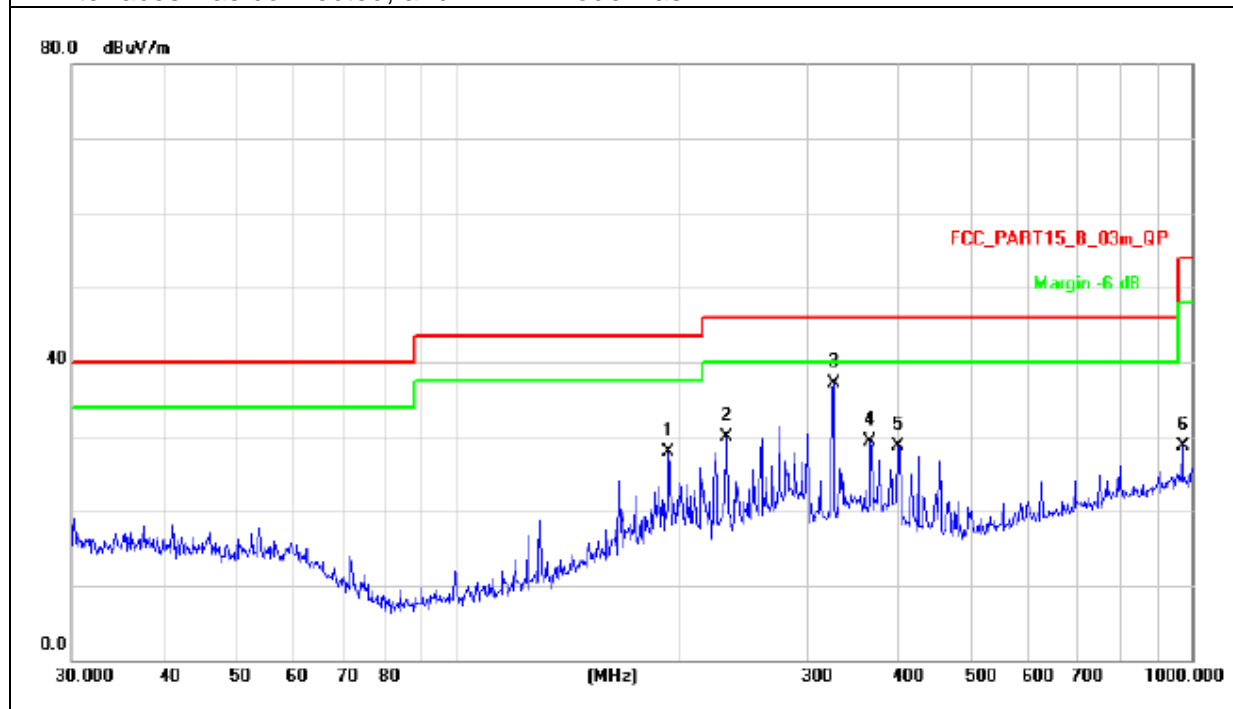



EUT :	INMOTION E-SCOOTER	Model Name :	L6
Temperature :	26 °C	Relative Humidity :	54%
Pressure :	1010 hPa	Polarization :	Vertical
Test Voltage :	By Battery		
Test Mode :	TX		

Frequency (MHz)	Meter Reading (dBμV)	Factor (dB)	Emission Level (dBμV/m)	Limits (dBμV/m)	Margin (dB)	Detector Type
43.9658	32.20	-9.35	22.85	40.00	-17.15	QP
167.2368	35.63	-13.29	22.34	43.50	-21.16	QP
324.4561	37.69	-11.95	25.74	46.00	-20.26	QP
400.4319	37.53	-10.17	27.36	46.00	-18.64	QP
454.3100	37.53	-8.95	28.58	46.00	-17.42	QP
694.4174	31.59	-4.48	27.11	46.00	-18.89	QP

Remark:

Factor = Antenna Factor + Cable Loss – Pre-amplifier.
 All interfaces was connected, and BT TX mode was link.

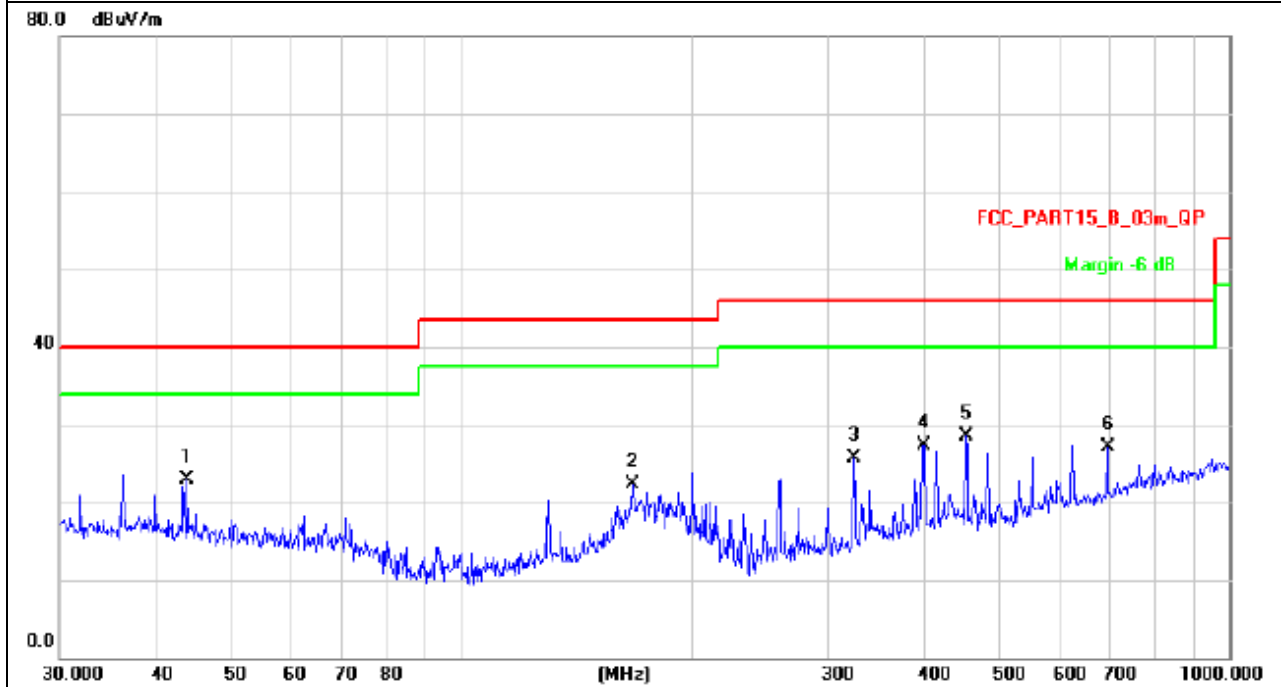



Radiated Spurious Emission (1GHz to 10th harmonics)
 (Scan with GFSK, $\pi/4$ -DQPSK,8DPSK,the worst casw is BDR Mode (GFSK))

Frequency (MHz)	Meter Reading (dB μ V)	Factor (dB)	Emission Level (dB μ V/m)	Limits (dB μ V/m)	Margin (dB)	Detector Type	Comment
Low Channel (2402 MHz)							
1159.3	65.41	-19.14	46.27	74	-27.73	peak	Vertical
1586.6	61.49	-16.43	45.06	74	-28.94	peak	Vertical
3145.4	60.25	-11.63	48.62	74	-25.38	peak	Vertical
4806.7	55.68	-3.64	52.04	74	-21.96	peak	Vertical
1158.9	69.82	-19.14	50.68	74	-23.32	peak	Horizontal
1596.5	65.43	-16.43	49	74	-25	peak	Horizontal
3150.2	58.71	-11.63	47.08	74	-26.92	peak	Horizontal
4803.4	51.34	-3.64	47.7	74	-26.3	peak	Horizontal
Mid Channel (2441 MHz)							
1235.4	64.28	-17.48	46.8	74	-27.2	peak	Vertical
2122.6	58.43	-12.92	45.51	74	-28.49	peak	Vertical
2846.9	56.51	-11.73	44.78	74	-29.22	peak	Vertical
4879.2	54.53	-3.68	50.85	74	-23.15	peak	Vertical
1197.3	66.67	-19.14	47.53	74	-26.47	peak	Horizontal
1835.3	61.78	-16.06	45.72	74	-28.28	peak	Horizontal
2686.1	56.89	-12.77	44.12	74	-29.88	peak	Horizontal
4880.6	52.76	-3.68	49.08	74	-24.92	peak	Horizontal
High Channel (2480 MHz)							
1272.5	62.63	-18.54	44.09	74	-29.91	peak	Vertical
2375.2	63.25	-12.87	50.38	74	-23.62	peak	Vertical
3227.4	54.57	-11.43	43.14	74	-30.86	peak	Vertical
4951.4	51.19	-3.59	47.6	74	-26.4	peak	Vertical
1228.6	69.54	-19.14	50.4	74	-23.6	peak	Horizontal
1940.2	66.68	-17.48	49.2	74	-24.8	peak	Horizontal
2852.7	64.47	-14.64	49.83	74	-24.17	peak	Horizontal
4960.3	52.82	-3.59	49.23	74	-24.77	peak	Horizontal

Remark:
 Factor = Antenna Factor + Cable Loss – Pre-amplifier.
 Emission Level = Meter Reading + Factor
 Margin = Emission Level - Limit



Radiated band edge:

Frequency (MHz)	Meter Reading (dBμV)	Factor (dB)	Emission Level (dBμV/m)	Limits (dBμV/m)	Margin (dB)	Detector Type	Comment
GFSK							
2400	45.53	-13.06	32.47	74	-41.53	peak	Vertical
2400	47.34	-13.06	34.28	74	-39.72	peak	Horizontal
2483.5	45.42	-12.78	32.64	74	-41.36	peak	Vertical
2483.5	47.83	-12.78	35.05	74	-38.95	peak	Horizontal
$\pi/4$-DQPSK							
2400	48.73	-13.06	35.67	74	-38.33	peak	Vertical
2400	50.51	-13.06	37.45	74	-36.55	peak	Horizontal
2483.5	47.72	-12.78	34.94	74	-39.06	peak	Vertical
2483.5	51.49	-12.78	38.71	74	-35.29	peak	Horizontal
8DPSK							
2400	48.51	-13.06	35.45	74	-38.55	peak	Vertical
2400	47.36	-13.06	34.3	74	-39.7	peak	Horizontal
2483.5	48.68	-12.78	35.9	74	-38.1	peak	Vertical
2483.5	47.81	-12.78	35.03	74	-38.97	peak	Horizontal

NOTE: 1.The result(PK) less than AV limite,No need shown AV result.
 2.Hopping enabled and disabled have evaluated,and the worst data was reported



4. NUMBER OF HOPPING CHANNEL

4.1 APPLIED PROCEDURES / LIMIT

FCC Part15 (15.247) , Subpart C				
Section	Test Item	Limit	Frequency Range (MHz)	Result
15.247 (a)(1)(iii)	Number of Hopping Channel	≥15	2400-2483.5	PASS

Spectrum Parameters	Setting
Attenuation	Auto
Span Frequency	= the frequency band of operation
RB	RBW ≥ 1% of the span
VB	VBW ≥ RBW
Detector	Peak
Trace	Max Hold
Sweep Time	Auto

4.1.1 TEST PROCEDURE

- a. The EUT was directly connected to the spectrum analyzer and antenna output port as show in the block diagram below,
- b. Spectrum Setting : RBW= 100KHz, VBW=100KHz, Sweep time = Auto.

4.1.2 DEVIATION FROM STANDARD

No deviation.

4.1.3 TEST SETUP

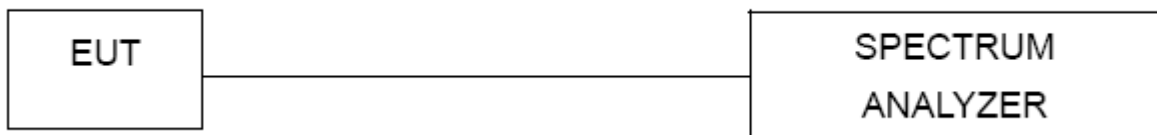

4.1.4 EUT OPERATION CONDITIONS

The EUT tested system was configured as the statements of 2.4 Unless otherwise a special operating condition is specified in the follows during the testing.



4.1.5 TEST RESULTS

EUT :	INMOTION E-SCOOTER	Model Name :	L6
Temperature :	25 °C	Relative Humidity :	60%
Pressure :	1015 hPa	Test Voltage :	By Battery
Test Mode :	Hopping Mode		

Number of Hopping Channel	79
---------------------------	----

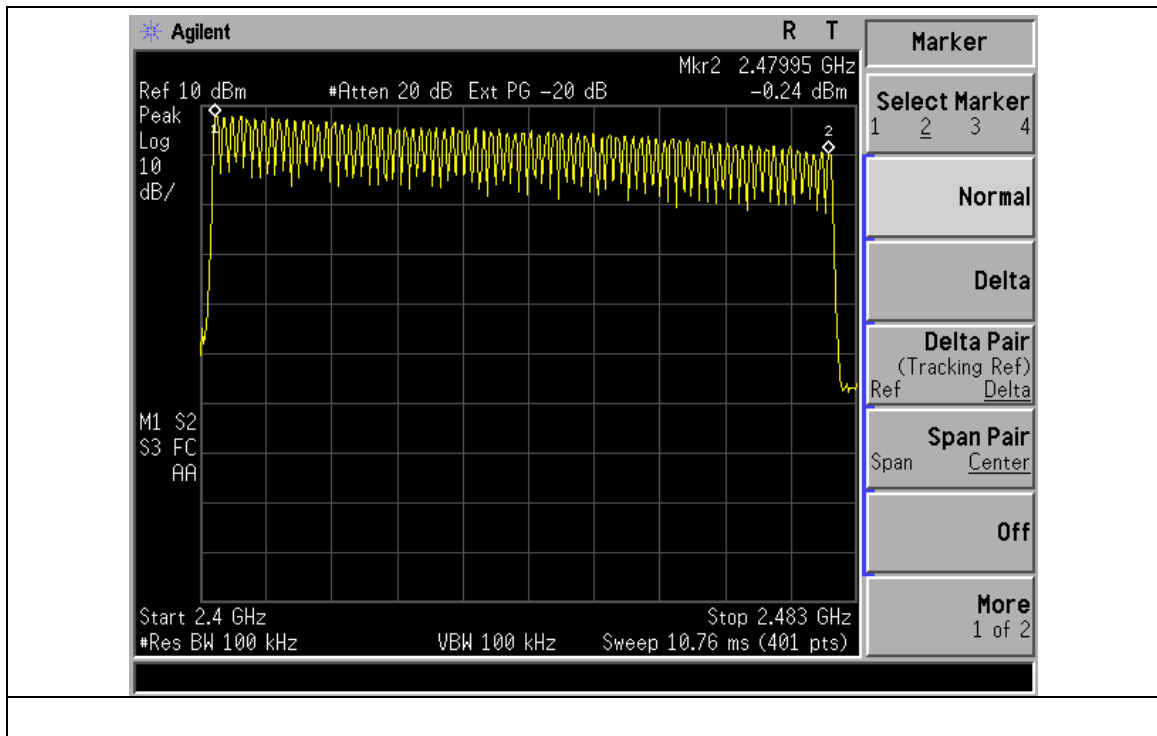



5. AVERAGE TIME OF OCCUPANCY

5.1 APPLIED PROCEDURES / LIMIT

FCC Part15 (15.247) , Subpart C				
Section	Test Item	Limit	Frequency Range (MHz)	Result
15.247 (a)(1)(iii)	Average Time of Occupancy	0.4sec	2400-2483.5	PASS

5.1.1 TEST PROCEDURE

- a. The transmitter output (antenna port) was connected to the spectrum analyzer
- b. Set RBW of spectrum analyzer to 1MHz and VBW to 1MHz.
- c. Use a video trigger with the trigger level set to enable triggering only on full pulses.
- d. Sweep Time is more than once pulse time.
- e. Set the center frequency on any frequency would be measure and set the frequency span to zero span.
- f. Measure the maximum time duration of one single pulse.
- g. Set the EUT for DH5, DH3 and DH1 packet transmitting.
- h. Measure the maximum time duration of one single pulse.
- i. A Period Time = (channel number)*0.4
DH1 Time Slot: Reading * (1600/2)*31.6/(channel number)
DH3 Time Slot: Reading * (1600/4)*31.6/(channel number)
DH5 Time Slot: Reading * (1600/6)*31.6/(channel number)

5.1.2 DEVIATION FROM STANDARD

No deviation.



5.1.3 TEST SETUP



5.1.4 EUT OPERATION CONDITIONS

The EUT tested system was configured as the statements of 2.4 Unless otherwise a special operating condition is specified in the follows during the testing.



5.1.5 TEST RESULTS

EUT :	INMOTION E-SCOOTER	Model Name :	L6
Temperature :	25 °C	Relative Humidity :	60%
Pressure :	1012 hPa	Test Voltage :	By Battery
Test Mode :	CH39-DH5, 2DH5, 3DH5		

Data Packet	Frequency	Pulse Duration (ms)	Dwell Time (s)	Limits (s)
DH5	2441 MHz	2.92	0.31	0.4
2DH5	2441 MHz	2.81	0.30	0.4
3DH5	2441 MHz	2.96	0.32	0.4

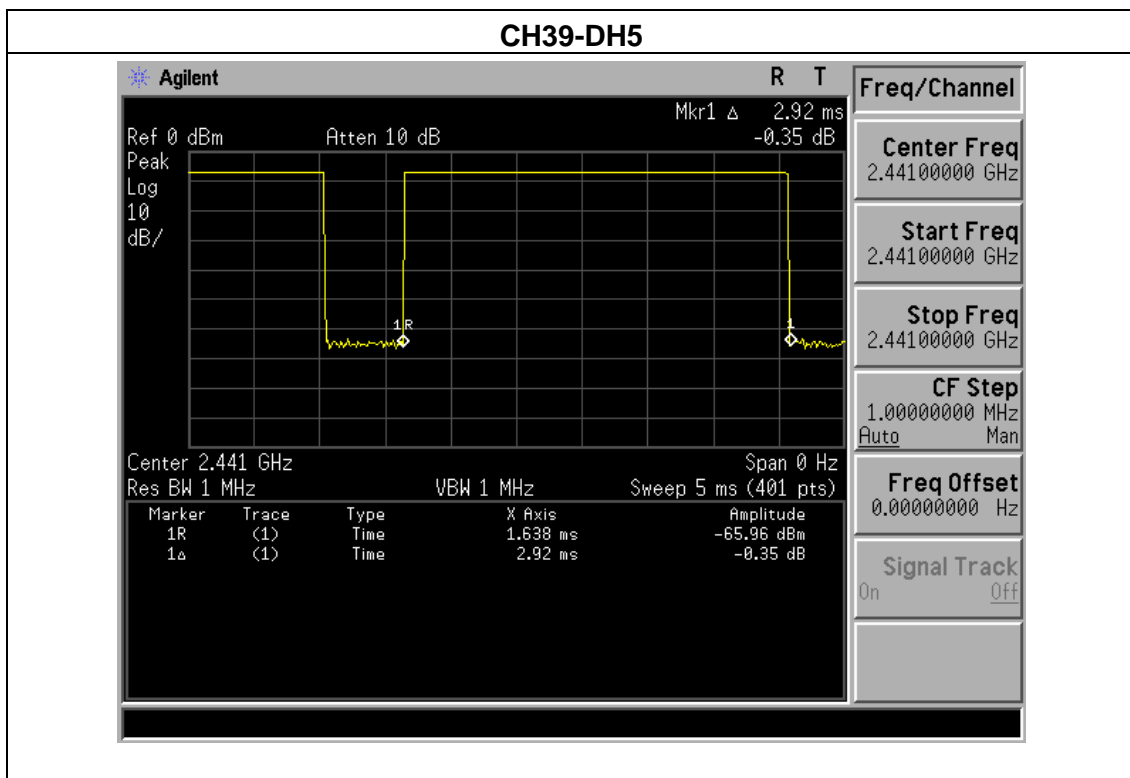

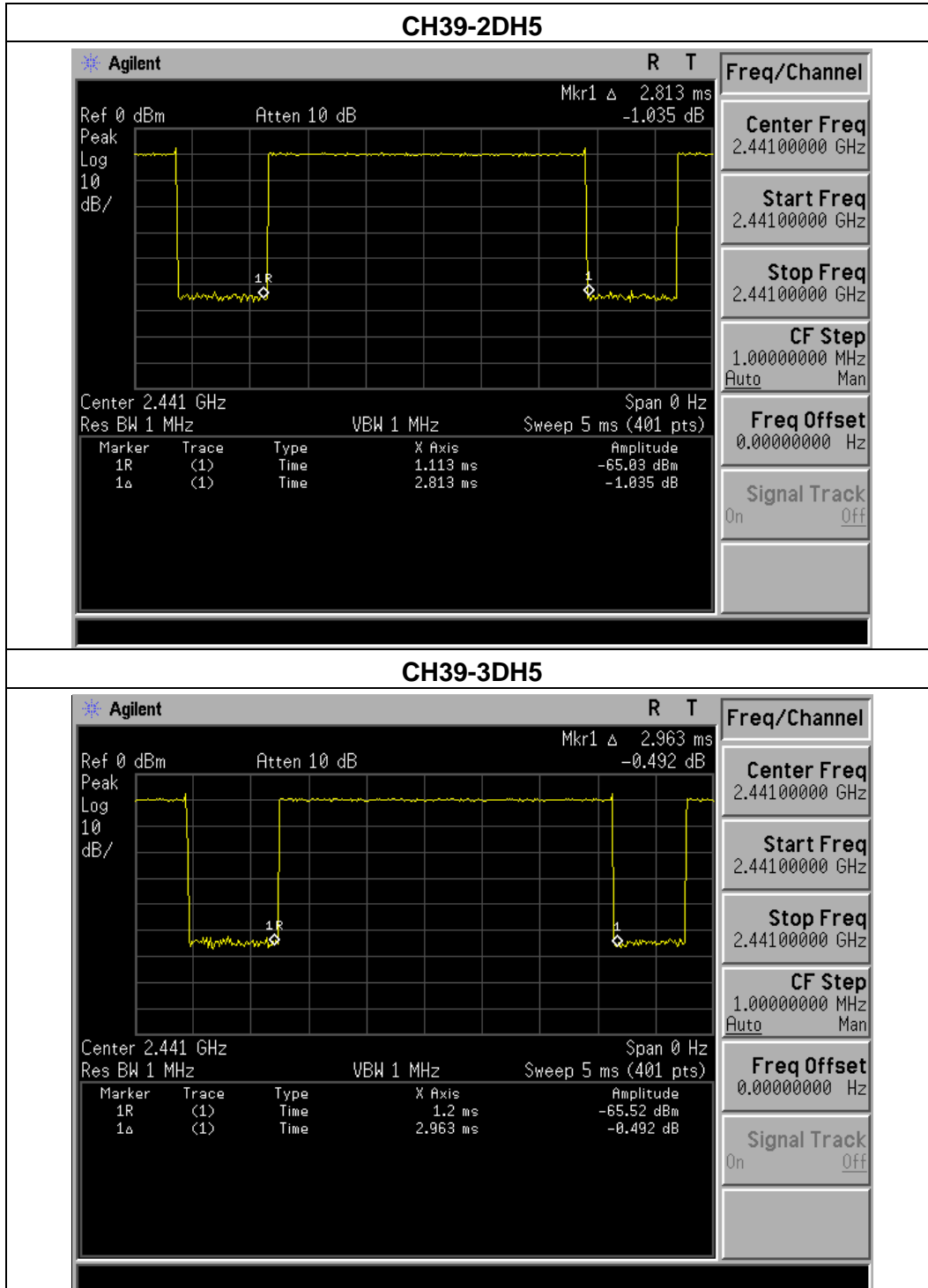



EUT :	INMOTION E-SCOOTER	Model Name :	L6
Temperature :	25 °C	Relative Humidity :	60%
Pressure :	1012 hPa	Test Voltage :	By Battery
Test Mode :	CH39-DH3, 2DH3, 3DH3		

Data Packet	Frequency	Pulse Duration (ms)	Dwell Time (s)	Limits (s)
DH3	2441 MHz	1.56	0.25	0.4
2DH3	2441 MHz	1.66	0.27	0.4
3DH3	2441 MHz	1.61	0.26	0.4

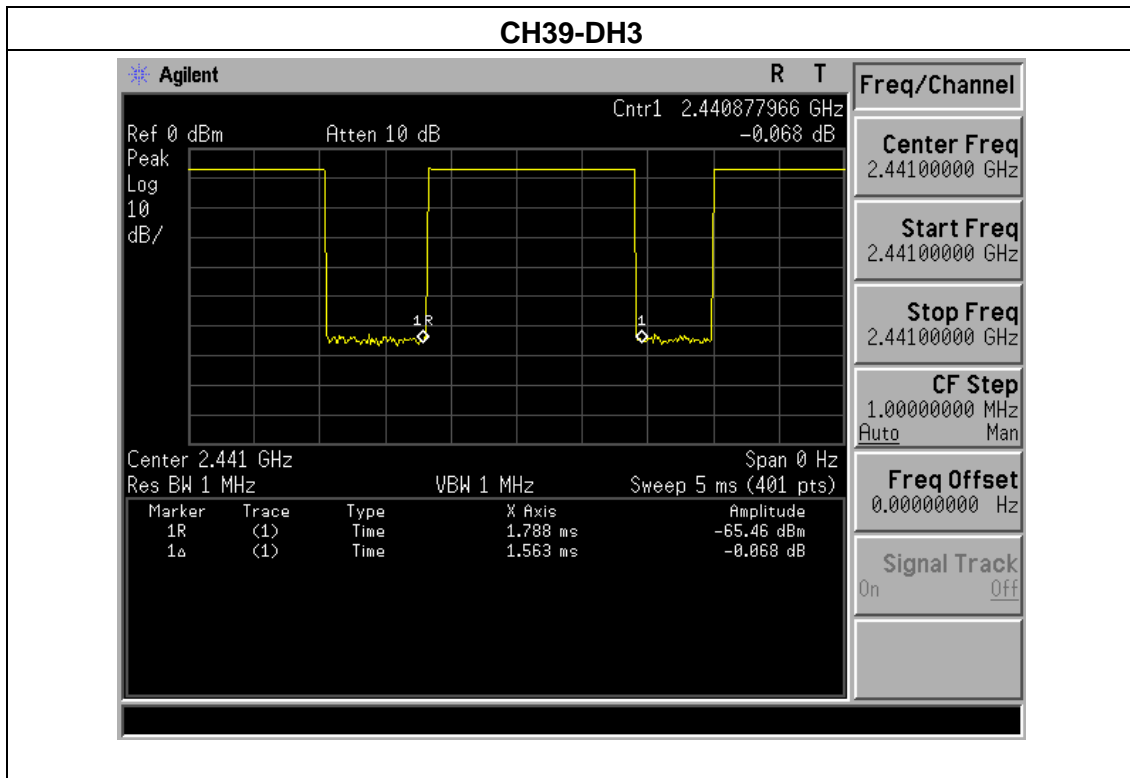

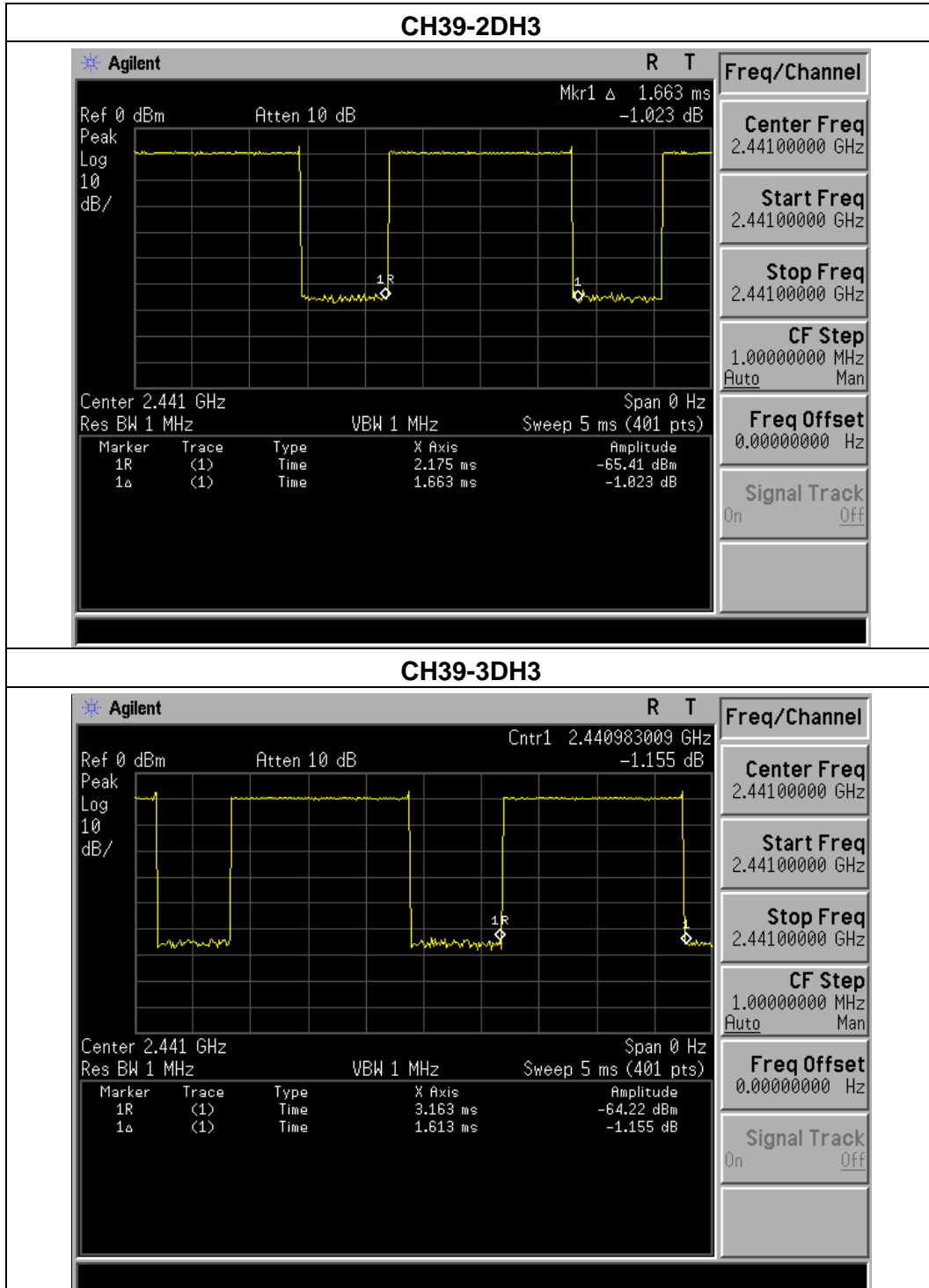



EUT :	INMOTION E-SCOOTER	Model Name :	L6
Temperature :	25 °C	Relative Humidity :	60%
Pressure :	1012 hPa	Test Voltage :	By Battery
Test Mode :	CH39-DH1, 2DH1, 3DH1		

Data Packet	Frequency	Pulse Duration (ms)	Dwell Time (s)	Limits (s)
DH1	2441 MHz	0.47	0.15	0.4
2DH1	2441 MHz	0.44	0.14	0.4
3DH1	2441 MHz	0.46	0.15	0.4

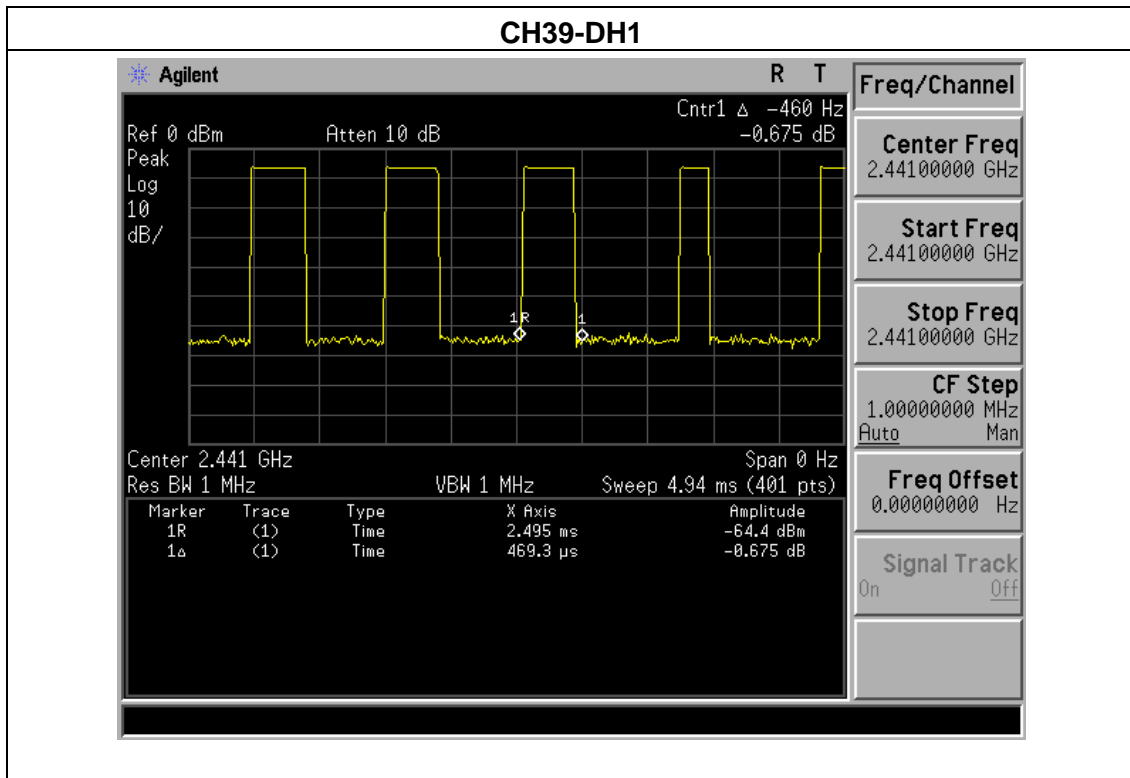

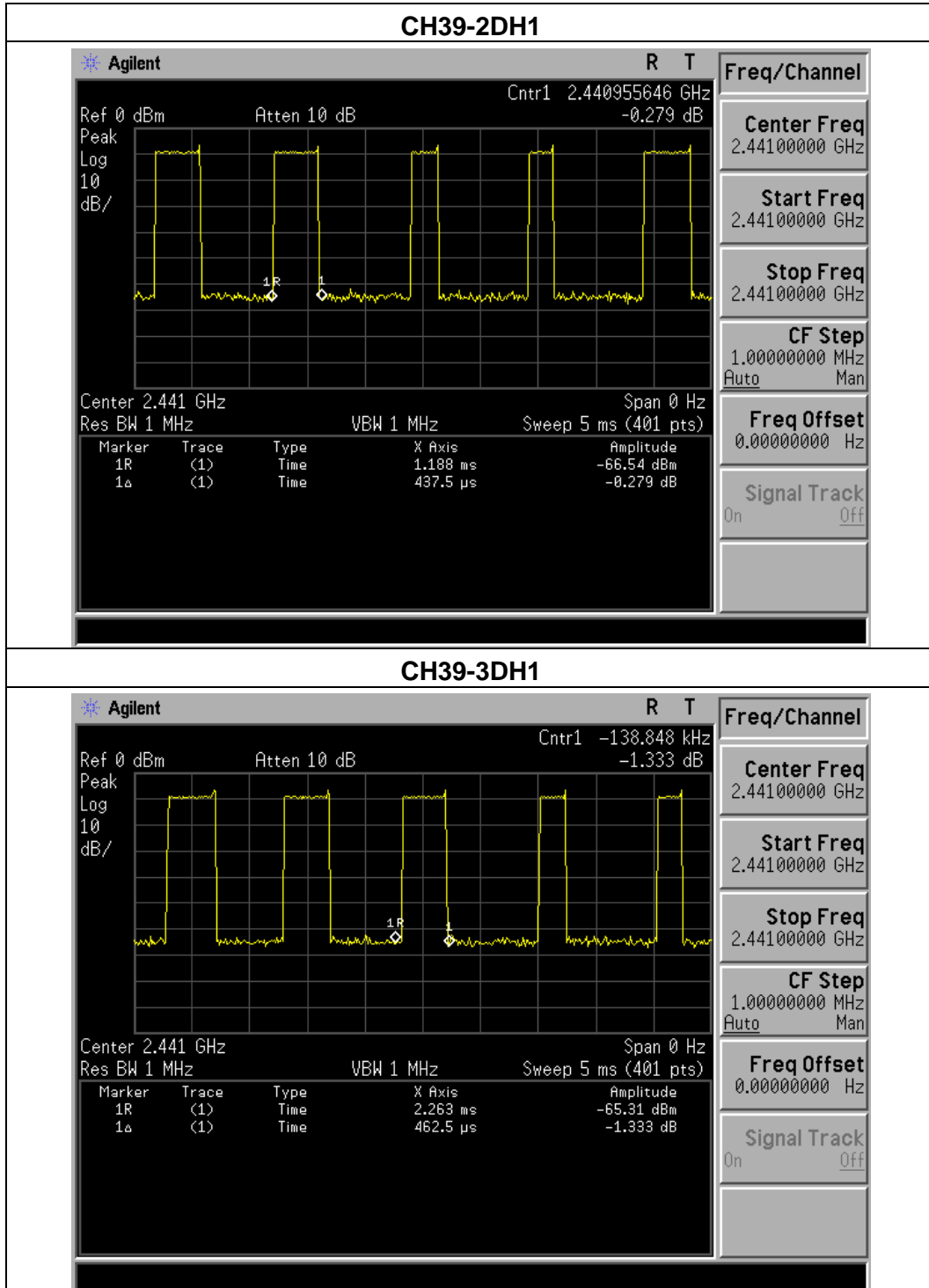



6. HOPPING CHANNEL SEPARATION MEASUREMENT

6.1 APPLIED PROCEDURES / LIMIT

Frequency hopping systems operating in the 2400-2483.5 MHz band may have hopping channel carrier frequencies that are separated by 25 kHz or two-thirds of the 20 dB bandwidth of the hopping channel, whichever is greater.

Spectrum Parameter	Setting
Attenuation	Auto
Span Frequency	> Measurement Bandwidth or Channel Separation
RB	100 kHz (Channel Separation)
VB	300 kHz (Channel Separation)
Detector	Peak
Trace	Max Hold
Sweep Time	Auto

6.1.1 TEST PROCEDURE

- The transmitter output (antenna port) was connected to the spectrum analyser in peak hold mode.
- The resolution bandwidth of 100 kHz and the video bandwidth of 300 kHz were utilised for channel separation measurement.

6.1.2 DEVIATION FROM STANDARD

No deviation.

6.1.3 TEST SETUP

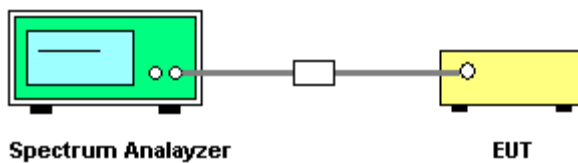

6.1.4 EUT OPERATION CONDITIONS

The EUT was programmed to be in continuously transmitting mode.



6.1.5 TEST RESULTS

EUT :	INMOTION E-SCOOTER	Model Name :	L6
Temperature :	25 °C	Relative Humidity :	60%
Pressure :	1012 hPa	Test Voltage :	By Battery
Test Mode :	CH00 / CH39 /CH78 (1Mbps Mode)		

Frequency	Ch. Separation (MHz)	Result
2402 MHz	1.01	Complies
2441 MHz	1.00	Complies
2480 MHz	1.00	Complies

Ch. Separation Limits: >2/3 20dB bandwidth

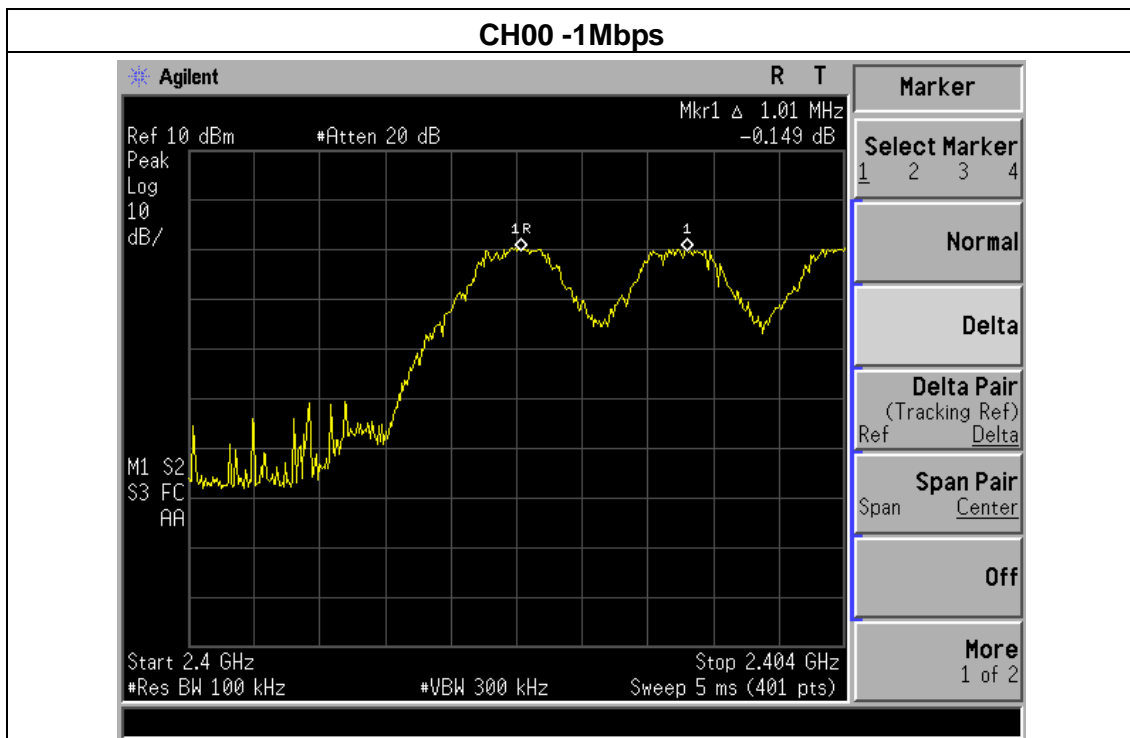

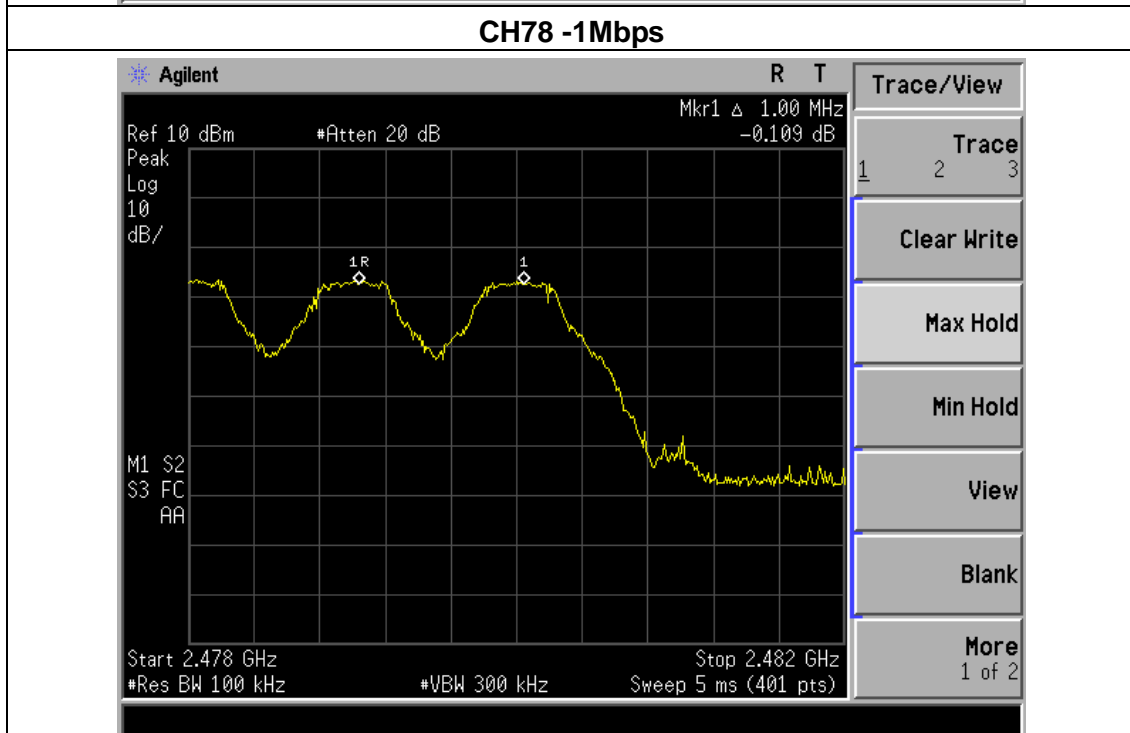
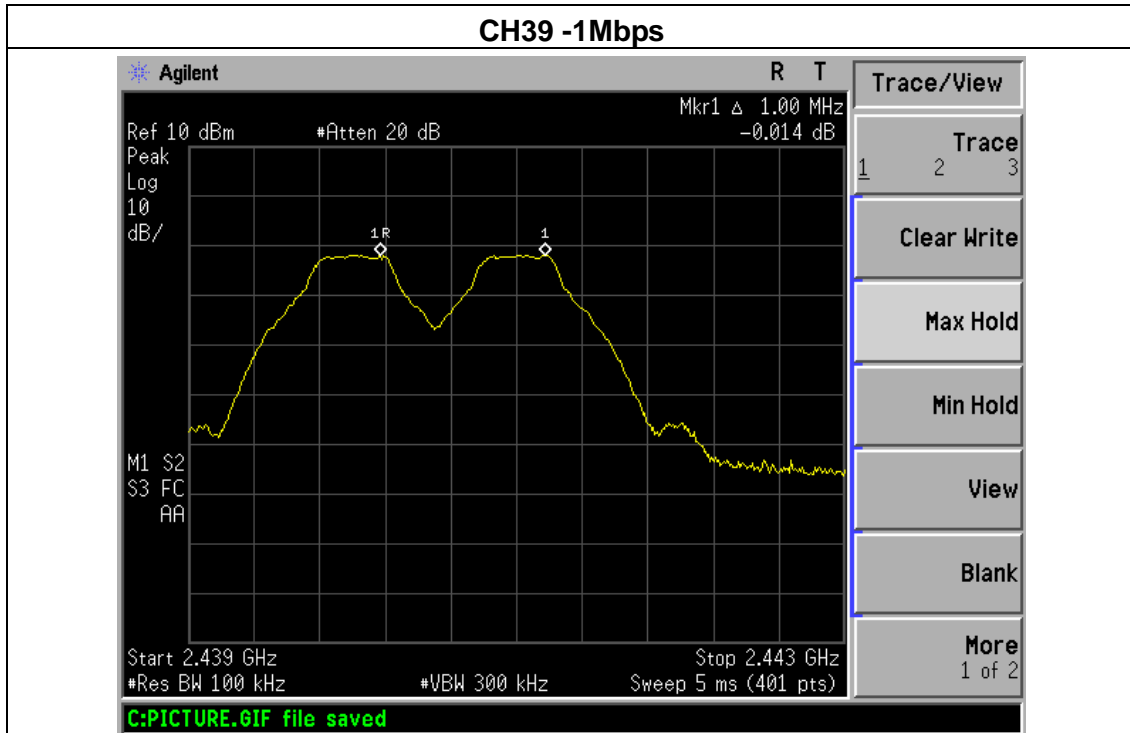



EUT :	INMOTION E-SCOOTER	Model Name :	L6
Temperature :	25 °C	Relative Humidity :	60%
Pressure :	1012 hPa	Test Voltage :	By Battery
Test Mode :	CH00 / CH39 /CH78 (2Mbps Mode)		

Frequency	Ch. Separation (MHz)	Result
2402 MHz	1.03	Complies
2441 MHz	1.01	Complies
2480 MHz	1.04	Complies

Ch. Separation Limits: >20dB bandwidth

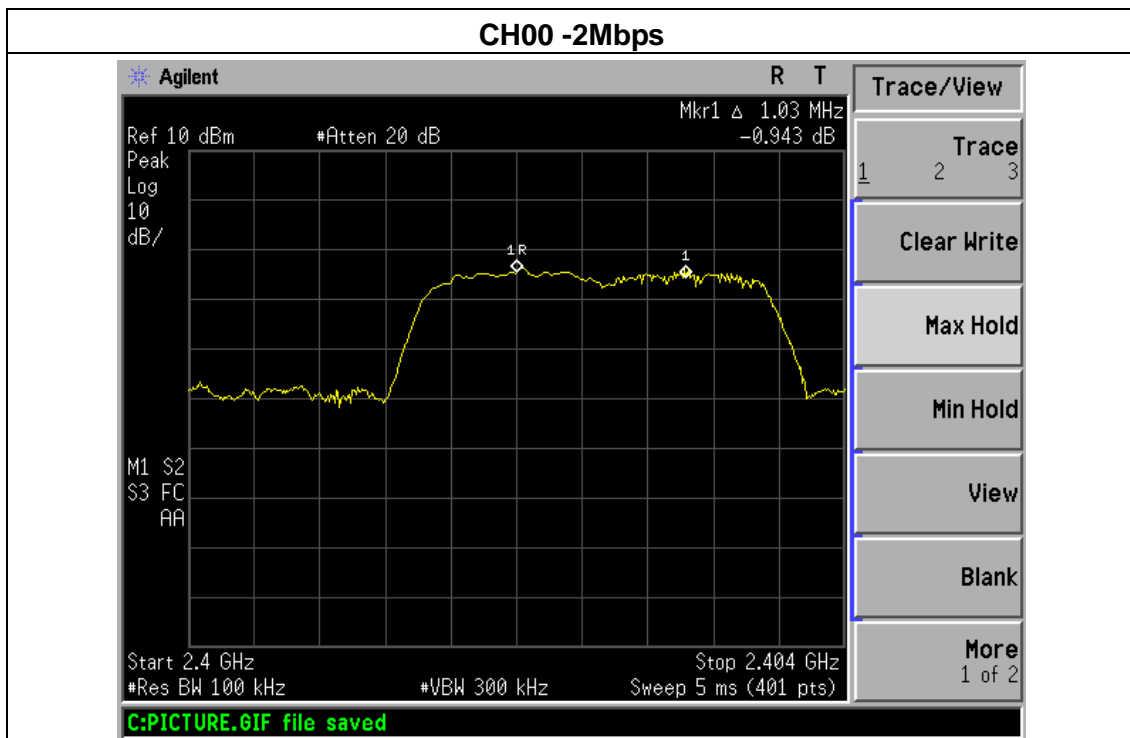

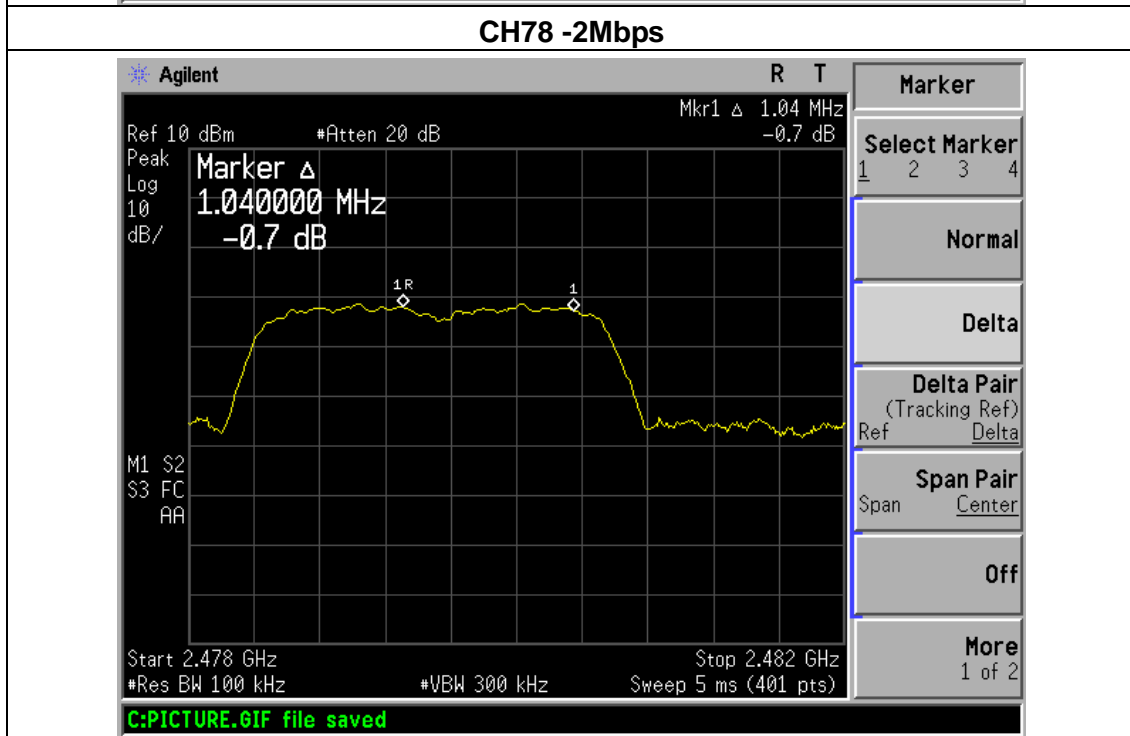
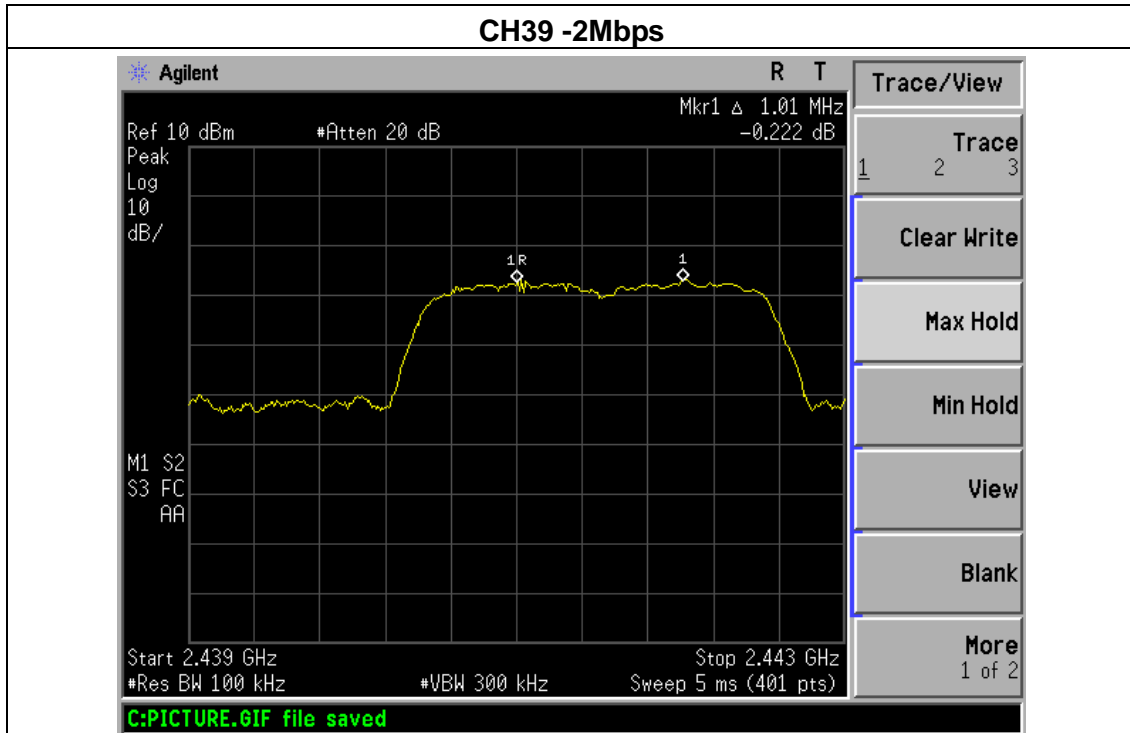



EUT :	INMOTION E-SCOOTER	Model Name :	L6
Temperature :	25 °C	Relative Humidity :	60%
Pressure :	1012 hPa	Test Voltage :	By Battery
Test Mode :	CH00 / CH39 /CH78 (3Mbps Mode)		

Frequency	Ch. Separation (MHz)	Result
2402 MHz	1.03	Complies
2441 MHz	1.01	Complies
2480 MHz	1.04	Complies

Ch. Separation Limits: >20dB bandwidth

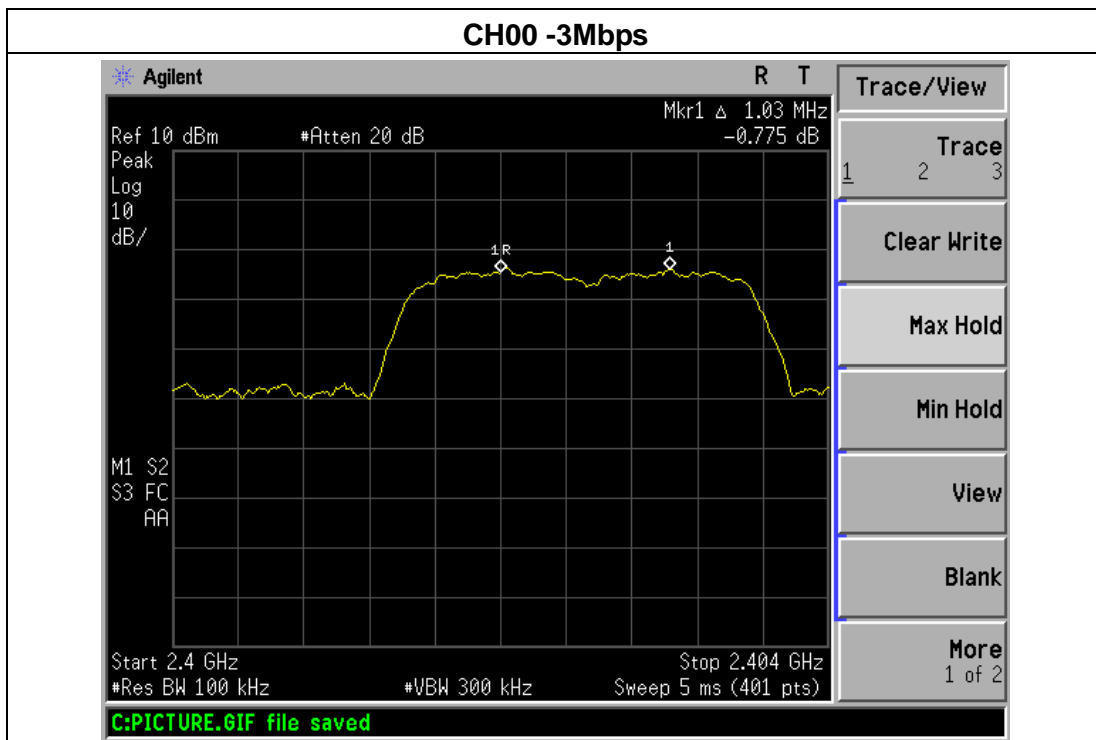

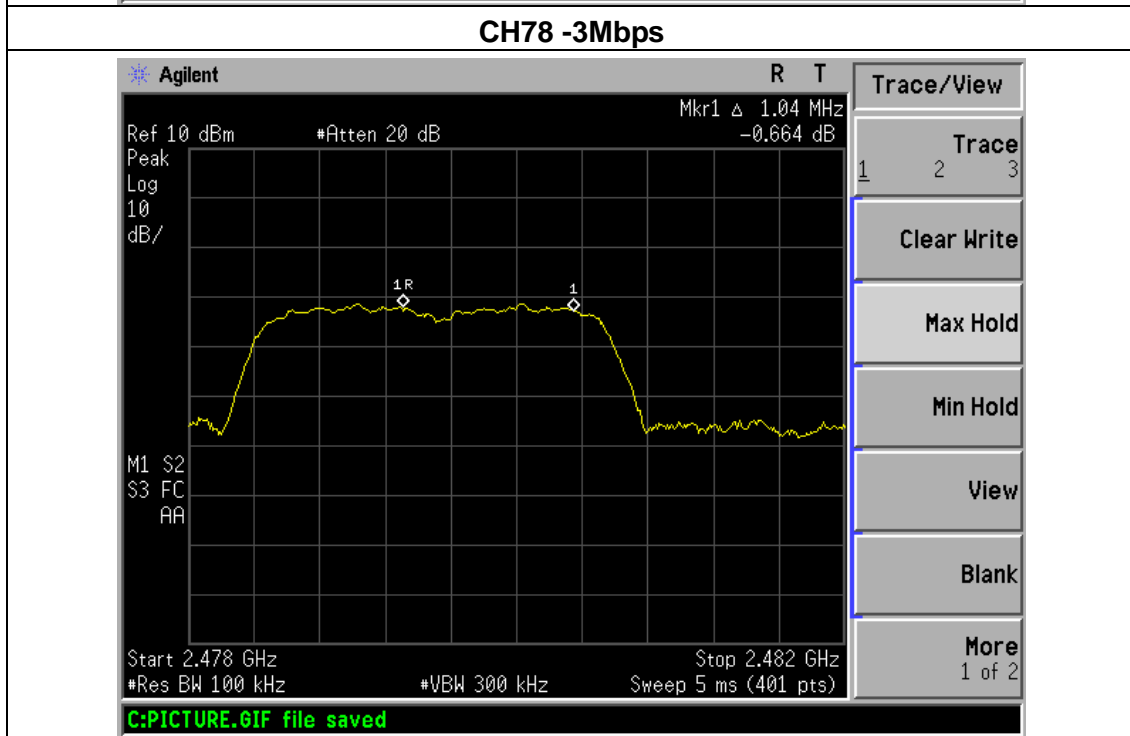
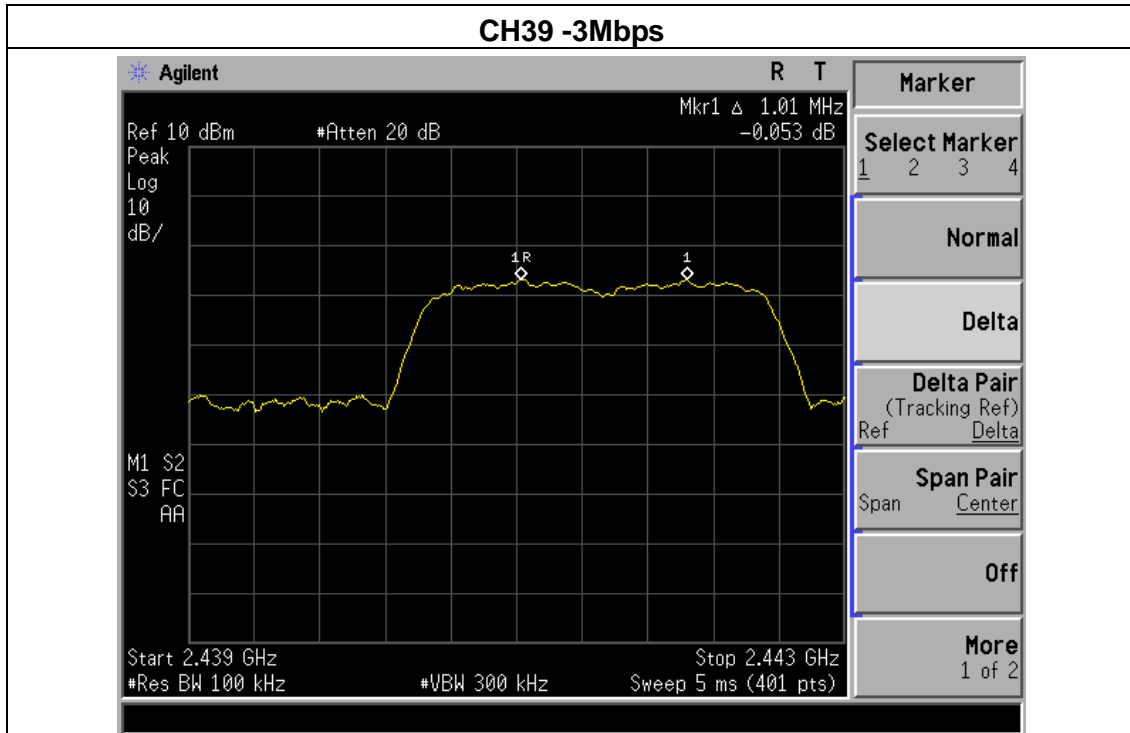



7. BANDWIDTH TEST

7.1 APPLIED PROCEDURES / LIMIT

FCC Part15 (15.247) , Subpart C				
Section	Test Item	Limit	Frequency Range (MHz)	Result
15.247 (a)(1)	Bandwidth	(20dB bandwidth)	2400-2483.5	PASS

Spectrum Parameter	Setting
Attenuation	Auto
Span Frequency	> Measurement Bandwidth or Channel Separation
RB	1% of the 20 dB bandwidth
VB	\geq RBW
Detector	Peak
Trace	Max Hold
Sweep Time	Auto

7.1.1 TEST PROCEDURE

- a. The EUT was directly connected to the spectrum analyzer and antenna output port as show in the block diagram below,
- b. Spectrum Setting : RBW= 1% of the 20 dB bandwidth, VBW \geq RBW, Sweep time = Auto.

7.1.2 DEVIATION FROM STANDARD

No deviation.

7.1.3 TEST SETUP



7.1.4 EUT OPERATION CONDITIONS

The EUT tested system was configured as the statements of 2.4 Unless otherwise a special operating condition is specified in the follows during the testing.



7.1.5 TEST RESULTS

EUT :	INMOTION E-SCOOTER	Model Name :	L6
Temperature :	25 °C	Relative Humidity :	60%
Pressure :	1012 hPa	Test Voltage :	By Battery
Test Mode :	CH00 / CH39 / C78(1Mbps)		

Frequency	20dB Bandwidth (kHz)	Result
2402 MHz	889.229	PASS
2441 MHz	922.176	PASS
2480 MHz	945.530	PASS

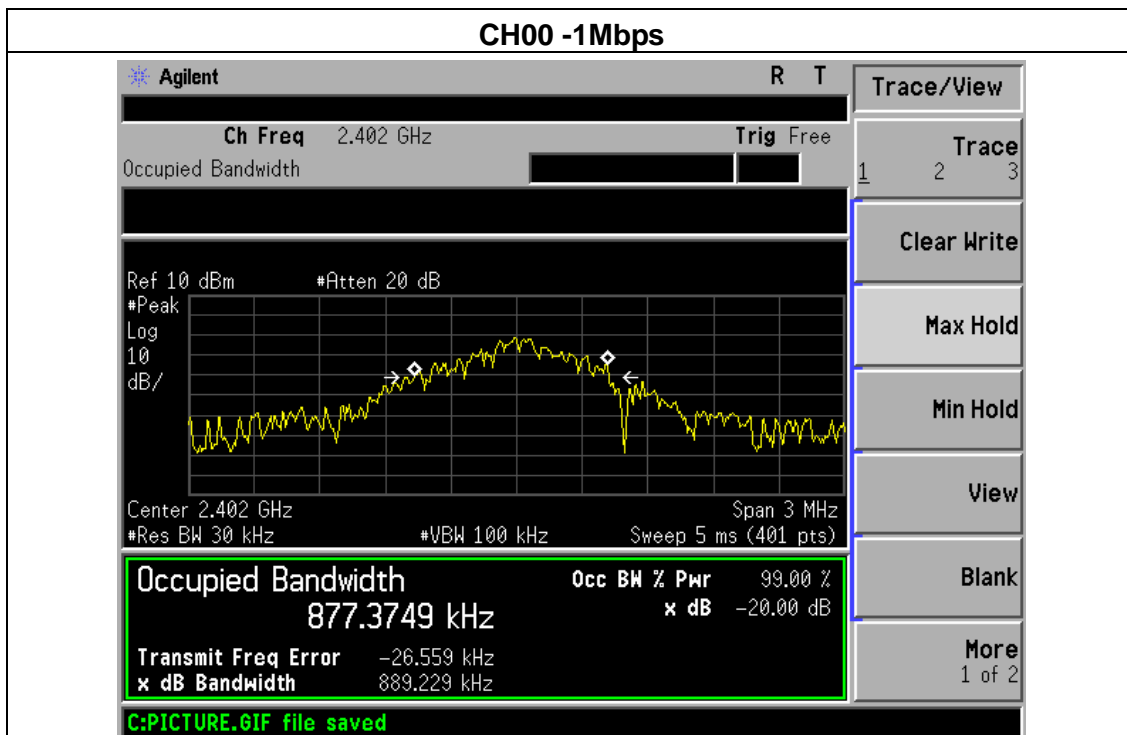

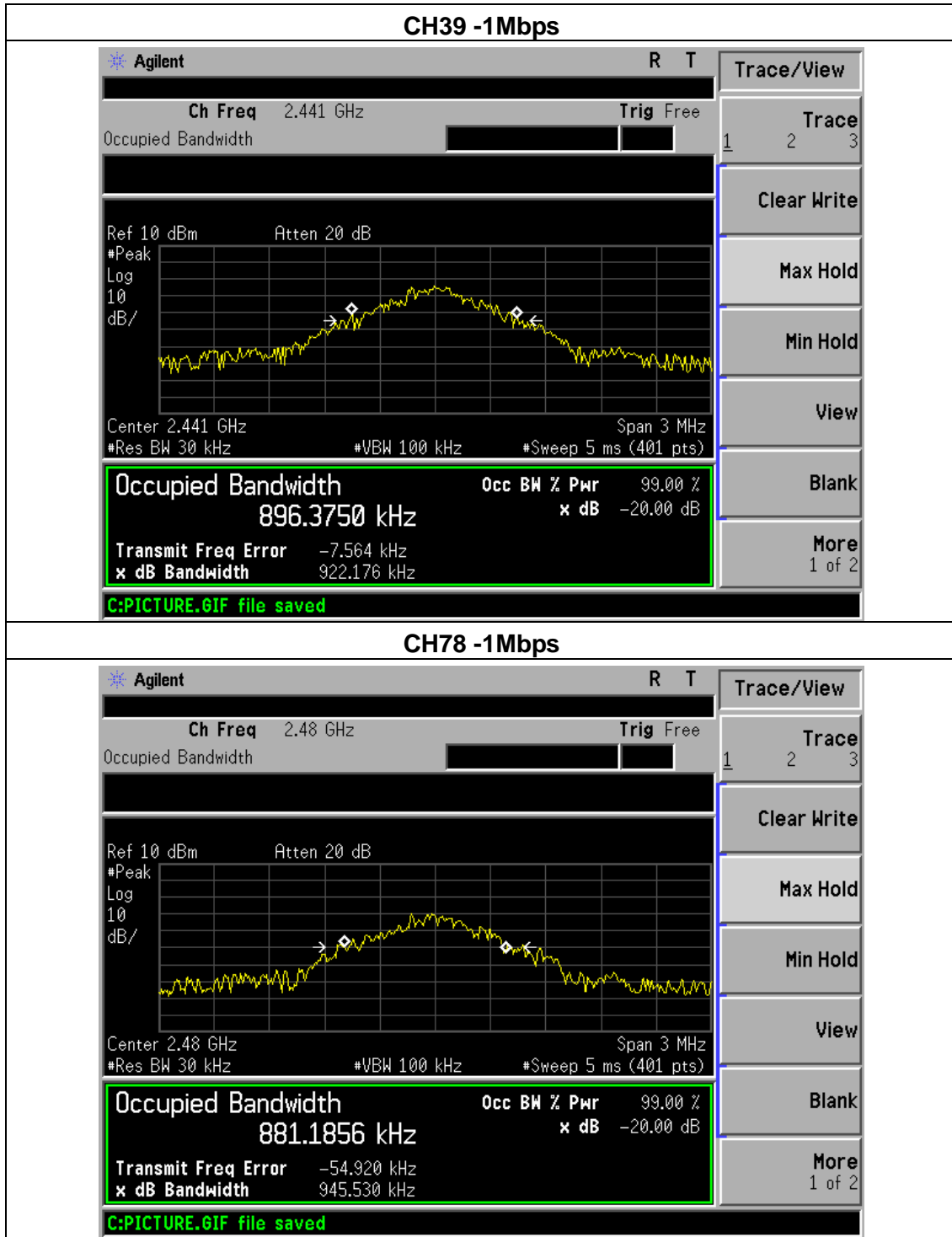



EUT :	INMOTION E-SCOOTER	Model Name :	L6
Temperature :	25 °C	Relative Humidity :	60%
Pressure :	1012 hPa	Test Voltage :	By Battery
Test Mode :	CH00 / CH39 /C78(2Mbps)		

Frequency	20dB Bandwidth (MHz)	Result
2402 MHz	1.327	PASS
2441 MHz	1.329	PASS
2480 MHz	1.316	PASS

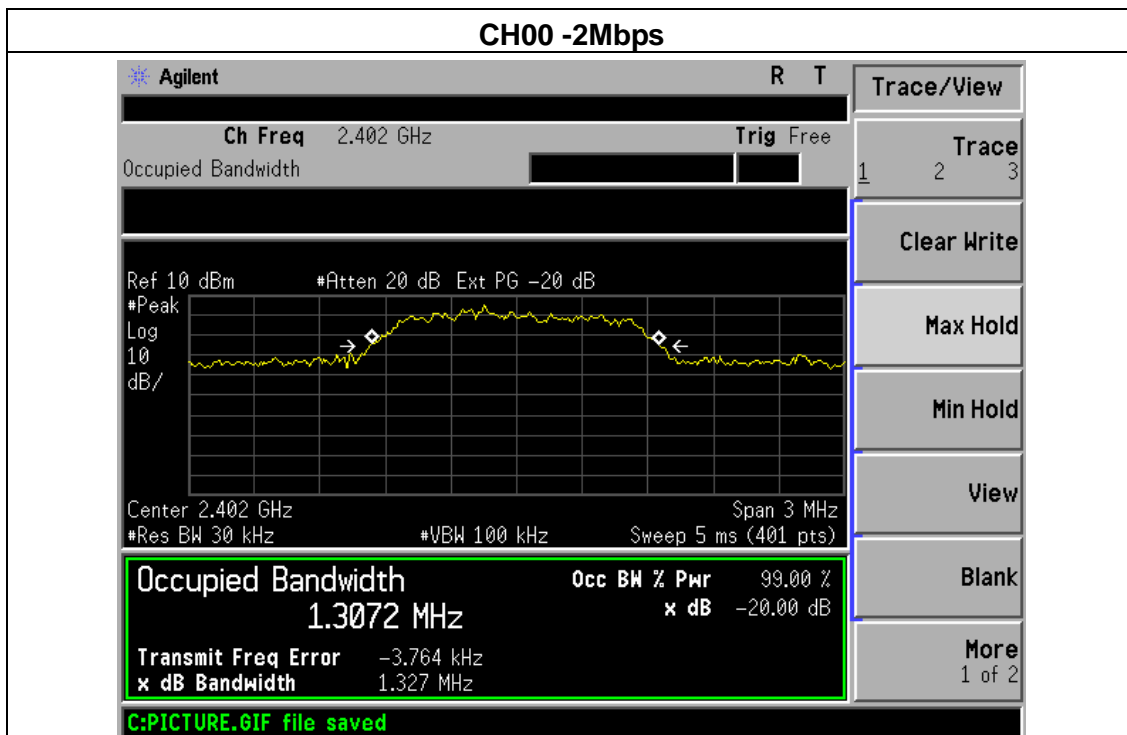

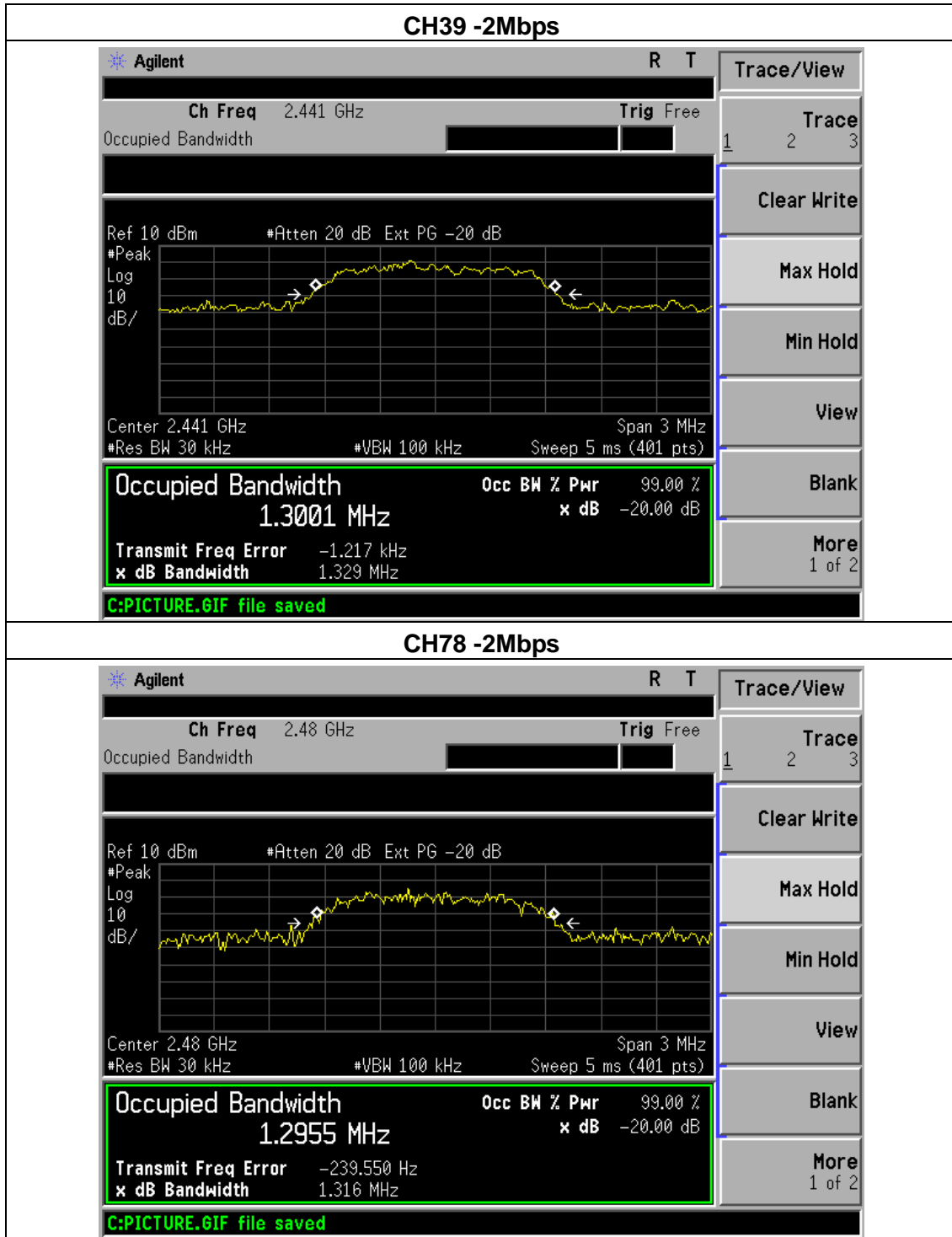



EUT :	INMOTION E-SCOOTER	Model Name :	L6
Temperature :	25 °C	Relative Humidity :	60%
Pressure :	1012 hPa	Test Voltage :	By Battery
Test Mode :	CH00 / CH39 /C78(3Mbps)		

Frequency	20dB Bandwidth (MHz)	Result
2402 MHz	1.318	PASS
2441 MHz	1.323	PASS
2480 MHz	1.313	PASS

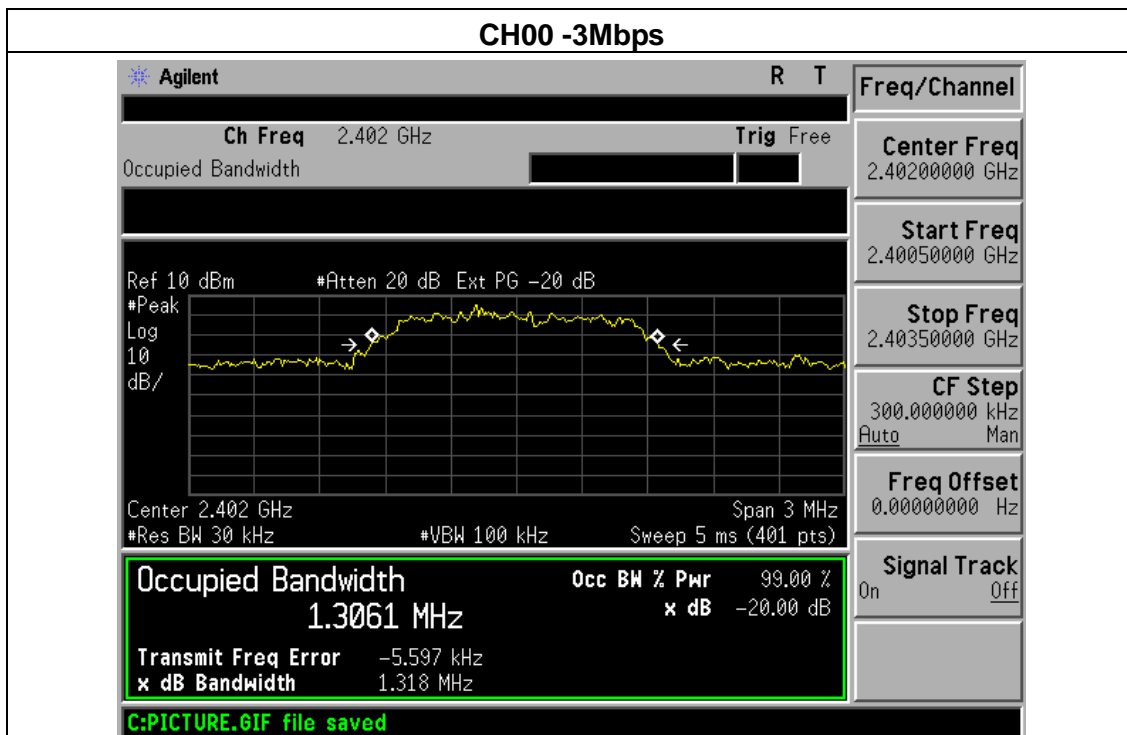

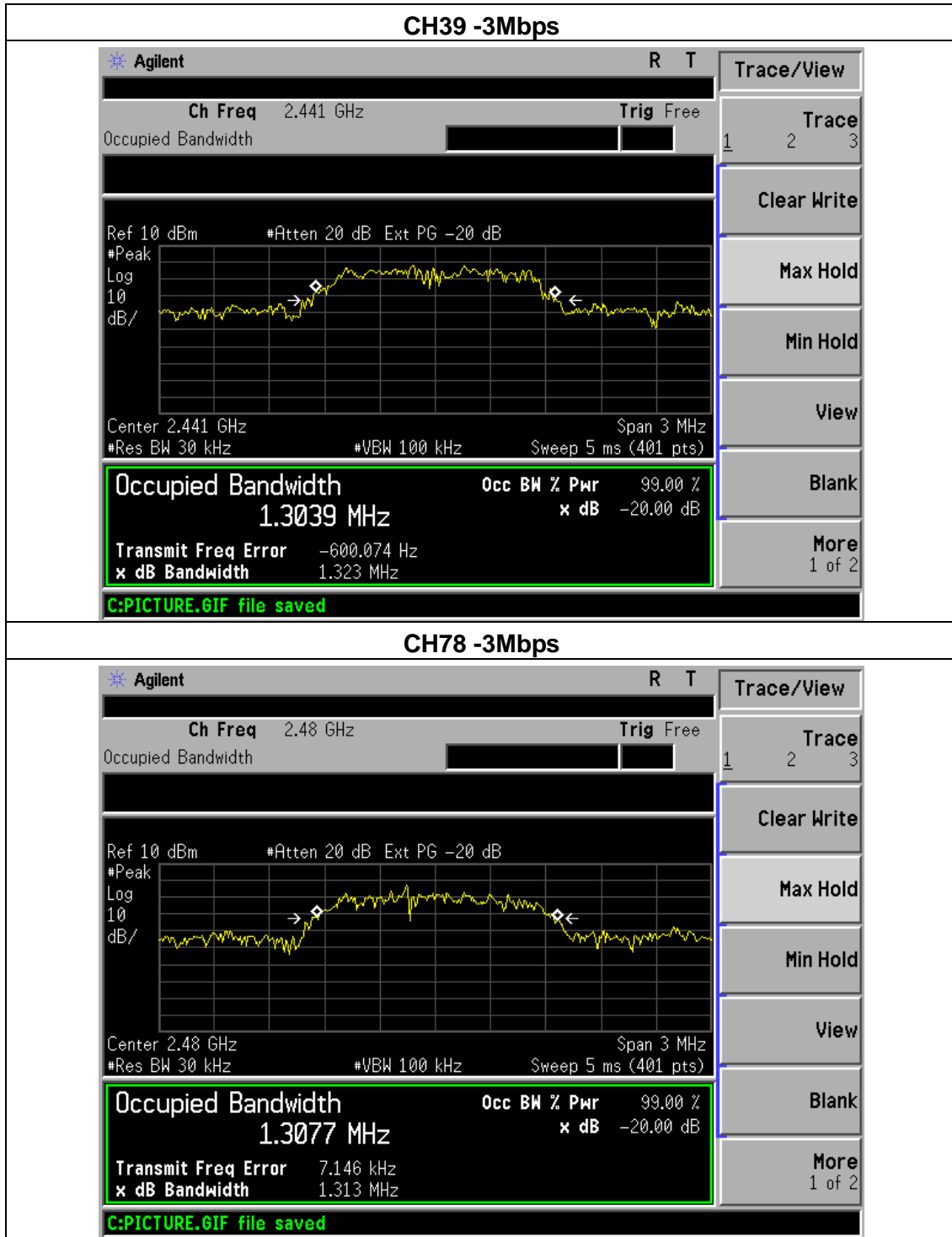



8. PEAK OUTPUT POWER TEST

8.1 APPLIED PROCEDURES / LIMIT

FCC Part15 (15.247) , Subpart C				
Section	Test Item	Limit	Frequency Range (MHz)	Result
15.247 (b)(i)	Peak Output Power	30Bm or 20.96dBm	2400-2483.5	PASS

8.1.1 TEST PROCEDURE

- a. The EUT was directly connected to the spectrum analyzer and antenna output port as show in the block diagram below,
- b. Spectrum Setting : RBW > the 20 dB bandwidth of the emission being measured
Span = approximately 5 times the 20 dB bandwidth, centered on a hopping channel
VBW \geq RBW
Sweep = auto
Detector function = peak
Trace = max hold

8.1.2 DEVIATION FROM STANDARD

No deviation.

8.1.3 TEST SETUP



8.1.4 EUT OPERATION CONDITIONS

The EUT tested system was configured as the statements of 2.4 Unless otherwise a special operating condition is specified in the follows during the testing.

**8.1.5 TEST RESULTS**

EUT :	INMOTION E-SCOOTER	Model Name :	L6
Temperature :	25 °C	Relative Humidity :	60%
Pressure :	1012 hPa	Test Voltage :	By Battery
Test Mode :	CH00/ CH39 /CH78 (1M/2M/3Mbps Mode)		

1Mbps			
Test Channel	Frequency (MHz)	Peak Output Power (dBm)	LIMIT (dBm)
CH00	2402	1.689	30.00
CH39	2441	0.464	30.00
CH78	2480	0.585	30.00
2Mbps			
CH00	2402	0.885	20.96
CH39	2441	0.461	20.96
CH78	2480	-0.157	20.96
3Mbps			
CH00	2402	0.871	20.96
CH39	2441	0.417	20.96
CH78	2480	0.255	20.96

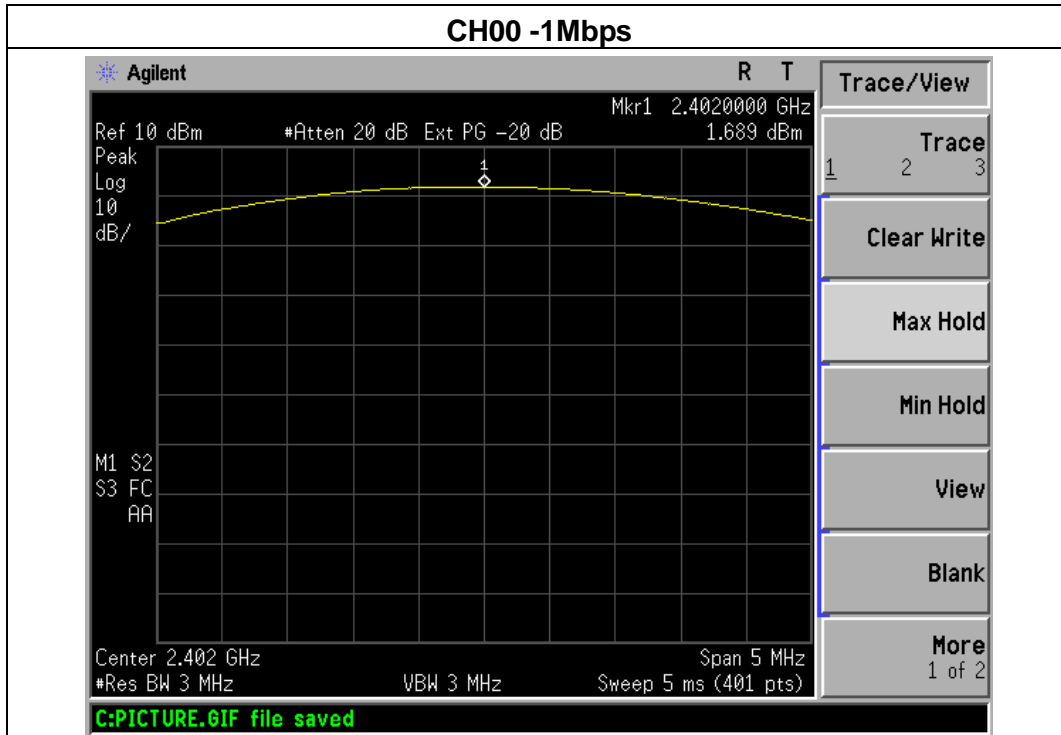

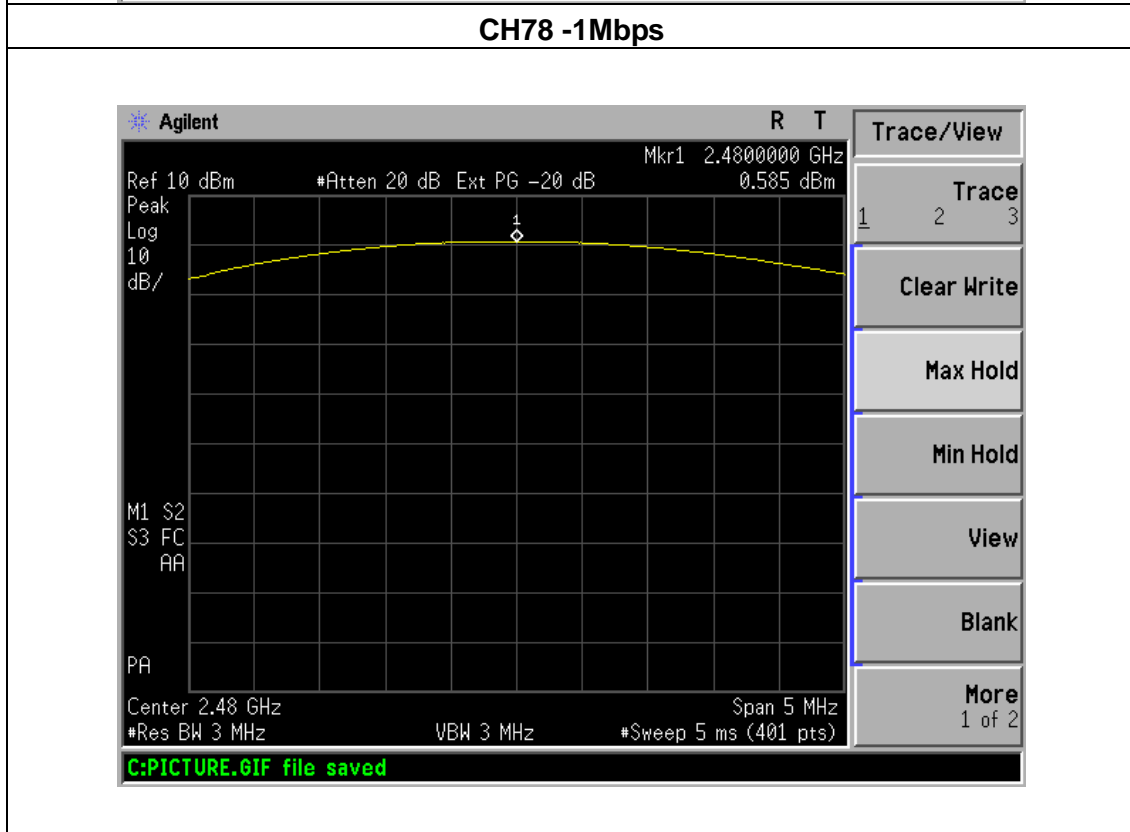
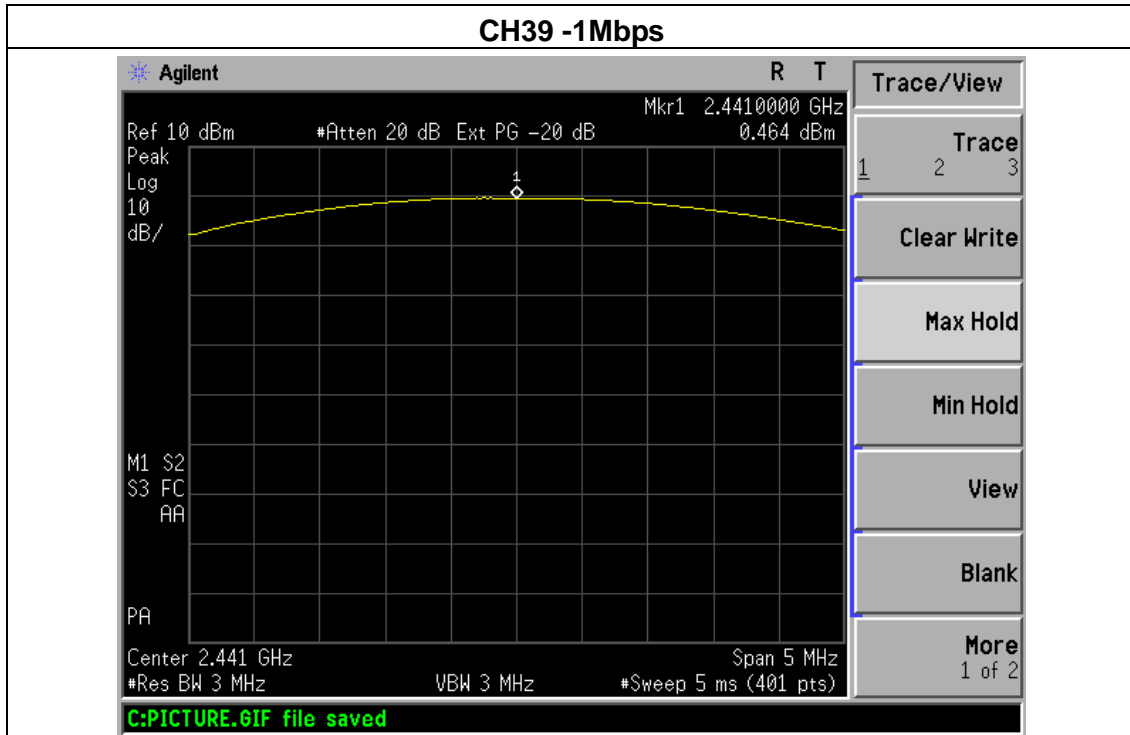

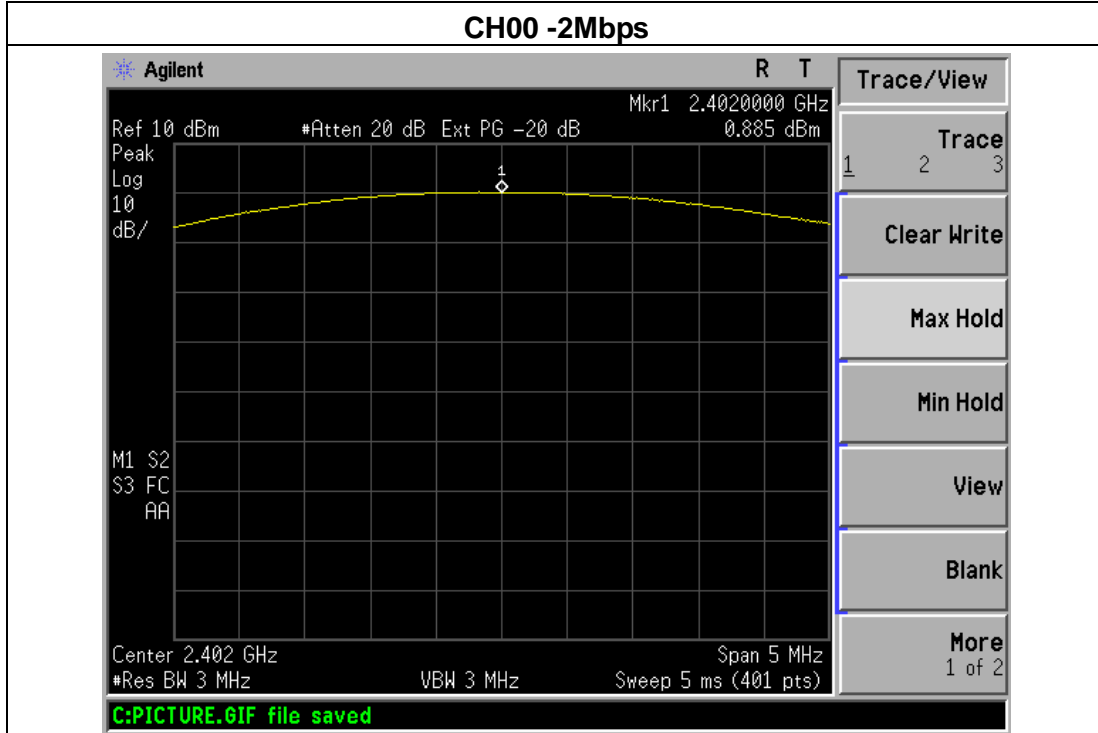

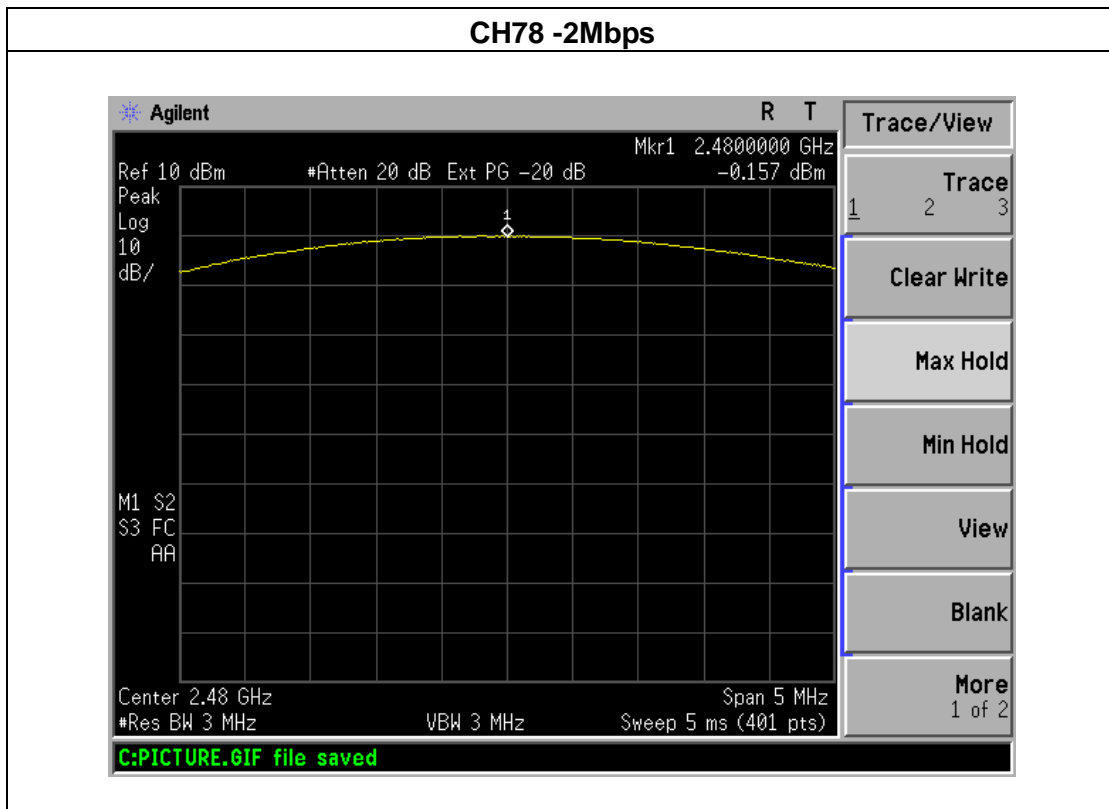
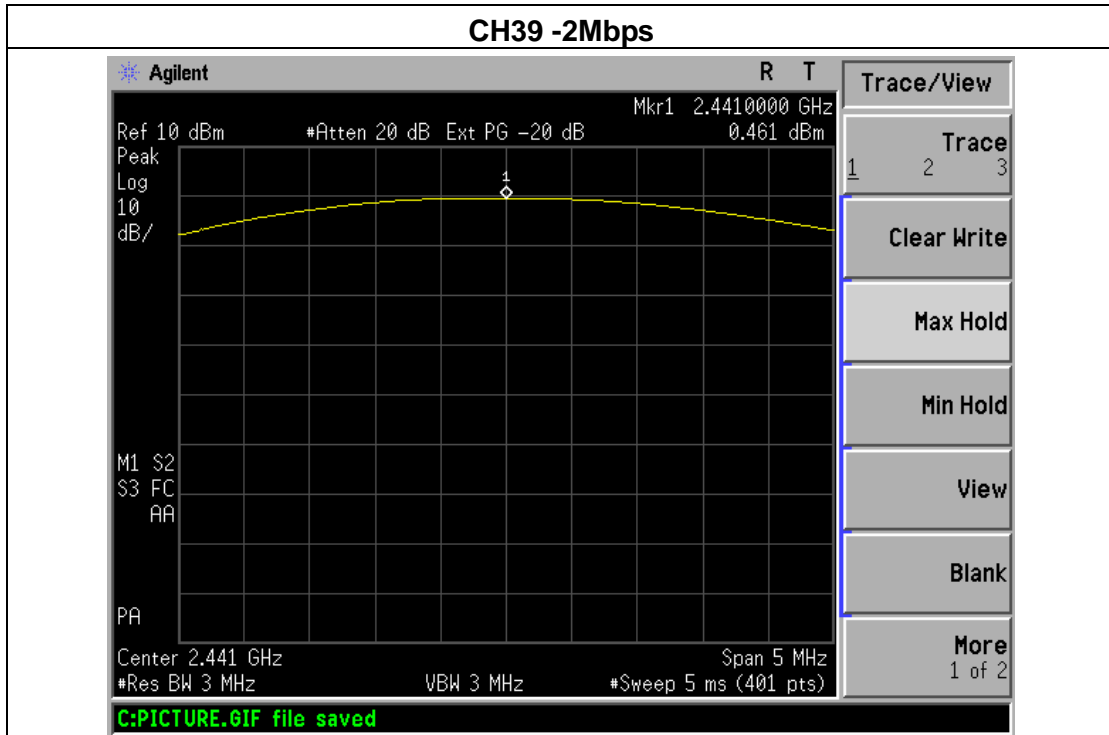

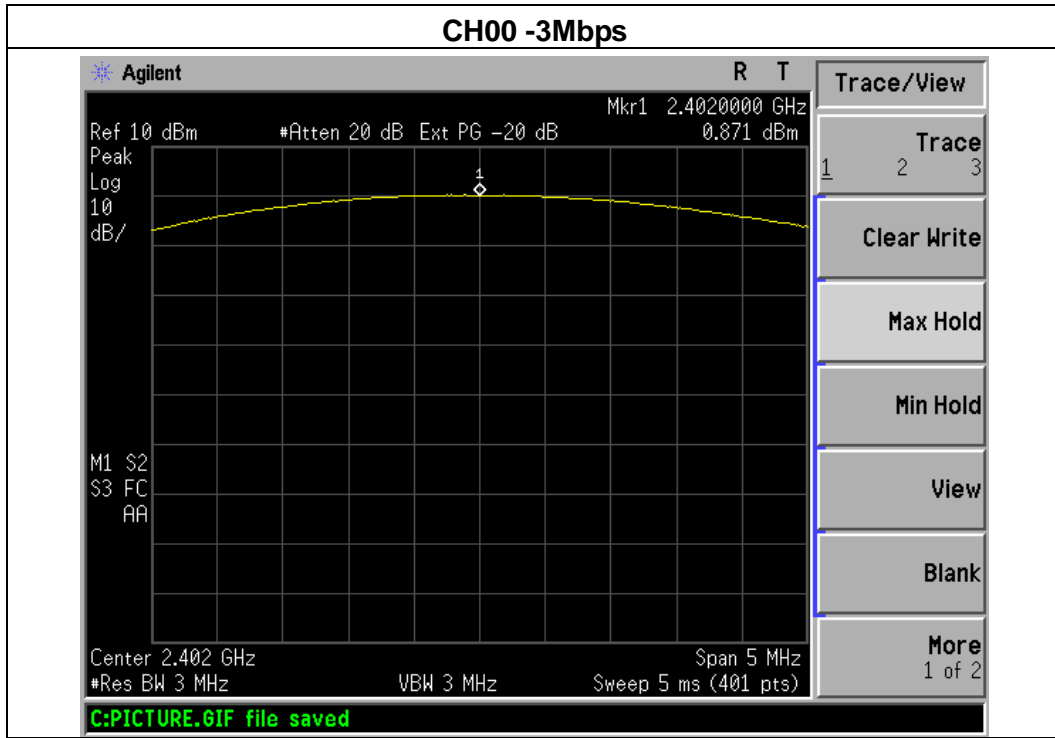

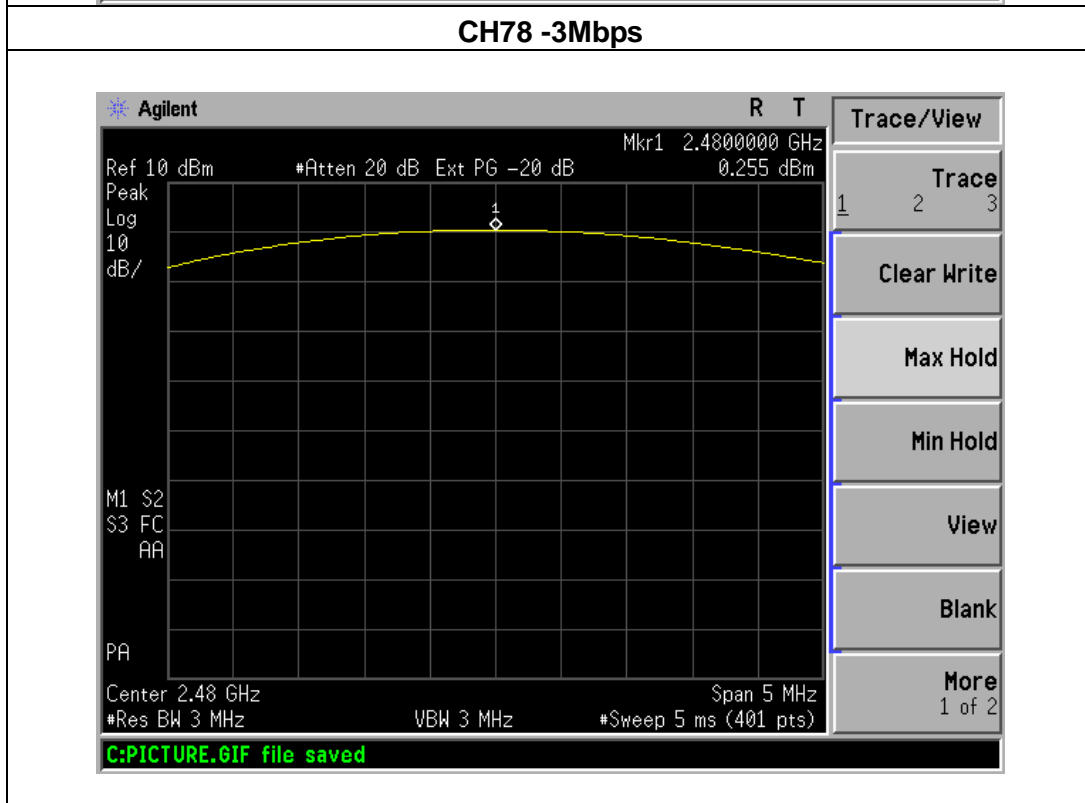
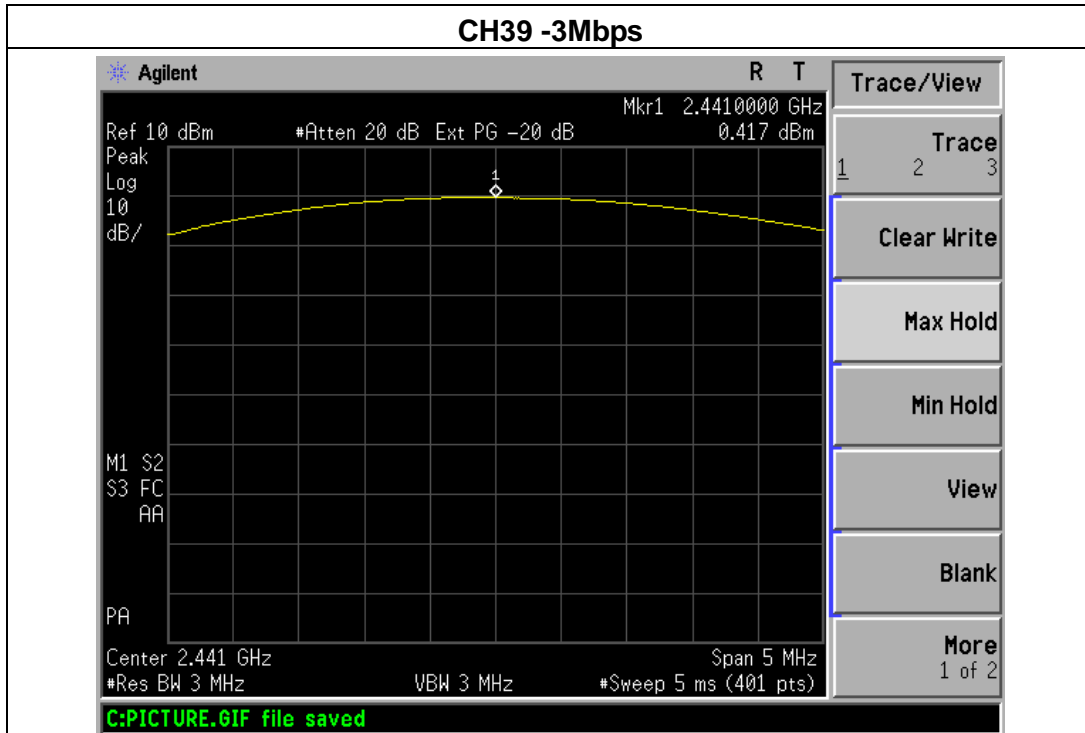



9. 100 KHZ BANDWIDTH OF FREQUENCY BAND EDGE

APPLICABLE STANDARD

In any 100 kHz bandwidth outside the frequency band in which the spread spectrum or digitally modulated intentional radiator is operating, the radio frequency power that is produced by the intentional radiator shall be at least 20 dB below that in the 100 kHz bandwidth within the band that contains the highest level of the desired power, based on either an RF conducted or a radiated measurement, provided the transmitter demonstrates compliance with the peak conducted power limits. If the transmitter complies with the conducted power limits based on the use of RMS averaging over a time interval, as permitted under paragraph (b)(3) of this section, the attenuation required under this paragraph shall be 30 dB instead of 20 dB. Attenuation below the general limits specified in §15.209(a) is not required. In addition, radiated emissions which fall in the restricted bands, as defined in §15.205(a), must also comply with the radiated emission limits specified in §15.209(a) (see §15.205(c)).

TEST PROCEDURE

- a) Check the calibration of the measuring instrument using either an internal calibrator or a known signal from an external generator.
- b) Position the EUT without connection to measurement instrument. Turn on the EUT and connect its antenna terminal to measurement instrument via a low loss cable. Then set it to any one measured frequency within its operating range, and make sure the instrument is operated in its linear range.
- c) Set RBW to 100 kHz and VBW of spectrum analyzer to 300 kHz with a convenient frequency span including 100 kHz bandwidth from band edge.
- d) Measure the highest amplitude appearing on spectral display and set it as a reference level. Plot the graph with marking the highest point and edge frequency.
- e) Repeat above procedures until all measured frequencies were complete.

9.1 DEVIATION FROM STANDARD

No deviation.



9.2 TEST SETUP



9.3 EUT OPERATION CONDITIONS

The EUT tested system was configured as the statements of 2.4 Unless otherwise a special operating condition is specified in the follows during the testing.



9.4 TEST RESULTS

EUT :	INMOTION E-SCOOTER	Model Name :	L6
Temperature :	25 °C	Relative Humidity :	60%
Pressure :	1012 hPa	Test Voltage :	By Battery
Test Mode :	CH00/ CH78 (1M/2M/3Mbps Mode)		

Frequency Band	Delta Peak to band emission (dBc)	> Limit (dBc)	Result
BDR mode (GFSK)			
Left-band	54.90	20	Pass
Right-band	49.88	20	Pass
EDR mode ($\pi/4$ -DQPSK)			
Left-band	55.64	20	Pass
Right-band	54.29	20	Pass
EDR mode(8DPSK)			
Left-band	56.06	20	Pass
Right-band	54.17	20	Pass



BDR mode (GFSK): Band Edge-Left Side

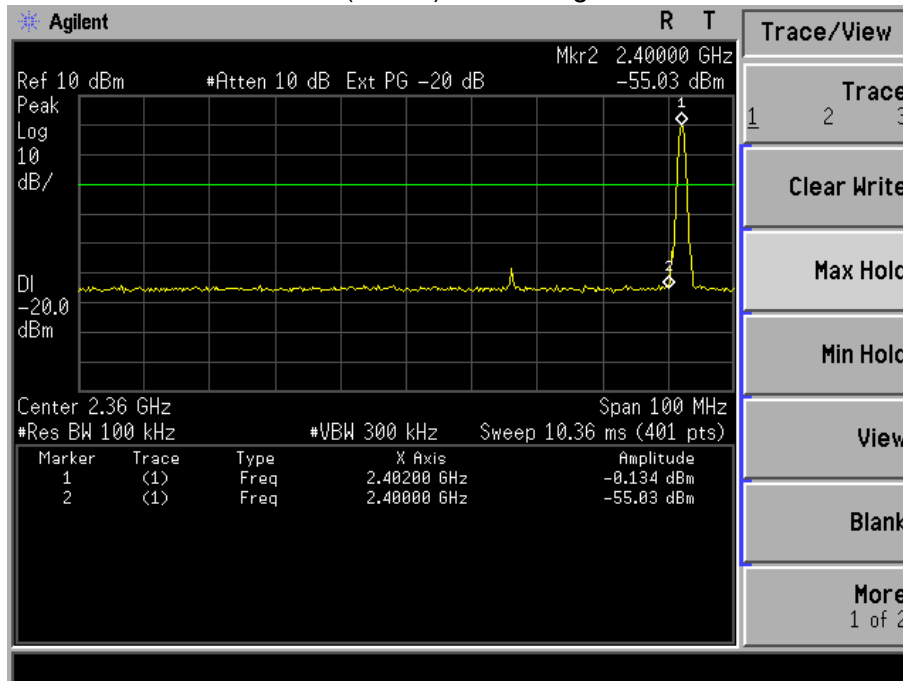

BDR mode (GFSK): Band Edge-Right Side

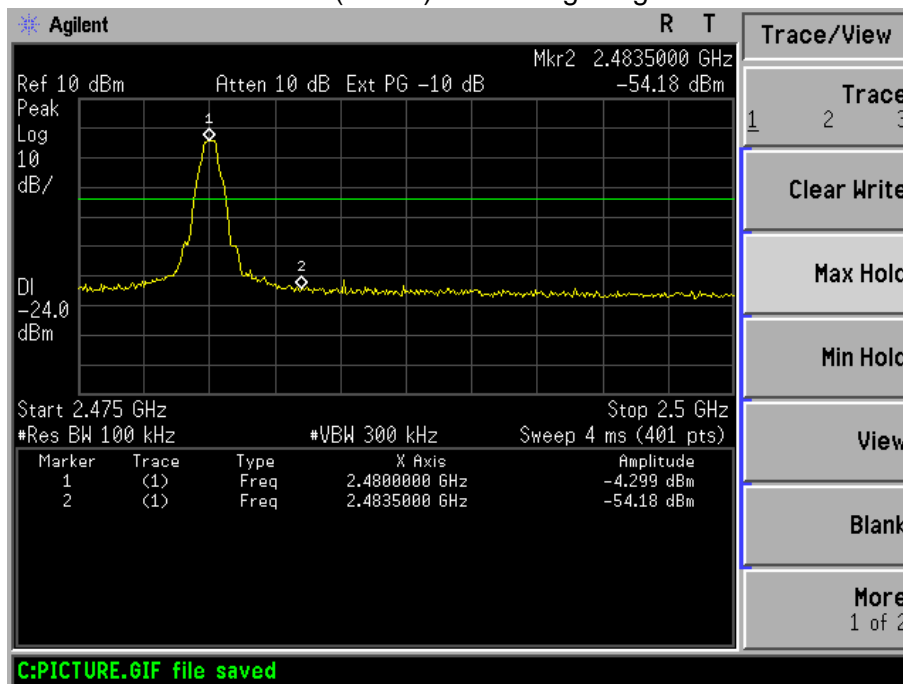



EDR mode ($\pi/4$ -DQPSK): Band Edge-Left Side

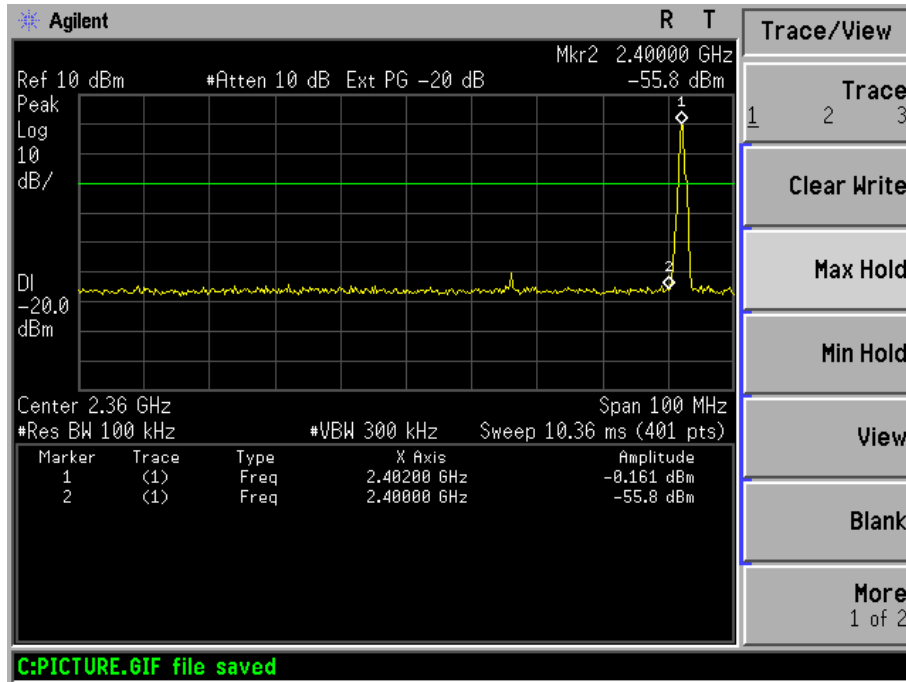

EDR mode ($\pi/4$ -DQPSK): Band Edge-Right Side

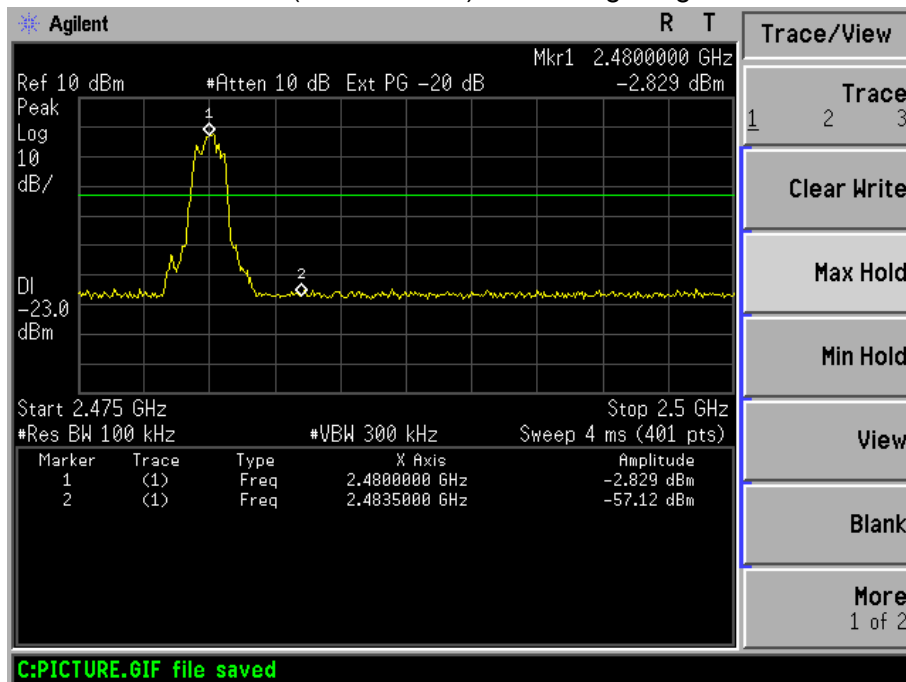



EDR mode(8DPSK): Band Edge-Left Side

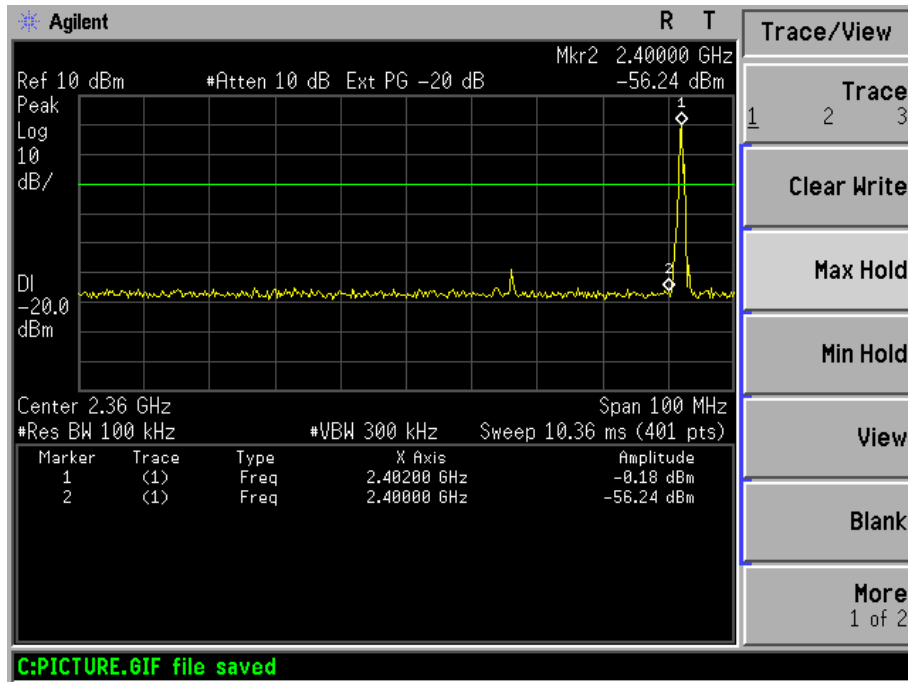

EDR mode(8DPSK): Band Edge-Right Side

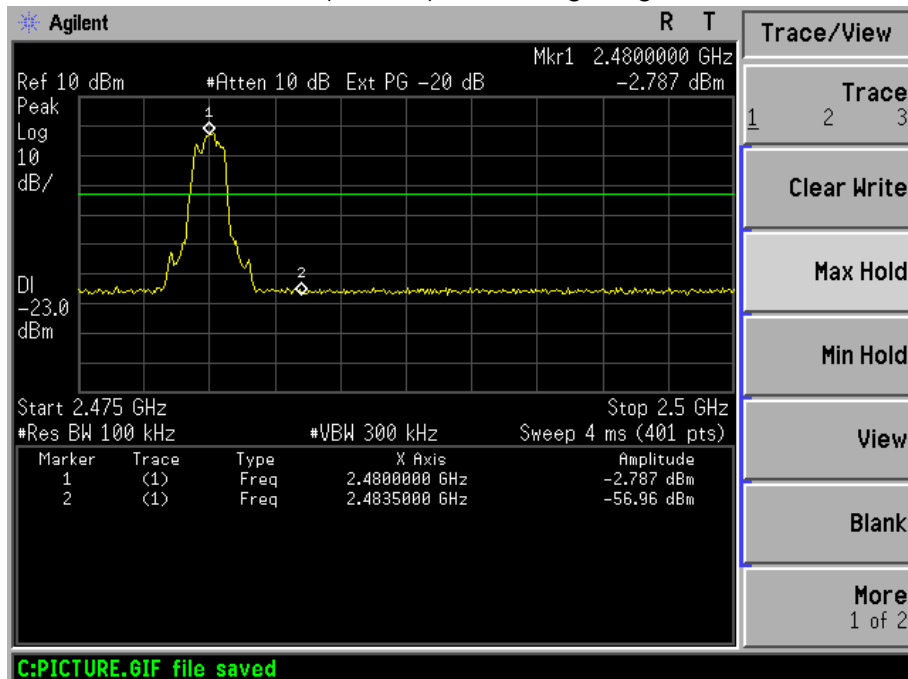

NOTE: Hopping enabled and disabled have evaluated, and the worst data was reported



10. ANTENNA REQUIREMENT

10.1 STANDARD REQUIREMENT

15.203 requirement: For intentional device, according to 15.203: an intentional radiator shall be designed to ensure that no antenna other than that furnished by the responsible party shall be used with the device.

10.2 EUT ANTENNA

The EUT antenna is FPCB antenna. It comply with the standard requirement.



11. EUT TEST PHOTO

Radiated Measurement Photos

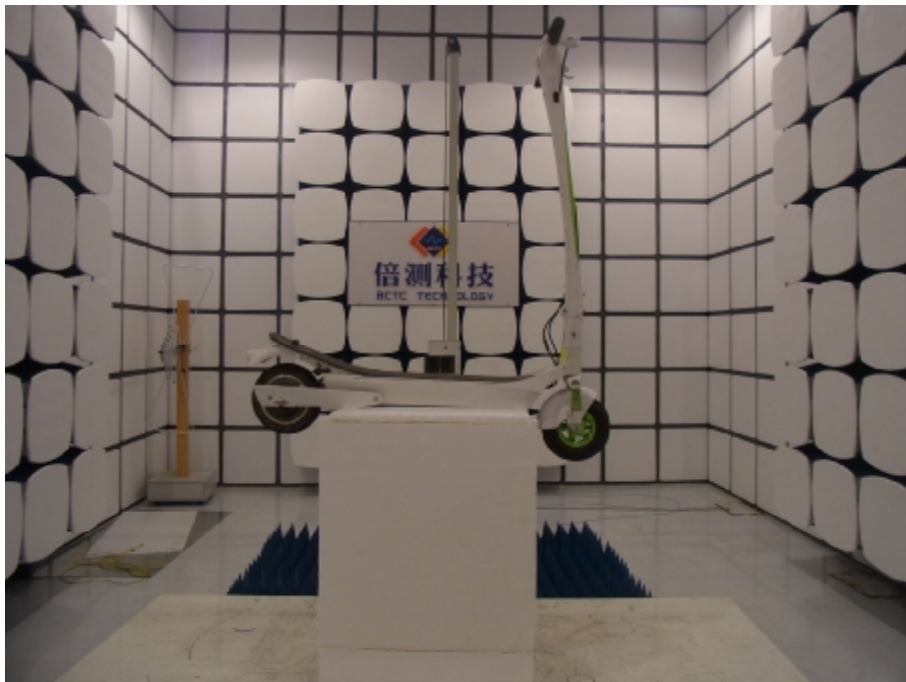
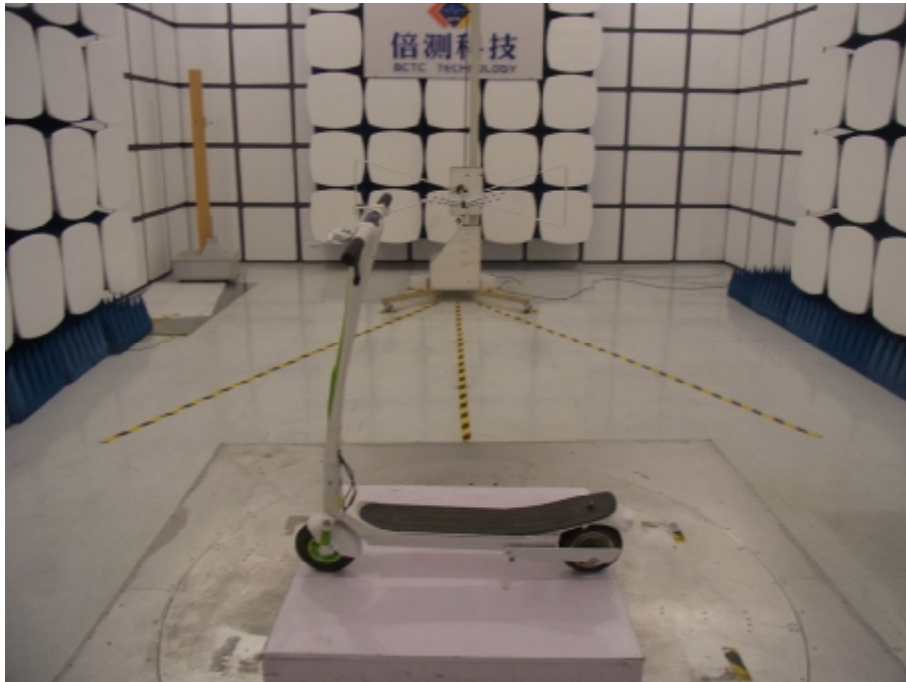



CONDUCTED EMISSION Photos

