

## FCC - TEST REPORT

Report Number : **64.790.18.02136.01** Date of Issue: 2018-11-26

Model : GBF-1719-B, 0383

Product Type : Bluetooth Body Fat Analyzer

Applicant : Greater Goods,LLC

Address : 4427 Chouteau Ave. St. Louis, Missouri, United States

Production Facility : Zhongshan Transtek Electronics Co., Ltd

Address : No.23 Jin'an Road, Minzhong, Zhongshan, Guangdong, PEOPLE'S  
: REPUBLIC OF CHINA

Test Result :  **Positive**  **Negative**



Total pages including Appendices : 31

*TÜV SÜD Certification and Testing (China) Co., Ltd. Guangzhou Branch is a subcontractor to TÜV SÜD Product Service GmbH according to the principles outlined in ISO 17025.*

*TÜV SÜD Certification and Testing (China) Co., Ltd. Guangzhou Branch reports apply only to the specific samples tested under stated test conditions. Construction of the actual test samples has been documented. It is the manufacturer's responsibility to assure that additional production units of this model are manufactured with identical electrical and mechanical components. The manufacturer/importer is responsible to the Competent Authorities in Europe for any modifications made to the production units which result in non-compliance to the relevant regulations. TÜV SÜD Certification and Testing (China) Co., Ltd. Guangzhou Branch shall have no liability for any deductions, inferences or generalizations drawn by the client or others from TÜV SÜD Certification and Testing (China) Co., Ltd. Guangzhou Branch issued reports.*

*This report is the confidential property of the client. As a mutual protection to our clients, the public and ourselves, extracts from the test report shall not be reproduced except in full without our written approval.*

## 1 Table of Contents

1	Table of Contents .....	2
2	Details about the Test Laboratory .....	3
3	Description of the Equipment Under Test .....	4
4	Summary of Test Standards .....	5
5	Summary of Test Results .....	6
6	General Remarks .....	7
7	Test Setups .....	8
8	Systems test configuration .....	9
9	Technical Requirement .....	10
9.1	Conducted peak output power .....	10
9.2	Power spectral density .....	13
9.3	6 dB Bandwidth and 99% Occupied Bandwidth .....	16
9.4	Spurious RF conducted emissions .....	20
9.5	Band edge .....	24
9.6	Spurious radiated emissions for transmitter .....	26
10	Test Equipment List .....	30
11	System Measurement Uncertainty .....	31

## 2 Details about the Test Laboratory

### Details about the Test Laboratory

#### Test Site 1

Company name: TÜV SÜD Certification and Testing (China) Co., Ltd. Shenzhen Branch  
Building 12 & 13, Zhiheng Wisdomland Business Park, Nantou Checkpoint  
Road 2, Nanshan District  
Shenzhen 518052  
P.R. China

Telephone: 86 755 8828 6998  
Fax: 86 755 828 5299

FCC Registration No.: 514049

### 3 Description of the Equipment Under Test

Product:	Bluetooth Body Fat Analyzer
Model no.:	GBF-1719-B, 0383
FCC ID:	2ADUL0383
Options and accessories:	N/A
Rating:	Battery:6.0VDC
RF Transmission Frequency:	2402MHz-2480MHz
No. of Operated Channel:	40
Modulation:	GFSK
Antenna Type:	Internal Antenna
Antenna Gain:	0.0dBi
Description of the EUT:	The Equipment Under Test (EUT) GBF-1719-B, 0383 are Bluetooth Body Fat Analyzer operated at 2.402-2.48GHz

## 4 Summary of Test Standards

Test Standards	
FCC Part 15 Subpart C 10-1-2017 Edition	PART 15 - RADIO FREQUENCY DEVICES Subpart C - Intentional Radiators

All the test methods were according to KDB558074 D01 v05 DTS Measurement Guidance and ANSI C63.10 (2013).

## 5 Summary of Test Results

Technical Requirements					
FCC Part 15 Subpart C					
Test Condition		Test Site	Test Result		
			Pass	Fail	N/A
§15.207	Conducted emission AC power port	---	<input type="checkbox"/>	<input type="checkbox"/>	<input checked="" type="checkbox"/>
§15.247 (b) (1)	Conducted peak output power	Site 1	<input checked="" type="checkbox"/>	<input type="checkbox"/>	<input type="checkbox"/>
§15.247(a)(1)	20dB bandwidth	---	<input type="checkbox"/>	<input type="checkbox"/>	<input checked="" type="checkbox"/>
§15.247(a)(1)	Carrier frequency separation	---	<input type="checkbox"/>	<input type="checkbox"/>	<input checked="" type="checkbox"/>
§15.247(a)(1)(iii)	Number of hopping frequencies	---	<input type="checkbox"/>	<input type="checkbox"/>	<input checked="" type="checkbox"/>
§15.247(a)(1)(iii)	Dwell Time	---	<input type="checkbox"/>	<input type="checkbox"/>	<input checked="" type="checkbox"/>
§15.247(a)(2)	6dB bandwidth and 99% Occupied Bandwidth	Site 1	<input checked="" type="checkbox"/>	<input type="checkbox"/>	<input type="checkbox"/>
§15.247(e)	Power spectral density	Site 1	<input checked="" type="checkbox"/>	<input type="checkbox"/>	<input type="checkbox"/>
§15.247(d)	Spurious RF conducted emissions	Site 1	<input checked="" type="checkbox"/>	<input type="checkbox"/>	<input type="checkbox"/>
§15.247(d)	Band edge	Site 1	<input checked="" type="checkbox"/>	<input type="checkbox"/>	<input type="checkbox"/>
§15.247(d) & §15.209	Spurious radiated emissions for transmitter	Site 1	<input checked="" type="checkbox"/>	<input type="checkbox"/>	<input type="checkbox"/>
§15.203	Antenna requirement	See note 1	<input checked="" type="checkbox"/>	<input type="checkbox"/>	<input type="checkbox"/>

Note 1: N/A=Not Applicable.

Note 2: The EUT uses a Integrated antenna, which gain is 0.0dBi. In accordance to §15.203, it is considered sufficiently to comply with the provisions of this section.

## 6 General Remarks

This submittal(s) (test report) is intended for FCC ID: 2ADUL0383 complies with Section 15.209, 15.247 of the FCC Part 15, Subpart C rules.

GBF-1719-B, 0383 are Bluetooth Body Fat Analyzer with Bluetooth 4.0. The TX and RX range is 2402MHz-2480MHz for 4.0.

The two models are identical except the model name, so the test was performed on the model GBF-1719-B.

### SUMMARY:

All tests according to the regulations cited on page 5 were

- Performed

- Not Performed

The Equipment under Test

- **Fulfills** the general approval requirements.

- **Does not fulfill** the general approval requirements.

Sample Received Date: June 15, 2018

Testing Start Date: June 23, 2018

Testing End Date: June 28, 2018

- TÜV SÜD Certification and Testing (China) Co., Ltd. Guangzhou Branch -

Reviewed by:

  
Tony Liu

Prepared by:

  
Kevin Ouyang

Test by:

  
Louise Liu

## 7 Test Setups

### 7.1 Radiated test setups

Below 1GHz

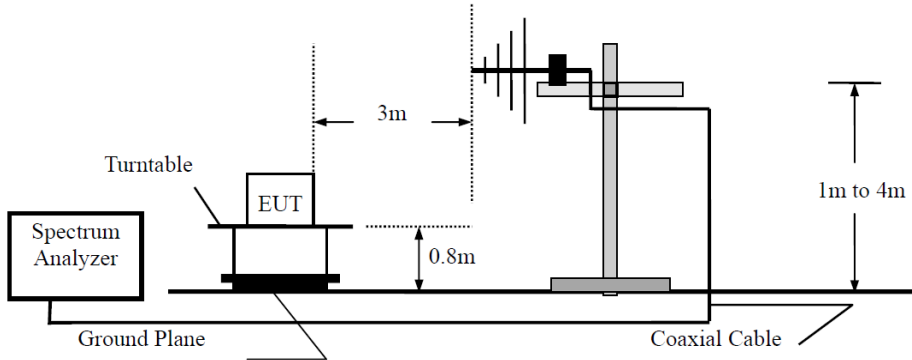

Above 1GHz

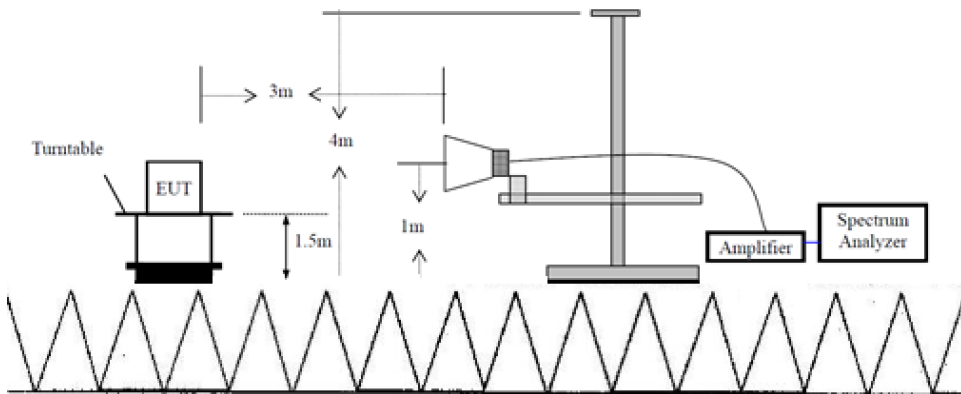

### 7.2 Conducted RF test setups

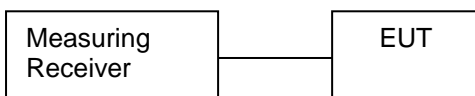



## 8 Systems test configuration

Auxiliary Equipment Used during Test:

DESCRIPTION	MANUFACTURER	MODEL NO.(SHIELD)	S/N(LENGTH)
Notebook	Lenovo	X220	---
Mobile phone	Huawei	P10	---

Test software: wtcdb.exe, which used to control the EUT in continues transmitting mode.

The system was configured to channel 0, 19, and 39 for the test.

## 9 Technical Requirement

### 9.1 Conducted peak output power

#### Test Method

1. Use the following spectrum analyzer settings:  
 RBW > the 6 dB bandwidth of the emission being measured, VBW $\geq$ 3RBW, Span $\geq$ 3RBW  
 Sweep = auto, Detector function = peak, Trace = max hold.
2. Add a correction factor to the display.
3. Allow the trace to stabilize. Use the marker-to-peak function to set the marker to the peak of the emission. The indicated level is the peak output power.

#### Limits

According to §15.247 (b) (1), conducted peak output power limit as below:

Frequency Range MHz	Limit W	Limit dBm
2400-2483.5	$\leq 1$	$\leq 30$

Test result as below table

Frequency MHz	Conducted Peak Output Power dBm	Result
Bottom channel 2402MHz	4.06	Pass
Middle channel 2440MHz	3.33	Pass
Top channel 2480MHz	2.33	Pass

### Low channel 2402MHz

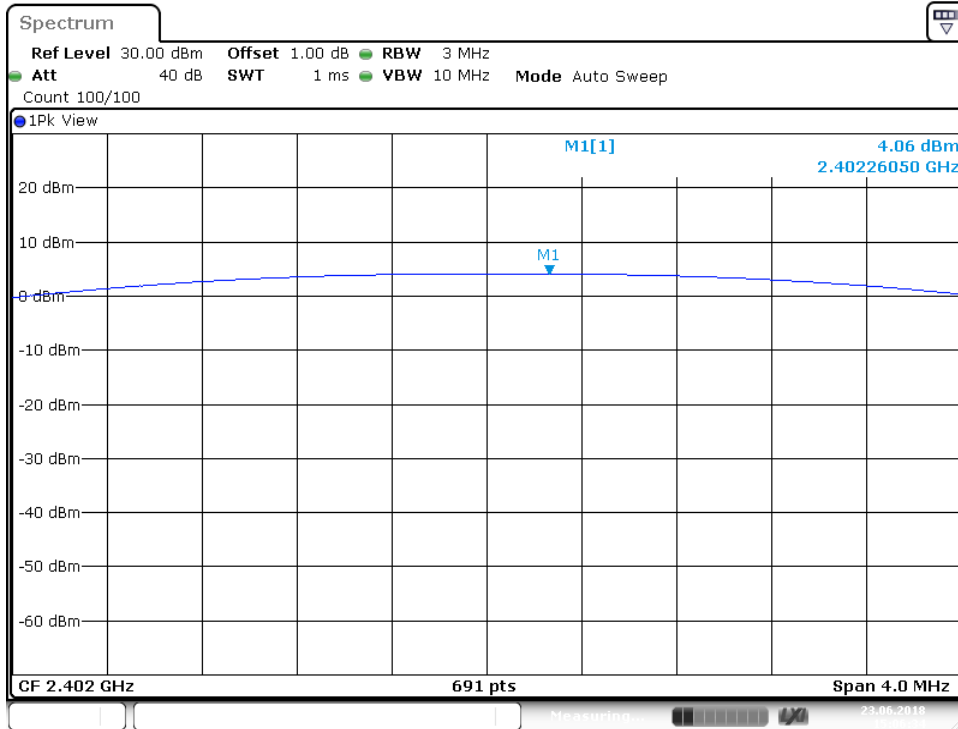

Date: 23 JUN 2018 15:06:34

### Middle channel 2440MHz

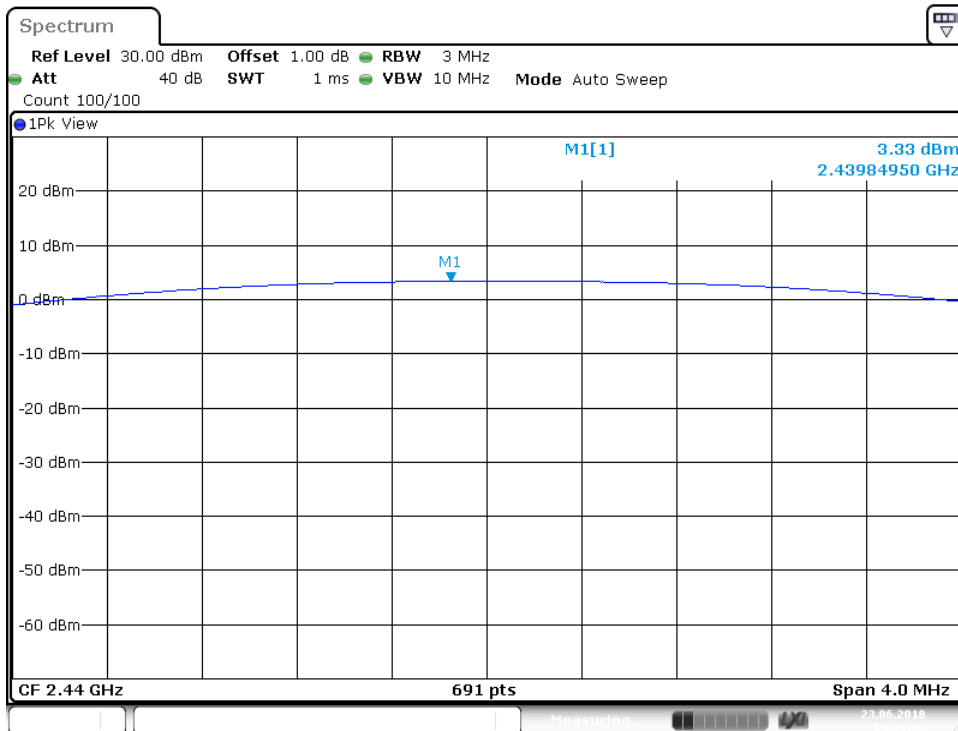

Date: 23 JUN 2018 15:15:32

### High channel 2480MHz

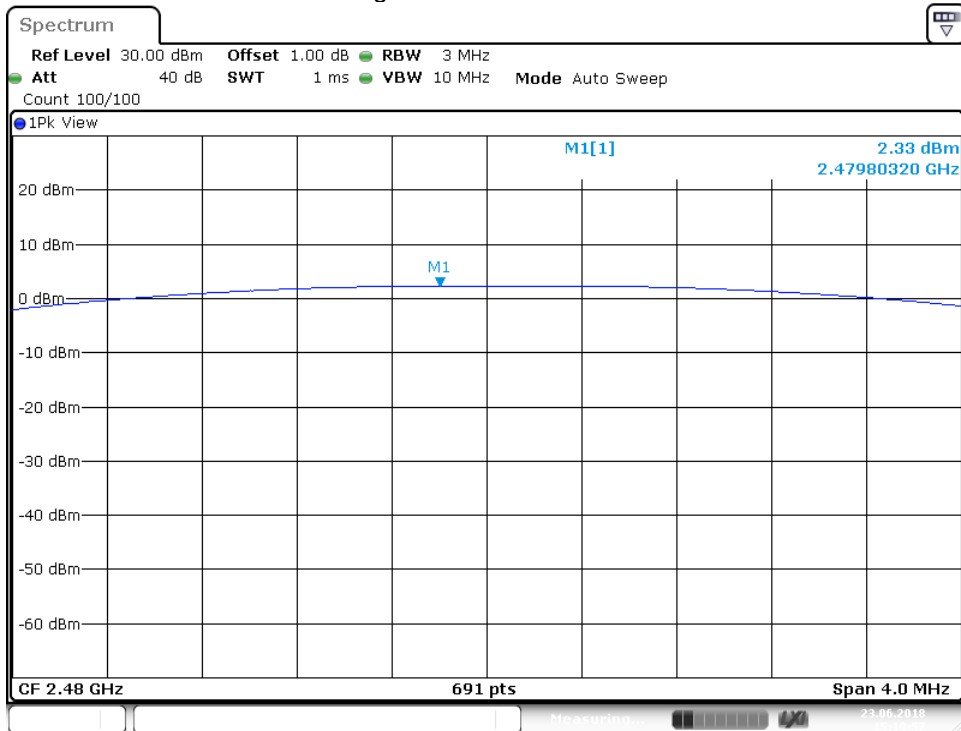

Date: 23 JUN 2018 15:19:57

## 9.2 Power spectral density

### Test Method

This procedure shall be used if maximum peak conducted output power was used to demonstrate compliance:

1. Set analyzer center frequency to DTS channel center frequency. RBW=3kHz, VBW $\geq$ 3RBW, Span=1.5 times DTS bandwidth, Detector=Peak, Sweep=auto, Trace= max hold.
2. Allow trace to fully stabilize, use the peak marker function to determine the maximum amplitude level within the RBW.
3. Repeat above procedures until other frequencies measured were completed.

### Limit

Limit [dBm]

≤8

### Test result

Frequency MHz	Power spectral density dBm	Result
Bottom channel 2402MHz	-1.94	Pass
Middle channel 2440MHz	-3.18	Pass
Top channel 2480MHz	-3.77	Pass

### Low channel 2402MHz

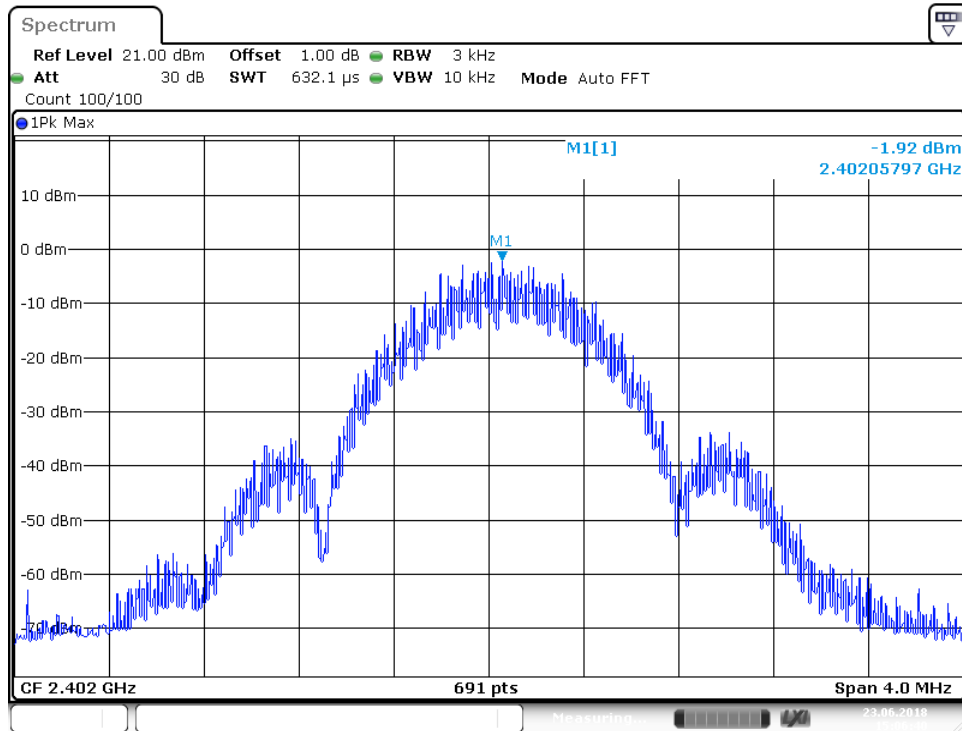

Date: 23 JUN 2018 15:06:40

### Middle channel 2440MHz

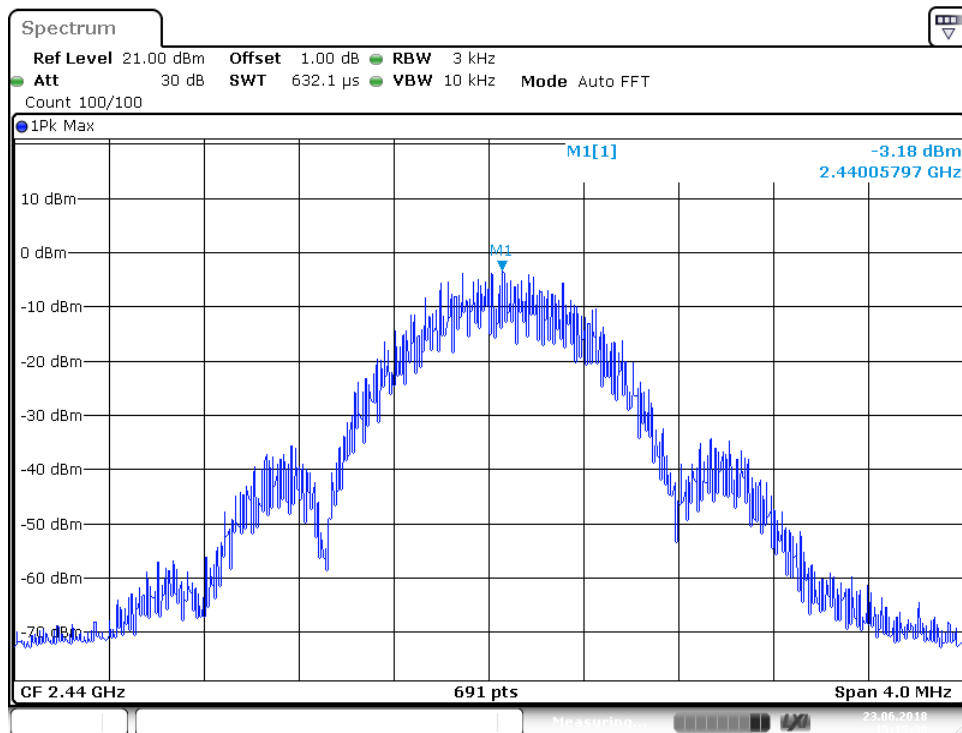

Date: 23 JUN 2018 15:15:39

### High channel 2480MHz

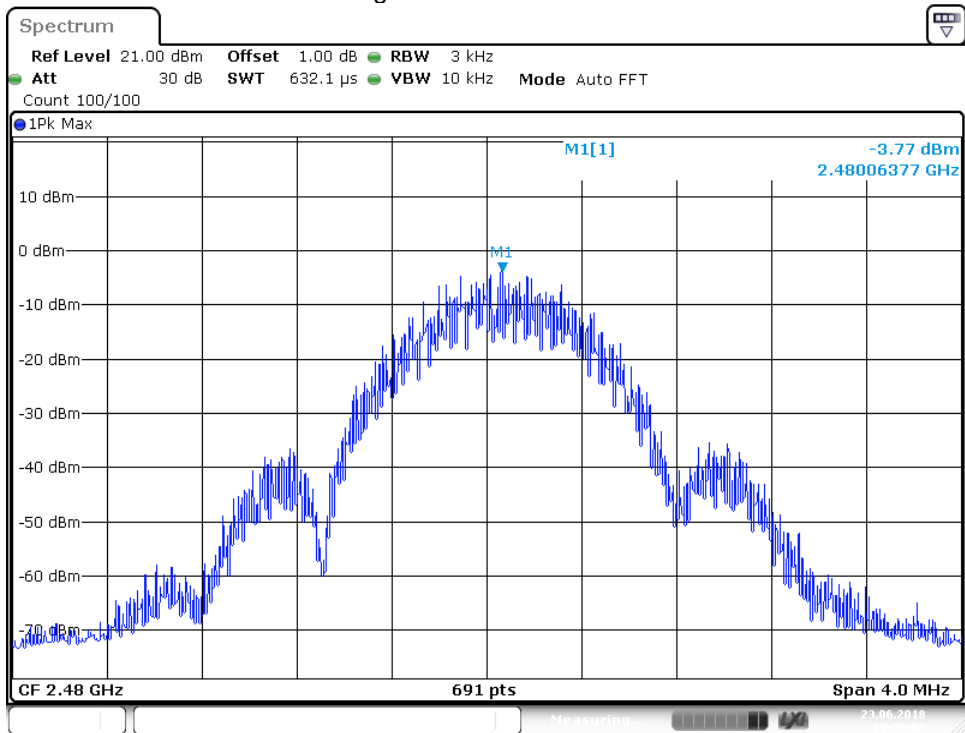

Date: 23 JUN 2018 15:20:03

### 9.3 6 dB Bandwidth and 99% Occupied Bandwidth

#### Test Method

1. Use the following spectrum analyzer settings:  
RBW=100K, VBW $\geq$ 3RBW, Sweep = auto, Detector function = peak, Trace = max hold
2. Use the automatic bandwidth measurement capability of an instrument, may be employed using the X dB bandwidth mode with X set to 6 dB, care shall be taken so that the bandwidth measurement is not influenced by any intermediate power nulls in the fundamental emission that might be  $\geq$  6 dB.
3. Allow the trace to stabilize, record the X dB Bandwidth value.

#### Limit

Limit [kHz]

—————  
 $\geq$ 500

#### Test result

Frequency MHz	6dB bandwidth kHz	99% bandwidth kHz	Result
Bottom channel 2402MHz	668	1011	Pass
Middle channel 2440MHz	676	1011	Pass
Top channel 2480MHz	676	1007	Pass



# 6 dB Bandwidth

## Low channel 2402MHz

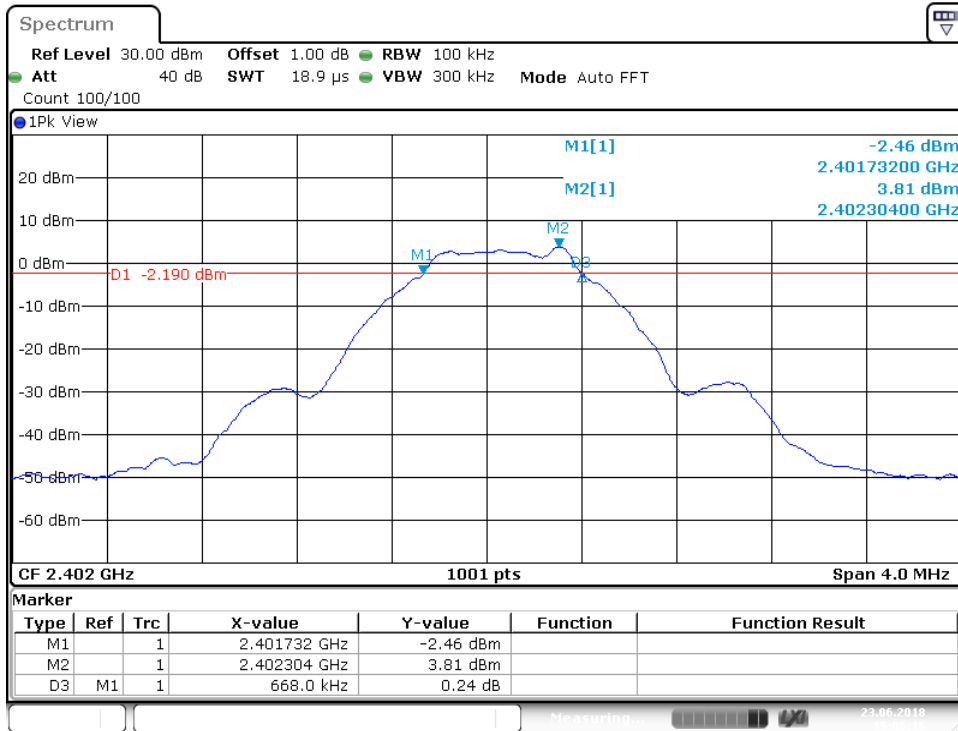

Date: 23 JUN 2018 15:06:16

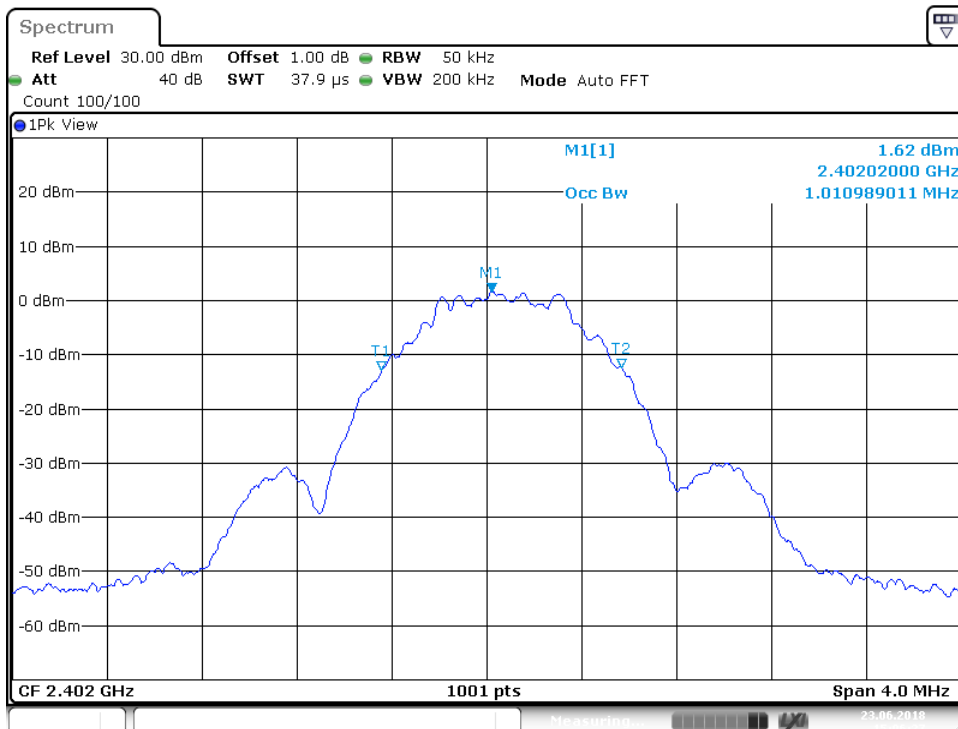

Date: 23 JUN 2018 15:06:27

### Middle channel 2440MHz

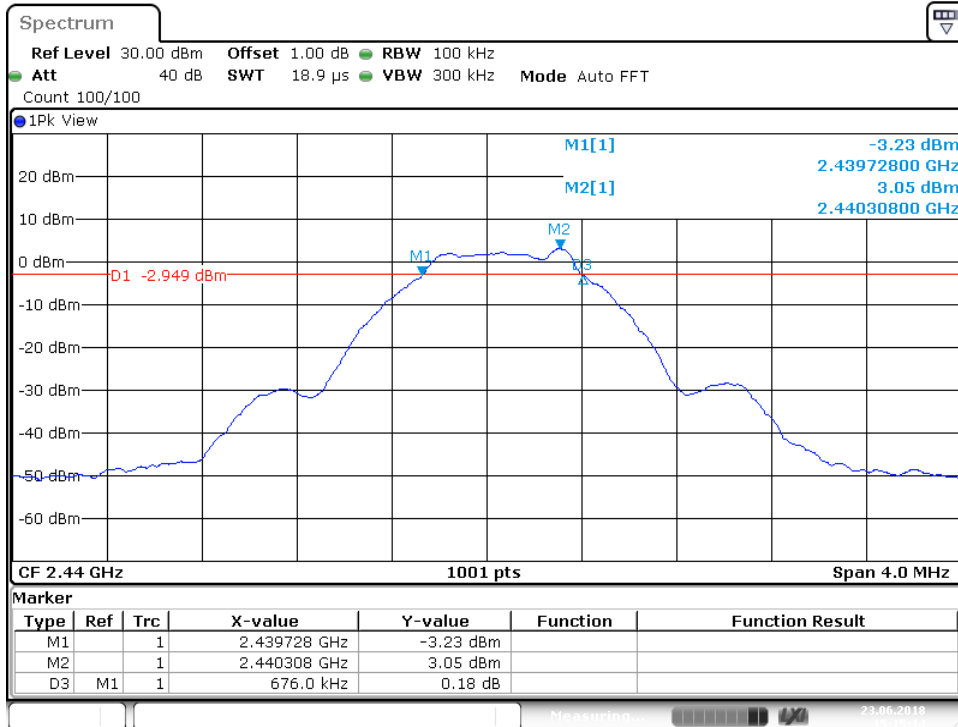

Date: 23 JUN 2018 15:15:15

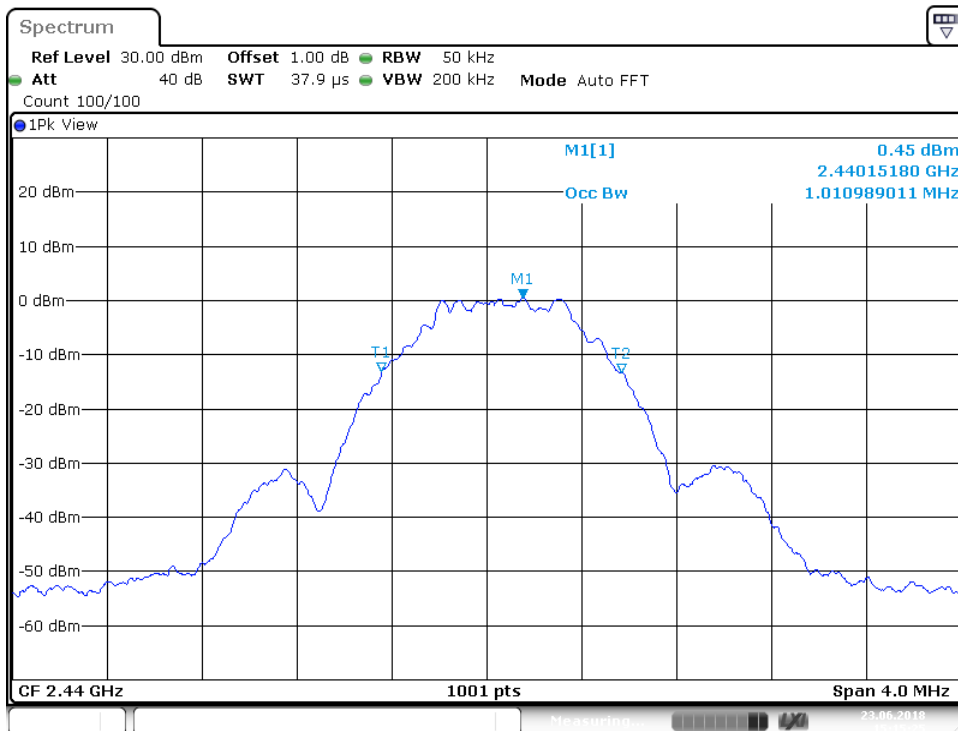

Date: 23 JUN 2018 15:15:26

### High channel 2480MHz

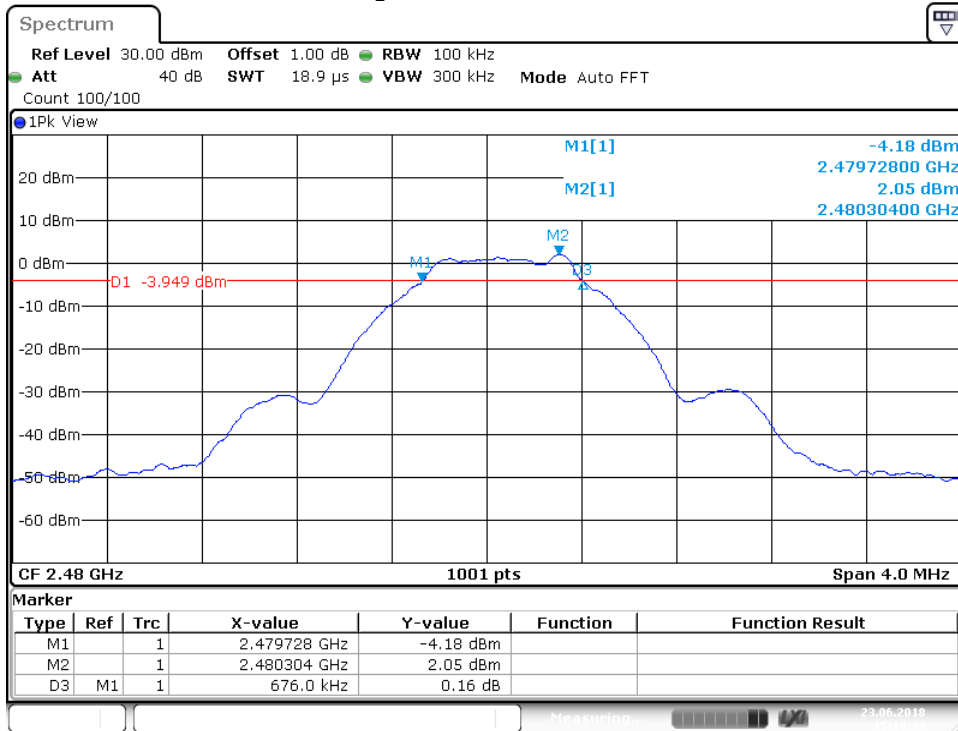

Date: 23 JUN 2018 15:19:39

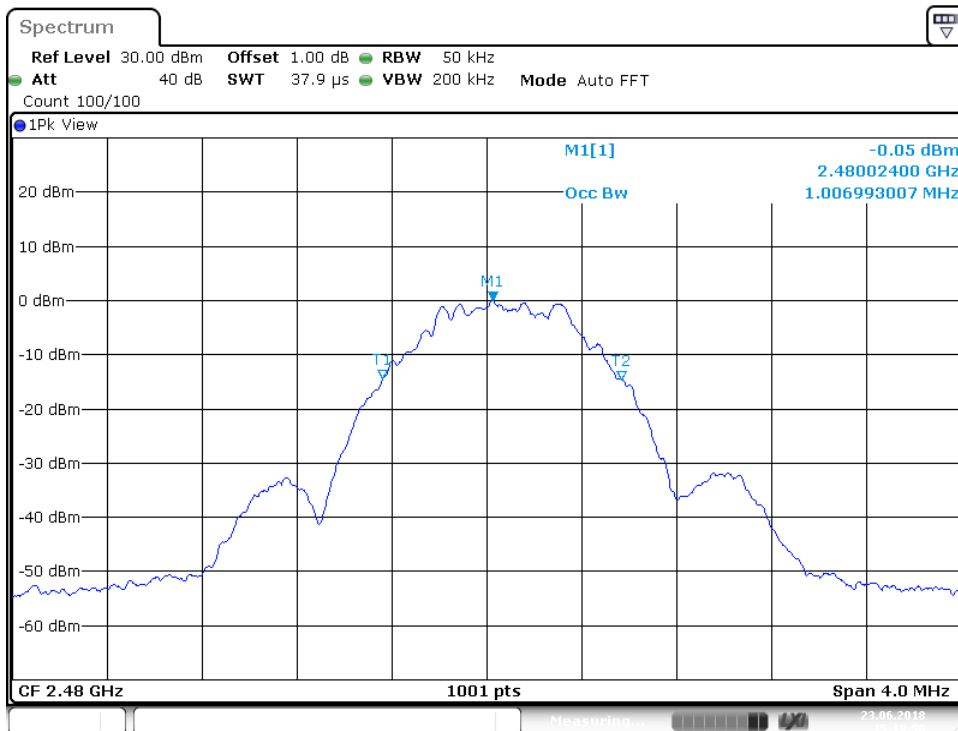

Date: 23 JUN 2018 15:19:50

## 9.4 Spurious RF conducted emissions

### Test Method

1. Establish a reference level by using the following procedure:
  - a. Set RBW=100 kHz. VBW $\geq$ 3RBW. Detector =peak, Sweep time = auto couple, Trace mode = max hold.
  - b. Allow trace to fully stabilize, use the peak marker function to determine the maximum PSD level.
2. Use the maximum PSD level to establish the reference level.
  - a. Set the center frequency and span to encompass frequency range to be measured.
  - b. Use the peak marker function to determine the maximum amplitude level. Ensure that the amplitude of all unwanted emissions outside of the authorized frequency band (excluding restricted frequency bands) are attenuated by at least the minimum requirements, report the three highest emissions relative to the limit.
3. Repeat above procedures until other frequencies measured were completed.

### Limit

Frequency Range MHz	Limit (dBc)
30-25000	-20

# Spurious RF conducted emissions

2402MHz

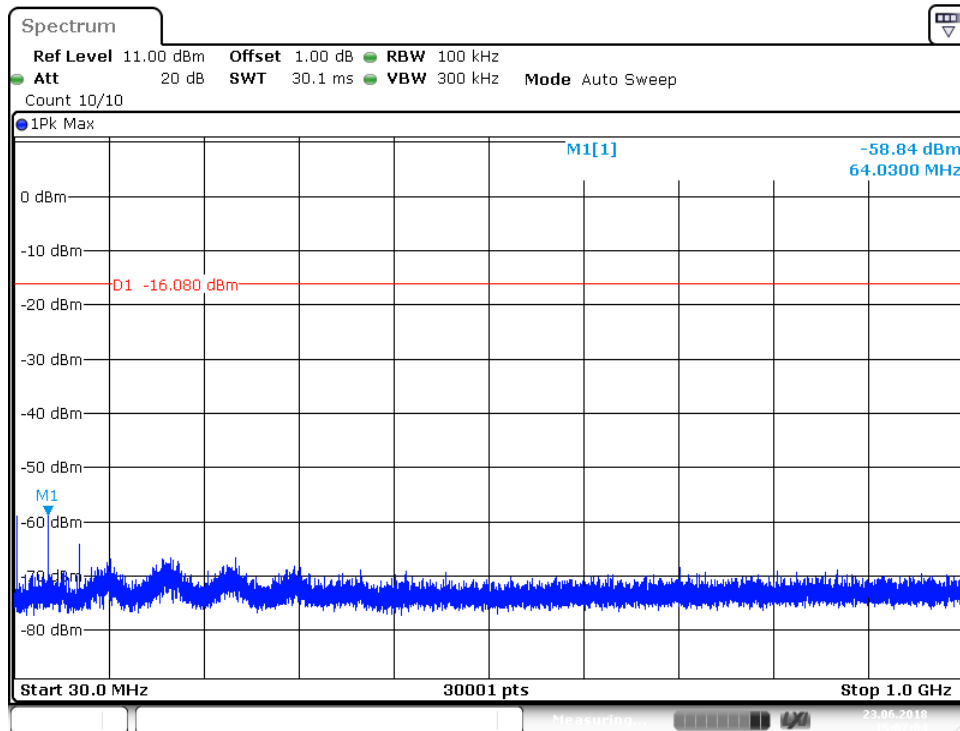

Date: 23 JUN 2018 15:07:05

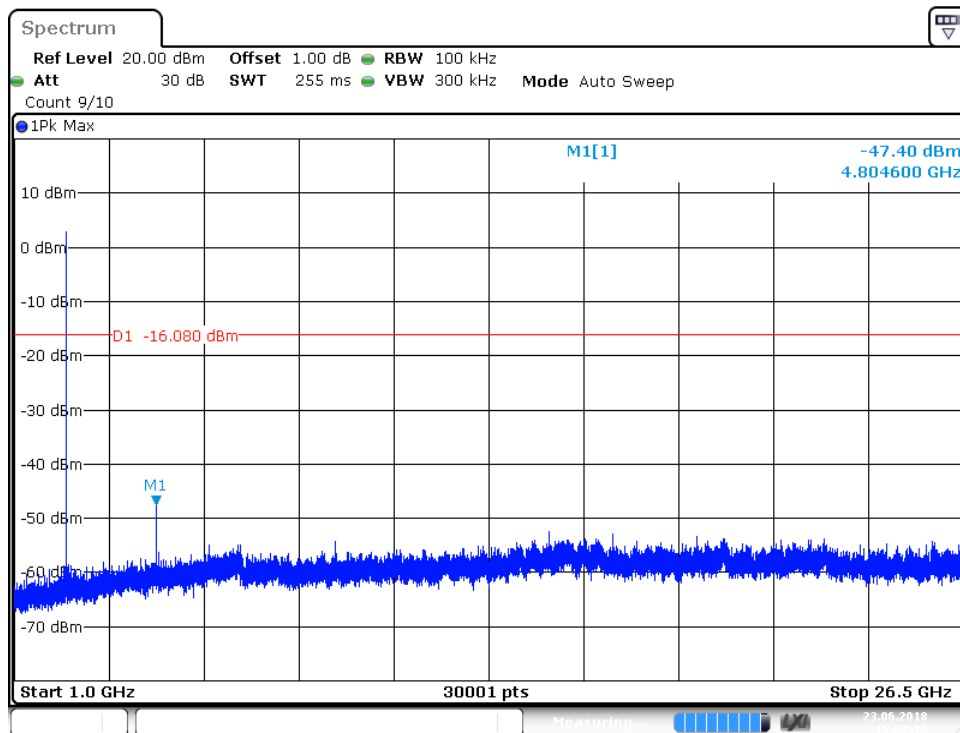

Date: 23 JUN 2018 15:07:16

## 2440MHz

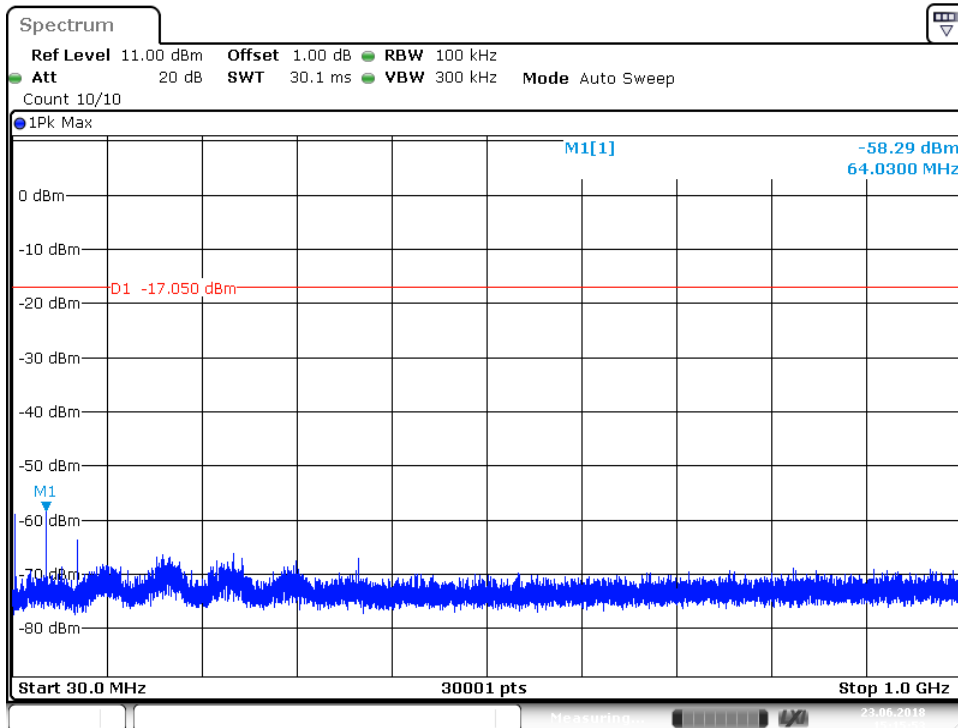

Date: 23 JUN 2018 15:15:53

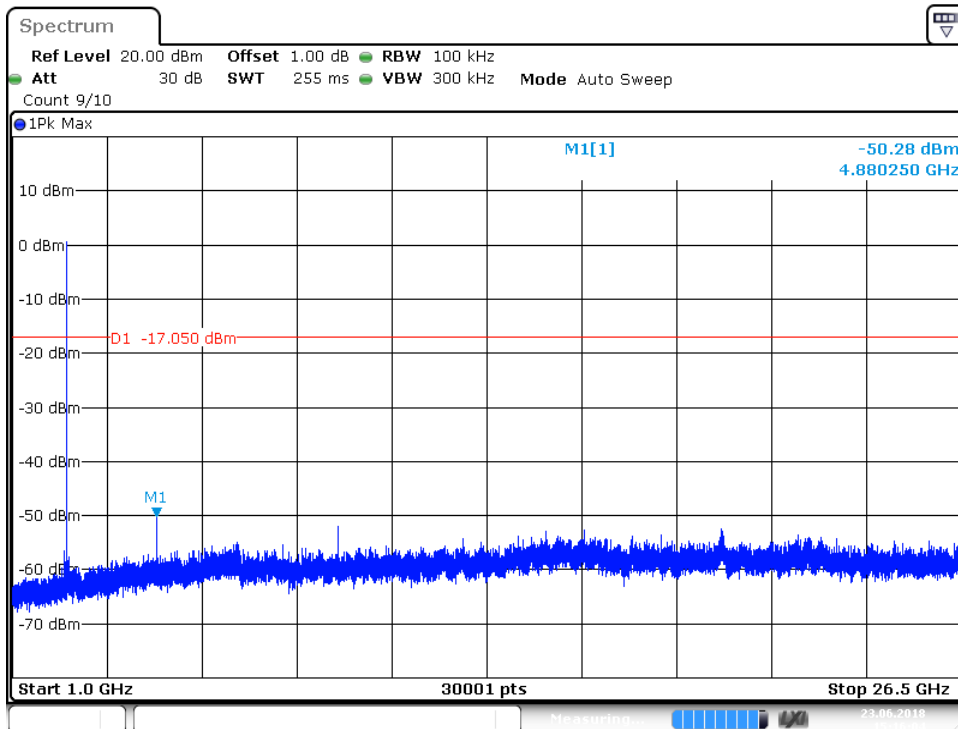

Date: 23 JUN 2018 15:16:05

## 2480MHz

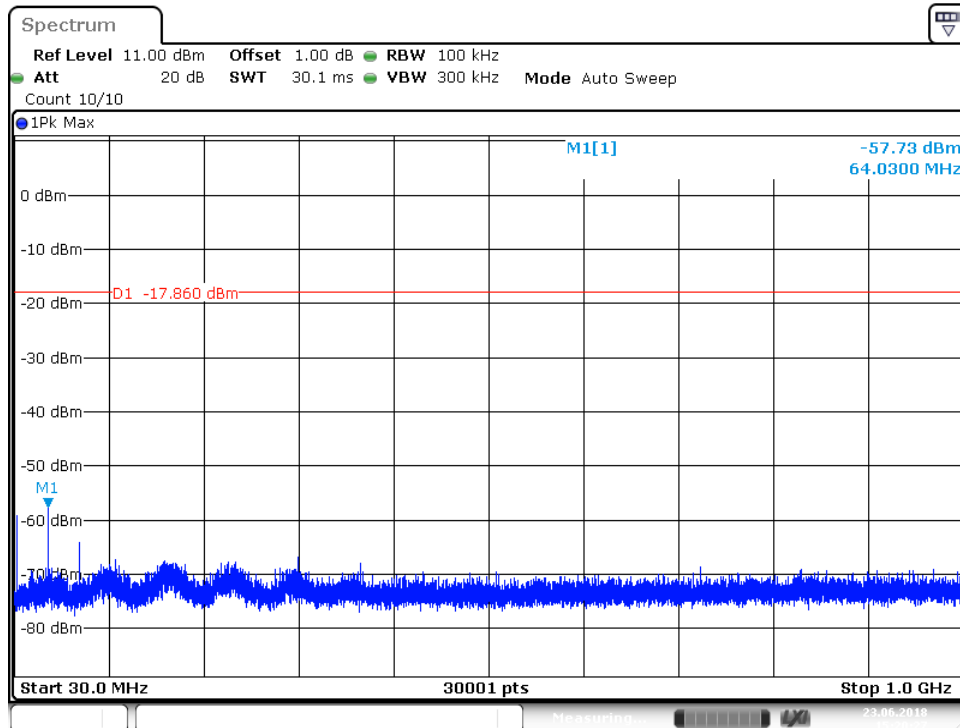

Date: 23 JUN 2018 15:20:27

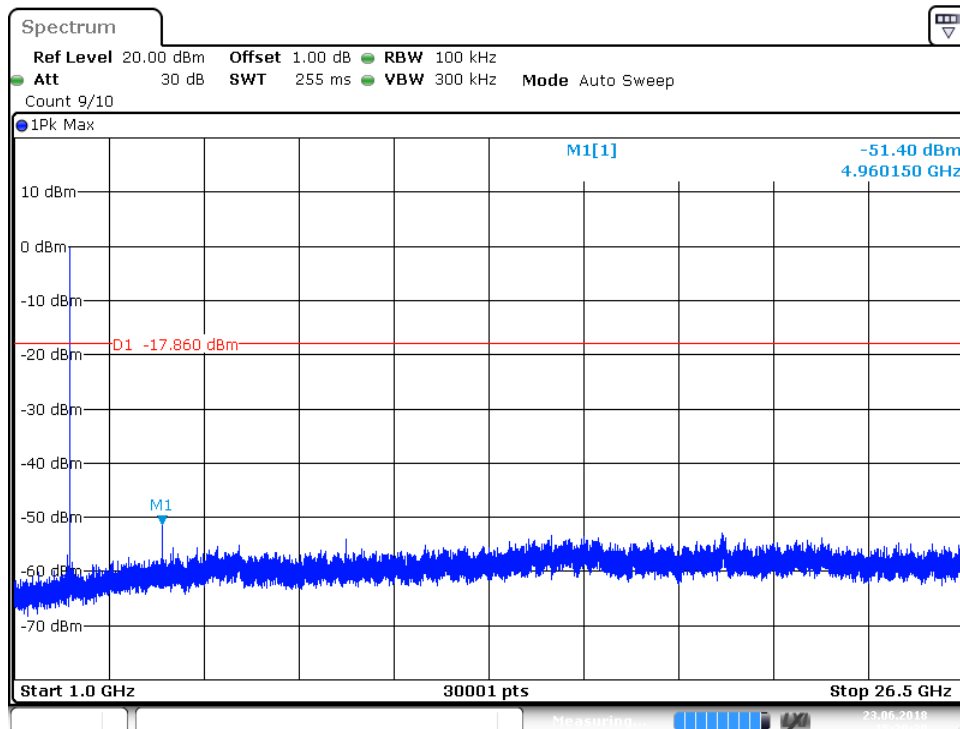

Date: 23 JUN 2018 15:20:39

## 9.5 Band edge

### Test Method

- 1 Use the following spectrum analyzer settings:  
Span = wide enough to capture the peak level of the in-band emission and all spurious  
RBW = 100 kHz, VBW  $\geq$  RBW, Sweep = auto, Detector function = peak, Trace = max hold.
- 2 Allow the trace to stabilize, use the peak and delta measurement to record the result.
- 3 The level displayed must comply with the limit specified in this Section.

### Limit

Frequency Range MHz	Limit (dBc)
30-25000	-20



# Band edge testing

## 2402MHz

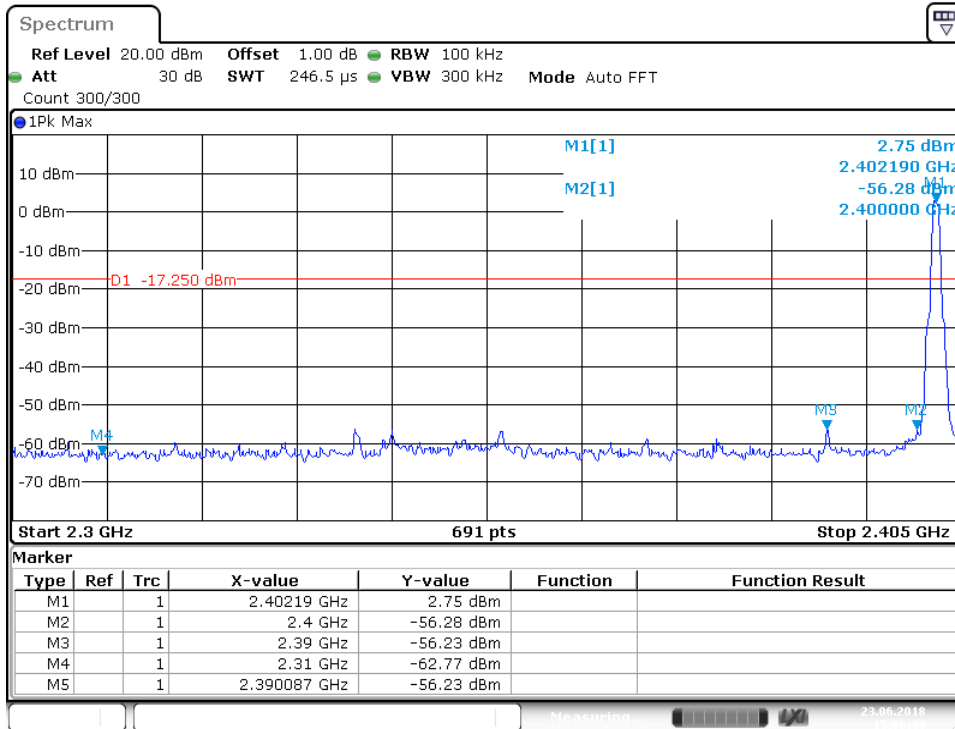

Date: 23 JUN 2018 15:06:50

## 2480MHz

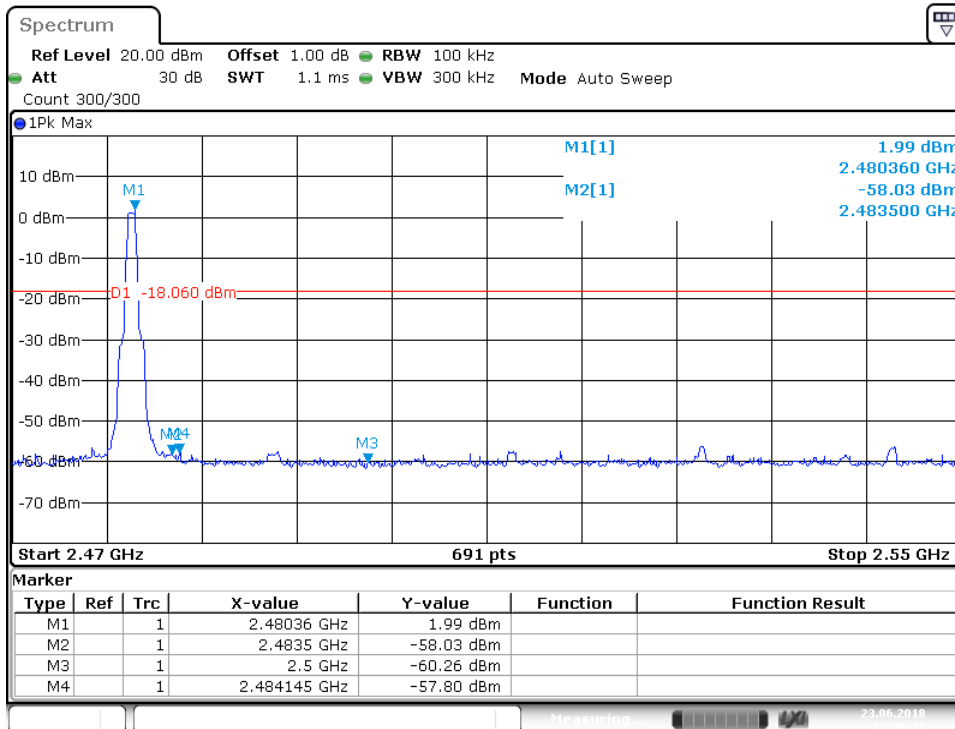

Date: 23 JUN 2018 15:20:13

## 9.6 Spurious radiated emissions for transmitter

### Test Method

- 1: The EUT was placed on a turn table which is 1.5m above ground plane for above 1GHz and 0.8m above ground for below 1GHz at 3 meter chamber room for test. The table was rotated 360 degrees to determine the position of the highest radiation.
- 2: The EUT was set 3 meters away from the interference – receiving antenna, which was mounted on the top of a variable – height antenna tower.
- 3: The height of antenna is varied from one meter to four meters above the ground to determine the maximum value of the field strength. Both horizontal and vertical polarizations of the antenna are set to make the measurement.
- 4: For each suspected emission, the EUT was arranged to its worst case and then the antenna was tuned to heights from 1 meter to 4 meters and the rotatable table was turned from 0 degrees to 360 degrees to find the maximum reading.
- 5: Use the following spectrum analyzer settings According to C63.10:

#### For Above 1GHz

Span = wide enough to capture the peak level of the in-band emission and all spurious  
RBW = 1MHz, VBW $\geq$ RBW for peak measurement and VBW = 10Hz for average measurement, Sweep = auto, Detector function = peak, Trace = max hold.

#### For Below 1GHz

Use the following spectrum analyzer settings:

Span = wide enough to capture the peak level of the in-band emission and all spurious  
RBW = 100 KHz, VBW $\geq$ RBW for peak measurement, Sweep = auto, Detector function = peak, Trace = max hold.

### Note:

- 1: The resolution bandwidth and video bandwidth of test receiver/spectrum analyzer is 120 KHz for Quasi-peak detection (QP) at frequency below 1GHz.
- 2: The resolution bandwidth of test receiver/spectrum analyzer is 1MHz and the video bandwidth is 3MHz for peak detection (PK) at frequency above 1GHz.
- 3: The resolution bandwidth of test receiver/spectrum analyzer is 1MHz and the video bandwidth is 3MHz for RMS Average ((duty cycle < 98%) for Average detection (AV) at frequency above 1GHz, then the measurement results was added to a correction factor (20log(1/duty cycle)).
- 4: The resolution bandwidth of test receiver/spectrum analyzer is 1MHz and the video bandwidth is 10Hz (duty cycle > 98%) for Average detection (AV) at frequency above 1GHz.

## Limit

The radio emission outside the operating frequency band shall be at least 20 dB below that in the 100 kHz bandwidth within the band that contains the highest level of the desired power. Radiated emissions which fall in the restricted bands, as defined in section 15.205, must comply with the radiated emission limits specified in section 15.209.

Frequency MHz	Field Strength uV/m	Field Strength dB $\mu$ V/m	Detector
30-88	100	40	QP
88-216	150	43.5	QP
216-960	200	46	QP
960-1000	500	54	QP
Above 1000	500	54	AV
Above 1000	5000	74	PK

## Spurious radiated emissions for transmitter

According to C63.10, if the peak (or quasi-peak) measured value complies with the average limit, it is unnecessary to perform an average measurement, so AV emission value did not show in below table if the peak value complies with average limit.

### Transmitting spurious emission test result as below:

#### Below 1GHz

Frequency Band	Frequency	Emission Level	Polarization	Limit	Detector	Margin	Correct factor	Result
	MHz	dBuV/m		dBuV/m				
30-1000MHz	38.730000	16.20	H	40.00	QP	23.80	-25.5	Pass
	389.923889	25.08	H	46.00	QP	20.92	-22.9	Pass
	576.056111	24.80	H	46.00	QP	21.20	-20.5	Pass
	886.617778	29.64	H	46.00	QP	16.36	-15.5	Pass
	38.945556	16.04	V	40.00	QP	23.96	-25.1	Pass
	59.046111	16.49	V	40.00	QP	23.51	-26.3	Pass
	444.190000	17.67	V	46.00	QP	28.33	-22.3	Pass
	874.169444	28.97	V	46.00	QP	17.03	-15.4	Pass

#### Above 1GHz

#### Low channel 2402MHz Test Result

Frequency Band	Frequency	Emission Level	Polarization	Limit	Detector	Margin	Correct factor	Result
	MHz	dBuV/m		dBuV/m				
1000-25000MHz	1253.500000	27.99	H	74	PK	46.01	-12.1	Pass
	1599.750000	39.91	H	74	PK	34.09	-9.6	Pass
	9609.375000	45.26	H	74	PK	28.74	8.6	Pass
	2248.125000	34.35	V	74	PK	39.65	-6.3	Pass
	2488.375000	34.61	V	74	PK	39.39	-5.4	Pass
	4804.218750	46.92	V	74	PK	27.08	2.6	Pass

#### Middle channel 2440MHz Test Result

Frequency Band	Frequency	Emission Level	Polarization	Limit	Detector	Margin	Correct factor	Result
	MHz	dBuV/m		dBuV/m				
1000-25000MHz	1599.312500	39.00	H	74	PK	35.00	-9.7	Pass
	2123.500000	33.38	H	74	PK	40.62	-6.8	Pass
	7319.531250	42.62	H	74	PK	31.38	5.8	Pass
	1599.625000	31.41	V	74	PK	42.59	-9.4	Pass
	2248.125000	34.04	V	74	PK	39.96	-6.3	Pass
	4880.625000	47.48	V	74	PK	26.52	2.6	Pass

## High channel 2480MHz Test Result

Frequency Band	Frequency	Emission Level	Polarization	Limit	Detector	Margin	Correct factor	Result
	MHz	dBuV/m		dBμV/m		dB	(dB)	
1000-25000MHz	1600.000000	35.14	H	74	PK	38.86	-9.6	Pass
	1952.312500	37.16	H	74	PK	36.84	-7.5	Pass
	4959.375000	41.12	H	74	PK	32.88	2.7	Pass
	1497.875000	31.44	V	74	PK	42.56	-10.4	Pass
	1759.750000	38.31	V	74	PK	35.69	-8.5	Pass
	4960.312500	45.16	V	74	PK	28.84	2.8	Pass

### Remark:

- (1) Data of measurement within this frequency range shown "--" in the table above means the reading of emissions are the noise floor or attenuated more than 10dB below the permissible limits or the field strength is too small to be measured.
- (2) Above 1GHz: Corrector factor = Antenna Factor + Cable Loss- Amplifier Gain  
Below 1GHz: Corrector factor = Antenna Factor + Cable Loss

## 10 Test Equipment List

### List of Test Instruments

#### Radiated Emission Test

Description	Manufacturer	Model no.	Serial no.	cal. due date
EMI Test Receiver	Rohde & Schwarz	ESR 26	101269	2018-7-14
Trilog Super Broadband Test Antenna	Schwarzbeck	VULB 9163	707	2018-7-14
Horn Antenna	Rohde & Schwarz	HF907	102294	2018-7-14
Pre-amplifier	Rohde & Schwarz	SCU 18	102230	2018-7-14
Signal Generator	Rohde & Schwarz	SMY01	839369/005	2018-7-7
Attenuator	Agilent	8491A	MY39264334	2018-7-7
3m Semi-anechoic chamber	TDK	9X6X6	----	2020-7-7
Test software	Rohde & Schwarz	EMC32	Version 9.15.00	N/A

#### Conducted Emission Test

Description	Manufacturer	Model no.	Serial no.	cal. due date
EMI Test Receiver	Rohde & Schwarz	ESR 3	101782	2018-7-14
LISN	Rohde & Schwarz	ENV4200	100249	2018-7-14
LISN	Rohde & Schwarz	ENV432	101318	2018-7-14
LISN	Rohde & Schwarz	ENV216	100326	2018-7-14
ISN	Rohde & Schwarz	ENY81	100177	2018-7-14
ISN	Rohde & Schwarz	ENY81-CA6	101664	2018-7-14
High Voltage Probe	Rohde & Schwarz	TK9420(VT9420)	9420-584	2018-7-14
RF Current Probe	Rohde & Schwarz	EZ-17	100816	2018-7-14
Attenuator	Shanghai Huaxiang	TS2-26-3	080928189	2018-7-7
Test software	Rohde & Schwarz	EMC32	Version9.15.00	N/A

#### TS8997 Test System

Description	Manufacturer	Model no.	Serial no.	cal. due date
Signal Generator	Rohde & Schwarz	SMB100A	108272	2018-7-7
Signal Analyzer	Rohde & Schwarz	FSV40	101030	2018-7-7
Vector Signal Generator	Rohde & Schwarz	SMU 200A	105324	2018-7-7
RF Switch Module	Rohde & Schwarz	OSP120/OSP-B157	101226/100851	2018-7-7
Power Splitter	Weinschel	1580	SC319	2018-7-7
10dB Attenuator	Weinschel	56-10	58764	2018-7-14
10dB Attenuator	R&S	DNF	DNF-001	2018-7-14
10dB Attenuator	R&S	DNF	DNF-002	2018-7-14
10dB Attenuator	R&S	DNF	DNF-003	2018-7-14
10dB Attenuator	R&S	DNF	DNF-004	2018-7-14
Test software	Rohde & Schwarz	EMC32	Version 9.26.01	N/A

## 11 System Measurement Uncertainty

For a 95% confidence level, the measurement expanded uncertainties for defined systems, in accordance with the recommendations of ISO 17025 were:

System Measurement Uncertainty	
Test Items	Extended Uncertainty
Uncertainty for Conducted Emission 150kHz-30MHz (for test using High Voltage Probe TK9420(VT9420))	2.51 dB
Uncertainty for Radiated Spurious Emission 25MHz-3000MHz	Horizontal: 4.80dB; Vertical: 4.87dB;
Uncertainty for Radiated Spurious Emission 3000MHz-18000MHz	Horizontal: 4.59dB; Vertical: 4.58dB;
Uncertainty for Radiated Spurious Emission 18000MHz-40000MHz	Horizontal: 5.05dB; Vertical: 5.04dB;
Uncertainty for Conducted RF test with TS 8997	Power level test involved: 1.16dB Frequency test involved: 0.6×10 <sup>-7</sup> or 1%