EMC TEST REPORT

Test Report No. : KES-E1-19T0355-R1
Date of Issue : Jul. 16, 2019
Product name : THINKWARE DASH CAM
Model/Type No. : U1000
Variant Mode : -
Applicant : THINKWARE CORPORATION
Applicant Address : A, 9FL., Samwhan Hipex, 240, Pangyoyeok-ro, Bundang-gu,
Seongnam-si, Gyeonggi-do, South Korea
Manufacturer : THINKWARE CORPORATION
Manufacturer Address : A, 9FL., Samwhan Hipex, 240, Pangyoyeok-ro, Bundang-gu,
Seongnam-si, Gyeonggi-do, South Korea
FCC ID : 2ADTG-U1000
Date of Receipt : Mar. 20, 2019
Test date : Mar. 24, 2019
Test Results : **In Compliance** **Not in Compliance**

Tested by



Hyo Jin, Kim
EMC Test Engineer

Reviewed by



Dong-Hun, Jang
EMC Technical Manager

This test report is not related to KS Q ISO/IEC 17025 and KOLAS.



REPORT REVISION HISTORY

Date	Test Report No.	Revision History
Jun. 14, 2019	KES-E1-19T0355	Issued
Jul. 16, 2019	KES-E1-19T0355-R1	Reissue due to uniqueness

This report shall not be reproduced except in full, without the written approval of KES Co., Ltd. This document may be altered or revised by KES Co., Ltd. personnel only, and shall be noted in the revision section of the document. Any alteration of this document not carried out by KES Co., Ltd. will constitute fraud and shall nullify the document.

This report shall not be reproduced except in full, without the written approval of KES Co., Ltd.
The results shown in this test report refer only to the sample(s) tested unless otherwise stated.
The authenticity of the test report, contact shchoi@kes.co.kr



TABLE OF CONTENTS

1.0	General Product Description.....	4
1.1	Test Voltage & Frequency	5
1.2	Variant Model Differences.....	5
1.3	Device Modifications	5
1.4	Equipment Under Test.....	5
1.5	Support Equipments	5
1.6	External I/O Cabling	6
1.7	EUT Operating Mode(s)	6
1.8	Configuration.....	7
1.9	Remarks when standards applied	8
1.10	Calibration Details of Equipment Used for Measurement.....	8
1.11	Test Facility	8
1.12	Laboratory Accreditations and Listings	8
2.0	Test Regulations.....	9
2.1	Conducted Emissions at Mains Power Ports	11
2.2	Radiated Electric Field Emissions(Below 1 GHz)	12
2.3	Radiated Electric Field Emissions(Above 1 GHz)	13
APPENDIX A – TEST DATA.....		14
	Conducted Emissions at Mains Power Ports.....	14
	Radiated Electric Field Emissions(Below 1 GHz)	16
	Radiated Electric Field Emissions(Above 1 GHz).....	18
	Test Setup Photos and Configuration	20
	Conducted Voltage Emissions	20
	Radiated Electric Field Emissions(Below 1 GHz)	21
	Radiated Electric Field Emissions(Above 1 GHz).....	22
	EUT External Photographs.....	23
	EUT Internal Photographs	24



1.0 General Product Description

Main Specifications of EUT are:

Item	Specification	Remarks
Model name	U1000	
Dimensions / Weight	64 x 111.5 x 32 mm / 112 g 2.5 x 4.4 x 1.3 inch / 0.24 lb	
Memory	microSD memory card	32 GB, 64 GB, 128 GB (UHS-I)
Recording mode	Continuous Rec	Records videos in 1-minute segments (dual channels are supported for recording the front and rear view)
	Incident Rec	Records 10 seconds before and after the incident (total 20 seconds)
	Manual Rec	Records from 10 seconds before and 50 seconds after manually starting the recording (total 1 minute)
	Parking Rec (parking mode)	(Optional)
	Audio Recording	Press the voice recording button to turn the audio recording on or off
Camera sensor	8.42M pixels, 1/1.8" Sony Exmor R STARVIS	
Angle of view (Lens)	Approximately 150° (diagonally)	
Video	UHD (3840 x 2160) / H.264 / file extension: MP4	
Frame rate	Maximum 30 fps	Applies equally to the front / rear recording
Audio	HE-AAC	
Acceleration sensor	3-axis acceleration sensor (3D, ±3G)	5 levels for sensitivity adjustment available
Rear camera (optional)	V-IN port	Optional accessory that requires separate purchase
GPS	Embedded GPS	Safety driving section alert supported
Power input	DC 12 / 24 V supported	
Power consumption	2ch: 5.1 W / 1ch: 3.1 W (mean)	Except for the fully charged supercapacitor / GPS
Auxiliary power unit	Super capacitor	
LED indicator	GPS LED, Rec LED, Wi-Fi LED	
Alarm	Built-in speakers	Voice guide (buzzer sounds)
Operating temperature	14 – 140°F / -10 – 60°C	
Storage temperature	-4 – 158°F / -20 – 70°C	
Connection Interface	1 x V-IN port	

This report shall not be reproduced except in full, without the written approval of KES Co., Ltd.
The results shown in this test report refer only to the sample(s) tested unless otherwise stated.
The authenticity of the test report, contact shchoi@kes.co.kr



1.1 Test Voltage & Frequency

Unless indicated otherwise on the individual data sheet or test results, the test voltage and frequency was as indicated below.

Voltage 230 Vac 120 Vac 24 Vdc 12 Vdc PoE

Frequency 50 Hz 60 Hz Hz

- The EUT uses only DC 12 V and DC 24 V for the vehicles.

1.2 Variant Model Differences

Not applicable

1.3 Device Modifications

Not applicable

1.4 Equipment Under Test

Description	Model Number	Serial Number	Manufacturer	Remarks
THINKWARE DASH CAM	U1000	-	THINKWARE CORPORATION	EUT
Micro SD	-	-	-	-

1.5 Support Equipments

Description	Model Number	Serial Number	Manufacturer	Remarks
REAR CAMERA	-	-	THINKWARE CORPORATION	-
RADAR	-	-	-	-
Cellphone	SM-A530N	-	Samsung Electronics Co., Ltd.	-



1.6 External I/O Cabling

Start		END		Cable Spec.	
Description	I/O Port	Description	I/O Port	Length	Shield
THINKWARE DASH CAM (EUT)	DC IN	DC POWER	DC OUT	1.5	U
	V-IN	REAR CAMERA	V-OUT	6.0	U
	RADAR	RADAR	RADAR	0.5	U
	Micro SD Slot	Micro SD	Micro SD Slot	-	-
	Wireless	iPhone	Wireless	-	-

* Unshielded=U, Shielded=S

1.7 EUT Operating Mode(s)

Test mode	operating
OP	Check the normal operation of the EUT with the iPhone(wifi connected)

EUT Test operating S/W		
Name	Version	Manufacture Company
-	-	-

This report shall not be reproduced except in full, without the written approval of KES Co., Ltd.
The results shown in this test report refer only to the sample(s) tested unless otherwise stated.
The authenticity of the test report, contact shchoi@kes.co.kr

1.8 Configuration

DC Main(DC 12 V)

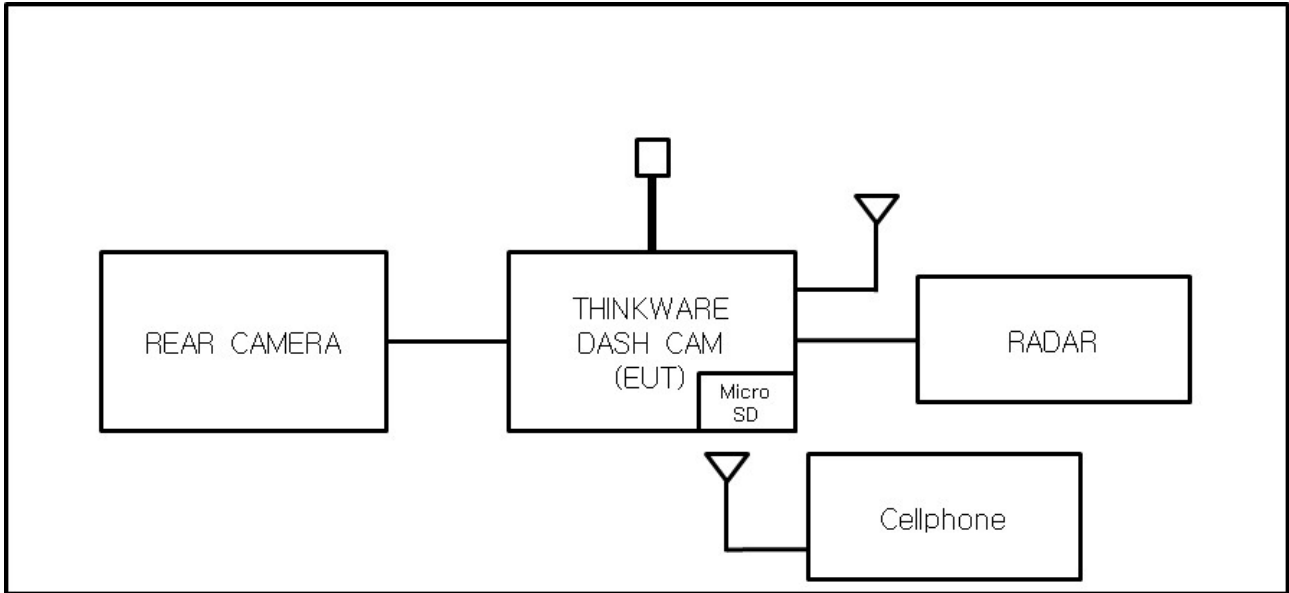

1.9 Remarks when standards applied

N/A







1.10 Calibration Details of Equipment Used for Measurement

Test equipment and test accessories are calibrated on regular basis. The maximum time between calibrations is one year or what is recommended by the manufacturer, whichever is less.

1.11 Test Facility

The measurement facility is located at 473-21 Gayeo-ro, Yeosu-si, Gyeonggi-do, 12658, Korea. The sites are constructed in conformance with the requirements of ANSI C63.4:2014 and CISPR 16-1-4:2012

1.12 Laboratory Accreditations and Listings

Country	Agency	Scope of Accreditation	Logo
KOREA	RRA	EMI (3 m & 10 m Semi-Anechoic Chamber ,10 m Open Area and conducted test site) EMS (ESD, RS, EFT/Burst, Surge, CS, Magnetic, Dips and interruptions)	 KR0100
International	KOLAS	EMI (3 m & 10 m Semi-Anechoic Chamber , and conducted test site) EMS (ESD, RS, EFT/Burst, Surge, CS, Magnetic, Dips and interruptions)	 KT489
USA	FCC	3 m & 10 m Semi-Anechoic Chamber, 10 m Open Area and Conducted test site to perform FCC Part 15/18 measurements.	 KR0100
Canada	ISED	3 m & 10 m Semi-Anechoic Chamber and Conducted test site	 23298-1
JAPAN	VCCI	Mains Ports Conducted Interference Measurement, Telecommunication Ports Conducted Disturbance Measurement and Radiation 10 meter site, Facility for measuring radiated disturbance above 1 GHz	 R-20056, C-20036, T-20040, G-20057
Europe	TÜV SÜD	EMI (3 m & 10 m Semi-Anechoic Chamber , 10 m Open Area and conducted test site) EMS (ESD, RS, EFT/Burst, Surge, CS, Magnetic, Dips and interruptions)	 CARAT 17 07 01633 001

This report shall not be reproduced except in full, without the written approval of KES Co., Ltd.
The results shown in this test report refer only to the sample(s) tested unless otherwise stated.
The authenticity of the test report, contact shchoi@kes.co.kr

2.0 Test Regulations

The emissions tests were performed according to following regulations:

EMC – Directive 2014/30/EU

EN 61000-6-3:2011

EN 61000-6-1:2007

EN 61000-6-4:2007 +A1:2011

EN 61000-6-2:2005

EN 55011:2007 +A1:2010

Group 1

Group 2

Class A

Class B

EN 55014-1:2006 +A2:2011

EN 55014-2:1997 +A2:2008

EN 55015:2013

EN 55032:2015

Class A

Class B

EN 55024:2010

EN 50130-4:2011 +A1:2014

EN 61000-3-2:2014

EN 61000-3-3:2013

EN 61326-1:2013



-
- | | | |
|--|---|----------------------------------|
| <input type="checkbox"/> VCCI V-3 / 2015.04 | <input type="checkbox"/> Class A | <input type="checkbox"/> Class B |
| <input type="checkbox"/> AS/NZS:2013 | <input type="checkbox"/> Class A | <input type="checkbox"/> Class B |
| <input checked="" type="checkbox"/> 47 CFR Part 15, Subpart B | | |
| <input type="checkbox"/> CISPR 22:2009 +A1:2010 | <input type="checkbox"/> Class A | <input type="checkbox"/> Class B |
| <input checked="" type="checkbox"/> ANSI C63.4-2014 | <input checked="" type="checkbox"/> Class A | <input type="checkbox"/> Class B |
| <input checked="" type="checkbox"/> IC Regulation ICES-003 : 2016 | | |
| <input type="checkbox"/> CAN/CSA CISPR 22-10 | <input type="checkbox"/> Class A | <input type="checkbox"/> Class B |
| <input checked="" type="checkbox"/> ANSI C63.4-2014 | <input checked="" type="checkbox"/> Class A | <input type="checkbox"/> Class B |
| <input type="checkbox"/> RE- Directive 2014/53/EU | | |
| <input type="checkbox"/> EN 301 489-1 V1.9.2 | | |
| <input type="checkbox"/> Equipment for fixed use | | |
| <input type="checkbox"/> Equipment for vehicular use | | |
| <input type="checkbox"/> Equipment for portable use | | |
| <input type="checkbox"/> EN 301 489-3 V1.6.1 | | |
| <input type="checkbox"/> EN 301 489-17 V2.2.1 | | |
| <input type="checkbox"/> EN 60945:2002 | | |

This report shall not be reproduced except in full, without the written approval of KES Co., Ltd.
The results shown in this test report refer only to the sample(s) tested unless otherwise stated.
The authenticity of the test report, contact shchoi@kes.co.kr

2.1 Conducted Emissions at Mains Power Ports

Test Date

N/A

Test Location

Electro wave Shieldroom #6

Test Equipment

Used	Description	Model Number	Manufacturer	Serial Number	Cal. Due
<input type="checkbox"/>	EMI Test S/W	EMC32	R & S	9.12.00	-
<input type="checkbox"/>	EMI TEST RECEIVER	ESR3	R & S	101781	04, 22, 2020
<input type="checkbox"/>	LISN	ENV216	R & S	101787	01, 04, 2020
<input type="checkbox"/>	LISN	ESH2-Z5	R & S	100450	04, 22, 2020
<input type="checkbox"/>	PULSE LIMITER	ESH3-Z2	R & S	101915	11, 26, 2019

Test ConditionsTemperature: °C
Relative Humidity: % R.H.**Frequency Range of Measurement**

150 kHz to 30 MHz

Instrument Settings

IF Band Width: 9 kHz

Test Results

The requirements are:

- PASS
 NOT PASS
 NOT APPLICABLE

Remarks

N/A : It is not applied, because The EUT uses only DC 12 V and DC 24 V for the vehicles.

2.2 Radiated Electric Field Emissions(Below 1 GHz)

Test Date

May. 24, 2019

Test Location

OPEN AREA TEST SITE #2 SEMI ANECHOIC CHAMBER #4(10 m)

Test Equipment

Used	Description	Model Number	Manufacturer	Serial Number	Cal. Due
<input checked="" type="checkbox"/>	EMI Test S/W	EP5/RE	TOYO Corporation	6.0.0	-
<input checked="" type="checkbox"/>	EMI TEST RECEIVER	ESU26	R & S	100551	04, 09, 2020
<input checked="" type="checkbox"/>	AMPLIFIER	SCU 01	R & S	100603	11, 26, 2019
<input checked="" type="checkbox"/>	TRILOG-BROADBAND ANTENNA	VULB9163	Schwarzbeck	715	11, 29, 2020
<input checked="" type="checkbox"/>	ATTENUATOR	8491A	HP	32173	03, 11, 2020

Test Conditions

Temperature: 22,9 °C
Relative Humidity: 48,7 % R.H.

Frequency Range of Measurement

30 MHz to 1 GHz

Instrument Settings

IF Band Width: 120 kHz

Test Results

The requirements are:

- PASS
 NOT PASS
 NOT APPLICABLE

Remarks

See Appendix A for test data.

2.3 Radiated Electric Field Emissions(Above 1 GHz)

Test Date

May. 24, 2019

Test Location

SEMI ANECHOIC CHAMBER #4(10 m)

Test Equipment

Used	Description	Model Number	Manufacturer	Serial Number	Cal. Due
<input checked="" type="checkbox"/>	EMI Test S/W	EP5/RE	TOYO Corporation	6.0.0	-
<input checked="" type="checkbox"/>	EMI TEST RECEIVER	ESU26	R & S	100551	04, 18, 2020
<input checked="" type="checkbox"/>	PREAMPLIFIER	8449B	AGILENT	3008A01742	01, 08, 2020
<input type="checkbox"/>	ATTENUATOR	8491A	HP	35496	03, 11, 2020
<input checked="" type="checkbox"/>	HORN ANTENNA	BBHA 9120D	SCHWARZBECK	9120D-1802	03, 12, 2020

Test Conditions

Temperature: 22,9 °C
Relative Humidity: 48,7 % R.H.

Frequency Range of Measurement

1 GHz to 6 GHz

Instrument Settings

IF Band Width: 1 MHz

Test Results

The requirements are:

- PASS
- NOT PASS
- NOT APPLICABLE

Remarks

See Appendix A for test data.



KES Co., Ltd.

3701, 40, Simin-daero 365beon-gil,
Dongan-gu, Anyang-si, Gyeonggi-do, 14057, Korea
Tel: +82-31-425-6200 / Fax: +82-31-424-0450
www.kes.co.kr

Report No.:
KES-E1-19T0355-R1
Page (14) of (27)

APPENDIX A – TEST DATA

- Part 15.107(b)

Conducted Emissions at Mains Power Ports

HOT LINE

N/A

This report shall not be reproduced except in full, without the written approval of KES Co., Ltd.
The results shown in this test report refer only to the sample(s) tested unless otherwise stated.
The authenticity of the test report, contact shchoi@kes.co.kr



KES Co., Ltd.

3701, 40, Simin-daero 365beon-gil,
Dongan-gu, Anyang-si, Gyeonggi-do, 14057, Korea
Tel: +82-31-425-6200 / Fax: +82-31-424-0450
www.kes.co.kr

Report No.:
KES-E1-19T0355-R1
Page (15) of (27)

- Part 15.107(b)

NEUTRAL LINE

N/A

◆ Calculation

QuasiPeak[$\text{dB}\mu\text{V}$] / CAverage [$\text{dB}\mu\text{V}$] = Reading Value[$\text{dB}\mu\text{V}$] + Corr. [dB]

QuasiPeak / CAverage : The Final Value

Reading Value : Not shown in the table.

Corr. : Correction values (LISN FACTOR + (Cable Loss + Pulse Limiter FACTOR))

This report shall not be reproduced except in full, without the written approval of KES Co., Ltd.
The results shown in this test report refer only to the sample(s) tested unless otherwise stated.
The authenticity of the test report, contact shchoi@kes.co.kr



Radiated Electric Field Emissions(Below 1 GHz)

- Part 15.109(b)

■ DC 12 V

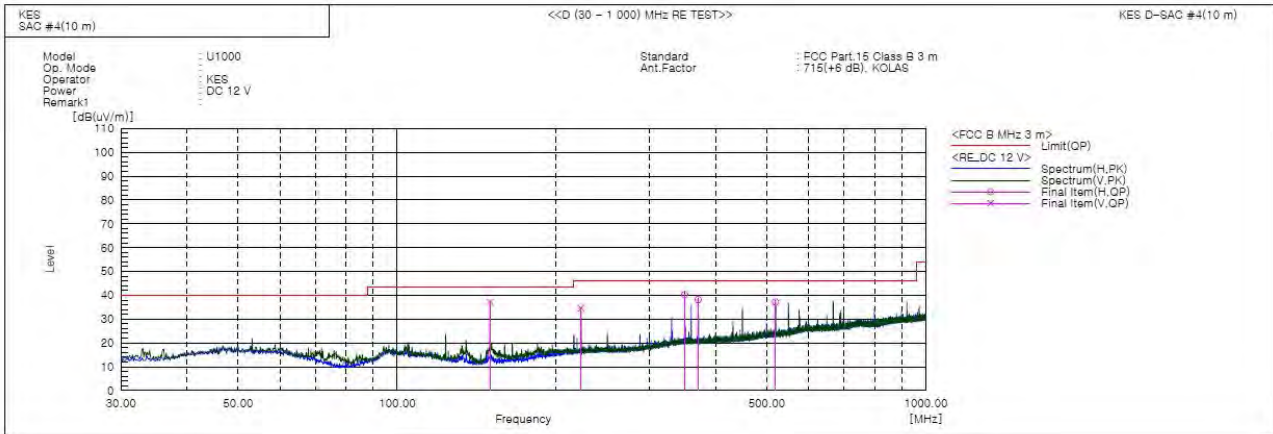

Final Result

No.	Frequency [MHz]	(P)	Reading QP [dB(uV)]	c.f [dB(1/m)]	Result QP [dB(uV/m)]	Limit QP [dB(uV/m)]	Margin QP [dB]	Height [cm]	Angle [deg]	Remark
1	150.003	V	63.9	-26.8	37.1	43.5	6.4	100.0	285.0	
2	222.788	V	56.1	-21.6	34.5	46.0	11.5	103.0	305.0	
3	349.979	H	57.9	-17.6	40.3	46.0	5.7	110.0	217.0	
4	371.198	H	55.4	-17.2	38.2	46.0	7.8	125.0	225.0	
5	519.729	H	51.1	-13.9	37.2	46.0	8.8	225.0	166.0	

This report shall not be reproduced except in full, without the written approval of KES Co., Ltd.
 The results shown in this test report refer only to the sample(s) tested unless otherwise stated.
 The authenticity of the test report, contact shchoi@kes.co.kr



- Part 15.109(b)
 ■ DC 24 V

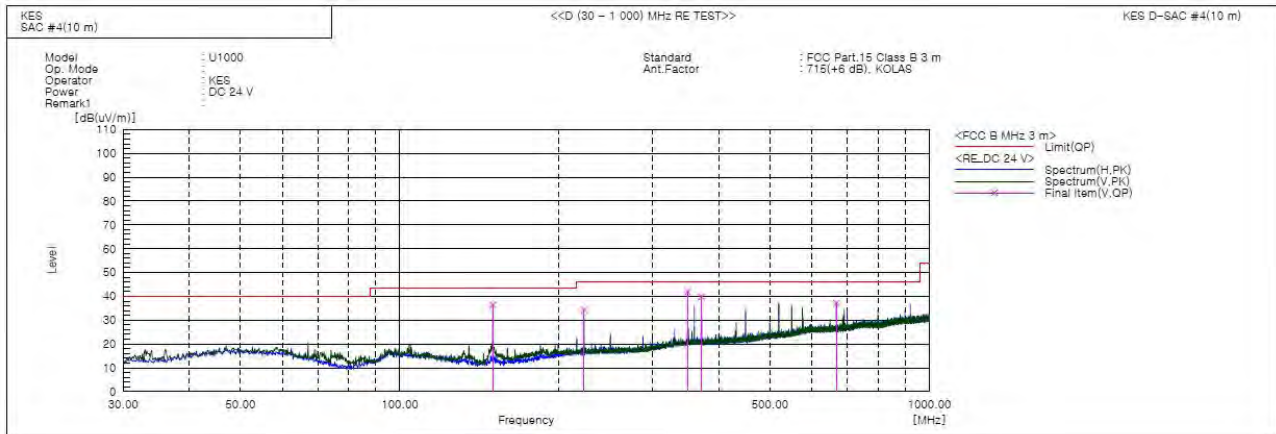

Final Result

No.	Frequency [MHz]	(P)	Reading QP [dB(uV)]	c.f [dB(1/m)]	Result QP [dB(uV/m)]	Limit QP [dB(uV/m)]	Margin QP [dB]	Height [cm]	Angle [deg]	Remark
1	149.916	V	63.1	-26.8	36.3	43.5	7.2	101.0	243.0	
2	349.997	V	59.5	-17.6	41.9	46.0	4.1	153.0	218.0	
3	371.198	V	57.0	-17.2	39.8	46.0	6.2	150.0	223.0	
4	222.788	V	55.9	-21.6	34.3	46.0	11.7	105.0	315.0	
5	668.260	V	47.9	-10.9	37.0	46.0	9.0	100.0	356.0	

◆ Calculation – SAC #4(10 m)

Result(QP) [dB(μV/m)] = (Reading(QP)[dB(μV)] + c.f[dB(1/m)])

Margin(QP)[dB] = Limit[dB(μV/m)] - Result(QP) [dB(μV/m)]

Reading(QP) : Reading value, Result(QP) : Reading value + Factor value

Limit(QP) : Limit value, c.f : (ANT Factor + Cable Loss - Preamp Factor), Margin: Margin value

This report shall not be reproduced except in full, without the written approval of KES Co., Ltd.
 The results shown in this test report refer only to the sample(s) tested unless otherwise stated.
 The authenticity of the test report, contact shchoi@kes.co.kr



Radiated Electric Field Emissions(Above 1 GHz)

- Part 15.109(b)

■ DC 12 V

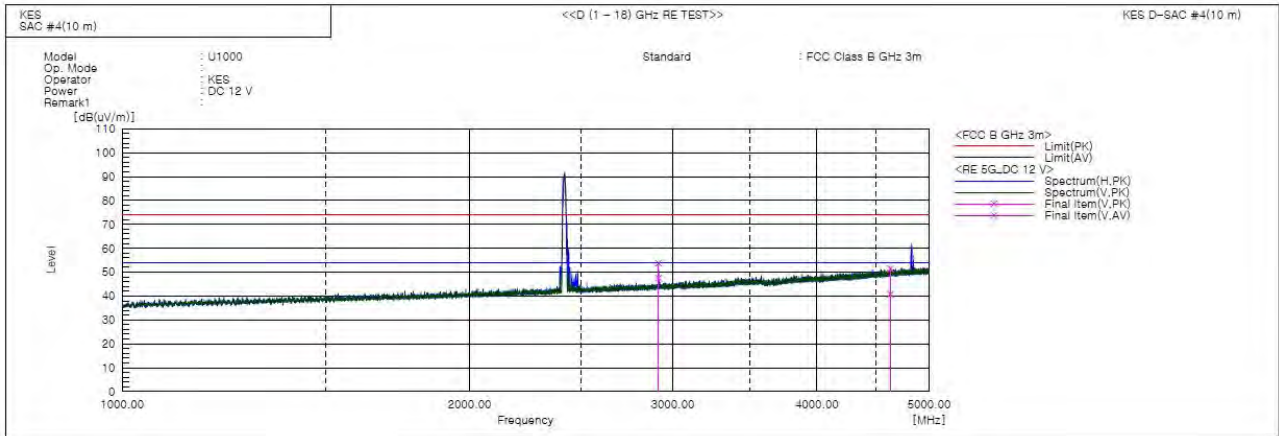

Final Result

No.	Frequency [MHz]	(P)	Reading PK [dB(uV)]	c.f [dB(1/m)]	Result PK [dB(uV/m)]	Limit PK [dB(uV/m)]	Limit AV [dB(uV/m)]	Margin PK [dB]	Height [cm]	Angle [deg]	Remark
1	2418.000	V	50.3	1.5	53.8	74.0	54.0	20.2	100.0	342.0	
2	2915.965	V	41.5	3.5	51.5	74.0	54.0	22.5	123.0	26.0	
3	4630.645	V	41.5	10.0	51.5	74.0	54.0	22.5	390.0	278.0	
4	4826.500	H	41.5	10.7	51.5	74.0	54.0	22.5	100.0	351.0	

This report shall not be reproduced except in full, without the written approval of KES Co., Ltd.
 The results shown in this test report refer only to the sample(s) tested unless otherwise stated.
 The authenticity of the test report, contact shchoi@kes.co.kr

- Part 15.109(b)

■ DC 24 V

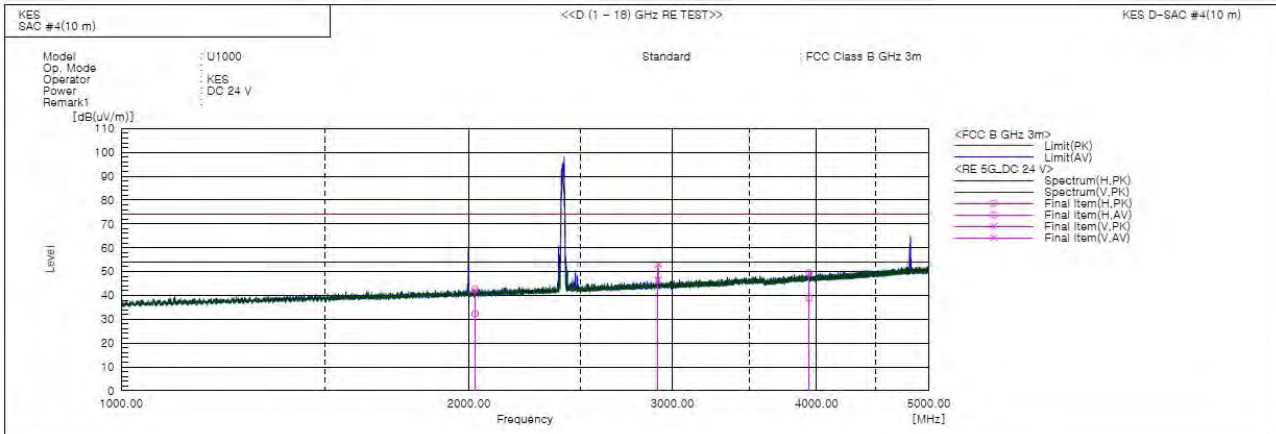

Final Result

No.	Frequency [MHz]	(P)	Reading PK [dB(uV)]	c.f [dB(1/m)]	Result PK [dB(uV/m)]	Limit PK [dB(uV/m)]	Limit AV [dB(uV/m)]	Margin PK [dB]	Height [cm]	Angle [deg]	Remark
1	2025.280	H	42.8	-0.3	42.5	74.0	54.0	31.5	140.0	128.0	
2	2418.500	H	-----	1.6	-----	74.0	54.0	-----	200.0	55.0	
3	2916.080	V	49.5	3.5	53.0	74.0	54.0	21.0	138.0	39.0	
4	3941.650	H	42.0	7.4	49.4	74.0	54.0	24.6	104.0	192.0	
5	4820.500	H	-----	10.7	-----	74.0	54.0	-----	200.0	47.0	

◆ Calculation

Result(PK/CAV) [dB(uV/m)] = (Reading(PK/CAV)[dB(uV)] + c.f[dB(1/m)])

Margin(PK/CAV)[dB] = Limit[dB(uV/m)] - Result(PK/CAV) [dB(uV/m)]

Reading(PK/CAV) : Reading value, Result(PK/CAV) : Reading value + Factor value

Limit(QP) : Limit value, c.f : (ANT Factor + Cable Loss - Preamp Factor), Margin: Margin value

This report shall not be reproduced except in full, without the written approval of KES Co., Ltd.
The results shown in this test report refer only to the sample(s) tested unless otherwise stated.
The authenticity of the test report, contact shchoi@kes.co.kr



KES Co., Ltd.

3701, 40, Simin-daero 365beon-gil,
Dongan-gu, Anyang-si, Gyeonggi-do, 14057, Korea
Tel: +82-31-425-6200 / Fax: +82-31-424-0450
www.kes.co.kr

Report No.:
KES-E1-19T0355-R1
Page (20) of (27)

Test Setup Photos and Configuration

Conducted Voltage Emissions

N/A

This report shall not be reproduced except in full, without the written approval of KES Co., Ltd.
The results shown in this test report refer only to the sample(s) tested unless otherwise stated.
The authenticity of the test report, contact shchoi@kes.co.kr

Radiated Electric Field Emissions(Below 1 GHz)

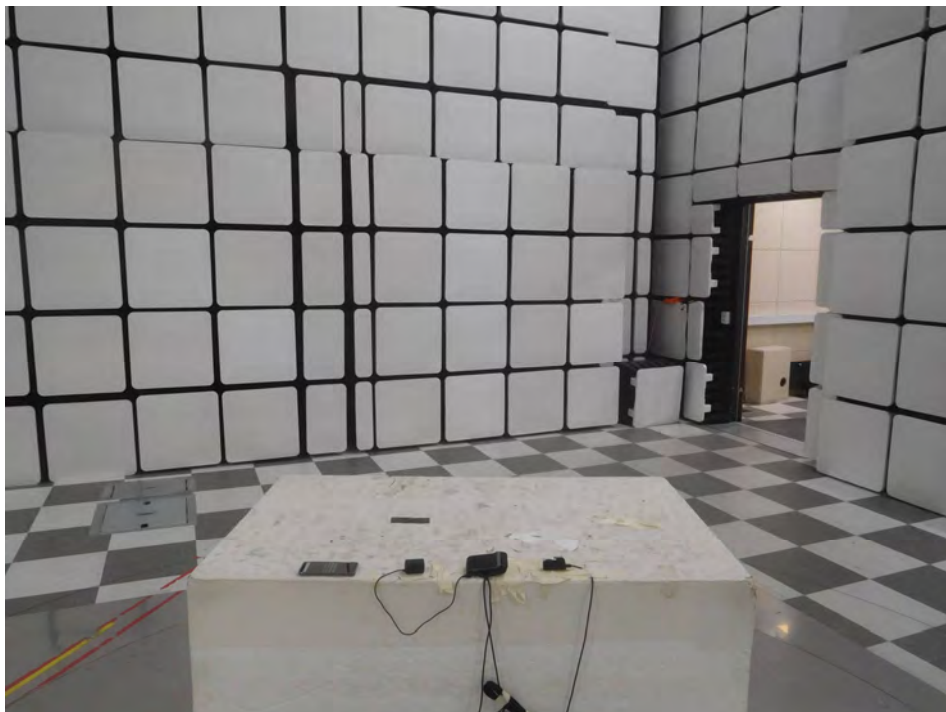
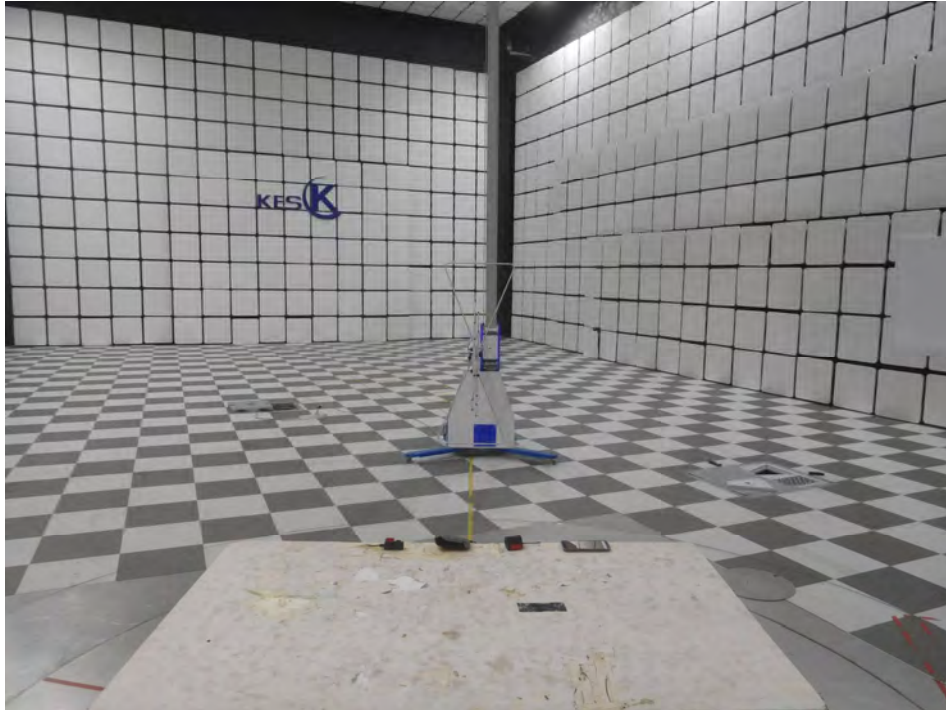

This report shall not be reproduced except in full, without the written approval of KES Co., Ltd.
The results shown in this test report refer only to the sample(s) tested unless otherwise stated.
The authenticity of the test report, contact shchoi@kes.co.kr

Radiated Electric Field Emissions(Above 1 GHz)

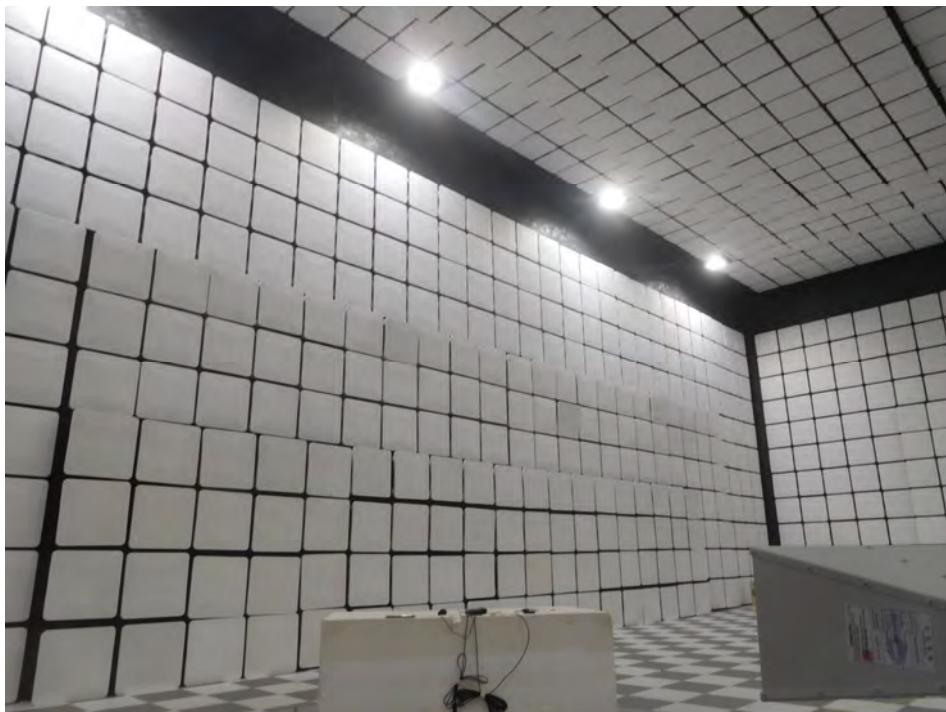
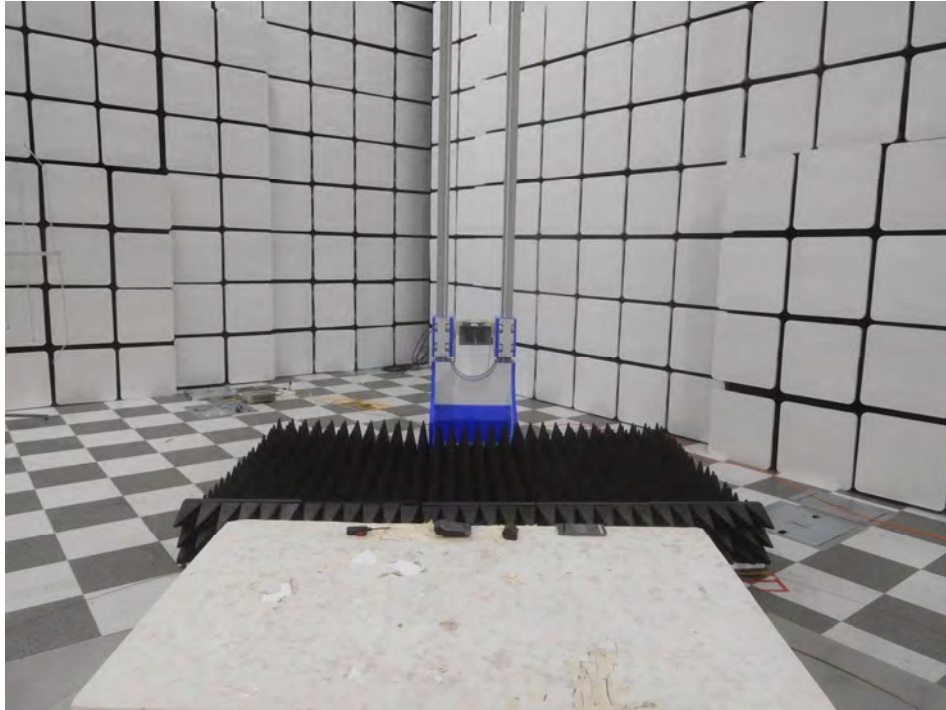

This report shall not be reproduced except in full, without the written approval of KES Co., Ltd.
The results shown in this test report refer only to the sample(s) tested unless otherwise stated.
The authenticity of the test report, contact shchoi@kes.co.kr

EUT External Photographs

(Top)



(Bottom)



This report shall not be reproduced except in full, without the written approval of KES Co., Ltd.
The results shown in this test report refer only to the sample(s) tested unless otherwise stated.
The authenticity of the test report, contact shchoi@kes.co.kr

EUT Internal Photographs

(Internal View)



This report shall not be reproduced except in full, without the written approval of KES Co., Ltd.
The results shown in this test report refer only to the sample(s) tested unless otherwise stated.
The authenticity of the test report, contact shchoi@kes.co.kr

EUT Internal View – Board 1



This report shall not be reproduced except in full, without the written approval of KES Co., Ltd.
The results shown in this test report refer only to the sample(s) tested unless otherwise stated.
The authenticity of the test report, contact shchoi@kes.co.kr

EUT Internal View – Board 2



This report shall not be reproduced except in full, without the written approval of KES Co., Ltd.
The results shown in this test report refer only to the sample(s) tested unless otherwise stated.
The authenticity of the test report, contact shchoi@kes.co.kr

Label Photographs



CAN ICES-3(A) / NMB-3(A)

This device complies with part 15 of the FCC Rules. Operation is subject to the following two conditions: (1) This device may not cause harmful interference, and (2) this device must accept any interference received, including interference that may cause undesired operation

This device complies with Industry Canada license-exempt RSS standard(s). Operation is subject to the following two conditions: (1) this device may not cause interference, and (2) this device must accept any interference, including interference that may cause undesired operation of the device.

Le présent appareil est conforme aux CNR d'Industrie Canada applicables aux appareils radio exempts de licence. L'exploitation est autorisée aux deux conditions suivantes :

(1) l'appareil ne doit pas produire de brouillage, et (2) l'utilisateur de l'appareil doit accepter tout brouillage radioélectrique subi, même si le brouillage est susceptible d'en compromettre le fonctionnement.