

FCC SAR

Measurement and Test Report

For

Shenzhen KVD Communication Equipment

13C, Block C, Shenzhen Electronic Technology Building,

Shennan Middle Road, Futian District, Shenzhen City, China

FCC ID: 2ADTE-Y100

FCC Rules:	FCC 47 CFR Part 2 (2.1093) ANSI/IEEE C95.1-1992 IEEE 1528-2003 <u>FCC OET Bulletin 65C (Edition 01-01)</u>
Product Description:	<u>Mobile Phone</u>
Tested Model:	<u>VALENCIA2 Y100</u>
Report No.:	<u>STR15068098E</u>
Tested Date:	<u>2015-06-18 to 2015-06-19</u>
Issued Date:	<u>2015-06-22</u>
Tested By:	<u>Lucy Wei / Engineer</u> <i>Lucy Wei</i>
Reviewed By:	<u>Lahm Peng / EMC Manager</u> <i>Lahm peng</i>
Approved & Authorized By:	<u>Jandy so / PSQ Manager</u> <i>Jandyso</i>
Prepared By:	Shenzhen SEM.Test Technology Co., Ltd. 1/F, Building A, Hongwei Industrial Park, Liuxian 2nd Road, Bao'an District, Shenzhen, P.R.C. (518101) Tel.: +86-755-33663308 Fax.: +86-755-33663309 Website: www.semtest.com.cn

Note: This test report is limited to the above client company and the product model only. It may not be duplicated without prior permitted by Shenzhen SEM.Test Technology Co., Ltd.

TABLE OF CONTENTS

1. General Information	3
1.1 Product Description for Equipment Under Test (EUT).....	3
1.2 Test Standards	6
1.3 Test Methodology.....	6
1.4 Test Facility	6
2. Summary of Test Results	7
3. Specific Absorption Rate (SAR).....	8
3.1 Introduction.....	8
3.2 SAR Definition	8
4. SAR Measurement System.....	9
4.1 The Measurement System	9
4.2 Probe.....	9
4.3 Probe Calibration Process.....	11
4.4 Phantom	12
4.5 Device Holder.....	12
4.6 Test Equipment List.....	13
5. Tissue Simulating Liquids.....	14
5.1 Composition of Tissue Simulating Liquid.....	14
5.2 Tissue Dielectric Parameters for Head and Body Phantoms.....	15
5.3 Tissue Calibration Result.....	16
6. SAR Measurement Evaluation	17
6.1 Purpose of System Performance Check.....	17
6.2 System Setup	17
6.3 Validation Results.....	18
7. EUT Testing Position	19
7.1 Define Two Imaginary Lines on The Handset.....	19
7.2 Cheek Position	20
7.3 Tilted Position.....	20
7.4 Body Worn Position	21
7.5 EUT Antenna Position	21
7.6 EUT Testing Position.....	22
8. SAR Measurement Procedures.....	23
8.1 Measurement Procedures	23
8.2 Spatial Peak SAR Evaluation	23
8.3 Area & Zoom Scan Procedures.....	24
8.4 Volume Scan Procedures.....	24
8.5 SAR Averaged Methods	24
8.6 Power Drift Monitoring.....	24
9. SAR Test Result	25
9.1 Conducted RF Output Power	25
9.2 Test Results for Standalone SAR Test.....	27
9.3 Simultaneous Multi-band Transmission SAR Analysis	30
10. Measurement Uncertainty	31
10.1 Uncertainty for EUT SAR Test.....	31
10.2 Uncertainty for System Performance Check.....	32
Annex A. Plots of System Performance Check	33
Annex B. Plots of SAR Measurement.....	41
Annex C. EUT Photos	113
Annex D. Test Setup Photos	114
Annex E. Calibration Certificate.....	116

1. General Information

1.1 Product Description for Equipment Under Test (EUT)

Client Information

Applicant: Shenzhen KVD Communication Equipment
 Address of applicant: 13C, Block C, Shenzhen Electronic Technology Building,
 Shennan Middle Road, Futian District, Shenzhen City, China

Manufacturer: The same as above

Address of manufacturer: The same as above

General Description of EUT	
Product Name:	Mobile Phone
Trade Name:	DOOGEE
Model No.:	VALENCIA2 Y100
Adding Model(s):	N/A
Hardware Version:	S316-W05
Software Version:	DOOGEE-Valencia2-Y100-Android4.4-V01
Device Category:	Portable Device
Rated Voltage:	DC 3.8V
Battery:	Capacity:2200mAh
<p><i>The EUT is dual band GSM 850/900/1800/1900 MHz, WCDMA 850/1900/2100MHz, Mobile Phone. The Mobile Phone is intended for speech and Multimedia Message Service (MMS) transmission. It is equipped with GPRS class 12 for GSM 850/900/1800/1900 and Wi-Fi, Bluetooth, GPS, and camera functions. For more information see the following datasheet.</i></p> <p><i>Note: The test data is gathered from a production sample, provided by the manufacturer</i></p>	

Technical Characteristics of EUT	
2G	
Support Networks:	GSM,GPRS
Support Band:	GSM 850/GSM 900/DCS 1800/PCS 1900
Uplink Frequency:	GSM/GPRS 850: 824~849MHz GSM/GPRS 1900: 1850~1910MHz
Downlink Frequency:	GSM/GPRS 850: 869~894MHz GSM/GPRS 1900: 1930~1990MHz
RF Output Power:	GSM 850: 32.35dBm,PCS1900:29.18dBm
Type of Modulation:	GSM,GPRS:GMSK
Antenna Type:	internal permanent antenna
Antenna Gain:	GSM 850: -1.0dBi,PCS1900: -1.0dBi
GPRS Class:	12
3G	
Support Networks:	WCDMA, HSDPA, HSUPA
Support Band:	WCDMA Band I,WCDMA Band II, WCDMA Band V
Uplink Frequency:	WCDMA Band II: 1850-1910MHz WCDMA Band V: 824~849MHz
Downlink Frequency:	WCDMA Band II: 1930~1990MHz WCDMA Band V: 869~894MHz
RF Output Power:	WCDMA Band II: 22.47dBm,WCDMA Band V: 22.66dBm
Type of Modulation:	WCDMA:BPSK
Antenna Type:	internal permanent antenna
Antenna Gain:	WCDMA Band II: -1.0dBi,WCDMA Band V: -1.0dBi
WLAN (Wi-Fi)	
Support Standards:	802.11b/g/n HT20/n HT40
Frequency Range:	802.11b/g/n HT20: 2412-2462MHz 802.11n HT40: 2422-2452MHz
RF Output Power:	9.48dBm(Conducted)
Type of Modulation:	CCK, OFDM
Data Rate:	1-11Mbps,6-54 Mbps, up to 150 Mbps,
Channel Separation:	5MHz
Antenna Type:	internal permanent antenna
Antenna Gain:	0dBi
Bluetooth	
Bluetooth Version:	Bluetooth v4.0 with BLE
Frequency Range:	2402-2480MHz

RF Output Power:	4.2dBm(Conducted)
Type of Modulation:	GFSK, Pi/4 DQPSK,8DPSK
Quantity of Channels:	79/40
Antenna Type:	internal permanent antenna
Antenna Gain:	0dBi

1.2 Test Standards

The following report is prepared on behalf of the Shenzhen KVD Communication Equipment in accordance with FCC 47 CFR Part 2.1093, ANSI/IEEE C95.1-1992, IEEE 1528-2003 and KDB 865664 D01 v01r03 and KDB 865664 D02 v01r01.

The objective is to determine compliance with FCC Part 2.1093 of the Federal Communication Commissions rules.

Maintenance of compliance is the responsibility of the manufacturer. Any modification of the product, which result in lowering the emission, should be checked to ensure compliance has been maintained.

1.3 Test Methodology

All measurements contained in this report were conducted with FCC OET Bulletin 65 Supplement C. The public notice KDB 447498 D01 V05 for Mobile and Portable Devices RF Exposure Procedure also.

1.4 Test Facility

FCC – Registration No.: 934118

Shenzhen SEM.Test Technology Co., Ltd. EMC Laboratory has been registered and fully described in a report filed with the (FCC) Federal Communications Commission. The acceptance letter from the FCC is maintained in our files and the Registration is 934118.

Industry Canada (IC) Registration No.: 11464A

The 3m Semi-anechoic chamber of Shenzhen SEM.Test Technology Co., Ltd. has been registered by Certification and Engineering Bureau of Industry Canada for radio equipment testing with Registration No.: 11464A.

CNAS Registration No.: L4062

Shenzhen SEM.Test Technology Co., Ltd. is a testing organization accredited by China National Accreditation Service for Conformity Assessment (CNAS) according to ISO/IEC 17025. The accreditation certificate number is L4062. All measurement facilities used to collect the measurement data are located at 1/F, Building A, Hongwei Industrial Park, Liuxian 2nd Road, Bao'an District, Shenzhen, P.R.C (518101).

2. Summary of Test Results

The maximum results of Specific Absorption Rate (SAR) have found during testing are as follows:

Frequency Band	Position	Scaled SAR _{1g} (W/kg)
GSM850	Head	0.38
GSM1900	Head	0.04
WCDMA Band V	Head	0.30
WCDMA Band II	Head	0.57
GSM850	Hotspot/Body-worn (1cm Gap)	0.72
GSM1900	Hotspot/Body-worn (1cm Gap)	1.27
WCDMA Band V	Hotspot/Body-worn (1cm Gap)	0.42
WCDMA Band II	Hotspot/Body-worn (1cm Gap)	0.24

The highest reported SAR values for head, body-worn accessory and product specific (wireless router) are 0.57 W/kg, 1.27 W/kg and 1.27 W/kg respectively.

The device is in compliance with Specific Absorption Rate (SAR) for general population/uncontrolled exposure limits (1.6 W/kg) specified in FCC 47 CFR Part 2.1093 and ANSI/IEEE C95.1-1992, and had been tested in accordance with the measurement methods and procedure specified in IEEE 1528-2003 and KDB 865664 D01 v01r03 and KDB865664 D02 v01r01.

3. Specific Absorption Rate (SAR)

3.1 Introduction

SAR is related to the rate at which energy is absorbed per unit mass in an object exposed to a radio field. The SAR distribution in a biological body is complicated and is usually carried out by experimental techniques or numerical modeling. The standard recommends limits for two tiers of groups, occupational/controlled and general population/uncontrolled, based on a person's awareness and ability to exercise control over his or her exposure. In general, occupational/controlled exposure limits are higher than the limits for general population/uncontrolled.

3.2 SAR Definition

The SAR definition is the time derivative (rate) of the incremental energy (dW) absorbed by (dissipated in) an incremental mass (dm) contained in a volume element (dv) of a given density (ρ). The equation description is as below:

$$\mathbf{SAR} = \frac{d}{dt} \left(\frac{dW}{dm} \right) = \frac{d}{dt} \left(\frac{dW}{\rho dv} \right)$$

SAR is expressed in units of Watts per kilogram (W/kg)

SAR measurement can be either related to the temperature elevation in tissue by

$$\mathbf{SAR} = C \left(\frac{\delta T}{\delta t} \right)$$

Where: C is the specific heat capacity, δT is the temperature rise and δt is the exposure duration, or related to the electrical field in the tissue by

$$\mathbf{SAR} = \frac{\sigma |E|^2}{\rho}$$

Where: σ is the conductivity of the tissue, ρ is the mass density of the tissue and E is the RMS electrical field strength.

However for evaluating SAR of low power transmitter, electrical field measurement is typically applied.

4. SAR Measurement System

4.1 The Measurement System

Comosar is a system that is able to determine the SAR distribution inside a phantom of human being according to different standards. The Comosar system consists of the following items:

- Main computer to control all the system
- 6 axis robot
- Data acquisition system
- Miniature E-field probe
- Phone holder
- Head simulating tissue

The following figure shows the system.



The EUT under test operating at the maximum power level is placed in the phone holder, under the phantom, which is filled with head simulating liquid. The E-Field probe measures the electric field inside the phantom. The OpenSAR software computes the results to give a SAR value in a 1g or 10g mass.

4.2 Probe

For the measurements the Specific Dosimetric E-Field Probe SN 37/08 EP80 with following specifications is used

- Dynamic range: 0.01-100 W/kg
- Tip Diameter : 5 mm
- Distance between probe tip and sensor center: 2.5mm
- Distance between sensor center and the inner phantom surface: 4 mm (repeatability better than +/- 1mm)
- Probe linearity: <0.25 dB
- Axial Isotropy: <0.25 dB

- Spherical Isotropy: <math>< 0.50\text{ dB}</math>
- Calibration range: 835 to 2500MHz for head & body simulating liquid.
- Angle between probe axis (evaluation axis) and surface normal line: less than 30°

Probe calibration is realized, in compliance with EN 62209-1 and IEEE 1528 STD, with CALISAR, Antennas proprietary calibration system. The calibration is performed with the EN 62209-1 annexe technique using reference guide at the five frequencies.

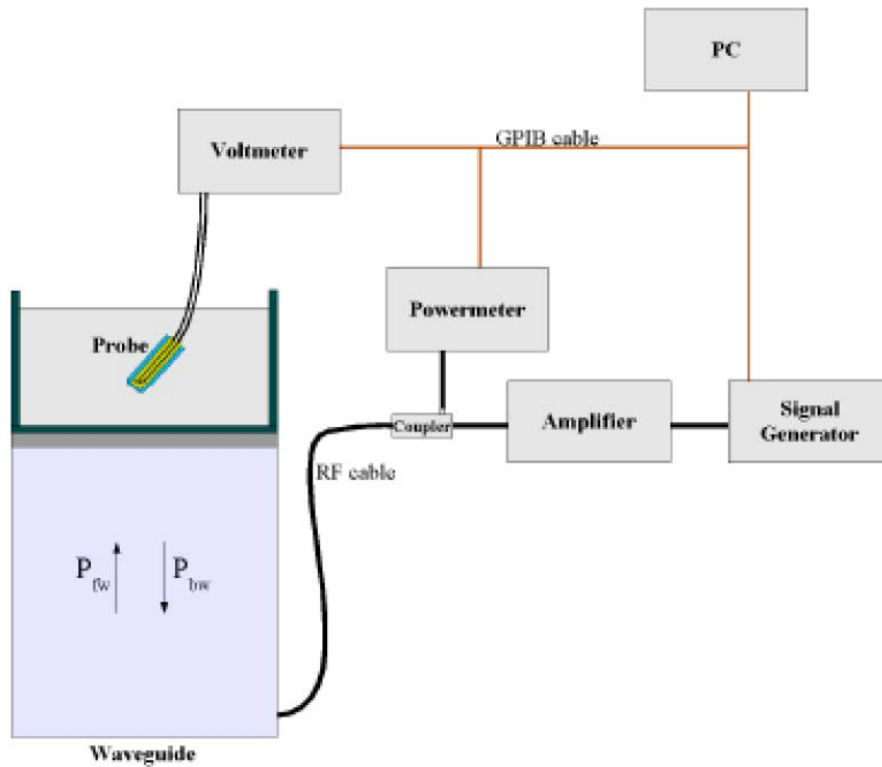

$$SAR = \frac{4(P_{fw} - P_{bw})}{ab\delta} \cos^2\left(\pi \frac{y}{a}\right) e^{-2z/\delta}$$

Where :

P_{fw} = Forward Power

P_{bw} = Backward Power

a and b = Waveguide dimensions

δ = Skin depth

Keithley configuration:

Rate = Medium; Filter = ON; RDGS = 10; Filter type = Moving Average; Range auto after each calibration, a SAR measurement is performed on a validation dipole and compared with a NPL calibrated probe, to verify it.

The calibration factors, CF(N), for the 3 sensors corresponding to dipole 1, dipole 2 and dipole 3 are:

$$CF(N)=SAR(N)/V_{lin}(N) \quad (N=1,2,3)$$

The linearised output voltage $V_{lin}(N)$ is obtained from the displayed output voltage $V(N)$ using

$$V_{lin}(N)=V(N)*(1+V(N)/DCP(N)) \quad (N=1,2,3)$$

where DCP is the diode compression point in mV.

4.3 Probe Calibration Process

Dosimetric Assessment Procedure

Each E-Probe/Probe Amplifier combination has unique calibration parameters. SATIMO Probe calibration procedure is conducted to determine the proper amplifier settings to enter in the probe parameters. The amplifier settings are determined for a given frequency by subjecting the probe to a known E-field density (1 mW/cm²) using an with CALISAR, Antenna proprietary calibration system.

Free Space Assessment Procedure

The free space E-field from amplified probe outputs is determined in a test chamber. This calibration can be performed in a TEM cell if the frequency is below 1 GHz and in a waveguide or other methodologies above 1 GHz for free space. For the free space calibration, the probe is placed in the volumetric center of the cavity and at the proper orientation with the field. The probe is rotated 360 degrees until the three channels show the maximum reading. The power density readings equates to 1mW/cm².

Temperature Assessment Procedure

E-field temperature correlation calibration is performed in a flat phantom filled with the appropriate simulated head tissue. The E-field in the medium correlates with the temperature rise in the dielectric medium. For temperature correlation calibration a RF transparent thermistor-based temperature probe is used in conjunction with the E-field probe.

Where:

$$SAR = C \frac{\Delta T}{\Delta t}$$

Δt = exposure time (30 seconds),

C = heat capacity of tissue (brain or muscle),

ΔT = temperature increase due to RF exposure.

SAR is proportional to $\Delta T / \Delta t$, the initial rate of tissue heating, before thermal diffusion takes place. The electric field in the simulated tissue can be used to estimate SAR by equating the thermally derived SAR to that with the E- field component.

$$\text{SAR} = \frac{|\mathbf{E}|^2 \cdot \sigma}{\rho}$$

Where:

σ = simulated tissue conductivity,

ρ = Tissue density (1.25 g/cm³ for brain tissue)

4.4 Phantom

For the measurements the Specific Anthropomorphic Mannequin (SAM) defined by the IEEE SCC-34/SC2 group is used. The phantom is a polyurethane shell integrated in a wooden table. The thickness of the phantom amounts to 2mm +/- 0.2mm. It enables the dosimetric evaluation of left and right phone usage and includes an additional flat phantom part for the simplified performance check. The phantom set-up includes a cover, which prevents the evaporation of the liquid.

4.5 Device Holder

The positioning system allows obtaining cheek and tilting position with a very good accuracy. In compliance with CENELEC, the tilt angle uncertainty is lower than 1°.

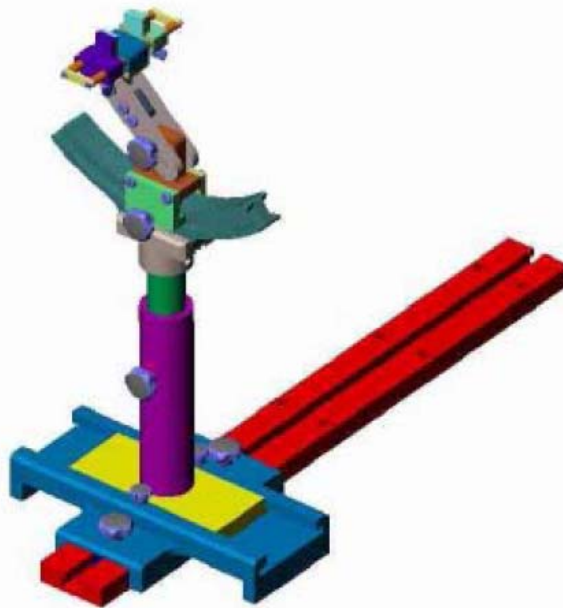

System Material	Permittivity	Loss Tangent
Delrin	3.7	0.005

4.6 Test Equipment List

Description	Manufacturer	Model	Serial Number	Cal. Date	Due. Date
E-Field Probe	SATIMO	SSE5	SN 09/13 EP168	2015-03-16	2016-03-17
835MHz Dipole	SATIMO	SID835	SN 47/12 DIP 0G835-204	2015-03-16	2016-03-17
1900MHz Dipole	SATIMO	SID1900	SN 47/12 DIP 1G900-207	2015-03-16	2016-03-17
Dielectric Probe	SATIMO	SCLMP	SN 47/12 OCPG49	2015-03-16	2016-03-17
SAM Phantom	SATIMO	SAM	SN/ 47/12 SAM95	N/A	N/A
Multi Meter	Keithley	Keithley 2000	4006367	2014-06-28	2015-06-27
Signal Generator	Rohde & Schwarz	SMR20	100047	2014-06-28	2015-06-27
Universal Tester	Rohde & Schwarz	CMU200	112012	2014-06-28	2015-06-27
Directional Coupler	Agilent	87300B	3123C03573	2014-06-28	2015-06-27

5. Tissue Simulating Liquids

5.1 Composition of Tissue Simulating Liquid

For the measurement of the field distribution inside the SAM phantom with SMTIMO, the phantom must be filled with around 25 liters of homogeneous body tissue simulating liquid. For head SAR testing, the liquid height from the ear reference point (ERP) of the phantom to the liquid top surface is larger than 15 cm. For body SAR testing, the liquid height from the center of the flat phantom to the liquid top surface is larger than 15 cm. Please see the following photos for the liquid height.

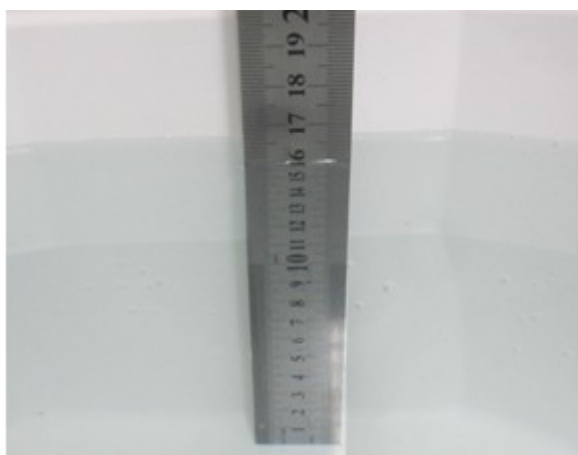

Liquid Height for Head SAR



Liquid Height for Body SAR

The Composition of Tissue Simulating Liquid

Frequency (MHz)	Water (%)	Salt (%)	Triton (%)	HEC (%)	Preventol (%)	DGBE (%)
Head						
835	35.34	0.98	0.00	0.00	63.68	0.00
1900	55.26	0.52	30.40	0.00	0.00	13.82
2450	55.44	0.32	30.50	0.00	0.00	13.74
Body						
835	52.87	1.07	0.00	0.00	46.10	0.00
1900	69.99	0.41	20.66	0.00	0.00	8.93
2450	70.56	0.35	20.88	0.00	0.00	8.21

5.2 Tissue Dielectric Parameters for Head and Body Phantoms

The head tissue dielectric parameters recommended by the IEEE SCC-34/SC-2 in P1528 have been incorporated in the following table. These head parameters are derived from planar layer models simulating the highest expected SAR for the dielectric properties and tissue thickness variations in a human head. Other head and body tissue parameters that have not been specified in P1528 are derived from the tissue dielectric parameters computed from the 4-Cole-Cole equations described in Reference [12] and extrapolated according to the head parameters specified in P1528.

Target Frequency (MHz)	Head		Body	
	Conductivity (σ)	Permittivity (ϵ_r)	Conductivity (σ)	Permittivity (ϵ_r)
150	0.76	52.3	0.80	61.9
300	0.87	45.3	0.92	58.2
450	0.87	43.5	0.94	56.7
835	0.90	41.5	0.97	55.2
900	0.97	41.5	1.05	55.0
915	0.98	41.5	1.06	55.0
1450	1.20	40.5	1.30	54.0
1610	1.29	40.3	1.40	53.8
1800-2000	1.40	40.0	1.52	53.3
2450	1.80	39.2	1.95	52.7
3000	2.40	38.5	2.73	52.0
5800	5.27	35.3	6.00	48.2

5.3 Tissue Calibration Result

The dielectric parameters of the liquids were verified prior to the SAR evaluation using COMOSAR Dielectric Probe Kit and an Agilent Network Analyzer.

Calibration Result for Dielectric Parameters of Tissue Simulating Liquid

Head Tissue Simulating Liquid									
Freq. MHz.	Temp. (°C)	Conductivity			Permittivity			Limit (%)	Date
		Reading (σ)	Target (σ)	Delta (%)	Reading (ϵ_r)	Target (ϵ_r)	Delta (%)		
835	21.2	0.87	0.90	-3.3	41.11	41.5	-0.9	±5	06-18-2015
1900	21.3	1.38	1.40	-1.4	38.56	40.0	-3.6	±5	06-19-2015

Body Tissue Simulating Liquid									
Freq. MHz.	Temp. (°C)	Conductivity			Permittivity			Limit (%)	Date
		Reading (σ)	Target (σ)	Delta (%)	Reading (ϵ_r)	Target (ϵ_r)	Delta (%)		
835	21.2	0.95	0.97	-2.0	54.85	55.2	-0.6	±5	06-18-2015
1900	21.3	1.50	1.52	-1.3	52.42	53.3	-1.7	±5	06-19-2015

6. SAR Measurement Evaluation

6.1 Purpose of System Performance Check

The system performance check verifies that the system operates within its specifications. System and operator errors can be detected and corrected. It is recommended that the system performance check be performed prior to any usage of the system in order to guarantee reproducible results. The system performance check uses normal SAR measurements in a simplified setup with a well characterized source. This setup was selected to give a high sensitivity to all parameters that might fail or vary over time. The system check does not intend to replace the calibration of the components, but indicates situations where the system uncertainty is exceeded due to drift or failure.

6.2 System Setup

In the simplified setup for system evaluation, the EUT is replaced by a calibrated dipole and the power source is replaced by a continuous wave which comes from a signal generator at frequency 835 MHz and 1900 MHz. The calibrated dipole must be placed beneath the flat phantom section of the SAM twin phantom with the correct distance holder. The distance holder should touch the phantom surface with a light pressure at the reference marking and be oriented parallel to the long side of the phantom.

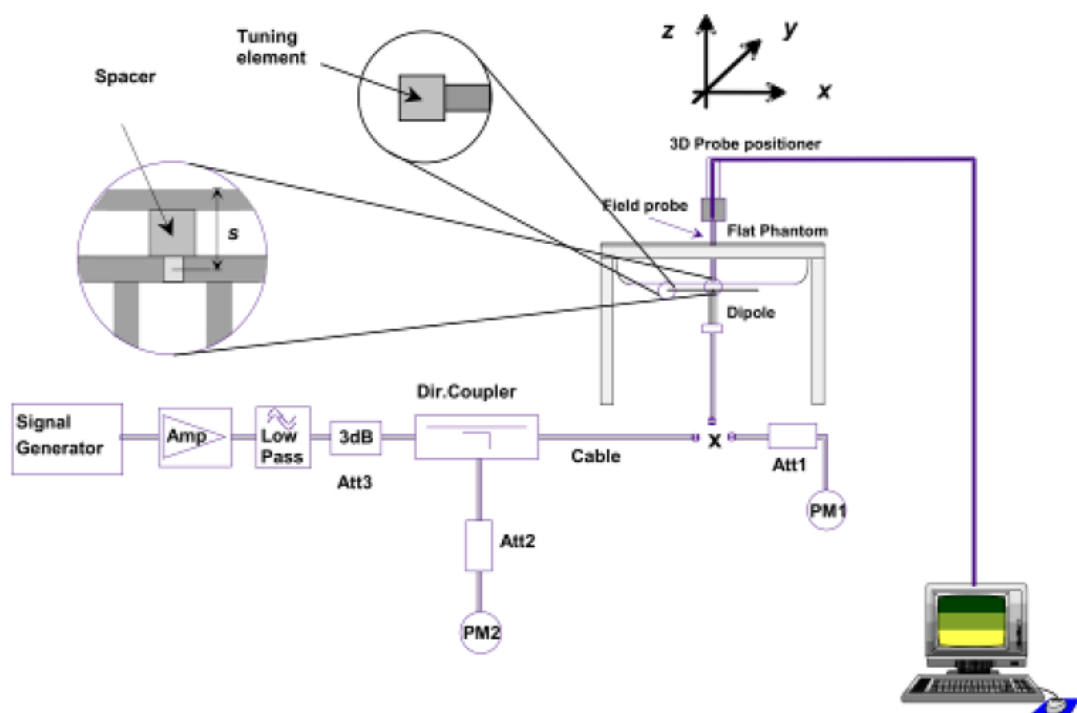

Fig 7.1 System Verification Setup Block Diagram



Fig 7.2 Setup Photo of Dipole Antenna

The output power on dipole port must be calibrated to 24 dBm (250 mW) before dipole is connected.

6.3 Validation Results

Comparing to the original SAR value provided by SATIMO, the validation data should be within its specification of 10 %. Table 7.2 shows the target SAR and measured SAR after normalized to 1W input power. The table below indicates the system performance check can meet the variation criterion.

Frequency	Liquid	Targeted SAR _{1g}	Measured SAR _{1g}	Normalized SAR _{1g}	Tolerance
MHz	(Head/Body)	(W/kg)	(W/kg)	(W/kg)	(%)
835	Head	9.56	2.41	9.65	0.94
1900	Head	39.70	9.90	39.59	-0.28
835	Body	9.56	2.34	9.36	-2.09
1900	Body	39.70	9.75	39.01	-1.74

Table 7.2 Targeted and Measurement SAR

Please refer to Annex A for the plots of system performance check.

7. EUT Testing Position

7.1 Define Two Imaginary Lines on The Handset

- (a) The vertical centerline passes through two points on the front side of the handset - the midpoint of the width w_t of the handset at the level of the acoustic output, and the midpoint of the width w_b of the bottom of the handset.
- (b) The horizontal line is perpendicular to the vertical centerline and passes through the center of the acoustic output. The horizontal line is also tangential to the face of the handset at point A.
- (c) The two lines intersect at point A. Note that for many handsets, point A coincides with the center of the acoustic output; however, the acoustic output may be located elsewhere on the horizontal line. Also note that the vertical centerline is not necessarily parallel to the front face of the handset, especially for clamshell handsets, handsets with flip covers, and other irregularly shaped handsets.

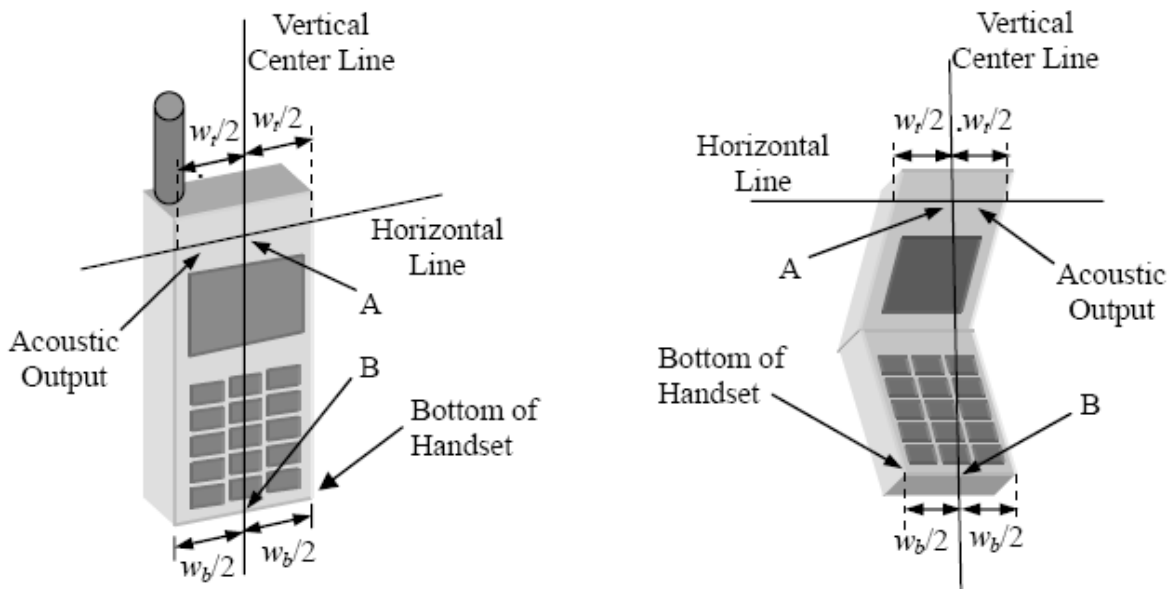

Fig 7.1 Illustration for Handset Vertical and Horizontal Reference Lines

7.2 Cheek Position

(a) To position the device with the vertical center line of the body of the device and the horizontal line crossing the center piece in a plane parallel to the sagittal plane of the phantom. While maintaining the device in this plane, align the vertical center line with the reference plane containing the three ear and mouth reference point (M: Mouth, RE: Right Ear, and LE: Left Ear) and align the center of the ear piece with the line RE-LE.

(b) To move the device towards the phantom with the ear piece aligned with the line LE-RE until the phone touched the ear. While maintaining the device in the reference plane and maintaining the phone contact with the ear, move the bottom of the phone until any point on the front side is in contact with the cheek of the phantom or until contact with the ear is lost (see Fig. 7.2).

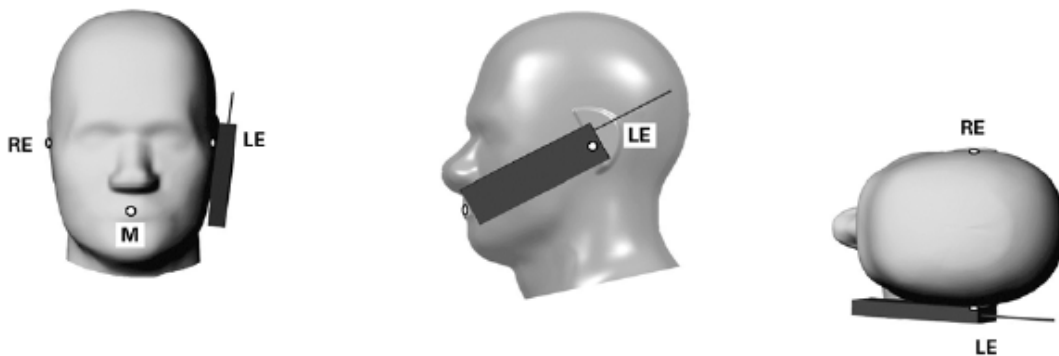

Fig 7.2 Illustration for Cheek Position

7.3 Tilted Position

(a) To position the device in the “cheek” position described above.

(b) While maintaining the device the reference plane described above and pivoting against the ear, moves it outward away from the mouth by an angle of 15 degrees or until contact with the ear is lost (see Fig. 7.3).

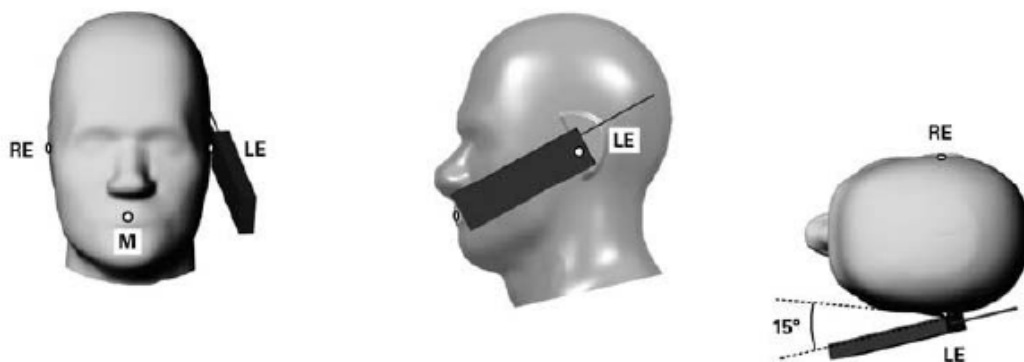

Fig 7.3 Illustration for Tilted Position

7.4 Body Worn Position

- (a) To position the device parallel to the phantom surface with either keypad up or down.
- (b) To adjust the device parallel to the flat phantom.
- (c) To adjust the distance between the device surface and the flat phantom to 1 cm.

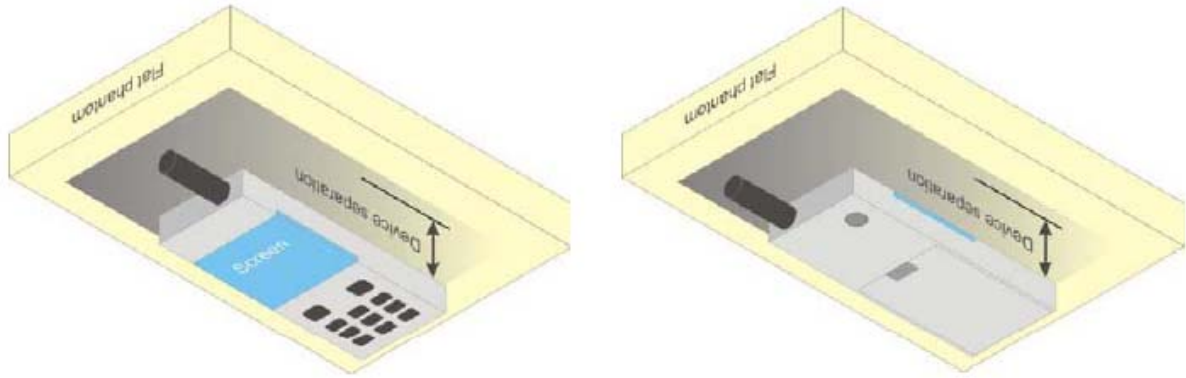

Fig 7.4 Illustration for Body Worn Position

7.5 EUT Antenna Position

Green Area: WWAN Antenna (GSM850/1900, WCDMA Band II/V)

Blue Area: RLAN Antenna (WLAN/Bluetooth)

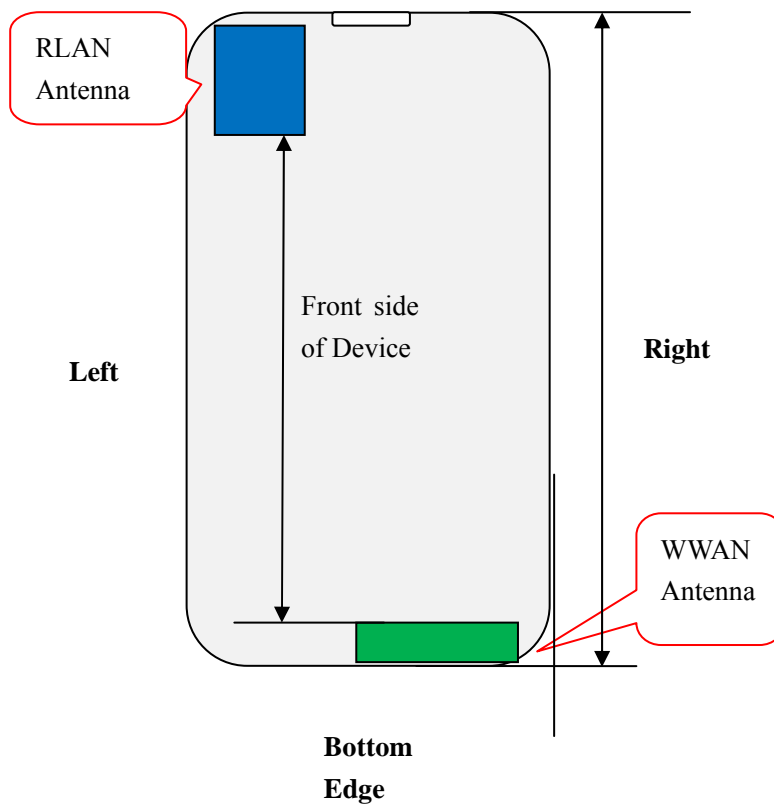

Fig 7.5 Block Diagram for EUT Antenna Position

7.6 EUT Testing Postion

Head/Body-worn/Hotspot mode SAR assessments are required for this device. This EUT was tested in different positions for different SAR test modes, more information as below:

Distance of EUT antenna-to-edge/surface(mm), Test distance:10mm						
Antennas	Back side	Front side	Left Edge	Right Edge	Top Edge	Bottom Edge
WWAN	2	3	28	2	132	1
WLAN	2	3	1	58	5	104
Bluetooth	2	3	1	58	5	104

Test distance:10mm						
Antennas	Back side	Front side	Left Edge	Right Edge	Top Edge	Bottom Edge
WWAN	YES	YES	NO	YES	NO	YES
WLAN	NO	NO	NO	NO	NO	NO
Bluetooth	NO	NO	NO	NO	NO	NO

Remark:

1. Referring to KDB 941225 D06, when the overall device length and width are $\geq 9\text{cm} \times 5\text{cm}$, the test separation is 10 mm. SAR must be measured for all sides and surfaces with a transmitting antenna located within 25mm from that surface or edge.
2. For WWAN antenna, SAR measurements at Top side are not required since the distance between WWAN transmitting antenna and surface or edge $> 25\text{mm}$.
3. For WLAN & Bluetooth antenna, SAR measurements is not required because of low power.

Please refer to Annex E for the EUT test setup photos.

8. SAR Measurement Procedures

8.1 Measurement Procedures

The measurement procedures are as follows:

- (a) Use base station simulator (if applicable) or engineering software to transmit RF power continuously (continuous Tx) in the highest power channel.
- (b) Keep EUT to radiate maximum output power or 100% factor (if applicable)
- (c) Measure output power through RF cable and power meter.
- (d) Place the EUT in the positions as Annex E demonstrates.
- (e) Set scan area, grid size and other setting on the SATIMO software.
- (f) Measure SAR results for the highest power channel on each testing position.
- (g) Find out the largest SAR result on these testing positions of each band
- (h) Measure SAR results for other channels in worst SAR testing position if the SAR of highest power channel is larger than 0.8 W/kg

According to the test standard, the recommended procedure for assessing the peak spatial-average SAR value consists of the following steps:

- (a) Power reference measurement
- (b) Area scan
- (c) Zoom scan
- (d) Power drift measurement

8.2 Spatial Peak SAR Evaluation

The procedure for spatial peak SAR evaluation has been implemented according to the test standard. It can be conducted for 1g and 10g, as well as for user-specific masses. The SATIMO software includes all numerical procedures necessary to evaluate the spatial peak SAR value.

The base for the evaluation is a "cube" measurement. The measured volume must include the 1g and 10g cubes with the highest averaged SAR values. For that purpose, the center of the measured volume is aligned to the interpolated peak SAR value of a previously performed area scan.

The entire evaluation of the spatial peak values is performed within the post-processing engine. The system always gives the maximum values for the 1g and 10g cubes. The algorithm to find the cube with highest averaged SAR is divided into the following stages:

- (a) Extraction of the measured data (grid and values) from the Zoom Scan
- (b) Calculation of the SAR value at every measurement point based on all stored data
- (c) Generation of a high-resolution mesh within the measured volume
- (d) Interpolation of all measured values from the measurement grid to the high-resolution grid
- (e) Extrapolation of the entire 3D field distribution to the phantom surface over the distance from sensor to surface
- (f) Calculation of the averaged SAR within masses of 1g and 10g

8.3 Area & Zoom Scan Procedures

First Area Scan is used to locate the approximate location(s) of the local peak SAR value(s). The measurement grid within an Area Scan is defined by the grid extent, grid step size and grid offset. Next, in order to determine the EM field distribution in a three-dimensional spatial extension, Zoom Scan is required. The Zoom Scan measures 5x5x7 points with step size 8, 8 and 5 mm for 300 MHz to 3 GHz, and 8x8x8 points with step size 4, 4 and 2.5 mm for 3 GHz to 6 GHz. The Zoom Scan is performed around the highest E-field value to determine the averaged SAR-distribution over 10 g.

8.4 Volume Scan Procedures

The volume scan is used for assess overlapping SAR distributions for antennas transmitting in different frequency bands. It is equivalent to an oversized zoom scan used in standalone measurements. The measurement volume will be used to enclose all the simultaneous transmitting antennas. For antennas transmitting simultaneously in different frequency bands, the volume scan is measured separately in each frequency band. In order to sum correctly to compute the 1g aggregate SAR, the EUT remain in the same test position for all measurements and all volume scan use the same spatial resolution and grid spacing (step-size is 4, 4 and 2.5 mm). When all volume scan were completed, the software can combine and subsequently superpose these measurement data to calculating the multiband SAR.

8.5 SAR Averaged Methods

The local SAR inside the phantom is measured using small dipole sensing elements inside a probe body. The probe tip must not be in contact with the phantom surface in order to minimize measurements errors, but the highest local SAR will occur at the surface of the phantom.

An extrapolation is using to determinate this highest local SAR values. The extrapolation is based on a fourth-order least-square polynomial fit of measured data. The local SAR value is then extrapolated from the liquid surface with a 1mm step.

The measurements have to be performed over a limited time (due to the duration of the battery) so the step of measurement is high. It could vary between 5 and 8 mm. To obtain an accurate assessment of the maximum SAR averaged over 10g and 1 g requires a very fine resolution in the three dimensional scanned data array.

8.6 Power Drift Monitoring

All SAR testing is under the EUT install full charged battery and transmit maximum output power. In SATIMO measurement software, the power reference measurement and power drift measurement procedures are used for monitoring the power drift of EUT during SAR test. Both these procedures measure the field at a specified reference position before and after the SAR testing. The software will calculate the field difference in dB. If the power drift more than 5%, the SAR will be retested.

9. SAR Test Result

9.1 Conducted RF Output Power

GSM - Burst Average Power (dBm)						
Band	GSM850			PCS1900		
Channel	128	189	251	512	661	810
Frequency (MHz)	824.2	836.4	848.8	1850.2	1880	1909.8
GSM	32.35	32.33	32.32	28.99	29.07	28.75
GPRS (1 slot)	32.16	32.12	31.99	29.18	29.09	28.86
GPRS (2 slots)	31.59	31.57	31.54	28.32	27.85	27.58
GPRS (4 slots)	28.62	28.75	28.74	25.59	25.61	25.43

GSM - Source-Based Time-Average Power (dBm)						
Band	GSM850			PCS1900		
Channel	128	189	251	512	661	810
Frequency (MHz)	824.2	836.4	848.8	1850.2	1880	1909.8
GSM	23.32	23.30	23.29	19.96	20.04	19.72
GPRS (1 slot)	23.13	23.09	22.96	20.15	20.06	19.83
GPRS (2 slots)	25.57	25.55	25.52	22.31	21.83	21.56
GPRS (4 slots)	25.61	25.74	25.73	22.8	22.60	22.42

Note: The source-based time-averaged power is linearly scaled the maximum burst averaged power based on time slots. The calculated method are shown as below:

Source based time-average power = Burst averaged power - Duty cycle factor in dB

Duty cycle factor = 9.03 dB for 1 Tx slot, 6.02 dB for 2 Tx slots, 4.25 dB for 3 Tx slots, 3.01 dB for 4 Tx slots

Remark:

1. For Head SAR testing, GSM should be evaluated, therefore the EUT was set in GSM for GSM850 and GSM1900 due to its highest source-based time-average power.
2. For Body SAR testing, GPRS should be evaluated, therefore the EUT was set in GPRS (4 Tx slots) for GSM850 and GSM1900 due to its highest source-based time-average power.
3. Per KDB 447498, the maximum output power channel is used for SAR testing and for further SAR test reduction.
4. EDGE tests with MCS1 setting, GMSK modulation. Burst average power with MCS5 setting 8PSK modulation, is provided voluntary for reference.
5. The DUT do not support DTM function.

WCDMA - Average Power (dBm)						
Band	WCDMA Band V			WCDMA Band II		
Channel	4132	4182	4233	9262	9400	9538
Frequency (MHz)	826.4	836.4	846.6	1852.4	1880	1907.6
RMC 12.2K	22.51	22.53	22.66	22.28	22.15	22.47
HSDPA Subtest-1	21.62	21.73	21.62	21.42	21.13	21.28
HSDPA Subtest-2	21.59	21.41	21.75	21.50	20.89	21.11
HSDPA Subtest-3	21.46	22.02	22.13	21.82	20.67	21.55
HSDPA Subtest-4	21.44	21.89	21.92	20.90	20.74	21.79
HSUPA Subtest-1	21.46	21.59	21.64	21.05	21.02	21.32
HSUPA Subtest-2	21.14	20.88	21.66	21.26	21.49	21.37
HSUPA Subtest-3	20.83	21.30	21.49	20.95	20.46	20.82
HSUPA Subtest-4	22.05	21.60	21.65	21.52	20.62	20.61
HSUPA Subtest-5	20.89	20.92	21.45	20.89	21.66	21.00

Remark:

1. For Head SAR, per KDB 941225 D01, RMC 12.2kbps setting is used to evaluate SAR. If AMR 12.2kbps power is < 1/4 dB higher than RMC, SAR tests with AMR 12.2kbps can be excluded.
2. For Body SAR, per KDB 941225 D01, RMC 12.2kbps setting is used to evaluate SAR. If HSDPA subset-1 and HSUPA subset-5 output power is < 1/4 dB higher than RMC, and SAR with RMC 12.2kbps setting is $\leq 1.2W/kg$, HSDPA and HSUPA SAR evaluation can be excluded.
3. EUT is designed to follow the MPR of 3GPP Table 5.2B.1 specification. In production units, MPR result deviation from 3GPP is expected; the implementation and expected deviation is detailed in tune-up procedure exhibit.

WLAN - Maximum Average Power				
Test Mode	Data Rate	Channel	Frequency (MHz)	Average Power (dBm)
802.11b	1Mbps	CH 01	2412	9.07
		CH 06	2437	9.36
		CH 11	2462	9.14
802.11g	54Mbps	CH 01	2412	9.14
		CH 06	2437	9.22
		CH 11	2462	9.37
802.11n (20MHz)	MCS1	CH 01	2412	9.29
		CH 06	2437	9.46
		CH 11	2462	9.48
802.11n (40MHz)	MCS7	CH 03	2422	9.31
		CH 06	2437	9.24
		CH 09	2452	9.19

Remark:

1. Per KDB 248227, choose the highest output power channel to test SAR and determine further SAR exclusion
2. Per KDB 248227, if 11g and 11n average output power is higher than 1/4 dB higher than 11b mode, SAR will be verified.
3. For each frequency band, testing at higher data rates and higher order modulations is not required when the maximum average output power for each of these configurations is less than 1/4 dB higher than those measured at the lowest data rate. For 802.11n mode, SAR test according to the highest power channel with correspondence data rates.
4. WIFI maximum output power is 9.48dBm. For low power, WIFI SAR is not required.

Bluetooth - Maximum Average Power				
Test Mode	Data Rate	Channel	Frequency (MHz)	Average Power (dBm)
GFSK	1Mbps	CH 00	2402	3.44
		CH 39	2441	4.20
		CH 78	2480	3.56
Pi/4 DQPSK	2Mbps	CH 00	2402	3.11
		CH 39	2441	3.88
		CH 78	2480	3.24
8DPSK	3Mbps	CH 00	2402	3.41
		CH 39	2441	4.19
		CH 78	2480	3.54

Remark:

Bluetooth maximum output power is 4.20dBm. For low power, BT SAR is not required.

9.2 Test Results for Standalone SAR Test

Head SAR

Mode	Test Postion Head	Frequency		Output Power (dBm)	Rated Limit (dBm)	SAR1g (W/kg)	Scaled SAR1g (W/kg)
		CH.	MHz				
Voice call	Right Cheek	190	836.6	32.33	33	0.324	0.38
Voice call	Right Tilted	190	836.6	32.33	33	0.152	0.18
Voice call	Left Cheek	190	836.6	32.33	33	0.329	0.38
Voice call	Left Tilted	190	836.6	32.33	33	0.161	0.19

Remark: Per KDB 447498, if the highest output channel SAR for each exposure position ≤ 0.8 W/kg other channels SAR tests are not necessary.

Mode	Test Postion Head	Frequency		Output Power (dBm)	Rated Limit (dBm)	SAR1g (W/kg)	Scaled SAR1g (W/kg)
		CH.	MHz				
Voice call	Right Cheek	661	1880.0	29.07	29.5	0.029	0.03
Voice call	Right Tilted	661	1880.0	29.07	29.5	0.007	0.01
Voice call	Left Cheek	661	1880.0	29.07	29.5	0.037	0.04
Voice call	Left Tilted	661	1880.0	29.07	29.5	0.005	0.01

Remark: Per KDB 447498, if the highest output channel SAR for each exposure position ≤ 0.8 W/kg other channels SAR tests are not necessary.

Mode	Test Postion Head	Frequency		Output Power (dBm)	Rated Limit (dBm)	SAR1g (W/kg)	Scaled SAR1g (W/kg)
		CH.	MHz				
RMC 12.2kbps	Right Cheek	4183	836.6	22.53	23	0.268	0.30
RMC 12.2kbps	Right Tilted	4183	836.6	22.53	23	0.136	0.15
RMC 12.2kbps	Left Cheek	4183	836.6	22.53	23	0.271	0.30
RMC 12.2kbps	Left Tilted	4183	836.6	22.53	23	0.099	0.11

Remark: Per KDB 447498, if the highest output channel SAR for each exposure position ≤ 0.8 W/kg other channels SAR tests are not necessary.

Mode	Test Postion Head	Frequency		Output Power (dBm)	Rated Limit (dBm)	SAR1g (W/kg)	Scaled SAR1g (W/kg)
		CH.	MHz				
RMC 12.2kbps	Right Cheek	9400	1880.0	22.15	23	0.386	0.47
RMC 12.2kbps	Right Tilted	9400	1880.0	22.15	23	0.100	0.12
RMC 12.2kbps	Left Cheek	9400	1880.0	22.15	23	0.469	0.57
RMC 12.2kbps	Left Tilted	9400	1880.0	22.15	23	0.099	0.12

Remark: Per KDB 447498, if the highest output channel SAR for each exposure position ≤ 0.8 W/kg other channels SAR tests are not necessary.

Hotspot/Body SAR

Mode	Test Postion Body	Frequency		Output Power (dBm)	Rated Limit (dBm)	SAR1g (W/kg)	Scaled SAR1g (W/kg)
		CH.	MHz				
GPRS 4 slots	Front	190	836.6	28.75	29	0.503	0.53
GPRS 4 slots	Back	190	836.6	28.75	29	0.679	0.72
GPRS 4 slots	Right	190	836.6	28.75	29	0.389	0.41
GPRS 4 slots	Bottom	190	836.6	28.75	29	0.214	0.23

Remark: Per KDB 447498, if the highest output channel SAR for each exposure position ≤ 0.8 W/kg other channels SAR tests are not necessary.

Mode	Test Postion Body	Frequency		Output Power (dBm)	Rated Limit (dBm)	SAR1g (W/kg)	Scaled SAR1g (W/kg)
		CH.	MHz				
GPRS 4 slots	Front	661	1880.0	25.61	26	0.551	0.60
GPRS 4 slots	Back	661	1880.0	25.61	26	0.785	0.86
GPRS 4 slots	Right	661	1880.0	25.61	26	0.223	0.24
GPRS 4 slots	Bottom	512	1850.2	25.59	26	1.078	1.18
GPRS 4 slots	Bottom	512	1850.2	25.59	26	1.159	1.27
GPRS 4 slots	Bottom	661	1880.0	25.61	26	0.867	0.95
GPRS 4 slots	Bottom	810	1909.8	25.43	26	0.643	0.73

Remark: Per KDB 447498, if the highest output channel SAR for each exposure position ≤ 0.8 W/kg other channels SAR tests are not necessary.

Mode	Test Postion Head	Frequency		Output Power (dBm)	Rated Limit (dBm)	SAR1g (W/kg)	Scaled SAR1g (W/kg)
		CH.	MHz				
RMC 12.2kbps	Front	4183	836.6	22.53	23	0.298	0.33
RMC 12.2kbps	Back	4183	836.6	22.53	23	0.381	0.42
RMC 12.2kbps	Right	4183	836.6	22.53	23	0.267	0.30
RMC 12.2kbps	Bottom	4183	836.6	22.53	23	0.125	0.14

Remark: Per KDB 447498, if the highest output channel SAR for each exposure position ≤ 0.8 W/kg other channels SAR tests are not necessary.

Mode	Test Postion Head	Frequency		Output Power (dBm)	Rated Limit (dBm)	SAR1g (W/kg)	Scaled SAR1g (W/kg)
		CH.	MHz				
RMC 12.2kbps	Front	9400	1880.0	22.15	23	0.027	0.03
RMC 12.2kbps	Back	9400	1880.0	22.15	23	0.024	0.03
RMC 12.2kbps	Right	9400	1880.0	22.15	23	0.200	0.24
RMC 12.2kbps	Bottom	9400	1880.0	22.15	23	0.012	0.01

Remark: Per KDB 447498, if the highest output channel SAR for each exposure position ≤ 0.8 W/kg other channels SAR tests are not necessary.

9.3 Simultaneous Multi-band Transmission SAR Analysis

1.	WWAN+BT
2.	WWAN+WIFI

Note:

For simultaneous transmission analysis, WiFi and Bluetooth SAR is estimated per KDB 447498 D01 v05 base on the formula below:

- $(\text{max. power of channel, including tune-up tolerance, } mW) / (\text{min. test separation distance, mm}) \cdot [\sqrt{f_{\text{(GHz)}}/x}] \text{ W/kg}$ for test separation distances $\leq 50 \text{ mm}$;
 where $x = 7.5$ for 1-g SAR, and $x = 18.75$ for 10-g SAR.
- 0.4 W/kg for 1-g SAR and 1.0 W/kg for 10-g SAR, when the test separation distances is $> 50 \text{ mm}$.²¹

If the test separation distances is $\leq 5 \text{ mm}$, 5mm is used for estimated SAR calculation.

WiFi's maximum tune up power is 9.5dBm, BT's maximum tune up power is 4.5dBm and the estimated SAR is listed below.

Test position	Head(0cm)	Body-worn(1.0cm)
WIFI Estimated SAR(W/kg)	0.37	0.19
BT Estimated SAR(W/kg)	0.12	0.06

Maximum SAR value and the sum of the 1-g SAR for WWAN & RLAN

WWAN		WLAN	BT	WWAN+WLAN	WWAN+BT
WWAN Band	Scaled SAR (W/kg)	Max. SAR(W/kg)		Scaled SAR Sum (W/kg)	
Head SAR					
GSM850	0.38	0.37	0.12	0.75	0.50
GSM1900	0.04	0.37	0.12	0.41	0.16
WCDMA850	0.30	0.37	0.12	0.67	0.42
WCDMA1900	0.57	0.37	0.12	0.94	0.69
Hotspot/Body SAR					
GSM850	0.72	0.19	0.06	0.91	0.78
GSM1900	1.27	0.19	0.06	1.46	1.33
WCDMA850	0.42	0.19	0.06	0.61	0.48
WCDMA1900	0.24	0.19	0.06	0.43	0.30

Conclusion: Per KDB 648474 D01, the simultaneous transmission SAR for WWAN and RLAN was not required, because the SAR scaled summation (Head: 0.94 W/kg; Hotspot/Body: 1.46W/kg) is less than 1.6 W/kg.

10. Measurement Uncertainty

10.1 Uncertainty for EUT SAR Test

a	b	c	d	e= f(d,k)	f	g	h= c*f/e	i= c*g/e	k
Uncertainty Component	Sec.	Tol (+- %)	Prob. Dist.	Div.	Ci (1g)	Ci (10g)	1g Ui (+-%)	10g Ui (+-%)	Vi
Measurement System									
Probe calibration	E.2.1	7.0	N	1	1	1	7.00	7.00	∞
Axial Isotropy	E.2.2	2.5	R	$\sqrt{3}$	$(1_{Cp})^{1/2}$	$(1_{Cp})^{1/2}$	1.02	1.02	∞
Hemispherical Isotropy	E.2.2	4.0	R	$\sqrt{3}$	$(Cp)^{1/2}$	$(Cp)^{1/2}$	1.63	1.63	∞
Boundary effect	E.2.3	1.0	R	$\sqrt{3}$	1	1	0.58	0.58	∞
Linearity	E.2.4	5.0	R	$\sqrt{3}$	1	1	2.89	2.89	∞
System detection limits	E.2.5	1.0	R	$\sqrt{3}$	1	1	0.58	0.58	∞
Readout Electronics	E.2.6	0.02	N	1	1	1	0.02	0.02	∞
Reponse Time	E.2.7	3.0	R	$\sqrt{3}$	1	1	1.73	1.73	∞
Integration Time	E.2.8	2.0	R	$\sqrt{3}$	1	1	1.15	1.15	∞
RF ambient Conditions	E.6.1	3.0	R	$\sqrt{3}$	1	1	1.73	1.73	∞
Probe positioner Mechanical Tolerances	E.6.2	2.0	R	$\sqrt{3}$	1	1	1.15	1.15	∞
Probe positioning with respect to Phantom Shell	E.6.3	0.05	R	$\sqrt{3}$	1	1	0.03	0.03	∞
Extrapolation, interpolation and integration Algorithms for Max. SAR Evaluation	E.5.2	5.0	R	$\sqrt{3}$	1	1	2.89	2.89	∞
Test Sample Related									
Test sample positioning	E.4.2.1	0.03	N	1	1	1	0.03	0.03	N-1
Device Holder Uncertainty	E.4.1.1	5.00	N	1	1	1	5.00	5.00	
Output power Variation - SAR drift measurement	6.6.2	12.02	R	$\sqrt{3}$	1	1	6.94	6.94	∞
Phantom and Tissue Parameters									
Phantom Uncertainty (Shape and thickness tolerances)	E.3.1	0.05	R	$\sqrt{3}$	1	1	0.03	0.03	∞
Liquid conductivity - deviation from target value	E.3.2	5.00	R	$\sqrt{3}$	0.64	0.43	1.85	1.24	
Liquid conductivity - measurement uncertainty	E.3.3	5.00	N	1	0.64	0.43	3.20	2.15	
Liquid permittivity - deviation from target value	E.3.2	0.37	R	$\sqrt{3}$	0.6	0.49	0.13	0.10	
Liquid permittivity - measurement uncertainty	E.3.3	10.00	N	1	0.6	0.49	6.00	4.90	M
Combined Standard Uncertainty			RSS				12.98	12.53	
Expanded Uncertainty (95% Confidence interval)			K=2				25.32	24.43	

10.2 Uncertainty for System Performance Check

a	b	c	d	e= f(d,k)	f	g	h= c*f/e	i= c*g/e	k
Uncertainty Component	Sec.	Tol (+-%)	Prob. Dist.	Div.	Ci (1g)	Ci (10g)	1g Ui (+-%)	10g Ui (+-%)	Vi
Measurement System									
Probe calibration	E.2.1	7.0	N	1	1	1	7.00	7.00	∞
Axial Isotropy	E.2.2	2.5	R	$\sqrt{3}$	$(1_{-Cp})^{1/2}$	$(1_{-Cp})^{1/2}$	1.02	1.02	∞
Hemispherical Isotropy	E.2.2	4.0	R	$\sqrt{3}$	$(Cp)^{1/2}$	$(Cp)^{1/2}$	1.63	1.63	∞
Boundary effect	E.2.3	1.0	R	$\sqrt{3}$	1	1	0.58	0.58	∞
Linearity	E.2.4	5.0	R	$\sqrt{3}$	1	1	2.89	2.89	∞
System detection limits	E.2.5	1.0	R	$\sqrt{3}$	1	1	0.58	0.58	∞
Readout Electronics	E.2.6	0.02	N	1	1	1	0.02	0.02	∞
Reponse Time	E.2.7	3.0	R	$\sqrt{3}$	1	1	1.73	1.73	∞
Integration Time	E.2.8	2.0	R	$\sqrt{3}$	1	1	1.15	1.15	∞
RF ambient Conditions	E.6.1	3.0	R	$\sqrt{3}$	1	1	1.73	1.73	∞
Probe positioner Mechanical Tolerance	E.6.2	2.0	R	$\sqrt{3}$	1	1	1.15	1.15	∞
Probe positioning with respect to Phantom Shell	E.6.3	0.05	R	$\sqrt{3}$	1	1	0.03	0.03	∞
Extrapolation, interpolation and integration Algorithms for Max. SAR Evaluation	E.5.2	5.0	R	$\sqrt{3}$	1	1	2.89	2.89	∞
Dipole									
Dipole axis to liquid Distance	8,E.4.2	1.00	N	$\sqrt{3}$	1	1	0.58	0.58	N-1
Input power and SAR drift measurement	8,6.6.2	12.02	R	$\sqrt{3}$	1	1	6.94	6.94	∞
Phantom and Tissue Parameters									
Phantom Uncertainty (Shape and thickness tolerances)	E.3.1	0.05	R	$\sqrt{3}$	1	1	0.03	0.03	∞
Liquid conductivity - deviation from target value	E.3.2	5.00	R	$\sqrt{3}$	0.64	0.43	1.85	1.24	
Liquid conductivity - measurement uncertainty	E.3.3	5.00	N	1	0.64	0.43	3.20	2.15	
Liquid permittivity - deviation from target value	E.3.2	0.37	R	$\sqrt{3}$	0.6	0.49	0.13	0.10	
Liquid permittivity - measurement uncertainty	E.3.3	10.00	N	1	0.6	0.49	6.00	4.90	M
Combined Standard Uncertainty			RSS				12.00	11.50	
Expanded Uncertainty (95% Confidence interval)			K=2				23.39	22.43	

Annex A. Plots of System Performance Check

MEASUREMENT 1

For Head Liquid

Type: Validation measurement (Fast, 75.00 %)

Date of measurement: 06/18/2015

Measurement duration: 12 minutes 21 seconds

E-field Probe: SSE5 - SN 09/13 EP168; ConvF: 6.25; Calibrated: 06/18/2015

A. Experimental conditions

Area Scan	dx=8mm dy=8mm
Phantom	Validation plane
Device Position	Dipole
Band	CW835
Channels	Middle
Signal	CW (Crest factor: 1.0)

B. SAR Measurement Results

Middle Band SAR (Channel 49)

Frequency (MHz)	835.000000
Relative permittivity (real part)	41.110245
Conductivity (S/m)	0.871245
Variation (%)	1.814580

Maximum location: X=0.00, Y=0.00

SAR 10g (W/Kg)	1.129489
SAR 1g (W/Kg)	2.411251

Z Axis Scan

Z (mm)	0.00	4.00	9.00	14.00	19.00	24.00	29.00
SAR (W/Kg)	0.0000	2.4900	1.8942	1.4811	1.3541	1.1123	1.0539

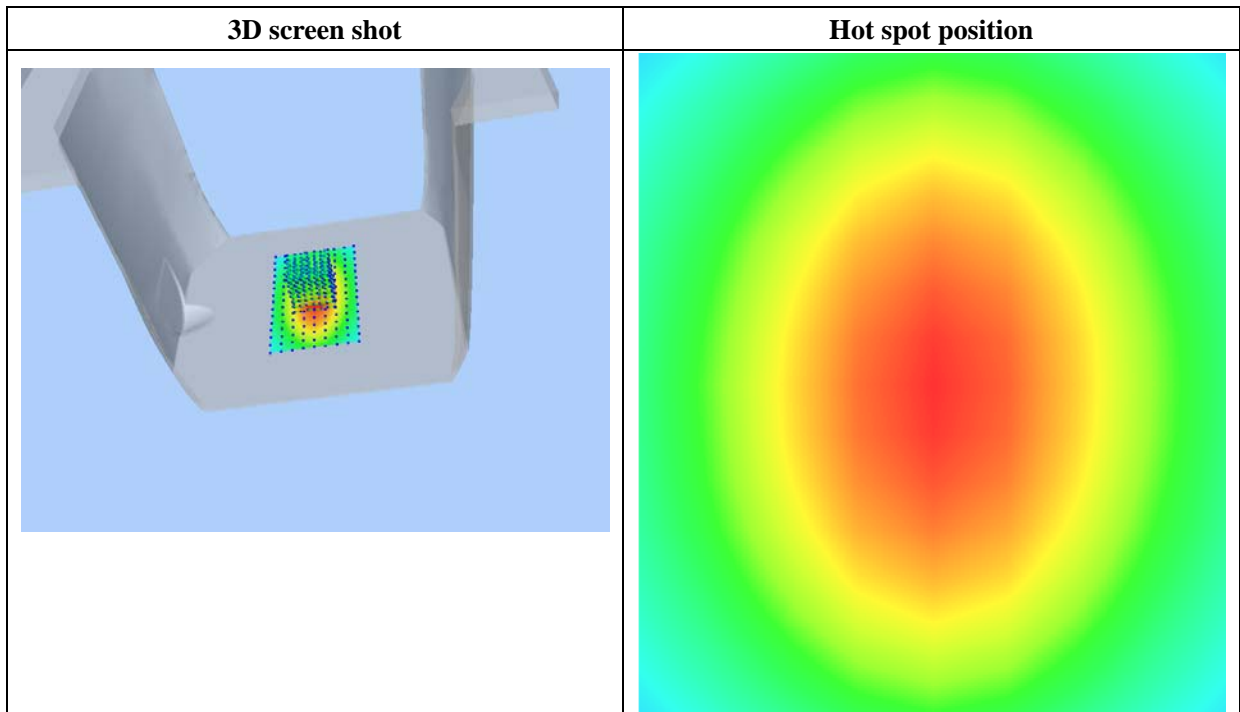
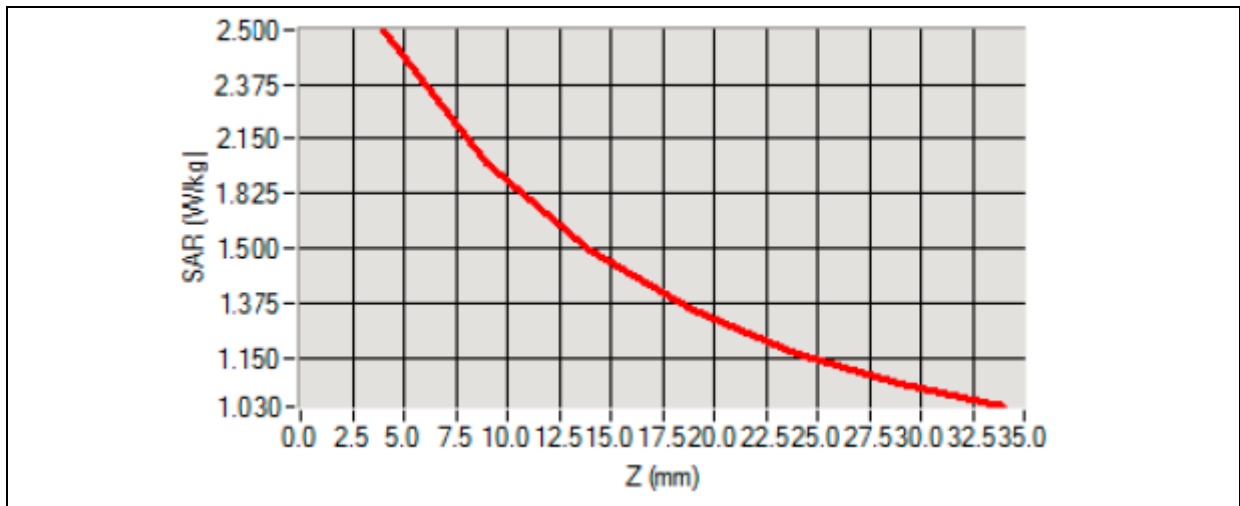

MEASUREMENT 2

For Head Liquid

Type: Validation measurement (Fast, 75.00 %)

Date of measurement: 06/19/2015

Measurement duration: 12 minutes 21 seconds

E-field Probe: SSE5 - SN 09/13 EP168; ConvF: 6.16; Calibrated: 06/19/2015

A. Experimental conditions

Area Scan	dx=8mm dy=8mm
Phantom	Validation plane
Device Position	Dipole
Band	CW1900
Channels	Middle
Signal	CW (Crest factor: 1.0)

B. SAR Measurement Results

Middle Band SAR (Channel 49)

Frequency (MHz)	1900.000000
Relative permittivity (real part)	38.560124
Conductivity (S/m)	1.380369
Variation (%)	1.022540

Maximum location: X=0.00, Y=0.00

SAR 10g (W/Kg)	7.174526
SAR 1g (W/Kg)	9.903214

Z Axis Scan

Z (mm)	0.00	4.00	9.00	14.00	19.00	24.00	29.00
SAR (W/Kg)	0.0000	10.2354	6.8400	5.0121	4.1189	3.0522	2.8424

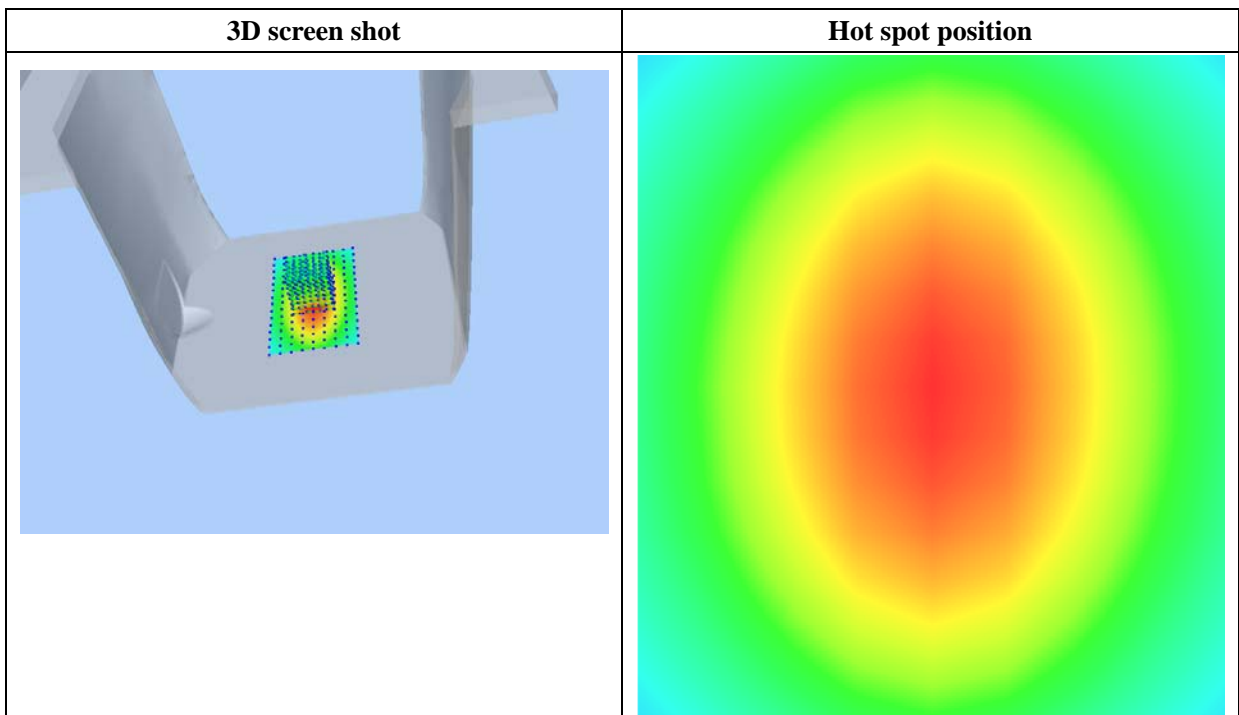
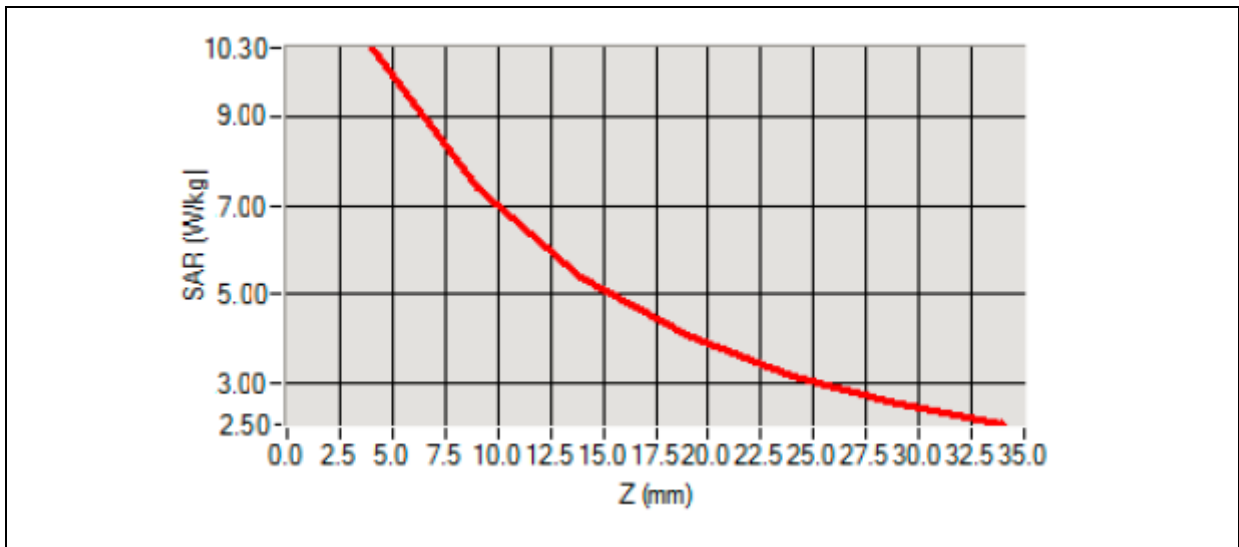

MEASUREMENT 3

For Body Liquid

Type: Validation measurement (Fast, 75.00 %)

Date of measurement: 06/18/2015

Measurement duration: 12 minutes 21 seconds

E-field Probe: SSE5 - SN 09/13 EP168; ConvF: 6.50; Calibrated: 06/18/2015

A. Experimental conditions

Area Scan	dx=8mm dy=8mm
Phantom	Validation plane
Device Position	Dipole
Band	CW835
Channels	Middle
Signal	CW (Crest factor: 1.0)

B. SAR Measurement Results

Middle Band SAR (Channel 49)

Frequency (MHz)	835.000000
Relative permittivity (real part)	54.851214
Conductivity (S/m)	0.951454
Variation (%)	0.901472

Maximum location: X=0.00, Y=0.00

SAR 10g (W/Kg)	1.028956
SAR 1g (W/Kg)	2.344211

Z Axis Scan

Z (mm)	0.00	4.00	9.00	14.00	19.00	24.00	29.00
SAR (W/Kg)	0.0000	2.5789	1.1300	0.8795	0.5940	0.5011	0.5100

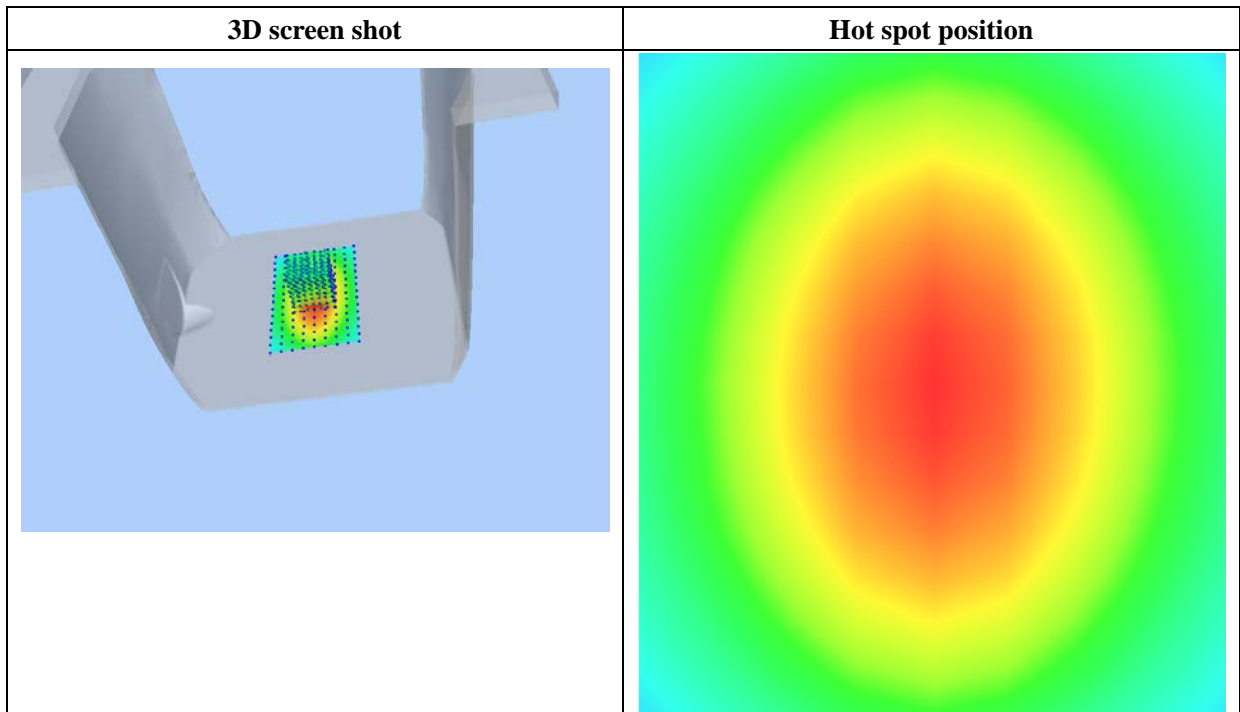
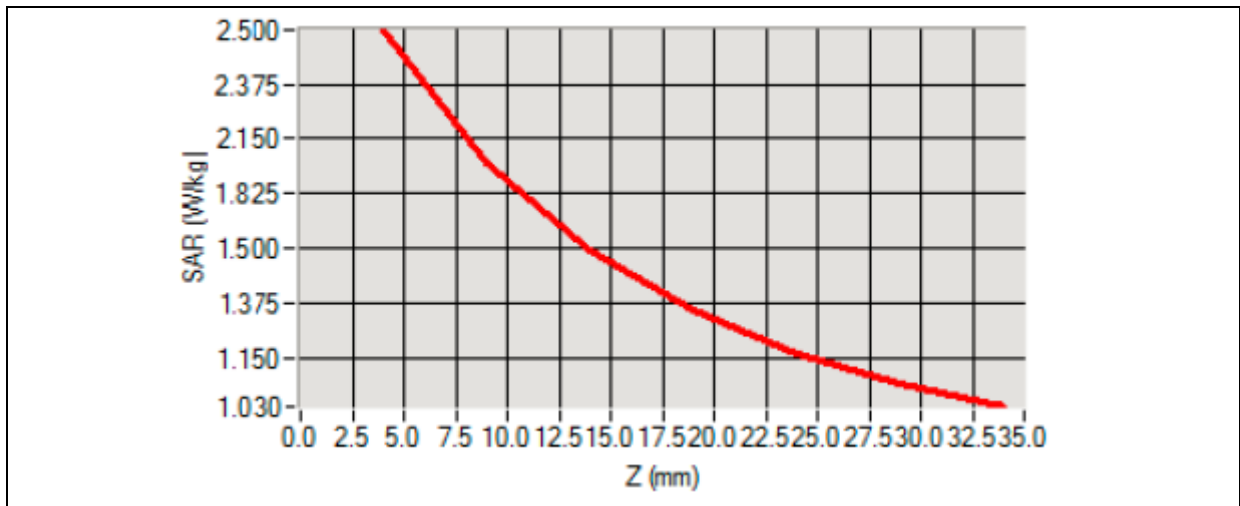

MEASUREMENT 4

For Body Liquid

Type: Validation measurement (Fast, 75.00 %)

Date of measurement: 06/19/2015

Measurement duration: 12 minutes 21 seconds

E-field Probe: SSE5 - SN 09/13 EP168; ConvF: 6.30; Calibrated: 06/19/2015

A. Experimental conditions

Area Scan	dx=8mm dy=8mm
Phantom	Validation plane
Device Position	Dipole
Band	CW1900
Channels	Middle
Signal	CW (Crest factor: 1.0)

B. SAR Measurement Results

Middle Band SAR (Channel 49)

Frequency (MHz)	1900.000000
Relative permittivity (real part)	52.420415
Conductivity (S/m)	1.501966
Variation (%)	0.541872

Maximum location: X=0.00, Y=0.00

SAR 10g (W/Kg)	5.134651
SAR 1g (W/Kg)	9.751550

Z Axis Scan

Z (mm)	0.00	4.00	9.00	14.00	19.00	24.00	29.00
SAR (W/Kg)	0.0000	10.2031	6.43001	4.9011	4.5325	3.1201	2.5024

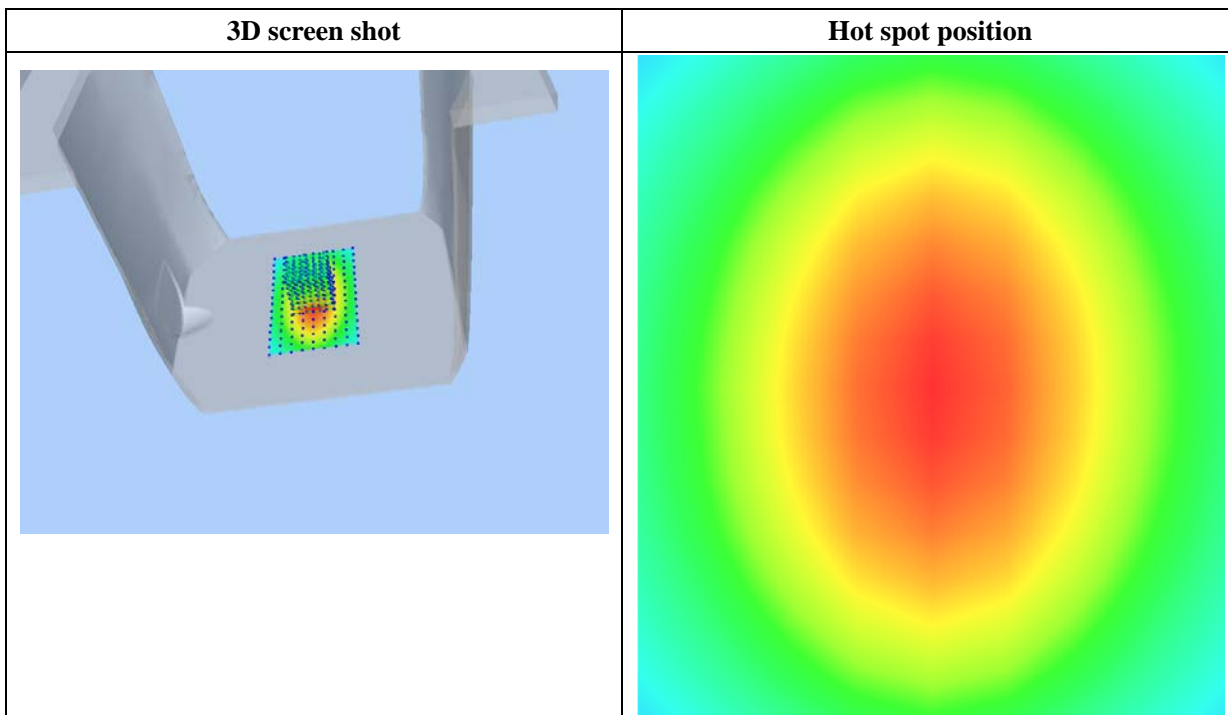
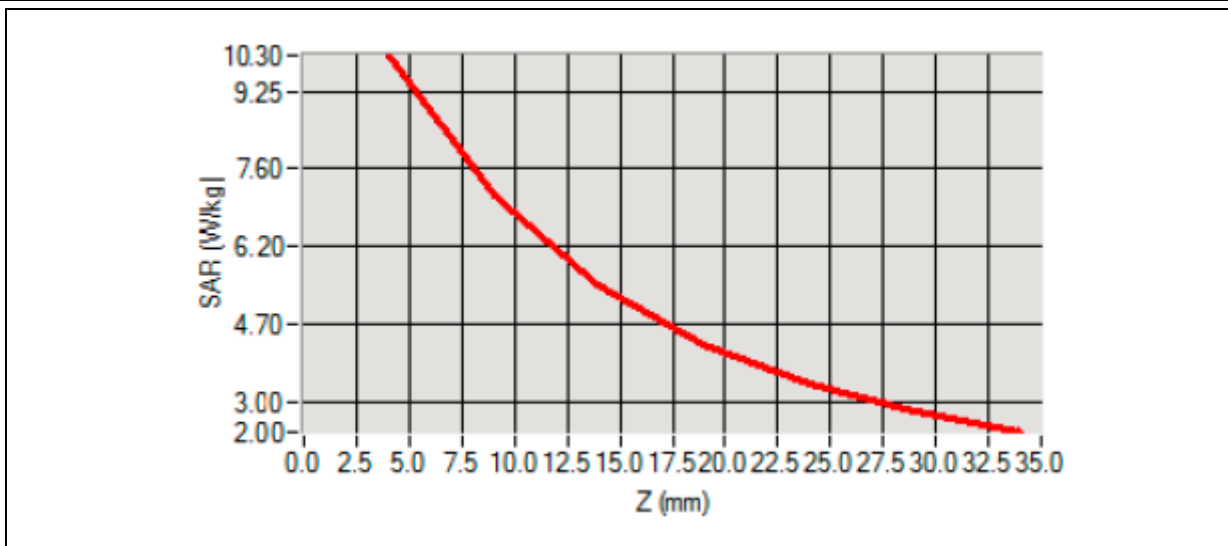

Annex B. Plots of SAR Measurement

<u>TYPE</u>	<u>BAND</u>	<u>PARAMETERS</u>
Phone	GSM850	<u>Measurement 1:</u> Right Head with Cheek device position on Middle Channel in GSM mode
Phone	GSM850	<u>Measurement 2:</u> Right Head with Tilt device position on Middle Channel in GSM mode
Phone	GSM850	<u>Measurement 3:</u> Right Head with Cheek device position on Middle Channel in GSM mode
Phone	GSM850	<u>Measurement 4:</u> Right Head with Tilt device position on Middle Channel in GSM mode
Phone	GSM1900	<u>Measurement 5:</u> Right Head with Cheek device position on Middle Channel in GSM mode
Phone	GSM1900	<u>Measurement 6:</u> Right Head with Tilt device position on Middle Channel in GSM mode
Phone	GSM1900	<u>Measurement 7:</u> Left Head with Cheek device position on Middle Channel in GSM mode
Phone	GSM1900	<u>Measurement 8:</u> Left Head with Tilt device position on Middle Channel in GSM mode
Phone	GPRS850-4TX	<u>Measurement 9:</u> Body Plane with Front Side device position on Middle Channel in GPRS850 mode
Phone	GPRS850-4TX	<u>Measurement 10:</u> Body Plane with Back Side device position on Middle Channel in GPRS850 mode
Phone	GPRS850-4TX	<u>Measurement 11:</u> Body Plane with Right Side device position on Middle Channel in GPRS850 mode
Phone	GPRS850-4TX	<u>Measurement 12:</u> Body Plane with Bottom Side device position on Middle Channel in GPRS850 mode
Phone	GPRS1900-4TX	<u>Measurement 13:</u> Body Plane with Front Side device position on Middle Channel in GPRS850 mode
Phone	GPRS1900-4TX	<u>Measurement 14:</u> Body Plane with Back Side device position on Middle Channel in GPRS850 mode
Phone	GPRS1900-4TX	<u>Measurement 15:</u> Body Plane with Right Side device position on Middle Channel in GPRS850 mode
Phone	GPRS1900-4TX	<u>Measurement 16:</u> Body Plane with Bottom Side device position on Low Channel in GPRS850 mode
Phone	GPRS1900-4TX	<u>Measurement 17:</u> Body Plane with Bottom Side device position on Low Channel in GPRS850 mode
Phone	GPRS1900-4TX	<u>Measurement 18:</u> Body Plane with Bottom Side device position on Middle in GPRS850 mode
Phone	GPRS1900-4TX	<u>Measurement 19:</u> Body Plane with Bottom Side device position on High Channel in GPRS850 mode e

Phone	WCDMA850-RMC	<u>Measurement 20:</u> Right Head with Cheek device position on Middle Channel in WCDMA mode
Phone	WCDMA850-RMC	<u>Measurement 21:</u> Right Head with Tilt device position on Middle Channel in WCDMA mode
Phone	WCDMA850-RMC	<u>Measurement 22:</u> Left Head with Cheek device position on Middle Channel in WCDMA mode
Phone	WCDMA850-RMC	<u>Measurement 23:</u> Left Head with Tilt device position on Middle Channel in WCDMA mode
Phone	WCDMA850-RMC	<u>Measurement 24:</u> Body Plane with Front Side device position on Middle Channel in WCDMA mode
Phone	WCDMA850-RMC	<u>Measurement 25:</u> Body Plane with Back Side device position on Middle Channel in WCDMA mode
Phone	WCDMA850-RMC	<u>Measurement 26:</u> Body Plane with Right Side device position on Middle Channel in WCDMA mode
Phone	WCDMA850-RMC	<u>Measurement 27:</u> Body Plane with Bottom Side device position on Middle Channel in WCDMA mode e
Phone	WCDMA1900-RMC	<u>Measurement 28:</u> Right Head with Cheek device position on Middle Channel in WCDMA mode
Phone	WCDMA1900-RMC	<u>Measurement 29:</u> Right Head with Tilt device position on Middle Channel in WCDMA mode
Phone	WCDMA1900-RMC	<u>Measurement 30:</u> Left Head with Cheek device position on Middle Channel in WCDMA mode
Phone	WCDMA1900-RMC	<u>Measurement 31:</u> Left Head with Tilt device position on Middle Channel in WCDMA mode
Phone	WCDMA1900-RMC	<u>Measurement 32:</u> Body Plane with Front Side device position on Middle Channel in WCDMA mode
Phone	WCDMA1900-RMC	<u>Measurement 33:</u> Body Plane with Back Side device position on Middle Channel in WCDMA mode
Phone	WCDMA1900-RMC	<u>Measurement 34:</u> Body Plane with Right Side device position on Middle Channel in WCDMA mode
Phone	WCDMA1900-RMC	<u>Measurement 35:</u> Body Plane with Bottom Side device position on Middle Channel in WCDMA mode e

MEASUREMENT 1

Type: Phone measurement (Complete)

Date of measurement: 06/18/2015

Measurement duration: 12 minutes 3 seconds

A. Experimental conditions

Area Scan	sam_direct_droit2_surf8mm.txt
Phantom	Right head
Device Position	Cheek
Band	GSM850
Channels	Middle
Signal	TDMA (Crest factor: 8.0)

B. SAR Measurement Results

Frequency (MHz)	836.600000
Relative permittivity (real part)	41.110245
Conductivity (S/m)	0.871245
Variation (%)	1.030000

Maximum location: X=-33.00, Y=-16.00

SAR 10g (W/Kg)	0.249331
SAR 1g (W/Kg)	0.324029

Z Axis Scan

Z (mm)	0.00	4.00	9.00	14.00	19.00	24.00	29.00
SAR (W/Kg)	0.3668	0.3317	0.2860	0.2391	0.1929	0.3668	0.3317

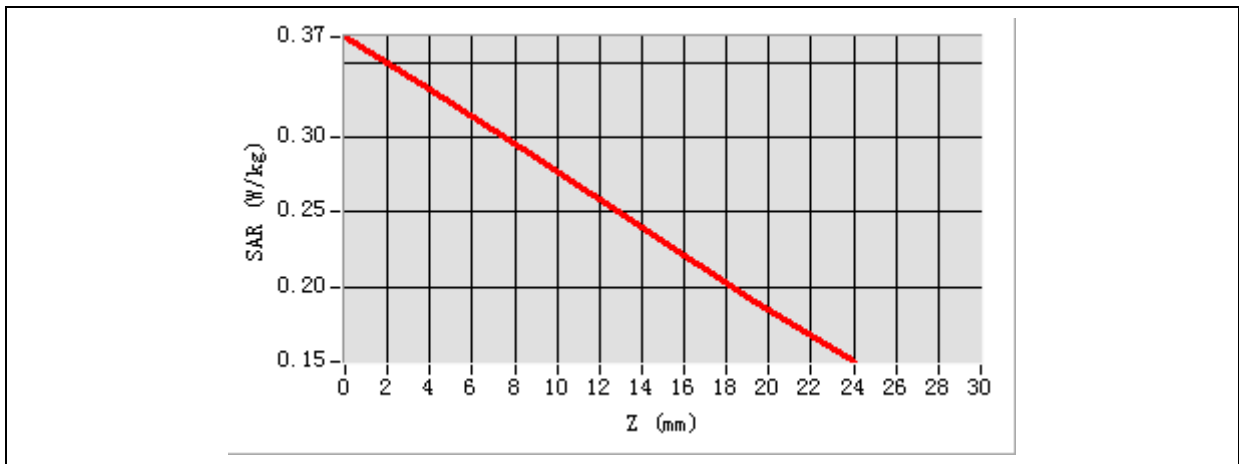

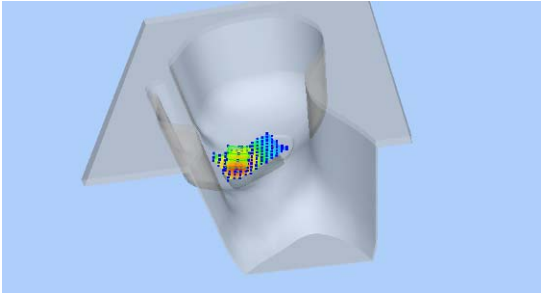
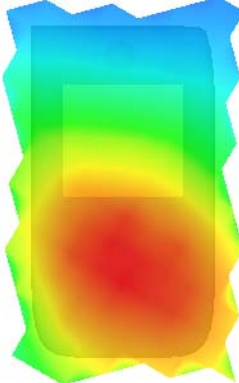
3D screen shot	Hot spot position
	

MEASUREMENT 2

Type: Phone measurement (Complete)

Date of measurement: 06/18/2015

Measurement duration: 12 minutes 3 seconds

A. Experimental conditions

Area Scan	sam_direct_droit2_surf8mm.txt
Phantom	Right head
Device Position	Tilt
Band	GSM850
Channels	Middle
Signal	TDMA (Crest factor: 8.0)

B. SAR Measurement Results

Frequency (MHz)	836.600000
Relative permittivity (real part)	41.110245
Conductivity (S/m)	0.871245
Variation (%)	-1.140000

Maximum location: X=-33.00, Y=-16.00

SAR 10g (W/Kg)	0.116233
SAR 1g (W/Kg)	0.152060

Z Axis Scan

Z (mm)	0.00	4.00	9.00	14.00	19.00	24.00	29.00
SAR (W/Kg)	0.1792	0.1555	0.1294	0.1070	0.0876	0.1792	0.1555

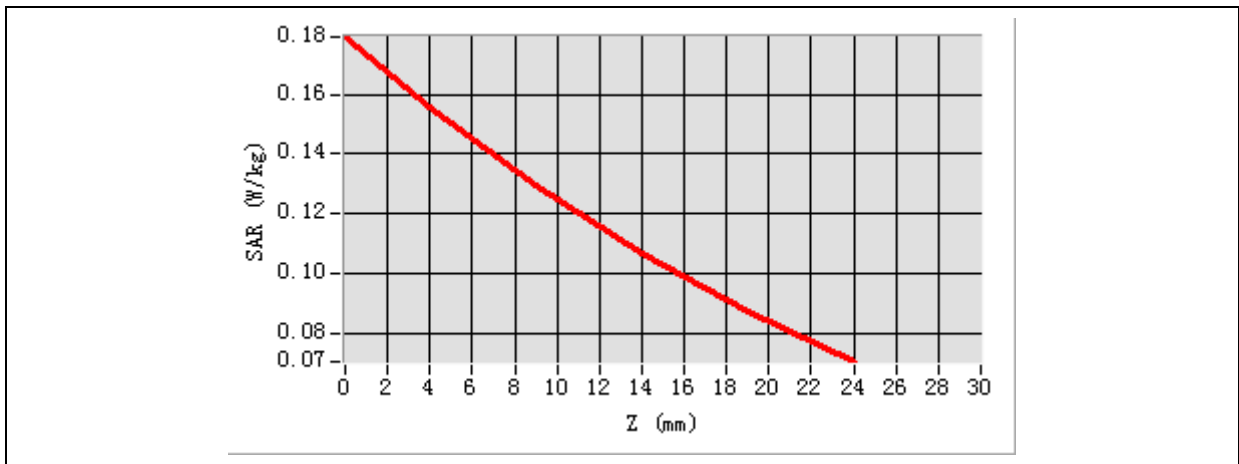

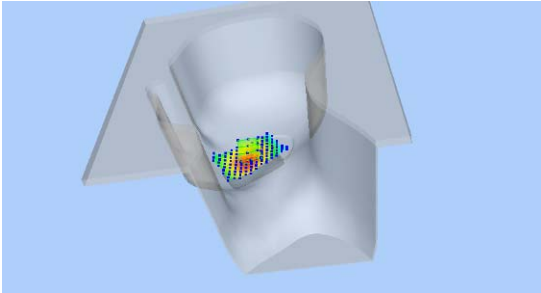
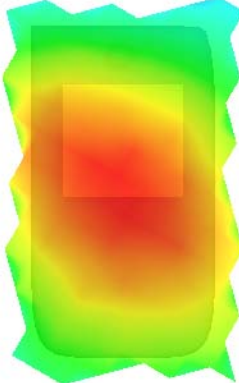
3D screen shot	Hot spot position
	

MEASUREMENT 3

Type: Phone measurement (Complete)

Date of measurement: 06/18/2015

Measurement duration: 12 minutes 3 seconds

A. Experimental conditions

Area Scan	sam_direct_droit2_surf8mm.txt
Phantom	Left head
Device Position	Cheek
Band	GSM850
Channels	Middle
Signal	TDMA (Crest factor: 8.0)

B. SAR Measurement Results

Frequency (MHz)	836.600000
Relative permittivity (real part)	41.110245
Conductivity (S/m)	0.871245
Variation (%)	-1.120000

Maximum location: X=-33.00, Y=-16.00

SAR 10g (W/Kg)	0.242289
SAR 1g (W/Kg)	0.329896

Z Axis Scan

Z (mm)	0.00	4.00	9.00	14.00	19.00	24.00	29.00
SAR (W/Kg)	0.4255	0.3415	0.2635	0.2101	0.1741	0.4255	0.3415

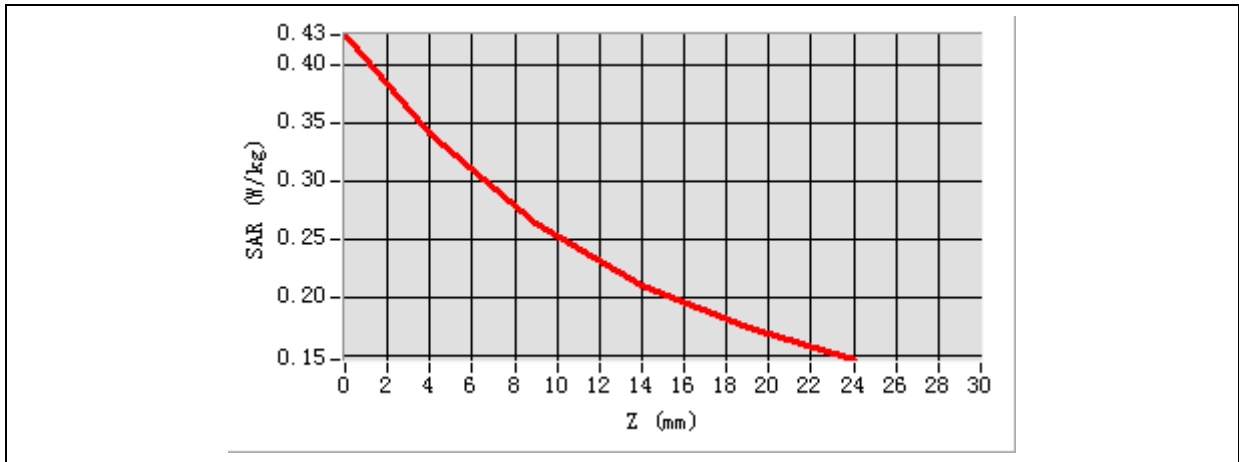

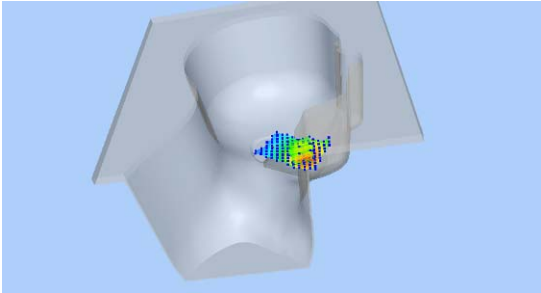
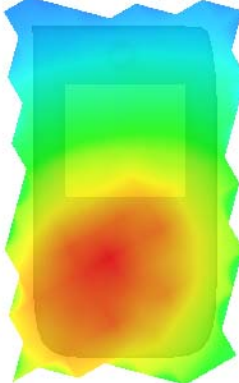
3D screen shot	Hot spot position
	

MEASUREMENT 4

Type: Phone measurement (Complete)

Date of measurement: 06/18/2015

Measurement duration: 12 minutes 3 seconds

A. Experimental conditions

Area Scan	sam_direct_droit2_surf8mm.txt
Phantom	Left head
Device Position	Tilt
Band	GSM850
Channels	Middle
Signal	TDMA (Crest factor: 8.0)

B. SAR Measurement Results

Frequency (MHz)	836.600000
Relative permittivity (real part)	41.110245
Conductivity (S/m)	0.871245
Variation (%)	-2.460000

Maximum location: X=-33.00, Y=-16.00

SAR 10g (W/Kg)	0.128698
SAR 1g (W/Kg)	0.161045

Z Axis Scan

Z (mm)	0.00	4.00	9.00	14.00	19.00	24.00	29.00
SAR (W/Kg)	0.1838	0.1623	0.1380	0.1164	0.0973	0.1838	0.1623

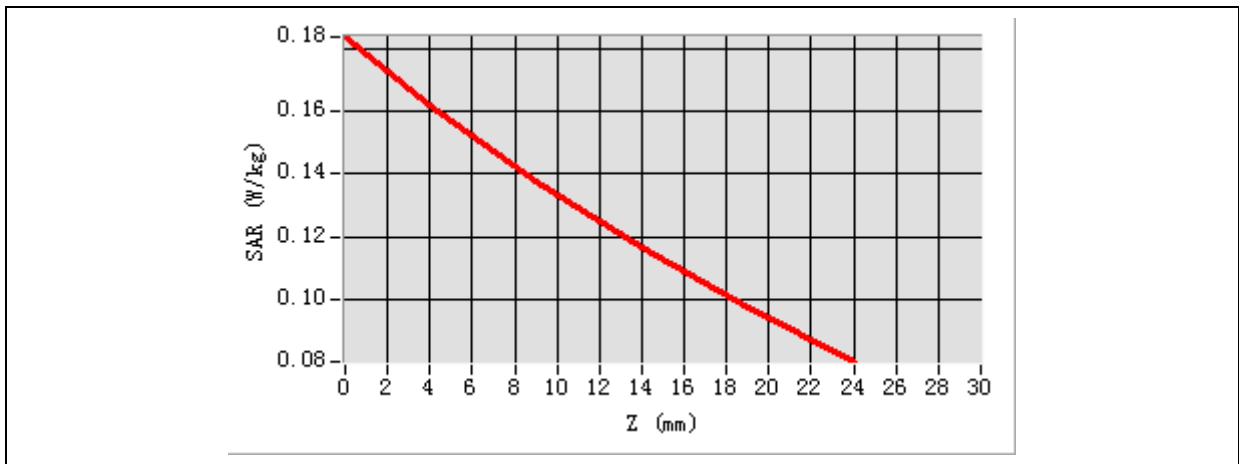

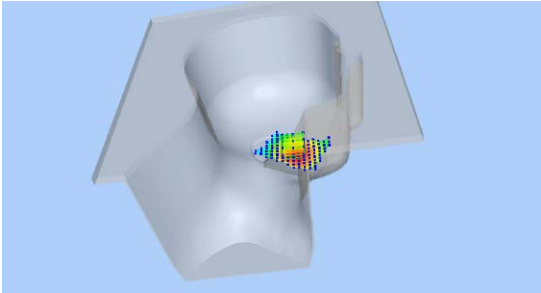
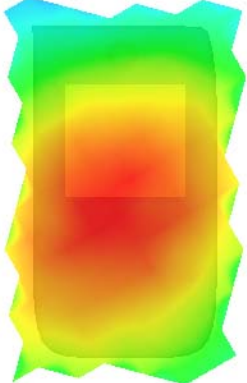
3D screen shot	Hot spot position
	

MEASUREMENT 5

Type: Phone measurement (Complete)

Date of measurement: 06/19/2015

Measurement duration: 12 minutes 3 seconds

A. Experimental conditions

Area Scan	sam_direct_droit2_surf8mm.txt
Phantom	Right head
Device Position	Cheek
Band	GSM1900
Channels	Middle
Signal	TDMA (Crest factor: 8.0)

B. SAR Measurement Results

Frequency (MHz)	1880.000000
Relative permittivity (real part)	38.560124
Conductivity (S/m)	1.380369
Variation (%)	-1.630000

Maximum location: X=-33.00, Y=-16.00

SAR 10g (W/Kg)	0.017125
SAR 1g (W/Kg)	0.028541

Z Axis Scan

Z (mm)	0.00	4.00	9.00	14.00	19.00	24.00	29.00
SAR (W/Kg)	0.0446	0.0302	0.0185	0.0117	0.0080	0.0446	0.0302

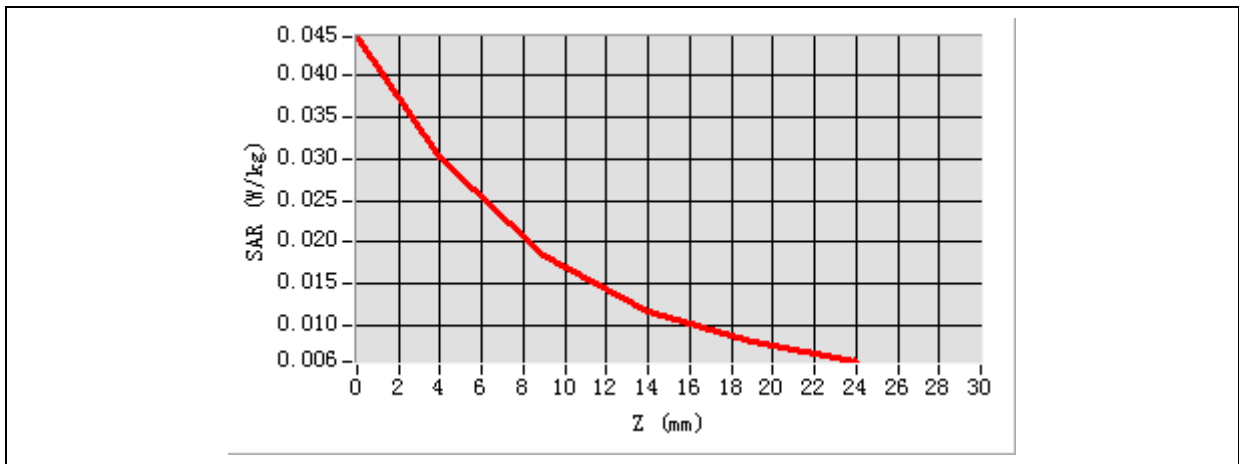

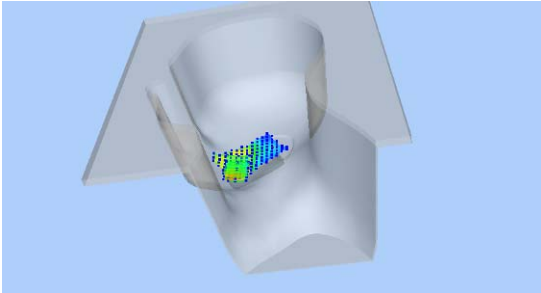
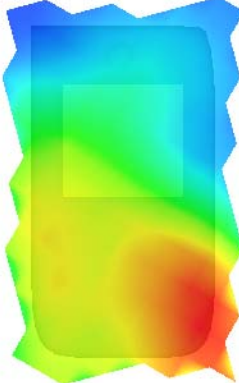
3D screen shot	Hot spot position
	

MEASUREMENT 6

Type: Phone measurement (Complete)

Date of measurement: 06/19/2015

Measurement duration: 12 minutes 3 seconds

A. Experimental conditions

Area Scan	sam_direct_droit2_surf8mm.txt
Phantom	Right head
Device Position	Tilt
Band	GSM1900
Channels	Middle
Signal	TDMA (Crest factor: 8.0)

B. SAR Measurement Results

Frequency (MHz)	1880.000000
Relative permittivity (real part)	38.560124
Conductivity (S/m)	1.380369
Variation (%)	-0.380000

Maximum location: X=-33.00, Y=-16.00

SAR 10g (W/Kg)	0.004235
SAR 1g (W/Kg)	0.007407

Z Axis Scan

Z (mm)	0.00	4.00	9.00	14.00	19.00	24.00	29.00
SAR (W/Kg)	0.0116	0.0079	0.0049	0.0031	0.0020	0.0116	0.0079

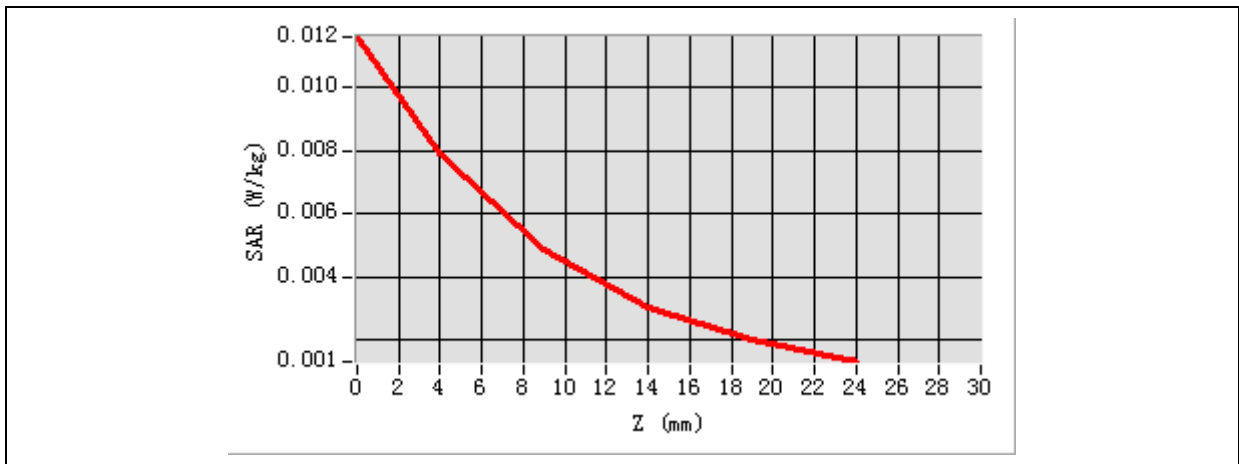

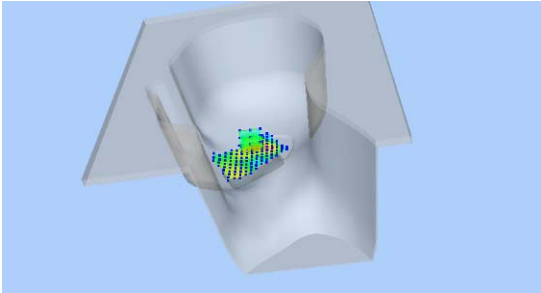
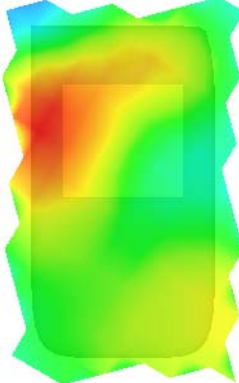
3D screen shot	Hot spot position
	

MEASUREMENT 7

Type: Phone measurement (Complete)

Date of measurement: 06/19/2015

Measurement duration: 12 minutes 3 seconds

A. Experimental conditions

Area Scan	sam_direct_droit2_surf8mm.txt
Phantom	Left head
Device Position	Cheek
Band	GSM1900
Channels	Middle
Signal	TDMA (Crest factor: 8.0)

B. SAR Measurement Results

Frequency (MHz)	1880.000000
Relative permittivity (real part)	38.560124
Conductivity (S/m)	1.380369
Variation (%)	0.890000

Maximum location: X=-33.00, Y=-16.00

SAR 10g (W/Kg)	0.020631
SAR 1g (W/Kg)	0.036542

Z Axis Scan

Z (mm)	0.00	4.00	9.00	14.00	19.00	24.00	29.00
SAR (W/Kg)	0.0597	0.0382	0.0218	0.0133	0.0093	0.0597	0.0382

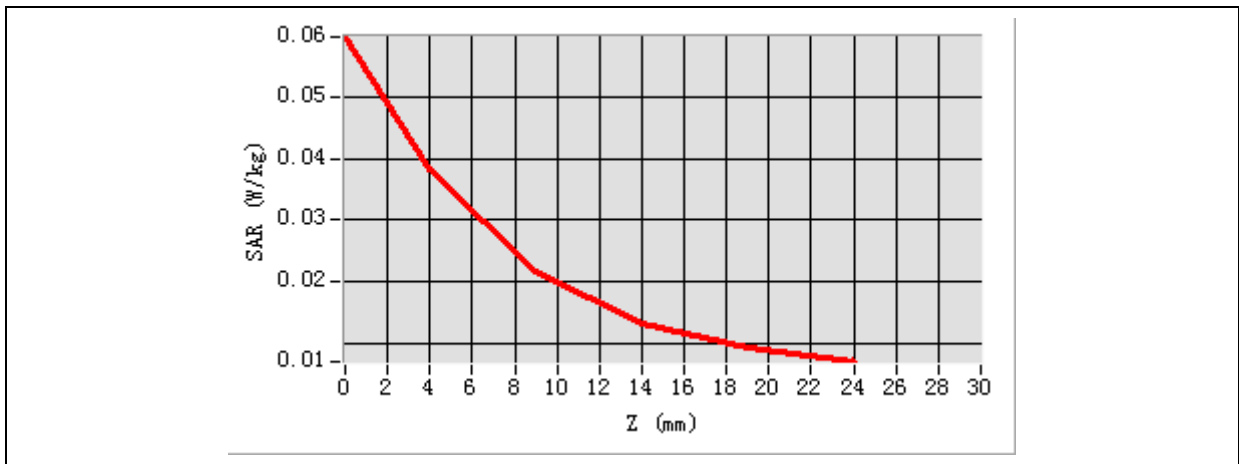

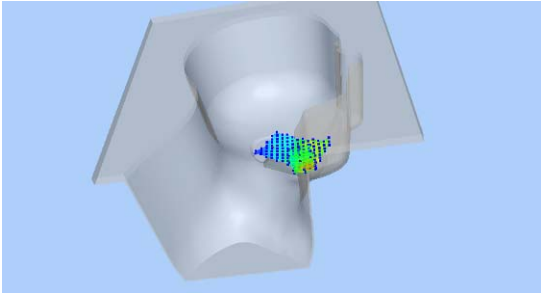
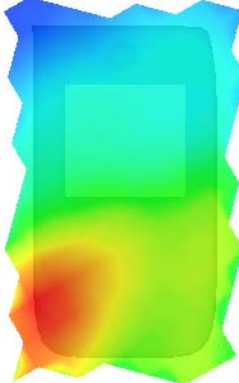
3D screen shot	Hot spot position
	

MEASUREMENT 8

Type: Phone measurement (Complete)

Date of measurement: 06/192015

Measurement duration: 12 minutes 3 seconds

A. Experimental conditions

Area Scan	sam_direct_droit2_surf8mm.txt
Phantom	Left head
Device Position	Tilt
Band	GSM1900
Channels	Middle
Signal	TDMA (Crest factor: 8.0)

B. SAR Measurement Results

Frequency (MHz)	1880.000000
Relative permittivity (real part)	38.560124
Conductivity (S/m)	1.380369
Variation (%)	-2.840000

Maximum location: X=-33.00, Y=-16.00

SAR 10g (W/Kg)	0.003116
SAR 1g (W/Kg)	0.005356

Z Axis Scan

Z (mm)	0.00	4.00	9.00	14.00	19.00	24.00	29.00
SAR (W/Kg)	0.0079	0.0056	0.0036	0.0022	0.0013	0.0079	0.0056

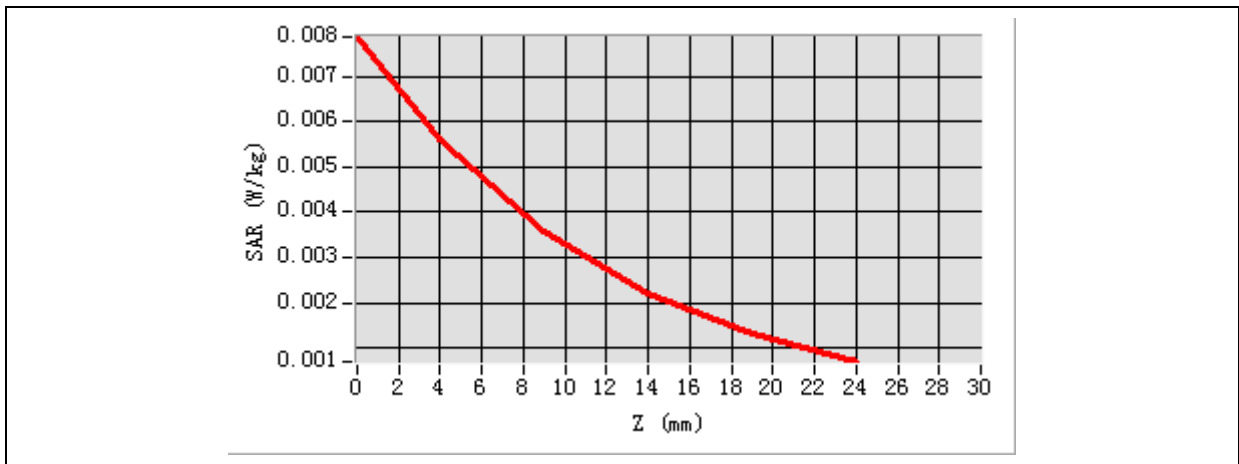

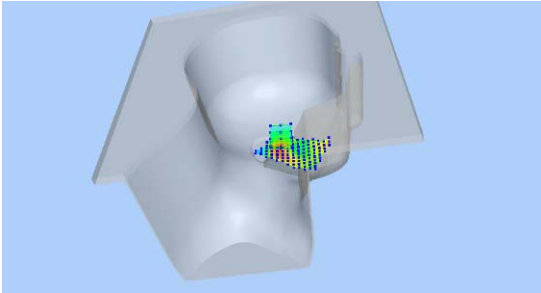
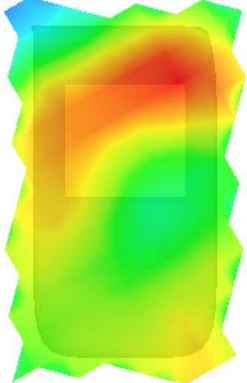
3D screen shot	Hot spot position
	

MEASUREMENT 9

Type: Phone measurement (Complete)

Date of measurement: 06/18/2015

Measurement duration: 12 minutes 3 seconds

A. Experimental conditions

Area Scan	sam_direct_droit2_surf8mm.txt
Phantom	Body plane
Device Position	Front
Band	GPRS850-4TX
Channels	Middle
Signal	Duty Cycle 1:2

B. SAR Measurement Results

Frequency (MHz)	836.600000
Relative permittivity (real part)	54.851214
Conductivity (S/m)	0.951454
Variation (%)	-1.160000

Maximum location: X=-33.00, Y=-16.00

SAR 10g (W/Kg)	0.381117
SAR 1g (W/Kg)	0.502950

Z Axis Scan

Z (mm)	0.00	4.00	9.00	14.00	19.00	24.00	29.00
SAR (W/Kg)	0.5781	0.5051	0.4175	0.3347	0.2586	0.5781	0.5051

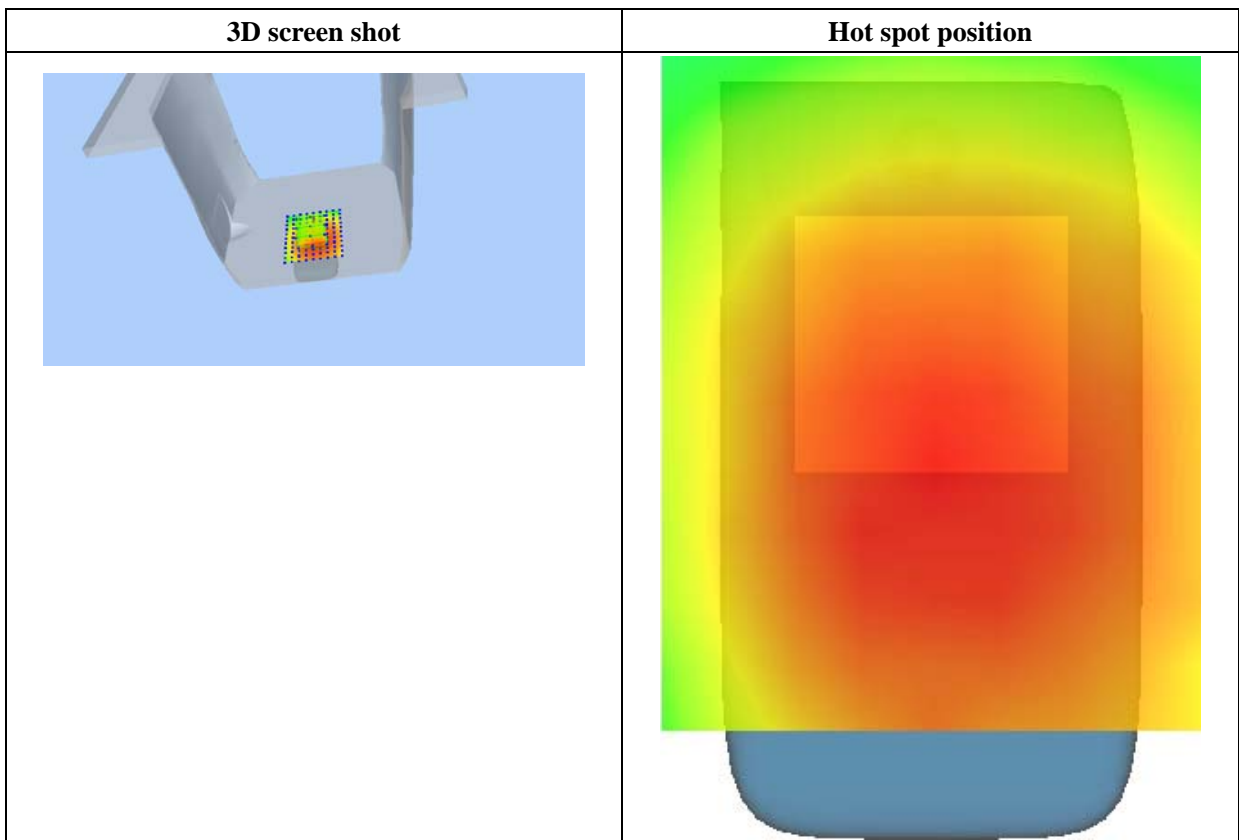
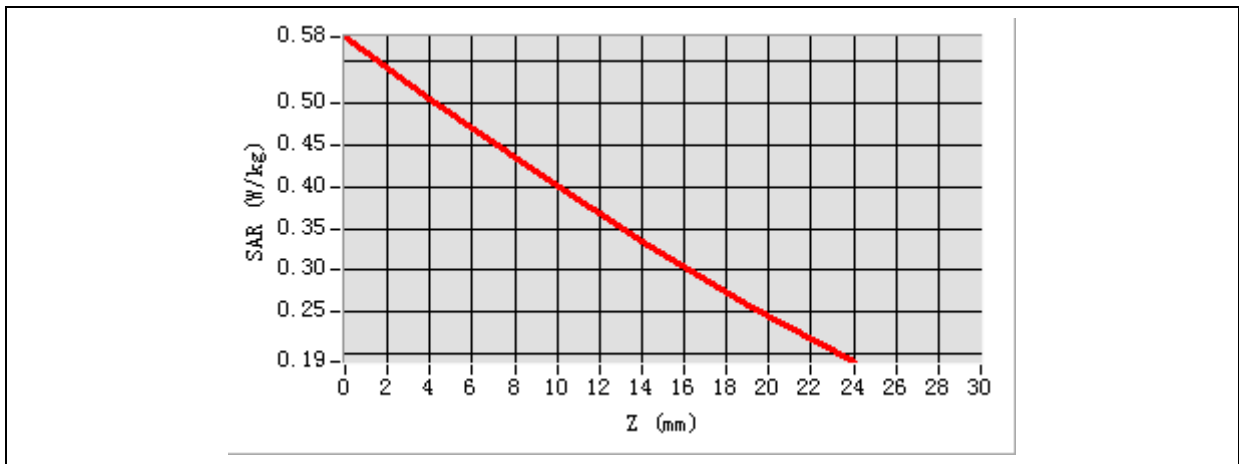

MEASUREMENT 10

Type: Phone measurement (Complete)

Date of measurement: 06/18/2015

Measurement duration: 12 minutes 3 seconds

A. Experimental conditions

Area Scan	sam_direct_droit2_surf8mm.txt
Phantom	Body plane
Device Position	Back
Band	GPRS850-4TX
Channels	Middle
Signal	Duty Cycle 1:2

B. SAR Measurement Results

Frequency (MHz)	836.600000
Relative permittivity (real part)	54.851214
Conductivity (S/m)	0.951454
Variation (%)	3.950000

Maximum location: X=-33.00, Y=-16.00

SAR 10g (W/Kg)	0.505057
SAR 1g (W/Kg)	0.679476

Z Axis Scan

Z (mm)	0.00	4.00	9.00	14.00	19.00	24.00	29.00
SAR (W/Kg)	0.8742	0.7003	0.5347	0.4164	0.3320	0.8742	0.7003

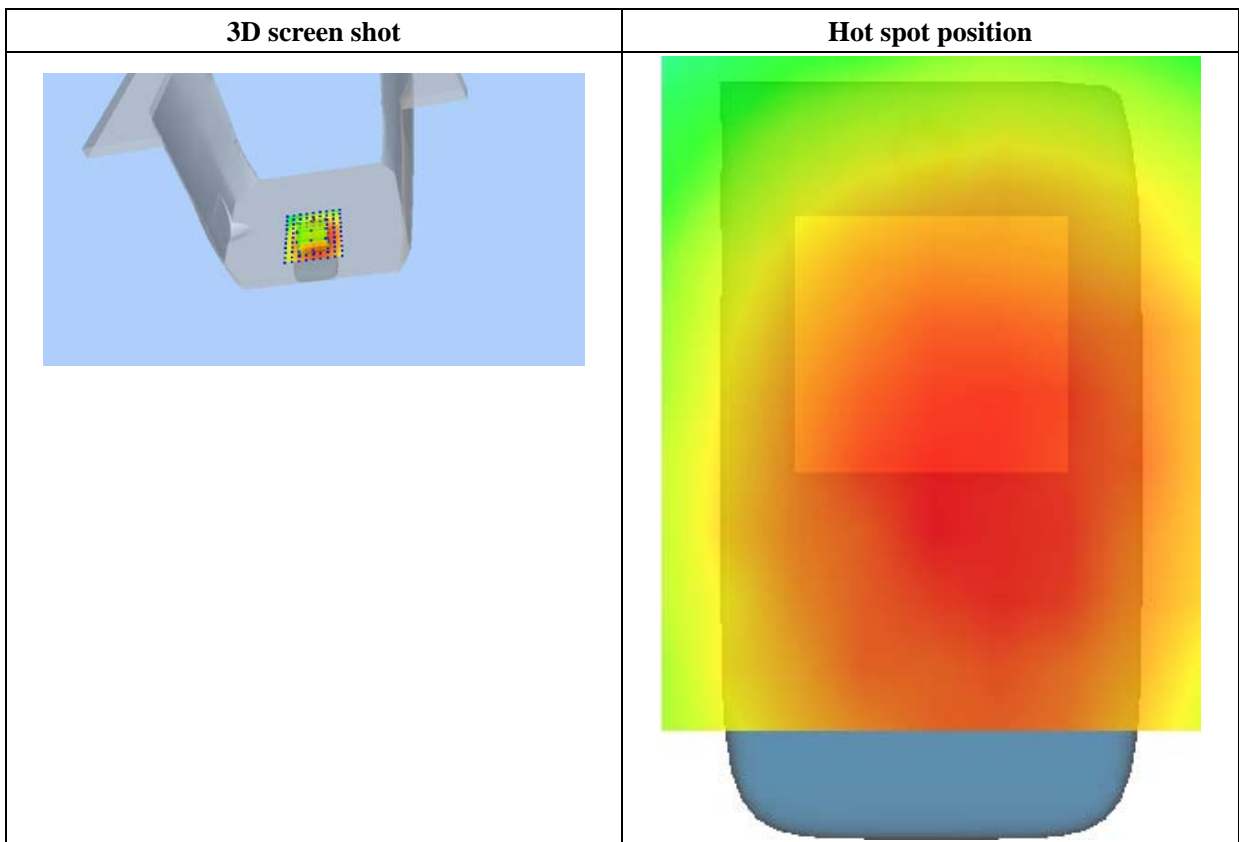
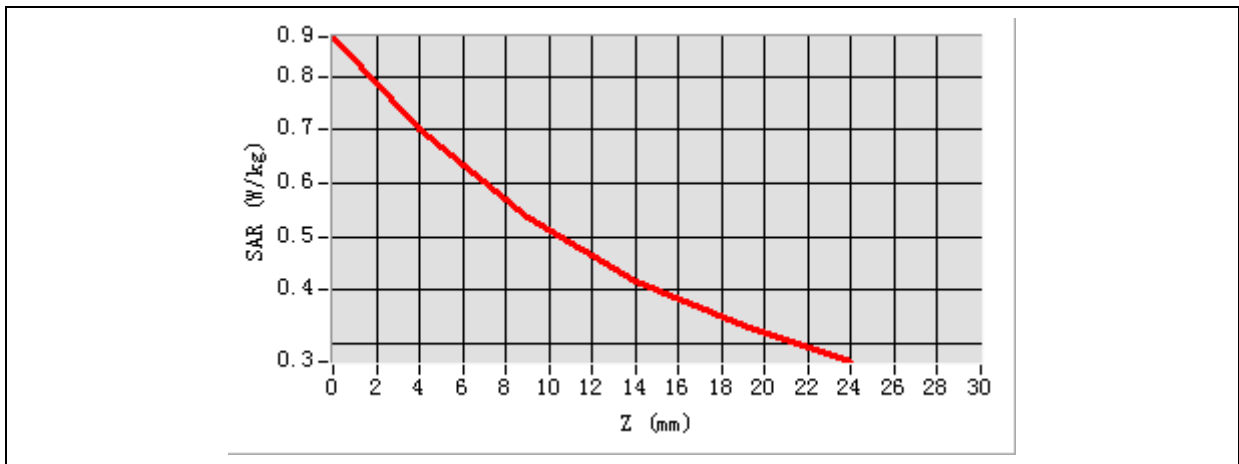

MEASUREMENT 11

Type: Phone measurement (Complete)

Date of measurement: 06/18/2015

Measurement duration: 12 minutes 3 seconds

A. Experimental conditions

Area Scan	sam_direct_droit2_surf8mm.txt
Phantom	Body plane
Device Position	Right
Band	GPRS850-4TX
Channels	Middle
Signal	Duty Cycle 1:2

B. SAR Measurement Results

Frequency (MHz)	836.600000
Relative permittivity (real part)	54.851214
Conductivity (S/m)	0.951454
Variation (%)	-3.550000

Maximum location: X=-33.00, Y=-16.00

SAR 10g (W/Kg)	0.269949
SAR 1g (W/Kg)	0.389490

Z Axis Scan

Z (mm)	0.00	4.00	9.00	14.00	19.00	24.00	29.00
SAR (W/Kg)	0.5260	0.4071	0.2945	0.2139	0.1563	0.5260	0.4071

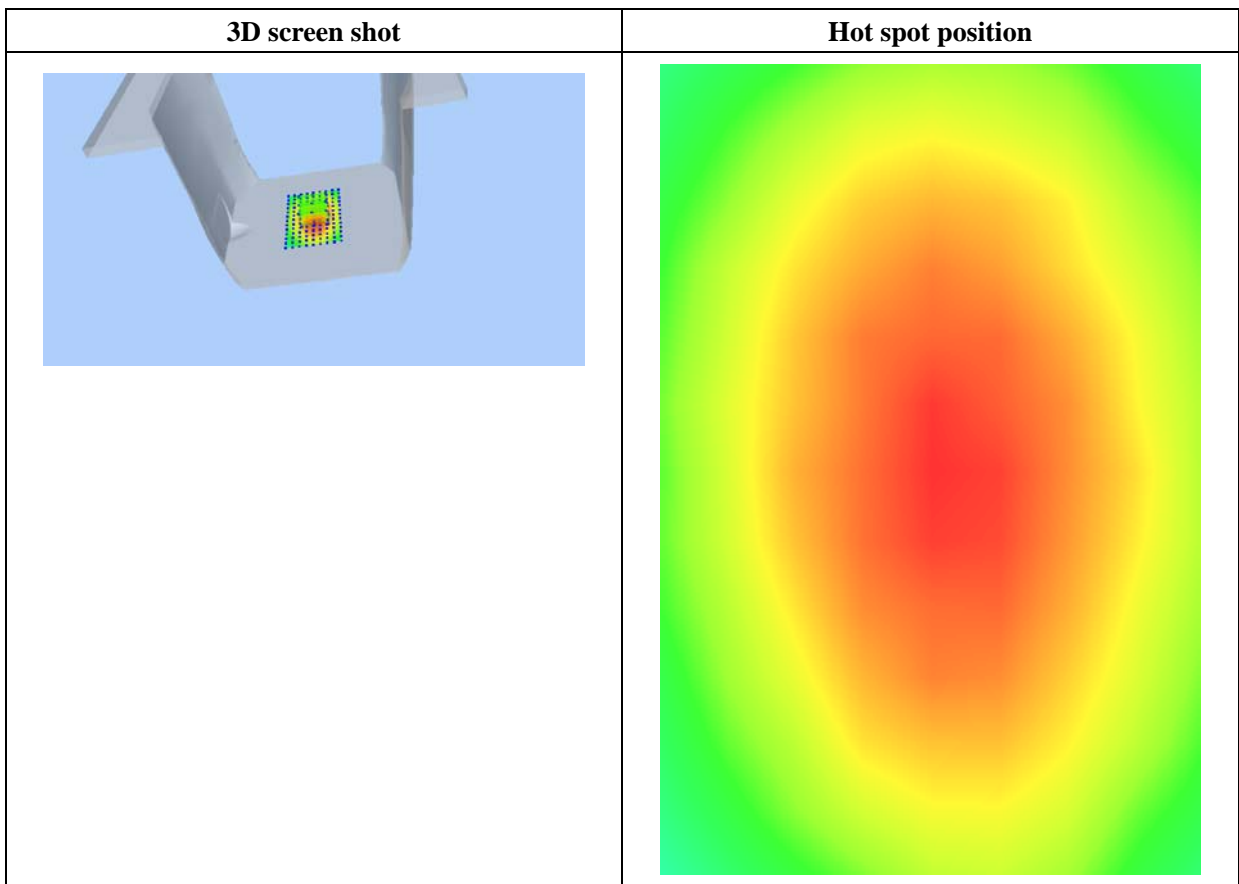
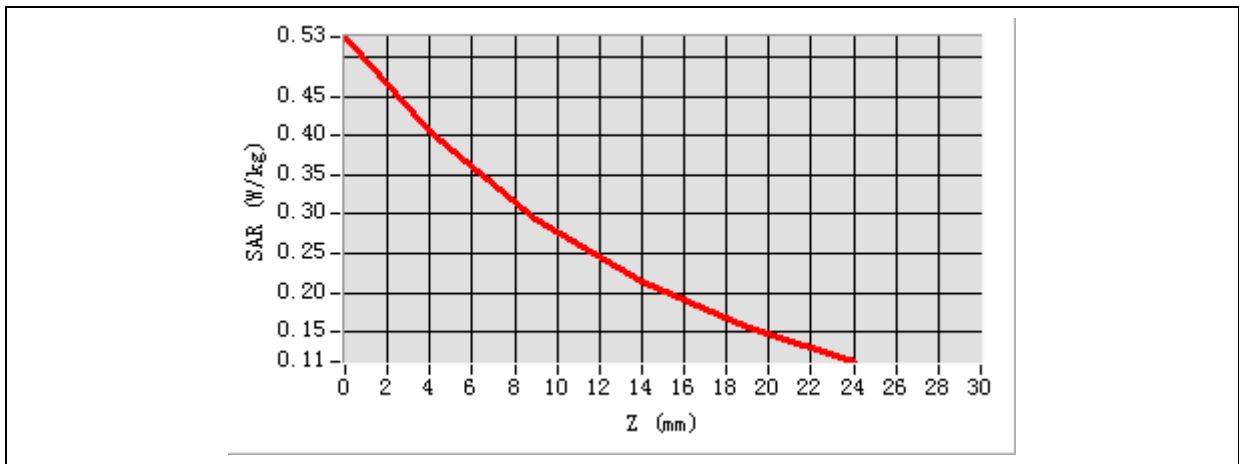

MEASUREMENT 12

Type: Phone measurement (Complete)

Date of measurement: 06/18/2015

Measurement duration: 12 minutes 3 seconds

A. Experimental conditions

Area Scan	sam_direct_droit2_surf8mm.txt
Phantom	Body plane
Device Position	Bottom
Band	GPRS850-4TX
Channels	Middle
Signal	Duty Cycle 1:2

B. SAR Measurement Results

Frequency (MHz)	836.600000
Relative permittivity (real part)	54.851214
Conductivity (S/m)	0.951454
Variation (%)	-3.540000

Maximum location: X=-33.00, Y=-16.00

SAR 10g (W/Kg)	0.132320
SAR 1g (W/Kg)	0.214185

Z Axis Scan

Z (mm)	0.00	4.00	9.00	14.00	19.00	24.00	29.00
SAR (W/Kg)	0.3278	0.2267	0.1432	0.0940	0.0661	0.3278	0.2267

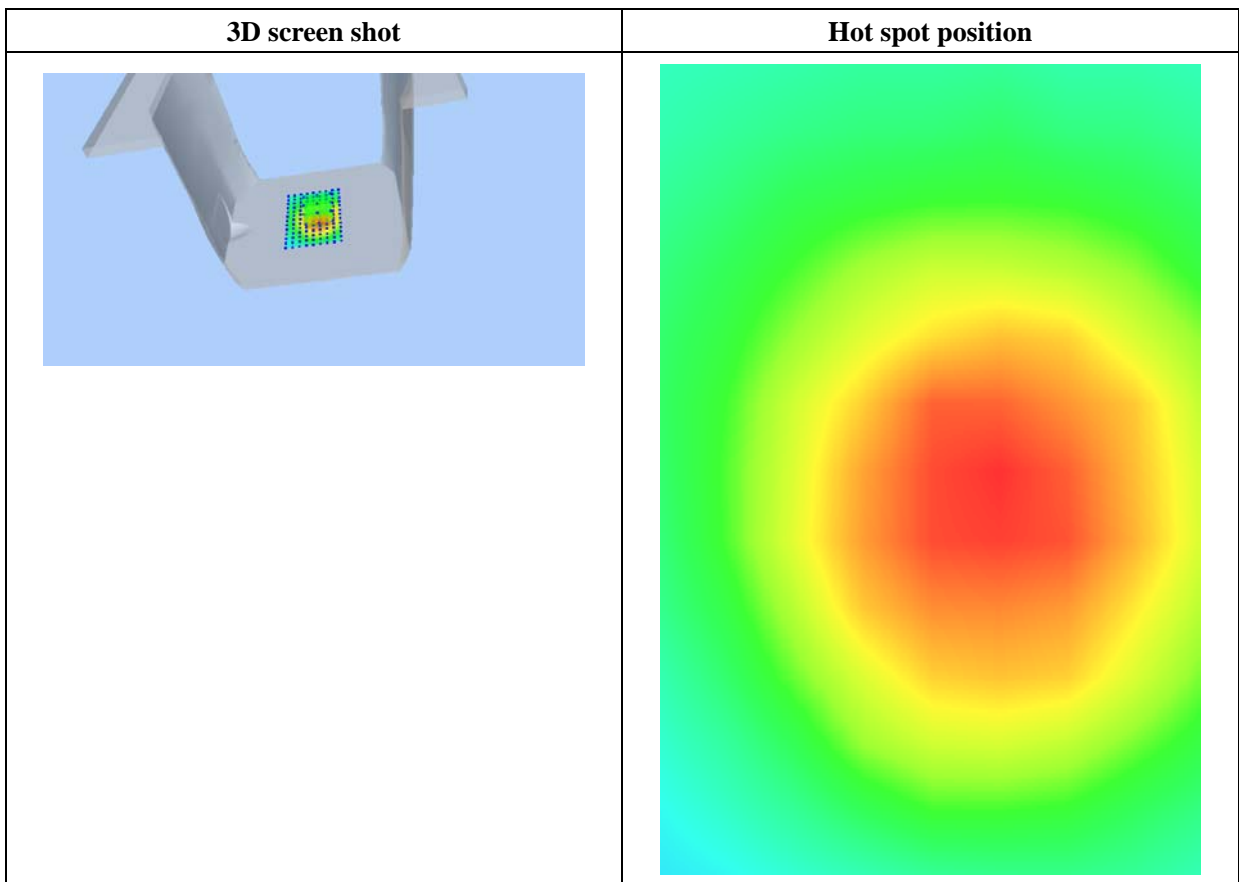
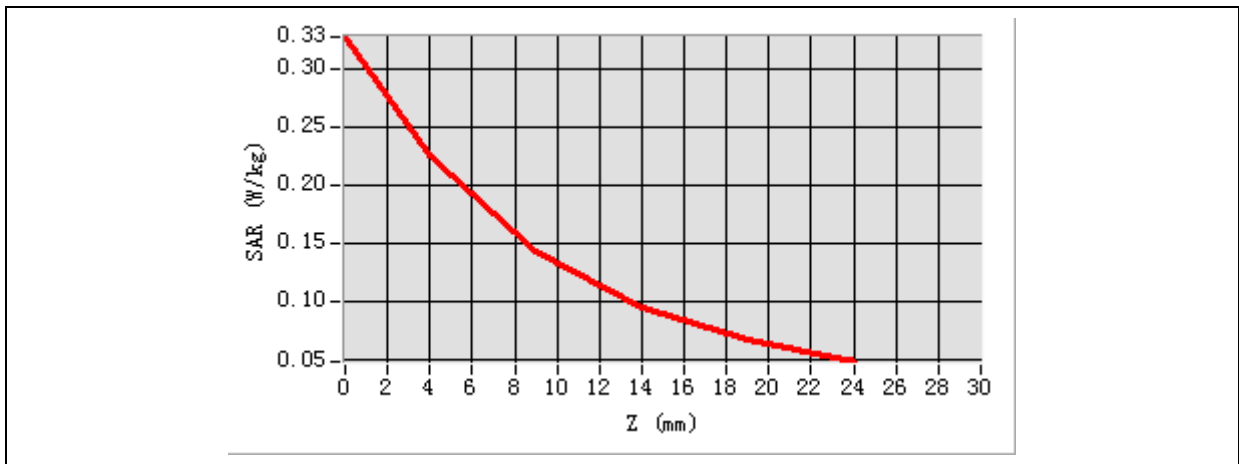

MEASUREMENT 13

Type: Phone measurement (Complete)

Date of measurement: 06/19/2015

Measurement duration: 12 minutes 3 seconds

A. Experimental conditions

Area Scan	sam_direct_droit2_surf8mm.txt
Phantom	Body plane
Device Position	Front
Band	GPRS1900-4TX
Channels	Middle
Signal	Duty Cycle 1:2

B. SAR Measurement Results

Frequency (MHz)	1880.000000
Relative permittivity (real part)	52.420415
Conductivity (S/m)	1.501966
Variation (%)	0.37000

Maximum location: X=-33.00, Y=-16.00

SAR 10g (W/Kg)	0.308569
SAR 1g (W/Kg)	0.550801

Z Axis Scan

Z (mm)	0.00	4.00	9.00	14.00	19.00	24.00	29.00
SAR (W/Kg)	0.8980	0.5864	0.3370	0.1952	0.1176	0.8980	0.5864

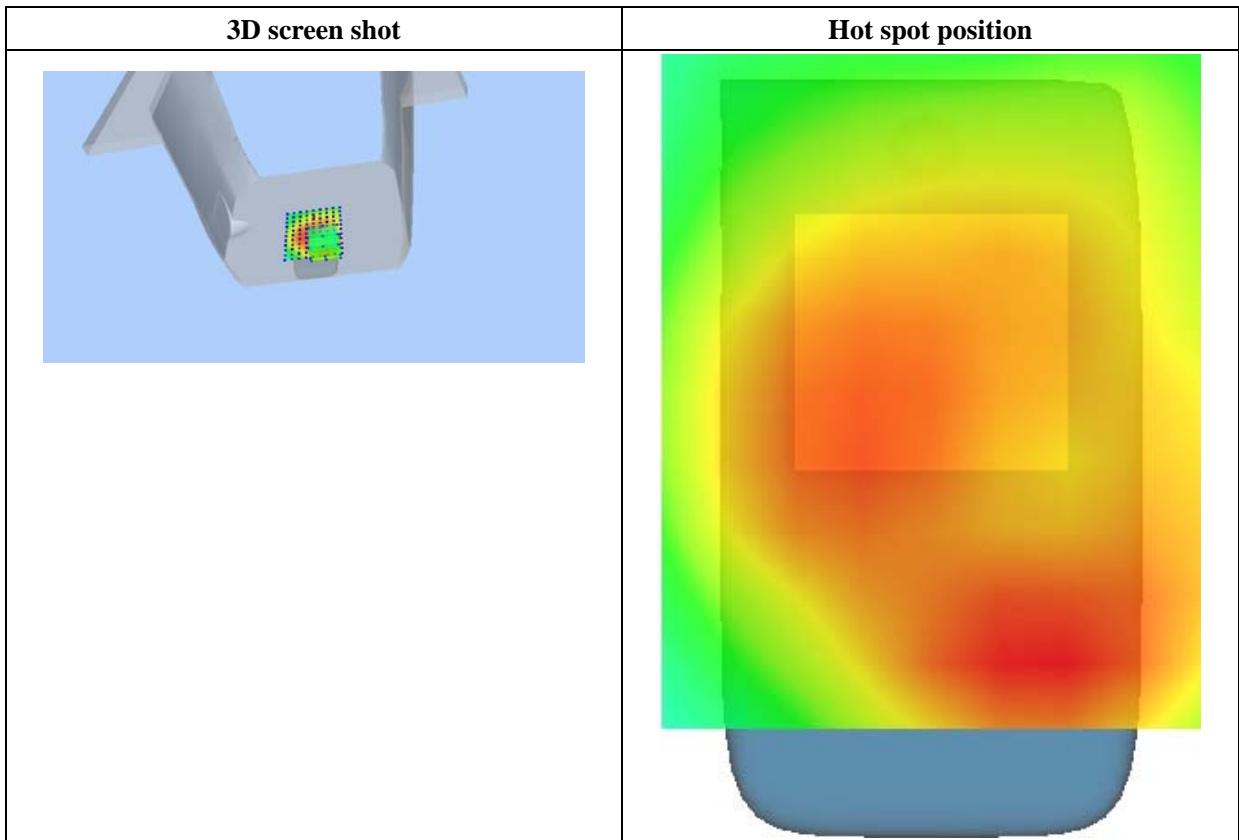
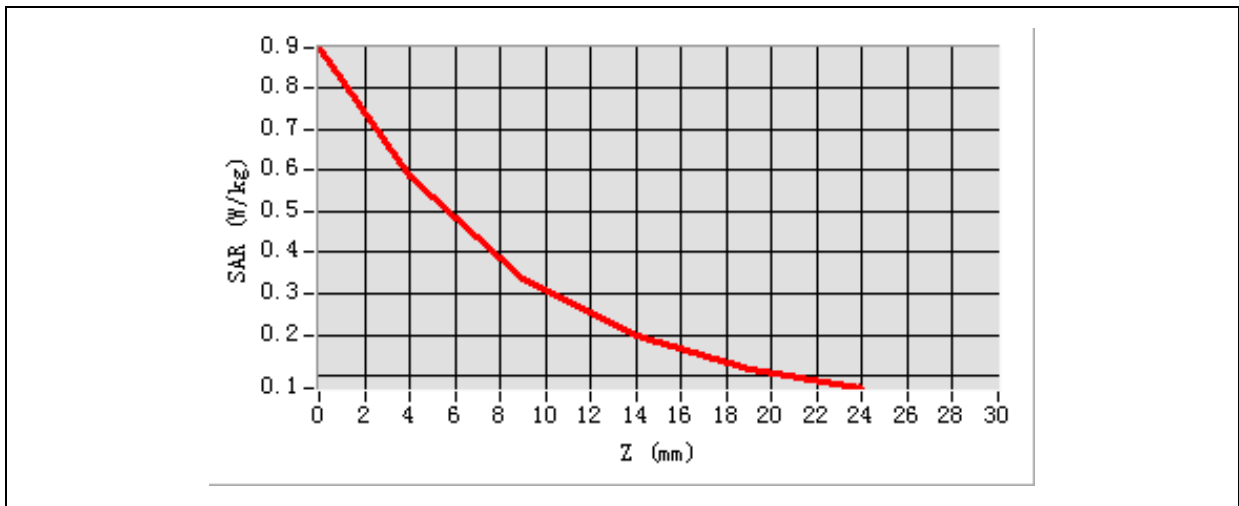

MEASUREMENT 14

Type: Phone measurement (Complete)

Date of measurement: 06/19/2015

Measurement duration: 12 minutes 3 seconds

A. Experimental conditions

Area Scan	sam_direct_droit2_surf8mm.txt
Phantom	Body plane
Device Position	Back
Band	GPRS1900-4TX
Channels	Middle
Signal	Duty Cycle 1:2

B. SAR Measurement Results

Frequency (MHz)	1880.000000
Relative permittivity (real part)	52.420415
Conductivity (S/m)	1.501966
Variation (%)	1.220000

Maximum location: X=-33.00, Y=-16.00

SAR 10g (W/Kg)	0.438258
SAR 1g (W/Kg)	0.785279

Z Axis Scan

Z (mm)	0.00	4.00	9.00	14.00	19.00	24.00	29.00
SAR (W/Kg)	1.2557	0.8311	0.4853	0.2834	0.1693	1.2557	0.8311

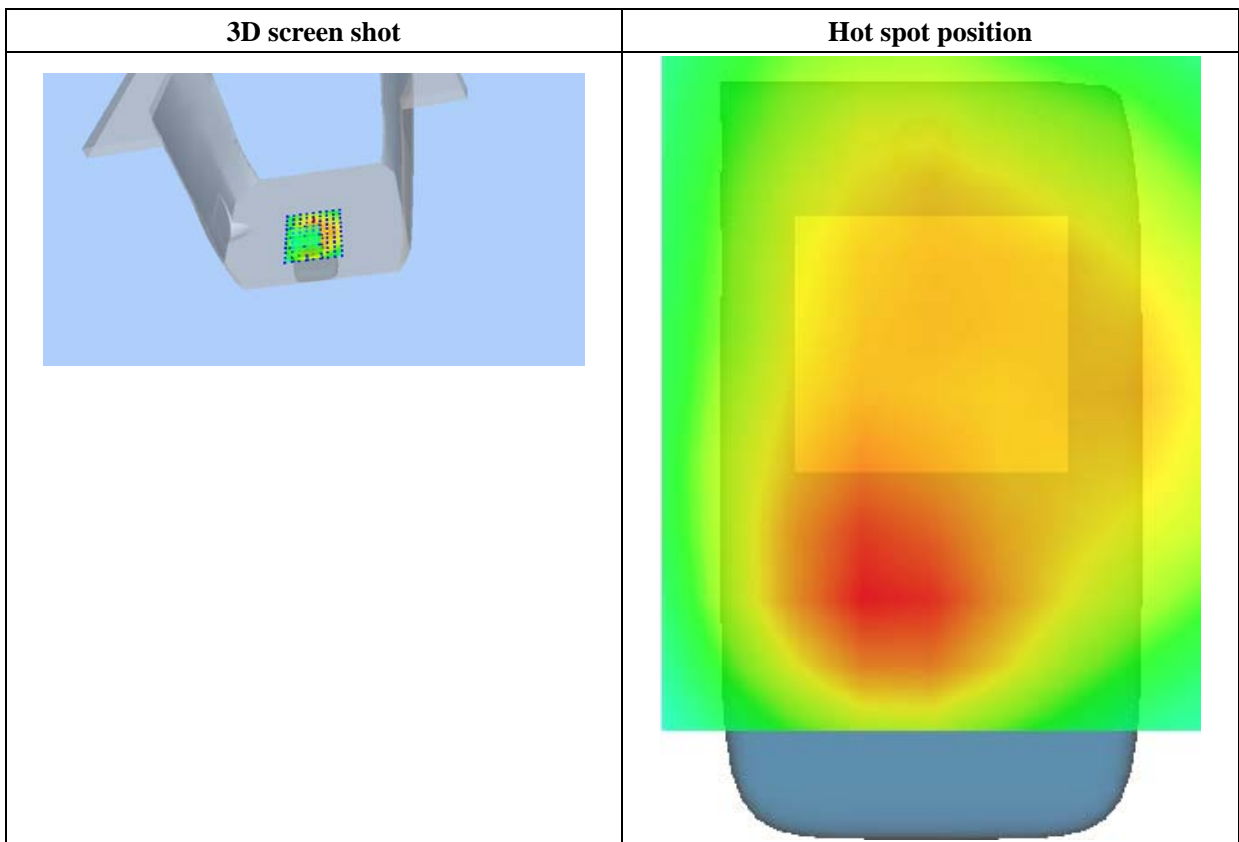
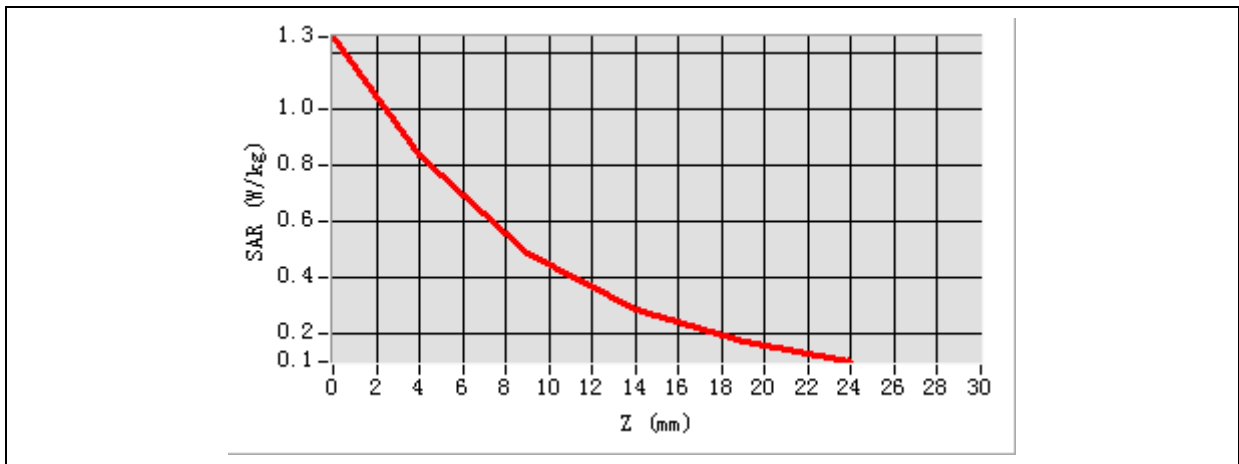

MEASUREMENT 15

Type: Phone measurement (Complete)

Date of measurement: 06/19/2015

Measurement duration: 12 minutes 3 seconds

A. Experimental conditions

Area Scan	sam_direct_droit2_surf8mm.txt
Phantom	Body plane
Device Position	Right
Band	GPRS1900-4TX
Channels	Middle
Signal	Duty Cycle 1:2

B. SAR Measurement Results

Frequency (MHz)	1880.000000
Relative permittivity (real part)	52.420415
Conductivity (S/m)	1.501966
Variation (%)	-0.720000

Maximum location: X=-33.00, Y=-16.00

SAR 10g (W/Kg)	0.126060
SAR 1g (W/Kg)	0.223216

Z Axis Scan

Z (mm)	0.00	4.00	9.00	14.00	19.00	24.00	29.00
SAR (W/Kg)	0.3726	0.2368	0.1318	0.0750	0.0460	0.3726	0.2368

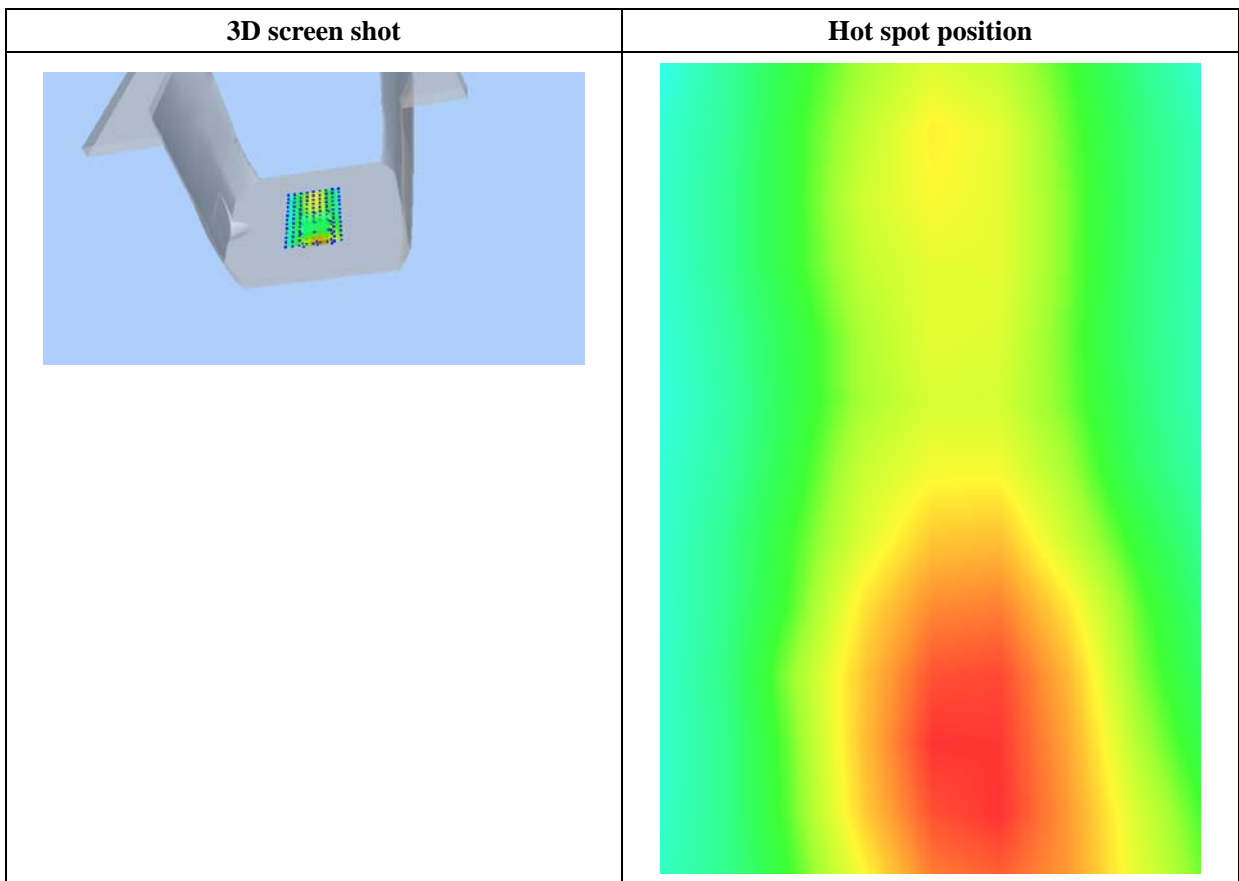
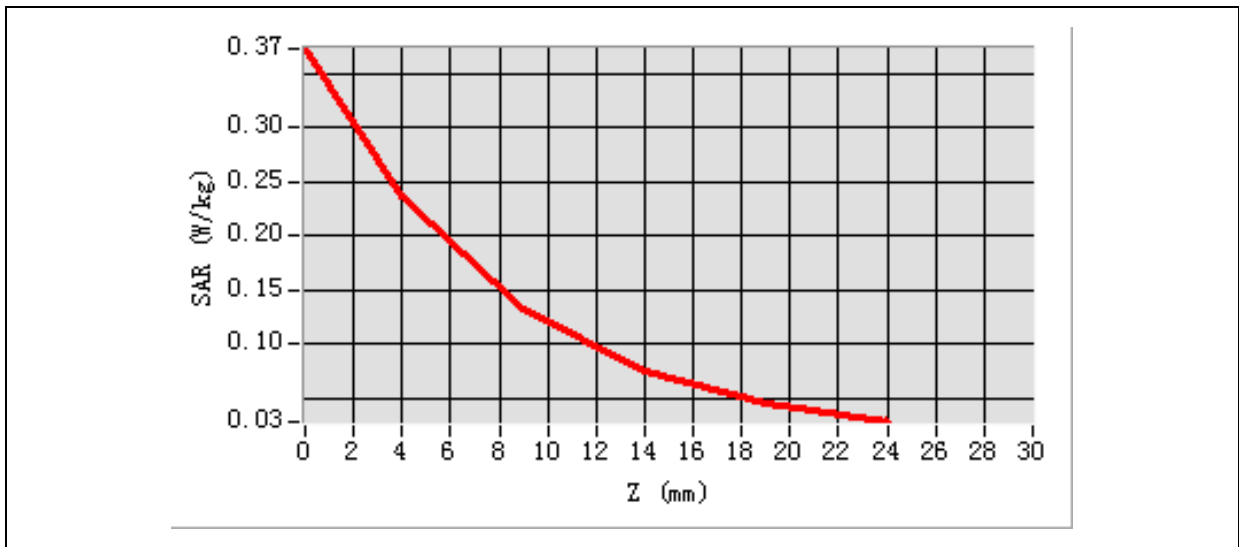

MEASUREMENT 16

Type: Phone measurement (Complete)

Date of measurement: 06/19/2015

Measurement duration: 12 minutes 3 seconds

A. Experimental conditions

Area Scan	sam_direct_droit2_surf8mm.txt
Phantom	Body plane
Device Position	Bottom
Band	GPRS1900-4TX
Channels	Low
Signal	Duty Cycle 1:2

B. SAR Measurement Results

Lower Band SAR (Channel 661)

Frequency (MHz)	1852.000000
Relative permittivity (real part)	52.420415
Conductivity (S/m)	1.501966
Variation (%)	0.650000

Maximum location: X=-33.00, Y=-16.00

SAR 10g (W/Kg)	0.606417
SAR 1g (W/Kg)	1.078061

Z Axis Scan

Z (mm)	0.00	4.00	9.00	14.00	19.00	24.00	29.00
SAR (W/Kg)	1.7254	1.1574	0.6891	0.4109	0.2504	1.7254	1.1574

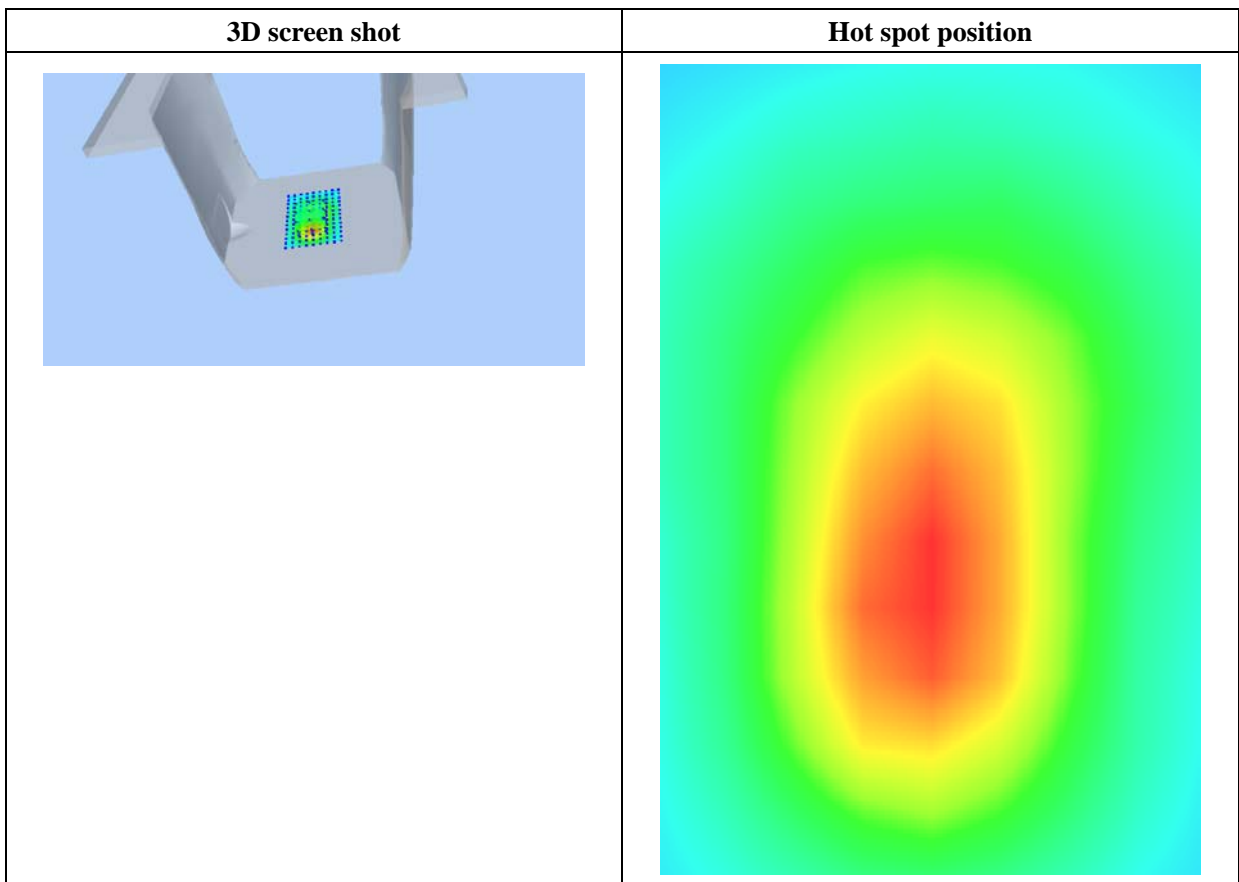
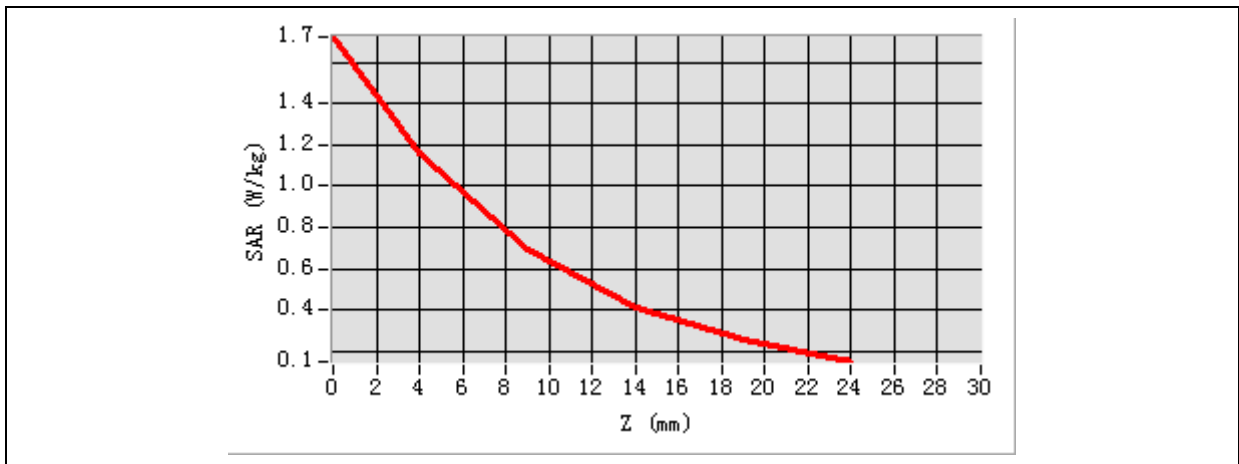

MEASUREMENT 17

Type: Phone measurement (Complete)

Date of measurement: 06/19/2015

Measurement duration: 12 minutes 3 seconds

A. Experimental conditions

Area Scan	sam_direct_droit2_surf8mm.txt
Phantom	Body plane
Device Position	Bottom
Band	GPRS1900-4TX
Channels	Low
Signal	Duty Cycle 1:2

B. SAR Measurement Results

Lower Band SAR (Channel 810)

Frequency (MHz)	1852.000000
Relative permittivity (real part)	52.420415
Conductivity (S/m)	1.501966
Variation (%)	-0.650000

Maximum location: X=-33.00, Y=-16.00

SAR 10g (W/Kg)	0.663478
SAR 1g (W/Kg)	1.159587

Z Axis Scan

Z (mm)	0.00	4.00	9.00	14.00	19.00	24.00	29.00
SAR (W/Kg)	1.9643	1.3030	0.7637	0.4483	0.2697	1.9643	1.3030

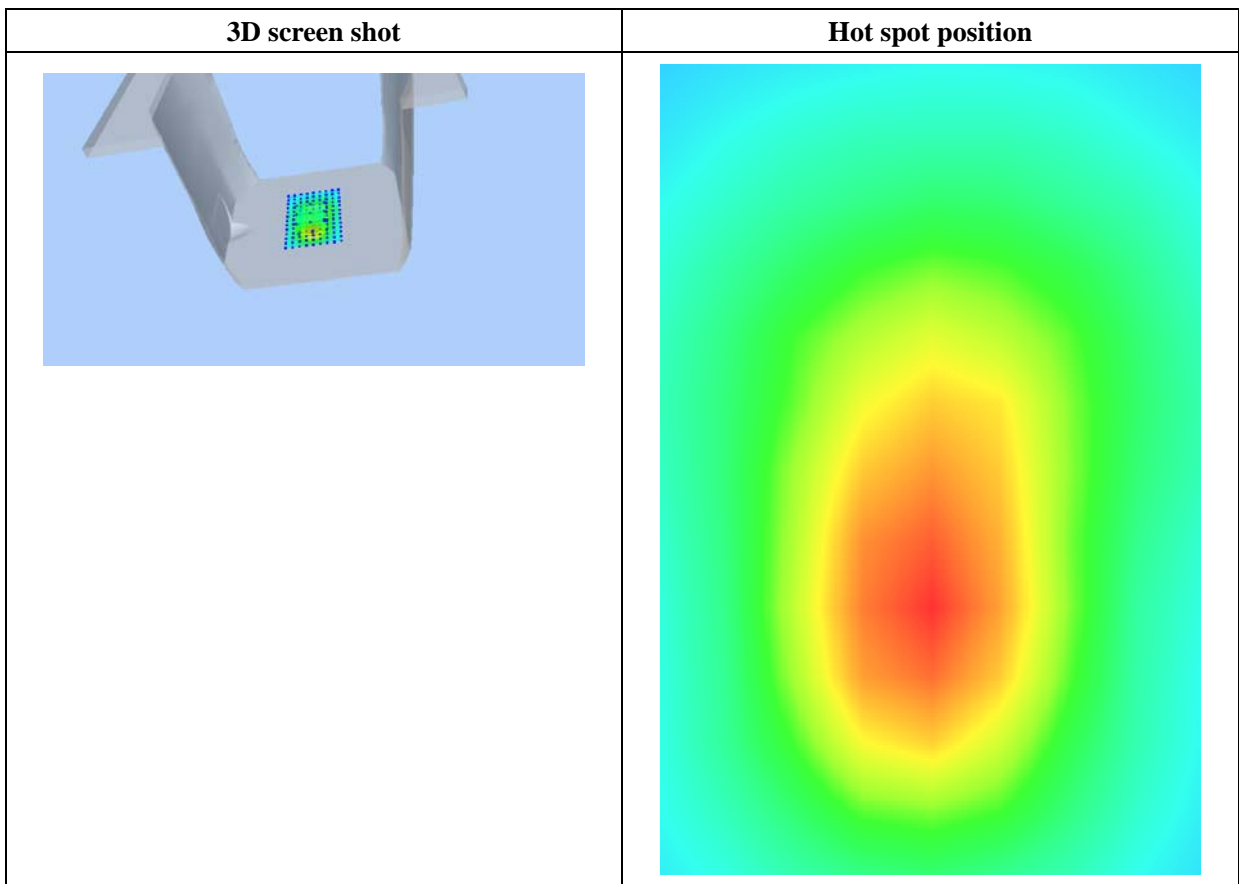
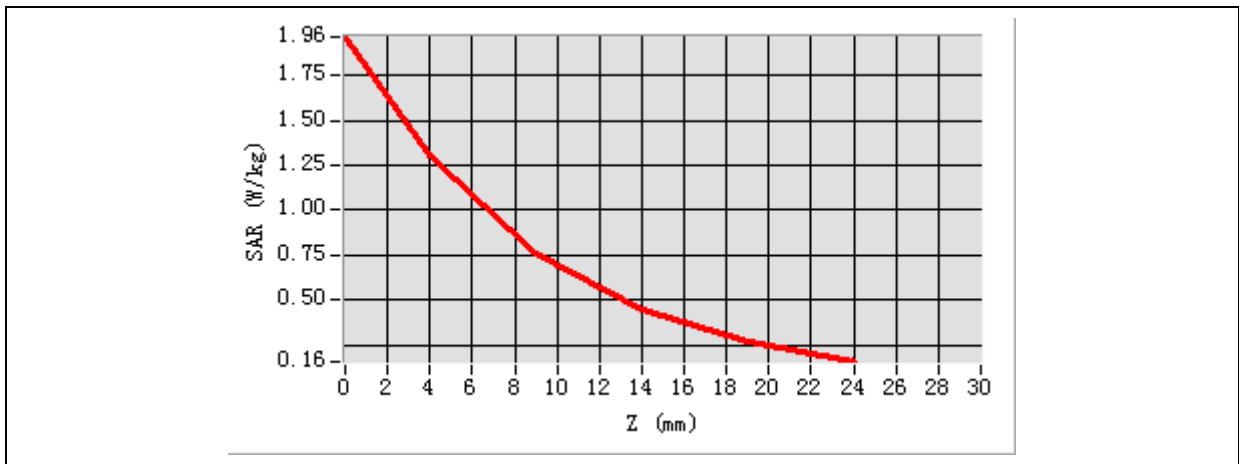

MEASUREMENT 18

Type: Phone measurement (Complete)

Date of measurement: 06/19/2015

Measurement duration: 12 minutes 3 seconds

A. Experimental conditions

Area Scan	sam_direct_droit2_surf8mm.txt
Phantom	Body plane
Device Position	Bottom
Band	GPRS1900-4TX
Channels	Middle
Signal	Duty Cycle 1:2

B. SAR Measurement Results

Lower Band SAR (Channel 512)

Frequency (MHz)	1880.000000
Relative permittivity (real part)	52.420415
Conductivity (S/m)	1.501966
Variation (%)	-1.340000

Maximum location: X=-33.00, Y=-16.00

SAR 10g (W/Kg)	0.467526
SAR 1g (W/Kg)	0.866843

Z Axis Scan

Z (mm)	0.00	4.00	9.00	14.00	19.00	24.00	29.00
SAR (W/Kg)	1.4332	0.9332	0.5331	0.3056	0.1812	1.4332	0.9332

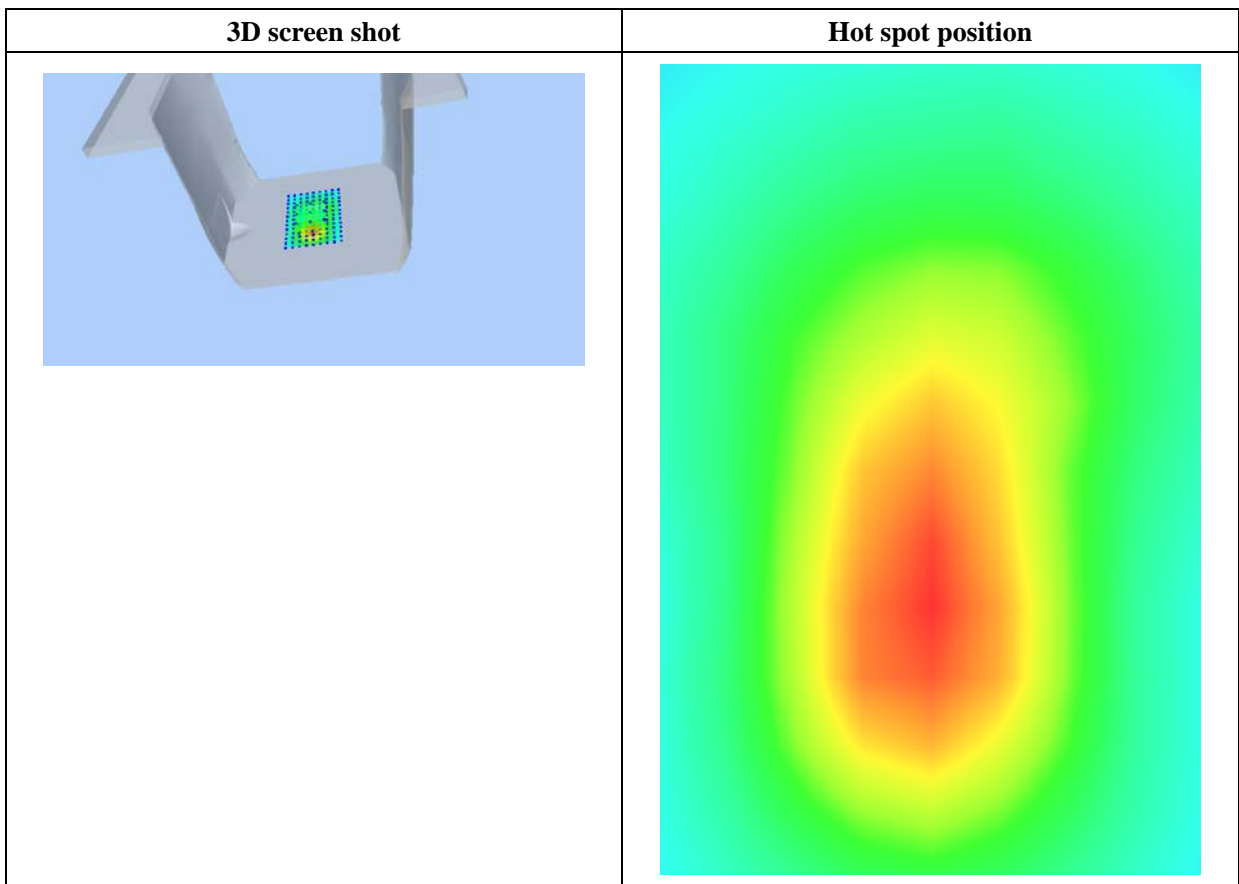
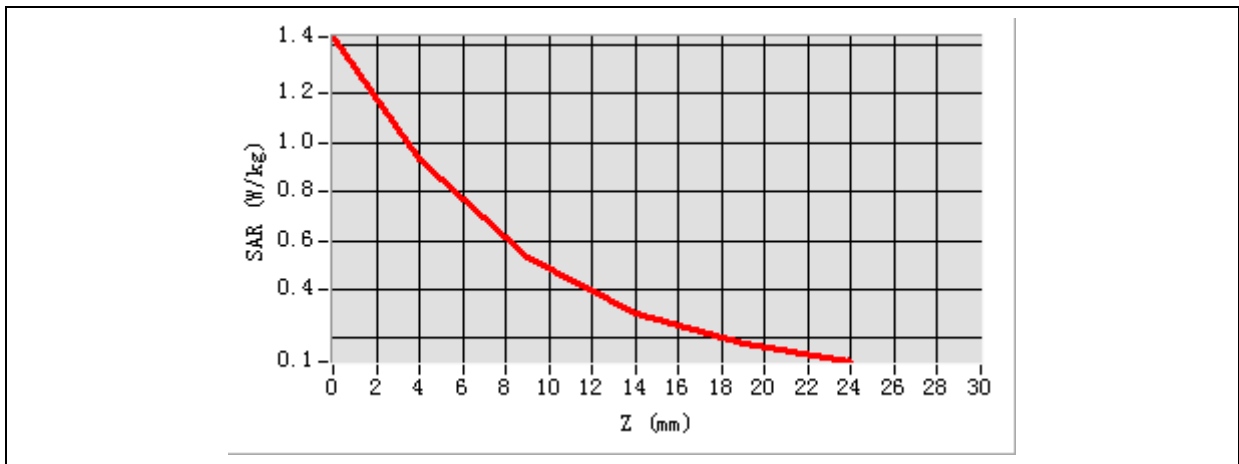

MEASUREMENT 19

Type: Phone measurement (Complete)

Date of measurement: 06/19/2015

Measurement duration: 12 minutes 3 seconds

A. Experimental conditions

Area Scan	sam_direct_droit2_surf8mm.txt
Phantom	Body plane
Device Position	Bottom
Band	GPRS1900-4TX
Channels	High
Signal	Duty Cycle 1:2

B. SAR Measurement Results

Lower Band SAR (Channel 512)

Frequency (MHz)	1909.800000
Relative permittivity (real part)	52.420415
Conductivity (S/m)	1.501966
Variation (%)	-1.410000

Maximum location: X=-33.00, Y=-16.00

SAR 10g (W/Kg)	0.342775
SAR 1g (W/Kg)	0.643457

Z Axis Scan

Z (mm)	0.00	4.00	9.00	14.00	19.00	24.00	29.00
SAR (W/Kg)	1.0966	0.6933	0.3817	0.2137	0.1277	1.0966	0.6933

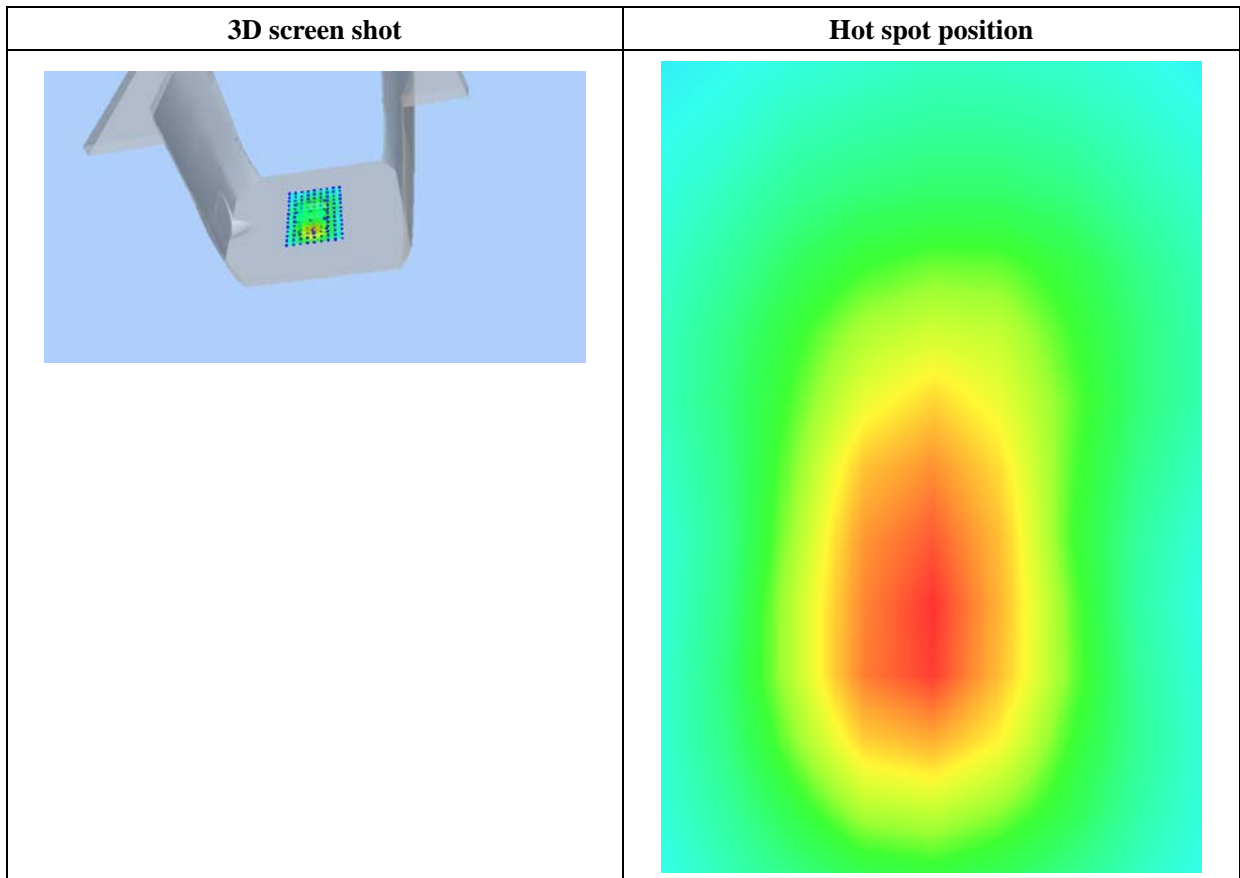
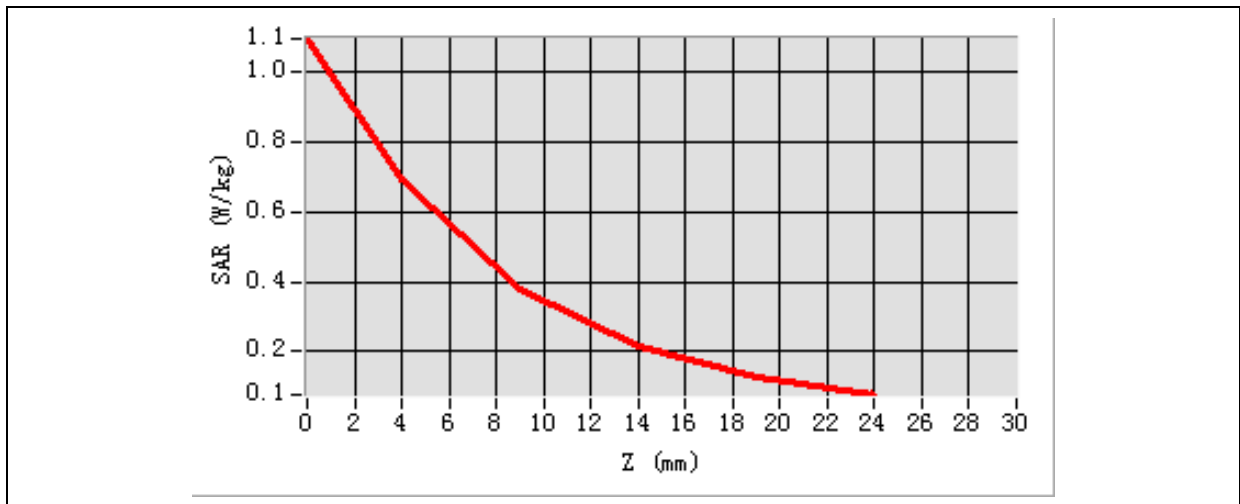

MEASUREMENT 20

Type: Phone measurement (Complete)

Date of measurement: 06/18/2015

Measurement duration: 12 minutes 3 seconds

A. Experimental conditions

Area Scan	sam_direct_droit2_surf8mm.txt
Phantom	Right head
Device Position	Cheek
Band	WCDMA850-RMC
Channels	Middle
Signal	Duty Cycle 1:1

B. SAR Measurement Results

Frequency (MHz)	836.600000
Relative permittivity (real part)	41.110245
Conductivity (S/m)	0.871245
Variation (%)	-0.390000

Maximum location: X=-33.00, Y=-16.00

SAR 10g (W/Kg)	0.204618
SAR 1g (W/Kg)	0.267612

Z Axis Scan

Z (mm)	0.00	4.00	9.00	14.00	19.00	24.00	29.00
SAR (W/Kg)	0.3226	0.2771	0.2284	0.1878	0.1537	0.3226	0.2771

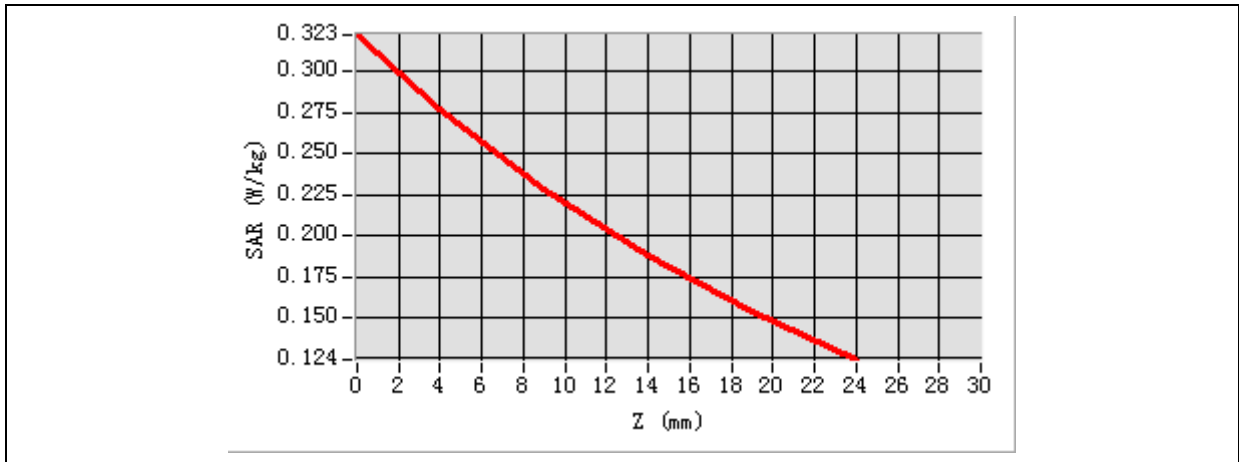

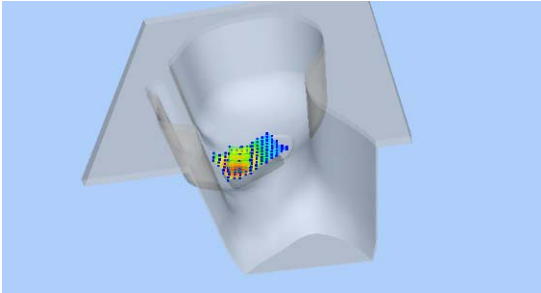
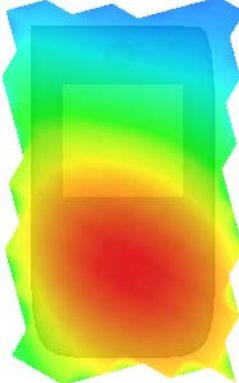
3D screen shot	Hot spot position
	

MEASUREMENT 21

Type: Phone measurement (Complete)

Date of measurement: 06/18/2015

Measurement duration: 12 minutes 3 seconds

A. Experimental conditions

Area Scan	sam_direct_droit2_surf8mm.txt
Phantom	Right head
Device Position	Tilt
Band	WCDMA850-RMC
Channels	Middle
Signal	Duty Cycle 1:1

B. SAR Measurement Results

Frequency (MHz)	836.600000
Relative permittivity (real part)	41.110245
Conductivity (S/m)	0.871245
Variation (%)	-1.240000

Maximum location: X=-33.00, Y=-16.00

SAR 10g (W/Kg)	0.104924
SAR 1g (W/Kg)	0.136348

Z Axis Scan

Z (mm)	0.00	4.00	9.00	14.00	19.00	24.00	29.00
SAR (W/Kg)	0.1646	0.1412	0.1163	0.0959	0.0789	0.1646	0.1412

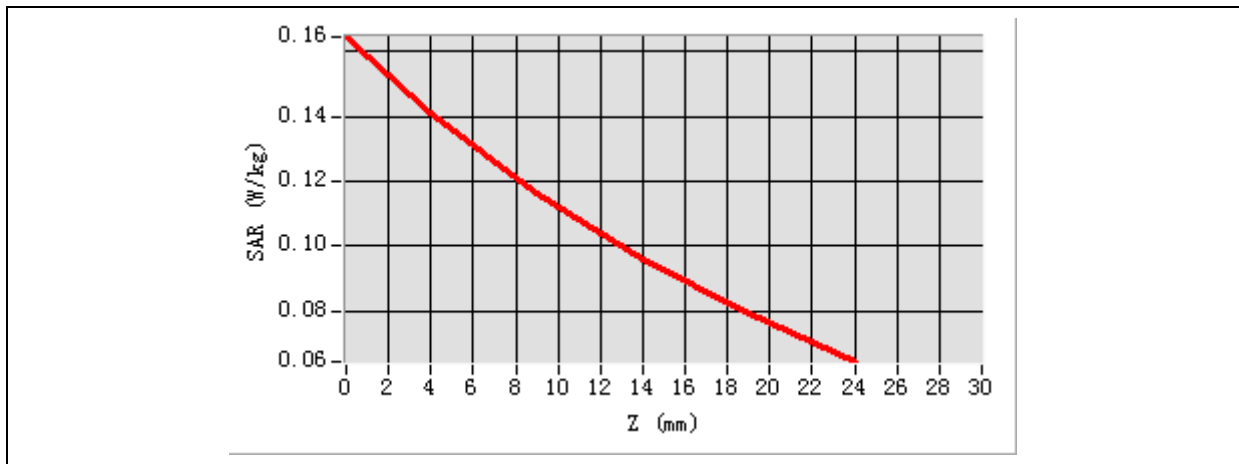

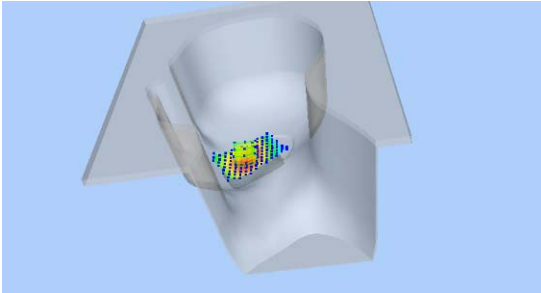
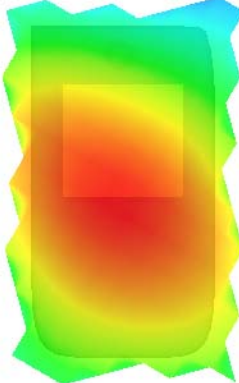
3D screen shot	Hot spot position
	

MEASUREMENT 22

Type: Phone measurement (Complete)

Date of measurement: 06/18/2015

Measurement duration: 12 minutes 3 seconds

A. Experimental conditions

Area Scan	sam_direct_droit2_surf8mm.txt
Phantom	Left head
Device Position	Cheek
Band	WCDMA850-RMC
Channels	Middle
Signal	Duty Cycle 1:1

B. SAR Measurement Results

Frequency (MHz)	836.600000
Relative permittivity (real part)	41.110245
Conductivity (S/m)	0.871245
Variation (%)	0.600000

Maximum location: X=-33.00, Y=-16.00

SAR 10g (W/Kg)	0.204842
SAR 1g (W/Kg)	0.270541

Z Axis Scan

Z (mm)	0.00	4.00	9.00	14.00	19.00	24.00	29.00
SAR (W/Kg)	0.3268	0.2807	0.2307	0.1885	0.1527	0.3268	0.2807

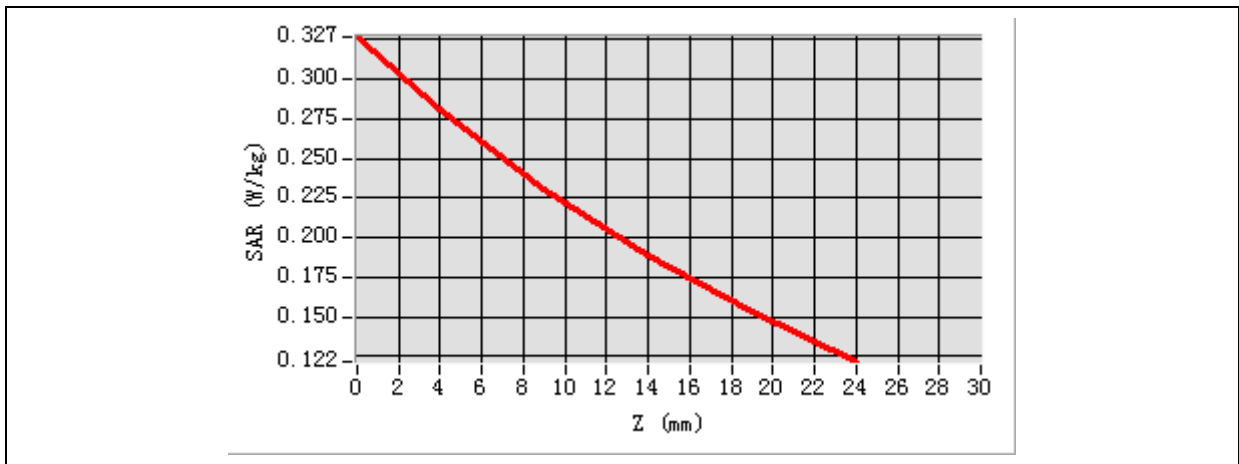

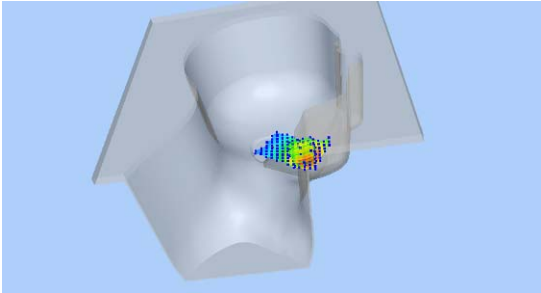
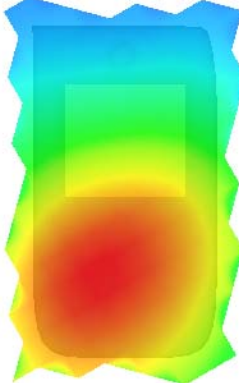
3D screen shot	Hot spot position
	

MEASUREMENT 23

Type: Phone measurement (Complete)

Date of measurement: 06/18/2015

Measurement duration: 12 minutes 3 seconds

A. Experimental conditions

Area Scan	sam_direct_droit2_surf8mm.txt
Phantom	Left head
Device Position	Tilt
Band	WCDMA850-RMC
Channels	Middle
Signal	Duty Cycle 1:1

B. SAR Measurement Results

Frequency (MHz)	836.600000
Relative permittivity (real part)	41.110245
Conductivity (S/m)	0.871245
Variation (%)	0.260000

Maximum location: X=-33.00, Y=-16.00

SAR 10g (W/Kg)	0.076351
SAR 1g (W/Kg)	0.099547

Z Axis Scan

Z (mm)	0.00	4.00	9.00	14.00	19.00	24.00	29.00
SAR (W/Kg)	0.1215	0.1029	0.0836	0.0683	0.0560	0.1215	0.1029

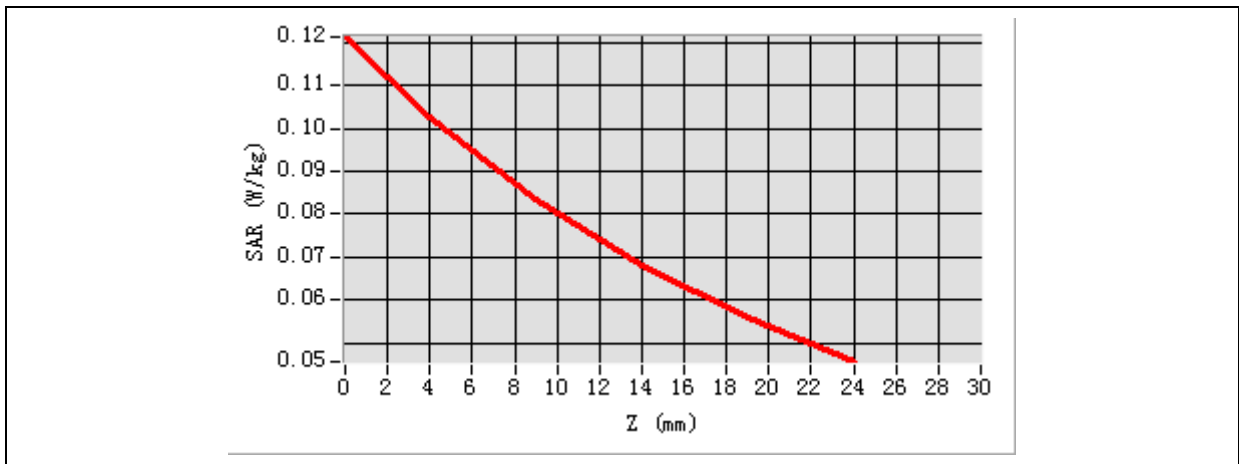

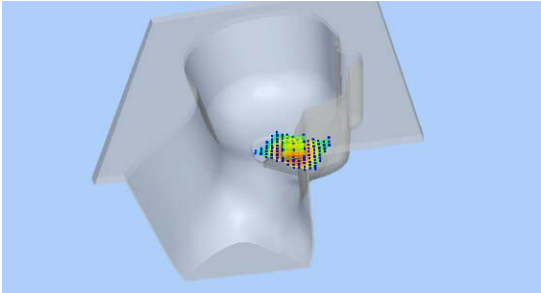
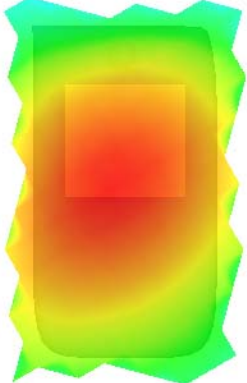
3D screen shot	Hot spot position
	

MEASUREMENT 24

Type: Phone measurement (Complete)

Date of measurement: 06/19/2015

Measurement duration: 12 minutes 3 seconds

A. Experimental conditions

Area Scan	sam_direct_droit2_surf8mm.txt
Phantom	Right head
Device Position	Cheek
Band	WCDMA1900-RMC
Channels	Middle
Signal	Duty Cycle 1:1

B. SAR Measurement Results

Frequency (MHz)	1880.000000
Relative permittivity (real part)	38.560124
Conductivity (S/m)	1.380369
Variation (%)	-1.060000

Maximum location: X=-33.00, Y=-16.00

SAR 10g (W/Kg)	0.235176
SAR 1g (W/Kg)	0.386025

Z Axis Scan

Z (mm)	0.00	4.00	9.00	14.00	19.00	24.00	29.00
SAR (W/Kg)	0.5817	0.4092	0.2616	0.1694	0.1129	0.5817	0.4092

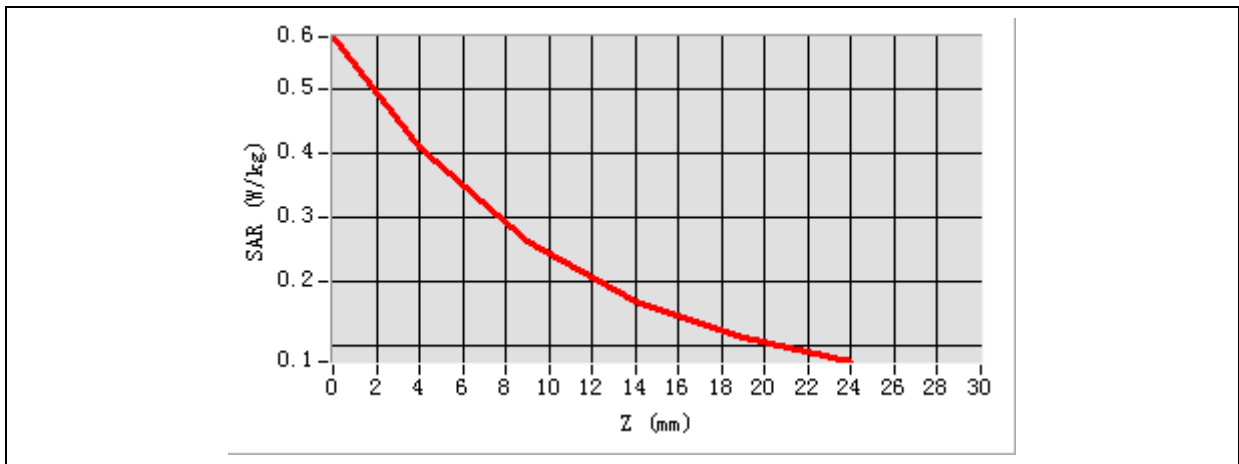

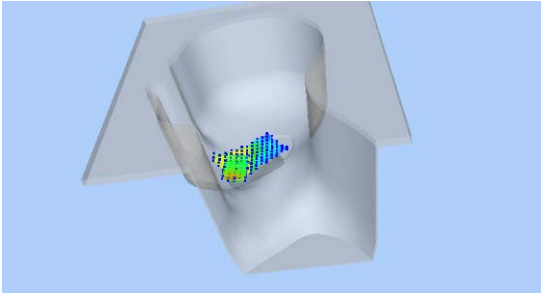
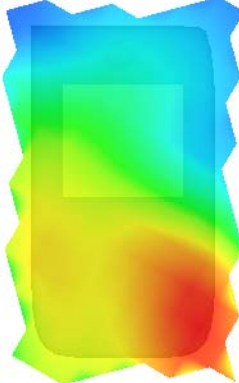
3D screen shot	Hot spot position
	

MEASUREMENT 25

Type: Phone measurement (Complete)

Date of measurement: 06/19/2015

Measurement duration: 12 minutes 3 seconds

A. Experimental conditions

Area Scan	sam_direct_droit2_surf8mm.txt
Phantom	Right head
Device Position	Tilt
Band	WCDMA1900-RMC
Channels	Middle
Signal	Duty Cycle 1:1

B. SAR Measurement Results

Frequency (MHz)	1880.000000
Relative permittivity (real part)	38.560124
Conductivity (S/m)	1.380369
Variation (%)	-0.930000

Maximum location: X=-33.00, Y=-16.00

SAR 10g (W/Kg)	0.059931
SAR 1g (W/Kg)	0.100111

Z Axis Scan

Z (mm)	0.00	4.00	9.00	14.00	19.00	24.00	29.00
SAR (W/Kg)	0.1491	0.1067	0.0698	0.0463	0.0315	0.1491	0.1067

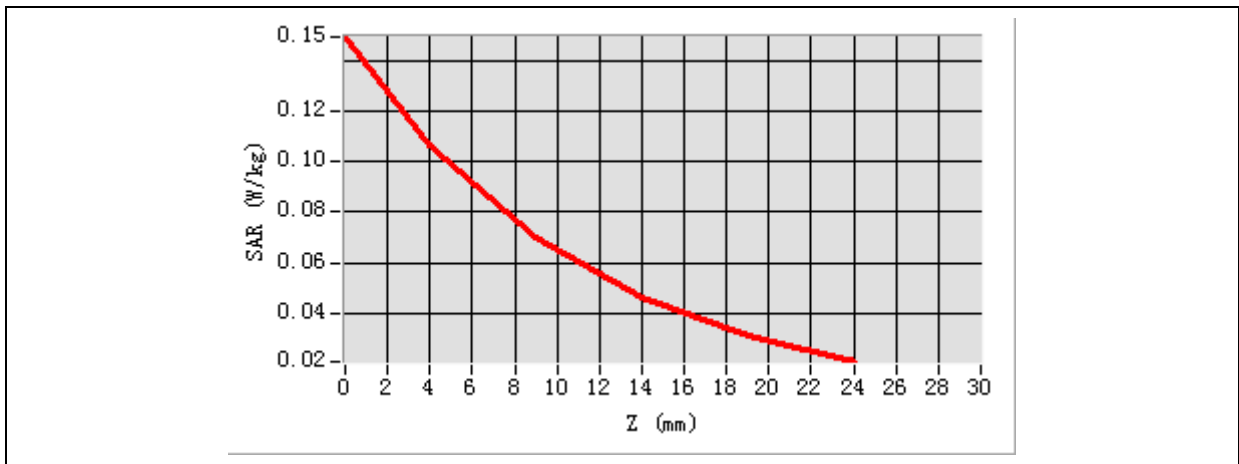

3D screen shot	Hot spot position

MEASUREMENT 26

Type: Phone measurement (Complete)

Date of measurement: 06/19/2015

Measurement duration: 12 minutes 3 seconds

A. Experimental conditions

Area Scan	sam_direct_droit2_surf8mm.txt
Phantom	Left head
Device Position	Cheek
Band	WCDMA1900-RMC
Channels	Middle
Signal	Duty Cycle 1:1

B. SAR Measurement Results

Frequency (MHz)	1880.000000
Relative permittivity (real part)	38.560124
Conductivity (S/m)	1.380369
Variation (%)	-0.920000

Maximum location: X=-33.00, Y=-16.00

SAR 10g (W/Kg)	0.281546
SAR 1g (W/Kg)	0.469757

Z Axis Scan

Z (mm)	0.00	4.00	9.00	14.00	19.00	24.00	29.00
SAR (W/Kg)	0.6994	0.5012	0.3279	0.2162	0.1452	0.6994	0.5012

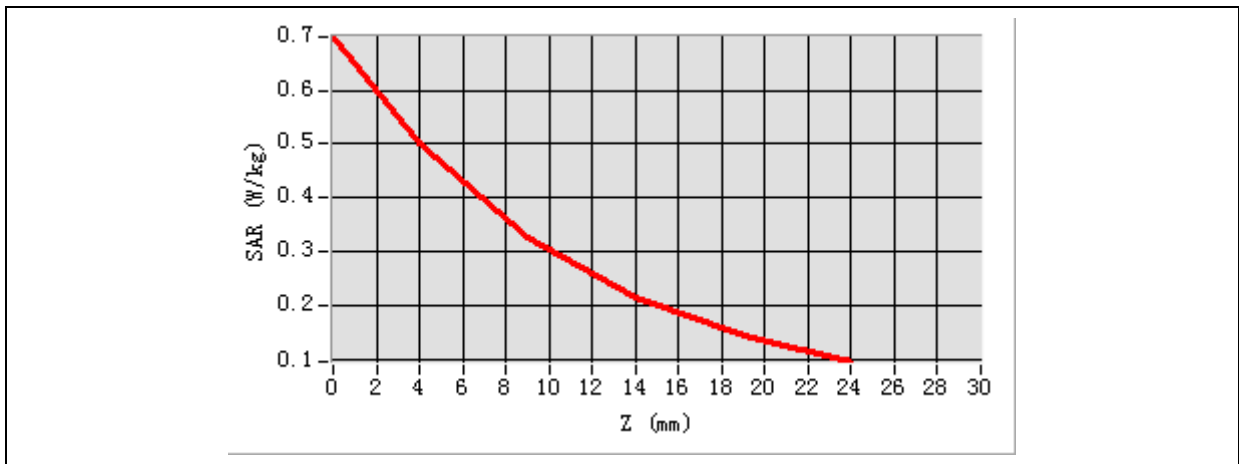

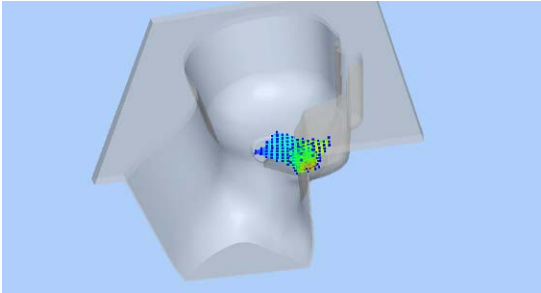
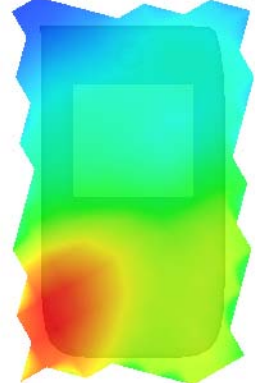
3D screen shot	Hot spot position
	

MEASUREMENT 27

Type: Phone measurement (Complete)

Date of measurement: 06/19/2015

Measurement duration: 12 minutes 3 seconds

A. Experimental conditions

Area Scan	sam_direct_droit2_surf8mm.txt
Phantom	Left head
Device Position	Tilt
Band	WCDMA1900-RMC
Channels	Middle
Signal	Duty Cycle 1:1

B. SAR Measurement Results

Frequency (MHz)	1880.000000
Relative permittivity (real part)	38.560124
Conductivity (S/m)	1.380369
Variation (%)	1.550000

Maximum location: X=-33.00, Y=-16.00

SAR 10g (W/Kg)	0.056868
SAR 1g (W/Kg)	0.099980

Z Axis Scan

Z (mm)	0.00	4.00	9.00	14.00	19.00	24.00	29.00
SAR (W/Kg)	0.1567	0.1067	0.0651	0.0401	0.0256	0.1567	0.1067

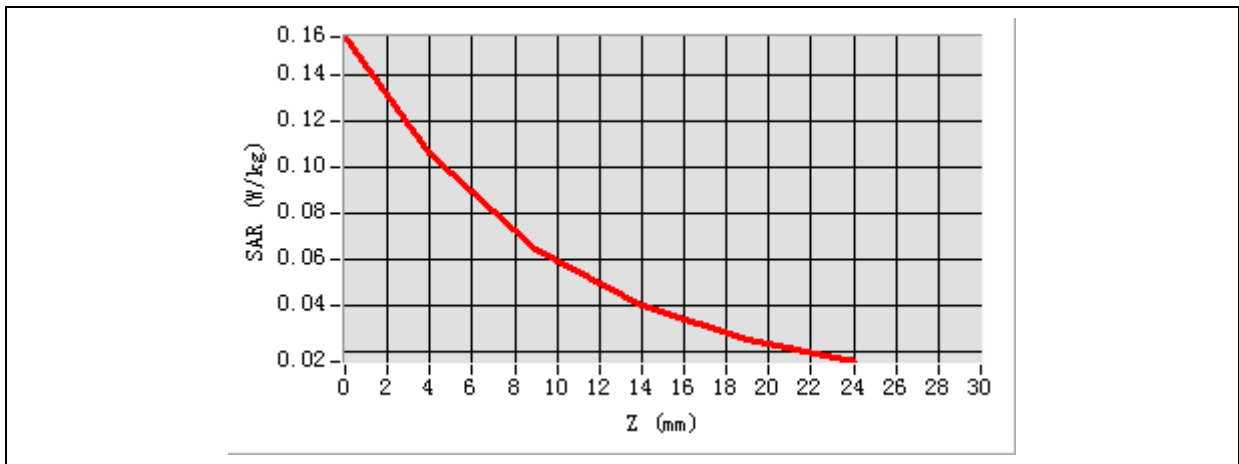

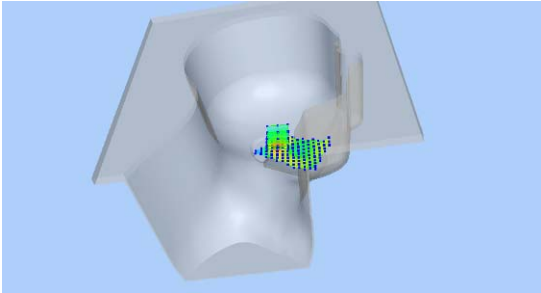
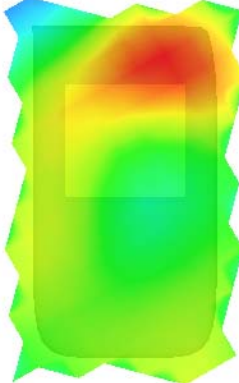
3D screen shot	Hot spot position
	

MEASUREMENT 28

Type: Phone measurement (Complete)

Date of measurement: 06/18/2015

Measurement duration: 12 minutes 3 seconds

A. Experimental conditions

Area Scan	sam_direct_droit2_surf8mm.txt
Phantom	Body plane
Device Position	Front
Band	WCDMA850-RMC
Channels	Middle
Signal	Duty Cycle 1:1

B. SAR Measurement Results

Frequency (MHz)	836.400000
Relative permittivity (real part)	54.851214
Conductivity (S/m)	0.951454
Variation (%)	-0.710000

Maximum location: X=-33.00, Y=-16.00

SAR 10g (W/Kg)	0.224152
SAR 1g (W/Kg)	0.297547

Z Axis Scan

Z (mm)	0.00	4.00	9.00	14.00	19.00	24.00	29.00
SAR (W/Kg)	0.3701	0.3078	0.2434	0.1920	0.1508	0.3701	0.3078

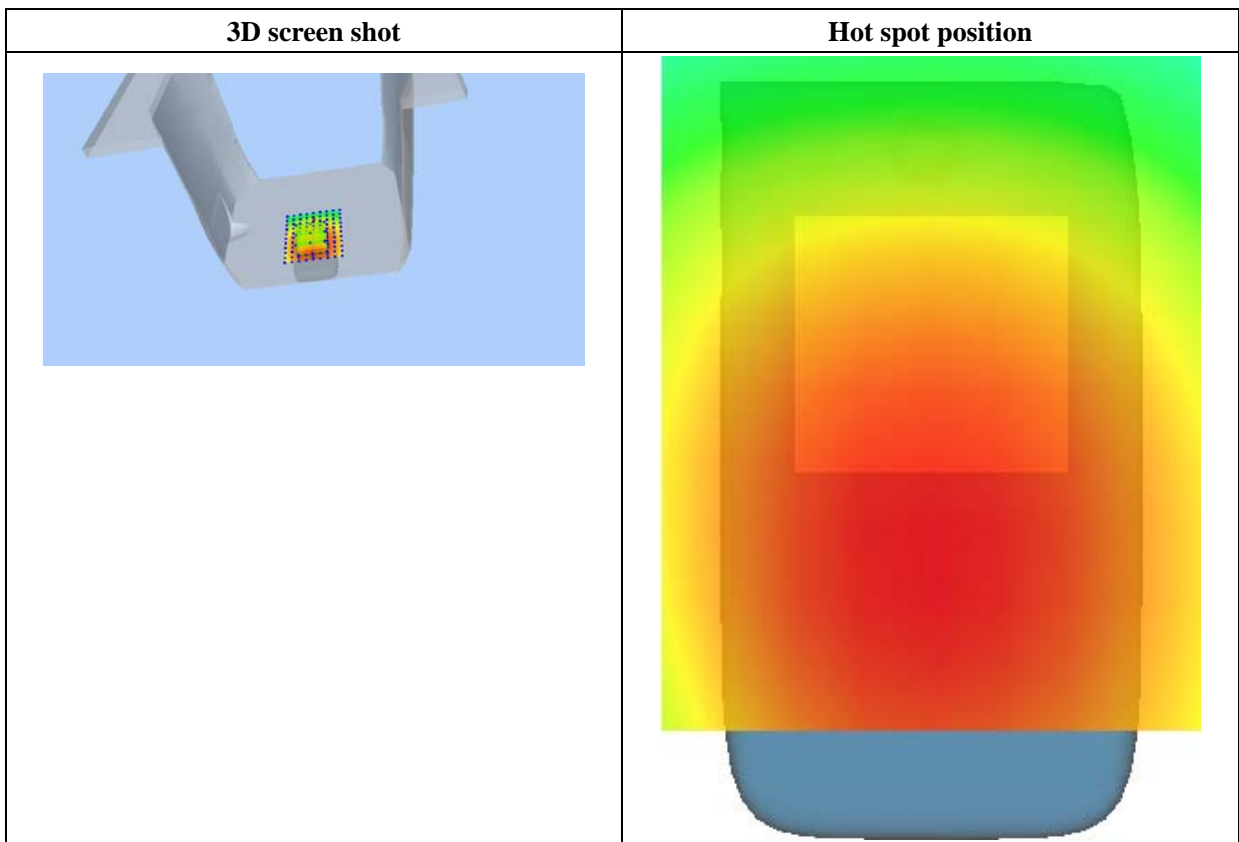
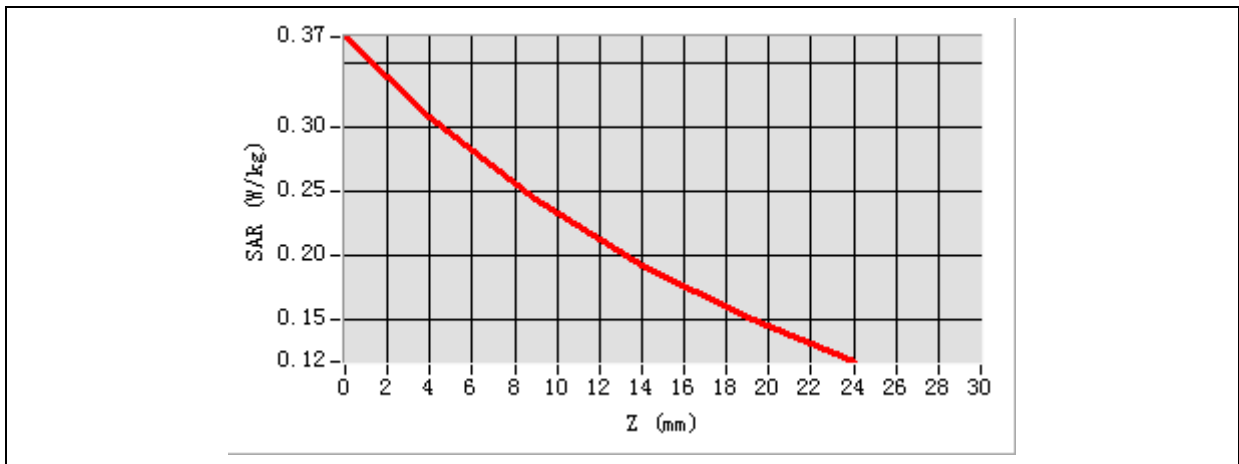

MEASUREMENT 29

Type: Phone measurement (Complete)

Date of measurement: 06/18/2015

Measurement duration: 12 minutes 3 seconds

A. Experimental conditions

Area Scan	sam_direct_droit2_surf8mm.txt
Phantom	Body plane
Device Position	Back
Band	WCDMA850-RMC
Channels	Middle
Signal	Duty Cycle 1:1

B. SAR Measurement Results

Frequency (MHz)	836.400000
Relative permittivity (real part)	54.851214
Conductivity (S/m)	0.951454
Variation (%)	-0.320000

Maximum location: X=-33.00, Y=-16.00

SAR 10g (W/Kg)	0.287470
SAR 1g (W/Kg)	0.381205

Z Axis Scan

Z (mm)	0.00	4.00	9.00	14.00	19.00	24.00	29.00
SAR (W/Kg)	0.4732	0.3944	0.3124	0.2463	0.1929	0.4732	0.3944

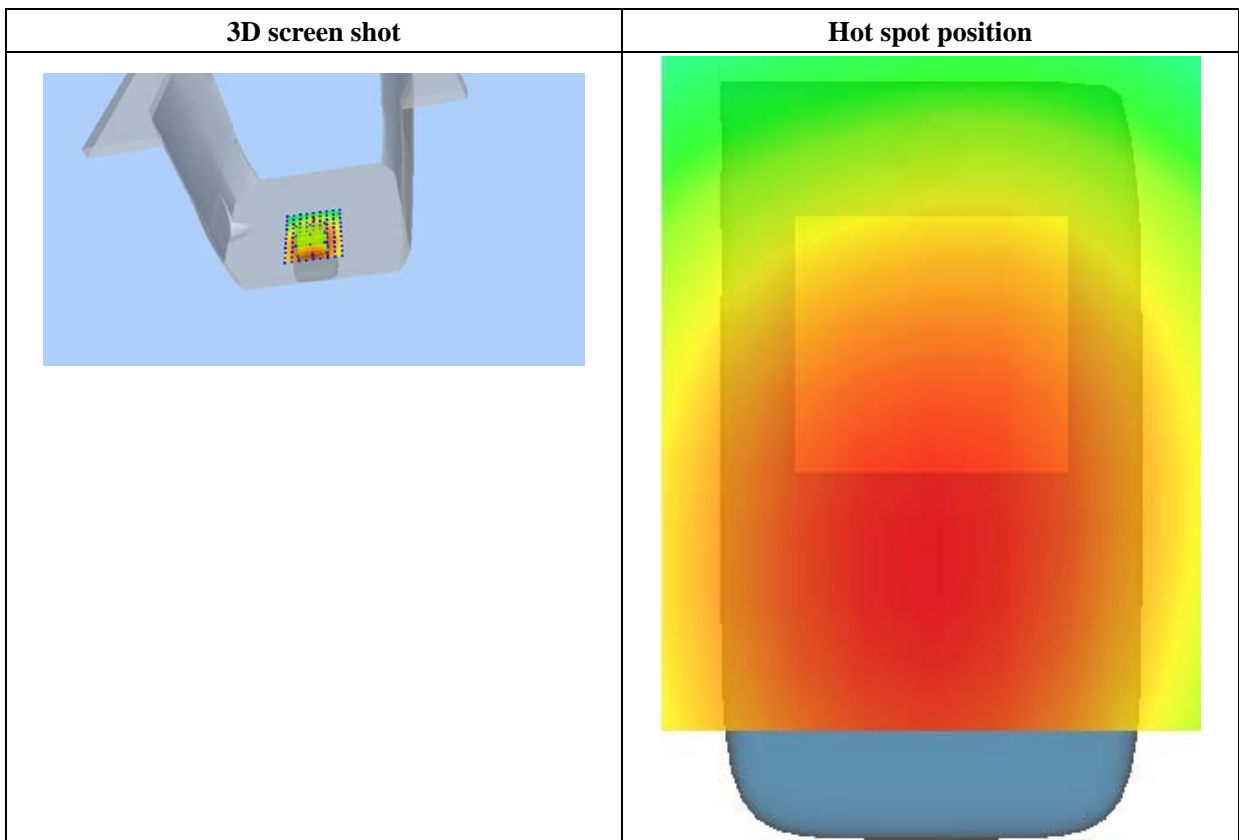
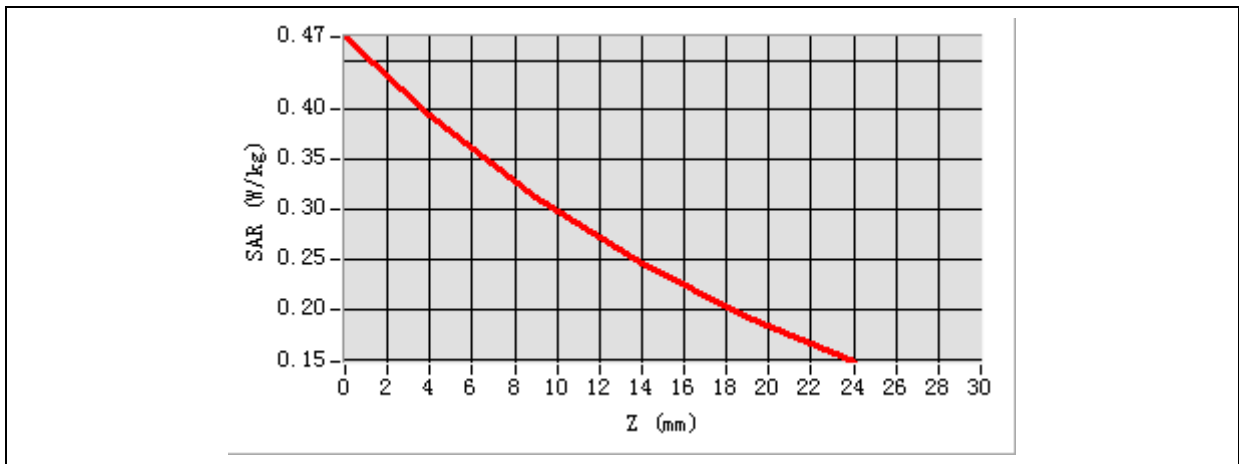

MEASUREMENT 30

Type: Phone measurement (Complete)

Date of measurement: 06/18/2015

Measurement duration: 12 minutes 3 seconds

A. Experimental conditions

Area Scan	sam_direct_droit2_surf8mm.txt
Phantom	Body plane
Device Position	Right
Band	WCDMA850-RMC
Channels	Middle
Signal	Duty Cycle 1:1

B. SAR Measurement Results

Frequency (MHz)	836.400000
Relative permittivity (real part)	54.851214
Conductivity (S/m)	0.951454
Variation (%)	-0.400000

Maximum location: X=-33.00, Y=-16.00

SAR 10g (W/Kg)	0.186403
SAR 1g (W/Kg)	0.266779

Z Axis Scan

Z (mm)	0.00	4.00	9.00	14.00	19.00	24.00	29.00
SAR (W/Kg)	0.3582	0.2785	0.2029	0.1488	0.1101	0.3582	0.2785

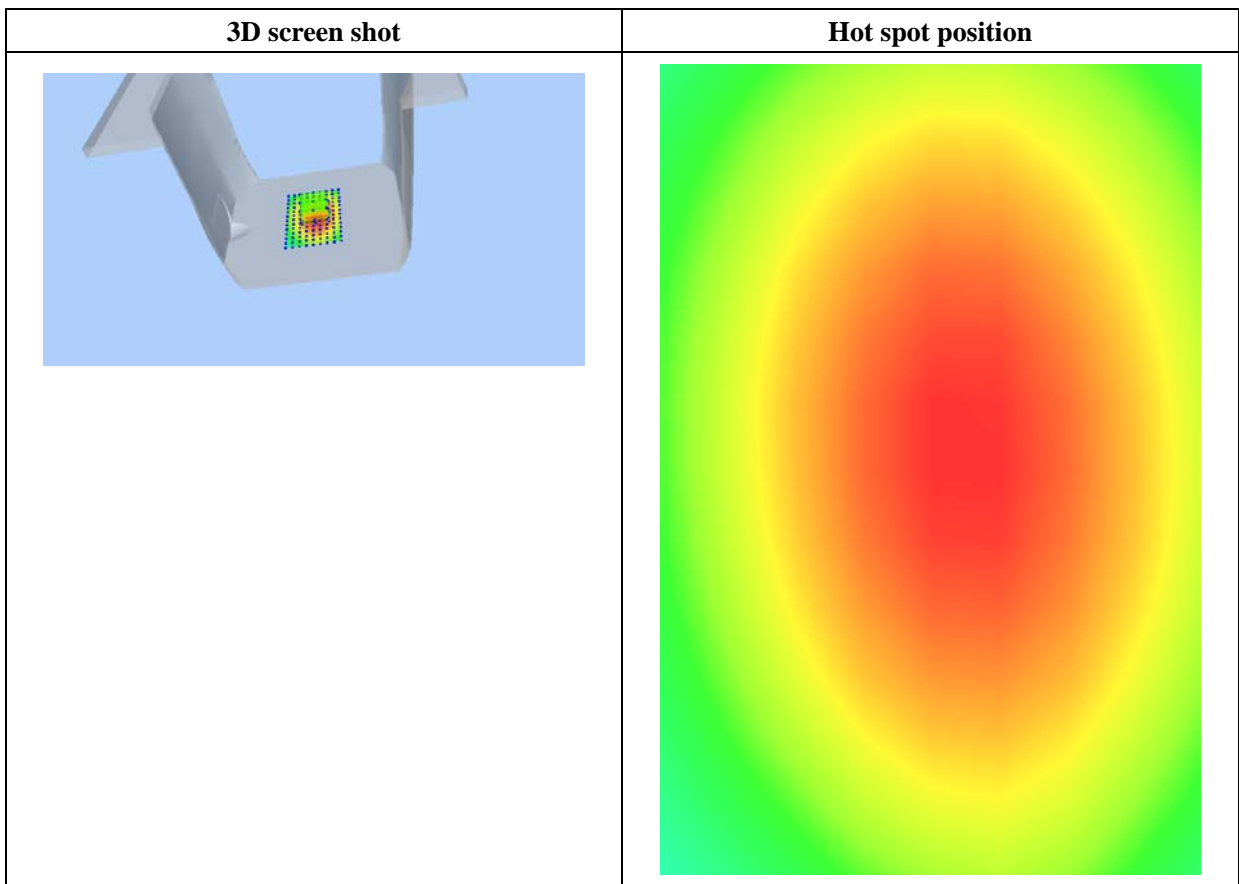
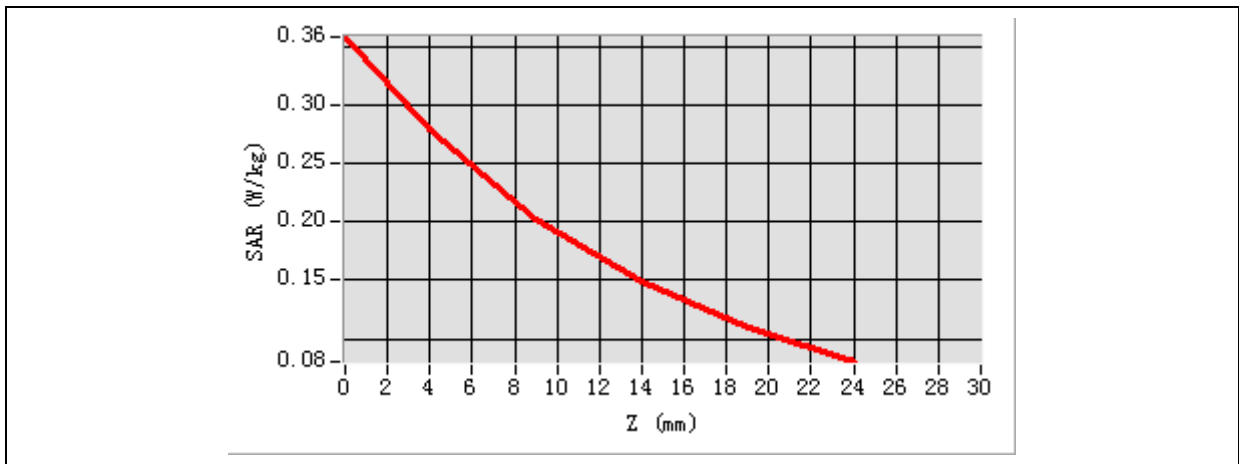

MEASUREMENT 31

Type: Phone measurement (Complete)

Date of measurement: 06/18/2015

Measurement duration: 12 minutes 3 seconds

A. Experimental conditions

Area Scan	sam_direct_droit2_surf8mm.txt
Phantom	Body plane
Device Position	Bottom
Band	WCDMA850-RMC
Channels	Middle
Signal	Duty Cycle 1:1

B. SAR Measurement Results

Frequency (MHz)	836.400000
Relative permittivity (real part)	54.851214
Conductivity (S/m)	0.951454
Variation (%)	1.350000

Maximum location: X=-33.00, Y=-16.00

SAR 10g (W/Kg)	0.079113
SAR 1g (W/Kg)	0.124723

Z Axis Scan

Z (mm)	0.00	4.00	9.00	14.00	19.00	24.00	29.00
SAR (W/Kg)	0.1812	0.1319	0.0884	0.0601	0.0418	0.1812	0.1319

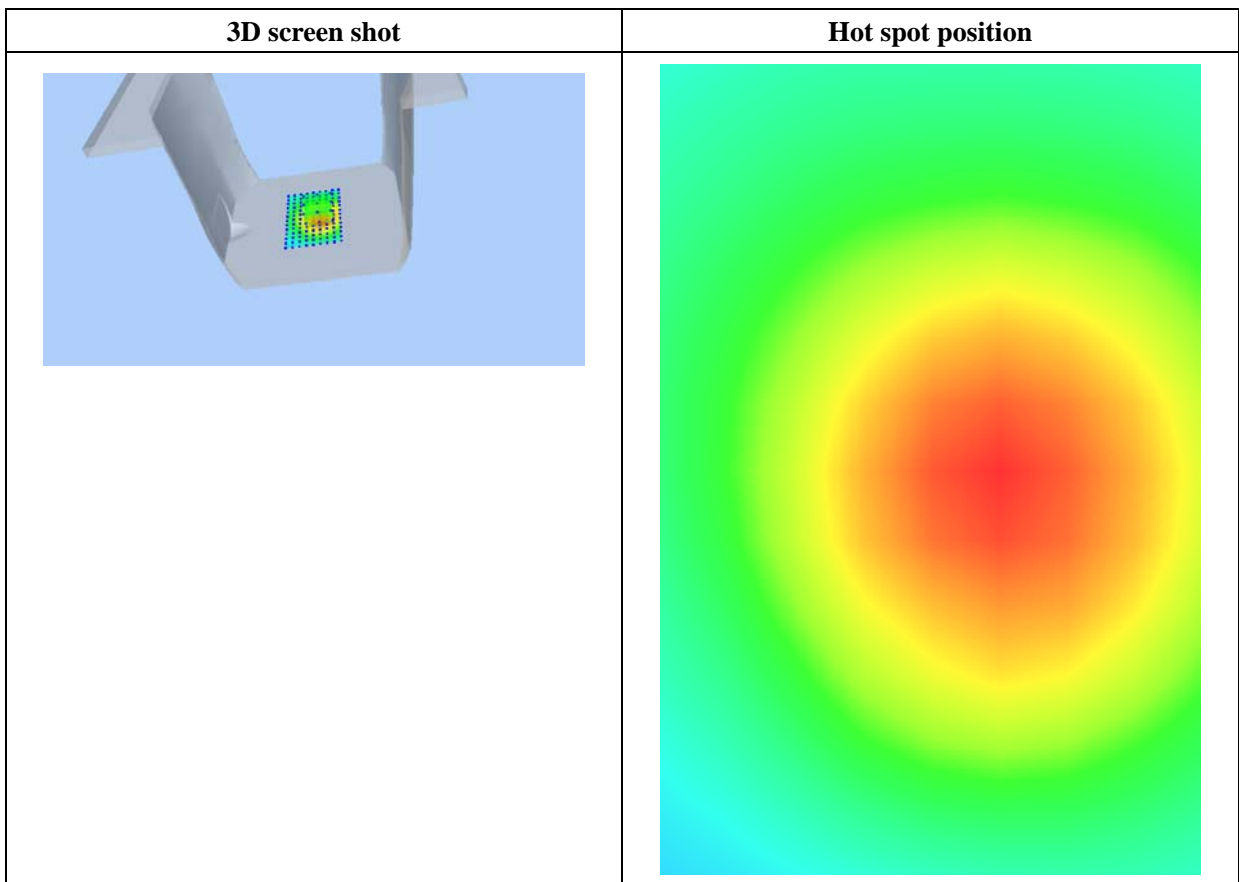
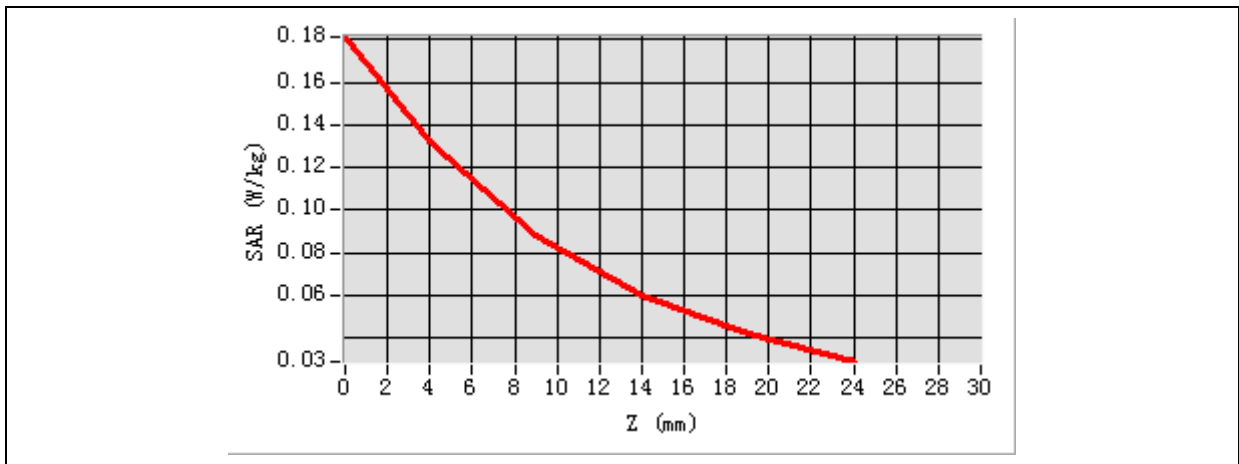

MEASUREMENT 32

Type: Phone measurement (Complete)

Date of measurement: 06/19/2015

Measurement duration: 12 minutes 3 seconds

A. Experimental conditions

Area Scan	sam_direct_droit2_surf8mm.txt
Phantom	Body plane
Device Position	Front
Band	WCDMA1900-RMC
Channels	Middle
Signal	Duty Cycle 1:1

B. SAR Measurement Results

Frequency (MHz)	1880.000000
Relative permittivity (real part)	52.420415
Conductivity (S/m)	1.501966
Variation (%)	-1.180000

Maximum location: X=-33.00, Y=-16.00

SAR 10g (W/Kg)	0.014462
SAR 1g (W/Kg)	0.027302

Z Axis Scan

Z (mm)	0.00	4.00	9.00	14.00	19.00	24.00	29.00
SAR (W/Kg)	0.0460	0.0291	0.0158	0.0085	0.0047	0.0460	0.0291

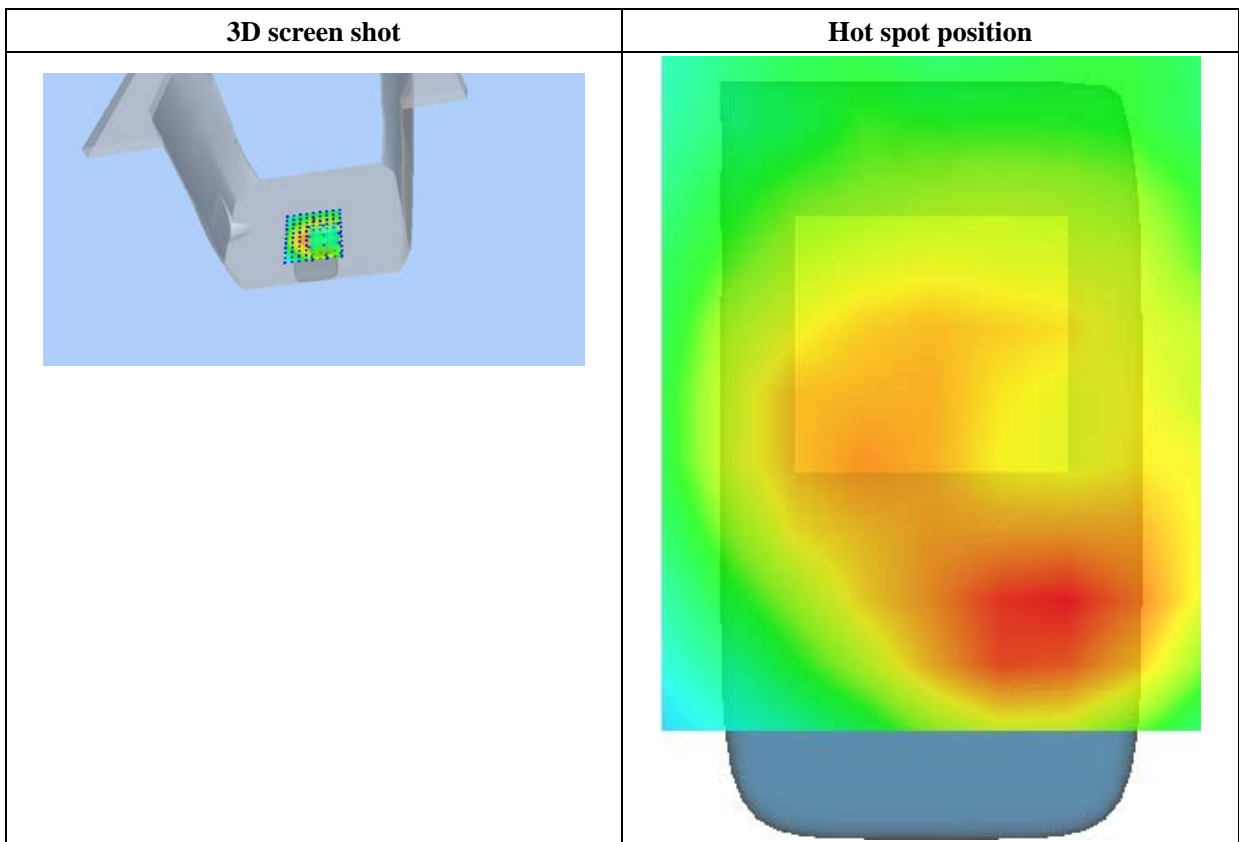
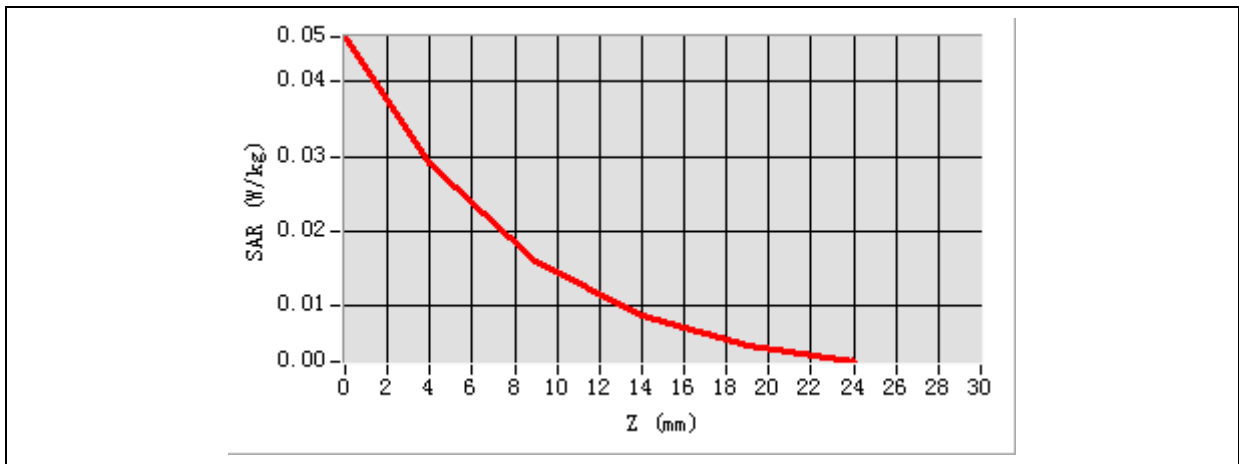

MEASUREMENT 33

Type: Phone measurement (Complete)

Date of measurement: 06/19/2015

Measurement duration: 12 minutes 3 seconds

A. Experimental conditions

Area Scan	sam_direct_droit2_surf8mm.txt
Phantom	Body plane
Device Position	Back
Band	WCDMA1900-RMC
Channels	Middle
Signal	Duty Cycle 1:1

B. SAR Measurement Results

Frequency (MHz)	1880.000000
Relative permittivity (real part)	52.420415
Conductivity (S/m)	1.501966
Variation (%)	-3.360000

Maximum location: X=-33.00, Y=-16.00

SAR 10g (W/Kg)	0.012970
SAR 1g (W/Kg)	0.024295

Z Axis Scan

Z (mm)	0.00	4.00	9.00	14.00	19.00	24.00	29.00
SAR (W/Kg)	0.0396	0.0258	0.0145	0.0079	0.0042	0.0396	0.0258

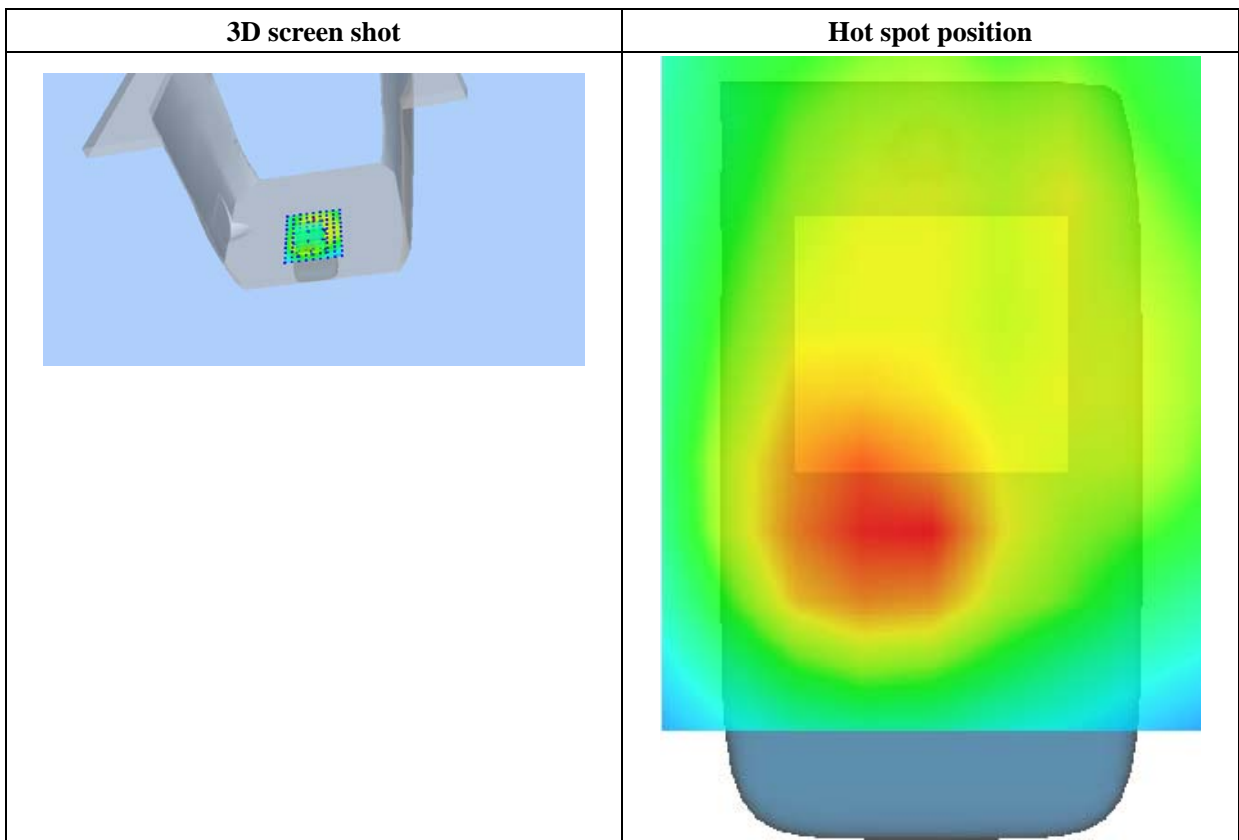
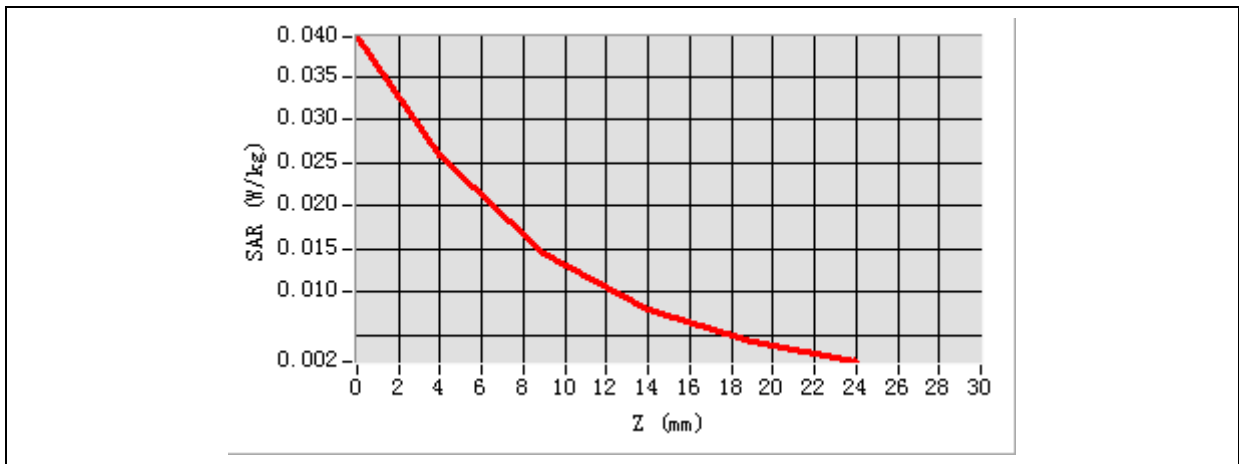

MEASUREMENT 34

Type: Phone measurement (Complete)

Date of measurement: 06/19/2015

Measurement duration: 12 minutes 3 seconds

A. Experimental conditions

Area Scan	sam_direct_droit2_surf8mm.txt
Phantom	Body plane
Device Position	Right
Band	WCDMA1900-RMC
Channels	Middle
Signal	Duty Cycle 1:1

B. SAR Measurement Results

Frequency (MHz)	1880.000000
Relative permittivity (real part)	52.420415
Conductivity (S/m)	1.501966
Variation (%)	-0.630000

Maximum location: X=-33.00, Y=-16.00

SAR 10g (W/Kg)	0.125659
SAR 1g (W/Kg)	0.200281

Z Axis Scan

Z (mm)	0.00	4.00	9.00	14.00	19.00	24.00	29.00
SAR (W/Kg)	0.2267	0.1881	0.1415	0.0983	0.0608	0.2267	0.1881

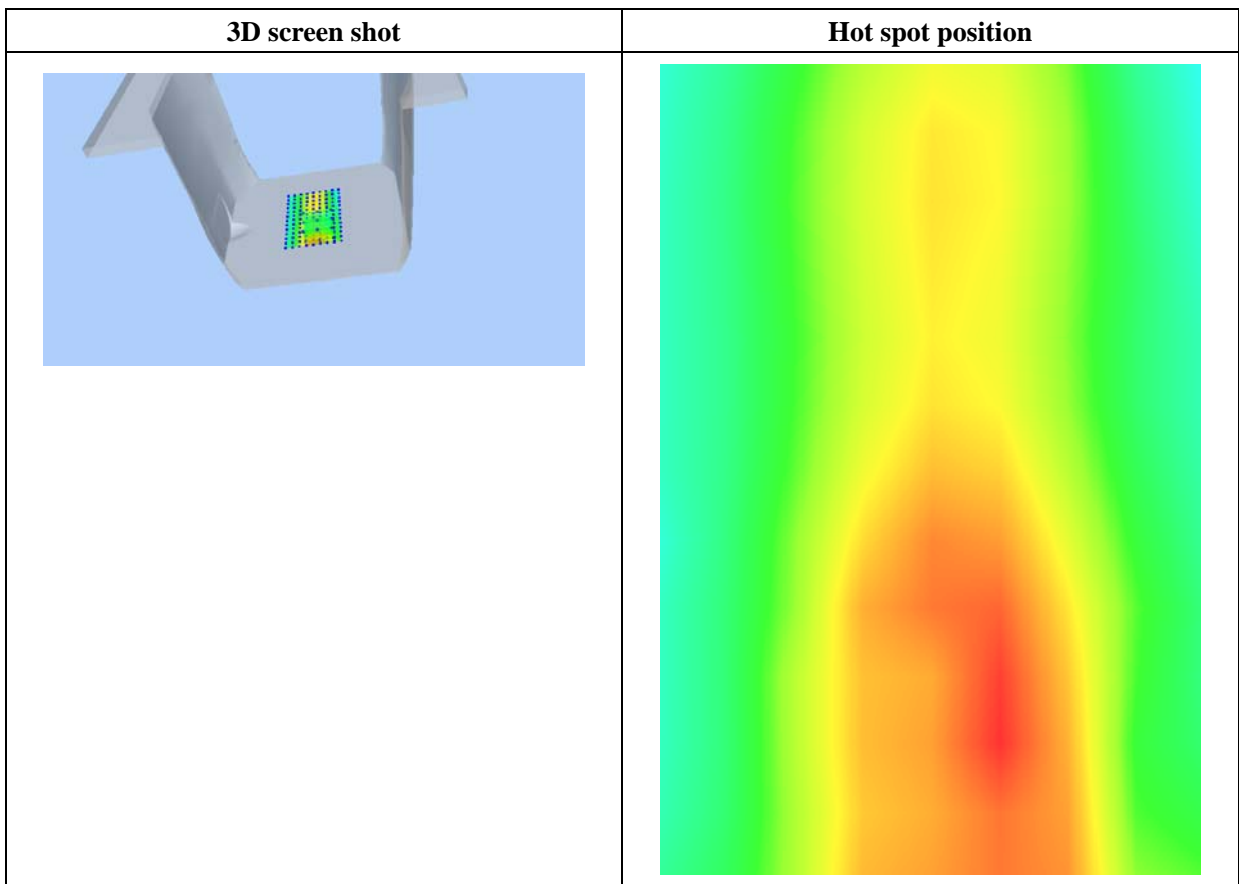
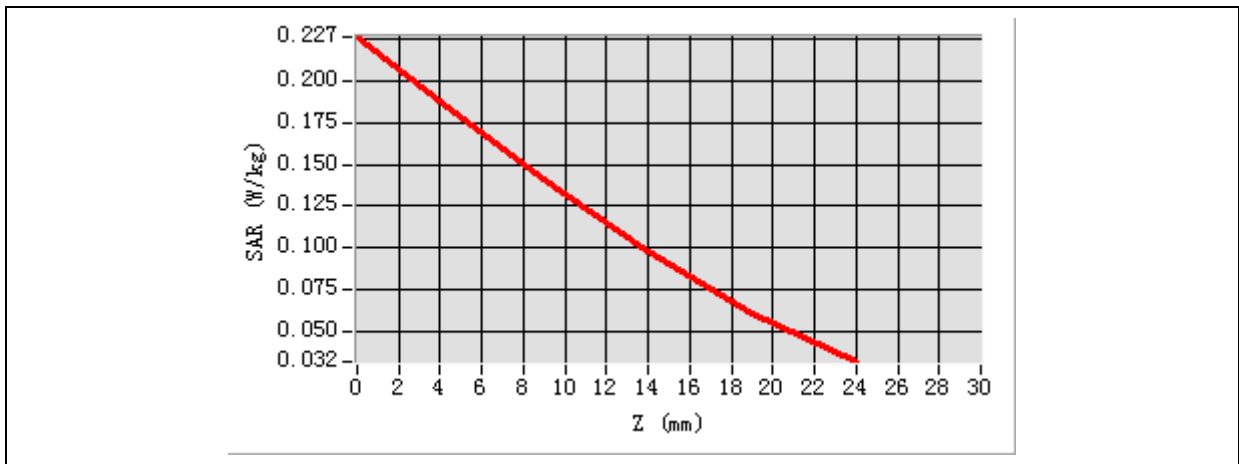

MEASUREMENT 35

Type: Phone measurement (Complete)

Date of measurement: 06/19/2015

Measurement duration: 12 minutes 3 seconds

A. Experimental conditions

Area Scan	sam_direct_droit2_surf8mm.txt
Phantom	Body plane
Device Position	Bottom
Band	WCDMA1900-RMC
Channels	Middle
Signal	Duty Cycle 1:1

B. SAR Measurement Results

Frequency (MHz)	1880.000000
Relative permittivity (real part)	52.420415
Conductivity (S/m)	1.501966
Variation (%)	2.500000

Maximum location: X=-33.00, Y=-16.00

SAR 10g (W/Kg)	0.006029
SAR 1g (W/Kg)	0.011823

Z Axis Scan

Z (mm)	0.00	4.00	9.00	14.00	19.00	24.00	29.00
SAR (W/Kg)	0.0201	0.0127	0.0069	0.0037	0.0019	0.0201	0.0127

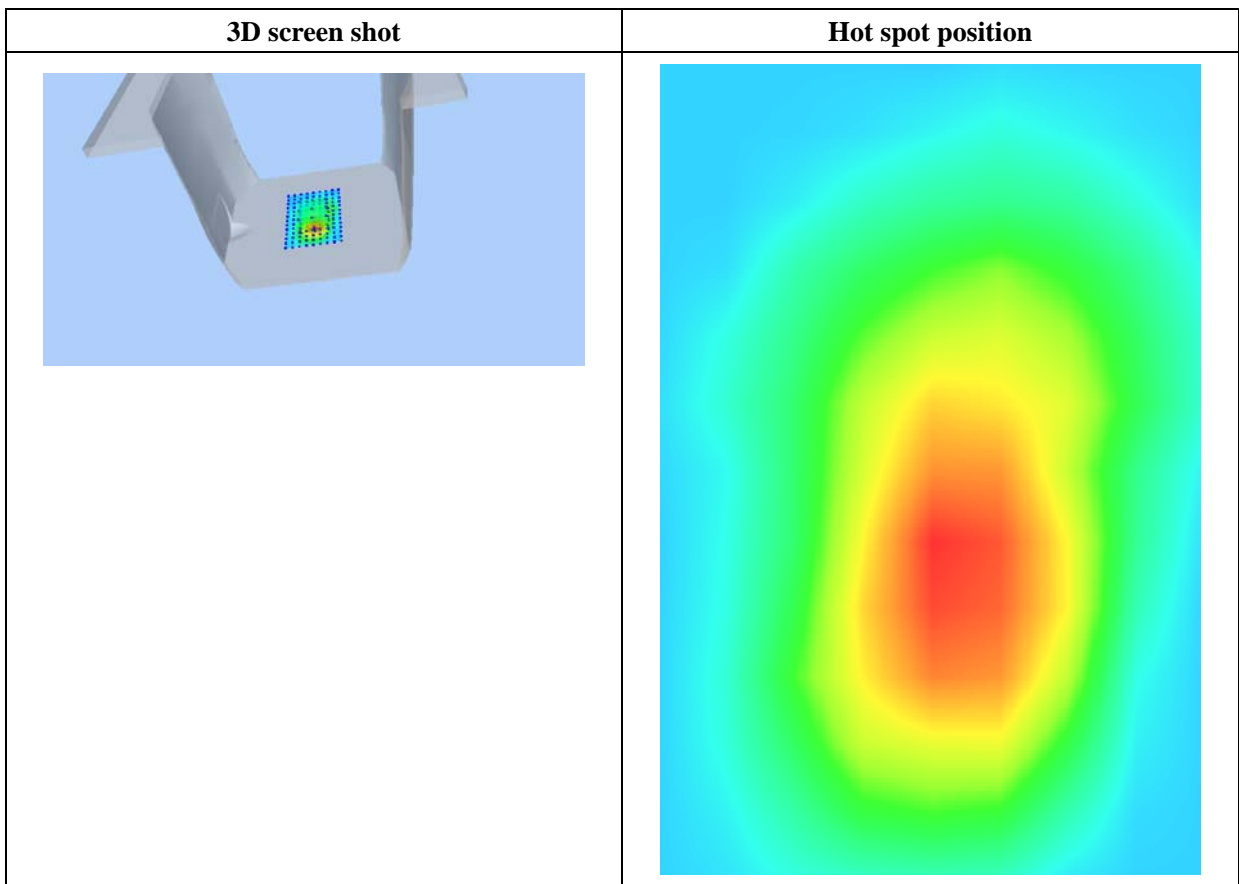
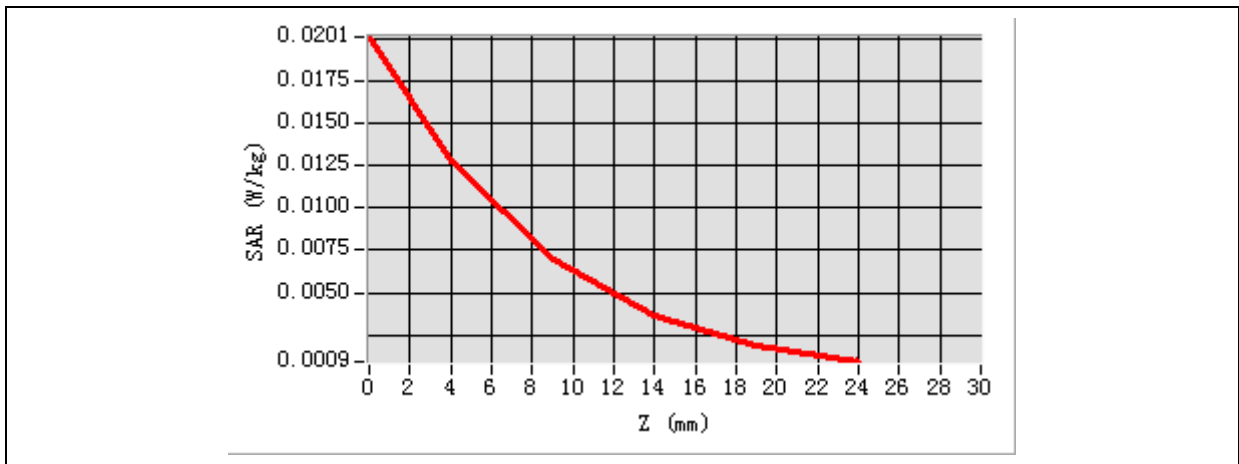

Annex C. EUT Photos



EUT View_Front



EUT View_Back

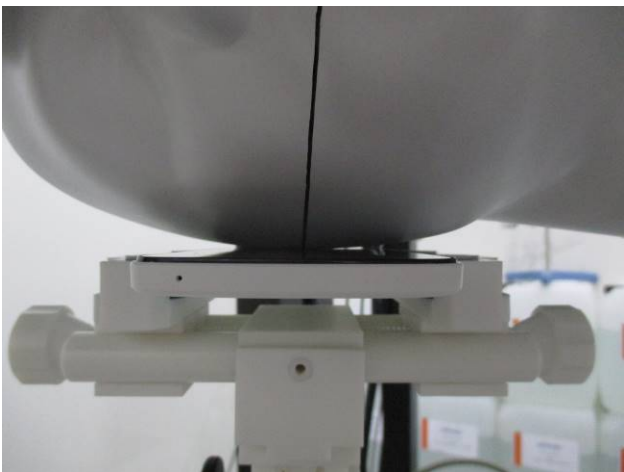
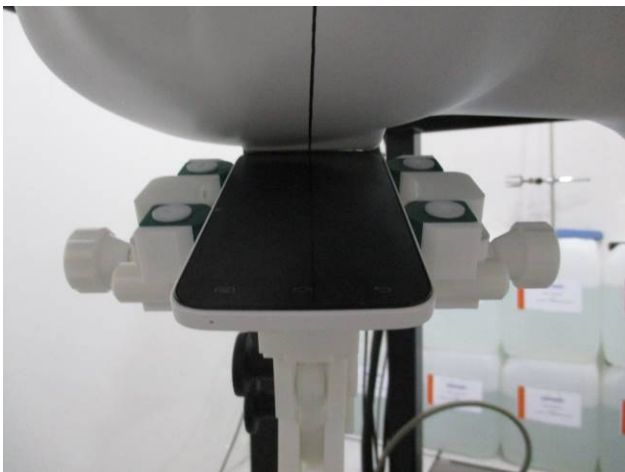
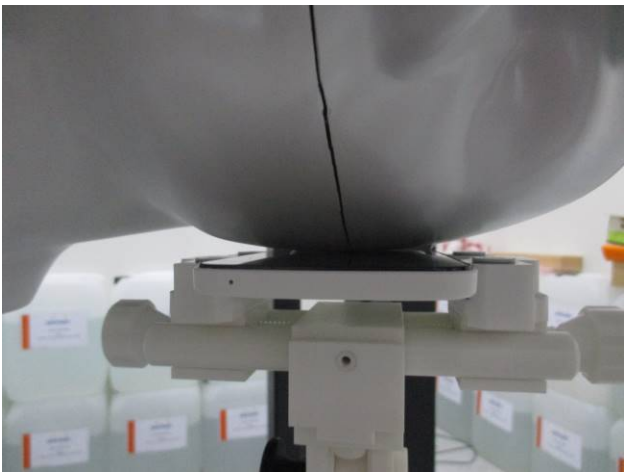

Annex D. Test Setup Photos

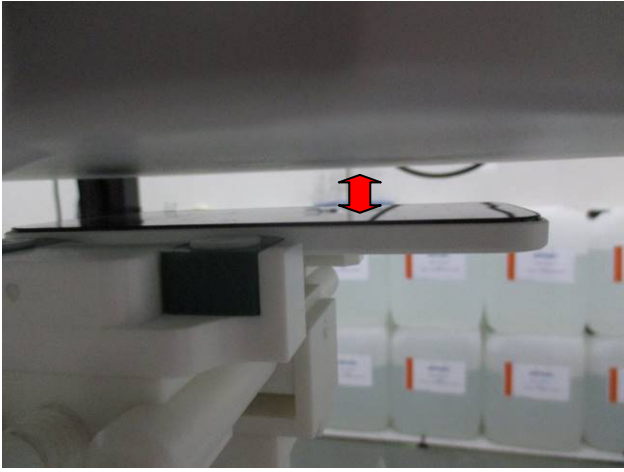
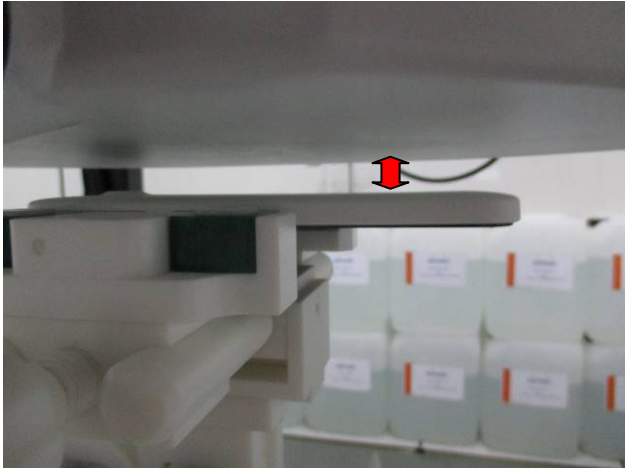
	
Right Head Check	Right Head Tilt
	
Left Head Check	Left Head Tilt
	
Body-Worn(LCD UP)	Body-Worn(LCD Down)

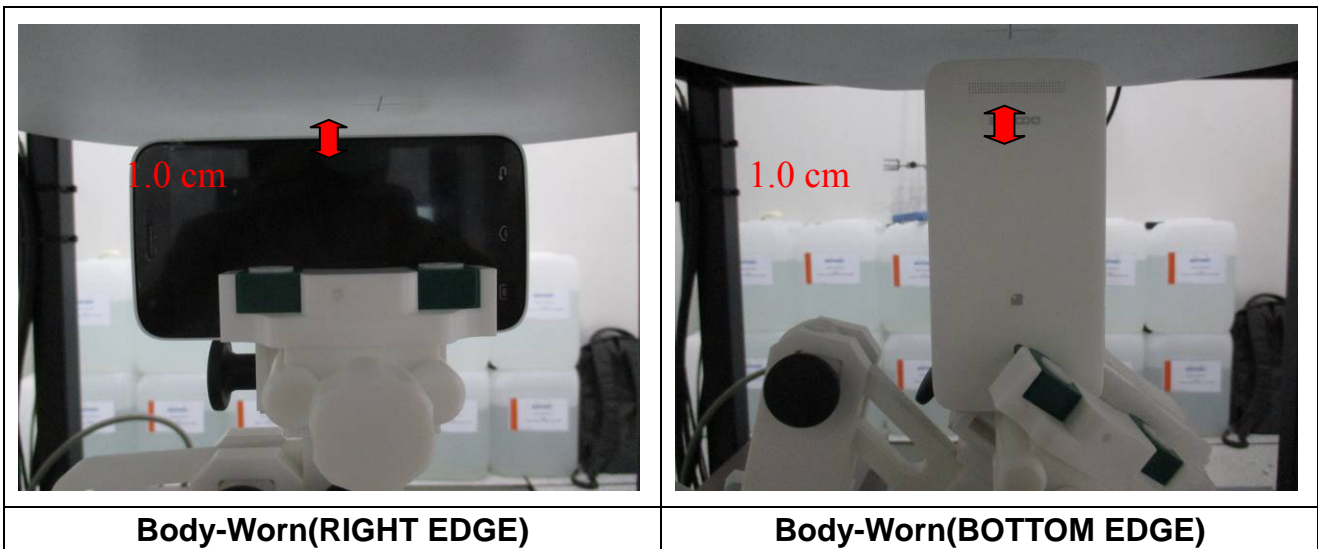

Annex E. Calibration Certificate

Please refer to the exhibit for the calibration certificate

******* END OF REPORT *******