

SAR TEST REPORT

For

Shenzhen KVD Communication Equipment Limited

GSM/WCDMA Smartphone

Model No.: X30

Additional Model No.: /

Prepared for : Shenzhen KVD Communication Equipment Limited
Address : Lenovo R&D Center 2F-B, South First Road, High-tech
Park, Nanshan District, Shenzhen, Guangdong, China

Prepared by : Shenzhen LCS Compliance Testing Laboratory Ltd.
Address : 1/F., Xingyuan Industrial Park, Tongda Road, Bao'an
Avenue, Bao'an District, Shenzhen, Guangdong, China

Tel : (86)755-82591330
Fax : (86)755-82591332
Web : www.LCS-cert.com
Mail : webmaster@LCS-cert.com

Date of receipt of test sample : Jul 03, 2017
Number of tested samples : 1
Serial number : Prototype
Date of Test : Jul 03, 2017~Jul 12, 2017
Date of Report : Jul 12, 2017

SAR TEST REPORT

Report Reference No. : LCS170801027AE

Date Of Issue : Jul 12, 2017

Testing Laboratory Name..... : Shenzhen LCS Compliance Testing Laboratory Ltd.

Address : 1/F., Xingyuan Industrial Park, Tongda Road, Bao'an Avenue, Bao'an District, Shenzhen, Guangdong, China

Testing Location/ Procedure..... : Full application of Harmonised standards ■
 Partial application of Harmonised standards □
 Other standard testing method □

Applicant's Name..... : Shenzhen KVD Communication Equipment Limited

Address : Lenovo R&D Center 2F-B, South First Road, High-tech Park, Nanshan District, Shenzhen, Guangdong, China

Test Specification:

Standard : IEEE 1528:2013/KDB865664
 47CFR §2.1093

Test Report Form No. : LCSEMC-1.0

TRF Originator : Shenzhen LCS Compliance Testing Laboratory Ltd.

Master TRF : Dated 2014-09

Shenzhen LCS Compliance Testing Laboratory Ltd. All rights reserved.

This publication may be reproduced in whole or in part for non-commercial purposes as long as the Shenzhen LCS Compliance Testing Laboratory Ltd. is acknowledged as copyright owner and source of the material. Shenzhen LCS Compliance Testing Laboratory Ltd. takes no responsibility for and will not assume liability for damages resulting from the reader's interpretation of the reproduced material due to its placement and context.

Test Item Description. : GSM/WCDMA Smartphone

Trade Mark : DOOGEE

Model/Type Reference : X30

Operation Frequency : GSM 850/PCS1900,WCDMA Band II/V,WLAN2.4G,Bluetooth4.1

Modulation Type : GSM(GMSK,8PSK),WCDMA/HSDPA/HSUPA(QPSK),WIFI(DS SS,OFDM),Bluetooth(GFSK,8DPSK,PII/4DQPSK)

Ratings : DC 3.80V, 3360mAh
 Charging parameter: Input: 100~240V AC, 50/60Hz, 0.2A;
 Output: DC 5V, 1A

Result : Positive

Compiled by:

Irene . Liu

Irene Liu/ File administrators

Supervised by:

Dick Su

Dick Su/ Technique principal

Approved by:

Gavin Liang

Gavin Liang/ Manager

SAR -- TEST REPORT

| | |
|--|--------------------------------------|
| Test Report No. : LCS170801027AE | <u>Jul 12, 2017</u> Date of issue |
|--|--------------------------------------|

| | |
|--------------------------|--|
| Type / Model..... | : X30 |
| EUT..... | : GSM/WCDMA Smartphone |
| Applicant..... | : Shenzhen KVD Communication Equipment Limited |
| Address..... | : Lenovo R&D Center 2F-B, South First Road, High-tech Park, Nanshan District, Shenzhen, Guangdong, China |
| Telephone..... | : / |
| Fax..... | : / |
| Manufacturer..... | : Shenzhen KVD Communication Equipment Limited |
| Address..... | : A, 3rd floor, Building A2, Silicon valley Digital Industrial Park, 22nd of Dafu industrial area, Aobei Community, Guanlan town, Longhua District, shenzhen 518000, China |
| Telephone..... | : / |
| Fax..... | : / |
| Factory..... | : Shenzhen KVD Communication Equipment Limited |
| Address..... | : A, 3rd floor, Building A2, Silicon valley Digital Industrial Park, 22nd of Dafu industrial area, Aobei Community, Guanlan town, Longhua District, shenzhen 518000, China |
| Telephone..... | : / |
| Fax..... | : / |
| Test Result | Positive |

The test report merely corresponds to the test sample.
 It is not permitted to copy extracts of these test result without the written permission of the test laboratory.

Revision History

| Revision | Issue Date | Revisions | Revised By |
|----------|--------------|---------------|-------------|
| 000 | Jul 12, 2017 | Initial Issue | Gavin Liang |
| | | | |

TABLE OF CONTENTS

| | |
|--|------------|
| 1. TEST STANDARDS AND TEST DESCRIPTION..... | 6 |
| 1.1. TEST STANDARDS | 6 |
| 1.2. TEST DESCRIPTION | 6 |
| 1.3. GENERAL REMARKS | 6 |
| 1.4. PRODUCT DESCRIPTION | 6 |
| 1.5. STATEMENT OF COMPLIANCE | 7 |
| 2. TEST ENVIRONMENT | 9 |
| 2.1. TEST FACILITY | 9 |
| 2.2. ENVIRONMENTAL CONDITIONS | 9 |
| 2.3. SAR LIMITS | 9 |
| 2.4. EQUIPMENTS USED DURING THE TEST | 10 |
| 3. SAR MEASUREMENTS SYSTEM CONFIGURATION | 11 |
| 3.1. SARMEASUREMENT SET-UP..... | 11 |
| 3.2. OPENSAR E-FIELD PROBE SYSTEM..... | 12 |
| 3.3. PHANTOMS..... | 13 |
| 3.4. DEVICE HOLDER | 13 |
| 3.5. SCANNING PROCEDURE | 14 |
| 3.6. DATA STORAGE AND EVALUATION..... | 16 |
| 3.7. POSITION OF THE WIRELESS DEVICE IN RELATION TO THE PHANTOM..... | 17 |
| 3.8. TISSUE DIELECTRIC PARAMETERS FOR HEAD AND BODY PHANTOMS | 19 |
| 3.9. TISSUE EQUIVALENT LIQUID PROPERTIES | 19 |
| 3.10. SYSTEM CHECK | 20 |
| 3.11. SAR MEASUREMENT PROCEDURE | 22 |
| 3.12. POWER REDUCTION | 28 |
| 3.13. POWER DRIFT | 28 |
| 4. TEST CONDITIONS AND RESULTS..... | 29 |
| 4.1. CONDUCTED POWER RESULTS | 29 |
| 4.2. MANUFACTURING TOLERANCE | 33 |
| 4.3. TRANSMIT ANTENNAS AND SAR MEASUREMENT POSITION..... | 37 |
| 4.4. STANDALONE SAR TEST EXCLUSION CONSIDERATIONS | 38 |
| 4.5. SAR MEASUREMENT RESULTS | 39 |
| 4.6. SIMULTANEOUS TX SAR CONSIDERATIONS..... | 42 |
| 4.7. SAR MEASUREMENT VARIABILITY | 46 |
| 4.8. GENERAL DESCRIPTION OF TEST PROCEDURES | 47 |
| 4.9. MEASUREMENT UNCERTAINTY (300MHZ-3GHZ)..... | 48 |
| 4.10. SYSTEM CHECK RESULTS | 49 |
| 4.11. SAR TEST GRAPH RESULTS | 55 |
| 5. CALIBRATION CERTIFICATES..... | 65 |
| 5.1. PROBE-EPGO265 CALIBRATION CERTIFICATE..... | 65 |
| 5.2. SID835DIPOLE CALIBRATION CERITICATE..... | 75 |
| 5.3. SID1900 DIPOLE CALIBRATION CERITICATE..... | 86 |
| 5.4. SID2450 DIPOLE CALIBRATION CERITICATE..... | 97 |
| 6. EUT TEST PHOTOGRAPHS | 108 |
| 6.1. PHOTOGRAPH OF LIQUID DEPTH..... | 108 |
| 6.2. PHOTOGRAPH OF THE TEST | 111 |
| 7. EUT PHOTOGRAPHS | 116 |

1. TEST STANDARDS AND TEST DESCRIPTION

1.1. Test Standards

IEEE Std C95.1, 2005: IEEE Standard for Safety Levels with Respect to Human Exposure to Radio Frequency Electromagnetic Fields, 3 KHz to 300 GHz.It specifies the maximum exposure limit of 1.6 W/kg as averaged over any 1 gram of tissue for portable devices being used within 20 cm of the user in the uncontrolled environment.
 IEEE Std 1528™-2013: IEEE Recommended Practice for Determining the Peak Spatial-Average Specific Absorption Rate (SAR) in the Human Head from Wireless Communications Devices: Measurement Techniques.
 FCC Part 2.1093 Radiofrequency Radiation Exposure Evaluation:Portable Devices
 KDB447498 D01 General RF Exposure Guidance v06 : Mobile and Portable Device RF Exposure Procedures and Equipment Authorization Policies
 KDB648474 D04, Handset SAR v01r03: SAR Evaluation Considerations for Wireless Handsets
 KDB865664 D01 SAR Measurement 100 MHz to 6 GHz v01r04 :SAR Measurement Requirements for 100 MHz to 6 GHz
 KDB865664 D02 RF Exposure Reporting v01r02: RF Exposure Compliance Reporting and Documentation Considerations
 KDB248227 D01 802.11 Wi-Fi SAR v02r02: SAR GUIDANCE FOR IEEE 802.11 (Wi-Fi) TRANSMITTERS
 KDB941225 D01 3G SAR Procedures v03r01: 3G SAR MEAUREMENT PROCEDURES
 KDB 941225 D06 Hotspot Mode v02r01: SAR EVALUATION PROCEDURES FOR PORTABLE DEVICES WITH WIRELESS ROUTER CAPABILITIES
 KDB 941225 D05 SAR for LTE Devices v02r05:SAR Evaluation Considerations for LTE Devices

1.2. Test Description

The EUT battery must be fully charged and checked periodically during the test to ascertain uniform power . And Test device is identical prototype.

1.3. General Remarks

| | | |
|--------------------------------|---|--------------|
| Date of receipt of test sample | : | Jul 03, 2017 |
| Testing commenced on | : | Jul 03, 2017 |
| Testing concluded on | : | Jul 12, 2017 |

1.4. Product Description

TheShenzhen KVD Communication Equipment Limited.'s Model:X30or the "EUT" as referred to in this report; more general information as follows,for more details, refer to the user's manual of the EUT.

| | |
|--|--|
| General Description | |
| Product Name: | GSM/WCDMA Smartphone |
| Model/Type reference: | X30 |
| Listed Model(s): | / |
| Modulation Type: | GMSK for GSM/GPRS, 8-PSK for EDGE,QPSK for UMTS |
| Device category: | Portable Device |
| Exposure category: | General population/uncontrolled environment |
| EUT Type: | Production Unit |
| Hardware Version | HCT-W178MB-A2 |
| Software Version: | DOOGEE-X30-Android7.0-20170622 |
| Power supply: | DC 3.80V, 3360mAh Charging parameter: Input: 100~240V AC, 50/60Hz, 0.2A; Output: DC 5V, 1A |
| Hotspot: | Supported, power not reduced when Hotspot open |
| <i>The EUT is GSM,WCDMA, mobile phone. the mobile phone is intended for speech and Multimedia Message Service (MMS) transmission. It is equipped with GPRS/EDGE class 12 for GSM850, PCS1900, WCDMA Band II,Band V,and Bluetooth, WiFi2.4Gcamera functions. For more information see the following datasheet</i> | |

| Technical Characteristics | |
|---------------------------|---|
| GSM | |
| Support Networks | GSM, GPRS, EDGE |
| Support Band | GSM850, PCS1900 |
| Frequency | GSM850: 824.2~848.8MHz GSM1900: 1850.2~1909.8MHz |
| Power Class: | GSM850:Power Class 4 PCS1900:Power Class 1 |
| Modulation Type: | GMSK for GSM/GPRS; GMSK/8PSK For EGPRS |
| Antenna Information | PIFA Antenna 0dBi (max.) For GSM 850; 0dBi (max.) For PCS 1900 |
| GSM Release Version | R99 |
| GPRS Multislot Class | 12 |
| EGPRS Multislot Class | 12 |
| DTM Mode | Not Supported |
| UMTS | |
| Support Networks | WCDMA RMC12.2K,HSDPA,HSUPA |
| Operation Band: | WCDMA Band II,BandV |
| FrequencyRange | WCDMA Band II: 1852.4~1907.6MHz WCDMA Band V: 826.4~846.6MHz |
| Modulation Type: | QPSK for WCDMA/HSUPA/HSDPA |
| Power Class: | Class 3 |
| WCDMA Release Version: | R99 |
| HSDPA Release Version: | Release 9 |
| HSUPA Release Version: | Release 6 |
| DC-HSUPA Release Version: | Not Supported |
| Antenna Information | PIFA Antenna 0dBi (max.) For WCDMA Band II 0dBi (max.) For WCDMA Band V |

| WIFI 2.4G | |
|----------------------|--|
| Supported Standards: | IEEE 802.11b/802.11g/802.11n(HT20 and HT40) |
| Operation frequency: | 2412-2462MHz for 11b/g/n(HT20) 2422-2452MHz for 11n(HT40) |
| Type of Modulation: | CCK, OFDM, QPSK, BPSK, 16QAM, 64QAM |
| Data Rate: | 1-11Mbps, 6-54Mbps, up to 150Mbps |
| Channel number: | IEEE 802.11b/802.11g/802.11n(HT20): 11; 802.11n(HT40): 7 |
| Channel separation: | 5MHz |
| Antenna Description | PIFA Antenna;-1dBi(Max.) |
| Bluetooth | |
| Bluetooth Version: | V4.1 |
| Modulation: | GFSK(1Mbps) , $\pi/4$ -DQPSK(2Mbps), 8DPSK(3Mbps) |
| Operation frequency: | 2402MHz~2480MHz |
| Channel number: | 40/79 |
| Channel separation: | 1MHz/2MHz |
| Antenna Description | PIFA Antenna;-1dBi(Max.) |

1.5. Statement of Compliance

The maximum of results of SAR found during testing for X30are follows:

<Highest Reported standalone SAR Summary>

| Classment Class | Frequency Band | Head (Report SAR _{1-g} (W/Kg)) | Hotspot (Report SAR _{1-g} (W/Kg)) | Body-worn (Report SAR _{1-g} (W/Kg)) |
|-----------------|----------------|---|--|--|
| PCE | GSM 850 | 0.384 | 0.467 | 0.467 |
| | GSM1900 | 0.282 | 1.275 | 1.275 |
| | WCDMA Band V | 0.417 | 0.601 | 0.601 |
| | WCDMA Band II | 0.139 | 0.346 | 0.346 |
| DTS | WIFI2.4G | 0.328 | 0.195 | 0.195 |

This device is in compliance with Specific Absorption Rate (SAR) for general population/uncontrolled exposure limits (1.6 W/kg) specified in FCC 47 CFR part 2 (2.1093) and ANSI/IEEE C95.1-2005, and had been tested in accordance with the measurement methods and procedures specified in IEEE 1528-2013.

<Highest Reported simultaneous SAR Summary>

| Exposure Position | Frequency Band | Reported SAR _{1-g} (W/kg) | Classment Class | Highest Reported Simultaneous Transmission SAR _{1-g} (W/Kg) |
|-------------------|----------------|------------------------------------|-----------------|--|
| Hotspot | GSM1900 | 1.275 | PCE | 1.470 |
| | WIFI2.4G | 0.195 | DTS | |

2. TEST ENVIRONMENT

2.1. Test Facility

The test facility is recognized, certified, or accredited by the following organizations:

Site Description
EMC Lab. : CNAS Registration Number. is L4595.
FCC Registration Number. is 899208.
Industry Canada Registration Number. is 9642A-1.
ESMD Registration Number. is ARCB0108.
UL Registration Number. is 100571-492.
TUV SUD Registration Number. is SCN1081.
TUV RH Registration Number. is UA 50296516-001.

2.2. Environmental conditions

During the measurement the environmental conditions were within the listed ranges:

| | |
|-----------------------|--------------|
| Temperature: | 18-25 ° C |
| Humidity: | 40-65 % |
| Atmospheric pressure: | 950-1050mbar |

2.3. SAR Limits

| EXPOSURE LIMITS | FCC Limit (1g Tissue) | |
|--|--|--|
| | SAR (W/kg) | |
| | (General Population / Uncontrolled Exposure Environment) | (Occupational / Controlled Exposure Environment) |
| Spatial Average(averaged over the whole body) | 0.08 | 0.4 |
| Spatial Peak(averaged over any 1 g of tissue) | 1.6 | 8.0 |
| Spatial Peak(hands/wrists/ feet/anklesaveraged over 10 g) | 4.0 | 20.0 |

Population/Uncontrolled Environments are defined as locations where there is the exposure of individual who have no knowledge or control of their exposure.

Occupational/Controlled Environments are defined as locations where there is exposure that may be incurred by people who are aware of the potential for exposure (i.e. as a result of employment or occupation).

2.4. Equipments Used during the Test

| Test Equipment | Manufacturer | Type/Model | Serial Number | Calibration | |
|--|--------------------------|-----------------|------------------------|------------------|-----------------|
| | | | | Calibration Date | Calibration Due |
| PC | Lenovo | G5005 | MY42081102 | N/A | N/A |
| Signal Generator | Angilent | E4438C | MY42081396 | 09/25/2016 | 09/24/2017 |
| Multimeter | Keithley | MiltiMeter 2000 | 4059164 | 10/01/2016 | 09/30/2017 |
| S-parameter Network Analyzer | Agilent | 8753ES | US38432944 | 09/25/2016 | 09/24/2017 |
| Wireless Communication Test Set | R & S | CMU200 | 105988 | 09/25/2016 | 09/24/2017 |
| Wideband Radia Communication Tester | R&S | CMW500 | 1201.0002K50 | 09/25/2016 | 09/24/2017 |
| Power Meter | R & S | NRVS | 100469 | 09/25/2016 | 09/24/2017 |
| Power Sensor | R & S | NRV-Z81 | 100458 | 09/25/2016 | 09/24/2017 |
| Power Sensor | R & S | NRV-Z32 | 10057 | 09/25/2016 | 09/24/2017 |
| E-Field PROBE | SATIMO | SSE2 | SN 34/15EPGO265 | 09/15/2016 | 09/14/2017 |
| DIPOLE 835 | SATIMO | SID 835 | SN 07/14 DIP 0G835-303 | 10/01/2015 | 09/30/2018 |
| DIPOLE 1900 | SATIMO | SID 1900 | SN 30/14 DIP 1G900-333 | 10/01/2015 | 09/30/2018 |
| DIPOLE 2450 | SATIMO | SID 2450 | SN 07/14 DIP 2G450-306 | 10/01/2015 | 09/30/2018 |
| COMOSAR OPEN Coaxial Probe | SATIMO | OCPG 68 | SN 40/14 OCPG68 | 10/01/2016 | 09/30/2017 |
| Communication Antenna | SATIMO | ANTA57 | SN 39/14 ANTA57 | 10/01/2016 | 09/30/2017 |
| Mobile Phone POSITIONING DEVICE | SATIMO | MSH98 | SN 40/14 MSH98 | N/A | N/A |
| DUMMY PROBE | SATIMO | DP60 | SN 03/14 DP60 | N/A | N/A |
| SAM PHANTOM | SATIMO | SAM117 | SN 40/14 SAM117 | N/A | N/A |
| High Power Solid State Amplifier (80MHz~1000MHz) | Instruments for Industry | CMC150 | M631-0627 | 09/25/2016 | 09/24/2017 |
| Medium Power Solid State Amplifier (0.8~4.2GHz) | Instruments for Industry | S41-25 | M629-0539 | 09/25/2016 | 09/24/2017 |
| Wave Tube Amplifier 48 GHz at 20Watt | Hughes Aircraft Company | 1277H02F000 | 102 | 09/25/2016 | 09/24/2017 |

Note:

- 1) Per KDB865664D01 requirements for dipole calibration, the test laboratory has adopted three year extended calibration interval. Each measured dipole is expected to evaluate with following criteria at least on annual interval.
 - a) There is no physical damage on the dipole;
 - b) System check with specific dipole is within 10% of calibrated values;
 - c) The most recent return-loss results,measured at least annually,deviates by no more than 20% from the previous measurement;
 - d) The most recent measurement of the real or imaginary parts of the impedance, measured at least annually is within 5Ω from the previous measurement.
- 2) Network analyzer probe calibration against air, distilled water and a shorting block performed before measuring liquid parameters.

3.SAR MEASUREMENTS SYSTEM CONFIGURATION

3.1. SAR Measurement Set-up

The OPENSAR system for performing compliance tests consist of the following items:

A standard high precision 6-axis robot (KUKA) with controller and software.

KUKA Control Panel (KCP)

A dosimetric probe, i.e., an isotropic E-field probe optimized and calibrated for usage in tissue simulating liquid. The probe is equipped with a Video Positioning System(VPS).

The stress sensor is composed with mechanical and electronic when the electronic part detects a change on the electro-mechanical switch,It sends an "Emergency signal" to the robot controller that to stop robot's moves

A computer operating Windows XP.

OPENSAR software

Remote control with teaches pendant and additional circuitry for robot safety such as warning lamps, etc.

The SAM phantom enabling testing left-hand right-hand and body usage.

The Position device for handheld EUT

Tissue simulating liquid mixed according to the given recipes .

System validation dipoles to validate the proper functioning of the system.

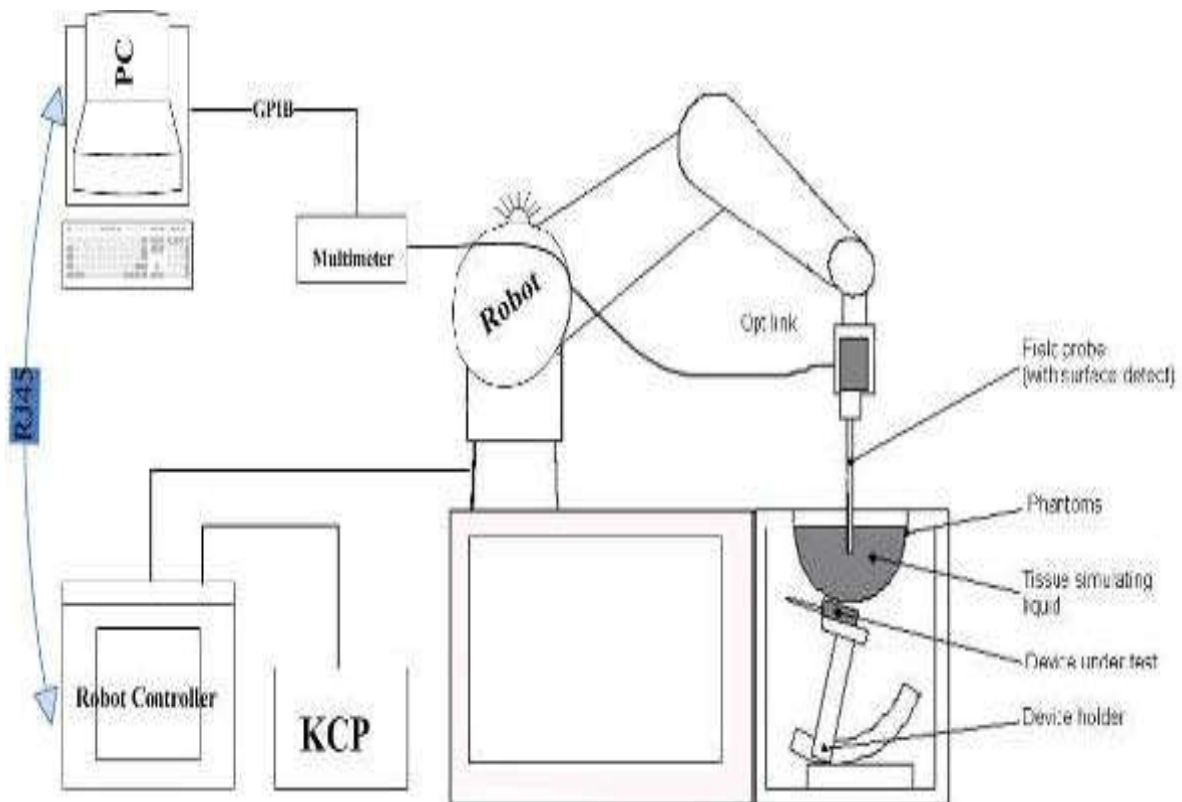

3.2. OPENSAR E-field Probe System

The SAR measurements were conducted with the dosimetric probe EPGO265 (manufactured by SATIMO), designed in the classical triangular configuration and optimized for dosimetric evaluation.

Probe Specification

Construction Symmetrical design with triangular core
 Interleaved sensors
 Built-in shielding against static charges
 PEEK enclosure material (resistant to organic solvents, e.g., DGBE)

Calibration ISO/IEC 17025 calibration service available.

| | |
|---------------|--|
| Frequency | 700 MHz to 3 GHz; Linearity: 0.25dB(700 MHz to 3GHz) |
| Directivity | 0.25 dB in HSL (rotation around probe axis) 0.5 dB in tissue material (rotation normal to probe axis) |
| Dynamic Range | 0.01W/kg to > 100 W/kg; Linearity: 0.25 dB |
| Dimensions | Overall length: 330 mm (Tip: 16mm) Tip diameter: 5 mm (Body: 8 mm) Distance from probe tip to sensor centers: 2.5 mm |
| Application | General dosimetry up to 3 GHz Dosimetry in strong gradient fields Compliance tests of Mobile Phones |



Isotropic E-Field Probe

The isotropic E-Field probe has been fully calibrated and assessed for isotropicity, and boundary effect within a controlled environment. Depending on the frequency for which the probe is calibrated the method utilized for calibration will change.

The E-Field probe utilizes a triangular sensor arrangement as detailed in the diagram below:

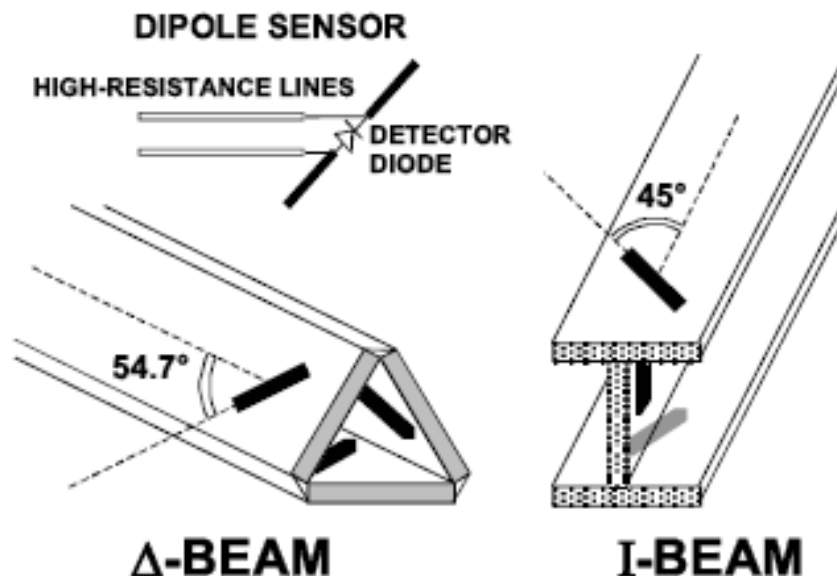

3.3. Phantoms

The SAM Phantom SAM117 is constructed of a fiberglass shell integrated in a wooden table. The shape of the shell is in compliance with the specification set in IEEE P1528 and CENELEC EN62209-1, EN62209-2:2010. The phantom enables the dosimetric evaluation of left and right hand phone usage as well as body mounted usage at the flat phantom region. A cover prevents the evaporation of the liquid. Reference markings on the Phantom allow the complete setup of all predefined phantom positions and measurement grids by manually teaching three points in the robot.

System checking was performed using the flat section, whilst Head SAR tests used the left and right head profile sections. Body SAR testing also used the flat section between the head profiles.



SAM Twin Phantom

3.4. Device Holder

In combination with the Generic Twin Phantom SAM117, the Mounting Device enables the rotation of the mounted transmitter in spherical coordinates whereby the rotation points is the ear opening. The devices can be easily, accurately, and repeatedly positioned according to the FCC and CENELEC specifications. The device holder can be locked at different phantom locations (left head, right head, flat phantom).



Device holder supplied by SATIMO

3.5. Scanning Procedure

The procedure for assessing the peak spatial-average SAR value consists of the following steps

Power Reference Measurement

The reference and drift jobs are useful jobs for monitoring the power drift of the device under test in the batch process. Both jobs measure the field at a specified reference position, at a selectable distance from the phantom surface. The reference position can be either the selected section's grid reference point or a user point in this section. The reference job projects the selected point onto the phantom surface, orients the probe perpendicularly to the surface, and approaches the surface using the selected detection method.

Area Scan

The Area Scan is used as a fast scan in two dimensions to find the area of high field values before running a detailed measurement around the hot spot. Before starting the area scan a grid spacing of 15 mm x 15 mm is set. During the scan the distance of the probe to the phantom remains unchanged. After finishing area scan, the field maxima within a range of 2 dB will be ascertained.

| | ≤ 3 GHz | > 3 GHz |
|--|---|---|
| Maximum distance from closest measurement point (geometric center of probe sensors) to phantom surface | 5 mm ± 1 mm | $\frac{1}{2} \cdot \delta \cdot \ln(2)$ mm ± 0.5 mm |
| Maximum probe angle from probe axis to phantom surface normal at the measurement location | 30° ± 1° | 20° ± 1° |
| Maximum area scan spatial resolution: Δx_{Area} , Δy_{Area} | ≤ 2 GHz: ≤ 15 mm 2 – 3 GHz: ≤ 12 mm | 3 – 4 GHz: ≤ 12 mm 4 – 6 GHz: ≤ 10 mm |
| | When the x or y dimension of the test device, in the measurement plane orientation, is smaller than the above, the measurement resolution must be ≤ the corresponding x or y dimension of the test device with at least one measurement point on the test device. | |

Zoom Scan

Zoom Scans are used to estimate the peak spatial SAR values within a cubic averaging volume containing 1 g and 10 g of simulated tissue. The default Zoom Scan is done by 7x7x7 points within a cube whose base is centered around the maxima found in the preceding area scan.

| | | | |
|--|---|---|---|
| Maximum zoom scan spatial resolution: $\Delta x_{\text{zoom}}, \Delta y_{\text{zoom}}$ | | ≤ 2 GHz: ≤ 8 mm 2 – 3 GHz: ≤ 5 mm* | 3 – 4 GHz: ≤ 5 mm* 4 – 6 GHz: ≤ 4 mm* |
| Maximum zoom scan spatial resolution, normal to phantom surface | uniform grid: $\Delta z_{\text{zoom}}(n)$ | ≤ 5 mm | 3 – 4 GHz: ≤ 4 mm 4 – 5 GHz: ≤ 3 mm 5 – 6 GHz: ≤ 2 mm |
| | graded grid | $\Delta z_{\text{zoom}}(1)$: between 1 st two points closest to phantom surface | ≤ 4 mm |
| | | $\Delta z_{\text{zoom}}(n>1)$: between subsequent points | $\leq 1.5 \cdot \Delta z_{\text{zoom}}(n-1)$ mm |
| Minimum zoom scan volume | x, y, z | ≥ 30 mm | 3 – 4 GHz: ≥ 28 mm 4 – 5 GHz: ≥ 25 mm 5 – 6 GHz: ≥ 22 mm |
| <p>Note: δ is the penetration depth of a plane-wave at normal incidence to the tissue medium; see IEEE Std 1528-2013 for details.</p> <p>* When zoom scan is required and the <i>reported</i> SAR from the <i>area scan based 1-g SAR estimation</i> procedures of KDB Publication 447498 is ≤ 1.4 W/kg, ≤ 8 mm, ≤ 7 mm and ≤ 5 mm zoom scan resolution may be applied, respectively, for 2 GHz to 3 GHz, 3 GHz to 4 GHz and 4 GHz to 6 GHz.</p> | | | |

Power Drift measurement

The drift job measures the field at the same location as the most recent reference job within the same procedure, and with the same settings. The drift measurement gives the field difference in dB from the reading conducted within the last reference measurement. Several drift measurements are possible for one reference measurement. This allows a user to monitor the power drift of the device under test within a batch process. In the properties of the Drift job, the user can specify a limit for the drift and have OPENSAR software stop the measurements if this limit is exceeded.

3.6. Data Storage and Evaluation

Data Storage

The OPENSAR software stores the acquired data from the data acquisition electronics as raw data (in microvolt readings from the probe sensors), together with all necessary software parameters for the data evaluation (probe calibration data, liquid parameters and device frequency and modulation data) in measurement files . The software evaluates the desired unit and format for output each time the data is visualized or exported. This allows verification of the complete software setup even after the measurement and allows correction of incorrect parameter settings. For example, if a measurement has been performed with a wrong crest factor parameter in the device setup, the parameter can be corrected afterwards and the data can be re-evaluated.

The measured data can be visualized or exported in different units or formats, depending on the selected probe type ([V/m], [A/m], [°C], [mW/g], [mW/cm²], [dBrel], etc.). Some of these units are not available in certain situations or show meaningless results, e.g., a SAR output in a lossless media will always be zero. Raw data can also be exported to perform the evaluation with other software packages.

Data Evaluation

The OPENSAR software automatically executes the following procedures to calculate the field units from the microvolt readings at the probe connector. The parameters used in the evaluation are stored in the configuration modules of the software:

- Probe parameters: - Sensitivity Normi, ai0, ai1, ai2
- Conversion factor ConvFi
- Diode compression point Dcpi
- Device parameters: - Frequency f
- Crest factor cf
- Media parameters: - Conductivity σ
- Density ρ

These parameters must be set correctly in the software. They can be found in the component documents or they can be imported into the software from the configuration files issued for the OPENSAR components. In the direct measuring mode of the multimeter option, the parameters of the actual system setup are used. In the scan visualization and export modes, the parameters stored in the corresponding document files are used.

The first step of the evaluation is a linearization of the filtered input signal to account for the compression characteristics of the detector diode. The compensation depends on the input signal, the diode type and the DC-transmission factor from the diode to the evaluation electronics. If the exciting field is pulsed, the crest factor of the signal must be known to correctly compensate for peak power. The formula for each channel can be given as:

$$V_i = U_i + U_i^2 \cdot \frac{cf}{dcp_i}$$

- With Vi = compensated signal of channel i (i = x, y, z)
- Ui = input signal of channel i (i = x, y, z)
- cf = crest factor of exciting field
- dcp_i = diode compression point

From the compensated input signals the primary field data for each channel can be evaluated:

E – fieldprobes : $E_i = \sqrt{\frac{V_i}{Norm_i \cdot ConvF}}$

H fieldprobes : $H_i = \sqrt{V_i} \cdot \frac{a_{i0} - a_{i1}f + a_{i2}f^2}{f}$

- With Vi = compensated signal of channel i (i = x, y, z)
- Normi = sensor sensitivity of channel i (i = x, y, z)
- [mV/(V/m)²] for E-field Probes
- ConvF = sensitivity enhancement in solution

- aij = sensor sensitivity factors for H-field probes
- f = carrier frequency [GHz]
- Ei = electric field strength of channel i in V/m
- Hi = magnetic field strength of channel i in A/m

The RSS value of the field components gives the total field strength (Hermitian magnitude):

$$E_{tot} = \sqrt{E_x^2 + E_y^2 + E_z^2}$$

The primary field data are used to calculate the derived field units.

$$SAR = E_{tot}^2 \cdot \frac{\sigma}{\rho \cdot 1'000}$$

- with SAR = local specific absorption rate in mW/g
- Etot = total field strength in V/m
- σ = conductivity in [mho/m] or [Siemens/m]
- ρ = equivalent tissue density in g/cm3

Note that the density is normally set to 1 (or 1.06), to account for actual brain density rather than the density of the simulation liquid.

3.7. Position of the wireless device in relation to the phantom

General considerations

This standard specifies two handset test positions against the head phantom – the “cheek” position and the “tilt” position.

The power flow density is calculated assuming the excitation field as a free space field

$$P_{(pwe)} = \frac{E_{tot}^2}{3770} \text{ or } P_{(pwe)} = H_{tot}^2 \cdot 37.7$$

Where P_{pwe}=Equivalent power density of a plane wave in mW/cm2

E_{tot}=total electric field strength in V/m

H_{tot}=total magnetic field strength in A/m

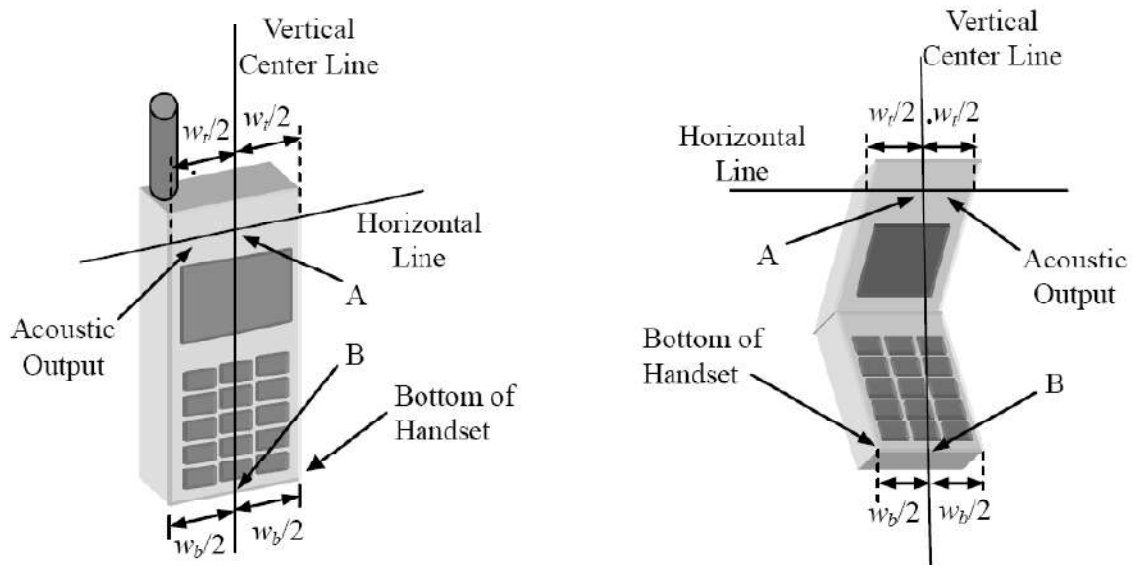

W_t Width of the handset at the level of the acoustic

W_b Width of the bottom of the handset

A Midpoint of the width w_r of the handset at the level of the acoustic output

B Midpoint of the width w_b of the bottom of the handset

Picture 1-a Typical “fixed” case handset Picture 1-b Typical “clam-shell” case handset

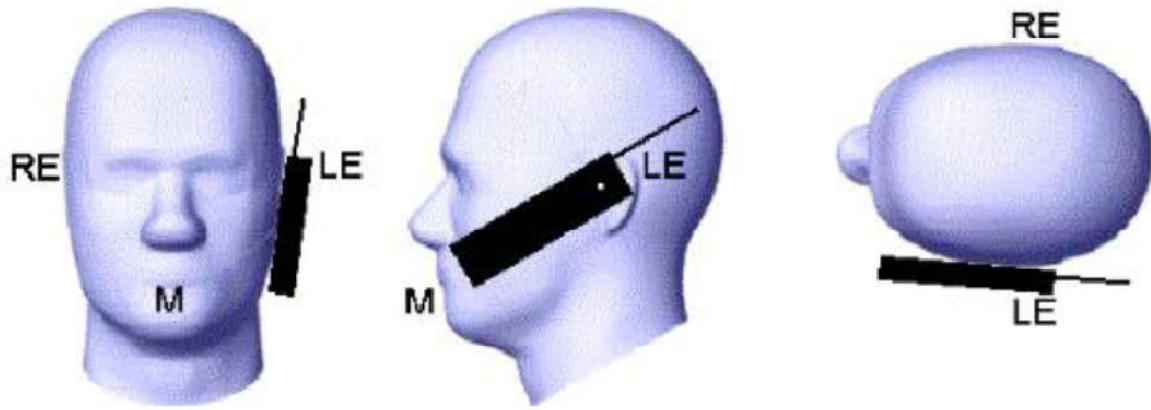

Picture 2 Cheek position of the wireless device on the left side of SAM

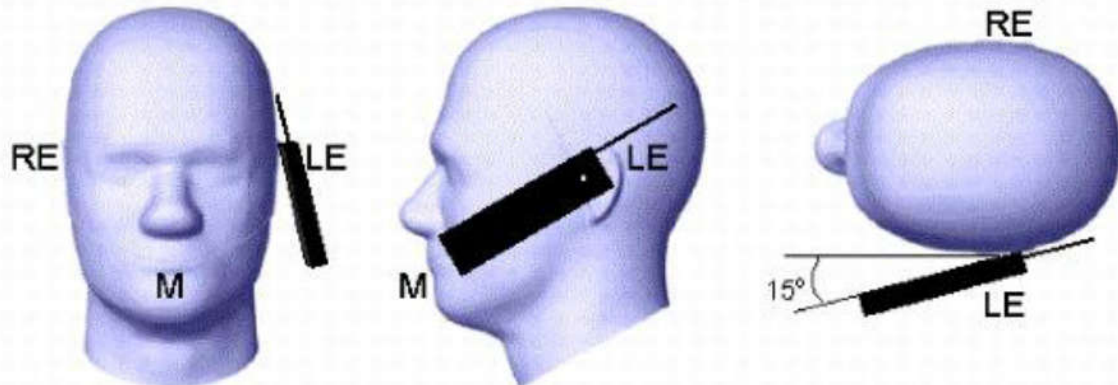

Picture 3 Tilt position of the wireless device on the left side of SAM

For body SAR test we applied to FCC KDB941225, KDB447498, KDB248227, KDB648654;

3.8. Tissue Dielectric Parameters for Head and Body Phantoms

The liquid is consisted of water,salt,Glycol,Sugar,Preventol and Cellulose.The liquid has previously been proven to be suited for worst-case.It's satisfying the latest tissue dielectric parameters requirements proposed by the KDB865664.

The composition of the tissue simulating liquid

| Ingredient (% Weight) | 750MHz | | 835MHz | | 1800 MHz | | 1900 MHz | | 2450MHz | | 2600MHz | | 5000MHz | |
|-----------------------------|--------|------|--------|------|----------|-------|----------|-------|---------|-------|---------|-------|---------|------|
| | Head | Body | Head | Body | Head | Body | Head | Body | Head | Body | Head | Body | Head | Body |
| Water | 39.28 | 51.3 | 41.45 | 52.5 | 54.5 | 40.2 | 54.9 | 40.4 | 62.7 | 73.2 | 60.3 | 71.4 | 65.5 | 78.6 |
| Preventol | 0.10 | 0.10 | 0.10 | 0.10 | 0.00 | 0.00 | 0.00 | 0.00 | 0.00 | 0.00 | 0.00 | 0.00 | 0.00 | 0.00 |
| HEC | 1.00 | 1.00 | 1.00 | 1.00 | 0.00 | 0.00 | 0.00 | 0.00 | 0.00 | 0.00 | 0.00 | 0.00 | 0.00 | 0.00 |
| DGBE | 0.00 | 0.00 | 0.00 | 0.00 | 45.33 | 59.31 | 44.92 | 59.10 | 36.80 | 26.70 | 39.10 | 28.40 | 0.00 | 0.00 |
| Triton X-100 | 0.00 | 0.00 | 0.00 | 0.00 | 0.00 | 0.00 | 0.00 | 0.00 | 0.00 | 0.00 | 0.00 | 0.00 | 17.2 | 10.7 |

| Target Frequency (MHz) | Head | | Body | |
|---------------------------|--------------|----------------|--------------|----------------|
| | ϵ_r | σ (S/m) | ϵ_r | σ (S/m) |
| 150 | 52.3 | 0.76 | 61.9 | 0.80 |
| 300 | 45.3 | 0.87 | 58.2 | 0.92 |
| 450 | 43.5 | 0.87 | 56.7 | 0.94 |
| 835 | 41.5 | 0.90 | 55.2 | 0.97 |
| 900 | 41.5 | 0.97 | 55.0 | 1.05 |
| 915 | 41.5 | 0.98 | 55.0 | 1.06 |
| 1450 | 40.5 | 1.20 | 54.0 | 1.30 |
| 1610 | 40.3 | 1.29 | 53.8 | 1.40 |
| 1800-2000 | 40.0 | 1.40 | 53.3 | 1.52 |
| 2450 | 39.2 | 1.80 | 52.7 | 1.95 |
| 3000 | 38.5 | 2.40 | 52.0 | 2.73 |
| 5800 | 35.3 | 5.27 | 48.2 | 6.00 |

3.9. Tissue equivalent liquid properties

Dielectric Performance of Head and Body Tissue Simulating Liquid

| Tissue Type | Measured Frequency (MHz) | Target Tissue | | Measured Tissue | | | | Liquid Temp. | Test Data |
|-------------|--------------------------|---------------|--------------|-----------------|--------|--------------|-------|--------------|------------|
| | | σ | ϵ_r | σ | Dev. | ϵ_r | Dev. | | |
| 835H | 835 | 0.90 | 41.50 | 0.87 | -3.33% | 41.52 | 0.05% | 21.0 | 07/03/2017 |
| 1900H | 1900 | 1.40 | 40.00 | 1.42 | 1.43% | 40.03 | 0.08% | 21.0 | 07/05/2017 |
| 2450H | 2450 | 1.80 | 39.20 | 1.81 | 0.56% | 40.03 | 2.12% | 21.0 | 07/10/2017 |
| 835B | 835 | 0.97 | 55.20 | 0.99 | 2.06% | 55.23 | 0.05% | 21.0 | 07/04/2017 |
| 1900B | 1900 | 1.52 | 53.30 | 1.53 | 0.66% | 53.32 | 0.04% | 21.0 | 07/06/2017 |
| 2450B | 2450 | 1.95 | 52.70 | 1.98 | 1.54% | 52.71 | 0.02% | 21.0 | 07/11/2117 |

3.10. System Check

The purpose of the system check is to verify that the system operates within its specifications at the device test frequency. The system check is simple check of repeatability to make sure that the system works correctly at the time of the compliance test;

System check results have to be equal or near the values determined during dipole calibration with the relevant liquids and test system ($\pm 10\%$).

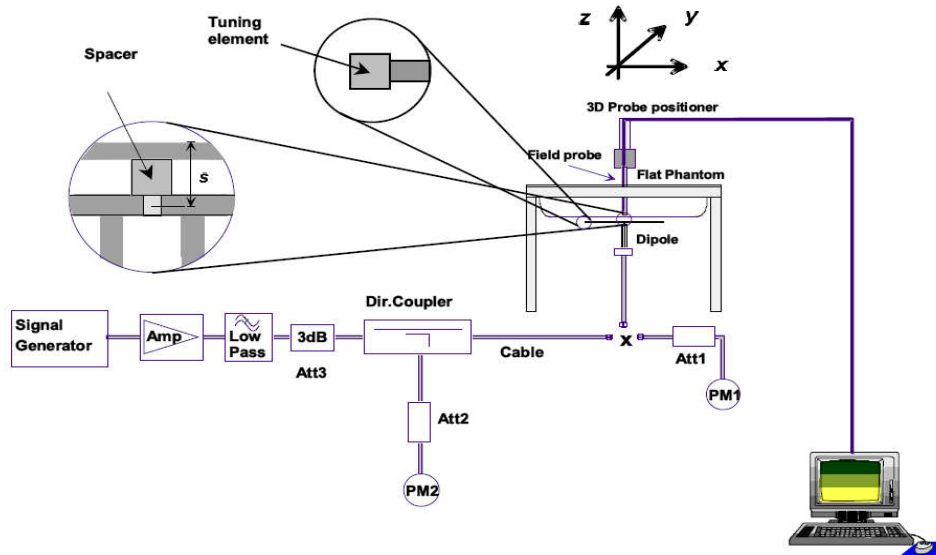

The output power on dipole port must be calibrated to 20 dBm (100mW) before dipole is connected.



Photo of Dipole Setup

Justification for Extended SAR Dipole Calibrations

Referring to KDB 865664D01V01r04, if dipoles are verified in return loss (<-20dB, within 20% of prior calibration), and in impedance (within 5 ohm of prior calibration), the annual calibration is not necessary and the calibration interval can be extended. While calibration intervals not exceed 3 years.

SID835SN 07/14 DIP 0G835-303 Extend Dipole Calibrations

| Date of Measurement | Return-Loss (dB) | Delta (%) | Real Impedance (ohm) | Delta (ohm) | Imaginary Impedance (ohm) | Delta (ohm) |
|---------------------|------------------|-----------|----------------------|-------------|---------------------------|-------------|
| 2015-10-01 | -24.46 | | 55.4 | | 2.4 | |
| 2016-09-30 | -25.50 | 4.252 | 56.2 | 0.8 | 1.353 | -1.047 |

SID1900 SN 30/14 DIP 1G900-333 Extend Dipole Calibrations

| Date of Measurement | Return-Loss (dB) | Delta (%) | Real Impedance (ohm) | Delta (ohm) | Imaginary Impedance (ohm) | Delta (ohm) |
|---------------------|------------------|-----------|----------------------|-------------|---------------------------|-------------|
| 2015-10-01 | -23.68 | | 51.2 | | 6.4 | |
| 2016-09-30 | -24.20 | 2.196 | 50.178 | -1.022 | 3.522 | -2.878 |

SID2450SN 07/14 DIP 2G450-306 Extend Dipole Calibrations

| Date of Measurement | Return-Loss (dB) | Delta (%) | Real Impedance (ohm) | Delta (ohm) | Imaginary Impedance (ohm) | Delta (ohm) |
|---------------------|------------------|-----------|----------------------|-------------|---------------------------|-------------|
| 2015-10-01 | -25.61 | | 44.9 | | -0.9 | |
| 2016-09-30 | -26.37 | -3.007 | 45.025 | 0.125 | -1.068 | -0.168 |

| Mixture Type | Frequency (MHz) | Power | SAR _{1g} (W/Kg) | SAR _{10g} (W/Kg) | Drift (%) | 1W Target | | Difference percentage | | Liquid Temp | Date |
|--------------|-----------------|---------------------|--------------------------|---------------------------|-----------|--------------------------|---------------------------|-----------------------|--------|-------------|------------|
| | | | | | | SAR _{1g} (W/Kg) | SAR _{10g} (W/Kg) | 1g | 10g | | |
| Head | 835 | 100 mW | 0.963 | 0.625 | 0.12 | 9.60 | 6.20 | 0.31% | 0.81% | 21.0 | 07/03/2017 |
| | | Normalize to 1 Watt | 9.63 | 6.25 | | | | | | | |
| Body | 835 | 100 mW | 0.952 | 0.625 | -0.18 | 9.90 | 6.39 | -3.84% | -2.19% | 21.0 | 07/04/2017 |
| | | Normalize to 1 Watt | 9.52 | 6.25 | | | | | | | |
| Head | 1900 | 100 mW | 4.039 | 1.980 | -0.03 | 39.84 | 20.20 | 1.38% | -1.98% | 21.0 | 07/05/2017 |
| | | Normalize to 1 Watt | 40.39 | 19.80 | | | | | | | |
| Body | 1900 | 100 mW | 4.210 | 2.156 | 1.74 | 43.33 | 21.59 | -2.84% | -0.14% | 21.0 | 07/06/2017 |
| | | Normalize to 1 Watt | 42.10 | 21.56 | | | | | | | |
| Head | 2450 | 100 mW | 5.231 | 2.356 | 0.25 | 53.89 | 24.15 | -2.93% | -2.44% | 21.0 | 07/10/2017 |
| | | Normalize to 1 Watt | 52.31 | 23.56 | | | | | | | |
| Body | 2450 | 100 mW | 5.270 | 2.489 | -0.30 | 54.65 | 24.58 | -3.57% | 1.26% | 21.0 | 07/11/2017 |
| | | Normalize to 1 Watt | 52.70 | 24.89 | | | | | | | |

3.11. SAR measurement procedure

The measurement procedures are as follows:

3.11.1 Conducted power measurement

- For WWAN power measurement, use base station simulator connection with RF cable, at maximum power in each supported wireless interface and frequency band.
- Read the WWAN RF power level from the base station simulator.
- For WLAN/BT power measurement, use engineering software to configure EUT WLAN/BT continuously Transmission, at maximum RF power in each supported wireless interface and frequency band.
- Connect EUT RF port through RF cable to the power meter, and measure WLAN/BT output power.

3.11.2 GSM Test Configuration

SAR tests for GSM 850 and GSM 1900, a communication link is set up with a System Simulator (SS) by air link. Using CMU200 the power level is set to "5" for GSM 850, set to "0" for GSM 1900. Since the GPRS class is 12 for this EUT, it has at most 4 timeslots in uplink and at most 4 timeslots in downlink, the maximum total timeslots is 5. the EGPRS class is 12 for this EUT, it has at most 4 timeslots in uplink and at most 4 timeslots in downlink, the maximum total timeslots is 5.

SAR test reduction for GPRS and EDGE modes is determined by the source-based time-averaged output power specified for production units, including tune-up tolerance. The data mode with highest specified time-averaged output power should be tested for SAR compliance in the applicable exposure conditions. For modes with the same specified maximum output power and tolerance, the higher number time-slot configuration should be tested. GSM voice and GPRS data use GMSK, which is a constant amplitude modulation with minimal peak to average power difference within the time-slot burst. For EDGE, GMSK is used for MCS 1 – MCS 4 and 8-PSK is used for MCS 5 – MCS 9; where 8-PSK has an inherently higher peak-to-average power ratio. The GMSK and 8-PSK EDGE configurations are considered separately for SAR compliance. The GMSK EDGE configurations are grouped with GPRS and considered with respect to time-averaged maximum output power to determine compliance. The 3G SAR test reduction procedure is applied to 8-PSK EDGE with GMSK GPRS/EDGE as the primary mode.

3.11.3 UMTS Test Configuration

3G SAR Test Reduction Procedure

In the following procedures, the mode tested for SAR is referred to as the primary mode. The equivalent modes considered for SAR test reduction are denoted as secondary modes. Both primary and secondary modes must be in the same frequency band. When the maximum output power and tune-up tolerance specified for production units in a secondary mode is ≤ ¼ dB higher than the primary mode or when the highest reported SAR of the primary mode is scaled by the ratio of specified maximum output power and tune-up tolerance of secondary to primary mode and the adjusted SAR is ≤ 1.2 W/kg, SAR measurement is not required for the secondary mode. This is referred to as the 3G SAR test reduction procedure in the following SAR test guidance, where the primary

mode is identified in the applicable wireless mode test procedures and the secondary mode is wireless mode being considered for SAR test reduction by that procedure. When the 3G SAR test reduction procedure is not satisfied, it is identified as “otherwise” in the applicable procedures; SAR measurement is required for the secondary mode.

Output power Verification

Maximum output power is verified on the high, middle and low channels according to procedures described in section 5.2 of 3GPP TS 34.121, using the appropriate RMC or AMR with TPC (transmit power control) set to all “1’s” for WCDMA/HSDPA or by applying the required inner loop power control procedures to maintain maximum output power while HSUPA is active. Results for all applicable physical channel configurations (DPCCH, DPDCHn and spreading codes, HSDPA, HSPA) are required in the SAR report. All configurations that are not supported by the handset or cannot be measured due to technical or equipment limitations must be clearly identified.

Head SAR

SAR for next to the ear head exposure is measured using a 12.2 kbps RMC with TPC bits configured to all “1’s”. The 3G SAR test reduction procedure is applied to AMR configurations with 12.2 kbps RMC as the primary mode. Otherwise, SAR is measured for 12.2 kbps AMR in 3.4 kbps SRB (signaling radio bearer) using the highest reported SAR configuration in 12.2 kbps RMC for head exposure.

1) Body-Worn Accessory SAR

SAR for body-worn accessory configurations is measured using a 12.2 kbps RMC with TPC bits configured to all “1’s”. The 3G SAR test reduction procedure is applied to other spreading codes and multiple DPDCHn configurations supported by the handset with 12.2 kbps RMC as the primary mode. Otherwise, SAR is measured using an applicable RMC configuration with the corresponding spreading code or DPDCHn, for the highest reported body-worn accessory exposure SAR configuration in 12.2 kbps RMC. When more than 2 DPDCHn are supported by the handset, it may be necessary to configure additional DPDCHn using FTM (Factory Test Mode) or other chipset based test approaches with parameters similar to those used in 384 kbps and 768 kbps RMC.

2) Handsets with Release 5 HSDPA

The 3G SAR test reduction procedure is applied to HSDPA body-worn accessory configurations with 12.2 kbps RMC as the primary mode. Otherwise, SAR is measured for HSDPA using the HSDPA body SAR procedures in the “Release 5 HSDPA Data Devices” section of this document, for the highest reported SAR body-worn accessory exposure configuration in 12.2 kbps RMC. Handsets with both HSDPA and HSUPA are tested according to Release 6 HSPA test procedures.

HSDPA should be configured according to the UE category of a test device. The number of HSDSCH/ HS-PDSCHs, HARQ processes, minimum inter-TTI interval, transport block sizes and RV coding sequence are defined by the H-set. To maintain a consistent test configuration and stable transmission conditions, QPSK is used in the H-set for SAR testing. HS-DPCCH should be configured with a CQI feedback cycle of 4 ms with a CQI repetition factor of 2 to maintain a constant rate of active CQI slots. DPCCH and DPDCH gain factors (β_c , β_d), and HS-DPCCH power offset parameters (Δ_{ACK} , Δ_{NACK} , Δ_{CQI}) should be set according to values indicated in the Table below. The CQI value is determined by the UE category, transport block size, number of HS-PDSCHs and modulation used in the H-set.

Table 2: Subtests for UMTS Release 5 HSDPA

| Sub-set | β_c | β_d | β_d (SF) | β_c/β_d | β_{hs} (note 1, note 2) | CM(dB) (note 3) | MPR(dB) |
|---------|----------------|----------------|----------------|-------------------|-------------------------------|-----------------|---------|
| 1 | 2/15 | 15/15 | 64 | 2/15 | 4/15 | 0.0 | 0.0 |
| 2 | 12/15 (note 4) | 15/15 (note 4) | 64 | 12/15 (note 4) | 24/15 | 1.0 | 0.0 |
| 3 | 15/15 | 8/15 | 64 | 15/8 | 30/15 | 1.5 | 0.5 |
| 4 | 15/15 | 4/15 | 64 | 15/4 | 30/15 | 1.5 | 0.5 |

Note1: Δ_{ACK} , Δ_{NACK} and $\Delta_{CQI} = 8 \Leftrightarrow A_{hs} = \beta_{hs}/\beta_c = 30/15 \Leftrightarrow \beta_{hs} = 30/15 * \beta_c$
 Note2: CM=1 for $\beta_c/\beta_d = 12/15$, $\beta_{hs}/\beta_c = 24/15$.
 Note3: For subtest 2 the β_c/β_d ratio of 12/15 for the TFC during the measurement period (TF1, TF0) is achieved by setting the signaled gain factors for the reference TFC (TFC1, TF1) to $\beta_c = 11/15$ and $\beta_d = 15/15$.

HSUPA Test Configuration

The 3G SAR test reduction procedure is applied to HSPA (HSUPA/HSDPA with RMC) body-worn accessory configurations with 12.2 kbps RMC as the primary mode. Otherwise, SAR is measured for HSPA using the HSPA body SAR procedures in the "Release 6 HSPA Data Devices" section of this document, for the highest reported body-worn accessory exposure SAR configuration in 12.2 kbps RMC. When VOIP is applicable for next to the ear head exposure in HSPA, the 3G SAR test reduction procedure is applied to HSPA with 12.2 kbps RMC as the primary mode; otherwise, the same HSPA configuration used for body-worn accessory measurements is tested for next to the ear head exposure.

Due to inner loop power control requirements in HSPA, a communication test set is required for output power and SAR tests. The 12.2 kbps RMC, FRC H-set 1 and E-DCH configurations for HSPA are configured according to the β values indicated in Table 2 and other applicable procedures described in the 'WCDMA Handset' and 'Release 5 HSDPA Data Devices' sections of this document

Table 3: Sub-Test 5 Setup for Release 6 HSUPA

| Sub-set | β_c | β_d | β_d (SF) | β_c/β_d | $\beta_{hs}^{(1)}$ | β_{ec} | β_{ed} | β_{ed} (SF) | β_{ed} (codes) | CM ⁽²⁾ (dB) | MPR (dB) | AG ⁽⁴⁾ Index | E-TFCI |
|---------|----------------------|----------------------|----------------|----------------------|--------------------|--------------|--|-------------------|----------------------|------------------------|----------|-------------------------|--------|
| 1 | 11/15 ⁽³⁾ | 15/15 ⁽³⁾ | 64 | 11/15 ⁽³⁾ | 22/15 | 209/225 | 1039/225 | 4 | 1 | 1.0 | 0.0 | 20 | 75 |
| 2 | 6/15 | 15/15 | 64 | 6/15 | 12/15 | 12/15 | 94/75 | 4 | 1 | 3.0 | 2.0 | 12 | 67 |
| 3 | 15/15 | 9/15 | 64 | 15/9 | 30/15 | 30/15 | $\beta_{ed1}: 47/15$ $\beta_{ed2}: 47/15$ | 4 | 2 | 2.0 | 1.0 | 15 | 92 |
| 4 | 2/15 | 15/15 | 64 | 2/15 | 4/15 | 2/15 | 56/75 | 4 | 1 | 3.0 | 2.0 | 17 | 71 |
| 5 | 15/15 ⁽⁴⁾ | 15/15 ⁽⁴⁾ | 64 | 15/15 ⁽⁴⁾ | 30/15 | 24/15 | 134/15 | 4 | 1 | 1.0 | 0.0 | 21 | 81 |

Note 1: Δ_{ACK} , Δ_{NACK} and $\Delta_{CQI} = 8 \Leftrightarrow A_{hs} = \beta_{hs}/\beta_c = 30/15 \Leftrightarrow \beta_{hs} = 30/15 * \beta_c$.
 Note 2: CM = 1 for $\beta_c/\beta_d = 12/15$, $\beta_{hs}/\beta_c = 24/15$. For all other combinations of DPDCH, DPCCH, HS-DPCCH, E-DPDCH and E-DPCCH the MPR is based on the relative CM difference.
 Note 3: For subtest 1 the β_c/β_d ratio of 11/15 for the TFC during the measurement period (TF1, TF0) is achieved by setting the signaled gain factors for the reference TFC (TF1, TF1) to $\beta_c = 10/15$ and $\beta_d = 15/15$.
 Note 4: For subtest 5 the β_c/β_d ratio of 15/15 for the TFC during the measurement period (TF1, TF0) is achieved by setting the signaled gain factors for the reference TFC (TF1, TF1) to $\beta_c = 14/15$ and $\beta_d = 15/15$.
 Note 5: Testing UE using E-DPDCH Physical Layer category 1 Sub-test 3 is not required according to TS 25.306 Figure 5.1g.
 Note 6: β_{ed} can not be set directly; it is set by Absolute Grant Value.

3.11.4 LTE Test Configuration

QPSK with 1 RB allocation

Start with the largest channel bandwidth and measure SAR for QPSK with 1 RB allocation, using the RB offset and required test channel combination with the highest maximum output power among RB offsets at the upper edge, middle and lower edge of each required test channel. When the reported SAR is ≤ 0.8 W/kg, testing of the remaining RB offset configurations and required test channels is not required for 1 RB allocation; otherwise, SAR is required for the remaining required test channels and only for the RB offset configuration with the highest output power for that channel.⁸ When the reported SAR of a required test channel is > 1.45 W/kg, SAR is required for all three RB offset configurations for that required test channel.

QPSK with 50% RB allocation

The procedures required for 1 RB allocation in section 4.2.1 are applied to measure the SAR for QPSK with 50% RB allocation.⁹

QPSK with 100% RB allocation

For QPSK with 100% RB allocation, SAR is not required when the highest maximum output power for 100 % RB allocation is less than the highest maximum output power in 50% and 1 RB allocations and the highest reported SAR for 1 RB and 50% RB allocation in sections 4.2.1 and 4.2.2 are ≤ 0.8 W/kg. Otherwise, SAR is measured for the highest output power channel; and if the reported SAR is > 1.45 W/kg, the remaining required test channels must also be tested.

3.11.5WIFI Test Configuration

The SAR measurement and test reduction procedures are structured according to either the DSSS or OFDM transmission mode configurations used in each standalone frequency band and aggregated band. For devices that operate in exposure configurations that require multiple test positions, additional SAR test reduction may be applied. The maximum output power specified for production units, including tune-up tolerance, are used to determine initial SAR test requirements for the 802.11 transmission modes in a frequency band. SAR is measured using the highest measured maximum output power channel for the initial test configuration. SAR measurement and test reduction for the remaining 802.11 modes and test channels are determined according to measured or specified maximum output power and reported SAR of the initial measurements. The general test reduction and SAR measurement approaches are summarized in the following:

1. The maximum output power specified for production units are determined for all applicable 802.11 transmission modes in each standalone and aggregated frequency band. Maximum output power is measured for the highest maximum output power configuration(s) in each frequency band according to the default power measurement procedures.
2. For OFDM transmission configurations in the 2.4 GHz and 5 GHz bands, an "initial test configuration" is first determined for each standalone and aggregated frequency band according to the maximum output power and tune-up tolerance specified for production units.
 - a. When the same maximum power is specified for multiple transmission modes in a frequency band, the largest channel bandwidth, lowest order modulation, lowest data rate and lowest order 802.11a/g/n/ac mode is used for SAR measurement, on the highest measured output power channel in the initial test configuration, for each frequency band.
 - b. SAR is measured for OFDM configurations using the initial test configuration procedures. Additional frequency band specific SAR test reduction may be considered for individual frequency bands
 - c. Depending on the reported SAR of the highest maximum output power channel tested in the initial test configuration, SAR test reduction may apply to subsequent highest output channels in the initial test configuration to reduce the number of SAR measurements.
3. The Initial test configuration does not apply to DSSS. The 2.4 GHz band SAR test requirements and 802.11b DSSS procedures are used to establish the transmission configurations required for SAR measurement.
4. An "initial test position" is applied to further reduce the number of SAR tests for devices operating in next to the ear, UMPC mini-tablet or hotspot mode exposure configurations that require multiple test positions .
 - a. SAR is measured for 802.11b according to the 2.4 GHz DSSS procedure using the exposure condition established by the initial test position.
 - b. SAR is measured for 2.4 GHz and 5 GHz OFDM configurations using the initial test configuration. 802.11b/g/n operating modes are tested independently according to the service requirements in each frequency band. 802.11b/g/n modes are tested on the maximum average output channel.
5. The Initial test position does not apply to devices that require a fixed exposure test position. SAR is measured in a fixed exposure test position for these devices in 802.11b according to the 2.4 GHz DSSS procedure or in 2.4 GHz and 5 GHz OFDM configurations using the initial test configuration procedures .
6. The "subsequent test configuration" procedures are applied to determine if additional SAR measurements are required for the remaining OFDM transmission modes that have not been tested in the initial test configuration. SAR test exclusion is determined according to reported SAR in the initial test configuration and maximum output power specified or measured for these other OFDM configurations.

2.4 GHz and 5GHz SAR Procedures

Separate SAR procedures are applied to DSSS and OFDM configurations in the 2.4 GHz band to simplify DSSS test requirements. For 802.11b DSSS SAR measurements, DSSS SAR procedure applies to fixed exposure test position and initial test position procedure applies to multiple exposure test positions. When SAR measurement is required for an OFDM configuration, the initial test configuration, subsequent test configuration and initial test position procedures are applied. The SAR test exclusion requirements for 802.11g/n OFDM configurations are described in section 5.2.2.

1. 802.11b DSSS SAR Test Requirements

SAR is measured for 2.4 GHz 802.11b DSSS using either a fixed test position or, when applicable, the initial test position procedure. SAR test reduction is determined according to the following:

- a. When the reported SAR of the highest measured maximum output power channel (section 3.1) for the exposure configuration is ≤ 0.8 W/kg, no further SAR testing is required for 802.11b DSSS in that exposure configuration.
- b. When the reported SAR is > 0.8 W/kg, SAR is required for that exposure configuration using the next highest measured output power channel. When any reported SAR is > 1.2 W/kg, SAR is required for the third channel; i.e., all channels require testing.

1. 2.4 GHz 802.11g/n OFDM SAR Test Exclusion Requirements

When SAR measurement is required for 2.4 GHz 802.11g/n OFDM configurations, the measurement and test reduction procedures for OFDM are applied (section 5.3). SAR is not required for the following 2.4 GHz OFDM conditions.

- a. When KDB Publication 447498 SAR test exclusion applies to the OFDM configuration
- b. When the highest reported SAR for DSSS is adjusted by the ratio of OFDM to DSSS specified maximum output power and the adjusted SAR is ≤ 1.2 W/kg.

2. SAR Test Requirements for OFDM Configurations

When SAR measurement is required for 802.11 a/g/n/ac OFDM configurations, each standalone and frequency aggregated band is considered separately for SAR test reduction. When the same transmitter and antenna(s) are used for U-NII-1 and U-NII-2A bands, additional SAR test reduction applies. When band gap channels between U-NII-2C band and 5.8 GHz U-NII-3 or §15.247 band are supported, the highest maximum output power transmission mode configuration and maximum output power channel across the bands must be used to determine SAR test reduction, according to the initial test configuration and subsequent test configuration requirements.²⁰ In applying the initial test configuration and subsequent test configuration procedures, the 802.11 transmission configuration with the highest specified maximum output power and the channel within a test configuration with the highest measured maximum output power should be clearly distinguished to apply the procedures.

3. OFDM Transmission Mode SAR Test Configuration and Channel Selection Requirements

The initial test configuration for 2.4 GHz and 5 GHz OFDM transmission modes is determined by the 802.11 configuration with the highest maximum output power specified for production units, including tune-up tolerance, in each standalone and aggregated frequency band. SAR for the initial test configuration is measured using the highest maximum output power channel determined by the default power measurement procedures (section 4). When multiple configurations in a frequency band have the same specified maximum output power, the initial test configuration is determined according to the following steps applied sequentially.

- a. The largest channel bandwidth configuration is selected among the multiple configurations with the same specified maximum output power.
- b. If multiple configurations have the same specified maximum output power and largest channel bandwidth, the lowest order modulation among the largest channel bandwidth configurations is selected.
- c. If multiple configurations have the same specified maximum output power, largest channel bandwidth and lowest order modulation, the lowest data rate configuration among these configurations is selected.
- d. When multiple transmission modes (802.11a/g/n/ac) have the same specified maximum output power, largest channel bandwidth, lowest order modulation and lowest data rate, the lowest order 802.11 mode is selected; i.e., 802.11a is chosen over 802.11n then 802.11ac or 802.11g is chosen over 802.11n.

After an initial test configuration is determined, if multiple test channels have the same measured maximum output power, the channel chosen for SAR measurement is determined according to the following. These channel selection procedures apply to both the initial test configuration and subsequent test configuration(s), with respect to the default power measurement procedures or additional power measurements required for further SAR test reduction. The same procedures also apply to subsequent highest output power channel(s) selection.

- a. Channels with measured maximum output power within $\frac{1}{4}$ dB of each other are considered to have the same maximum output.
- b. When there are multiple test channels with the same measured maximum output power, the channel closest to mid-band frequency is selected for SAR measurement.
- c. When there are multiple test channels with the same measured maximum output power and equal separation from mid-band frequency; for example, high and low channels or two mid-band channels, the higher frequency (number) channel is selected for SAR measurement.

Initial Test Configuration Procedures

An initial test configuration is determined for OFDM transmission modes according to the channel bandwidth, modulation and data rate combination(s) with the highest maximum output power specified for production units in each standalone and aggregated frequency band. SAR is measured using the highest measured maximum output power channel. For configurations with the same specified or measured maximum output power, additional transmission mode and test channel selection procedures are required (see section 5.3.2). SAR test reduction of subsequent highest output test channels is based on the reported SAR of the initial test configuration. For next to the ear, hotspot mode and UMC mini-tablet exposure configurations where multiple test positions are required, the initial test position procedure is applied to minimize the number of test positions required for SAR measurement using the initial test configuration transmission mode.²³ For fixed exposure conditions that do not have multiple SAR test positions, SAR is measured in the transmission mode determined by the initial test configuration. When the reported SAR of the initial test configuration is > 0.8 W/kg, SAR measurement is required for the subsequent next highest measured output power channel(s) in the initial test configuration until the reported SAR is ≤ 1.2 W/kg or all required channels are tested.

4. Subsequent Test Configuration Procedures

SAR measurement requirements for the remaining 802.11 transmission mode configurations that have not been tested in the initial test configuration are determined separately for each standalone and aggregated frequency band, in each exposure condition, according to the maximum output power specified for production units. The initial test position procedure is applied to next to the ear, UMPC mini-tablet and hotspot mode configurations. When the same maximum output power is specified for multiple transmission modes, the procedures in section 5.3.2 are applied to determine the test configuration. Additional power measurements may be required to determine if SAR measurements are required for subsequent highest output power channels in a subsequent test configuration. The subsequent test configuration and SAR measurement procedures are described in the following.

- a. When SAR test exclusion provisions of KDB Publication 447498 are applicable and SAR measurement is not required for the initial test configuration, SAR is also not required for the next highest maximum output power transmission mode subsequent test configuration(s) in that frequency band or aggregated band and exposure configuration.
- b. When the highest reported SAR for the initial test configuration (when applicable, include subsequent highest output channels), according to the initial test position or fixed exposure position requirements, is adjusted by the ratio of the subsequent test configuration to initial test configuration specified maximum output power and the adjusted SAR is ≤ 1.2 W/kg, SAR is not required for that subsequent test configuration.
- c. The number of channels in the initial test configuration and subsequent test configuration can be different due to differences in channel bandwidth. When SAR measurement is required for a subsequent test configuration and the channel bandwidth is smaller than that in the initial test configuration, all channels in the subsequent test configuration that overlap with the larger bandwidth channel tested in the initial test configuration should be used to determine the highest maximum output power channel. This step requires additional power measurement to identify the highest maximum output power channel in the subsequent test configuration to determine SAR test reduction.
 - 1). SAR should first be measured for the channel with highest measured output power in the subsequent test configuration.
 - 2). SAR for subsequent highest measured maximum output power channels in the subsequent test configuration is required only when the reported SAR of the preceding higher maximum output power channel(s) in the subsequent test configuration is > 1.2 W/kg or until all required channels are tested.
 - a) For channels with the same measured maximum output power, SAR should be measured using the channel closest to the center frequency of the larger channel bandwidth channel in the initial test configuration.
 - d. SAR measurements for the remaining highest specified maximum output power OFDM transmission mode configurations that have not been tested in the initial test configuration (highest maximum output) or subsequent test configuration(s) (subsequent next highest maximum output power) is determined by applying the subsequent test configuration procedures in this section to the remaining configurations according to the following:
 - 1) replace “subsequent test configuration” with “next subsequent test configuration” (i.e., subsequent next highest specified maximum output power configuration)
 - 2) replace “initial test configuration” with “all tested higher output power configurations.

3.12. Power Reduction

The product without any power reduction.

3.13. Power Drift

To control the output power stability during the SAR test, SAR system calculates the power drift by measuring the E-field at the same location at the beginning and at the end of the measurement for each test position. This ensures that the power drift during one measurement is within 5%.

4. TEST CONDITIONS AND RESULTS

4.1. Conducted Power Results

Max Conducted power measurement results and power drift from tune-up tolerance provide by manufacturer:

Conducted power measurement results for GSM850/PCS1900<SIM1>

| GSM 850 | | Burst Conducted power (dBm) | | | / | Average power (dBm) | | |
|-----------------|-----------------|-----------------------------|--------------|----------------|----------------|------------------------|--------------|----------------|
| | | Channel/Frequency(MHz) | | | | Channel/Frequency(MHz) | | |
| | | 128/824.2 | 190/836.6 | 251/848.8 | | 128/824.2 | 190/836.6 | 251/848.8 |
| GSM | | 32.69 | 32.68 | 32.68 | -9.03dB | 23.66 | 23.65 | 23.65 |
| GPRS (GMSK) | 1TX slot | 32.52 | 32.56 | 32.49 | -9.03dB | 23.49 | 23.53 | 23.46 |
| | 2TX slot | 31.02 | 31.00 | 30.99 | -6.02dB | 25.00 | 24.98 | 24.97 |
| | 3TX slot | 29.50 | 29.48 | 29.50 | -4.26dB | 25.24 | 25.22 | 25.24 |
| | 4TX slot | 28.02 | 28.01 | 27.98 | -3.01dB | 25.01 | 25.00 | 24.97 |
| EGPRS (8PSK) | 1TX slot | 26.00 | 26.02 | 26.00 | -9.03dB | 16.97 | 16.99 | 16.97 |
| | 2TX slot | 24.48 | 24.51 | 24.47 | -6.02dB | 18.46 | 18.49 | 18.45 |
| | 3TX slot | 22.98 | 22.99 | 22.99 | -4.26dB | 18.72 | 18.73 | 18.73 |
| | 4TX slot | 21.52 | 21.49 | 21.47 | -3.01dB | 18.51 | 18.48 | 18.46 |
| GSM 1900 | | Burst Conducted power (dBm) | | | / | Average power (dBm) | | |
| | | Channel/Frequency(MHz) | | | | Channel/Frequency(MHz) | | |
| | | 512/ 1850.2 | 661/ 1880 | 810/ 1909.8 | | 512/ 1850.2 | 661/ 1880 | 810/ 1909.8 |
| GSM | | 29.67 | 29.63 | 29.65 | -9.03dB | 20.64 | 20.60 | 20.62 |
| GPRS (GMSK) | 1TX slot | 29.56 | 29.55 | 29.52 | -9.03dB | 20.53 | 20.52 | 20.49 |
| | 2TX slot | 27.99 | 28.00 | 27.97 | -6.02dB | 21.97 | 21.98 | 21.95 |
| | 3TX slot | 26.49 | 26.47 | 26.50 | -4.26dB | 22.23 | 22.21 | 22.24 |
| | 4TX slot | 24.99 | 25.01 | 24.97 | -3.01dB | 21.98 | 22.00 | 21.96 |
| EGPRS (8PSK) | 1TX slot | 25.49 | 25.53 | 25.50 | -9.03dB | 16.46 | 16.50 | 16.47 |
| | 2TX slot | 24.02 | 23.99 | 23.97 | -6.02dB | 18.00 | 17.97 | 17.95 |
| | 3TX slot | 22.51 | 22.51 | 22.51 | -4.26dB | 18.25 | 18.25 | 18.25 |
| | 4TX slot | 21.02 | 21.01 | 20.97 | -3.01dB | 18.01 | 18.00 | 17.96 |

Conducted power measurement results for GSM850/PCS1900<SIM2>

| GSM 850 | | Burst Conducted power (dBm) | | | / | Average power (dBm) | | |
|-----------------|-----------------|-----------------------------|--------------|----------------|----------------|------------------------|--------------|----------------|
| | | Channel/Frequency(MHz) | | | | Channel/Frequency(MHz) | | |
| | | 128/824.2 | 190/836.6 | 251/848.8 | | 128/824.2 | 190/836.6 | 251/848.8 |
| GSM | | 32.35 | 32.34 | 32.34 | -9.03dB | 23.32 | 23.31 | 23.31 |
| GPRS (GMSK) | 1TX slot | 32.18 | 32.22 | 32.15 | -9.03dB | 23.15 | 23.19 | 23.12 |
| | 2TX slot | 30.69 | 30.67 | 30.66 | -6.02dB | 24.67 | 24.65 | 24.64 |
| | 3TX slot | 29.19 | 29.17 | 29.19 | -4.26dB | 24.93 | 24.91 | 24.93 |
| | 4TX slot | 27.73 | 27.72 | 27.69 | -3.01dB | 24.72 | 24.71 | 24.68 |
| EGPRS (8PSK) | 1TX slot | 25.73 | 25.75 | 25.73 | -9.03dB | 16.70 | 16.72 | 16.70 |
| | 2TX slot | 24.22 | 24.25 | 24.21 | -6.02dB | 18.20 | 18.23 | 18.19 |
| | 3TX slot | 22.74 | 22.75 | 22.75 | -4.26dB | 18.48 | 18.49 | 18.49 |
| | 4TX slot | 21.29 | 21.26 | 21.24 | -3.01dB | 18.28 | 18.25 | 18.23 |
| GSM 1900 | | Burst Conducted power (dBm) | | | / | Average power (dBm) | | |
| | | Channel/Frequency(MHz) | | | | Channel/Frequency(MHz) | | |
| | | 512/ 1850.2 | 661/ 1880 | 810/ 1909.8 | | 512/ 1850.2 | 661/ 1880 | 810/ 1909.8 |
| GSM | | 29.36 | 29.32 | 29.34 | -9.03dB | 20.33 | 20.29 | 20.31 |
| GPRS (GMSK) | 1TX slot | 28.98 | 28.97 | 29.00 | -9.03dB | 19.95 | 19.94 | 19.97 |
| | 2TX slot | 27.49 | 27.50 | 27.49 | -6.02dB | 21.47 | 21.48 | 21.47 |
| | 3TX slot | 26.03 | 26.04 | 26.04 | -4.26dB | 21.77 | 21.78 | 21.78 |
| | 4TX slot | 24.56 | 24.56 | 24.57 | -3.01dB | 21.55 | 21.55 | 21.56 |
| EGPRS (8PSK) | 1TX slot | 25.03 | 25.05 | 25.05 | -9.03dB | 16.00 | 16.02 | 16.02 |
| | 2TX slot | 23.54 | 23.56 | 23.56 | -6.02dB | 17.52 | 17.54 | 17.54 |
| | 3TX slot | 22.04 | 22.07 | 22.04 | -4.26dB | 17.78 | 17.81 | 17.78 |
| | 4TX slot | 20.57 | 20.59 | 20.56 | -3.01dB | 17.56 | 17.58 | 17.55 |

Notes:

1. Division Factors

To average the power, the division factor is as follows:

1TX-slot = 1 transmit time slot out of 8 time slots=> conducted power divided by (8/1) => -9.00dB

2TX-slots = 2 transmit time slots out of 8 time slots=> conducted power divided by (8/2) => -6.00dB

3TX-slots = 3 transmit time slots out of 8 time slots=> conducted power divided by (8/3) => -4.26dB

4TX-slots = 4 transmit time slots out of 8 time slots=> conducted power divided by (8/4) => -3.00dB

2. According to the conducted power as above, the GPRS measurements are performed with 3Txslot for GPRS850 and 3TxslotGPRS1900.

3. We will only measured SAR at SIM1 as power higher than SIM2;

Conducted Power Measurement Results(WCDMA Band II/V)

| Item | Band | FDD Band V result (dBm) | | | FDD Band II result (dBm) | | |
|-------|--------------|-------------------------|----------------|----------------|--------------------------|---------------|-----------------|
| | | Test Channel | | | Test Channel | | |
| | | 4132/ 826.4 | 4183/ 836.6 | 4233/ 846.6 | 9262/ 1852.4 | 9400/ 1880 | 9538/ 1907.6 |
| RMC | 12.2kbps RMC | 23.57 | 23.43 | 23.52 | 23.56 | 23.51 | 23.60 |
| | 64kbps RMC | 23.55 | 23.42 | 23.48 | 23.53 | 23.47 | 23.58 |
| | 144kbps RMC | 23.49 | 23.37 | 23.38 | 23.46 | 23.36 | 23.48 |
| | 384kbps RMC | 23.39 | 23.28 | 23.29 | 23.33 | 23.27 | 23.38 |
| HSDPA | Subtest 1 | 22.84 | 22.71 | 22.88 | 22.88 | 22.99 | 22.85 |
| | Subtest 2 | 22.86 | 22.89 | 22.77 | 22.86 | 22.87 | 22.88 |
| | Subtest 3 | 22.86 | 22.80 | 22.87 | 22.83 | 22.75 | 22.86 |
| | Subtest 4 | 22.87 | 22.79 | 22.82 | 22.77 | 22.77 | 22.85 |
| HSUPA | Subtest 1 | 22.72 | 22.90 | 22.84 | 22.76 | 22.90 | 22.82 |
| | Subtest 2 | 22.81 | 22.71 | 22.76 | 22.81 | 22.87 | 22.73 |
| | Subtest 3 | 22.71 | 22.81 | 22.78 | 22.79 | 22.80 | 22.79 |
| | Subtest 4 | 22.78 | 22.82 | 22.88 | 22.74 | 22.77 | 22.89 |
| | Subtest 5 | 22.77 | 22.84 | 22.83 | 22.77 | 22.77 | 22.88 |

Note:When the maximum output power and tune-up tolerance specified for production units in a secondary mode is $\leq 1/2$ dB higher than the primary mode (RMC12.2kbps) or when the highest reported SAR of the primary mode is scaled by the ratio of specified maximum output power and tune-up tolerance of secondary to primary mode and the adjusted SAR is ≤ 1.2 W/kg, SAR measurement is not required for the secondary mode.

<WLAN 2.4GHz Conducted Power>

| Mode | Channel | Frequency (MHz) | Data rate (Mbps) | Average Output Power (dBm) |
|----------------------|---------|-----------------|------------------|----------------------------|
| IEEE 802.11b | 1 | 2412 | 1 | 13.30 |
| | | | 2 | 13.29 |
| | | | 5.5 | 13.27 |
| | | | 11 | 13.25 |
| | 6 | 2437 | 1 | 13.61 |
| | | | 2 | 13.60 |
| | | | 5.5 | 13.59 |
| | | | 11 | 13.57 |
| | 11 | 2462 | 1 | 13.25 |
| | | | 2 | 13.24 |
| | | | 5.5 | 13.22 |
| | | | 11 | 13.20 |
| IEEE 802.11g | 1 | 2412 | 6 | 13.00 |
| | | | 9 | 12.97 |
| | | | 12 | 12.95 |
| | | | 18 | 12.94 |
| | | | 24 | 12.93 |
| | | | 36 | 12.92 |
| | | | 48 | 12.88 |
| | | | 54 | 12.76 |
| | 6 | 2437 | 6 | 13.42 |
| | | | 9 | 13.41 |
| | | | 12 | 13.40 |
| | | | 18 | 13.39 |
| | | | 24 | 13.37 |
| | | | 36 | 13.38 |
| | | | 48 | 13.36 |
| | | | 54 | 13.32 |
| | 11 | 2462 | 6 | 13.28 |
| | | | 9 | 13.27 |
| | | | 12 | 13.26 |
| | | | 18 | 13.25 |
| | | | 24 | 13.24 |
| | | | 36 | 13.23 |
| | | | 48 | 13.22 |
| | | | 54 | 13.21 |
| IEEE 802.11n HT20 | 1 | 2412 | MCS0 | 12.88 |
| | | | MCS1 | 12.86 |
| | | | MCS2 | 12.84 |
| | | | MCS3 | 12.83 |
| | | | MCS4 | 12.81 |
| | | | MCS5 | 12.80 |
| | | | MCS6 | 12.76 |
| | | | MCS7 | 12.75 |
| | 6 | 2437 | MCS0 | 13.13 |
| | | | MCS1 | 13.11 |
| | | | MCS2 | 13.10 |
| | | | MCS3 | 12.99 |
| | | | MCS4 | 12.97 |
| | | | MCS5 | 12.95 |
| | | | MCS6 | 12.94 |
| | | | MCS7 | 12.85 |
| | 11 | 2462 | MCS0 | 12.71 |
| | | | MCS1 | 12.69 |
| | | | MCS2 | 12.68 |
| | | | MCS3 | 12.67 |

| | | | | |
|----------------------|---|------|------|-------|
| | | | MCS4 | 12.63 |
| | | | MCS5 | 12.62 |
| | | | MCS6 | 12.60 |
| | | | MCS7 | 12.59 |
| IEEE 802.11n HT40 | 3 | 2422 | MCS0 | 12.57 |
| | | | MCS1 | 12.56 |
| | | | MCS2 | 12.53 |
| | | | MCS3 | 12.50 |
| | | | MCS4 | 12.49 |
| | | | MCS5 | 12.48 |
| | | | MCS6 | 12.47 |
| | 6 | 2437 | MCS7 | 12.46 |
| | | | MCS0 | 12.39 |
| | | | MCS1 | 12.35 |
| | | | MCS2 | 12.33 |
| | | | MCS3 | 12.30 |
| | | | MCS4 | 12.29 |
| | | | MCS5 | 12.27 |
| | 9 | 2452 | MCS6 | 12.25 |
| | | | MCS7 | 12.23 |
| | | | MCS0 | 12.79 |
| | | | MCS1 | 12.75 |
| | | | MCS2 | 12.70 |
| | | | MCS3 | 12.69 |
| | | | MCS4 | 12.68 |
| | | | MCS5 | 12.65 |
| | | | MCS6 | 12.63 |
| | | | MCS7 | 12.60 |

Note:SAR is not required for the following 2.4 GHz OFDM conditions as the highest reported SAR for DSSS is adjusted by the ratio of OFDM to DSSS specified maximum output power and the adjusted SAR is ≤ 1.2 W/kg.

<BT Conducted Power>

| Mode | channel | Frequency (MHz) | Conducted AVG output power (dBm) |
|-----------|---------|-----------------|----------------------------------|
| GFSK-BLE | 0 | 2402 | -5.979 |
| | 19 | 2440 | -4.851 |
| | 39 | 2480 | -4.783 |
| GFSK | 0 | 2402 | 1.776 |
| | 39 | 2441 | 2.028 |
| | 78 | 2480 | 2.733 |
| π/4-DQPSK | 0 | 2402 | 0.412 |
| | 39 | 2441 | 1.405 |
| | 78 | 2480 | 2.173 |
| 8DPSK | 0 | 2402 | 0.422 |
| | 39 | 2441 | 1.419 |
| | 78 | 2480 | 2.159 |

Per KDB 447498 D01v06, the 1-g and 10-g SAR test exclusion thresholds for 100 MHz to 6 GHz at test separation distances ≤ 50 mm are determined by:

$$[(\text{max. power of channel, including tune-up tolerance, mW}) / (\text{min. test separation distance, mm})] \cdot [\sqrt{f(\text{GHz})}] \leq 3.0$$

for 1-g SAR and ≤ 7.5 for 10-g extremity SAR

- f(GHz) is the RF channel transmit frequency in GHz
- Power and distance are rounded to the nearest mW and mm before calculation
- The result is rounded to one decimal place for comparison

| Bluetooth Turn up Power (dBm) | Separation Distance (mm) | Frequency (GHz) | Exclusion Thresholds |
|-------------------------------|--------------------------|-----------------|----------------------|
| 3.0 | 5 | 2.45 | 0.6 |

Per KDB 447498 D01v06, when the minimum test separation distance is < 5 mm, a distance of 5 mm is applied to determine SAR test exclusion. The test exclusion threshold is 0.5< 3.0, SAR testing is not required.

4.2. Manufacturing tolerance

GSM Speech<SIM1>

| GSM 850 (GMSK) (Burst Average Power) | | | |
|---------------------------------------|-------------|-------------|-------------|
| Channel | Channel 128 | Channel 190 | Channel 251 |
| Target (dBm) | 32.0 | 32.0 | 32.0 |
| Tolerance ±(dB) | 1.0 | 1.0 | 1.0 |
| GSM 1900 (GMSK) (Burst Average Power) | | | |
| Channel | Channel 512 | Channel 661 | Channel 810 |
| Target (dBm) | 29.0 | 29.0 | 29.0 |
| Tolerance ±(dB) | 1.0 | 1.0 | 1.0 |

| GSM 850 GPRS (GMSK) (Burst Average Power) | | | | |
|--|-----------------|------|------|------|
| Channel | | 128 | 190 | 251 |
| 1 Txslot | Target (dBm) | 32.0 | 32.0 | 32.0 |
| | Tolerance ±(dB) | 1.0 | 1.0 | 1.0 |
| 2 Txslot | Target (dBm) | 31.0 | 30.0 | 30.0 |
| | Tolerance ±(dB) | 1.0 | 1.0 | 1.0 |
| 3 Txslot | Target (dBm) | 28.0 | 28.0 | 29.0 |
| | Tolerance ±(dB) | 1.0 | 1.0 | 1.0 |
| 4 Txslot | Target (dBm) | 27.0 | 27.0 | 27.0 |
| | Tolerance ±(dB) | 1.0 | 1.0 | 1.0 |
| GSM 850 EDGE (8PSK) (Burst Average Power) | | | | |
| Channel | | 128 | 190 | 251 |
| 1 Txslot | Target (dBm) | 25.0 | 26.0 | 25.0 |
| | Tolerance ±(dB) | 1.0 | 1.0 | 1.0 |
| 2 Txslot | Target (dBm) | 24.0 | 24.0 | 24.0 |
| | Tolerance ±(dB) | 1.0 | 1.0 | 1.0 |
| 3 Txslot | Target (dBm) | 22.0 | 22.0 | 22.0 |
| | Tolerance ±(dB) | 1.0 | 1.0 | 1.0 |
| 4 Txslot | Target (dBm) | 21.0 | 21.0 | 21.0 |
| | Tolerance ±(dB) | 1.0 | 1.0 | 1.0 |
| GSM 1900 GPRS (GMSK) (Burst Average Power) | | | | |
| Channel | | 512 | 661 | 810 |
| 1 Txslot | Target (dBm) | 29.0 | 29.0 | 29.0 |
| | Tolerance ±(dB) | 1.0 | 1.0 | 1.0 |
| 2 Txslot | Target (dBm) | 27.0 | 27.0 | 27.0 |
| | Tolerance ±(dB) | 1.0 | 1.0 | 1.0 |
| 3 Txslot | Target (dBm) | 26.0 | 26.0 | 26.0 |
| | Tolerance ±(dB) | 1.0 | 1.0 | 1.0 |
| 4 Txslot | Target (dBm) | 24.0 | 25.0 | 24.0 |
| | Tolerance ±(dB) | 1.0 | 1.0 | 1.0 |
| GSM 1900 EDGE (8PSK) (Burst Average Power) | | | | |
| Channel | | 512 | 661 | 810 |
| 1 Txslot | Target (dBm) | 25.0 | 25.0 | 25.0 |
| | Tolerance ±(dB) | 1.0 | 1.0 | 1.0 |
| 2 Txslot | Target (dBm) | 24.0 | 23.0 | 23.0 |
| | Tolerance ±(dB) | 1.0 | 1.0 | 1.0 |
| 3 Txslot | Target (dBm) | 22.0 | 22.0 | 22.0 |
| | Tolerance ±(dB) | 1.0 | 1.0 | 1.0 |
| 4 Txslot | Target (dBm) | 21.0 | 21.0 | 20.0 |
| | Tolerance ±(dB) | 1.0 | 1.0 | 1.0 |

GSM Speech<SIM2>

| GSM 850 (GMSK) (Burst Average Power) | | | |
|--|-------------|-------------|-------------|
| Channel | Channel 128 | Channel 190 | Channel 251 |
| Target (dBm) | 32.0 | 32.0 | 32.0 |
| Tolerance ±(dB) | 1.0 | 1.0 | 1.0 |
| GSM 1900 (GMSK) (Burst Average Power) | | | |
| Channel | Channel 810 | Channel 661 | Channel 512 |
| Target (dBm) | 29.0 | 29.0 | 29.0 |
| Tolerance ±(dB) | 1.0 | 1.0 | 1.0 |

| GSM 850 GPRS (GMSK) (Burst Average Power) | | | | |
|---|-----------------|------|------|------|
| Channel | | 128 | 190 | 251 |
| 1 Txslot | Target (dBm) | 32.0 | 32.0 | 32.0 |
| | Tolerance ±(dB) | 1.0 | 1.0 | 1.0 |
| 2 Txslot | Target (dBm) | 30.0 | 30.0 | 30.0 |
| | Tolerance ±(dB) | 1.0 | 1.0 | 1.0 |
| 3 Txslot | Target (dBm) | 29.0 | 29.0 | 29.0 |
| | Tolerance ±(dB) | 1.0 | 1.0 | 1.0 |
| 4 Txslot | Target (dBm) | 27.0 | 27.0 | 27.0 |
| | Tolerance ±(dB) | 1.0 | 1.0 | 1.0 |
| GSM 850 EDGE (8PSK) (Burst Average Power) | | | | |
| Channel | | 128 | 190 | 251 |
| 1 Txslot | Target (dBm) | 25.0 | 25.0 | 25.0 |
| | Tolerance ±(dB) | 1.0 | 1.0 | 1.0 |
| 2 Txslot | Target (dBm) | 23.0 | 23.0 | 23.0 |
| | Tolerance ±(dB) | 1.0 | 1.0 | 1.0 |
| 3 Txslot | Target (dBm) | 22.0 | 22.0 | 22.0 |
| | Tolerance ±(dB) | 1.0 | 1.0 | 1.0 |
| 4 Txslot | Target (dBm) | 21.0 | 21.0 | 21.0 |
| | Tolerance ±(dB) | 1.0 | 1.0 | 1.0 |
| GSM 1900 GPRS (GMSK) (Burst Average Power) | | | | |
| Channel | | 512 | 661 | 810 |
| 1 Txslot | Target (dBm) | 28.0 | 28.0 | 28.0 |
| | Tolerance ±(dB) | 1.0 | 1.0 | 1.0 |
| 2 Txslot | Target (dBm) | 27.0 | 27.0 | 27.0 |
| | Tolerance ±(dB) | 1.0 | 1.0 | 1.0 |
| 3 Txslot | Target (dBm) | 26.0 | 26.0 | 26.0 |
| | Tolerance ±(dB) | 1.0 | 1.0 | 1.0 |
| 4 Txslot | Target (dBm) | 24.0 | 24.0 | 24.0 |
| | Tolerance ±(dB) | 1.0 | 1.0 | 1.0 |
| GSM 1900 EDGE (8PSK) (Burst Average Power) | | | | |
| Channel | | 512 | 661 | 810 |
| 1 Txslot | Target (dBm) | 25.0 | 25.0 | 25.0 |
| | Tolerance ±(dB) | 1.0 | 1.0 | 1.0 |
| 2 Txslot | Target (dBm) | 23.0 | 23.0 | 23.0 |
| | Tolerance ±(dB) | 1.0 | 1.0 | 1.0 |
| 3 Txslot | Target (dBm) | 22.0 | 22.0 | 22.0 |
| | Tolerance ±(dB) | 1.0 | 1.0 | 1.0 |
| 4 Txslot | Target (dBm) | 20.0 | 20.0 | 20.0 |
| | Tolerance ±(dB) | 1.0 | 1.0 | 1.0 |

UMTS

| UMTSBand V | | | |
|--------------------------------------|--------------|--------------|--------------|
| Channel | Channel 4132 | Channel 4183 | Channel 4233 |
| Target (dBm) | 23.0 | 23.0 | 23.0 |
| Tolerance ±(dB) | 1.0 | 1.0 | 1.0 |
| UMTSBand V HSDPA(sub-test 1) | | | |
| Channel | Channel 4132 | Channel 4183 | Channel 4233 |
| Target (dBm) | 22.0 | 22.0 | 22.0 |
| Tolerance ±(dB) | 1.0 | 1.0 | 1.0 |
| UMTSBand V HSDPA(sub-test 2) | | | |
| Channel | Channel 4132 | Channel 4183 | Channel 4233 |
| Target (dBm) | 22.0 | 22.0 | 22.0 |
| Tolerance ±(dB) | 1.0 | 1.0 | 1.0 |
| UMTS Band V HSDPA(sub-test 3) | | | |
| Channel | Channel 4132 | Channel 4183 | Channel 4233 |
| Target (dBm) | 22.0 | 22.0 | 22.0 |
| Tolerance ±(dB) | 1.0 | 1.0 | 1.0 |
| UMTSBand V HSDPA(sub-test 4) | | | |
| Channel | Channel 4132 | Channel 4183 | Channel 4233 |
| Target (dBm) | 22.0 | 22.0 | 22.0 |
| Tolerance ±(dB) | 1.0 | 1.0 | 1.0 |
| UMTSBand V HSUPA(sub-test 1) | | | |
| Channel | Channel 4132 | Channel 4183 | Channel 4233 |
| Target (dBm) | 22.0 | 22.0 | 22.0 |
| Tolerance ±(dB) | 1.0 | 1.0 | 1.0 |
| UMTSBand V HSUPA(sub-test 2) | | | |
| Channel | Channel 4132 | Channel 4183 | Channel 4233 |
| Target (dBm) | 22.0 | 22.0 | 22.0 |
| Tolerance ±(dB) | 1.0 | 1.0 | 1.0 |
| UMTSBand V HSUPA(sub-test 3) | | | |
| Channel | Channel 4132 | Channel 4183 | Channel 4233 |
| Target (dBm) | 22.0 | 22.0 | 22.0 |
| Tolerance ±(dB) | 1.0 | 1.0 | 1.0 |
| UMTS Band V HSUPA(sub-test 4) | | | |
| Channel | Channel 4132 | Channel 4183 | Channel 4233 |
| Target (dBm) | 22.0 | 22.0 | 22.0 |
| Tolerance ±(dB) | 1.0 | 1.0 | 1.0 |
| UMTSBand V HSUPA(sub-test 5) | | | |
| Channel | Channel 4132 | Channel 4183 | Channel 4233 |
| Target (dBm) | 22.0 | 22.0 | 22.0 |
| Tolerance ±(dB) | 1.0 | 1.0 | 1.0 |

| UMTSBand II | | | |
|---------------------------------------|--------------|--------------|--------------|
| Channel | Channel 9262 | Channel 9400 | Channel 9538 |
| Target (dBm) | 23.0 | 23.0 | 23.0 |
| Tolerance ±(dB) | 1.0 | 1.0 | 1.0 |
| UMTSBand II HSDPA(sub-test 1) | | | |
| Channel | Channel 9262 | Channel 9400 | Channel 9538 |
| Target (dBm) | 22.0 | 22.0 | 22.0 |
| Tolerance ±(dB) | 1.0 | 1.0 | 1.0 |
| UMTS Band II HSDPA(sub-test 2) | | | |
| Channel | Channel 9262 | Channel 9400 | Channel 9538 |
| Target (dBm) | 22.0 | 22.0 | 22.0 |
| Tolerance ±(dB) | 1.0 | 1.0 | 1.0 |
| UMTSBand II HSDPA(sub-test 3) | | | |
| Channel | Channel 9262 | Channel 9400 | Channel 9538 |
| Target (dBm) | 22.0 | 22.0 | 22.0 |

| | | | |
|--------------------------------------|--------------|--------------|--------------|
| Tolerance ±(dB) | 1.0 | 1.0 | 1.0 |
| UMTSBand II HSDPA(sub-test 4) | | | |
| Channel | Channel 9262 | Channel 9400 | Channel 9538 |
| Target (dBm) | 22.0 | 22.0 | 22.0 |
| Tolerance ±(dB) | 1.0 | 1.0 | 1.0 |
| UMTSBand II HSUPA(sub-test 1) | | | |
| Channel | Channel 9262 | Channel 9400 | Channel 9538 |
| Target (dBm) | 22.0 | 22.0 | 22.0 |
| Tolerance ±(dB) | 1.0 | 1.0 | 1.0 |
| UMTSBand II HSUPA(sub-test 2) | | | |
| Channel | Channel 9262 | Channel 9400 | Channel 9538 |
| Target (dBm) | 22.0 | 22.0 | 22.0 |
| Tolerance ±(dB) | 1.0 | 1.0 | 1.0 |
| UMTSBand II HSUPA(sub-test 3) | | | |
| Channel | Channel 9262 | Channel 9400 | Channel 9538 |
| Target (dBm) | 22.0 | 22.0 | 22.0 |
| Tolerance ±(dB) | 1.0 | 1.0 | 1.0 |
| UMTSBand II HSUPA(sub-test 4) | | | |
| Channel | Channel 9262 | Channel 9400 | Channel 9538 |
| Target (dBm) | 22.0 | 22.0 | 22.0 |
| Tolerance ±(dB) | 1.0 | 1.0 | 1.0 |
| UMTSBand II HSUPA(sub-test 5) | | | |
| Channel | Channel 9262 | Channel 9400 | Channel 9538 |
| Target (dBm) | 22.0 | 22.0 | 22.0 |
| Tolerance ±(dB) | 1.0 | 1.0 | 1.0 |

WiFi 2.4G

| | | | |
|------------------------------------|-----------|-----------|------------|
| IEEE 802.11b (Average) | | | |
| Channel | Channel 1 | Channel 6 | Channel 11 |
| Target (dBm) | 13.0 | 13.0 | 13.0 |
| Tolerance ±(dB) | 1.0 | 1.0 | 1.0 |
| IEEE 802.11g (Average) | | | |
| Channel | Channel 1 | Channel 6 | Channel 11 |
| Target (dBm) | 12.0 | 13.0 | 13.0 |
| Tolerance ±(dB) | 1.0 | 1.0 | 1.0 |
| IEEE 802.11n HT20 (Average) | | | |
| Channel | Channel 1 | Channel 6 | Channel 11 |
| Target (dBm) | 12.0 | 13.0 | 12.0 |
| Tolerance ±(dB) | 1.0 | 1.0 | 1.0 |
| IEEE 802.11n HT40 (Average) | | | |
| Channel | Channel 3 | Channel 6 | Channel 9 |
| Target (dBm) | 12.0 | 12.0 | 12.0 |
| Tolerance ±(dB) | 1.0 | 1.0 | 1.0 |

| Bluetooth V4.1 | | | |
|--------------------|-----------|------------|------------|
| BLE-GFSK (Average) | | | |
| Channel | Channel 0 | Channel 19 | Channel 39 |
| Target (dBm) | -6.0 | -5.0 | -5.0 |
| Tolerance ±(dB) | 1.0 | 1.0 | 1.0 |
| GFSK (Average) | | | |
| Channel | Channel 0 | Channel 39 | Channel 78 |
| Target (dBm) | 1.0 | 2.0 | 2.0 |
| Tolerance ±(dB) | 1.0 | 1.0 | 1.0 |
| 8DPSK (Average) | | | |
| Channel | Channel 0 | Channel 39 | Channel 78 |
| Target (dBm) | 0.0 | 1.0 | 2.0 |
| Tolerance ±(dB) | 1.0 | 1.0 | 1.0 |
| π/4DQPSK (Average) | | | |
| Channel | Channel 0 | Channel 39 | Channel 78 |
| Target (dBm) | 0.0 | 1.0 | 2.0 |
| Tolerance ±(dB) | 1.0 | 1.0 | 1.0 |

4.3. Transmit Antennas and SAR Measurement Position

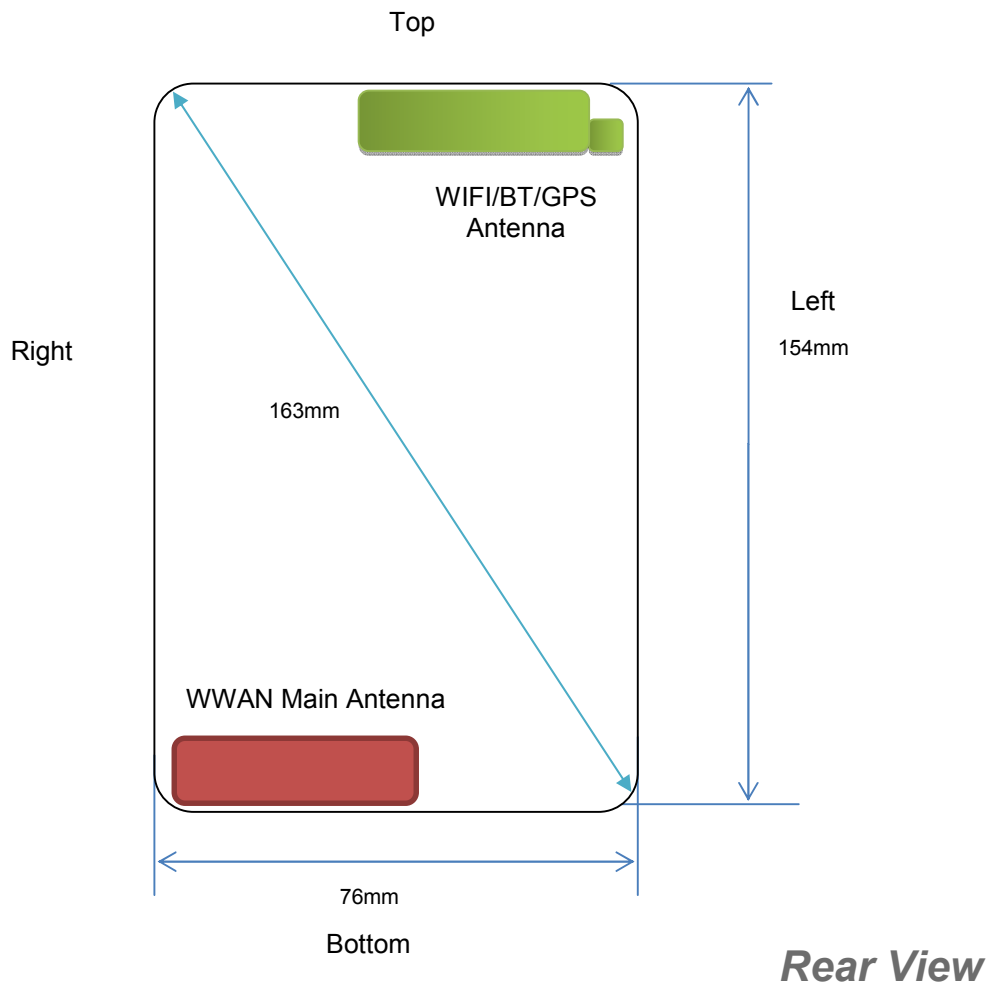

Antenna information:

| | |
|----------------------|--------------------|
| WWAN Main Antenna | GSM/UMTS/LTE TX/RX |
| LTEDiversity antenna | Only RX |
| WLAN/GPS/BT Antenna | WLAN/BT TX/RX |

Note:

1). Per KDB648474 D04, because the overall diagonal distance of this devices is 163mm>160mm, it is not considered as "Phablet" device.

- 2). Per KDB648474 D04, 10-g extremity SAR is not required when Body-Worn mode 1-g reported SAR < 1.2 W/Kg.
 3). According to the KDB941225 D06 Hot Spot SAR v02, the edges with less than 25 mm distance to the antennas need to be tested for SAR.

| Distance of The Antenna to the EUT surface and edge (mm) | | | | | | |
|--|-------|------|----------|-------------|-----------|------------|
| Antennas | Front | Back | Top Side | Bottom Side | Left Side | Right Side |
| WWAN | <5 | <5 | 136 | <5 | 31 | <5 |
| BT/WLAN | <5 | <5 | <5 | 135 | <5 | 33 |

| Positions for SAR tests; Hotspot mode | | | | | | |
|---------------------------------------|-------|------|----------|-------------|-----------|------------|
| Antennas | Front | Back | Top Side | Bottom Side | Left Side | Right Side |
| WWAN | Yes | Yes | No | Yes | No | Yes |
| BT/WLAN | Yes | Yes | Yes | No | Yes | No |

General Note: Referring to KDB 941225 D06 v02, When the overall device length and width are ≥9cm*5cm, the test distance is 10mm, SAR must be measured for all sides and surfaces with a transmitting antenna located with 25mm from that surface or edge.

4.4. Standalone SAR Test Exclusion Considerations

Per KDB447498 for standalone 1-g head or body SAR evaluation by measurement or numerical simulation is not required when the corresponding SAR Exclusion Threshold condition, listed below, is satisfied.

The 1-g and 10-g SAR test exclusion thresholds for 100 MHz to 6 GHz at test separation distances ≤ 50 mm are determined by:

$[(\text{max. power of channel, including tune-up tolerance, mW}) / (\text{min. test separation distance, mm})] \cdot [\sqrt{f(\text{GHz})}] \leq 3.0$ for 1-g SAR and ≤ 7.5 for 10-g extremity SAR, where

- f(GHz) is the RF channel transmit frequency in GHz
- Power and distance are rounded to the nearest mW and mm before calculation
- The result is rounded to one decimal place for comparison
- 3.0 and 7.5 are referred to as the numeric thresholds in the step 2 below

At 100 MHz to 6 GHz and for test separation distances > 50 mm, the SAR test exclusion threshold is determined according to the following, and as illustrated in Appendix B:

a) $[\text{Power allowed at numeric threshold for 50 mm in step 1}) + (\text{test separation distance} - 50 \text{ mm}) \cdot (f(\text{MHz})/150)] \text{ mW}$, at 100 MHz to 1500 MHz

b) $[\text{Power allowed at numeric threshold for 50 mm in step 1}) + (\text{test separation distance} - 50 \text{ mm}) \cdot 10] \text{ mW}$ at > 1500 MHz and ≤ 6 GHz

| Positions for SAR tests; Hotspot mode | | | | | | |
|---------------------------------------|-------|------|----------|-------------|-----------|------------|
| Antennas | Front | Back | Top Side | Bottom Side | Left Side | Right Side |
| WWAN | Yes | Yes | No | Yes | Yes | Yes |
| BT/WLAN | Yes | Yes | Yes | No | Yes | Yes |

General Note: Referring to KDB 941225 D06 v02, When the overall device length and width are ≥9cm*5cm, the test distance is 10mm, SAR must be measured for all sides and surfaces with a transmitting antenna located with 25mm from that surface or edge.

4.5. SAR Measurement Results

The calculated SAR is obtained by the following formula:

$$\text{Reported SAR} = \text{Measured SAR} * 10^{(P_{\text{target}} - P_{\text{measured}})/10}$$

$$\text{Scaling factor} = 10^{(P_{\text{target}} - P_{\text{measured}})/10}$$

$$\text{Reported SAR} = \text{Measured SAR} * \text{Scaling factor}$$

Where

P_{target} is the power of manufacturing upper limit;

P_{measured} is the measured power;

Measured SAR is measured SAR at measured power which including power drift)

Reported SAR which including Power Drift and Scaling factor

Duty Cycle

| Test Mode | Duty Cycle |
|------------------------|------------|
| Speech for GSM850/1900 | 1:8 |
| GPRS850 | 1:2.67 |
| GPRS1900 | 1:2.67 |
| UMTS | 1:1 |
| LTE | 1:1 |
| WLAN2450 | 1:1 |

4.4.1 SAR Results

SAR Values [GSM 850]

| Ch. | Freq. (MHz) | Time slots | Test Position | Conducted Power (dBm) | Maximum Allowed Power (dBm) | Power Drift (%) | Scaling Factor | SAR _{1-g} results(W/kg) | | Graph Results |
|---|-------------|------------|---------------|-----------------------|-----------------------------|-----------------|----------------|----------------------------------|----------|---------------|
| | | | | | | | | Measured | Reported | |
| measured / reported SAR numbers - Head | | | | | | | | | | |
| 128 | 824.2 | Voice | Left Cheek | 32.69 | 33.00 | 1.66 | 1.074 | 0.358 | 0.384 | Plot 1 |
| 128 | 824.2 | Voice | Left Tilt | 32.69 | 33.00 | -0.21 | 1.074 | 0.302 | 0.324 | |
| 128 | 824.2 | Voice | Right Cheek | 32.69 | 33.00 | 0.09 | 1.074 | 0.286 | 0.307 | |
| 128 | 824.2 | Voice | Right Tilt | 32.69 | 33.00 | -2.65 | 1.074 | 0.235 | 0.252 | |
| measured / reported SAR numbers - Body (hotspot open, distance 10mm) | | | | | | | | | | |
| 128 | 824.2 | 3Txslots | Front | 29.50 | 30.00 | -2.18 | 1.122 | 0.388 | 0.435 | |
| 128 | 824.2 | 3Txslots | Rear | 29.50 | 30.00 | 0.27 | 1.122 | 0.416 | 0.467 | Plot 2 |
| 128 | 824.2 | 3Txslots | Left | 29.50 | 30.00 | 1.96 | 1.122 | 0.299 | 0.335 | |
| 128 | 824.2 | 3Txslots | Right | 29.50 | 30.00 | 0.06 | 1.122 | 0.277 | 0.311 | |
| 128 | 824.2 | 3Txslots | Bottom | 29.50 | 30.00 | 0.63 | 1.122 | 0.230 | 0.258 | |

SAR Values [GSM 1900]

| Ch. | Freq. (MHz) | time slots | Test Position | Conducted Power (dBm) | Maximum Allowed Power (dBm) | Power Drift (%) | Scaling Factor | SAR _{1-g} results(W/kg) | | Graph Results |
|---|-------------|------------|---------------|-----------------------|-----------------------------|-----------------|----------------|----------------------------------|----------|---------------|
| | | | | | | | | Measured | Reported | |
| measured / reported SAR numbers - Head | | | | | | | | | | |
| 512 | 1850.2 | Voice | Left Cheek | 29.67 | 30.00 | -0.50 | 1.079 | 0.261 | 0.282 | Plot 3 |
| 512 | 1850.2 | Voice | Left Tilt | 29.67 | 30.00 | 1.01 | 1.079 | 0.255 | 0.275 | |
| 512 | 1850.2 | Voice | Right Cheek | 29.67 | 30.00 | -2.41 | 1.079 | 0.198 | 0.214 | |
| 512 | 1850.2 | Voice | Right Tilt | 29.67 | 30.00 | 0.05 | 1.079 | 0.152 | 0.164 | |
| measured / reported SAR numbers - Body (hotspot open, distance 10mm) | | | | | | | | | | |
| 810 | 1909.8 | 3Txslots | Front | 26.50 | 27.00 | 2.40 | 1.122 | 0.765 | 0.858 | |
| 512 | 1850.2 | 3Txslots | Rear | 26.49 | 27.00 | 1.23 | 1.125 | 1.130 | 1.271 | |
| 661 | 1880.0 | 3Txslots | | 26.47 | 27.00 | 1.11 | 1.130 | 1.125 | 1.271 | |
| 810 | 1909.8 | 3Txslots | | 26.50 | 27.00 | -1.15 | 1.122 | 1.136 | 1.275 | Plot 4 |
| 810 | 1909.8 | 3Txslots | Left | 26.50 | 27.00 | 0.23 | 1.122 | 0.740 | 0.830 | |
| 810 | 1909.8 | 3Txslots | Right | 26.50 | 27.00 | -1.09 | 1.122 | 0.741 | 0.831 | |
| 810 | 1909.8 | 3Txslots | Bottom | 26.50 | 27.00 | 1.02 | 1.122 | 0.500 | 0.561 | |

SAR Values [WCDMA Band V]

| Ch. | Freq. (MHz) | Channel Type | Test Position | Conducted Power (dBm) | Maximum Allowed Power (dBm) | Power Drift (%) | Scaling Factor | SAR _{1-g} results(W/kg) | | Graph Results |
|---|-------------|--------------|---------------|-----------------------|-----------------------------|-----------------|----------------|----------------------------------|----------|---------------|
| | | | | | | | | Measured | Reported | |
| measured / reported SAR numbers - Head | | | | | | | | | | |
| 4132 | 826.4 | RMC | Left Cheek | 23.57 | 24.00 | 0.35 | 1.104 | 0.378 | 0.417 | Plot 5 |
| 4132 | 826.4 | RMC | Left Tilt | 23.57 | 24.00 | 0.05 | 1.104 | 0.360 | 0.397 | |
| 4132 | 826.4 | RMC | Right Cheek | 23.57 | 24.00 | -1.06 | 1.104 | 0.356 | 0.393 | |
| 4132 | 826.4 | RMC | Right Tilt | 23.57 | 24.00 | 0.24 | 1.104 | 0.301 | 0.332 | |
| measured / reported SAR numbers - Body (hotspot open, distance 10mm) | | | | | | | | | | |
| 4132 | 826.4 | RMC | Front | 23.57 | 24.00 | 0.00 | 1.104 | 0.544 | 0.601 | Plot 6 |
| 4132 | 826.4 | RMC | Rear | 23.57 | 24.00 | 1.01 | 1.104 | 0.520 | 0.574 | |
| 4132 | 826.4 | RMC | Left | 23.57 | 24.00 | 0.16 | 1.104 | 0.486 | 0.537 | |
| 4132 | 826.4 | RMC | Right | 23.57 | 24.00 | -1.30 | 1.104 | 0.480 | 0.530 | |
| 4132 | 826.4 | RMC | Bottom | 23.57 | 24.00 | -2.01 | 1.104 | 0.301 | 0.332 | |

SAR Values [WCDMA Band II]

| Ch. | Freq. (MHz) | Channel Type | Test Position | Conducted Power (dBm) | Maximum Allowed Power (dBm) | Power Drift (%) | Scaling Factor | SAR _{1-g} results(W/kg) | | Graph Results |
|---|-------------|--------------|---------------|-----------------------|-----------------------------|-----------------|----------------|----------------------------------|----------|---------------|
| | | | | | | | | Measured | Reported | |
| measured / reported SAR numbers - Head | | | | | | | | | | |
| 9538 | 1907.6 | RMC | Left Cheek | 23.60 | 24.00 | 1.63 | 1.096 | 0.127 | 0.139 | Plot 7 |
| 9538 | 1907.6 | RMC | Left Tilt | 23.60 | 24.00 | 0.01 | 1.096 | 0.115 | 0.126 | |
| 9538 | 1907.6 | RMC | Right Cheek | 23.60 | 24.00 | -2.66 | 1.096 | 0.109 | 0.120 | |
| 9538 | 1907.6 | RMC | Right Tilt | 23.60 | 24.00 | 2.51 | 1.096 | 0.100 | 0.110 | |
| measured / reported SAR numbers - Body (hotspot open, distance 10mm) | | | | | | | | | | |
| 9538 | 1907.6 | RMC | Front | 23.60 | 24.00 | -4.39 | 1.096 | 0.316 | 0.346 | Plot 8 |
| 9538 | 1907.6 | RMC | Rear | 23.60 | 24.00 | -1.43 | 1.096 | 0.310 | 0.340 | |
| 9538 | 1907.6 | RMC | Left | 23.60 | 24.00 | 2.76 | 1.096 | 0.300 | 0.329 | |
| 9538 | 1907.6 | RMC | Right | 23.60 | 24.00 | 3.03 | 1.096 | 0.299 | 0.328 | |
| 9538 | 1907.6 | RMC | Bottom | 23.60 | 24.00 | -0.29 | 1.096 | 0.276 | 0.303 | |

SAR Values [WIFI2.4G]

| Ch. | Freq. (MHz) | Service | Test Position | Maximum Allowed Power (dBm) | Conducted Power (dBm) | Power Drift (%) | Scaling Factor | SAR _{1-g} results(W/kg) | | Graph Results |
|---|-------------|---------|---------------|-----------------------------|-----------------------|-----------------|----------------|----------------------------------|----------|---------------|
| | | | | | | | | Measured | Reported | |
| measured / reported SAR numbers - Head | | | | | | | | | | |
| 6 | 2437 | DSSS | Left Cheek | 13.61 | 14.00 | -4.64 | 1.094 | 0.300 | 0.328 | Plot 9 |
| 6 | 2437 | DSSS | Left Tilt | 13.61 | 14.00 | 0.45 | 1.094 | 0.288 | 0.315 | |
| 6 | 2437 | DSSS | Right Cheek | 13.61 | 14.00 | 1.02 | 1.094 | 0.263 | 0.288 | |
| 6 | 2437 | DSSS | Right Tilt | 13.61 | 14.00 | -2.36 | 1.094 | 0.206 | 0.225 | |
| measured / reported SAR numbers - Body (hotspot open, distance 10mm) | | | | | | | | | | |
| 6 | 2437 | DSSS | Front | 13.61 | 14.00 | -1.50 | 1.094 | 0.170 | 0.186 | |
| 6 | 2437 | DSSS | Rear | 13.61 | 14.00 | 3.55 | 1.094 | 0.178 | 0.195 | Plot 10 |
| 6 | 2437 | DSSS | Left | 13.61 | 14.00 | 2.11 | 1.094 | 0.150 | 0.164 | |
| 6 | 2437 | DSSS | Right | 13.61 | 14.00 | 3.22 | 1.094 | 0.151 | 0.165 | |
| 6 | 2437 | DSSS | Top | 13.61 | 14.00 | 2.06 | 1.094 | 0.132 | 0.144 | |

Note:

1. The value with black color is the maximum Reported SAR Value of each test band.
2. Per FCC KDB Publication 447498 D01, if the reported (scaled) SAR measured at the middle channel or highest output power channel for each test configuration is ≤ 0.8 W/kg then testing at the other channels is optional for such test configuration(s).
3. Per KDB 941225 D02, RMC 12.2kbps setting is used to evaluate SAR. If HSDPA/HSUPA output power is < 0.25 dB higher than RMC, or reported SAR with RMC 12.2kbps setting is ≤ 1.2 W/kg, HSDPA/HSUPA SAR evaluation can be excluded.
4. Per KDB 941225 D05, start with the largest channel bandwidth and measure SAR for QPSK with 1 RB allocation, using the RB offset and required test channel combination with the highest maximum output power for RB offsets at the upper edge, middle and lower edge of each required test channel.
5. Per KDB 941225 D05, 50% RB allocation for QPSK SAR testing follows 1RB QPSK allocation procedure.
6. Per KDB 941225 D05, For QPSK with 100% RB allocation, SAR is not required when the highest maximum output power for 100% RB allocation is less than the highest maximum output power in 50% and 1 RB allocations and the highest reported SAR for 1 RB and 50% RB allocation are ≤ 0.8 W/kg. Otherwise, SAR is measured for the highest output power channel; and if the reported SAR is > 1.45 W/kg, the remaining required test channels must also be tested.
7. Per KDB 941225 D05, 16QAM output power for each RB allocation configuration is $>$ not $\frac{1}{2}$ dB higher than the same configuration in QPSK and the reported SAR for the QPSK configuration is ≤ 1.45 W/kg; Per KDB 941225 D05v02r03, 16QAM SAR testing is not required.
8. Per KDB 941225 D05, Smaller bandwidth output power for each RB allocation configuration is $>$ not $\frac{1}{2}$ dB higher than the same configuration in the largest supported bandwidth, and the reported SAR for the largest supported bandwidth is ≤ 1.45 W/kg; Per KDB 941225 D05, smaller bandwidth SAR testing is not required.
9. Per KDB 248227- SAR is measured using the highest measured maximum output power channel for the initial test configuration.
10. Per KDB 248227- Channels with measured maximum output power within $\frac{1}{4}$ dB of each other are considered to have the same maximum output, When there are multiple test channels with the same measured maximum output power, the channel closest to mid-band frequency is selected for SAR measurement. And when there are multiple test channels with the same measured maximum output power and equal separation from mid-band frequency; for example, high and low channels or two mid-band channels, the higher frequency (number) channel is selected for SAR measurement.
11. Per KDB 248227- When the highest reported SAR for DSSS is adjusted by the ratio of OFDM to DSSS specified maximum output power and the adjusted SAR is ≤ 1.2 W/kg. So OFDM SAR test is not required.
12. Per KDB 648474 D04, when the reported SAR for a body-worn accessory measured without a headset connected to the handset is ≤ 1.2 W/kg, SAR testing with a headset connected to the handset is not required.

4.4.2 Standalone SAR Test Exclusion Considerations and Estimated SAR

Per KDB447498 requires when the standalone SAR test exclusion of section 4.3.1 is applied to an antenna that transmits simultaneously with other antennas, the standalone SAR must be estimated according to the following to determine simultaneous transmission SAR test exclusion;

• $(\text{max. power of channel, including tune-up tolerance, mW}) / (\text{min. test separation distance, mm}) \cdot [\sqrt{f(\text{GHz})} / x]$ W/kg for test separation distances ≤ 50 mm;

where $x = 7.5$ for 1-g SAR, and $x = 18.75$ for 10-g SAR.

• 0.4 W/kg for 1-g SAR and 1.0 W/kg for 10-g SAR, when the test separation distances is > 50 mm

Per FCC KD B447498 D01, simultaneous transmission SAR test exclusion may be applied when the sum of the 1-g SAR for all the transmitting antenna in a specific a physical test configuration is ≤ 1.6 W/Kg. When the sum is greater than the SAR limit, SAR test exclusion is determined by the SAR to peak location separation ratio.

$$\text{Ratio} = \frac{(\text{SAR}_1 + \text{SAR}_2)^{1.5}}{(\text{peak location separation, mm})} < 0.04$$

| Estimated stand alone SAR | | | | | |
|---------------------------|-----------------|---------------|---------------------|--------------------------|-------------------------------------|
| Communication system | Frequency (MHz) | Configuration | Maximum Power (dBm) | Separation Distance (mm) | Estimated SAR _{1-g} (W/kg) |
| Bluetooth* | 2450 | Head | 3.00 | 5 | 0.080 |
| Bluetooth* | 2450 | Hotspot | 3.00 | 10 | 0.040 |
| Bluetooth* | 2450 | Body-worn | 3.00 | 10 | 0.040 |

Remark:

1. Bluetooth*- Including Lower power Bluetooth
2. Maximum average power including tune-up tolerance;
3. When the minimum test separation distance is < 5 mm, a distance of 5 mm is applied to determine SAR test exclusion
4. Body as body use distance is 10mm from manufacturer declaration of user manual

4.6. Simultaneous TX SAR Considerations

4.5.1 Introduction

The following procedures adopted from “FCC SAR Considerations for Cell Phones with Multiple Transmitters” are applicable to handsets with built-in unlicensed transmitters such as 802.11 a/b/g/n and Bluetooth devices which may simultaneously transmit with the licensed transmitter.

For the DUT, the BT and WiFi modules sharing same antenna, GSM, WCDMA and LTE modules sharing a single antenna; BT/WLAN and GSM/UMTS/LTE can simultaneous transmit;

Application Simultaneous Transmission information:

| Air-Interface | Band (MHz) | Type | Simultaneous Transmissions | Voice over Digital Transport(Data) |
|---------------|---------------|------|---------------------------------|------------------------------------|
| GSM | 850 | VO | Yes, WLAN or BT/BLE | N/A |
| | 1900 | VO | | |
| | GPRS/EDGE | DT | Yes, WLAN or BT/BLE | N/A |
| WCDMA | Band II/BandV | DT | Yes, WLAN or BT/BLE | N/A |
| WLAN | 2450 | DT | Yes, GSM, GPRS, EDGE, UMTS, LTE | Yes |
| BT/BLE | 2450 | DT | Yes, GSM, GPRS, EDGE, UMTS, LTE | N/A |

Note: VO-Voice Service only; DT-Digital Transport

Note:

BT and WLAN can be active at the same time, but only with interleaving of packages switched on board level. That means that they don't transmit at the same time.

BLE-Bluetooth low energy;

BT- Classical Bluetooth

4.5.2 Evaluation of Simultaneous SAR

Head Exposure Conditions

Simultaneous transmission SAR forWiFi and GSM

| Test Position | GSM850 Reported SAR _{1-g} (W/Kg) | GSM1900 Reported SAR _{1-g} (W/Kg) | WiFi2.4G Reported SAR _{1-g} (W/Kg) | MAX. ΣSAR _{1-g} (W/Kg) | SAR _{1-g} Limit (W/Kg) | Peak location separation ratio | Simut Meas. Required |
|---------------|---|--|---|---------------------------------|---------------------------------|--------------------------------|----------------------|
| Left Cheek | 0.384 | 0.282 | 0.328 | 0.712 | 1.6 | no | no |
| Left Tilt | 0.324 | 0.275 | 0.315 | 0.639 | 1.6 | no | no |
| Right Cheek | 0.307 | 0.214 | 0.288 | 0.595 | 1.6 | no | no |
| Right Tilt | 0.252 | 0.164 | 0.225 | 0.477 | 1.6 | no | no |

Simultaneous transmission SAR forWiFi and UMTS

| Test Position | UMTS Band V Reported SAR _{1-g} (W/Kg) | UMTS Band II Reported SAR _{1-g} (W/Kg) | WiFi2.4G Reported SAR _{1-g} (W/Kg) | MAX. ΣSAR _{1-g} (W/Kg) | SAR _{1-g} Limit (W/Kg) | Peak location separation ratio | Simut Meas. Required |
|---------------|--|---|---|---------------------------------|---------------------------------|--------------------------------|----------------------|
| Left Cheek | 0.417 | 0.139 | 0.328 | 0.745 | 1.6 | no | no |
| Left Tilt | 0.397 | 0.126 | 0.315 | 0.712 | 1.6 | no | no |
| Right Cheek | 0.393 | 0.120 | 0.288 | 0.681 | 1.6 | no | no |
| Right Tilt | 0.332 | 0.110 | 0.225 | 0.557 | 1.6 | no | no |

Simultaneous transmission SAR forBT and GSM

| Test Position | GSM850 Reported SAR _{1-g} (W/Kg) | GSM1900 Reported SAR _{1-g} (W/Kg) | BT Estimated SAR _{1-g} (W/Kg) | MAX. ΣSAR _{1-g} (W/Kg) | SAR _{1-g} Limit (W/Kg) | Peak location separation ratio | Simut Meas. Required |
|---------------|---|--|--|---------------------------------|---------------------------------|--------------------------------|----------------------|
| Left Cheek | 0.384 | 0.282 | 0.080 | 0.464 | 1.6 | no | no |
| LeftTilt | 0.324 | 0.275 | 0.080 | 0.404 | 1.6 | no | no |
| Right Cheek | 0.307 | 0.214 | 0.080 | 0.387 | 1.6 | no | no |
| Right Tilt | 0.252 | 0.164 | 0.080 | 0.332 | 1.6 | no | no |

Simultaneous transmission SAR forBT and UMTS

| Test Position | UMTS Band V Reported SAR _{1-g} (W/Kg) | UMTS Band II Reported SAR _{1-g} (W/Kg) | BT Estimated SAR _{1-g} (W/Kg) | MAX. ΣSAR _{1-g} (W/Kg) | SAR _{1-g} Limit (W/Kg) | Peak location separation ratio | Simut Meas. Required |
|---------------|--|---|--|---------------------------------|---------------------------------|--------------------------------|----------------------|
| Left Cheek | 0.417 | 0.139 | 0.080 | 0.497 | 1.6 | no | no |
| LeftTilt | 0.397 | 0.126 | 0.080 | 0.477 | 1.6 | no | no |
| RightChek | 0.393 | 0.120 | 0.080 | 0.473 | 1.6 | no | no |
| Right Tilt | 0.332 | 0.110 | 0.080 | 0.412 | 1.6 | no | no |

BodyHotspot Exposure Conditions

Simultaneous transmission SAR forWiFi and GSM

| Test Position | GSM850 Reported SAR _{1-g} (W/Kg) | GSM1900 Reported SAR _{1-g} (W/Kg) | WiFi2.4G Reported SAR _{1-g} (W/Kg) | MAX. ΣSAR _{1-g} (W/Kg) | SAR _{1-g} Limit (W/Kg) | Peak location separation ratio | Simut Meas. Required |
|---------------|---|--|---|---------------------------------|---------------------------------|--------------------------------|----------------------|
| Front | 0.435 | 0.858 | 0.186 | 1.044 | 1.6 | no | no |
| Rear | 0.467 | 1.275 | 0.195 | 1.470 | 1.6 | no | no |
| Left | 0.335 | 0.830 | 0.164 | 0.994 | 1.6 | no | no |
| Right | 0.311 | 0.831 | 0.165 | 0.996 | 1.6 | no | no |
| Bottom | 0.258 | 0.561 | / | 0.561 | 1.6 | no | no |
| Top | / | / | 0.144 | 0.144 | 1.6 | no | no |

Simultaneous transmission SAR forWiFi and UMTS

| Test Position | UMTS Band V Reported SAR _{1-g} (W/Kg) | UMTS Band II Reported SAR _{1-g} (W/Kg) | WiFi2.4G Reported SAR _{1-g} (W/Kg) | MAX. ΣSAR _{1-g} (W/Kg) | SAR _{1-g} Limit (W/Kg) | Peak location separation ratio | Simut Meas. Required |
|---------------|--|---|---|---------------------------------|---------------------------------|--------------------------------|----------------------|
| Front | 0.601 | 0.346 | 0.186 | 0.787 | 1.6 | no | no |
| Rear | 0.574 | 0.340 | 0.195 | 0.769 | 1.6 | no | no |
| Left | 0.537 | 0.329 | 0.164 | 0.701 | 1.6 | no | no |
| Right | 0.530 | 0.328 | 0.165 | 0.695 | 1.6 | no | no |
| Bottom | 0.332 | 0.303 | / | 0.332 | 1.6 | no | no |
| Top | / | / | 0.144 | 0.144 | 1.6 | no | no |

Simultaneous transmission SAR forBT and GSM

| Test Position | GSM850 Reported SAR _{1-g} (W/Kg) | GSM1900 Reported SAR _{1-g} (W/Kg) | BT Estimated SAR _{1-g} (W/Kg) | MAX. ΣSAR _{1-g} (W/Kg) | SAR _{1-g} Limit (W/Kg) | Peak location separation ratio | Simut Meas. Required |
|---------------|---|--|--|---------------------------------|---------------------------------|--------------------------------|----------------------|
| Front | 0.435 | 0.858 | 0.040 | 0.898 | 1.6 | no | no |
| Rear | 0.467 | 1.275 | 0.040 | 1.315 | 1.6 | no | no |
| Left | 0.335 | 0.830 | 0.040 | 0.870 | 1.6 | no | no |
| Right | 0.311 | 0.831 | / | 0.831 | 1.6 | no | no |
| Bottom | 0.258 | 0.561 | / | 0.561 | 1.6 | no | no |
| Top | / | / | 0.040 | 0.040 | 1.6 | no | no |

Simultaneous transmission SAR for BT and UMTS

| Test Position | UMTS Band V Reported SAR _{1-g} (W/Kg) | UMTS Band II Reported SAR _{1-g} (W/Kg) | BT Estimated SAR _{1-g} (W/Kg) | MAX. Σ SAR _{1-g} (W/Kg) | SAR _{1-g} Limit (W/Kg) | Peak location separation ratio | Simut Meas. Required |
|---------------|--|---|--|---|---------------------------------|--------------------------------|----------------------|
| Front | 0.601 | 0.346 | 0.040 | 0.641 | 1.6 | no | no |
| Rear | 0.574 | 0.340 | 0.040 | 0.614 | 1.6 | no | no |
| Left | 0.537 | 0.329 | 0.040 | 0.577 | 1.6 | no | no |
| Right | 0.530 | 0.328 | / | 0.530 | 1.6 | no | no |
| Bottom | 0.332 | 0.303 | / | 0.332 | 1.6 | no | no |
| Top | / | / | 0.040 | 0.040 | 1.6 | no | no |

Note:

1. The WiFi and BT share same antenna, so cannot transmit at same time.
2. The value with block color is the maximum values of standalone
3. The value with blue color is the maximum values of Σ SAR_{1-g}

4.7. SAR Measurement Variability

According to KDB865664, Repeated measurements are required only when the measured SAR is ≥ 0.80 W/kg. If the measured SAR value of the initial repeated measurement is < 1.45 W/kg with $\leq 20\%$ variation, only one repeated measurement is required to reaffirm that the results are not expected to have substantial variations, which may introduce significant compliance concerns. A second repeated measurement is required only if the measured result for the initial repeated measurement is within 10% of the SAR limit and vary by more than 20%, which are often related to device and measurement setup difficulties. The following procedures are applied to determine if repeated measurements are required. The same procedures should be adapted for measurements according to extremity and occupational exposure limits by applying a factor of 2.5 for extremity exposure and a factor of 5 for occupational exposure to the corresponding SAR thresholds.19 The repeated measurement results must be clearly identified in the SAR report. All measured SAR, including the repeated results, must be considered to determine compliance and for reporting according to KDB 690783.Repeated measurement is not required when the original highest measured SAR is < 0.80 W/kg; steps 2) through 4) do not apply.

- 3) When the original highest measured SAR is ≥ 0.80 W/kg, repeat that measurement once.
- 4) Perform a second repeated measurement only if the ratio of largest to smallest SAR for the original and first repeated measurements is > 1.20 or when the original or repeated measurement is ≥ 1.45 W/kg (~ 10% from the 1-g SAR limit).
- 5) Perform a third repeated measurement only if the original, first or second repeated measurement is ≥ 1.5 W/kg and the ratio of largest to smallest SAR for the original, first and second repeated measurements is > 1.20 .
- 6) Perform a third repeated measurement only if the original, first or second repeated measurement is ≥ 1.5 W/kg and the ratio of largest to smallest SAR for the original, first and second repeated measurements is > 1.20

| Frequency Band (MHz) | Air Interface | RF Exposure Configuration | Test Position | Repeated SAR (yes/no) | Highest Measured SAR _{1-g} (W/Kg) | First Repeated | |
|----------------------|---------------|---------------------------|---------------|-----------------------|--|------------------------------------|-------------------------------|
| | | | | | | Measured SAR _{1-g} (W/Kg) | Largest to Smallest SAR Ratio |
| 850 | GSM850 | Standalone | Body-Rear | no | 0.416 | n/a | n/a |
| | WCDMA Band V | Standalone | Body-Front | no | 0.544 | n/a | n/a |
| 1900 | GSM1900 | Standalone | Body-Front | yes | 1.136 | 1.001 | 0.796 |
| | WCDMA Band II | Standalone | Body-Rear | no | 0.316 | n/a | n/a |
| 2450 | 2.4GWLAN | Standalone | Body-Rear | no | 0.178 | n/a | n/a |

Remark:

1. *Second Repeated Measurement is not required since the ratio of the largest to smallest SAR for the original and first repeated measurement is not > 1.20 or 3 (1-g or 10-g respectively)*

4.8. General description of test procedures

1. The DUT is tested using CMU 200 communications testers as controller unit to set test channels and maximum output power to the DUT, as well as for measuring the conducted peak power.
2. Test positions as described in the tables above are in accordance with the specified test standard.
3. Tests in body position were performed in that configuration, which generates the highest time based averaged output power (see conducted power results).
4. Tests in head position with GSM were performed in voice mode with 1 timeslot unless GPRS/EGPRS/DTM function allows parallel voice and data traffic on 2 or more timeslots.
5. UMTS was tested in RMC mode with 12.2 kbit/s and TPC bits set to 'all 1'.
6. WiFi was tested in 802.11b/g/n mode with 1 Mbit/s and 6 Mbit/s. According to KDB 248227 the SAR testing for 802.11g/n is not required since When the highest reported SAR for DSSS is adjusted by the ratio of OFDM to DSSS specified maximum output power and the adjusted SAR is ≤ 1.2 W/kg.
7. Required WiFi test channels were selected according to KDB 248227
8. According to FCC KDB pub 248227 D01, When there are multiple test channels with the same measured maximum output power, the channel closest to mid-band frequency is selected for SAR measurement and when there are multiple test channels with the same measured maximum output power and equal separation from mid-band frequency; for example, high and low channels or two mid-band channels, the higher frequency (number) channel is selected for SAR measurement.
9. According to FCC KDB pub 941225 D06 this device has been tested with 10 mm distance to the phantom for operation in WiFi hot spot mode.
10. Per FCC KDB pub 941225 D06 the edges with antennas within 2.5 cm are required to be evaluated for SAR to cover WiFi hot spot function.
11. According to IEEE 1528 the SAR test shall be performed at middle channel. Testing of top and bottom channel is optional.
12. According to KDB 447498 D01 testing of other required channels within the operating mode of a frequency band is not required when the reported 1-g or 10-g SAR for the mid-band or highest output power channel is:
 - ≤ 0.8 W/kg or 2.0 W/kg, for 1-g or 10-g respectively, when the transmission band is ≤ 100 MHz
 - ≤ 0.6 W/kg or 1.5 W/kg, for 1-g or 10-g respectively, when the transmission band is between 100 MHz and 200 MHz
 - ≤ 0.4 W/kg or 1.0 W/kg, for 1-g or 10-g respectively, when the transmission band is ≥ 200 MHz
13. IEEE 1528-2003 require the middle channel to be tested first. This generally applies to wireless devices that are designed to operate in technologies with tight tolerances for maximum output power variations across channels in the band. When the maximum output power variation across the required test channels is $> \frac{1}{2}$ dB, instead of the middle channel, the highest output power channel must be used.
14. Per KDB648474 D04 require when the reported SAR for a body-worn accessory, measured without a headset connected to the handset, is < 1.2 W/kg.
15. Per KDB648474 D04 require when the separation distance required for body-worn accessory testing is larger than or equal to that tested for hotspot mode, using the same wireless mode test configuration for voice and data, such as UMTS, LTE and Wi-Fi, and for the same surface of the phone, the hotspot mode SAR data may be used to support body-worn accessory SAR compliance for that particular configuration (surface)
16. 10-g extremity SAR is required only for the surfaces and edges with hotspot mode 1-g SAR > 1.2 W/kg.
17. Per KDB648474 D04 require for phablet SAR test considerations. For GSM/WCDMA Smartphones with a display diagonal dimension > 15.0 cm or an overall diagonal dimension > 16.0 cm, When hotspot mode applies, 10-g extremity SAR is required only for the surfaces and edges with hotspot mode 1-g reported SAR > 1.2 W/kg.
18. 10-g extremity SAR is required only for the surfaces and edges with hotspot mode 1-g SAR > 1.2 W/kg.

4.9. Measurement Uncertainty (300MHz-3GHz)

Not required as SAR measurement uncertainty analysis is required in SAR reports only when the highest measured SAR in a frequency band is ≥ 1.5 W/kg for 1-g SAR according to KDB865664D01.

4.10. System Check Results

Test mode:835MHz(Head)
 Product Description:Validation
 Model:Dipole SID835
 E-Field Probe:SSE2(SN34/15 EPGO265)
 Test Date:July 03, 2017

| | |
|-----------------------------------|------------|
| Medium(liquid type) | HSL_850 |
| Frequency (MHz) | 835.000000 |
| Relative permittivity (real part) | 43.02 |
| Conductivity (S/m) | 0.90 |
| Input power | 100mW |
| Crest Factor | 1.0 |
| Conversion Factor | 2.04 |
| Variation (%) | 0.1200000 |
| SAR 10g (W/Kg) | 0.624808 |
| SAR 1g (W/Kg) | 0.962563 |

SURFACE SAR

VOLUME SAR

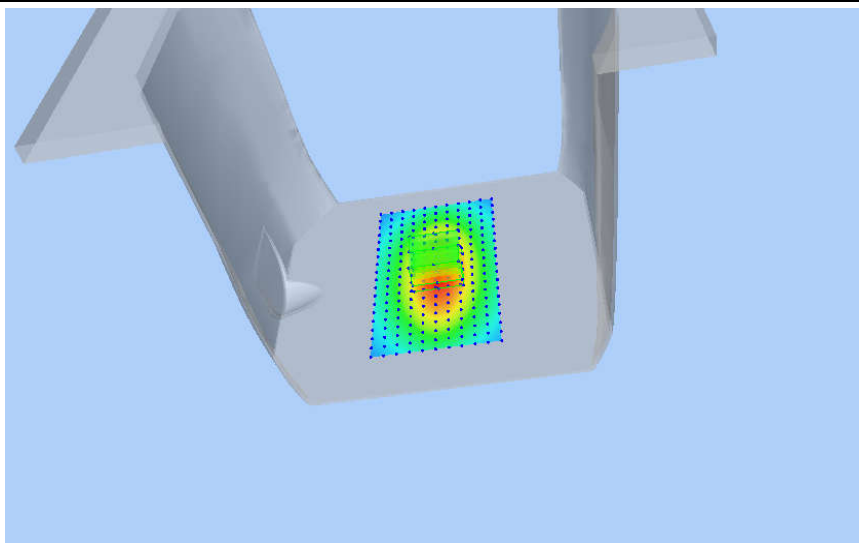
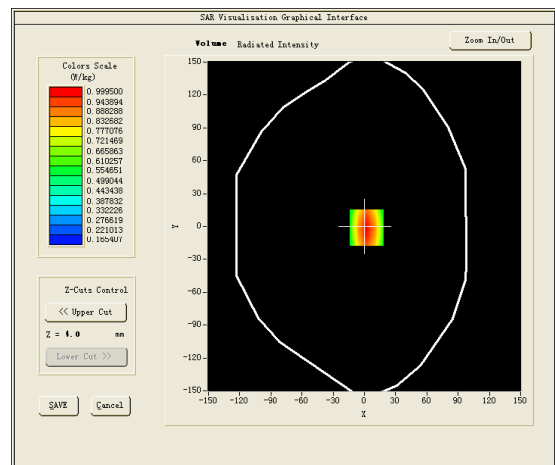
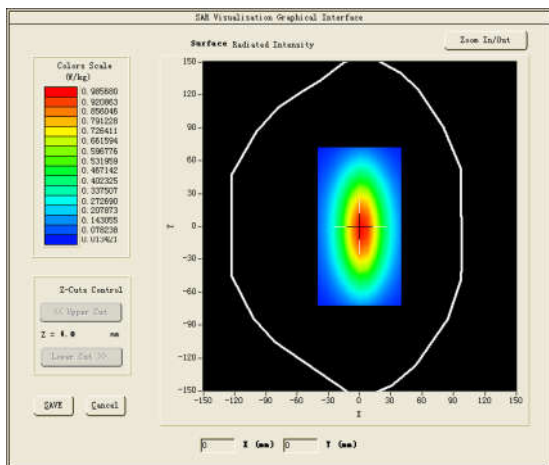

Test mode:835MHz(Body)
 Product Description:Validation
 Model:Dipole SID835
 E-Field Probe:SSE2(SN34/15 EPGO265)
 Test Date:July 04, 2017

| | |
|-----------------------------------|------------|
| Medium(liquid type) | MSL_850 |
| Frequency (MHz) | 835.0000 |
| Relative permittivity (real part) | 53.72 |
| Conductivity (S/m) | 0.98 |
| Input power | 100mW |
| Crest Factor | 1.0 |
| Conversion Factor | 2.12 |
| Variation (%) | -0.1800000 |
| SAR 10g (W/Kg) | 0.625071 |
| SAR 1g (W/Kg) | 0.951868 |

SURFACE SAR

VOLUME SAR

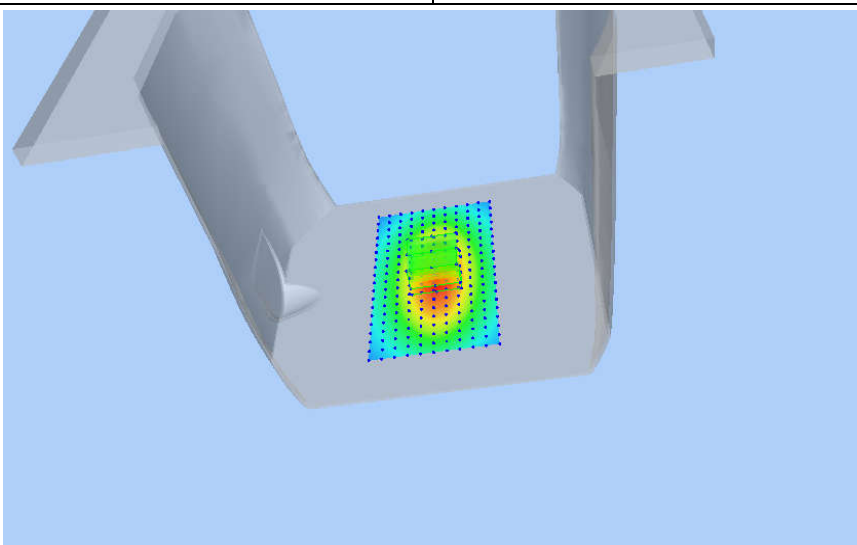
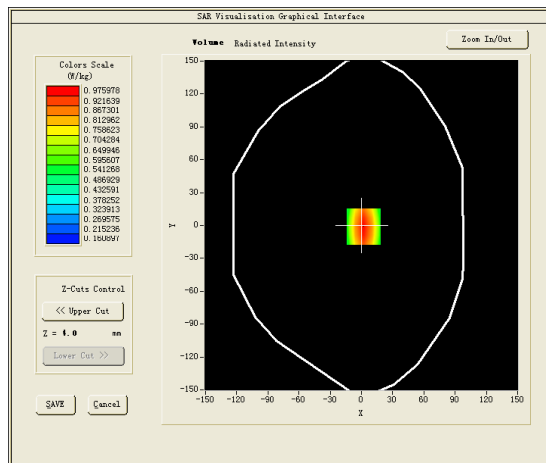
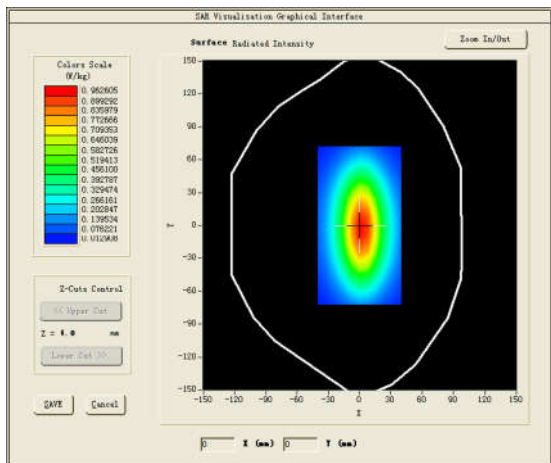

Test mode:1900MHz(Head)
 Product Description:Validation
 Model :Dipole SID1900
 E-Field Probe:SSE2(SN34/15 EPGO265)
 Test Date:July 05, 2017

| | |
|-----------------------------------|------------|
| Medium(liquid type) | HSL_1900 |
| Frequency (MHz) | 1900.0000 |
| Relative permittivity (real part) | 40.79 |
| Conductivity (S/m) | 1.42 |
| Input power | 100mW |
| Crest Factor | 1.0 |
| Conversion Factor | 2.35 |
| Variation (%) | -0.0300000 |
| SAR 10g (W/Kg) | 1.9804893 |
| SAR 1g (W/Kg) | 4.0387228 |

SURFACE SAR

VOLUME SAR

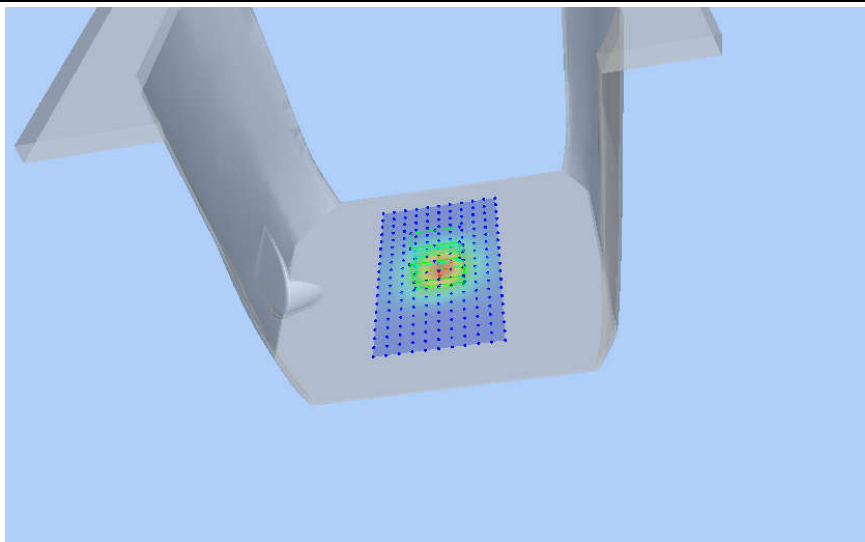
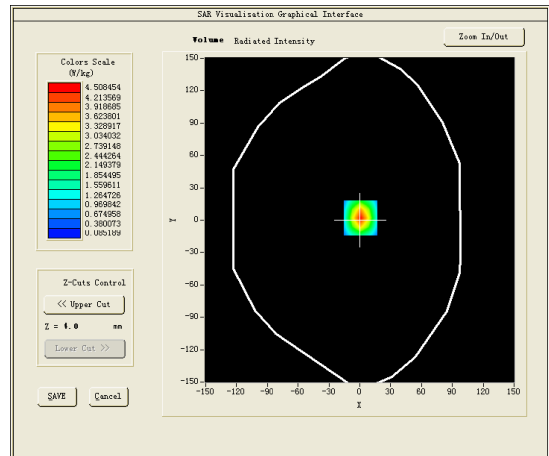
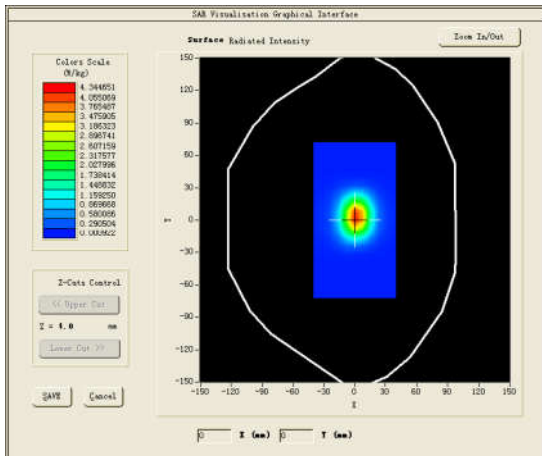

Test mode:1900MHz(Body)
 Product Description:Validation
 Model :Dipole SID1900
 E-Field Probe:SSE2(SN34/15 EPGO265)
 Test Date:July 06, 2017

| | |
|-----------------------------------|-----------|
| Medium(liquid type) | MSL_1900 |
| Frequency (MHz) | 1900.0000 |
| Relative permittivity (real part) | 54.47 |
| Conductivity (S/m) | 1.57 |
| Input power | 100mW |
| Crest Factor | 1.0 |
| Conversion Factor | 2.42 |
| Variation (%) | 1.740000 |
| SAR 10g (W/Kg) | 2.156287 |
| SAR 1g (W/Kg) | 4.210465 |

SURFACE SAR

VOLUME SAR

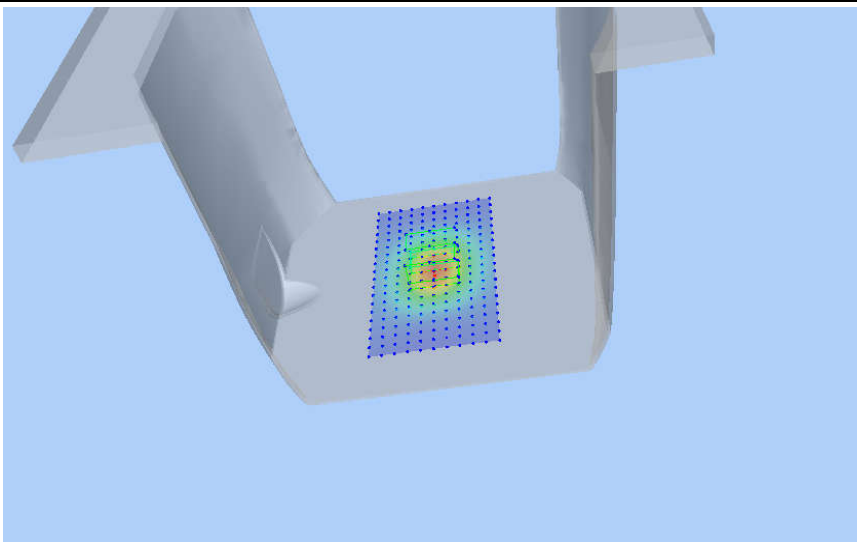
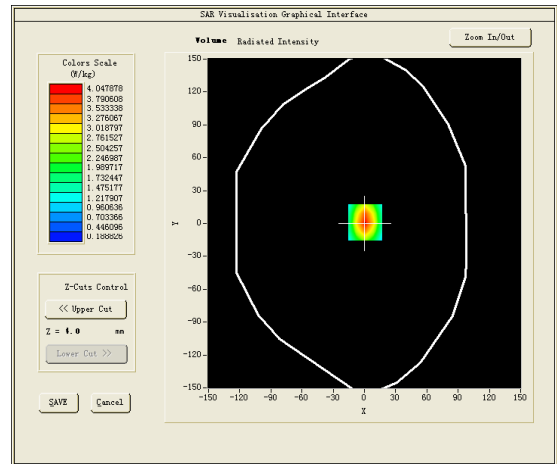
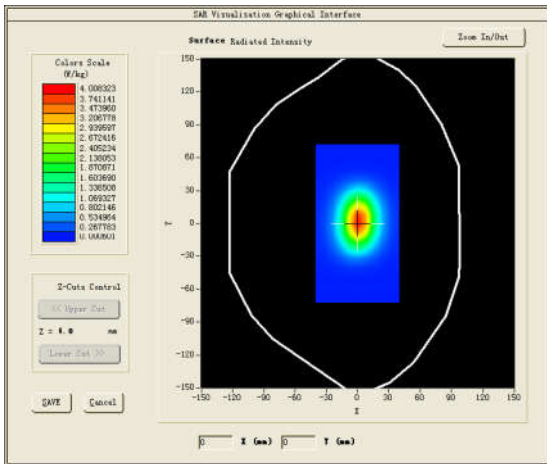

Test mode:2450MHz(Head)
 Product Description:Validation
 Model:Dipole SID2450
 E-Field Probe:SSE2(SN34/15 EPGO265)
 Test Date:July 10, 2017

| | |
|-----------------------------------|-------------|
| Medium(liquid type) | HSL_2450 |
| Frequency (MHz) | 2450.000000 |
| Relative permittivity (real part) | 38.73 |
| Conductivity (S/m) | 1.81 |
| Input power | 100mW |
| Crest Factor | 1.0 |
| Conversion Factor | 2.47 |
| Variation (%) | 0.2500000 |
| SAR 10g (W/Kg) | 2.355956 |
| SAR 1g (W/Kg) | 5.230843 |

SURFACE SAR

VOLUME SAR

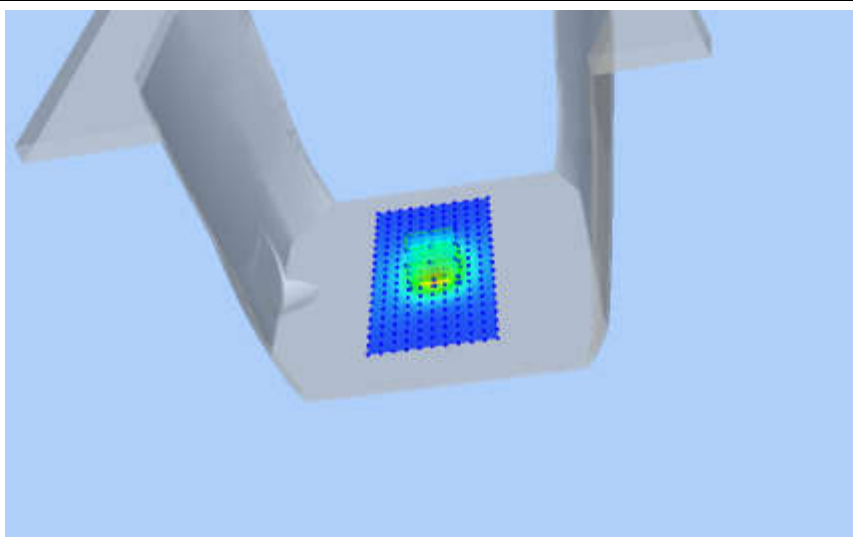
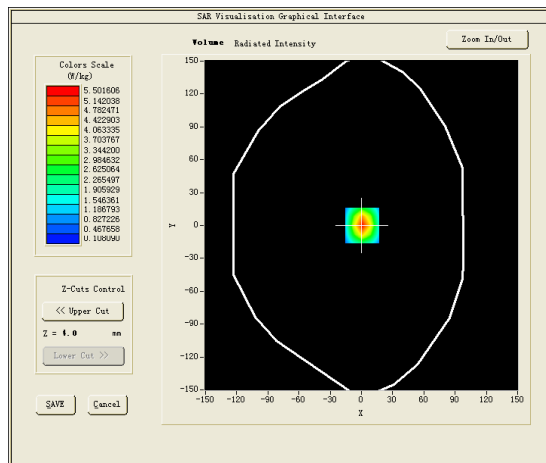
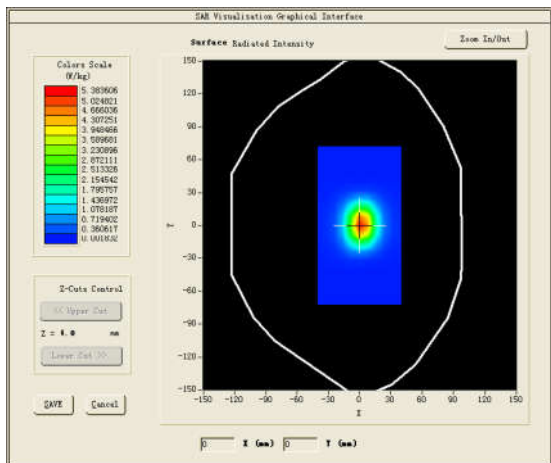

Test mode:2450MHz(Body)
 Product Description:Validation
 Model:Dipole SID2450
 E-Field Probe:SSE2(SN34/15 EPGO265)
 Test Date:July 11, 2017

| | |
|-----------------------------------|-------------|
| Medium(liquid type) | MSL_2450 |
| Frequency (MHz) | 2450.000000 |
| Relative permittivity (real part) | 53.23 |
| Conductivity (S/m) | 1.96 |
| Input power | 100mW |
| Crest Factor | 1.0 |
| Conversion Factor | 2.55 |
| Variation (%) | -0.3000000 |
| SAR 10g (W/Kg) | 2.488556 |
| SAR 1g (W/Kg) | 5.270692 |

SURFACE SAR

VOLUME SAR

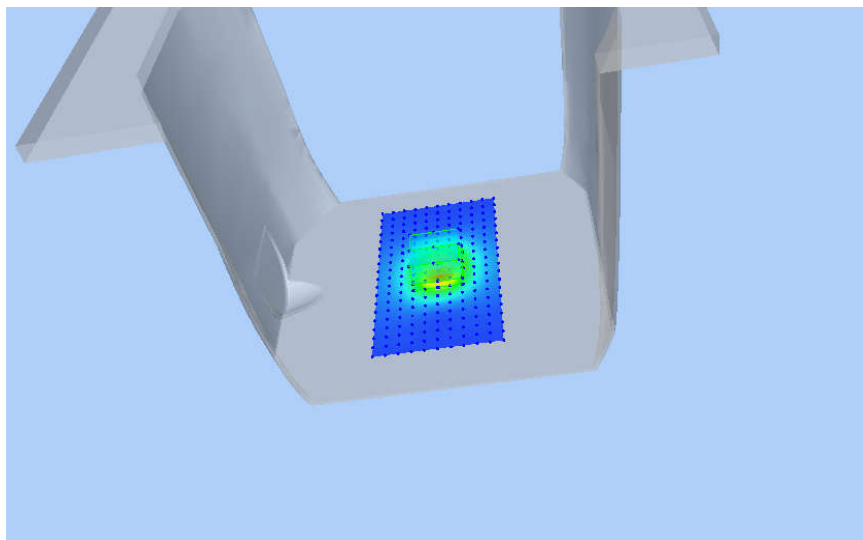
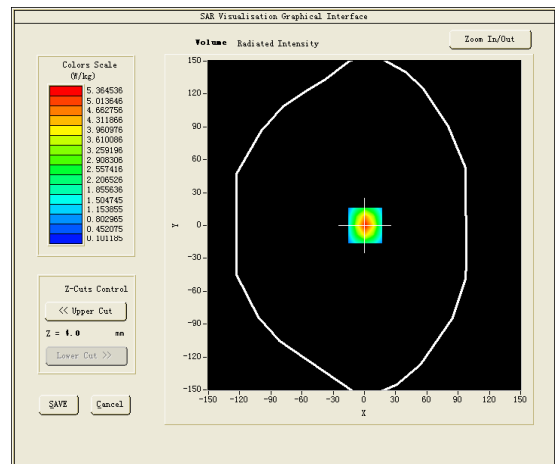
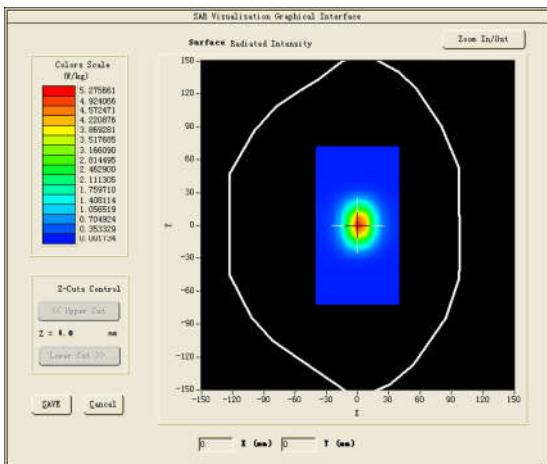

4.11 SAR Test Graph Results

SAR plots for the highest measured SAR in each exposure configuration, wireless mode and frequency band combination according to FCC KDB 865664 D02;

#1

Test Mode:GSM 850MHz,Lowchannel(Head LeftCheek)

Product Description:GSM/WCDMA Smartphone

Model:X30

Test Date:July 03, 2017

| | |
|-----------------------------------|----------------------------|
| Medium(liquid type) | MSL_850 |
| Frequency (MHz) | 824.200000 |
| Relative permittivity (real part) | 43.02 |
| Conductivity (S/m) | 0.90 |
| E-Field Probe | SN34/15 EPGO265 |
| Crest Factor | 8.0 |
| Conversion Factor | 2.04 |
| Sensor | 4mm |
| Area Scan | dx=8mm dy=8mm |
| Zoom Scan | 5x5x7,dx=8mm dy=8mm dz=5mm |
| Variation (%) | 1.660000 |
| SAR 10g (W/Kg) | 0.258116 |
| SAR 1g (W/Kg) | 0.357774 |
| SURFACE SAR | VOLUME SAR |

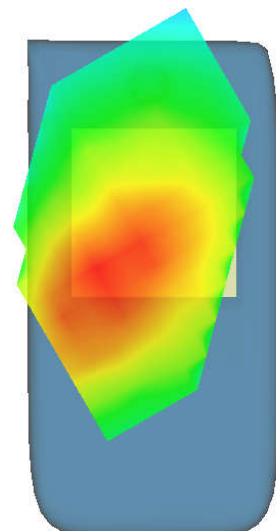
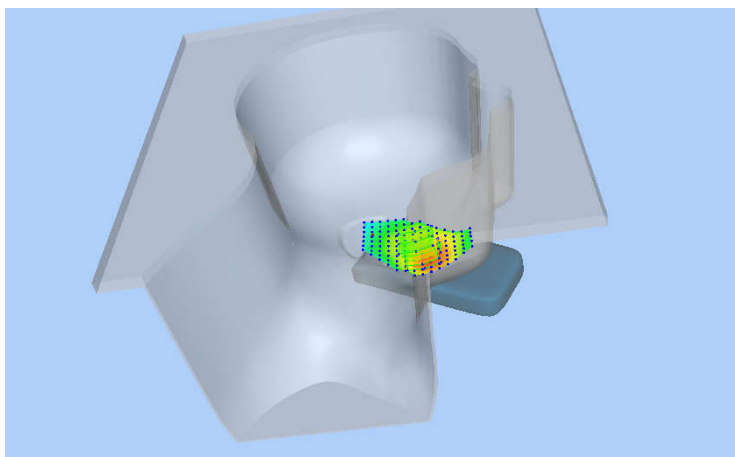
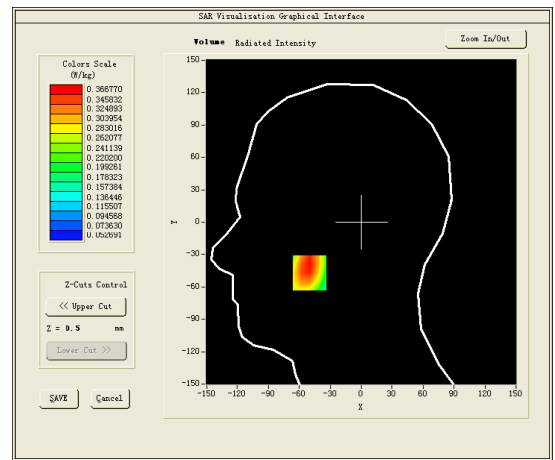
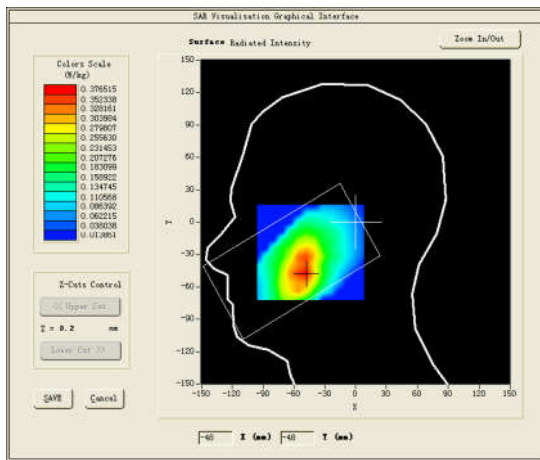

#2

Test Mode:Hotspot GSM850MHz,Lowchannel(Body Rear Side)

Product Description:GSM/WCDMA Smartphone

Model:X30

Test Date:July 04, 2017

| | |
|-----------------------------------|----------------------------|
| Medium(liquid type) | MSL_850 |
| Frequency (MHz) | 824.200000 |
| Relative permittivity (real part) | 53.72 |
| Conductivity (S/m) | 0.98 |
| E-Field Probe | SN34/15 EPGO265 |
| Crest Factor | 2.67 |
| Conversion Factor | 2.12 |
| Sensor | 4mm |
| Area Scan | dx=8mm dy=8mm |
| Zoom Scan | 5x5x7,dx=8mm dy=8mm dz=5mm |
| Variation (%) | 0.270000 |
| SAR 10g (W/Kg) | 0.251321 |
| SAR 1g (W/Kg) | 0.416444 |
| SURFACE SAR | VOLUME SAR |

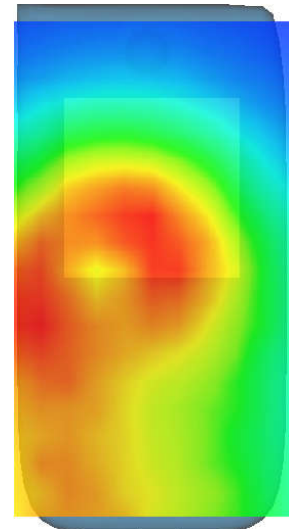
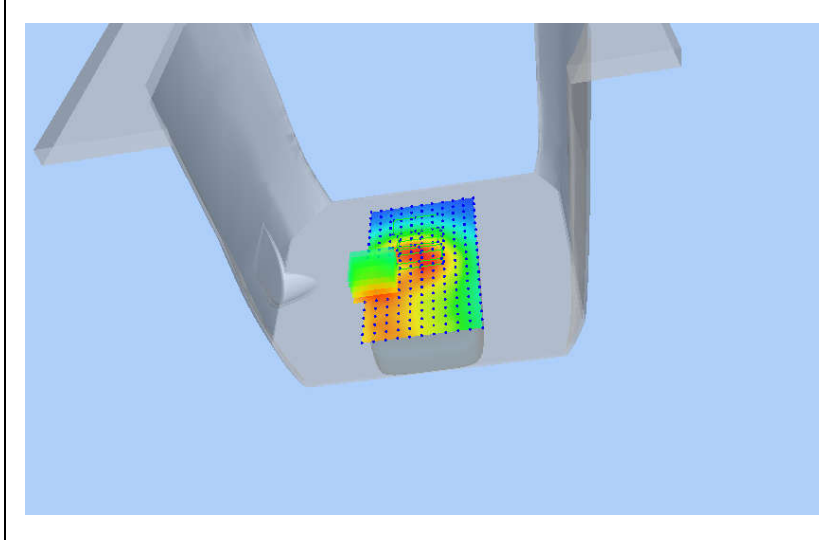
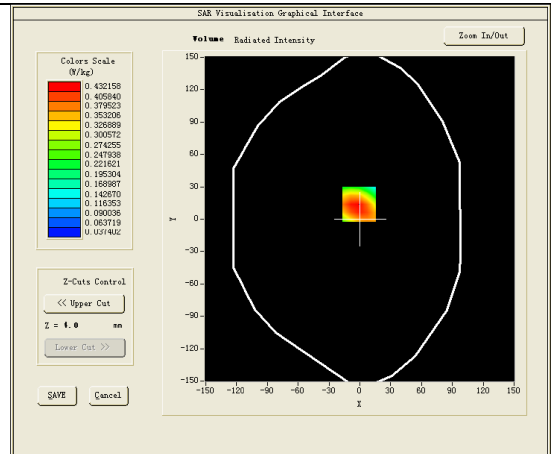
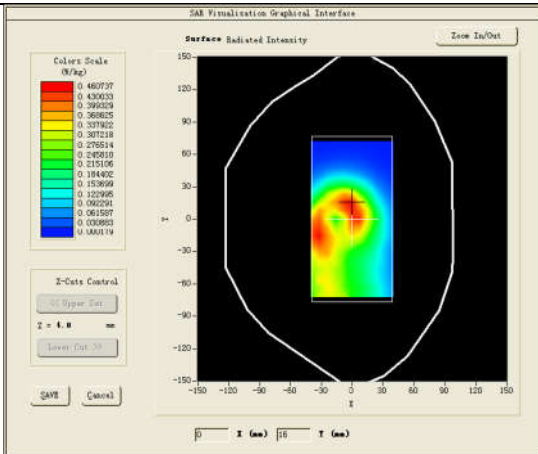

#3

Test Mode:GSM 1900MHz,Lowchannel(Head Left Cheek)
 Product Description:GSM/WCDMA Smartphone
 Model:X30
 Test Date:July 05, 2017

| | |
|-----------------------------------|----------------------------|
| Medium(liquid type) | MSL 1900 |
| Frequency (MHz) | 1850.200000 |
| Relative permittivity (real part) | 40.79 |
| Conductivity (S/m) | 1.42 |
| E-Field Probe | SN34/15 EPGO265 |
| Crest Factor | 8.0 |
| Conversion Factor | 2.35 |
| Sensor | 4mm |
| Area Scan | dx=8mm dy=8mm |
| Zoom Scan | 5x5x7,dx=8mm dy=8mm dz=5mm |
| Variation (%) | -0.500000 |
| SAR 10g (W/Kg) | 0.151318 |
| SAR 1g (W/Kg) | 0.260722 |
| SURFACE SAR | VOLUME SAR |

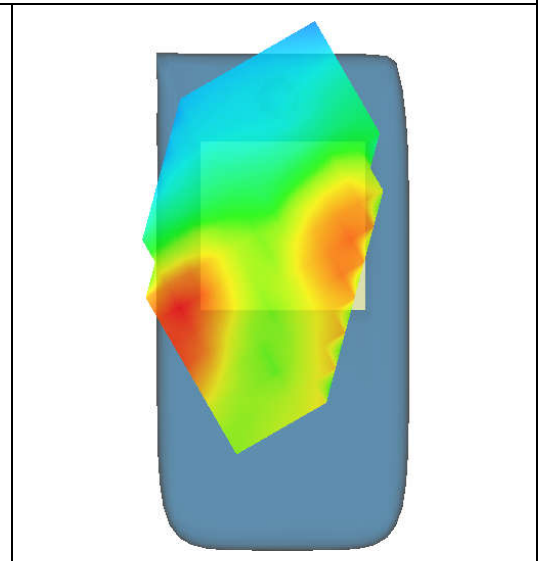
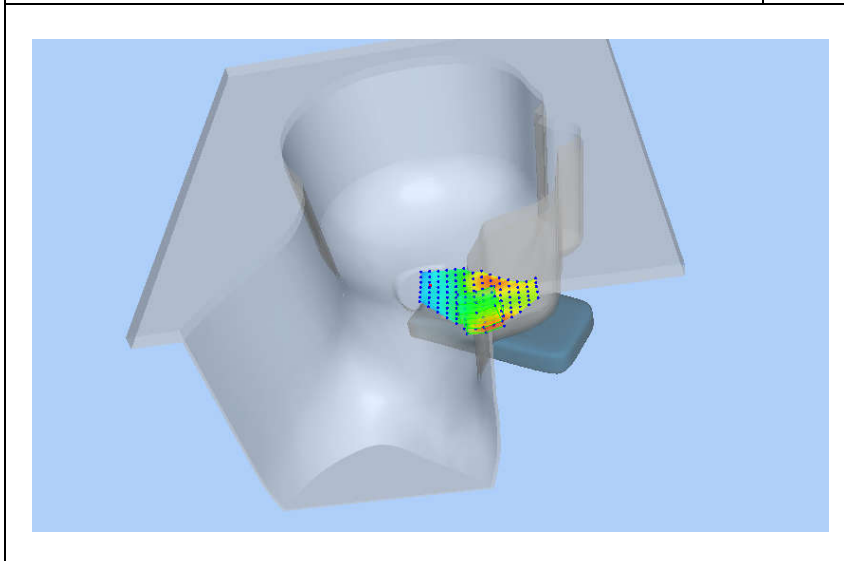
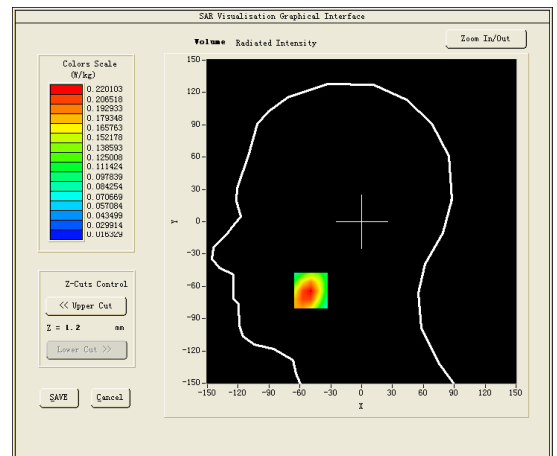
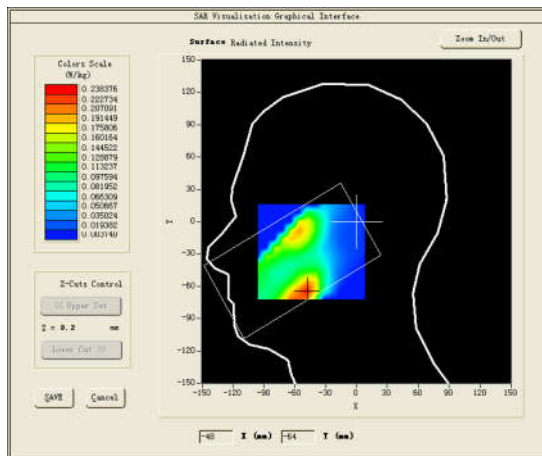

#4

Test Mode: Hotspot GPRS1900MHz,Highchannel(Body RearSide)
 Product Description:GSM/WCDMA Smartphone
 Model:X30
 Test Date:July 06, 2017

| | |
|-----------------------------------|----------------------------|
| Medium(liquid type) | MSL_1900 |
| Frequency (MHz) | 1909.800000 |
| Relative permittivity (real part) | 54.47 |
| Conductivity (S/m) | 1.57 |
| E-Field Probe | SN34/15 EPGO265 |
| Crest Factor | 2.67 |
| Conversion Factor | 2.42 |
| Sensor | 4mm |
| Area Scan | dx=8mm dy=8mm |
| Zoom Scan | 5x5x7,dx=8mm dy=8mm dz=5mm |
| Variation (%) | -1.150000 |
| SAR 10g (W/Kg) | 0.848624 |
| SAR 1g (W/Kg) | 1.361233 |

SURFACE SAR

VOLUME SAR

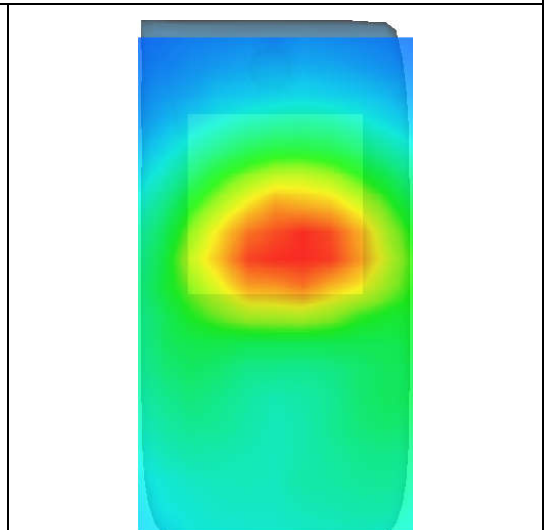
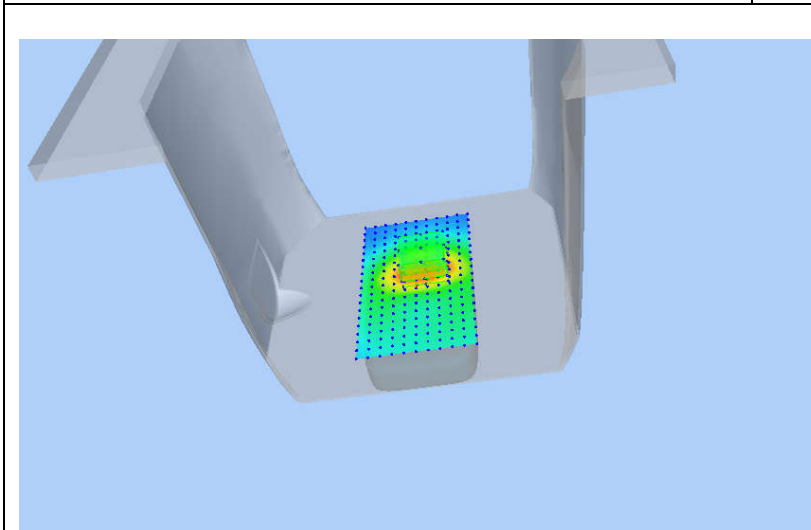
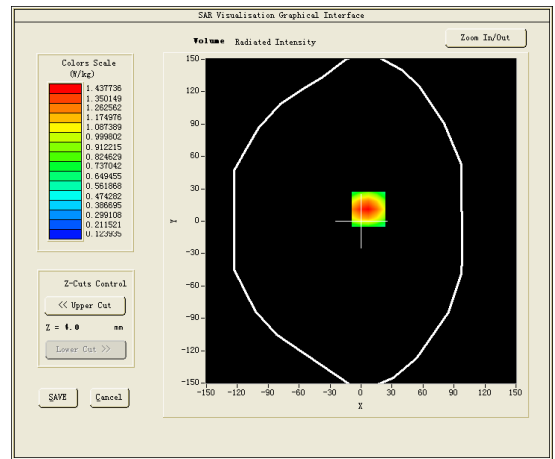
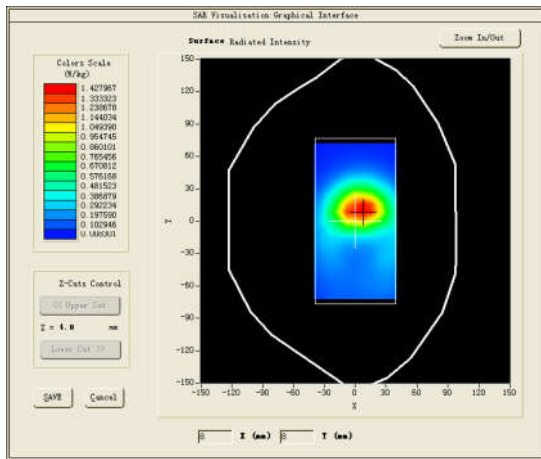

#5

Test Mode:WCDMA Band V,Lowchannel(Head LeftCheek)
 Product Description:GSM/WCDMA Smartphone
 Model:X30
 Test Date:July 03, 2017

| | |
|-----------------------------------|----------------------------|
| Medium(liquid type) | MSL 850 |
| Frequency (MHz) | 826.400000 |
| Relative permittivity (real part) | 43.02 |
| Conductivity (S/m) | 0.90 |
| E-Field Probe | SN34/15 EPGO265 |
| Crest Factor | 1.0 |
| Conversion Factor | 2.04 |
| Sensor | 4mm |
| Area Scan | dx=8mm dy=8mm |
| Zoom Scan | 5x5x7,dx=8mm dy=8mm dz=5mm |
| Variation (%) | 0.350000 |
| SAR 10g (W/Kg) | 0.278993 |
| SAR 1g (W/Kg) | 0.377714 |

SURFACE SAR

VOLUME SAR

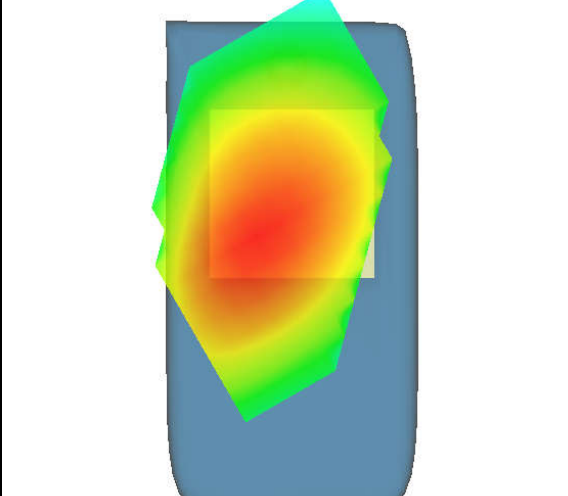
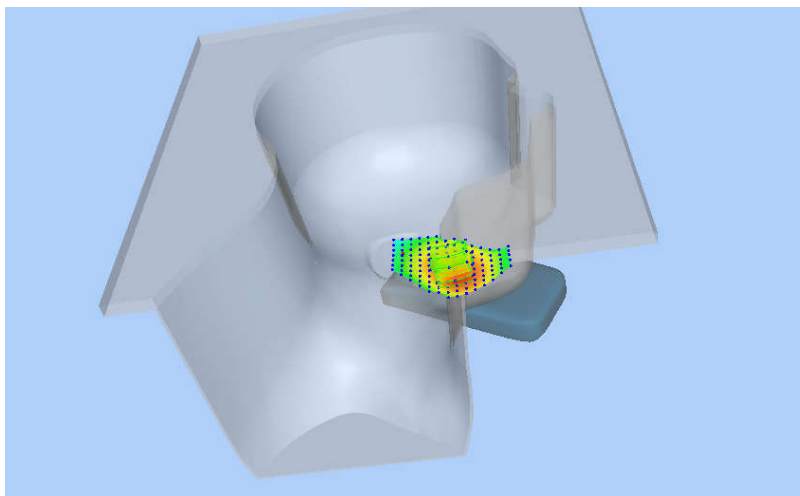
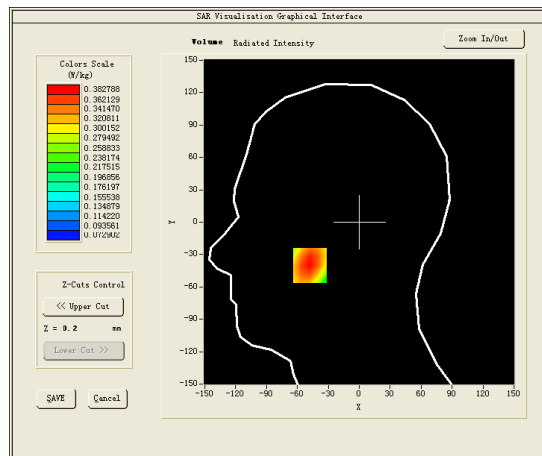
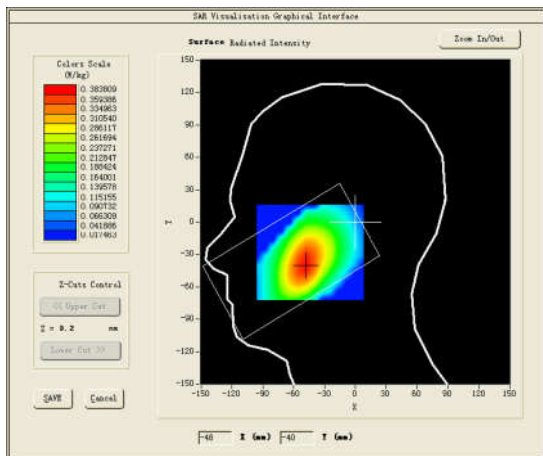

#6

Test Mode: Hotspot WCDMA Band V, Lowchannel(BodyFrontSide)
 Product Description: GSM/WCDMA Smartphone
 Model: X30
 Test Date: July 04, 2017

| | |
|-----------------------------------|-----------------------------|
| Medium(liquid type) | MSL_850 |
| Frequency (MHz) | 826.400000 |
| Relative permittivity (real part) | 53.72 |
| Conductivity (S/m) | 0.98 |
| E-Field Probe | SN34/15 EPGO265 |
| Crest Factor | 1.0 |
| Conversion Factor | 2.12 |
| Sensor | 4mm |
| Area Scan | dx=8mm dy=8mm |
| Zoom Scan | 5x5x7, dx=8mm dy=8mm dz=5mm |
| Variation (%) | 0.000000 |
| SAR 10g (W/Kg) | 0.318533 |
| SAR 1g (W/Kg) | 0.543851 |
| SURFACE SAR | VOLUME SAR |

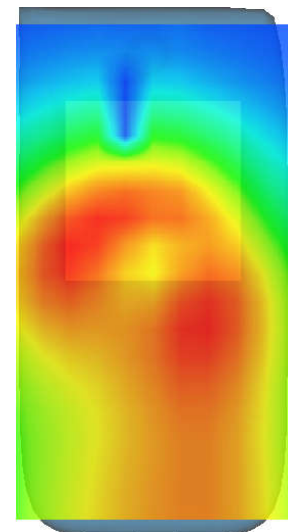
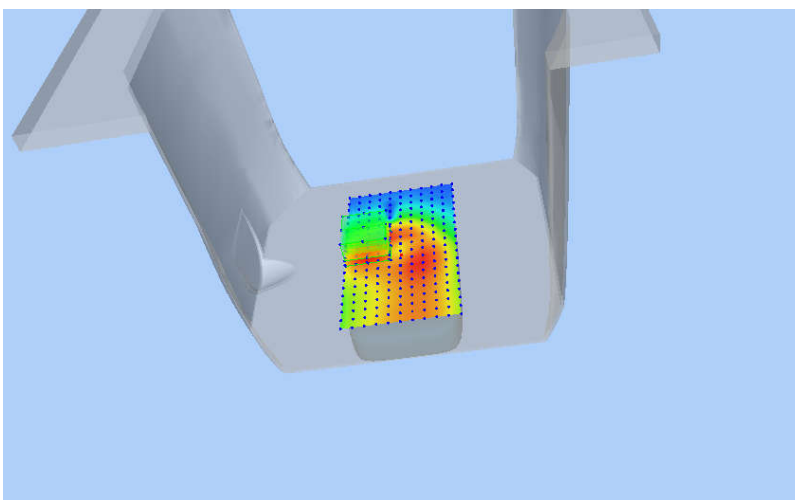
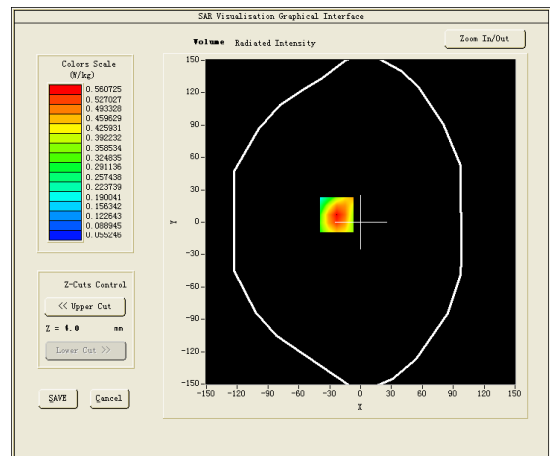
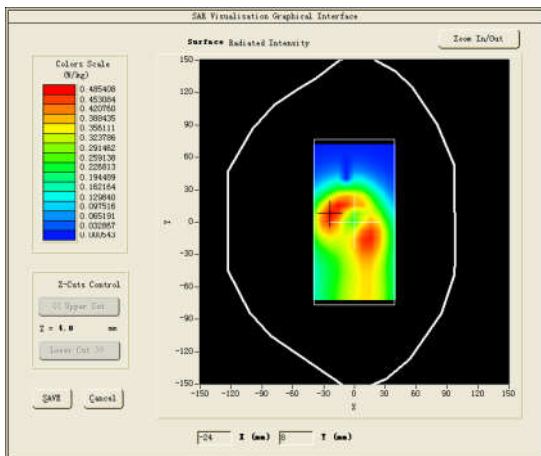

#7

Test Mode:WCDMA Band II,Highchannel(Head Left Cheek)
 Product Description:GSM/WCDMA Smartphone
 Model:X30
 Test Date:July 05, 2017

| | |
|-----------------------------------|----------------------------|
| Medium(liquid type) | MSL_1900 |
| Frequency (MHz) | 1907.600000 |
| Relative permittivity (real part) | 40.79 |
| Conductivity (S/m) | 1.42 |
| E-Field Probe | SN34/15 EPGO265 |
| Crest Factor | 1.0 |
| Conversion Factor | 2.35 |
| Sensor | 4mm |
| Area Scan | dx=8mm dy=8mm |
| Zoom Scan | 5x5x7,dx=8mm dy=8mm dz=5mm |
| Variation (%) | 1.630000 |
| SAR 10g (W/Kg) | 0.078007 |
| SAR 1g (W/Kg) | 0.126767 |
| SURFACE SAR | VOLUME SAR |

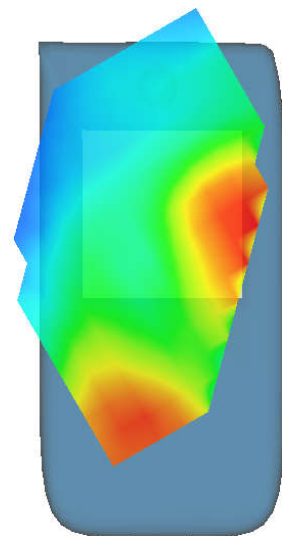
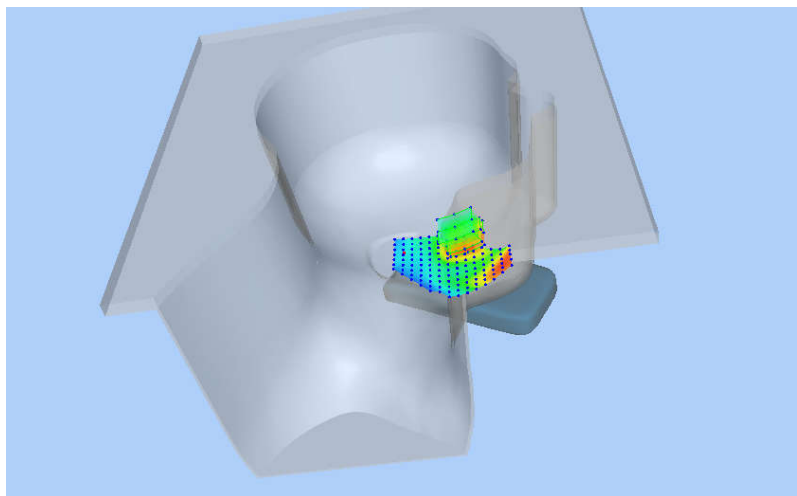
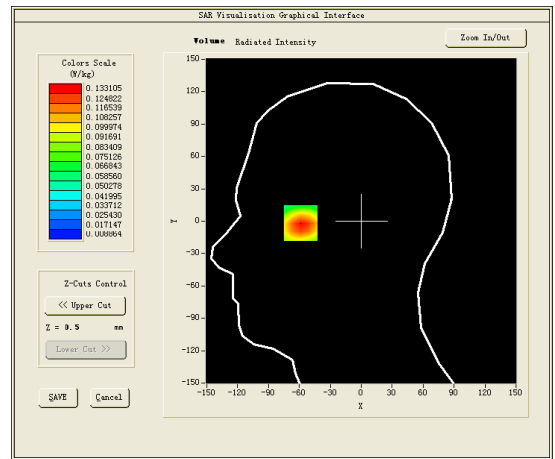
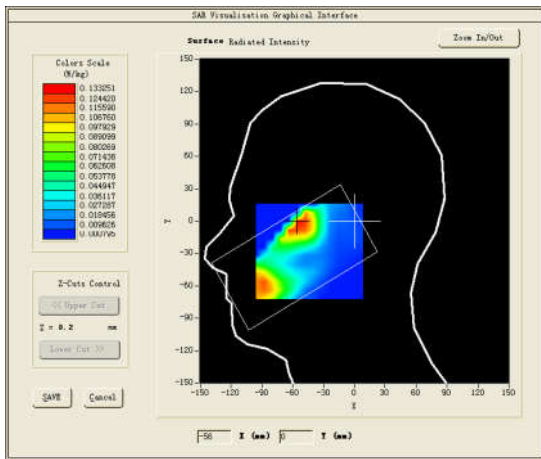

#8

Test Mode: Hotspot WCDMA Band II,Highchannel(Body FrontSide)
 Product Description:GSM/WCDMA Smartphone
 Model:X30
 Test Date:July 06, 2017

| | |
|-----------------------------------|----------------------------|
| Medium(liquid type) | MSL_1900 |
| Frequency (MHz) | 1907.600000 |
| Relative permittivity (real part) | 54.47 |
| Conductivity (S/m) | 1.57 |
| E-Field Probe | SN34/15 EPGO265 |
| Crest Factor | 1.0 |
| Conversion Factor | 2.42 |
| Sensor | 4mm |
| Area Scan | dx=8mm dy=8mm |
| Zoom Scan | 5x5x7,dx=8mm dy=8mm dz=5mm |
| Variation (%) | -4.390000 |
| SAR 10g (W/Kg) | 0.217310 |
| SAR 1g (W/Kg) | 0.315838 |

SURFACE SAR

VOLUME SAR

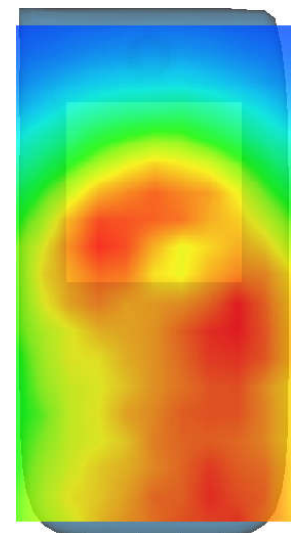
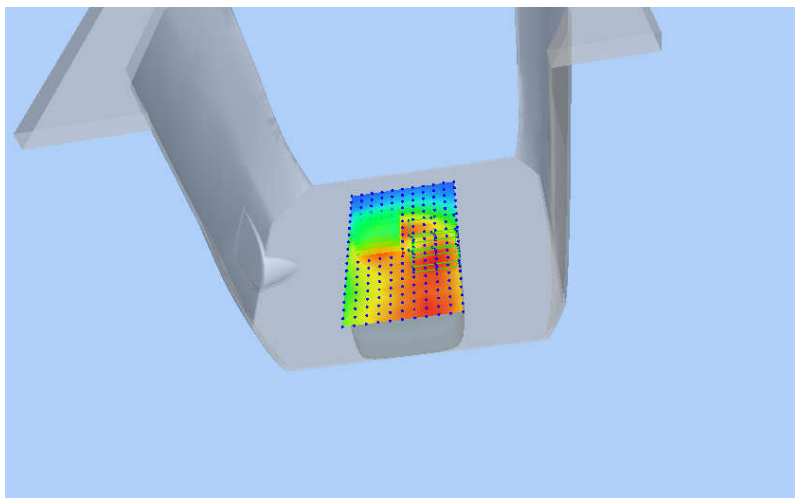
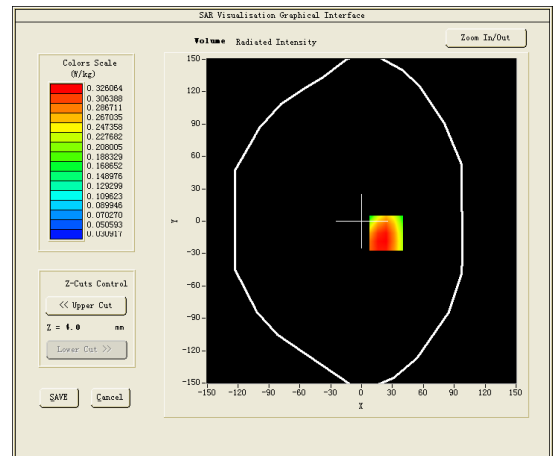
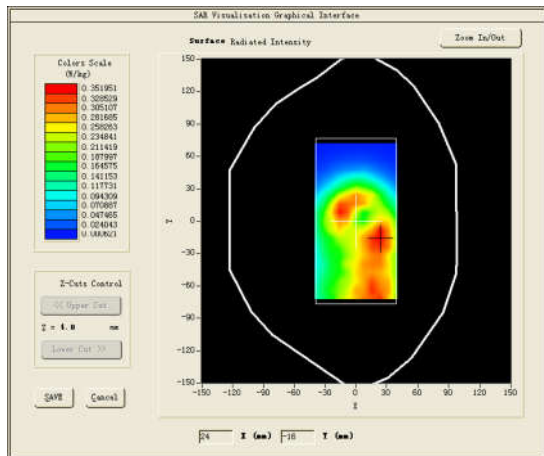

#9

Test Mode:802.11b(WiFi2.4G),Mid channel(Head Left Cheek)

Product Description:GSM/WCDMA Smartphone

Model:X30

Test Date:July 10, 2017

| | |
|-----------------------------------|----------------------------|
| Medium(liquid type) | MSL_2450 |
| Frequency (MHz) | 2437.000000 |
| Relative permittivity (real part) | 38.73 |
| Conductivity (S/m) | 1.81 |
| E-Field Probe | SN34/15 EPGO265 |
| Crest Factor | 1.0 |
| Conversion Factor | 2.47 |
| Sensor | 4mm |
| Area Scan | dx=8mm dy=8mm |
| Zoom Scan | 5x5x7,dx=8mm dy=8mm dz=5mm |
| Variation (%) | -4.640000 |
| SAR 10g (W/Kg) | 0.143156 |
| SAR 1g (W/Kg) | 0.300062 |

SURFACE SAR

VOLUME SAR

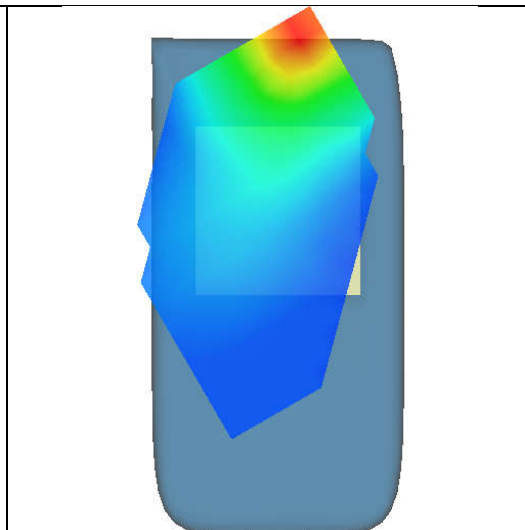
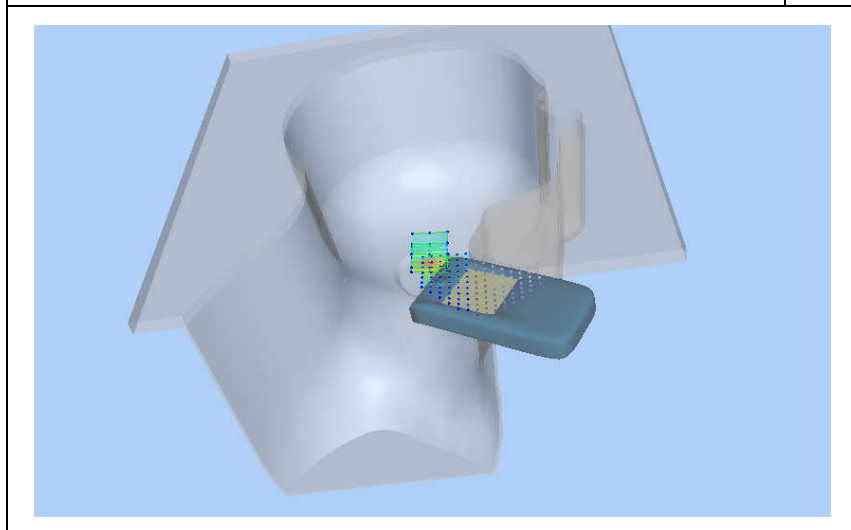
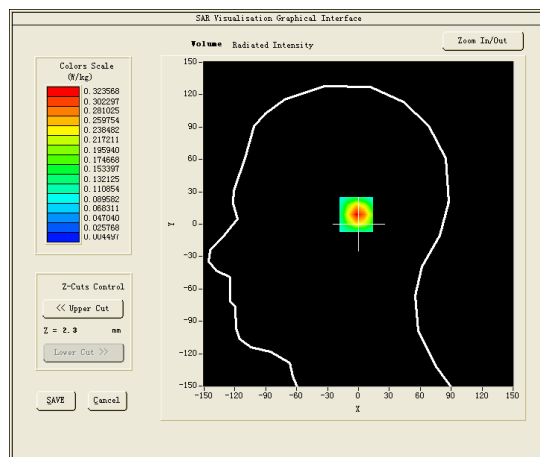
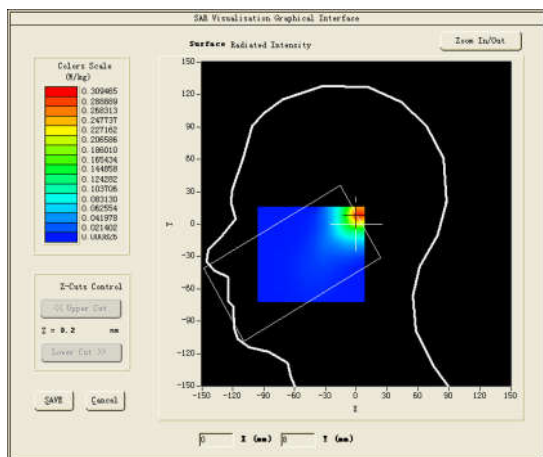

#10

Test Mode: Hotspot 802.11b(WiFi2.4G),Mid channel(BodyRearSide)
 Product Description:GSM/WCDMA Smartphone
 Model:X30
 Test Date:July 10, 2017

| | |
|-----------------------------------|----------------------------|
| Medium(liquid type) | MSL 2450 |
| Frequency (MHz) | 2437.000000 |
| Relative permittivity (real part) | 53.23 |
| Conductivity (S/m) | 1.96 |
| E-Field Probe | SN34/15 EPGO265 |
| Crest Factor | 1.0 |
| Conversion Factor | 2.55 |
| Sensor | 4mm |
| Area Scan | dx=8mm dy=8mm |
| Zoom Scan | 5x5x7,dx=8mm dy=8mm dz=5mm |
| Variation (%) | 3.550000 |
| SAR 10g (W/Kg) | 0.088710 |
| SAR 1g (W/Kg) | 0.177560 |

SURFACE SAR

VOLUME SAR

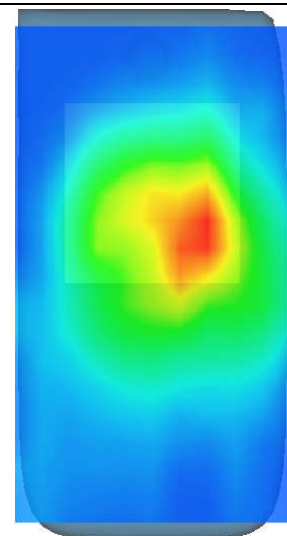
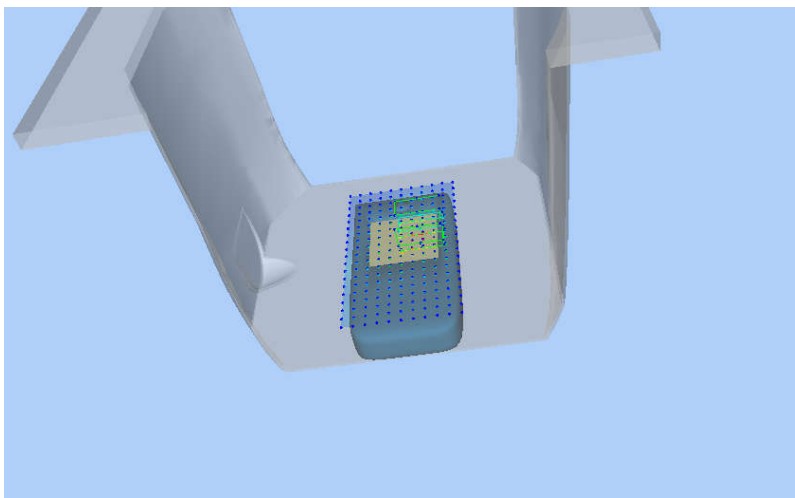
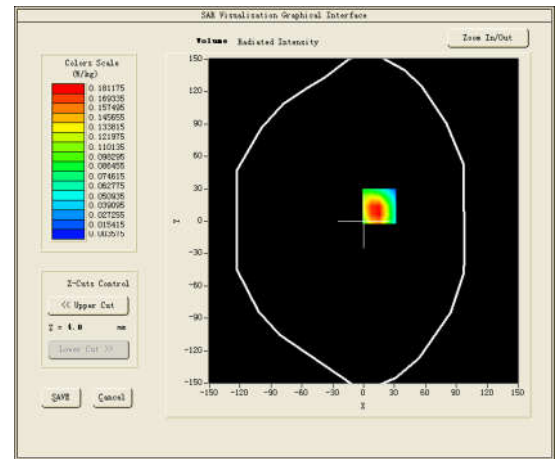
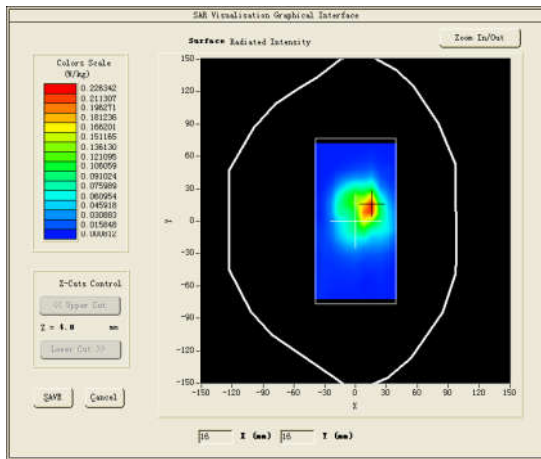

5. CALIBRATION CERTIFICATES

5.1 Probe-EPGO265 Calibration Certificate



COMOSAR E-Field Probe Calibration Report

Ref : ACR.294.1.16.SATU.A

SHENZHEN BALUN TECHNOLOGY CO.,LTD.
BLOCK B, FL 1, BAISHA SCIENCE AND TECHNOLOGY
PARK, SHAHE XI ROAD,
NANSHAN DISTRICT, SHENZHEN, GUANGDONG
PROVINCE, P.R. CHINA 518055
MVG COMOSAR DOSIMETRIC E-FIELD PROBE
SERIAL NO.: SN 34/15 EPGO265

Calibrated at MVG US
2105 Barrett Park Dr. - Kennesaw, GA 30144



Calibration Date: 09/15/2016

Summary:

This document presents the method and results from an accredited COMOSAR Dosimetric E-Field Probe calibration performed in MVG USA using the CALISAR / CALIBAIR test bench, for use with a COMOSAR system only. All calibration results are traceable to national metrology institutions.



COMOSAR E-FIELD PROBE CALIBRATION REPORT

Ref: ACR.294.1.16.SATU.A

| | <i>Name</i> | <i>Function</i> | <i>Date</i> | <i>Signature</i> |
|----------------------|---------------|-----------------|-------------|----------------------|
| <i>Prepared by :</i> | Jérôme LUC | Product Manager | 9/24/2016 | <i>JS</i> |
| <i>Checked by :</i> | Jérôme LUC | Product Manager | 9/24/2016 | <i>JS</i> |
| <i>Approved by :</i> | Kim RUTKOWSKI | Quality Manager | 9/24/2016 | <i>Kim Rutkowski</i> |

| | <i>Customer Name</i> |
|-----------------------|---|
| <i>Distribution :</i> | SHENZHEN BALUN TECHNOLOGY Co.,Ltd. |

| <i>Issue</i> | <i>Date</i> | <i>Modifications</i> |
|--------------|-------------|----------------------|
| A | 9/24/2016 | Initial release |
| | | |
| | | |
| | | |

Page: 2/10

*This document shall not be reproduced, except in full or in part, without the written approval of MVG.
The information contained herein is to be used only for the purpose for which it is submitted and is not to be released in whole or part without written approval of MVG.*



TABLE OF CONTENTS

1 Device Under Test 4

2 Product Description 4

 2.1 General Information 4

3 Measurement Method 4

 3.1 Linearity 4

 3.2 Sensitivity 5

 3.3 Lower Detection Limit 5

 3.4 Isotropy 5

 3.5 Boundary Effect 5

4 Measurement Uncertainty 5

5 Calibration Measurement Results 6

 5.1 Sensitivity in air 6

 5.2 Linearity 7

 5.3 Sensitivity in liquid 7

 5.4 Isotropy 8

6 List of Equipment 10



1 DEVICE UNDER TEST

| Device Under Test | |
|--|---|
| Device Type | COMOSAR DOSIMETRIC E FIELD PROBE |
| Manufacturer | MVG |
| Model | SSE2 |
| Serial Number | SN 34/15 EPGO265 |
| Product Condition (new / used) | New |
| Frequency Range of Probe | 0.45 GHz-6GHz |
| Resistance of Three Dipoles at Connector | Dipole 1: R1=0.192 MΩ Dipole 2: R2=0.230 MΩ Dipole 3: R3=0.205 MΩ |

A yearly calibration interval is recommended.

2 PRODUCT DESCRIPTION

2.1 GENERAL INFORMATION

MVG's COMOSAR E field Probes are built in accordance to the IEEE 1528, OET 65 Bulletin C and CEI/IEC 62209 standards.



Figure 1 – MVG COMOSAR Dosimetric E field Dipole

| | |
|--|--------|
| Probe Length | 330 mm |
| Length of Individual Dipoles | 2 mm |
| Maximum external diameter | 8 mm |
| Probe Tip External Diameter | 2.5 mm |
| Distance between dipoles / probe extremity | 1 mm |

3 MEASUREMENT METHOD

The IEEE 1528, OET 65 Bulletin C, CENELEC EN50361 and CEI/IEC 62209 standards provide recommended practices for the probe calibrations, including the performance characteristics of interest and methods by which to assess their affect. All calibrations / measurements performed meet the fore mentioned standards.

3.1 LINEARITY

The evaluation of the linearity was done in free space using the waveguide, performing a power sweep to cover the SAR range 0.01W/kg to 100W/kg.

Page: 4/10

*This document shall not be reproduced, except in full or in part, without the written approval of MVG.
The information contained herein is to be used only for the purpose for which it is submitted and is not to be released in whole or part without written approval of MVG.*



3.2 SENSITIVITY

The sensitivity factors of the three dipoles were determined using a two step calibration method (air and tissue simulating liquid) using waveguides as outlined in the standards.

3.3 LOWER DETECTION LIMIT

The lower detection limit was assessed using the same measurement set up as used for the linearity measurement. The required lower detection limit is 10 mW/kg.

3.4 ISOTROPY

The axial isotropy was evaluated by exposing the probe to a reference wave from a standard dipole with the dipole mounted under the flat phantom in the test configuration suggested for system validations and checks. The probe was rotated along its main axis from 0 - 360 degrees in 15 degree steps. The hemispherical isotropy is determined by inserting the probe in a thin plastic box filled with tissue-equivalent liquid, with the plastic box illuminated with the fields from a half wave dipole. The dipole is rotated about its axis (0°-180°) in 15° increments. At each step the probe is rotated about its axis (0°-360°).

3.5 BOUNDARY EFFECT

The boundary effect is defined as the deviation between the SAR measured data and the expected exponential decay in the liquid when the probe is oriented normal to the interface. To evaluate this effect, the liquid filled flat phantom is exposed to fields from either a reference dipole or waveguide. With the probe normal to the phantom surface, the peak spatial average SAR is measured and compared to the analytical value at the surface.

4 MEASUREMENT UNCERTAINTY

The guidelines outlined in the IEEE 1528, OET 65 Bulletin C, CENELEC EN50361 and CEI/IEC 62209 standards were followed to generate the measurement uncertainty associated with an E-field probe calibration using the waveguide technique. All uncertainties listed below represent an expanded uncertainty expressed at approximately the 95% confidence level using a coverage factor of k=2, traceable to the Internationally Accepted Guides to Measurement Uncertainty.

| Uncertainty analysis of the probe calibration in waveguide | | | | | |
|--|-----------------------|--------------------------|------------|----|--------------------------|
| ERROR SOURCES | Uncertainty value (%) | Probability Distribution | Divisor | ci | Standard Uncertainty (%) |
| Incident or forward power | 3.00% | Rectangular | $\sqrt{3}$ | 1 | 1.732% |
| Reflected power | 3.00% | Rectangular | $\sqrt{3}$ | 1 | 1.732% |
| Liquid conductivity | 5.00% | Rectangular | $\sqrt{3}$ | 1 | 2.887% |
| Liquid permittivity | 4.00% | Rectangular | $\sqrt{3}$ | 1 | 2.309% |
| Field homogeneity | 3.00% | Rectangular | $\sqrt{3}$ | 1 | 1.732% |
| Field probe positioning | 5.00% | Rectangular | $\sqrt{3}$ | 1 | 2.887% |

This document shall not be reproduced, except in full or in part, without the written approval of MVG. The information contained herein is to be used only for the purpose for which it is submitted and is not to be released in whole or part without written approval of MVG.



COMOSAR E-FIELD PROBE CALIBRATION REPORT

Ref: ACR.294.1.16.SATU.A

| | | | | | |
|--|-------|-------------|------------|---|--------|
| Field probe linearity | 3.00% | Rectangular | $\sqrt{3}$ | 1 | 1.732% |
| Combined standard uncertainty | | | | | 5.831% |
| Expanded uncertainty 95 % confidence level k = 2 | | | | | 12.0% |

5 CALIBRATION MEASUREMENT RESULTS

| Calibration Parameters | |
|------------------------|-------|
| Liquid Temperature | 21 °C |
| Lab Temperature | 21 °C |
| Lab Humidity | 45 % |

5.1 SENSITIVITY IN AIR

| Normx dipole 1 ($\mu\text{V}/(\text{V}/\text{m})^2$) | Normy dipole 2 ($\mu\text{V}/(\text{V}/\text{m})^2$) | Normz dipole 3 ($\mu\text{V}/(\text{V}/\text{m})^2$) |
|---|---|---|
| 0.72 | 0.81 | 0.85 |

| DCP dipole 1 (mV) | DCP dipole 2 (mV) | DCP dipole 3 (mV) |
|----------------------|----------------------|----------------------|
| 92 | 90 | 95 |

Calibration curves $e_i=f(V)$ ($i=1,2,3$) allow to obtain E-field value using the formula:

$$E = \sqrt{E_1^2 + E_2^2 + E_3^2}$$

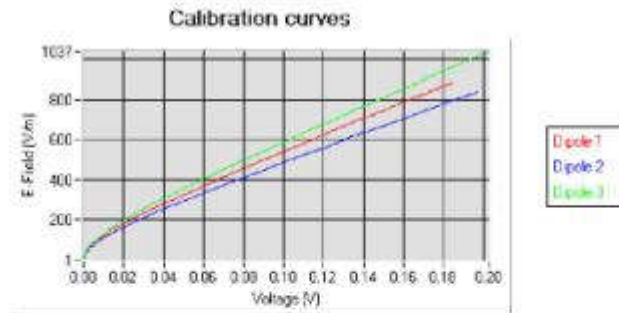

*This document shall not be reproduced, except in full or in part, without the written approval of MVG.
The information contained herein is to be used only for the purpose for which it is submitted and is not to be released in whole or part without written approval of MVG.*