

FCC TEST REPORT
FOR
Shenzhen KVD Communication Equipment Limited
GSM/WCDMA Smartphone
Model No.: X10
Additional Model No.: Please refer to page 6

Prepared for : Shenzhen KVD Communication Equipment Limited
Address : Lenovo R&D Center 2F-B, South First Road, High-tech Park,
Nanshan District, Shenzhen, Guangdong, China

Prepared by : Shenzhen LCS Compliance Testing Laboratory Ltd.
Address : 1/F., Xingyuan Industrial Park, Tongda Road, Bao'an Avenue,
Bao'an District, Shenzhen, Guangdong, China

Tel : (+86)755-82591330
Fax : (+86)755-82591332
Web : www.LCS-cert.com
Mail : webmaster@LCS-cert.com

Date of receipt of test sample : Apr 28, 2017
Number of tested samples : 1
Serial number : Prototype
Date of Test : Apr 28, 2017~May 19, 2017
Date of Report : May 19, 2017

FCC TEST REPORT
FCC CFR 47 PART 15 C(15.247)

Report Reference No. : LCS170428102AE

Date of Issue : May 19, 2017

Testing Laboratory Name : Shenzhen LCS Compliance Testing Laboratory Ltd.

Address : 1/F., Xingyuan Industrial Park, Tongda Road, Bao'an Avenue, Bao'an District, Shenzhen, Guangdong, China

Testing Location/ Procedure : Full application of Harmonised standards [X]
Partial application of Harmonised standards []
Other standard testing method []

Applicant's Name : Shenzhen KVD Communication Equipment Limited

Address : Lenovo R&D Center 2F-B, South First Road, High-tech Park, Nanshan District, Shenzhen, Guangdong, China

Test Specification

Standard : FCC CFR 47 PART 15 C(15.247)

Test Report Form No. : LCSEMC-1.0

TRF Originator : Shenzhen LCS Compliance Testing Laboratory Ltd.

Master TRF : Dated 2011-03

Shenzhen LCS Compliance Testing Laboratory Ltd. All rights reserved.

This publication may be reproduced in whole or in part for non-commercial purposes as long as the Shenzhen LCS Compliance Testing Laboratory Ltd. is acknowledged as copyright owner and source of the material. Shenzhen LCS Compliance Testing Laboratory Ltd. takes no responsibility for and will not assume liability for damages resulting from the reader's interpretation of the reproduced material due to its placement and context.

Test Item Description : GSM/WCDMA Smartphone

Trade Mark : DOOGEE, LIKUID

Model/ Type reference : X10, ZINCO

Ratings : DC 3.8V by Li-ion Battery(3360mAh)
Charging parameter: Input: 100~240V AC, 50/60Hz, 0.2A;
Output: DC 5V, 1A

Result : Positive

Compiled by:

Calvin Weng

Supervised by:

Glin Lu

Approved by:

Gavin Liang

Calvin Weng/ Administrators

Glin Lu/ Technique principal

Gavin Liang/ Manager

FCC -- TEST REPORT

Test Report No. : LCS170428102AE	<u>May 19, 2017</u> Date of issue
--	--------------------------------------

EUT.....	: GSM/WCDMA Smartphone
Type / Model.....	: X10
Applicant.....	: Shenzhen KVD Communication Equipment Limited
Address.....	: Lenovo R&D Center 2F-B, South First Road, High-tech Park, Nanshan District, Shenzhen, Guangdong, China
Telephone.....	:
Fax.....	:
Manufacturer.....	: Shenzhen KVD Communication Equipment Limited
Address.....	: A, 3rd floor, Building A2, Silicon valley Digital Industrial Park, 22nd of Dafu industrial area, Aobei Community, Guanlan town, Longhua District, shenzhen 518000, China
Telephone.....	:
Fax.....	:
Factory.....	: Shenzhen KVD Communication Equipment Limited
Address.....	: A, 3rd floor, Building A2, Silicon valley Digital Industrial Park, 22nd of Dafu industrial area, Aobei Community, Guanlan town, Longhua District, shenzhen 518000, China
Telephone.....	:
Fax.....	:

Test Result	Positive
--------------------	-----------------

The test report merely corresponds to the test sample.
It is not permitted to copy extracts of these test result without the written permission of the test laboratory.

Revision History

Revision	Issue Date	Revisions	Revised By
00	May 19, 2017	Initial Issue	Gavin Liang

TABLE OF CONTENTS

Description	Page
1. GENERAL INFORMATION	6
1.1 Description of Device (EUT)	6
1.2. Host System Configuration List and Details	6
1.3. External I/O Cable	7
1.4. Description of Test Facility	7
1.5. Statement of the Measurement Uncertainty	7
1.6. Measurement Uncertainty	7
1.7 Description of Test Modes	8
2. TEST METHODOLOGY	9
2.1 EUT Configuration	9
2.2 EUT Exercise	9
2.3 General Test Procedures	9
3. SYSTEM TEST CONFIGURATION	10
3.1 Justification	10
3.2 EUT Exercise Software	10
3.3 Special Accessories	10
3.4 Block Diagram/Schematics	10
3.5 Equipment Modifications	10
3.6 Test Setup	10
4. SUMMARY OF TEST RESULTS.....	11
5. SUMMARY OF TEST EQUIPMENT	12
6. ANTENNA PORT MEASUREMENT	13
6.1 Peak Power	13
6.2 Frequency Separation and 20 dB Bandwidth	16
6.3 Number of Hopping Frequency	23
6.4 Time of Occupancy (Dwell Time)	25
6.5 Conducted Spurious Emissions and Band Edges Test	28
7. RADIATED MEASUREMENT	34
8. POWER LINE CONDUCTED EMISSIONS	44
9. ANTENNA REQUIREMENT	46
10. TEST SETUP PHOTOGRAPHS OF EUT.....	47
11. EXTERIOR PHOTOGRAPHS OF THE EUT	47
12. INTERIOR PHOTOGRAPHS OF THE EUT	47

1. GENERAL INFORMATION

1.1 Description of Device (EUT)

Name of EUT	GSM/WCDMA Smartphone
Model Number	X10, ZINCO
Modulation Type	GMSK for GSM/GPRS, 8-PSK for EDGE,QPSK for UMTS, QPSK, 16QAM for LTE
Antenna Gain	0 dBi (max.) For GSM 850, GSM 900, DCS 1800, PCS 1900; 0 dBi (max.) For WCDMA Band II, V; -1 dBi (max.) For BT and WLAN
Hardware version	JC45B_MB_V1.0_20161227
Software version	V1.0
GSM/EDGE/GPRS Operation Frequency Band	GSM850/PCS1900/GPRS850/GPRS1900/EDGE850/EDGE1900
UMTS Operation Frequency Band	UMTS FDD Band II/V
LTE Operation Frequency Band	Not Supported
GSM/EDGE/GPRS	Supported GSM/GPRS/EDGE
GSM Release Version	R99
GSM/EDGE/GPRS Power Class	GSM850:Power Class 4/ PCS1900:Power Class 1
GPRS/EDGE Multislot Class	GPRS/EDGE: Multi-slot Class 12
GPRS operation mode	Class B
WCDMA Release Version	R99
HSDPA Release Version	Release 8
HSUPA Release Version	Release 6
DC-HSUPA Release Version	Not Supported
LTE Release Version	Not Supported
LTE/UMTS Power Class	Not Supported
WLAN FCC Modulation Type	IEEE 802.11b: DSSS(CCK,DQPSK,DBPSK) IEEE 802.11g: OFDM(64QAM, 16QAM, QPSK, BPSK) IEEE 802.11n HT20/40: OFDM (64QAM, 16QAM, QPSK,BPSK)
WLAN FCC Operation frequency	IEEE 802.11b:2412-2462MHz IEEE 802.11g:2412-2462MHz IEEE 802.11n HT20:2412-2462MHz IEEE 802.11n HT40:2422-2452MHz
Antenna Type	PIFA Antenna
BT Modulation Type	GFSK,8-DPSK, π /4DQPSK(BT V4.0)
Extreme temp. Tolerance	-30°C to +50°C
GPS function	Support and only RX
NFC Function	Not Supported
Extreme vol. Limits	3.40VDC to 4.20VDC (nominal: 3.80VDC)

1.2. Host System Configuration List and Details

Manufacturer	Description	Model	Serial Number	Certificate
Shenzhen HuaJin Electronics CO., LTD	Power Adapter	HJ-0501000E1-US	---	FCC VoC

1.3. External I/O Cable

I/O Port Description	Quantity	Cable
USB	1	1m, unshielded cable
Earphone	1	N/A

1.4. Description of Test Facility

CNAS Registration Number. is L4595.
 FCC Registration Number. is 899208.
 Industry Canada Registration Number. is 9642A-1.
 ESMD Registration Number. is ARCB0108.
 UL Registration Number. is 100571-492.
 TUV SUD Registration Number. is SCN1081.
 TUV RH Registration Number. is UA 50296516-001

The 3m-Semi anechoic test site fulfils CISPR 16-1-4 according to ANSI C63.4:2014 and CISPR 16-1-4:2010 SVSWR requirement for radiated emission above 1GHz.

1.5. Statement of the Measurement Uncertainty

The data and results referenced in this document are true and accurate. The reader is cautioned that there may be errors within the calibration limits of the equipment and facilities. The measurement uncertainty was calculated for all measurements listed in this test report acc. To CISPR 16 – 4 “Specification for radio disturbance and immunity measuring apparatus and methods – Part 4: Uncertainty in EMC Measurements” and is documented in the LCS quality system acc. to DIN EN ISO/IEC 17025. Furthermore, component and process variability of devices similar to that tested may result in additional deviation. The manufacturer has the sole responsibility of continued compliance of the device.

1.6. Measurement Uncertainty

Test Item	Frequency Range	Uncertainty	Note
Radiation Uncertainty	9KHz~30MHz	±3.10dB	(1)
	30MHz~200MHz	±2.96dB	(1)
	200MHz~1000MHz	±3.10dB	(1)
	1GHz~26.5GHz	±3.80dB	(1)
	26.5GHz~40GHz	±3.90dB	(1)
Conduction Uncertainty	150kHz~30MHz	±1.63dB	(1)
Power disturbance	30MHz~300MHz	±1.60dB	(1)

(1). This uncertainty represents an expanded uncertainty expressed at approximately the 95% confidence level using a coverage factor of k=2.

1.7 Description of Test Modes

Bluetooth operates in the unlicensed ISM Band at 2.4GHz. With basic data rate feature, the data rates can be up to 1 Mb/s by modulating the RF carrier using GFSK techniques. The EUT works in the X-axis, Y-axis, Z-axis. The following operating modes were applied for the related test items. All test modes were tested, only the result of the worst case was recorded in the report.

Mode of Operations	Frequency Range (MHz)	Data Rate (Mbps)
BT V 3.0	2402	1/2/3
	2441	1/2/3
	2480	1/2/3
For Conducted Emission		
Test Mode		TX Mode
For Radiated Emission		
Test Mode		TX Mode

Worst-case mode and channel used for 150 KHz-30 MHz power line conducted emissions was the mode and channel with the highest output power that was determined to be TX (1Mbps).

Worst-case mode and channel used for 9kHz-1000 MHz radiated emissions was the mode and channel with the highest output power, that was determined to be TX(1Mbps-High Channel).

AC conducted emission pre-test at both at AC 120V/60Hz and AC 240V/50Hz modes, recorded worst case;

AC conducted emission pre-test at both at power adapter and power from PC modes, recorded worst case;

Bluetooth V3.0 (DSS) frequency & channel list:

Channel	Frequency(MHz)	Channel	Frequency(MHz)
1	2402	41	2442
2	2403	42	2443
--	--	--	--
38	2439	78	2479
39	2440	79	2480
40	2441		

2. TEST METHODOLOGY

The tests documented in this report were performed in accordance with ANSI C63.10-2013, FCC CFR PART 15C 15.207, 15.209, 15.247 and DA 00-705.

2.1 EUT Configuration

The EUT configuration for testing is installed on RF field strength measurement to meet the Commissions requirement and operating in a manner that intends to maximize its emission characteristics in a continuous normal application.

2.2 EUT Exercise

The EUT was operated in the engineering mode to fix the TX frequency that was for the purpose of the measurements.

According to its specifications, the EUT must comply with the requirements of the Section 15.207, 15.209, 15.247 under the FCC Rules Part 15 Subpart C.

2.3 General Test Procedures

2.3.1 Conducted Emissions

The EUT is directly placed on the ground. According to the requirements in Section 6.2.1 of ANSI C63.10-2013 Conducted emissions from the EUT measured in the frequency range between 0.15 MHz and 30MHz using Quasi-peak and average detector modes.

2.3.2 Radiated Emissions

The EUT is placed on a turntable, which is directly placed on the ground. The turntable shall rotate 360 degrees to determine the position of maximum emission level. EUT is set 3m away from the receiving antenna, which varied from 1m to 4m to find out the highest emission. And also, each emission was to be maximized by changing the polarization of receiving antenna both horizontal and vertical. In order to find out the maximum emissions, exploratory radiated emission measurements were made according to the requirements in Section 6.3 of ANSI C63.10-2013

3. SYSTEM TEST CONFIGURATION

3.1 Justification

The system was configured for testing in a continuous transmits condition.

3.2 EUT Exercise Software

The sample is controlled by using dialing engineering code (***#3646633#**) to control sample change channel, modulation and so on;

3.3 Special Accessories

No.	Equipment	Manufacturer	Model No.	Serial No.	Length	shielded/ unshielded	Notes
1	PC	Lenovo	Ideapad	A13110155 0	/	/	DOC
2	Power adapter	Lenovo	CPA-A090	36200414	1.00m	unshielded	DOC

3.4 Block Diagram/Schematics

Please refer to the related document.

3.5 Equipment Modifications

Shenzhen LCS Compliance Testing Laboratory Ltd. has not done any modification on the EUT.

3.6 Test Setup

Please refer to the test setup photo.

4. SUMMARY OF TEST RESULTS

Applied Standard: FCC Part 15 Subpart C		
FCC Rules	Description of Test	Result
§15.247(b)(1)	Maximum Conducted Output Power	Compliant
§15.247(c)	Frequency Separation and 20 dB Bandwidth	Compliant
§15.247(a)(1)(ii)	Number Of Hopping Frequency	Compliant
§15.247(a)(1)(iii)	Time Of Occupancy (Dwell Time)	Compliant
§15.209, §15.205	Conducted Spurious Emissions and Band Edges Test	Compliant
§15.209, §15.247(d)	Radiated and Conducted Spurious Emissions	Compliant
§15.207(a)	Conducted Emissions	Compliant
§15.203	Antenna Requirements	Compliant
§15.247(i)§2.1093	RF Exposure	Compliant

5. SUMMARY OF TEST EQUIPMENT

Item	Equipment	Manufacturer	Model No.	Serial No.	Last Cal.	Next Cal.
1	Power Sensor	R&S	NRV-Z51	100458	2016-06-18	2017-06-17
2	Power Sensor	R&S	NRV-Z32	10057	2016-06-18	2017-06-17
3	Power Meter	R&S	NRVS	100444	2016-06-18	2017-06-17
4	DC Filter	MPE	23872C	N/A	2016-06-18	2017-06-17
5	RF Cable	Harbour Industries	1452	N/A	2016-06-18	2017-06-17
6	SMA Connector	Harbour Industries	9625	N/A	2016-06-18	2017-06-17
7	Spectrum Analyzer	Agilent	N9020A	MY50510140	2016-10-27	2017-10-26
8	Signal analyzer	Agilent	E4448A(External mixers to 40GHz)	US44300469	2016-06-16	2017-06-15
9	RF Cable	Hubersuhne	Sucoflex104	FP2RX2	2016-06-18	2017-06-17
10	3m Semi Anechoic Chamber	SIDT FRANKONIA	SAC-3M	03CH03-HY	2016-06-18	2017-06-17
11	Amplifier	SCHAFFNER	COA9231A	18667	2017-04-18	2018-04-17
12	Amplifier	Agilent	8449B	3008A02120	2017-04-18	2018-04-17
13	Amplifier	MITEQ	AMF-6F-260400	9121372	2017-04-18	2018-04-17
14	Loop Antenna	R&S	HFH2-Z2	860004/001	2017-04-18	2018-04-17
15	By-log Antenna	SCHWARZBECK	VULB9163	9163-470	2017-04-18	2018-04-17
16	Horn Antenna	EMCO	3115	6741	2017-04-18	2018-04-17
17	Horn Antenna	SCHWARZBECK	BBHA9170	BBHA9170154	2017-04-18	2018-04-17
18	RF Cable-R03m	Jye Bao	RG142	CB021	2016-06-18	2017-06-17
19	RF Cable-HIGH	SUHNER	SUCOFLEX 106	03CH03-HY	2016-06-18	2017-06-17
20	EMI Test Receiver	R&S	ESCI	101142	2016-06-18	2017-06-17
21	Artificial Mains	R&S	ENV216	101288	2016-06-18	2017-06-17
22	EMI Test Software	AUDIX	E3	N/A	2016-06-18	2017-06-17

6. ANTENNA PORT MEASUREMENT

6.1 Peak Power

6.1.1 Block Diagram of Test Setup

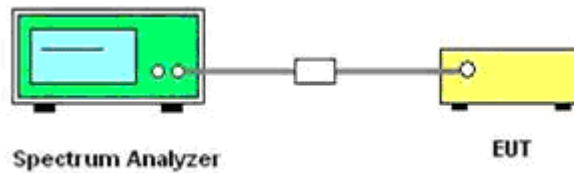

6.1.2 Limit

According to §15.247(b)(1), For frequency hopping systems operating in the 2400–2483.5 MHz band employing at least 75 non-overlapping hopping channels, and all frequency hopping systems in the 5725–5850 MHz band: 1 watt. For all other frequency hopping system in the 2400–2483.5 MHz band: 0.125 watts.

6.1.3 Test Procedure

Use the following spectrum analyzer settings:

Span = approximately 5 times the 20 dB bandwidth, centered on a hopping channel

RBW > the 20 dB bandwidth of the emission being measured

VBW ≥ RBW

Sweep = auto

Detector function = peak

Trace = max hold

Allow the trace to stabilize. Use the marker-to-peak function to set the marker to the peak of the emission. The indicated level is the peak output power

6.1.4 Test Results

Test Mode	Channel	Frequency (MHz)	Measured Maximum Power (dBm)	Limits (dBm)	Verdict
GFSK	0	2402	3.656	30.00	PASS
	39	2441	3.975		
	78	2480	4.192		
π/4DQPSK	0	2402	3.108	21.00	PASS
	39	2441	3.395		
	78	2480	3.582		
8-DPSK	0	2402	3.180	21.00	PASS
	39	2441	3.481		
	78	2480	3.679		

Remark:

1. Test results including cable loss;
2. Measured output power at difference Packet Type for each mode and recorded worst case for each mode.
3. Worst case data at DH1 for GFSK, 2DH1 for π/4DQPSK, 3DH1 for 8-DPSK modulation type;

Peak Output Power

GFSK

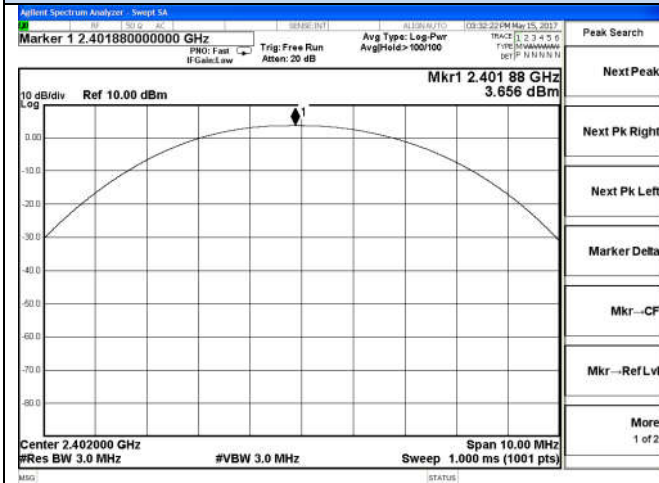

$\pi/4$ -DQPSK

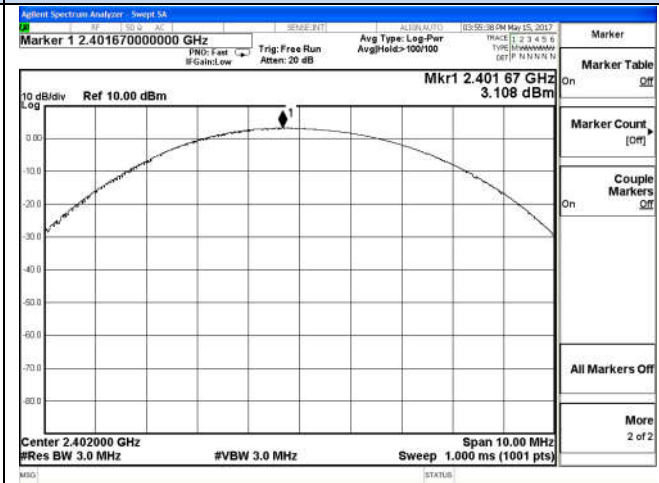

Channel 0 / 2402 MHz

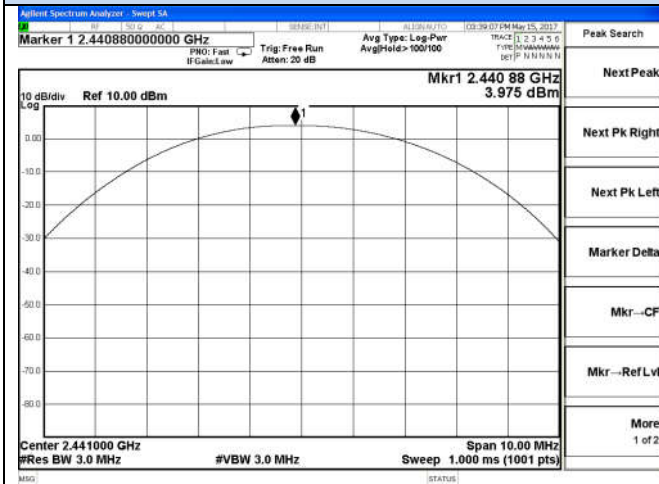

Channel 0 / 2402 MHz

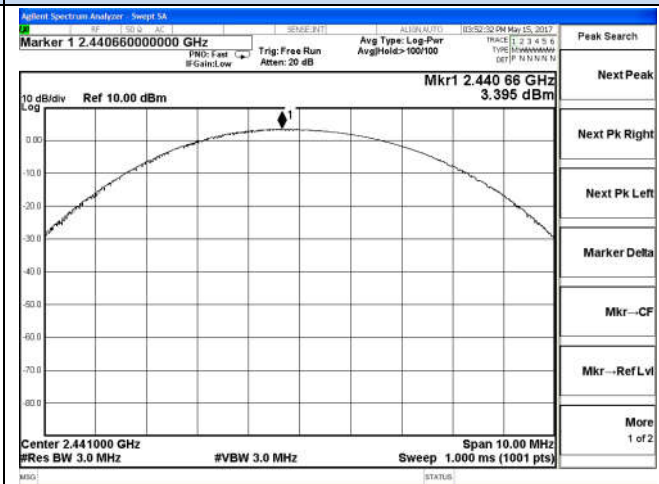

Channel 39 / 2441 MHz

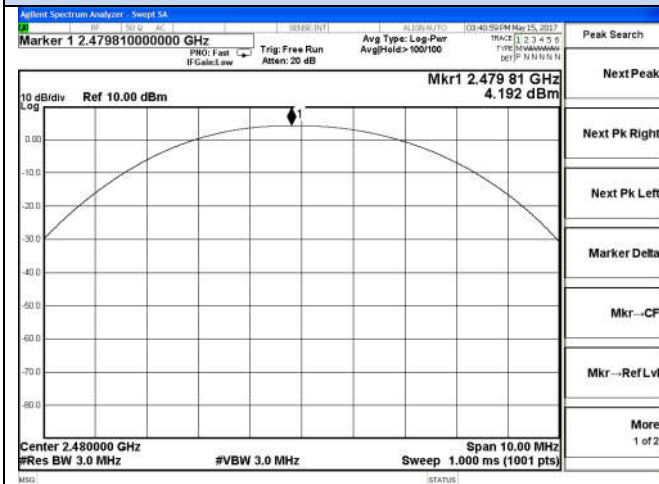

Channel 39 / 2441 MHz

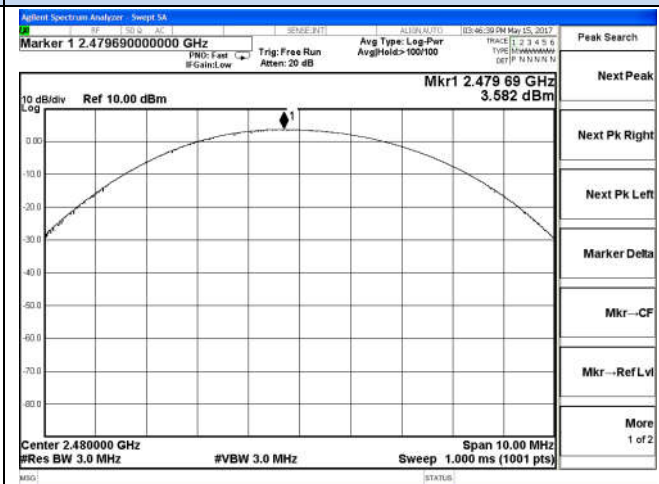

Channel 78 / 2480 MHz



Channel 78 / 2480 MHz

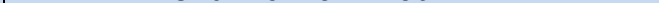

Peak Output Power

8-DPSK

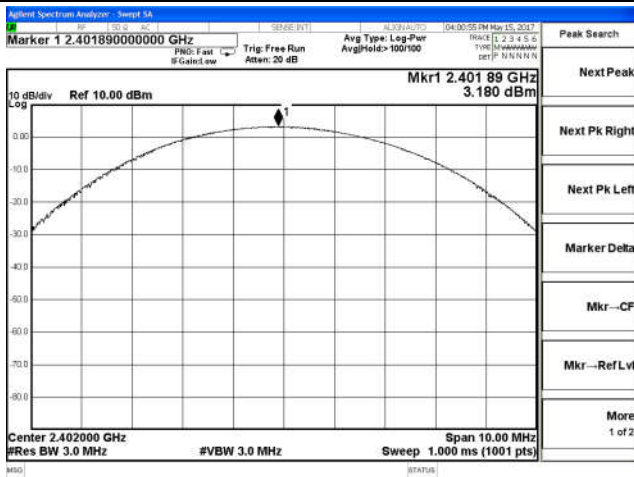

8-DPSK

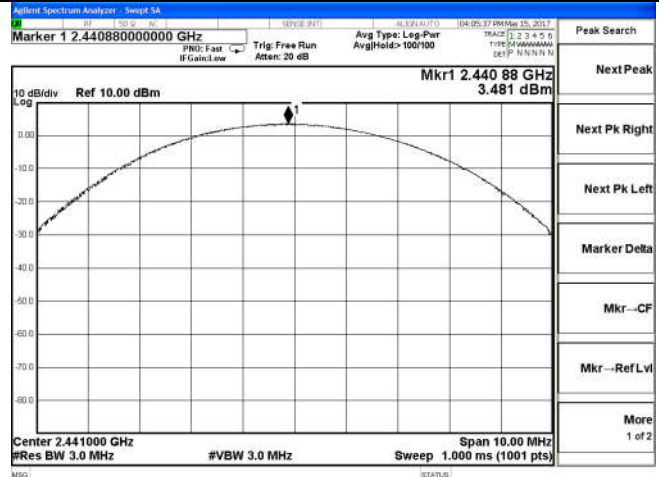

Channel 0 / 2402 MHz

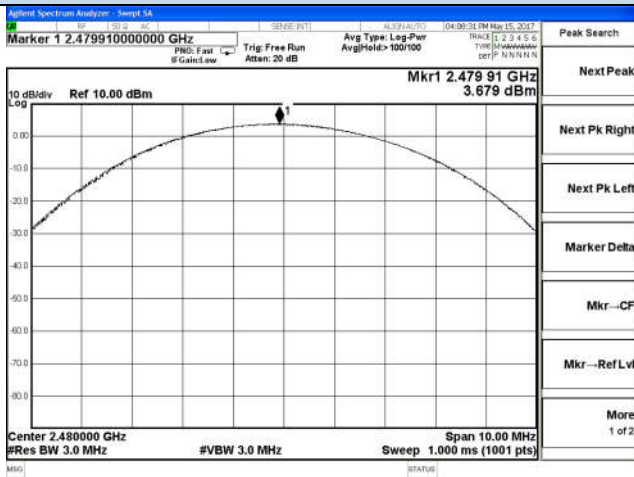

Channel 39 / 2441 MHz

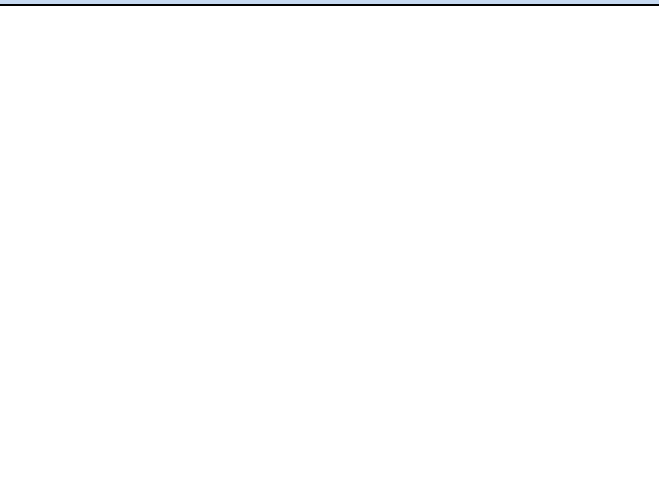

Channel 78 / 2480 MHz

6.2 Frequency Separation and 20 dB Bandwidth

6.2.1 Limit

§15.247(a) (1) Frequency hopping systems shall have hopping channel carrier frequencies separated by a minimum of 25 kHz or the 20 dB bandwidth of the hopping channel, whichever is greater. Alternatively, frequency hopping systems operating in the 2400-2483.5 MHz band may have hopping channel carrier frequencies that are separated by 25 kHz or two-thirds of the 20 dB bandwidth of the hopping channel, whichever is greater, provided the systems operate with an output power no greater than 125 mW.

6.2.2 Block Diagram of Test Setup

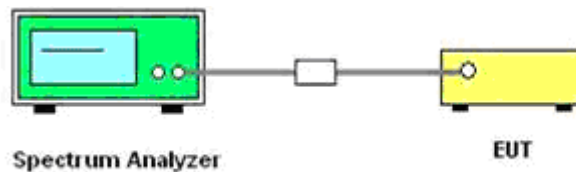

6.2.3 Test Procedure

Frequency separation test procedure :

- 1). Place the EUT on the table and set it in transmitting mode.
- 2). Remove the antenna from the EUT and then connect a low loss RF cable from the antenna port to the Spectrum Analyzer.
- 3). Set center frequency of Spectrum Analyzer = middle of hopping channel.
- 4). Set the Spectrum Analyzer as RBW = 100 KHz, VBW = 300 KHz, Span = wide enough to capture the peaks of two adjacent channels, Sweep = auto.
- 5). Max hold, mark 2 peaks of hopping channel and record the 2 peaks frequency.

20dB bandwidth test procedure :

- 1). Span = approximately 2 to 3 times the 20 dB bandwidth, centered on a hopping channel.
- 2). RBW = 30 KHz, VBW = 100 KHz.
- 3). Detector function = peak.
- 4). Trace = max hold.

6.2.4 Test Results

6.2.4.1 20dB Bandwidth

Test Mode	Channel	Frequency (MHz)	Measured Bandwidth (KHz)		Limits (KHz)	Verdict
			99%	20dB		
GFSK	0	2402	839.07	830.4	No Limits	PASS
	39	2441	835.24	825.3		
	78	2480	834.47	828.2		
$\pi/4$ DQPSK	0	2402	1064.2	1118	No Limits	PASS
	39	2441	1063.5	1119		
	78	2480	1063.7	1118		
8-DPSK	0	2402	1101.4	1163	No Limits	PASS
	39	2441	1101.4	1165		
	78	2480	1101.2	1164		

Remark:

1. Test results including cable loss;
2. Measured output power at difference Packet Type for each mode and recorded worst case for each mode.
3. Worst case data at DH1 for GFSK, 2DH1 for $\pi/4$ DQPSK, 3DH1 for 8-DPSK modulation type;
4. Please refer following test plots;

20dB Bandwidth and 99% Bandwidth

GFSK

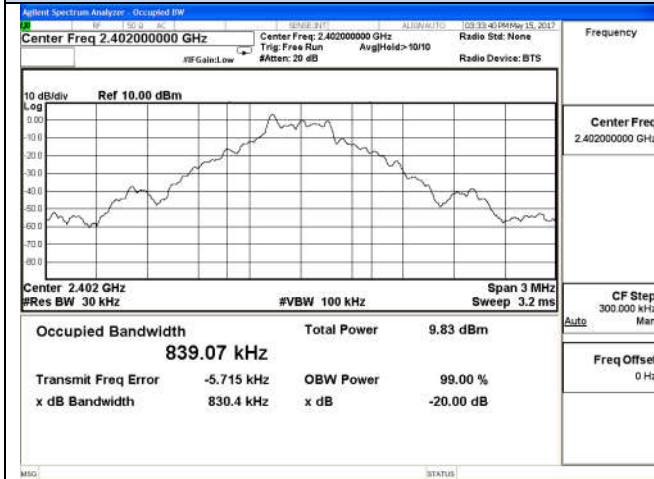

$\pi/4$ DQPSK

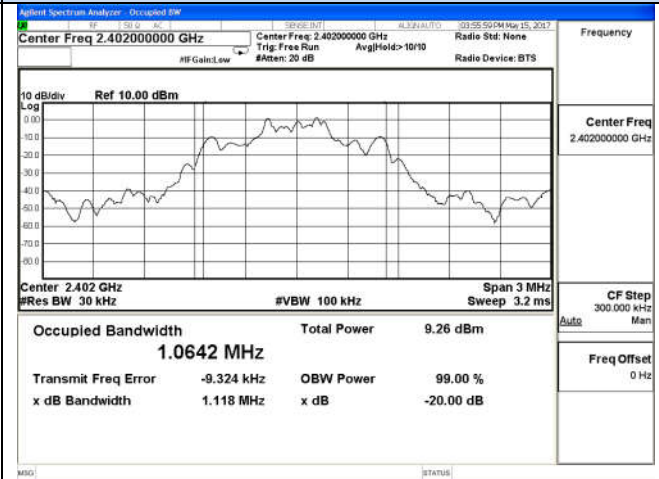

Channel 0 / 2402 MHz

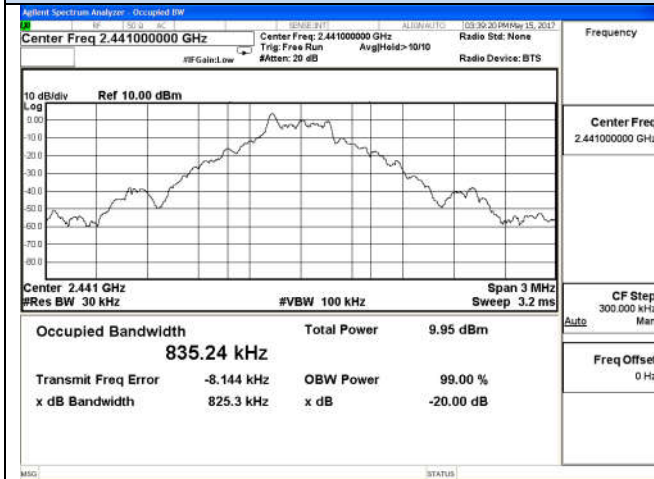

Channel 0 / 2402 MHz

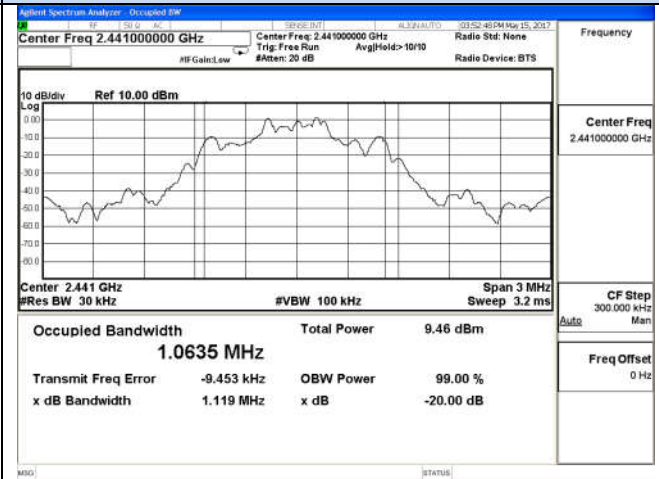

Channel 39 / 2441 MHz

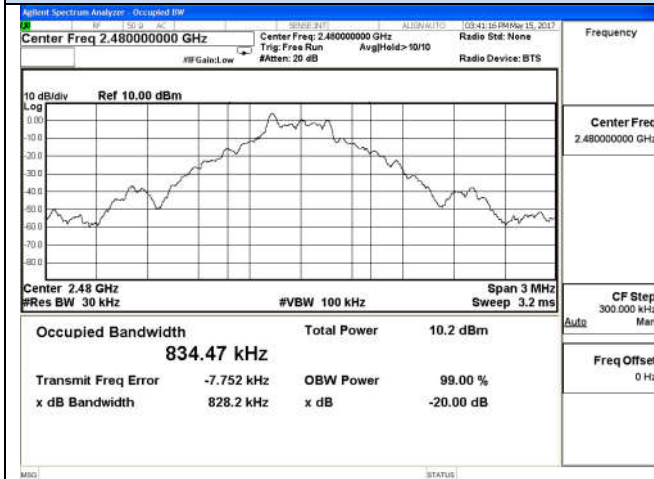

Channel 39 / 2441 MHz

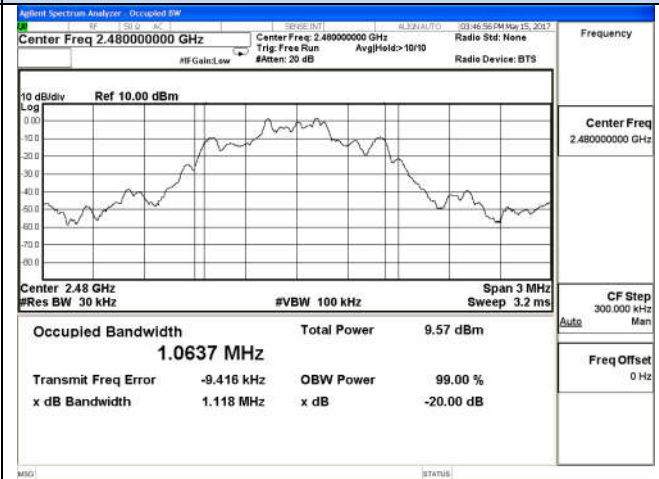

Channel 78 / 2480 MHz

Channel 78 / 2480 MHz

20dB Bandwidth and 99% Bandwidth

8-DPSK

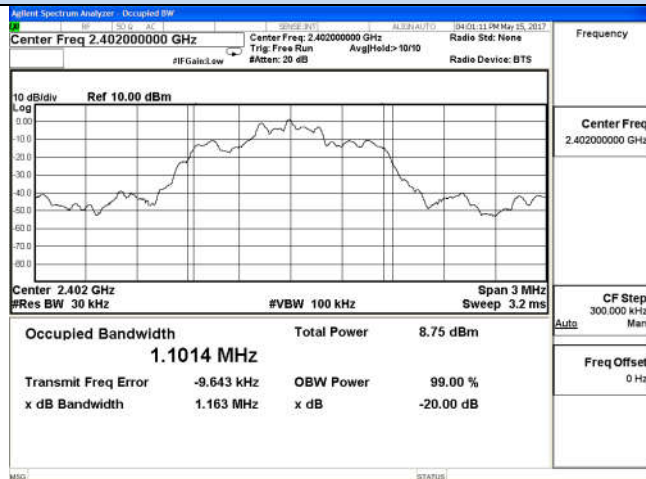

8-DPSK

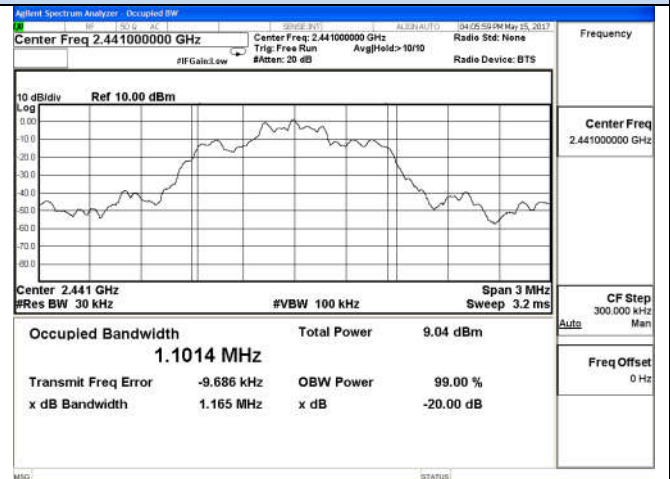

Channel 0 / 2402 MHz

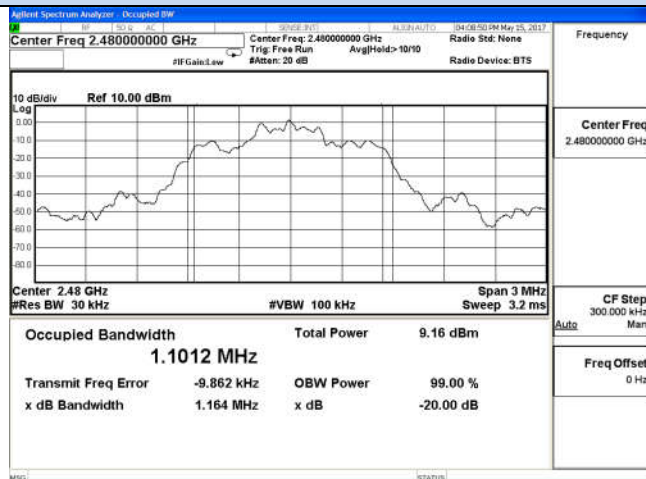

Channel 39 / 2441 MHz

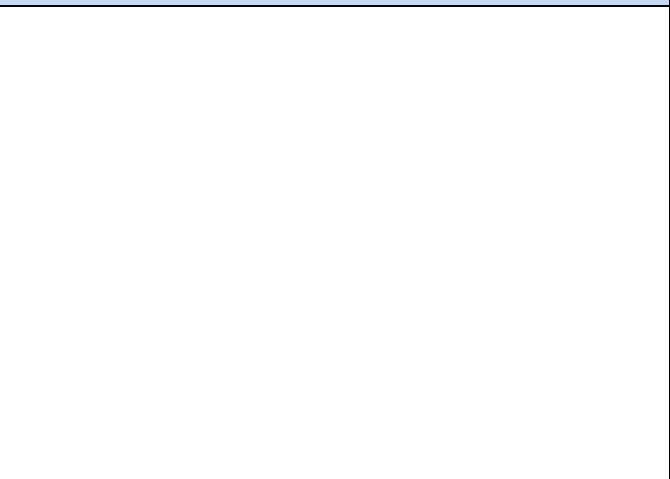

Channel 78 / 2480 MHz

6.2.4.2 Frequency Separation

The Measurement Result With 1Mbps For GFSK Modulation				
Channel	20dB Bandwidth (KHz)	Channel Separation (KHz)	Limit (KHz)	Result
Low	830.4	1000	830.4	Pass
Middle	825.3		825.3	Pass
High	828.2		828.2	Pass
The Measurement Result With 2Mbps For $\pi/4$ -DQPSK Modulation				
Channel	20dB Bandwidth (KHz)	Channel Separation (KHz)	Limit (KHz)	Result
Low	1118	1000	745.33	Pass
Middle	1119		746.00	Pass
High	1118		745.33	Pass
The Measurement Result With 3Mbps For 8-DPSK Modulation				
Channel	20dB Bandwidth (KHz)	Channel Separation (KHz)	Limit (KHz)	Result
Low	1163	1000	775.33	Pass
Middle	1165		776.67	Pass
High	1164		776.00	Pass

Remark:

1. Test results including cable loss;
2. Please refer to following plots;
3. Measured at difference Packet Type for each mode and recorded worst case for each mode.
4. Worst case data at DH1 for GFSK, 2DH1 for $\pi/4$ -DQPSK, 3DH1 for 8-DPSK modulation type;

Frequency Separation

GFSK

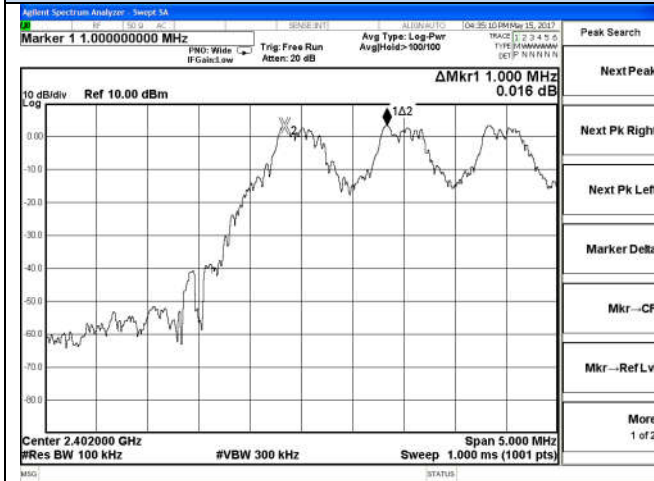

$\pi/4$ DQPSK



Channel 0 / 2402 MHz

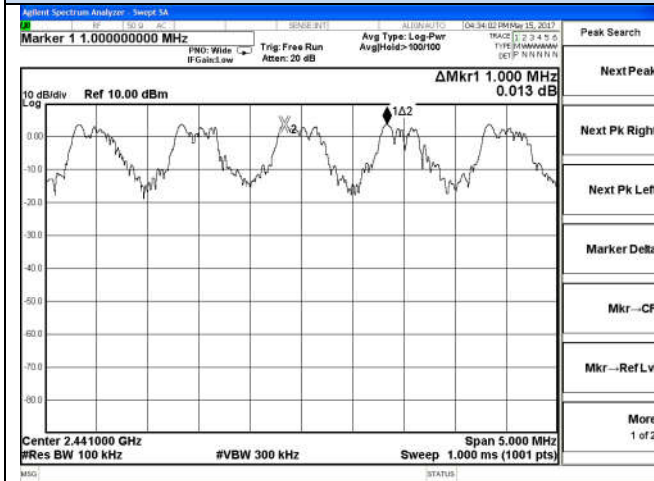

Channel 0 / 2402 MHz

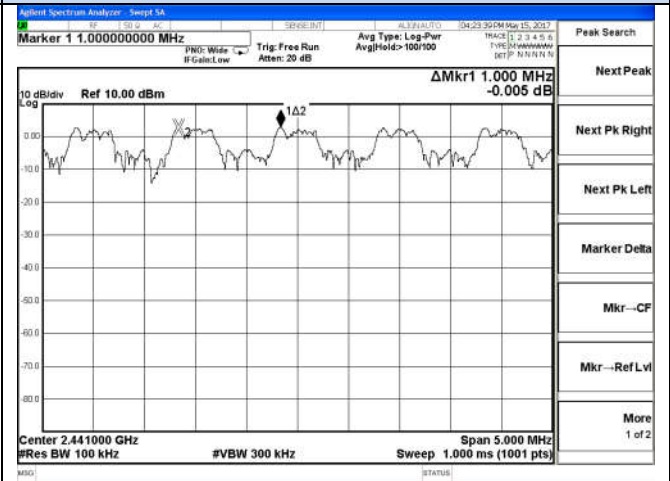

Channel 39 / 2441 MHz

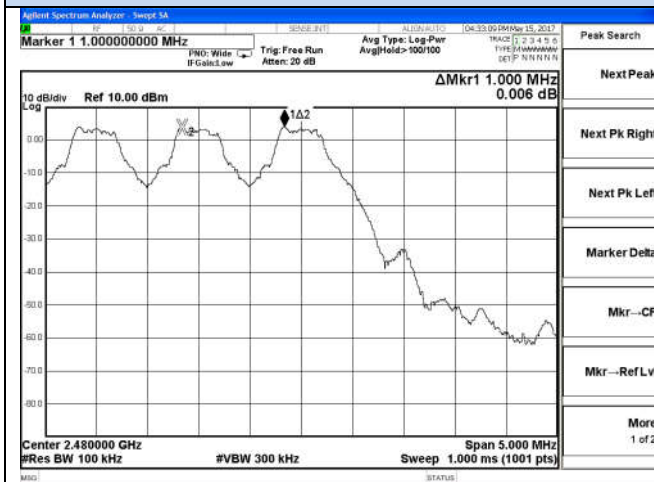

Channel 39 / 2441 MHz

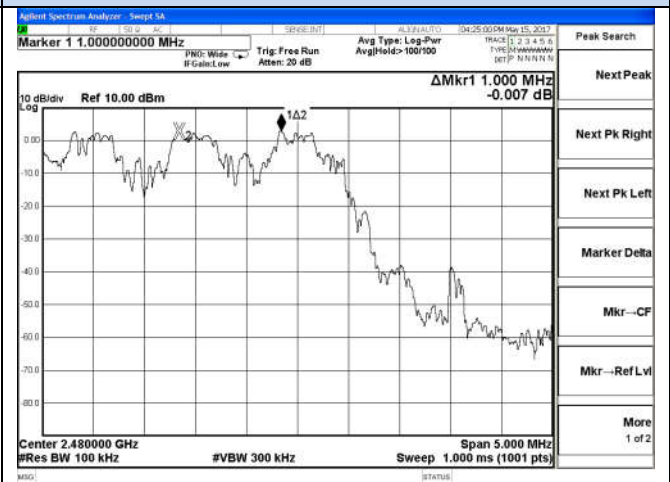

Channel 78 / 2480 MHz

Channel 78 / 2480 MHz

Frequency Separation

8-DPSK



8-DPSK



Channel 0 / 2402 MHz



Channel 39 / 2441 MHz

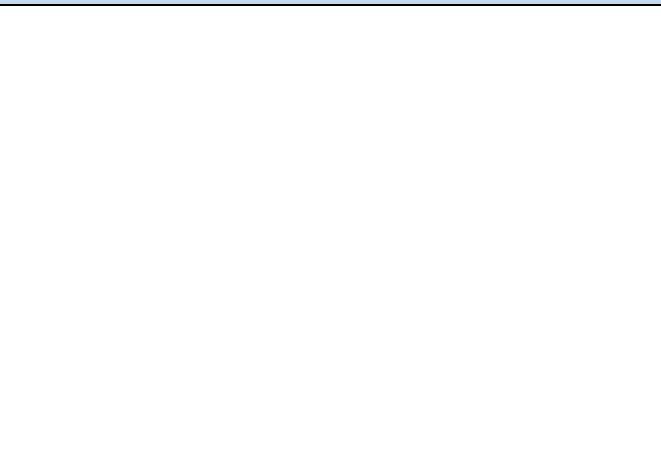

Channel 78 / 2480 MHz

6.3 Number of Hopping Frequency

6.3.1 Limit

According to §15.247(a)(1)(ii) or A8.1 (d), Frequency hopping systems operating in the band 2400-2483.5 MHz shall use at least 15 hopping channels.

6.3.2 Block Diagram of Test Setup

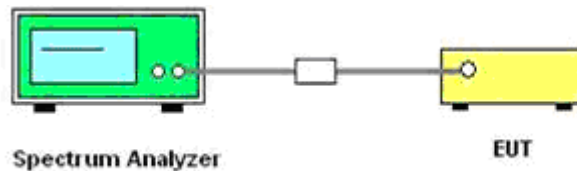

6.3.3 Test Procedure

- 1). Place the EUT on the table and set it in transmitting mode.
- 2). Remove the antenna from the EUT and then connect a low loss RF cable from the antenna port to the Spectrum Analyzer.
- 3). Set Spectrum Analyzer Start=2400MHz, Stop = 2483.5MHz, Sweep = auto.
- 4). Set the Spectrum Analyzer as RBW = 1 MHz, VBW=1MHz.
- 5). Max hold, view and count how many channel in the band.

6.3.4 Test Results

Test Mode	Measurement Result (No. of Channels)	Limit (No. of Channels)	Result
GFSK	79	≥15	PASS
$\pi/4$ DQPSK	79	≥15	PASS
8-DPSK	79	≥15	PASS

Remark:

1. Test results including cable loss;
2. Measured output power at difference Packet Type for each mode and recorded worst case for each mode.
3. Worst case data at DH1 for GFSK, 2DH1 for $\pi/4$ DQPSK, 3DH1 for 8-DPSK modulation type;
4. Record test plots only for GFSK;
5. Please refer following test plots;

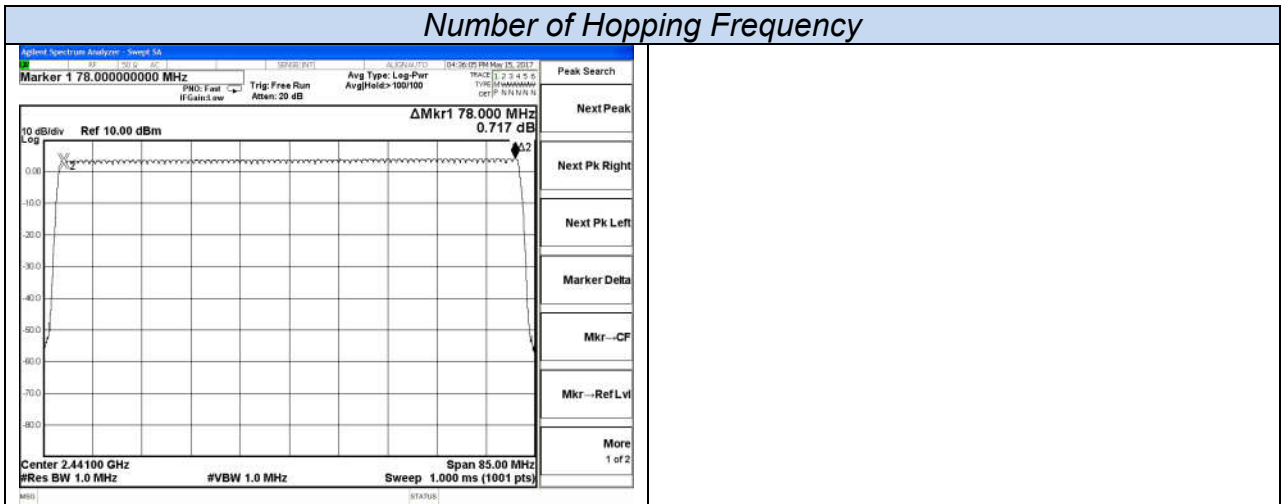

6.4 Time of Occupancy (Dwell Time)

6.4.1 Limit

According to §15.247(a)(1)(iii) or A8.1 (d), Frequency hopping systems operating in the 2400MHz-2483.5 MHz bands. The average time of occupancy on any channels shall not greater than 0.4 s within a period 0.4 s multiplied by the number of hopping channels employed.

6.4.2 Block Diagram of Test Setup

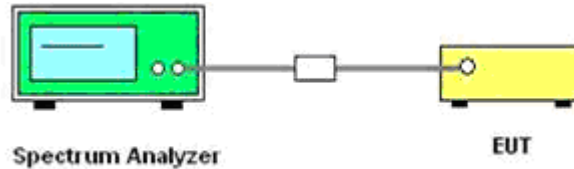

6.4.3 Test Procedure

- 1). Place the EUT on the table and set it in transmitting mode.
- 2). Remove the antenna from the EUT and then connect a low loss RF cable from the antenna port to the Spectrum Analyzer.
- 3). Set center frequency of Spectrum Analyzer = operating frequency.
- 4). Set the Spectrum Analyzer as RBW, VBW=1MHz, Span = 0Hz, Sweep = auto.
- 5). Repeat above procedures until all frequency measured was complete.

6.4.4 Test Results

The Dwell Time=Burst Width*Total Hops. The detailed calculations are showed as follows:

The duration for dwell time calculation: $0.4[s] \times \text{hopping number} = 0.4[s] \times 79[\text{ch}] = 31.6[s \cdot \text{ch}]$;

The burst width [ms/hop/ch], which is directly measured, refers to the duration on one channel hop.

The hops per second for all channels: The selected EUT Conf uses a slot type of 5-Tx&1-Rx and a hopping rate of 1600 [ch*hop/s] for all channels. So the final hopping rate for all channels is $1600/6=266.67$ [ch*hop/s]

The hops per second on one channel: $266.67 [\text{ch} \cdot \text{hops/s}] / 79 [\text{ch}] = 3.38 [\text{hop/s}]$;

The total hops for all channels within the dwell time calculation duration: $3.38 [\text{hop/s}] \times 31.6[s \cdot \text{ch}] = 106.67$ [hop*ch];

The dwell time for all channels hopping: $106.67 [\text{hop} \cdot \text{ch}] \times \text{Burst Width} [\text{ms/hop/ch}]$.

Mode	Frequency (MHz)	Burst Type	Pulse Width (ms)	Dwell Time (S)	Limit (S)	Verdict
GFSK	2441	DH1	0.372	0.119	0.4	PASS
		DH3	1.624	0.260	0.4	PASS
		DH5	2.872	0.306	0.4	PASS
π/4-DQPSK	2441	2DH1	0.376	0.120	0.4	PASS
		2DH3	1.628	0.260	0.4	PASS
		2DH5	2.876	0.307	0.4	PASS
8-DPSK	2441	3DH1	0.376	0.120	0.4	PASS
		3DH3	1.628	0.260	0.4	PASS
		3DH5	2.876	0.307	0.4	PASS

Remark:

1. Test results including cable loss;
2. Please refer to following plots;
3. Measured at difference Packet Type for each mode and recorded worst case for each mode.
4. Dwell Time Calculate formula:

DH1: Dwell time=Pulse time (ms) × (1600 ÷ 2 ÷ 79) × 31.6 Second

DH3: Dwell time=Pulse time (ms) × (1600 ÷ 4 ÷ 79) × 31.6 Second

DH5: Dwell time = Pulse Time (ms) × (1600 ÷ 6 ÷ 79) × 31.6 Second

5. Measured at low, middle and high channel, recorded worst at middle channel;

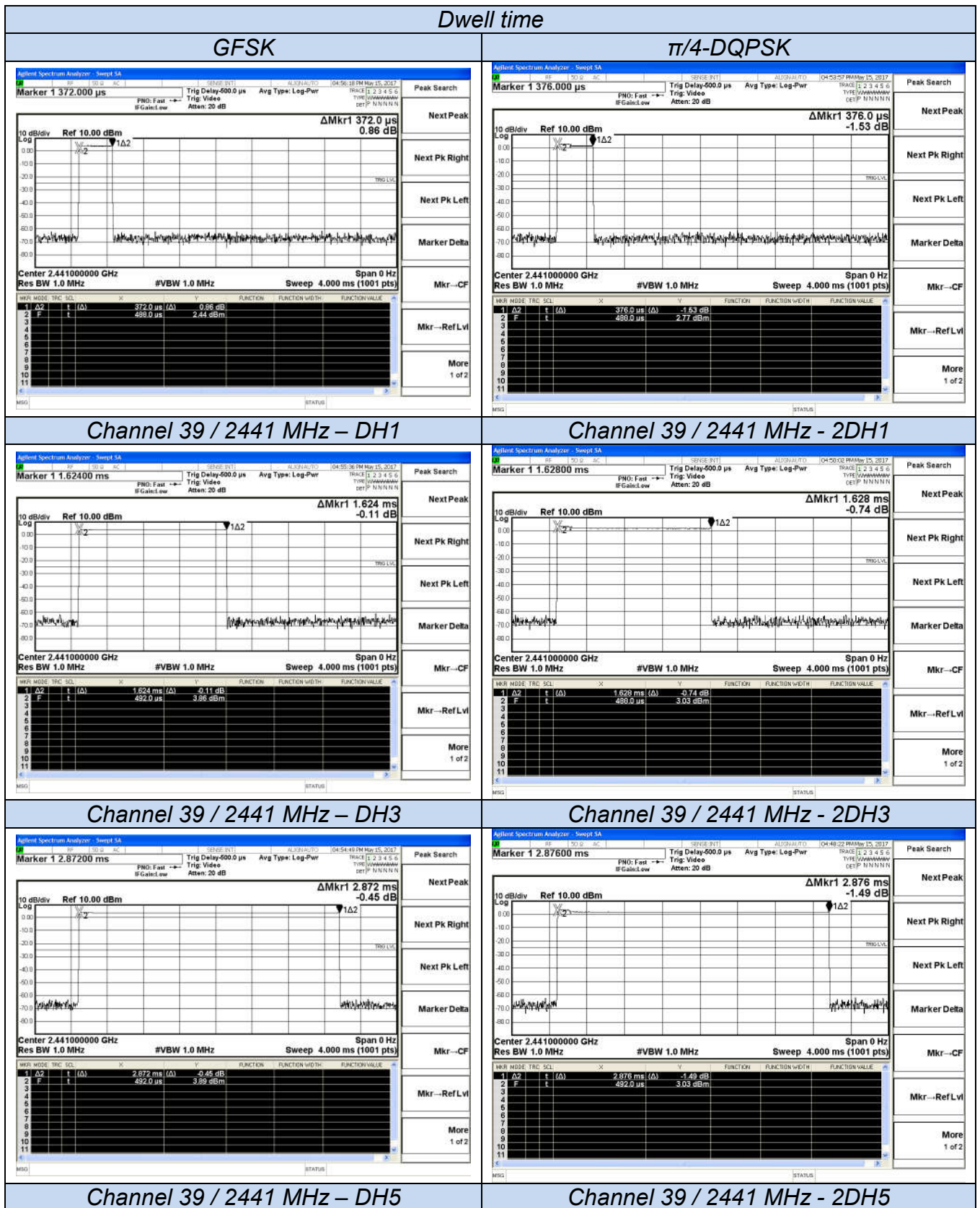

Dwell time

8-DPSK

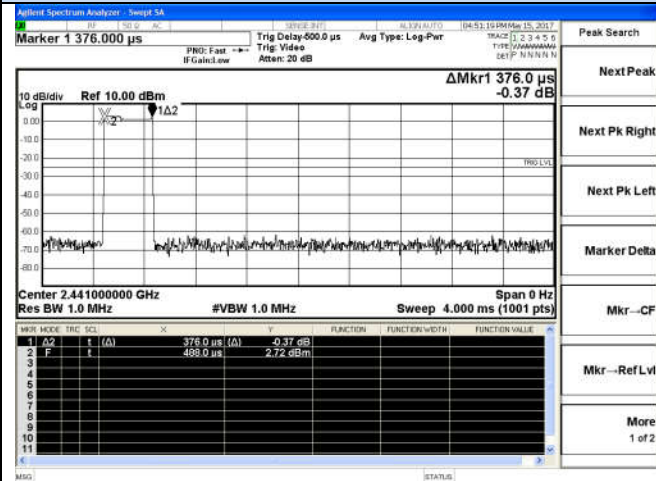

8-DPSK

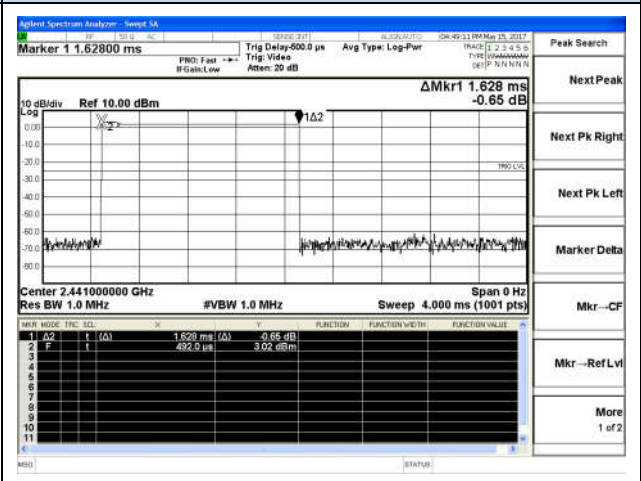

Channel 39 / 2441 MHz – 3DH1

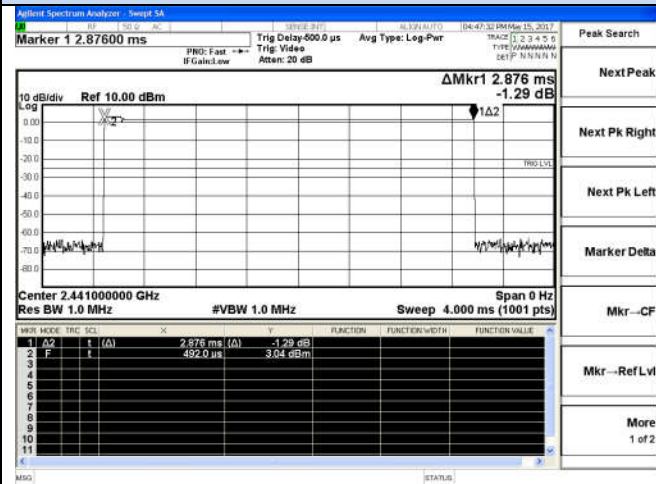

Channel 39 / 2441 MHz – 3DH3

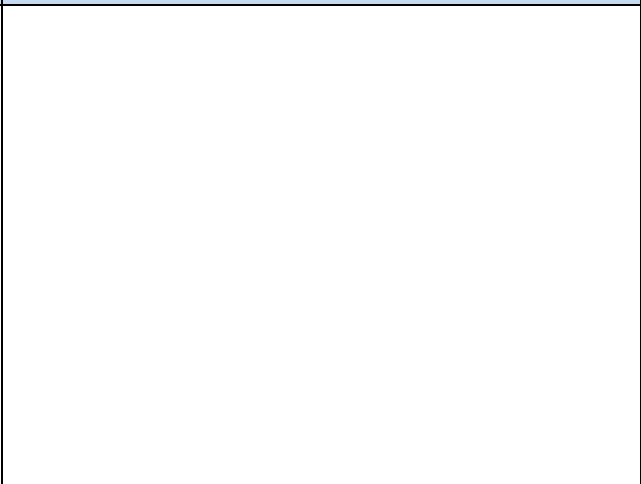

Channel 39 / 2441 MHz – 3DH5

6.5 Conducted Spurious Emissions and Band Edges Test

6.5.1 Limit

In any 100 kHz bandwidth outside the frequency band in which the spread spectrum or digitally modulated intentional radiator is operating, the radio frequency power that is produced by the intentional radiator shall be at least 20 dB below that in the 100 kHz bandwidth within the band that contains the highest level of the desired power, based on either an RF conducted or a radiated measurement. Attenuation below the general limits specified in Section 15.209(a) is not required.

6.5.2 Block Diagram of Test Setup

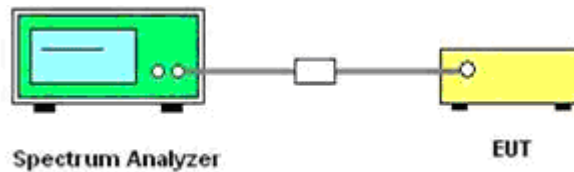

6.5.3 Test Procedure

Conducted RF measurements of the transmitter output were made to confirm that the EUT antenna port conducted emissions meet the specified limit and to identify any spurious signals that require further investigation or measurements on the radiated emissions site.

The transmitter output is connected to the spectrum analyzer. The resolution bandwidth is set to 100 KHz. The video bandwidth is set to 300 KHz.

Measurements are made over the 9 KHz to 26.5GHz range with the transmitter set to the lowest, middle, and highest channels

6.5.4 Test Results of Conducted Spurious Emissions

No non-compliance noted. Only record the worst test result (TX-GFSK) in this report. The test data refer to the following page.

Test Mode	Channel	Frequency (MHz)	Spurious RF Conducted Emission (dBc)	Limits (dBc)	Verdict
GFSK	0	2402	<-20	-20	PASS
	39	2441	<-20		
	78	2480	<-20		
$\pi/4$ -DQPSK	0	2402	<-20	-20	PASS
	39	2441	<-20		
	78	2480	<-20		
8-DPSK	0	2402	<-20	-20	PASS
	39	2441	<-20		
	78	2480	<-20		

Remark:

1. Test results including cable loss;
2. Please refer to following plots;
3. Measured at difference Packet Type for each mode and recorded worst case for each mode.
4. Worst case data at DH1 for GFSK, 2DH1 for $\pi/4$ -DQPSK, 3DH1 for 8-DPSK modulation type;

RF Conducted Spurious Emissions GFSK – Channel 0 / 2402 MHz

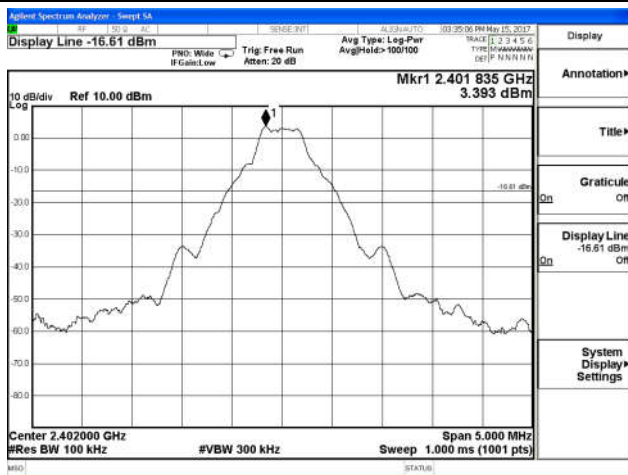

Reference Peak Value

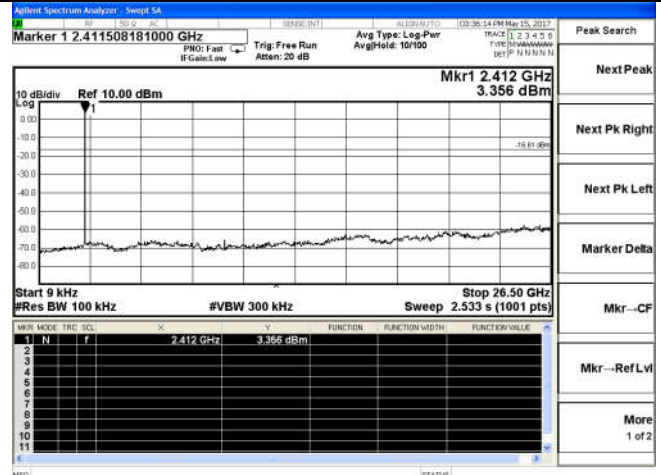

9 KHz – 26.5 GHz

GFSK – Channel 39 / 2441 MHz

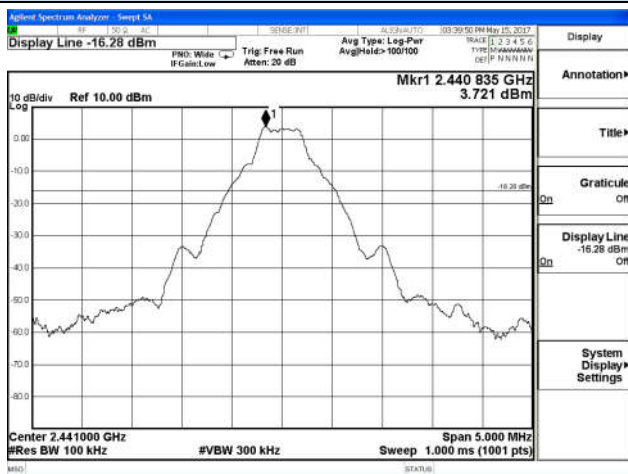

Reference Peak Value

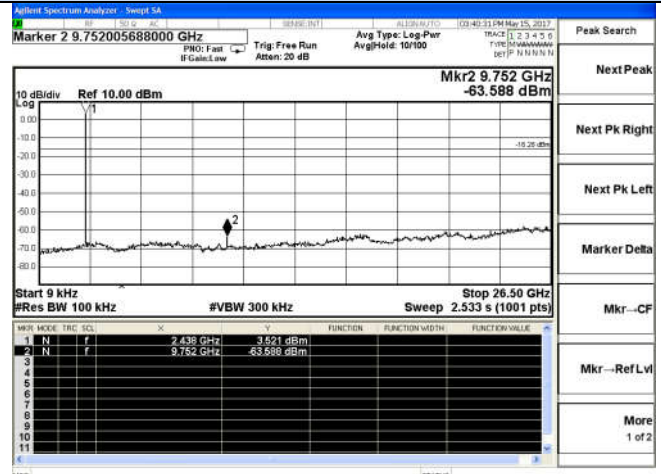

9 KHz – 26.5 GHz

GFSK – Channel 78 / 2480 MHz



Reference Peak Value

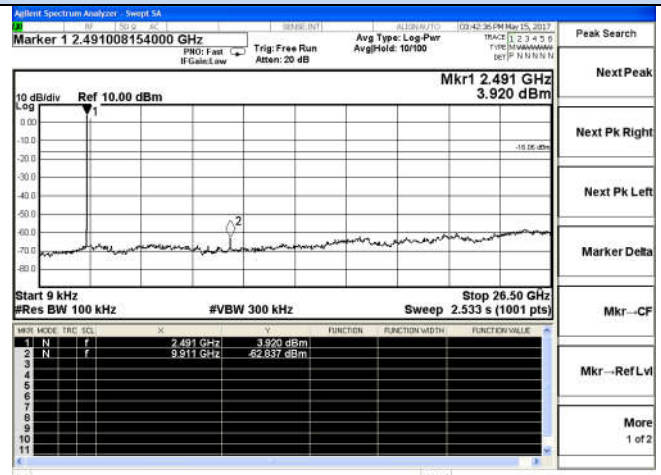

9 KHz – 26.5 GHz

RF Conducted Spurious Emissions
 $\pi/4$ -DQPSK – Channel 0 / 2402 MHz

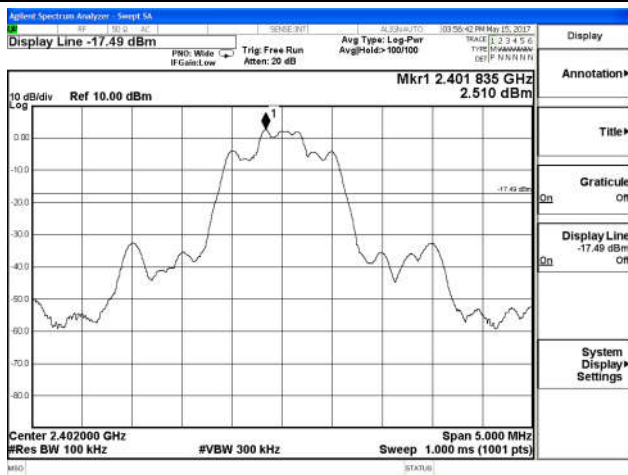

Reference Peak Value

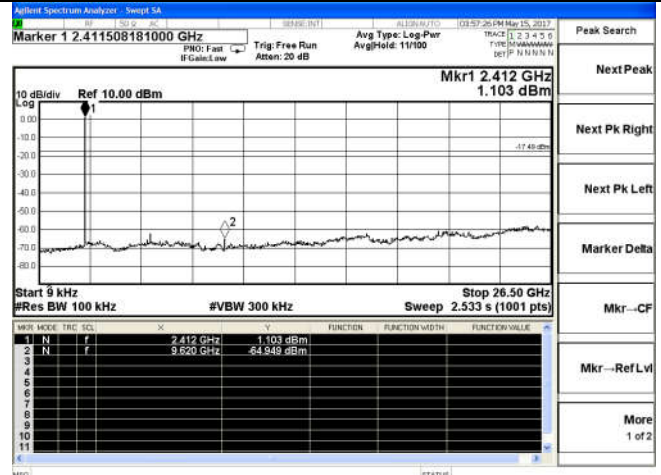

9 KHz – 26.5 GHz

$\pi/4$ -DQPSK – Channel 39 / 2441 MHz

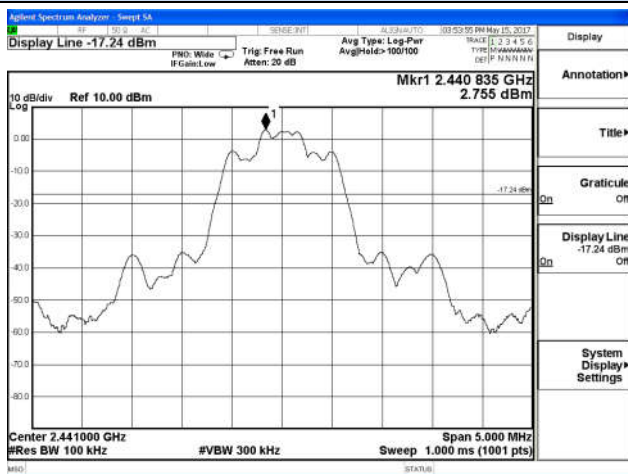

Reference Peak Value

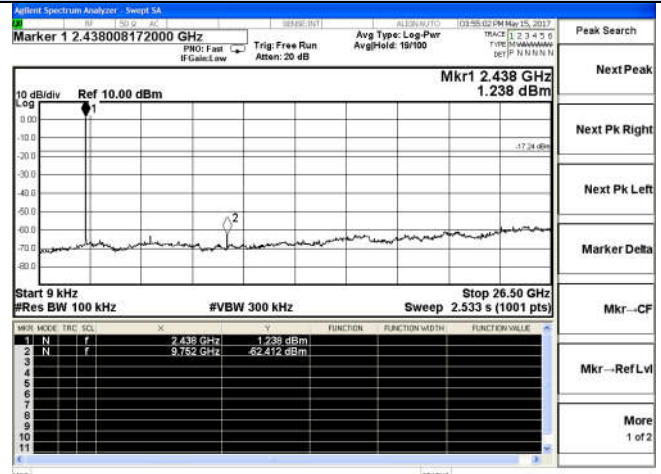

9 KHz – 26.5 GHz

$\pi/4$ -DQPSK – Channel 78 / 2480 MHz

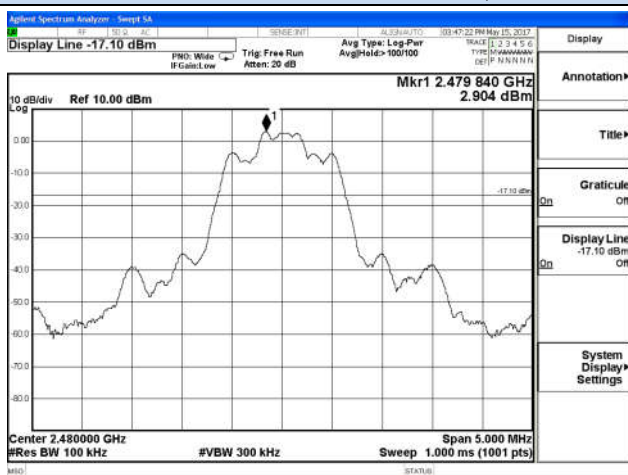

Reference Peak Value

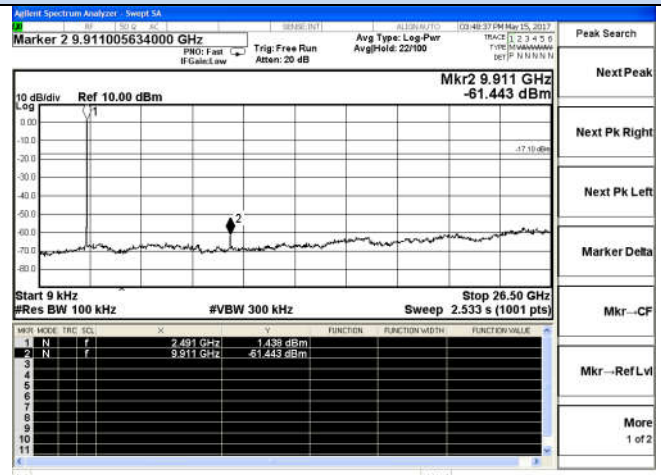

9 KHz – 26.5 GHz

RF Conducted Spurious Emissions 8-DPSK – Channel 0 / 2402 MHz

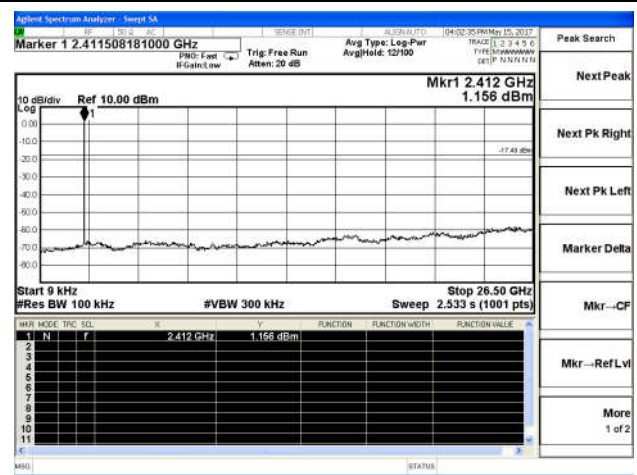
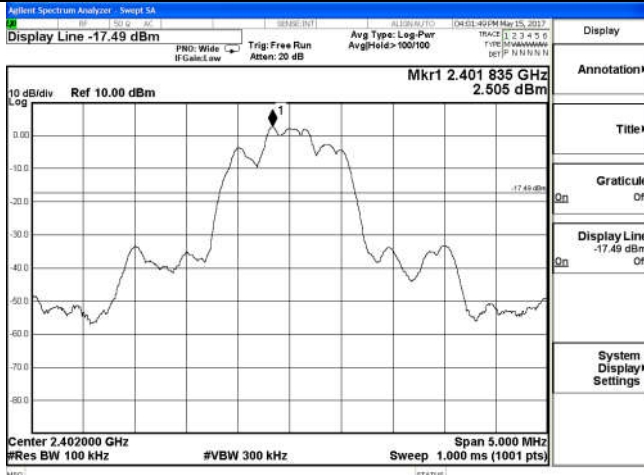

Reference Peak Value

9 KHz – 26.5 GHz

8-DPSK – Channel 39 / 2441 MHz

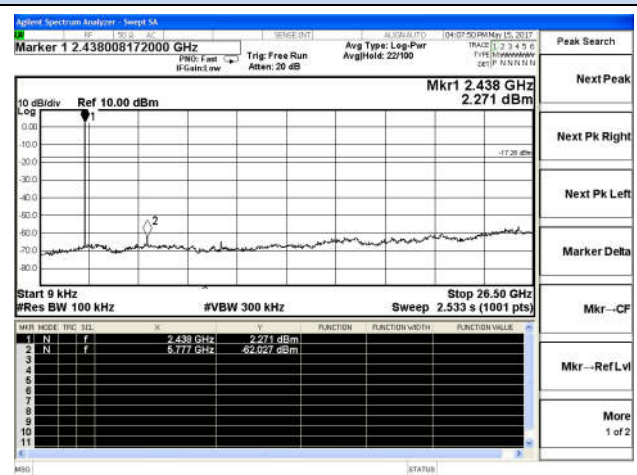

Reference Peak Value

9 KHz – 26.5 GHz

8-DPSK – Channel 78 / 2480 MHz

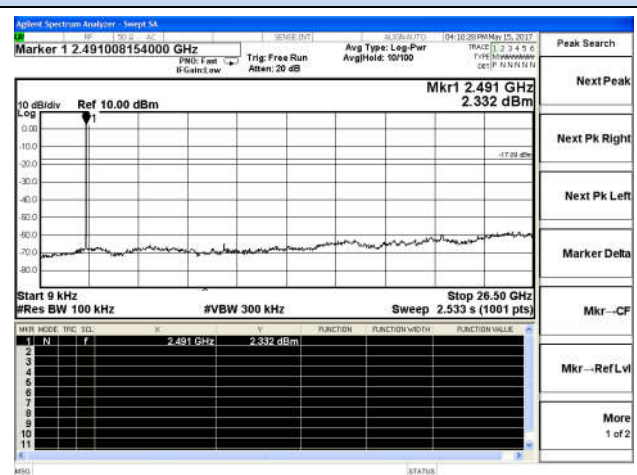

Reference Peak Value

9 KHz – 26.5 GHz

Band-edge for RF conducted emissions

GFSK

$\pi/4$ -DQPSK

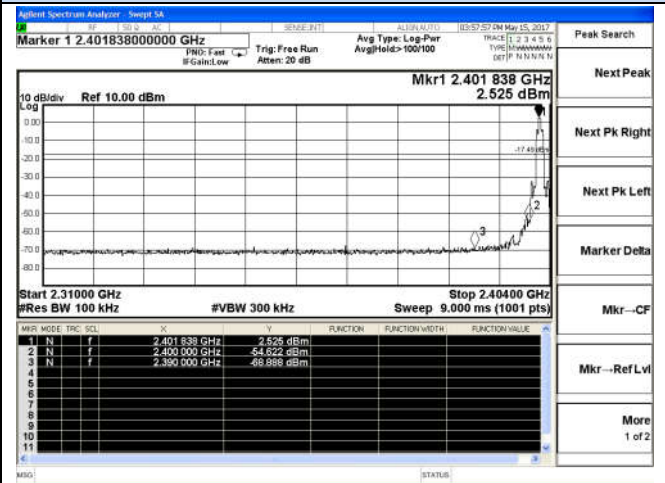
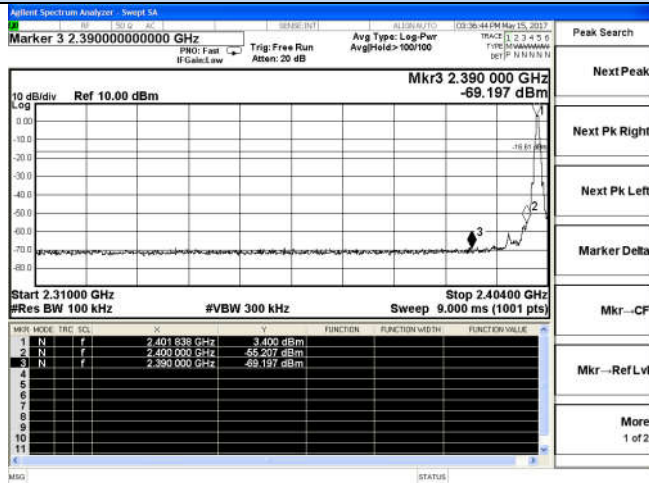

Channel 0 / 2402 MHz – Non-Hopping

Channel 0 / 2402 MHz – Non-Hopping

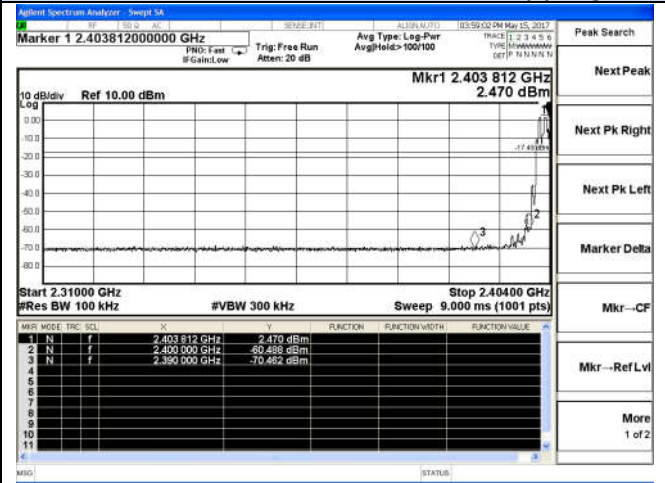
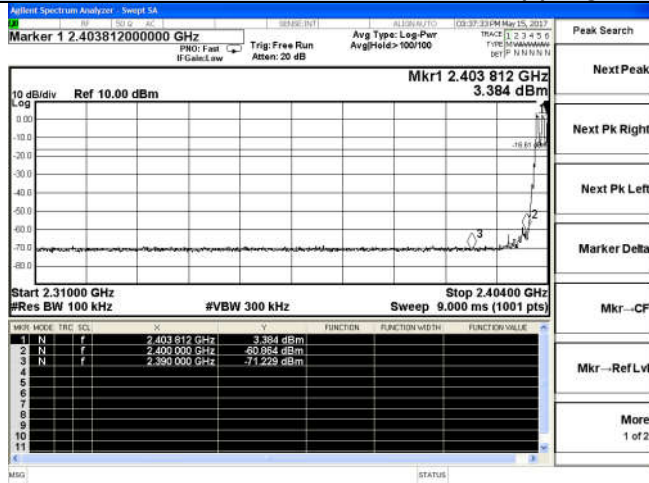

Channel 0 / 2402 MHz – Hopping

Channel 0 / 2402 MHz – Hopping

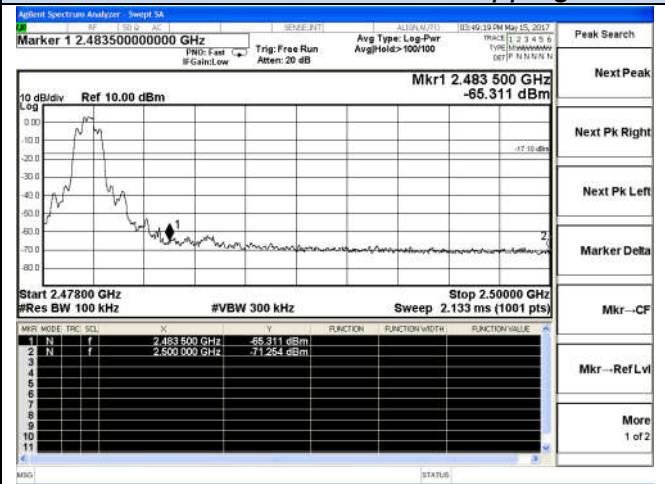
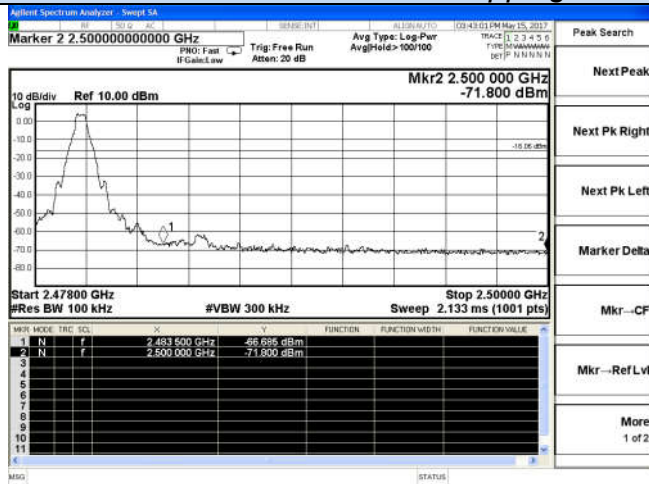

Channel 78 / 2480 MHz – Non-Hopping

Channel 78 / 2480 MHz – Non-Hopping

Band-edge for RF conducted emissions

GFSK

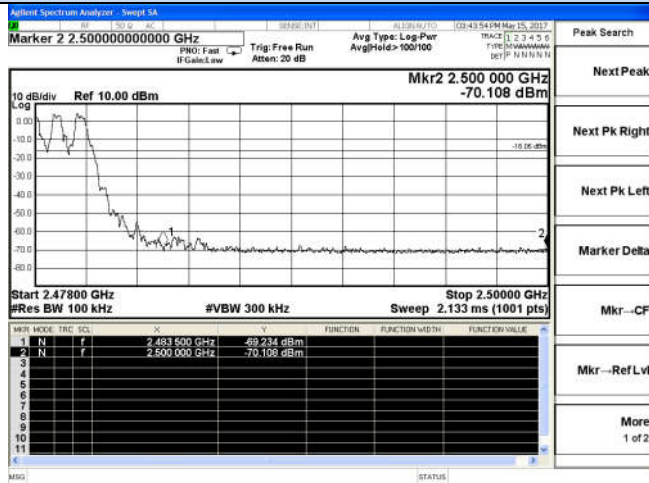

$\pi/4$ -DQPSK

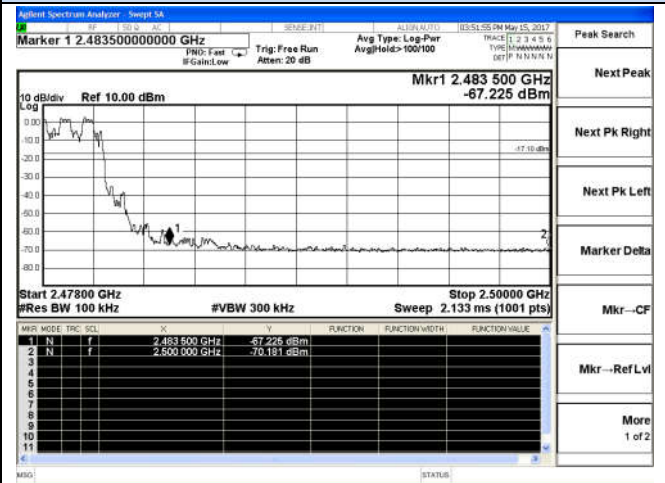

Channel 78 / 2480 MHz – Hopping

8-DPSK

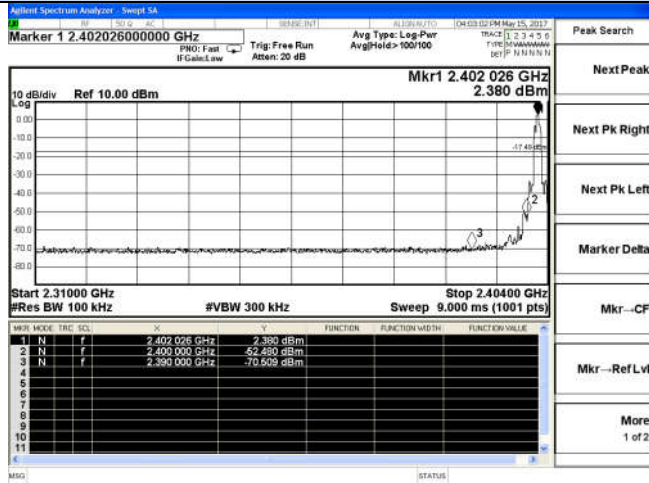

Channel 78 / 2480 MHz – Hopping

8-DPSK

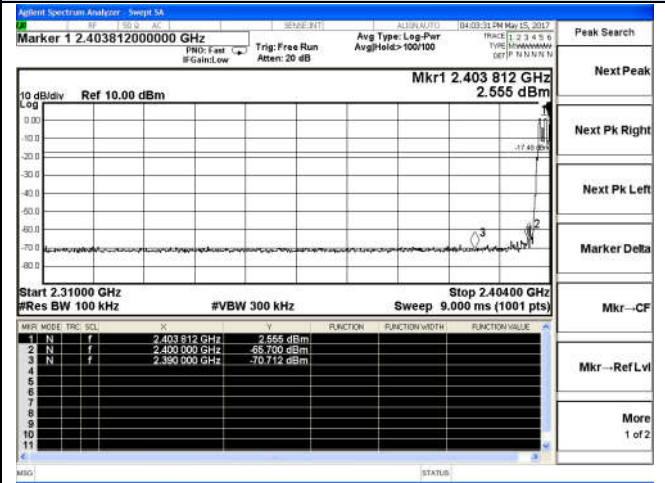

Channel 0 / 2402 MHz – Non-Hopping

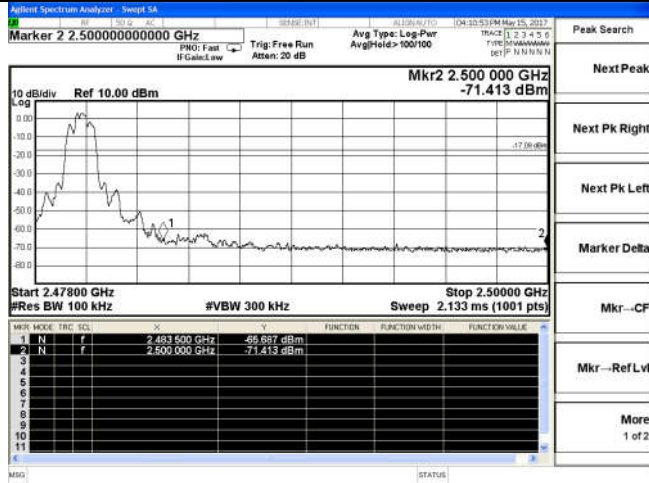

Channel 0 / 2402 MHz – Hopping

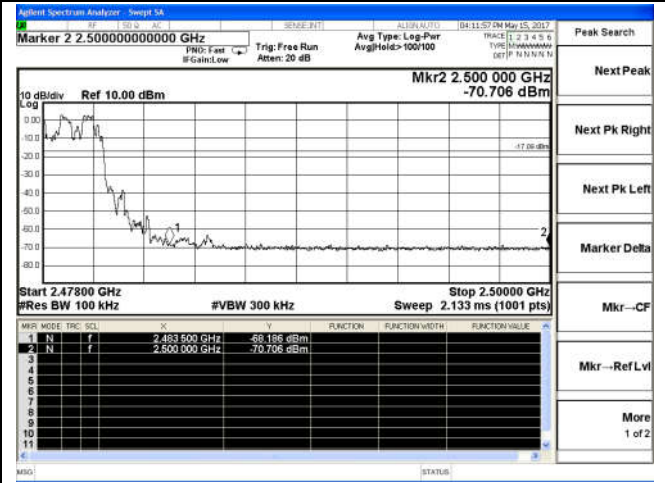

Channel 78 / 2480 MHz – Non-Hopping

Channel 78 / 2480 MHz – Hopping

7. RADIATED MEASUREMENT

7.1 Block Diagram of Test Setup

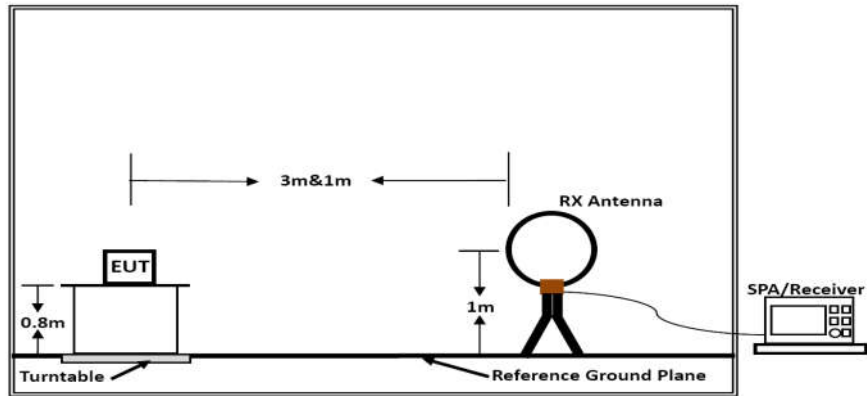

Below 30MHz

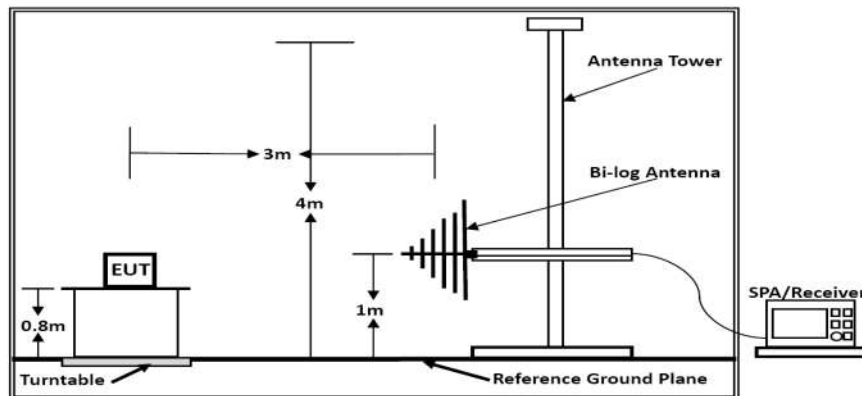

Below 1GHz

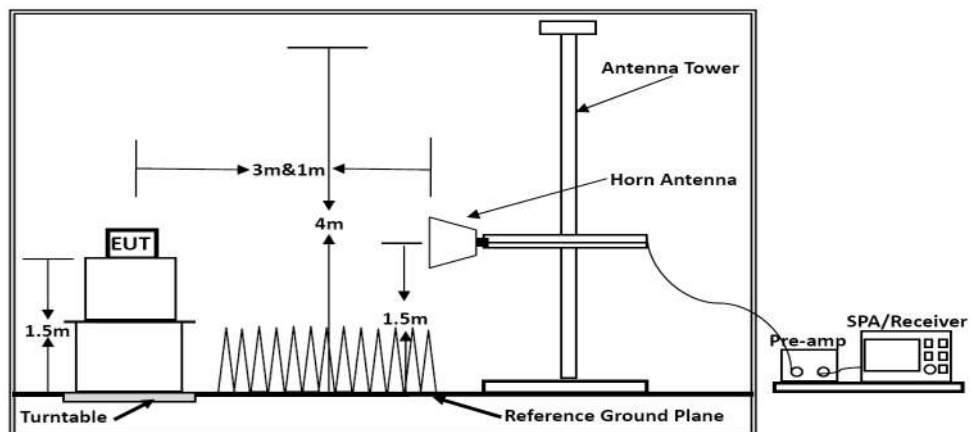

Above 1GHz

Above 18 GHz shall be extrapolated to the specified distance using an extrapolation factor of 20 dB/decade from 3m to 1m.

Distance extrapolation factor = $20 \log(\text{specific distance} [3\text{m}] / \text{test distance} [1.5\text{m}])$ (dB);

Limit line = specific limits (dBuV) + distance extrapolation factor [6 dB].

7.2 Restricted Band Emission Limit

15.205 (a) Except as shown in paragraph (d) of this section, only spurious emissions are permitted in any of the frequency bands listed below:

MHz	MHz	MHz	GHz
0.090-0.110	16.42-16.423	399.9-410	4.5-5.15
\1\ 0.495-0.505	16.69475-16.69525	608-614	5.35-5.46
2.1735-2.1905	16.80425-16.80475	960-1240	7.25-7.75
4.125-4.128	25.5-25.67	1300-1427	8.025-8.5
4.17725-4.17775	37.5-38.25	1435-1626.5	9.0-9.2
4.20725-4.20775	73-74.6	1645.5-1646.5	9.3-9.5
6.215-6.218	74.8-75.2	1660-1710	10.6-12.7
6.26775-6.26825	108-121.94	1718.8-1722.2	13.25-13.4
6.31175-6.31225	123-138	2200-2300	14.47-14.5
8.291-8.294	149.9-150.05	2310-2390	15.35-16.2
8.362-8.366	156.52475-156.52525	2483.5-2500	17.7-21.4
8.37625-8.38675	156.7-156.9	2690-2900	22.01-23.12
8.41425-8.41475	162.0125-167.17	3260-3267	23.6-24.0
12.29-12.293	167.72-173.2	3332-3339	31.2-31.8
12.51975-12.52025	240-285	3345.8-3358	36.43-36.5
12.57675-12.57725	322-335.4	3600-4400	(2\)
13.36-13.41			

\1\ Until February 1, 1999, this restricted band shall be 0.490-0.510 MHz.

\2\ Above 38.6

According to §15.247 (d): 20dBc in any 100 kHz bandwidth outside the operating frequency band. In case the emission fall within the restricted band specified on 15.205(a), then the 15.209(a) limit in the table below has to be followed.

Frequencies (MHz)	Field Strength (microvolts/meter)	Measurement Distance (meters)
0.009~0.490	2400/F(KHz)	300
0.490~1.705	24000/F(KHz)	30
1.705~30.0	30	30
30~88	100	3
88~216	150	3
216~960	200	3
Above 960	500	3

7.3 Instruments Setting

Please refer to section 6 of equipment list in this report. The following table is the setting of spectrum analyzer and receiver.

Spectrum Parameter	Setting
Attenuation	Auto
Start Frequency	1000 MHz
Stop Frequency	10 th carrier harmonic
RB / VB (Emission in restricted band)	1MHz / 1MHz for Peak, 1 MHz / 1/B kHz for Average
RB / VB (Emission in non-restricted band)	1MHz / 1MHz for Peak, 1 MHz / 1/B kHz for Average

Receiver Parameter	Setting
Attenuation	Auto
Start ~ Stop Frequency	9kHz~150kHz / RB/VB 200Hz/1KHz for QP/AVG
Start ~ Stop Frequency	150kHz~30MHz / RB/VB 9kHz/30KHz for QP/AVG
Start ~ Stop Frequency	30MHz~1000MHz / RB/VB 120kHz/1MHz for QP

7.4 Test Procedures

1) Sequence of testing 9 kHz to 30 MHz

Setup:

- The equipment was set up to simulate a typical usage like described in the user manual or described by manufacturer.
- If the EUT is a tabletop system, a rotatable table with 0.8 m height is used.
- If the EUT is a floor standing device, it is placed on the ground.
- Auxiliary equipment and cables were positioned to simulate normal operation conditions.
- The AC power port of the EUT (if available) is connected to a power outlet below the turntable.
- The measurement distance is 3 meter.
- The EUT was set into operation.

Premeasurement:

- The turntable rotates from 0° to 315° using 45° steps.
- The antenna height is 0.8 meter.
- At each turntable position the analyzer sweeps with peak detection to find the maximum of all emissions

Final measurement:

- Identified emissions during the premeasurement the software maximizes by rotating the turntable position (0° to 360°) and by rotating the elevation axes (0° to 360°).
- The final measurement will be done in the position (turntable and elevation) causing the highest emissions with QPK detector.
- The final levels, frequency, measuring time, bandwidth, turntable position, correction factor, margin to the limit and limit will be recorded. Also a plot with the graph of the premeasurement and the limit will be stored.

2) Sequence of testing 30 MHz to 1 GHz

Setup:

- The equipment was set up to simulate a typical usage like described in the user manual or described by manufacturer.
- If the EUT is a tabletop system, a table with 0.8 m height is used, which is placed on the ground plane.
- If the EUT is a floor standing device, it is placed on the ground plane with insulation between both.
- Auxiliary equipment and cables were positioned to simulate normal operation conditions
- The AC power port of the EUT (if available) is connected to a power outlet below the turntable.
- The measurement distance is 3 meter.
- The EUT was set into operation.

Premeasurement:

- The turntable rotates from 0° to 315° using 45° steps.
- The antenna is polarized vertical and horizontal.
- The antenna height changes from 1 to 3 meter.
- At each turntable position, antenna polarization and height the analyzer sweeps three times in peak to find the maximum of all emissions.

Final measurement:

- The final measurement will be performed with minimum the six highest peaks.
- According to the maximum antenna and turntable positions of premeasurement the software maximize the peaks by changing turntable position ($\pm 45^\circ$) and antenna movement between 1 and 4 meter.
- The final measurement will be done with QP detector with an EMI receiver.
- The final levels, frequency, measuring time, bandwidth, antenna height, antenna polarization, turntable angle, correction factor, margin to the limit and limit will be recorded. Also a plot with the graph of the premeasurement with marked maximum final measurements and the limit will be stored.

3) Sequence of testing 1 GHz to 18 GHz

Setup:

- The equipment was set up to simulate a typical usage like described in the user manual or described by manufacturer.
- If the EUT is a tabletop system, a rotatable table with 1.5 m height is used.
- If the EUT is a floor standing device, it is placed on the ground plane with insulation between both.
- Auxiliary equipment and cables were positioned to simulate normal operation conditions
- The AC power port of the EUT (if available) is connected to a power outlet below the turntable.
- The measurement distance is 3 meter.
- The EUT was set into operation.

Premeasurement:

- The turntable rotates from 0° to 315° using 45° steps.
- The antenna is polarized vertical and horizontal.
- The antenna height scan range is 1 meter to 2.5 meter.
- At each turntable position and antenna polarization the analyzer sweeps with peak detection to find the maximum of all emissions.

Final measurement:

- The final measurement will be performed with minimum the six highest peaks.
- According to the maximum antenna and turntable positions of premeasurement the software maximize the peaks by changing turntable position ($\pm 45^\circ$) and antenna movement between 1 and 4 meter. This procedure is repeated for both antenna polarizations.
- The final measurement will be done in the position (turntable, EUT-table and antenna polarization) causing the highest emissions with Peak and Average detector.
- The final levels, frequency, measuring time, bandwidth, turntable position, EUT-table position, antenna polarization, correction factor, margin to the limit and limit will be recorded. Also a plot with the graph of the premeasurement with marked maximum final measurements and the limit will be stored.

4) Sequence of testing above 18 GHz

Setup:

- The equipment was set up to simulate a typical usage like described in the user manual or described by manufacturer.
- If the EUT is a tabletop system, a rotatable table with 1.5 m height is used.
- If the EUT is a floor standing device, it is placed on the ground plane with insulation between both.
- Auxiliary equipment and cables were positioned to simulate normal operation conditions
- The AC power port of the EUT (if available) is connected to a power outlet below the turntable.
- The measurement distance is 1 meter.
- The EUT was set into operation.

Premeasurement:

- The antenna is moved spherical over the EUT in different polarizations of the antenna.

Final measurement:

- The final measurement will be performed at the position and antenna orientation for all detected emissions that were found during the premeasurements with Peak and Average detector.
- The final levels, frequency, measuring time, bandwidth, correction factor, margin to the limit and limit will be recorded. Also a plot with the graph of the premeasurement and the limit will be stored.

7.5 EUT Operation during Test

The EUT was programmed to be in continuously transmitting mode.

7.6 Test Results

Radiated Emissions (9 KHz~30MHz)

Temperature	25°C	Humidity	46%
Test Engineer	Chaz Liu	Configurations	BT

Freq. (MHz)	Level (dBuV)	Over Limit (dB)	Over Limit (dBuV)	Remark
-	-	-	-	See Note

Note:

The amplitude of spurious emissions which are attenuated by more than 20 dB below the permissible value has no need to be reported.

Distance extrapolation factor = 40 log (specific distance / test distance) (dB);

Limit line = specific limits (dBuV) + distance extrapolation factor.

PASS.

Pre-scan all modes and recorded the worst case results in this report (TX-High Channel (1Mbps)). The test data please refer to following page.

Below 1GHz (High Channel)

Vertical:

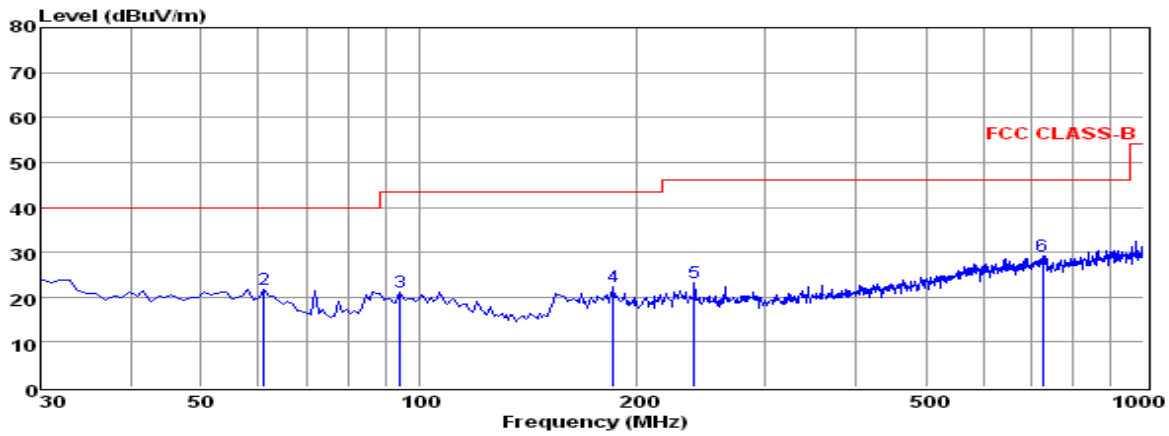

	Freq	Reading	CabLos	Antfac	Measured	Limit	Over	Remark
	MHz	dBuV	dB	dB/m	dBuV/m	dBuV/m	dB	
1	30.00	11.23	0.39	12.33	23.95	40.00	-16.05	QP
2	61.04	8.97	0.49	12.28	21.74	40.00	-18.26	QP
3	94.02	7.94	0.58	12.66	21.18	43.50	-22.32	QP
4	185.20	11.57	0.70	10.14	22.41	43.50	-21.09	QP
5	239.52	10.13	1.01	12.07	23.21	46.00	-22.79	QP
6	724.52	8.42	1.72	19.12	29.26	46.00	-16.74	QP

Note: 1. All readings are Quasi-peak values.
 2. Measured= Reading + Antenna Factor + Cable Loss
 3. The emission that are 20db below the official limit are not reported

Horizontal:

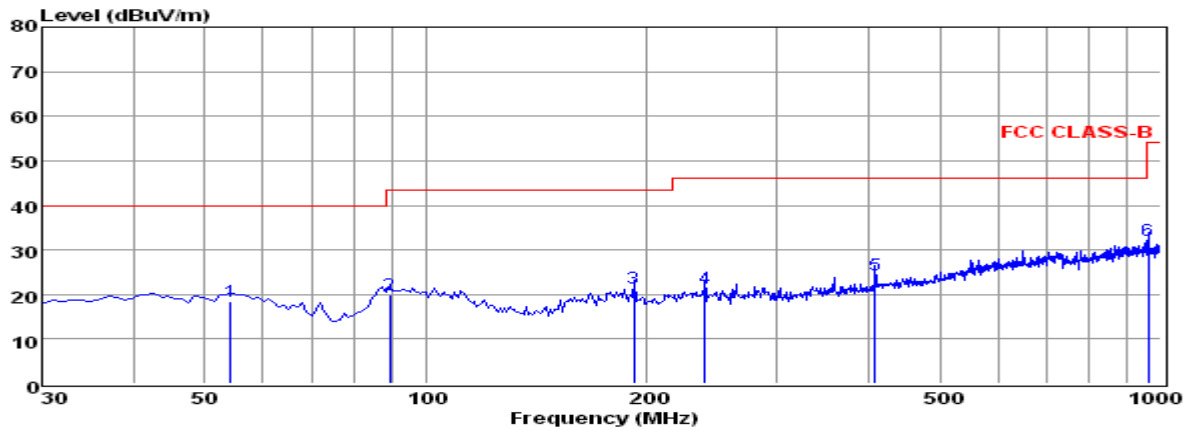

	Freq	Reading	CabLos	Antfac	Measured	Limit	Over	Remark
	MHz	dBuV	dB	dB/m	dBuV/m	dBuV/m	dB	
1	54.25	5.07	0.46	13.05	18.58	40.00	-21.42	QP
2	89.17	7.49	0.68	11.64	19.81	43.50	-23.69	QP
3	191.99	10.02	0.76	10.56	21.34	43.50	-22.16	QP
4	239.52	8.20	1.01	12.07	21.28	46.00	-24.72	QP
5	408.30	7.95	1.17	15.23	24.35	46.00	-21.65	QP
6	960.23	8.65	1.90	21.48	32.03	54.00	-21.97	QP

Note: 1. All readings are Quasi-peak values.
 2. Measured= Reading + Antenna Factor + Cable Loss
 3. The emission that are 20db below the official limit are not reported

Above 1GHz

Note: Only recorded the worst test result.

The worst test result for GFSK, Channel 0 / 2402 MHz:

Freq. MHz	Reading dBuV	Ant. Fac dB/m	Pre. Fac. dB	Cab. Loss dB	Measured dBuV/m	Limit dBuV/m	Margin dB	Remark	Pol.
4804.00	47.64	33.06	35.04	3.94	49.60	74.00	-24.40	Peak	Horizontal
4804.00	32.27	33.06	35.04	3.94	34.23	54.00	-19.77	Average	Horizontal
4804.00	48.65	33.06	35.04	3.94	50.61	74.00	-23.39	Peak	Vertical
4804.00	34.29	33.06	35.04	3.94	36.25	54.00	-17.75	Average	Vertical

The worst test result for GFSK, Channel 39 / 2441 MHz:

Freq. MHz	Reading dBuV	Ant. Fac dB/m	Pre. Fac. dB	Cab. Loss dB	Measured dBuV/m	Limit dBuV/m	Margin dB	Remark	Pol.
4882.00	47.88	33.16	35.15	3.96	49.85	74.00	-24.15	Peak	Horizontal
4882.00	32.91	33.16	35.15	3.96	34.88	54.00	-19.12	Average	Horizontal
4882.00	50.27	33.16	35.15	3.96	52.24	74.00	-21.76	Peak	Vertical
4882.00	35.38	33.16	35.15	3.96	37.35	54.00	-16.65	Average	Vertical

The worst test result for GFSK, Channel 78 / 2480 MHz:

Freq. MHz	Reading dBuV	Ant. Fac dB/m	Pre. Fac. dB	Cab. Loss dB	Measured dBuV/m	Limit dBuV/m	Margin dB	Remark	Pol.
4960.00	49.02	33.26	35.14	3.98	51.12	74.00	-22.88	Peak	Horizontal
4960.00	32.68	33.26	35.14	3.98	34.78	54.00	-19.22	Average	Horizontal
4960.00	50.19	33.26	35.14	3.98	52.29	74.00	-21.71	Peak	Vertical
4960.00	35.37	33.26	35.14	3.98	37.47	54.00	-16.53	Average	Vertical

Notes:

1). Measuring frequencies from 9 KHz - 10th harmonic (ex. 26GHz), No emission found between lowest internal used/generated frequency to 30 MHz.

2). Radiated emissions measured in frequency range from 9 KHz - 10th harmonic (ex. 26GHz) were made with an instrument using Peak detector mode.

3). 18~25GHz at least have 20dB margin. No recording in the test report.

Results of Restricted Bands Test (Radiated)

According to C63.10:2013 Clause 12.7.2(d), for conducted measurements above 1000 MHz, EIRP shall be computed as specified in 12.7.4.2, and then field strength shall be computed as follows (see also Annex G):

1) $E[\text{dBuV/m}] = \text{EIRP}[\text{dBm}] - 20 \log(d[\text{m}]) + 104.77$, where E is field strength and d is distance at which the field strength limit is specified in the applicable requirements.

2) $E[\text{dBuV/m}] = \text{EIRP}[\text{dBm}] + 95.2$, for $d = 3 \text{ m}$.

Then the radiated field strength E can be calculated as

$$E = \text{EIRP}[\text{dBm}] + 95.2$$

$$= \text{Antenna port power} + \text{Antenna gain (or 2dBi, which is greater)} + 95.2$$

And note if the upper bound on antenna gain for a device with a single RF output shall be selected as the maximum in-band gain of the antenna across all operating bands, or 2 dBi, whichever is greater.

If all peak measurement results satisfy the average limit, then average measurements are not required.

GFSK						
Freq. MHz	Reading Level dBm	Antenna Gain dBi	Calculated E dBuV/m	Limit dBuV/m	Margin dB	Remark
2310.000	-60.239	-1.00	36.961	74.00	-37.039	Peak
2390.000	-60.232	-1.00	36.968	74.00	-37.032	Peak
2483.500	-54.312	-1.00	42.888	74.00	-31.112	Peak
2500.000	-60.305	-1.00	36.895	74.00	-37.105	Peak

Pi/4-DQPSK						
Freq. MHz	Reading Level dBm	Antenna Gain dBi	Calculated E dBuV/m	Limit dBuV/m	Margin dB	Remark
2310.000	-61.817	-1.00	35.383	74.00	-38.617	Peak
2390.000	-60.637	-1.00	36.563	74.00	-37.437	Peak
2483.500	-54.207	-1.00	42.993	74.00	-31.007	Peak
2500.000	-60.217	-1.00	36.983	74.00	-37.017	Peak

8-DPSK						
Freq. MHz	Reading Level dBm	Antenna Gain dBi	Calculated E dBuV/m	Limit dBuV/m	Margin dB	Remark
2310.000	-61.838	-1.00	35.362	74.00	-38.638	Peak
2390.000	-60.089	-1.00	37.111	74.00	-36.889	Peak
2483.500	-50.938	-1.00	46.262	74.00	-27.738	Peak
2500.000	-61.617	-1.00	35.583	74.00	-38.417	Peak

Test plot of Restricted Bands-conducted

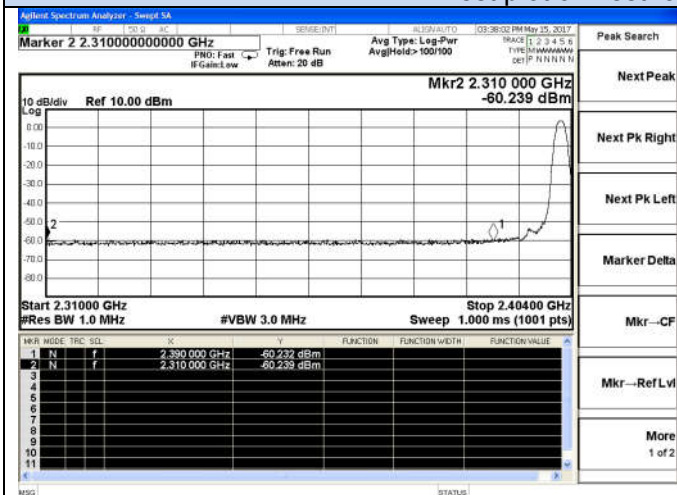

GFSK-Low channel(Peak)

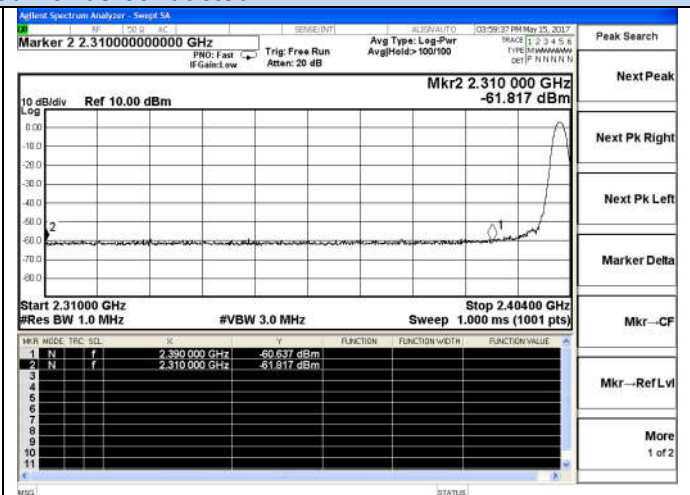

Pi/4-DQPSK-Low channel(Peak)

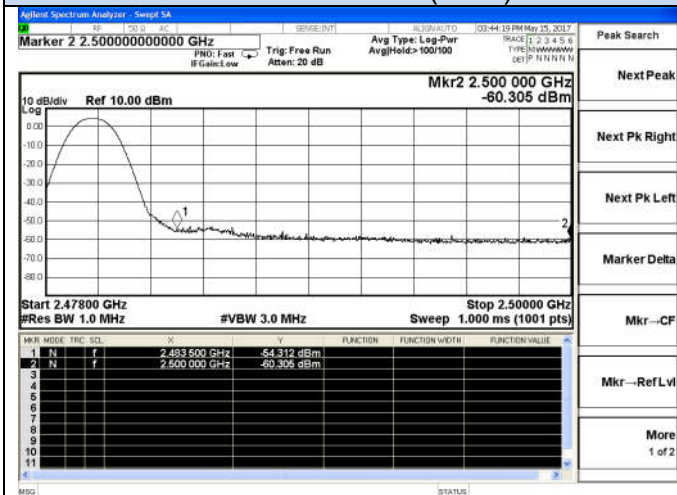

GFSK-High channel(Peak)

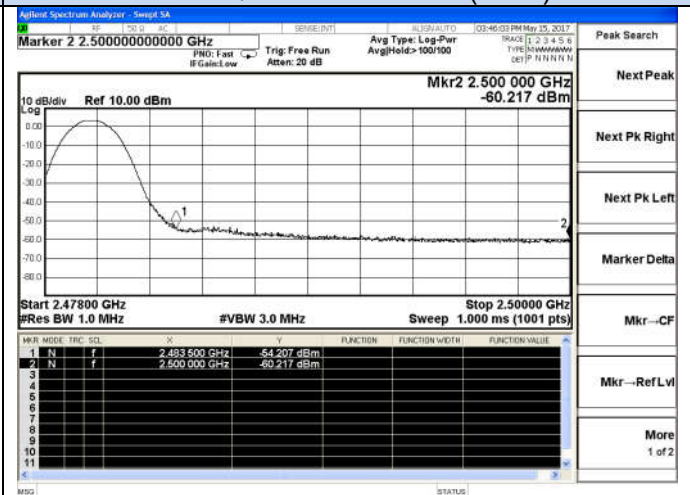

Pi/4-DQPSK-High channel(Peak)

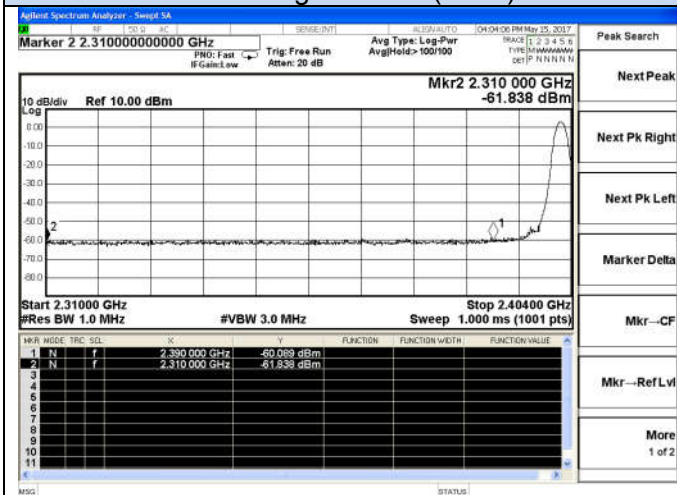

8-DPQK-Low channel(Peak)

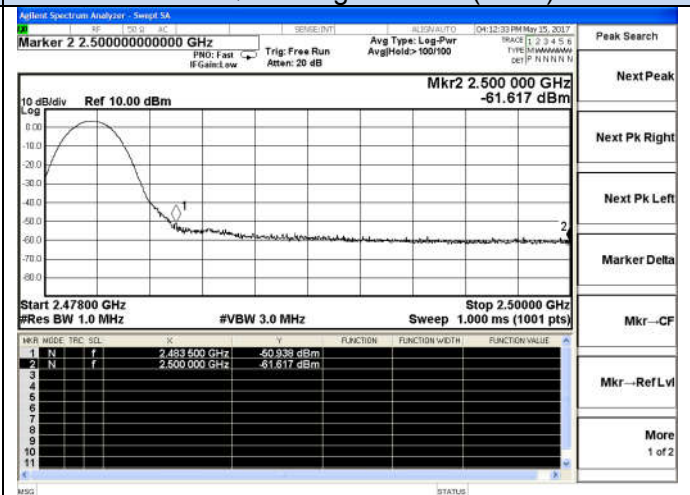

8-DPQK-High channel(Peak)

8. POWER LINE CONDUCTED EMISSIONS

8.1 Standard Applicable

According to §15.207 (a): For an intentional radiator which is designed to be connected to the public utility (AC) power line, the radio frequency voltage that is conducted back onto the AC power line on any frequency or frequencies within the band 150 kHz to 30 MHz shall not exceed 250 microvolts (The limit decreases linearly with the logarithm of the frequency in the range 0.15 MHz to 0.50 MHz). The limits at specific frequency range are listed as follows:

Frequency Range (MHz)	Limits (dB μ V)	
	Quasi-peak	Average
0.15 to 0.50	66 to 56	56 to 46
0.50 to 5	56	46
5 to 30	60	50

* Decreasing linearly with the logarithm of the frequency

8.2 Block Diagram of Test Setup

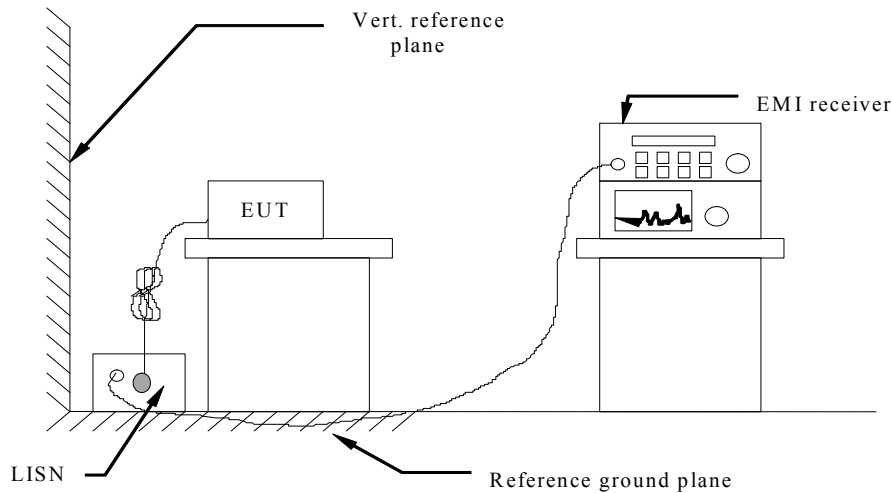

8.3 Test Results

PASS.

The test data please refer to following page.

AC Conducted Emission of power adapter @ AC 240V/50Hz @ GFSK (worst case)

Line:

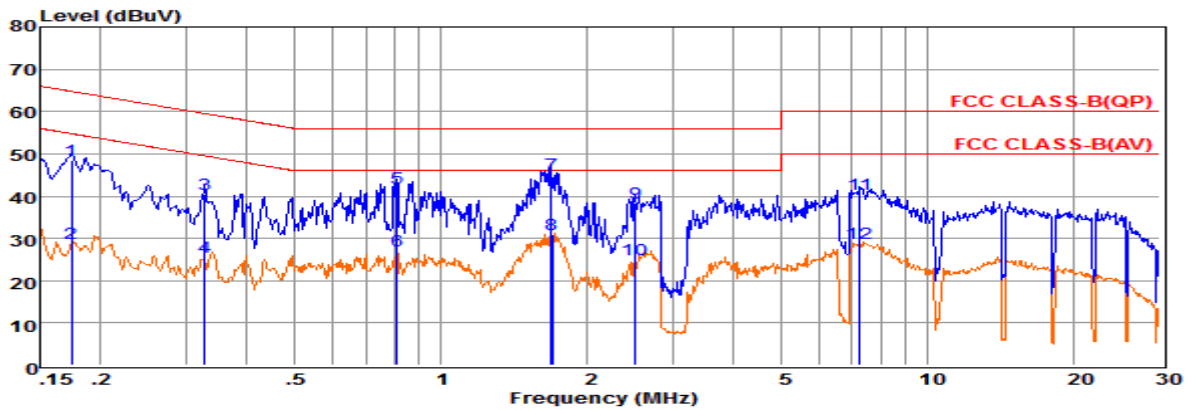

	Freq	Reading	LISNFac	CabLos	Aux2Fac	Measured	Limit	Over	Remark
	MHz	dBuV	dB	dB	dB	dB	dBuV	dBuV	dB
1	0.17	28.77	9.60	0.02	10.00	48.39	64.77	-16.38	QP
2	0.17	9.36	9.60	0.02	10.00	28.98	54.76	-25.78	Average
3	0.33	20.93	9.62	0.03	10.00	40.58	59.53	-18.95	QP
4	0.33	5.81	9.62	0.03	10.00	25.46	49.53	-24.07	Average
5	0.81	22.30	9.64	0.04	10.00	41.98	56.00	-14.02	QP
6	0.81	7.39	9.64	0.04	10.00	27.07	46.00	-18.93	Average
7	1.69	25.58	9.64	0.05	10.00	45.27	56.00	-10.73	QP
8	1.69	11.24	9.64	0.05	10.00	30.93	46.00	-15.07	Average
9	2.51	18.63	9.64	0.05	10.00	38.32	56.00	-17.68	QP
10	2.51	5.29	9.64	0.05	10.00	24.98	46.00	-21.02	Average
11	7.25	20.61	9.68	0.07	10.00	40.36	60.00	-19.64	QP
12	7.25	8.97	9.68	0.07	10.00	28.72	50.00	-21.28	Average

Remarks: 1. Measured = Reading +Cable Loss +Aux2 Fac.
 2. The emission levels that are 20dB below the official limit are not reported.

Neutral:

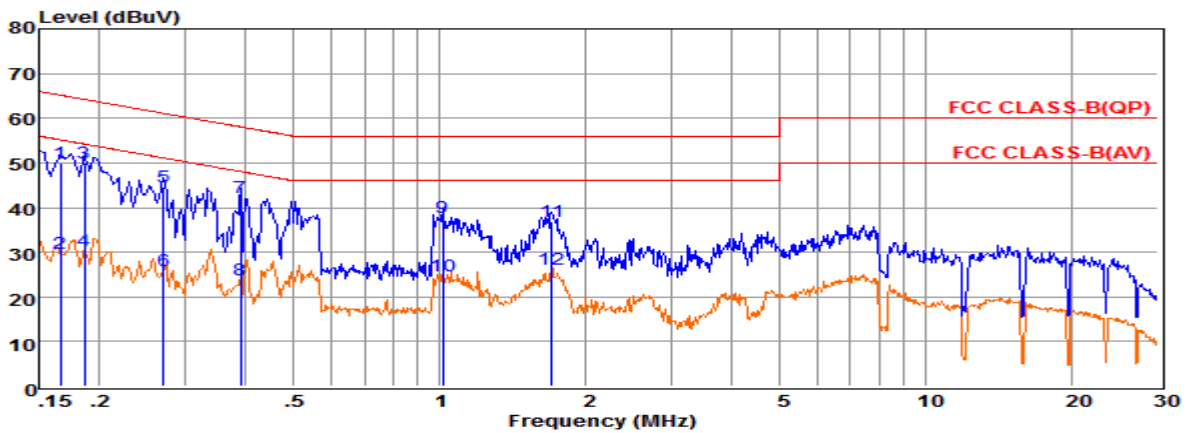

	Freq	Reading	LISNFac	CabLos	Aux2Fac	Measured	Limit	Over	Remark
	MHz	dBuV	dB	dB	dB	dB	dBuV	dBuV	dB
1	0.17	30.37	9.66	0.02	10.00	50.05	65.16	-15.11	QP
2	0.17	10.02	9.66	0.02	10.00	29.70	55.16	-25.46	Average
3	0.19	30.28	9.62	0.02	10.00	49.92	64.20	-14.28	QP
4	0.19	10.69	9.62	0.02	10.00	30.33	54.19	-23.86	Average
5	0.27	25.10	9.60	0.03	10.00	44.73	61.12	-16.39	QP
6	0.27	6.11	9.60	0.03	10.00	25.74	51.11	-25.37	Average
7	0.39	22.63	9.61	0.04	10.00	42.28	58.08	-15.80	QP
8	0.39	4.04	9.61	0.04	10.00	23.69	48.08	-24.39	Average
9	1.02	18.10	9.63	0.05	10.00	37.78	56.00	-18.22	QP
10	1.02	5.02	9.63	0.05	10.00	24.70	46.00	-21.30	Average
11	1.70	17.25	9.63	0.05	10.00	36.93	56.00	-19.07	QP
12	1.70	6.39	9.63	0.05	10.00	26.07	46.00	-19.93	Average

Remarks: 1. Measured = Reading +Cable Loss +Aux2 Fac.
 2. The emission levels that are 20dB below the official limit are not reported.

***Note: Pre-scan all modes and recorded the worst case results (@240VAC) in this report;

9. ANTENNA REQUIREMENT

9.1 Standard Applicable

According to antenna requirement of §15.203, an intentional radiator shall be designed to ensure that no antenna other than that furnished by the responsible party shall be used with the device. The use of a permanently attached antenna or of an antenna that uses a unique coupling to the intentional radiator shall be considered sufficient to comply with the provisions of this Section. The manufacturer may design the unit so that a broken antenna can be re-placed by the user, but the use of a standard antenna jack or electrical connector is prohibited. This requirement does not apply to carrier current devices or to devices operated under the provisions of Sections 15.211, 15.213, 15.217, 15.219, or 15.221. Further, this requirement does not apply to intentional radiators that must be professionally installed, such as perimeter protection systems and some field disturbance sensors, or to other intentional radiators which, in accordance with Section 15.31(d), must be measured at the installation site. However, the installer shall be responsible for ensuring that the proper antenna is employed so that the limits in this Part are not exceeded.

And according to §15.247(4)(1), system operating in the 2400-2483.5MHz bands that are used exclusively for fixed, point-to-point operations may employ transmitting antennas with directional gain greater than 6dBi provided the maximum peak output power of the intentional radiator is reduced by 1 dB for every 3 dB that the directional gain of the antenna exceeds 6dBi.

9.2 Antenna Connected Construction

9.2.1. Standard Applicable

According to § 15.203 & RSS-Gen, an intentional radiator shall be designed to ensure that no antenna other than that furnished by the responsible party shall be used with the device.

9.2.2. Antenna Connector Construction

The directional gains of antenna used for transmitting is -1dBi, and the antenna is an PIFA antenna connect to PCB board and no consideration of replacement. Please see EUT photo for details. The WLAN and BT share same antenna;

9.2.3. Results: Compliance.

10. TEST SETUP PHOTOGRAPHS OF EUT

Please refer to separated files for Test Setup Photos of the EUT.

11. EXTERIOR PHOTOGRAPHS OF THE EUT

Please refer to separated files for External Photos of the EUT.

12. INTERIOR PHOTOGRAPHS OF THE EUT

Please refer to separated files for Internal Photos of the EUT.

-----THE END OF REPORT-----