

FCC PART 22/24 TEST REPORT**FCC Part 22 / Part 24**

Report Reference No. : LCS190110023AEF

FCC ID..... : 2ADTE-S90

Date of Issue. : January 25, 2019

Testing Laboratory Name: Shenzhen LCS Compliance Testing Laboratory Ltd.

Address..... : 1/F., Xingyuan Industrial Park, Tongda Road, Bao'an Avenue, Bao'an District, Shenzhen, Guangdong, China

Applicant's name.....: Shenzhen KVD Communication Equipment Limited

Address..... : Lenovo R&D Center 2F-B, South First Road, High-tech Park, Nanshan District, Shenzhen, Guangdong, China

Test specification :

Standard: **FCC Part 22: Public Mobile Services****FCC Part 24: Personal Communication Services**

Test Report Form No: LCSEMC-1.0

TRF Originator: Shenzhen LCS Compliance Testing Laboratory Ltd.

Master TRF: Dated 2011-03

Shenzhen LCS Compliance Testing Laboratory Ltd. All rights reserved.

This publication may be reproduced in whole or in part for non-commercial purposes as long as the Shenzhen LCS Compliance Testing Laboratory Ltd. is acknowledged as copyright owner and source of the material. Shenzhen LCS Compliance Testing Laboratory Ltd. takes no responsibility for and will not assume liability for damages resulting from the reader's interpretation of the reproduced material due to its placement and context.

Test item description..... : **LTE GSM/WCDMA Smartphone**

Trade Mark: DOOGEE

Model/Type reference.....: S90

Listed Models: /

Ratings.....: DC 3.8V by Rechargeable Li-ion Battery(5050mAh)

Recharged by DC 5V/2000mA TRAVEL CHARGER

Modulation: QPSK

Hardware version.....: HCT-S700MB-A2

Software version: DOOGEE_S90_Android8.1-20181126

Frequency: UMTS Band II / UMTS Band V

Result.....: **PASS**

Compiled by:



Aking Jin/File administrators

Supervised by:

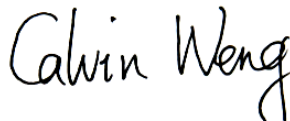

Calvin Weng/Technique principal

Approved by:



Gavin Liang/ Manager

TEST REPORT**Test Report No. : LCS190110023AEF**

January 25, 2019

Date of issue

Equipment under Test : LTE GSM/WCDMA Smartphone

Model /Type : S90

Listed Models : /

Model Declaration : /

Applicant : Shenzhen KVD Communication Equipment LimitedAddress : Lenovo R&D Center 2F-B, South First Road, High-tech Park,
Nanshan District, Shenzhen, Guangdong, China**Manufacturer : Shenzhen KVD Communication Equipment Limited**Address : A,3rd floor, Building A2, Silicon valley Digital Industrial Park,22nd of
Dafu industrial area,Aobei Community,Guanlan town,Longhua
District,shenzhen 518000, China**Factory : Shenzhen KVD Communication Equipment Limited**Address : A,3rd floor, Building A2, Silicon valley Digital Industrial Park,22nd of
Dafu industrial area,Aobei Community,Guanlan town,Longhua
District,shenzhen 518000, China**Test Result:****PASS**

The test report merely corresponds to the test sample.

It is not permitted to copy extracts of these test result without the written permission of the test laboratory.

Revision History

| Revision | Issue Date | Revisions | Revised By |
|----------|------------------|---------------|-------------|
| 000 | January 25, 2019 | Initial Issue | Gavin Liang |
| | | | |
| | | | |

Contents

| | | |
|----------|---|-----------|
| 1 | <u>TEST STANDARDS</u> | 5 |
| 2 | <u>SUMMARY</u> | 6 |
| 2.1 | General Remarks | 6 |
| 2.2 | Product Description | 6 |
| 2.3 | Equipment under Test | 7 |
| 2.4 | Short description of the Equipment under Test (EUT) | 7 |
| 2.5 | Internal Identification of AE used during the test | 7 |
| 2.6 | Normal Accessory setting | 7 |
| 2.7 | EUT configuration | 8 |
| 2.8 | Related Submittal(s) / Grant (s) | 8 |
| 2.9 | Modifications | 8 |
| 2.10 | General Test Conditions/Configurations | 8 |
| 3 | <u>TEST ENVIRONMENT</u> | 9 |
| 3.1 | Address of the test laboratory | 9 |
| 3.2 | Test Facility | 9 |
| 3.3 | Environmental conditions | 9 |
| 3.4 | Test Description | 9 |
| 3.5 | Equipments Used during the Test | 11 |
| 3.6 | Measurement uncertainty | 12 |
| 4 | <u>TEST CONDITIONS AND RESULTS</u> | 13 |
| 4.1 | Output Power | 13 |
| 4.2 | Radiated Spurious Emssion | 16 |
| 4.3 | Occupied Bandwidth and Emission Bandwith | 19 |
| 4.4 | Band Edge Compliance | 21 |
| 4.5 | Spurious Emssion on Antenna Port | 23 |
| 4.6 | Frequency Stability Test | 29 |
| 4.7 | Peak-to-Average Ratio (PAR) | 31 |
| 5 | <u>TEST SETUP PHOTOS OF THE EUT</u> | 33 |
| 6 | <u>EXTERNAL PHOTOS OF THE EUT</u> | 33 |
| 7 | <u>INTERNAL PHOTOS OF THE EUT</u> | 33 |

1 TEST STANDARDS

The tests were performed according to following standards:

[FCC Part 22 \(10-1-17 Edition\)](#): Private Land Mobile Radio Services.

[FCC Part 24\(10-1-17 Edition\)](#): Public Mobile Services.

[ANSI/TIA-603-E-2016](#):Land Mobile FM or PM Communications Equipment Measurement and Performance Standards.

[971168 D01 Power Meas License Digital Systems v03](#) :Measurement Guidance For Certification of Licensed Digital Transmitters

[FCC Part 2](#): Frequency Allocations And Radio Treaty Matters: General Rules And Regulations.

[ANSI C63.26:2015](#):American National Standard for Compliance Testing of Transmitters Used in Licensed Radio Services.

2 SUMMARY

2.1 General Remarks

| | | |
|--------------------------------|---|------------------|
| Date of receipt of test sample | : | January 10, 2019 |
| Testing commenced on | : | January 10, 2019 |
| Testing concluded on | : | January 21, 2019 |

2.2 Product Description

The **Shenzhen KVD Communication Equipment Limited's** Model: S90 or the "EUT" as referred to in this report; more general information as follows, for more details, refer to the user's manual of the EUT.

| | |
|--|---|
| Name of EUT | LTE GSM/WCDMA Smartphone |
| Test Model | S90 |
| Modulation Type | GMSK for GSM/GPRS; QPSK for UMTS; QPSK, 16QAM for LTE |
| Antenna Gain | 0 dBi (max.) For GSM 850, PCS 1900; 0 dBi (max.) For WCDMA Band II, V; 0 dBi (max.) For LTE Band 2, 4, 5, 7, 17; 0 dBi (max.) For BT and WLAN |
| Hardware version | HCT-S700MB-A2 |
| Software version | DOOGEE_S90_Android8.1-20181126 |
| GSM/EDGE/GPRS Operation Frequency Band | GSM850/PCS1900/GPRS850/GPRS1900 |
| UMTS Operation Frequency Band | UMTS FDD Band II/V |
| LTE Operation Frequency Band | LTE Band 2, 4, 5, 7, 17 |
| GSM/EDGE/GPRS | Supported GSM/GPRS |
| GSM Release Version | R99 |
| GSM/EDGE/GPRS Power Class | GSM850:Power Class 4/ PCS1900:Power Class 1 |
| GPRS/EDGE Multislot Class | GPRS: Multi-slot Class 12 |
| GPRS operation mode | Class B |
| WCDMA Release Version | R8 |
| HSDPA Release Version | Release 8 |
| HSUPA Release Version | Release 6 |
| DC-HSUPA Release Version | Not Supported |
| LTE Release Version | Release 9 |
| LTE/UMTS Power Class | Class 3 |
| WLAN FCC Modulation Type | IEEE 802.11b: DSSS(CCK,DQPSK,DBPSK) IEEE 802.11g: OFDM(64QAM, 16QAM, QPSK, BPSK) IEEE 802.11n HT20: OFDM (64QAM, 16QAM, QPSK,BPSK) IEEE 802.11n HT40: OFDM (64QAM, 16QAM, QPSK,BPSK) |
| WLAN FCC Operation frequency | IEEE 802.11b:2412-2462MHz IEEE 802.11g:2412-2462MHz IEEE 802.11n HT20:2412-2462MHz IEEE 802.11n HT40:2422-2452MHz |
| Antenna Type | PIFA Antenna |
| BT Modulation Type | GFSK, $\pi/4$ -DQPSK, 8-DPSK (BT V4.0) |
| Extreme temp. Tolerance | -20°C to +55°C |
| GPS function | Support and only RX |
| FM function | Support and only RX |
| NFC Function | Not Supported |
| Extreme vol. Limits | 3.40VDC to 4.35VDC (nominal: 3.80VDC) |

2.3 Equipment under Test

Power supply system utilised

| | | | |
|----------------------|---|---|-----------------------------------|
| Power supply voltage | : | <input type="radio"/> 120V / 60 Hz | <input type="radio"/> 115V / 60Hz |
| | | <input type="radio"/> 12 V DC | <input type="radio"/> 24 V DC |
| | | <input checked="" type="radio"/> Other (specified in blank below) | |

DC 3.80V

Test frequency list

| Test Mode | TX/RX | RF Channel | | |
|---------------|-------|--------------|--------------|--------------|
| | | Low(L) | Middle (M) | High (H) |
| WCDMA Band V | TX | Channel 4132 | Channel 4182 | Channel 4233 |
| | | 826.4 MHz | 836.4 MHz | 846.6 MHz |
| | RX | Channel 4357 | Channel 4407 | Channel 4458 |
| | | 871.4 MHz | 881.4 MHz | 891.6 MHz |
| Test Mode | TX/RX | RF Channel | | |
| | | Low(L) | Middle (M) | High (H) |
| WCDMA Band II | TX | Channel 9262 | Channel 9400 | Channel 9538 |
| | | 1852.4 MHz | 1880.0 MHz | 1907.6 MHz |
| | RX | Channel 9662 | Channel 9800 | Channel 9938 |
| | | 1932.4 MHz | 1960.0 MHz | 1987.6 MHz |

2.4 Short description of the Equipment under Test (EUT)

2.4.1 General Description

S90 is subscriber equipment in the LTE/WCDMA/GSM system. The HSPA/UMTS frequency band is Band II/V, LTE frequency band is band 2, band 4, band 5, band 7, band 17. The GSM/GPRS frequency band includes GSM850 and PCS1900. The LTE GSM/WCDMA Smartphone implements such functions as RF signal receiving/transmitting, HSPA/UMTS and GSM/GPRS protocol processing, voice, video MMS service and etc. Externally it provides micro SD card interface and SIM card interface.

NOTE: Unless otherwise noted in the report, the functional boards installed in the units shall be selected from the below list, but not means all the functional boards listed below shall be installed in one unit.

2.5 Internal Identification of AE used during the test

| AE ID* | Description |
|--------|-------------------|
| AE1 | Battery (5050mAh) |
| AE2 | TRAVEL CHARGER |

AE2

Model: HJ-0502000W2-US

INPUT: AC 100-240V, 50Hz 0.6A Max.

OUTPUT: DC 5V/2000mA

*AE ID: is used to identify the test sample in the lab internally.

2.6 Normal Accessory setting

Fully charged battery was used during the test.

2.7 EUT configuration

The following peripheral devices and interface cables were connected during the measurement:

● - supplied by the manufacturer

○ - supplied by the lab

| | | | |
|-----------------------|-------------|----------------|---|
| <input type="radio"/> | Power Cable | Length (m) : | / |
| | | Shield : | / |
| | | Detachable : | / |
| <input type="radio"/> | Multimeter | Manufacturer : | / |
| | | Model No. : | / |

2.8 Related Submittal(s) / Grant (s)

This submittal(s) (test report) is intended for **FCC ID: 2ADTE-S90** filing to comply with FCC Part 22 and Part 24 Rules.

2.9 Modifications

No modifications were implemented to meet testing criteria.

2.10 General Test Conditions/Configurations

2.10.1 Test Modes

NOTE: The test mode(s) are selected according to relevant radio technology specifications.

| Test Mode | Test Modes Description |
|-----------|-------------------------------|
| UMTS/TM1 | WCDMA system, QPSK modulation |
| UMTS/TM2 | HSDPA system, QPSK modulation |
| UMTS/TM3 | HSUPA system, QPSK modulation |

Note:

1. This EUT owns two SIM cards, SIM 1 support GSM/UMTS, SIM 2 support GSM;
2. We measured conducted power at both SIM 1 and SIM 2, recorded worst case at SIM 1, after pre-check, we measured other items at SIM 1;
3. As WCDMA, HSDPA and HSUPA with the same emission designator, test result recorded in this report at the worst case UMTS/TM1 only after exploratory scan.

2.10.2 Test Environment

| Environment Parameter | Selected Values During Tests | |
|-----------------------|------------------------------|---------|
| Relative Humidity | Ambient | |
| Temperature | TN | Ambient |
| Voltage | VL | 3.40V |
| | VN | 3.80V |
| | VH | 4.35V |

NOTE: VL=lower extreme test voltage VN=nominal voltage
VH=upper extreme test voltage TN=normal temperature

3 TEST ENVIRONMENT

3.1 Address of the test laboratory

Shenzhen LCS Compliance Testing Laboratory Ltd

1/F., Xingyuan Industrial Park, Tongda Road, Bao'an Avenue, Bao'an District, Shenzhen, Guangdong, China

The sites are constructed in conformance with the requirements of ANSI C63.4 (2014) and CISPR Publication 22.

3.2 Test Facility

The test facility is recognized, certified, or accredited by the following organizations:

FCC Registration Number. is 254912.

Industry Canada Registration Number. is 9642A-1.

ESMD Registration Number. is ARCB0108.

UL Registration Number. is 100571-492.

TUV SUD Registration Number. is SCN1081.

TUV RH Registration Number. is UA 50296516-001

NVLAP Registration Code is 600167-0

3.3 Environmental conditions

During the measurement the environmental conditions were within the listed ranges:

| | |
|-----------------------|--------------|
| Temperature: | 15-35 ° C |
| Humidity: | 30-60 % |
| Atmospheric pressure: | 950-1050mbar |

(1)expressed at approximately the 95% confidence level using a coverage factor of k=1.96.

3.4 Test Description

3.4.1 Cellular Band (824-849MHz paired with 869-894MHz) (Band V)

| Test Item | FCC Rule No. | Requirements | Verdict |
|--|---------------------|---|---------|
| Effective(Isotropic) Radiated Output Power | §2.1046, §22.913 | FCC: ERP ≤ 7W. | Pass |
| Modulation Characteristics | §2.1047 | Digital modulation | N/A |
| Bandwidth | §2.1049 | OBW: No limit. EBW: No limit. | Pass |
| Band Edges Compliance | §2.1051, §22.917 | ≤-13dBm/1%*EBW, in 1MHz bands immediately outside and adjacent to The frequency block. | Pass |
| Spurious Emission at Antenna Terminals | §2.1051, §22.917 | ≤ -13dBm/100kHz, from 9kHz to 10 th harmonics but outside authorized operating frequency ranges. | Pass |
| Field Strength of Spurious Radiation | §2.1053, §22.917 | ≤ -13dBm/100kHz. | Pass |
| Frequency Stability | §2.1055, §22.355 | ≤ ±2.5ppm. | Pass |
| Peak-Average Ratio | §24.232 | ≤13dB | Pass |
| Receiver Spurious Emissions | N/A | -- | Pass |

NOTE 1: For the verdict, the "N/A" denotes "not applicable", the "N/T" de notes "not tested".

3.4.2 PCS Band (1850-1915MHz paired with 1930-1995MHz) (Band II)

| Test Item | FCC Rule No. | Requirements | Verdict |
|--|---------------------|---|---------|
| Effective(Isotropic) Radiated Output Power | §2.1046, §24.232 | EIRP ≤ 2W | Pass |
| Peak-Average Ratio | §2.1046, §24.232 | ≤13dB | Pass |
| Modulation Characteristics | §2.1047 | Digital modulation | N/A |
| Bandwidth | §2.1049 | OBW: No limit. EBW: No limit. | Pass |
| Band Edges Compliance | §2.1051, §24.238 | ≤ -13dBm/1%*EBW, In 1MHz bands immediately outside and adjacent to The frequency block. | Pass |
| Spurious Emission at Antenna Terminals | §2.1051, §24.238 | ≤-13dBm/1MHz, from 9kHz to10 th harmonics but outside authorized operating frequency ranges. | Pass |
| Field Strength of Spurious Radiation | §2.1053, §24.238 | ≤ -13dBm/1MHz. | Pass |
| Frequency Stability | §2.1055, §24.235 | ≤ ±2.5ppm. | Pass |
| Receiver Spurious Emissions | N/A | -- | Pass |

NOTE 1: For the verdict, the "N/A" denotes "not applicable", the "N/T" de notes "not tested".

Remark: 1.The measurement uncertainty is not included in the test result.

3.5 Equipments Used during the Test

| Item | Equipment | Manufacturer | Model No. | Serial No. | Cal Date | Due Date |
|------|-------------------------------------|-------------------|--------------|-------------|------------|------------|
| 1 | Power Meter | R&S | NRVS | 100444 | 2018-06-16 | 2019-06-15 |
| 2 | Power Sensor | R&S | NRV-Z81 | 100458 | 2018-06-16 | 2019-06-15 |
| 3 | Power Sensor | R&S | NRV-Z32 | 10057 | 2018-06-16 | 2019-06-15 |
| 4 | LTE Test Software | Tonscend | JS1120-1 | N/A | N/A | N/A |
| 5 | RF Control Unit | Tonscend | JS0806 | 158060009 | 2018-06-16 | 2019-06-15 |
| 6 | MXA Signal Analyzer | Agilent | N9020A | MY51250905 | 2018-11-15 | 2019-11-14 |
| 7 | WIDEBAND RADIO COMMUNICATION TESTER | R&S | CMW 500 | 103818 | 2018-06-16 | 2019-06-15 |
| 8 | DC Power Supply | Agilent | E3642A | N/A | 2018-11-15 | 2019-11-14 |
| 9 | EMI Test Software | AUDIX | E3 | N/A | 2018-06-16 | 2019-06-15 |
| 10 | 3m Semi Anechoic Chamber | SIDT FRANKONIA | SAC-3M | 03CH03-HY | 2018-06-16 | 2019-06-15 |
| 11 | Positioning Controller | MF | MF-7082 | N/A | 2018-06-16 | 2019-06-15 |
| 12 | Active Loop Antenna | SCHWARZBECK | FMZB 1519B | 00005 | 2018-07-26 | 2019-07-25 |
| 13 | By-log Antenna | SCHWARZBECK | VULB9163 | 9163-470 | 2018-07-26 | 2019-07-25 |
| 14 | Horn Antenna | SCHWARZBECK | BBHA 9120D | 9120D-1925 | 2018-07-02 | 2019-07-01 |
| 15 | Broadband Horn Antenna | SCHWARZBECK | BBHA 9170 | 791 | 2018-09-20 | 2019-09-19 |
| 16 | Broadband Preampifier | SCHWARZBECK | BBV 9719 | 9719-025 | 2018-09-20 | 2019-09-19 |
| 17 | EMI Test Receiver | R&S | ESR 7 | 101181 | 2018-06-16 | 2019-06-15 |
| 18 | RS SPECTRUM ANALYZER | R&S | FSP40 | 100503 | 2018-11-15 | 2019-11-14 |
| 19 | AMPLIFIER | QuieTek | QTK | CHM/0809065 | 2018-11-15 | 2019-11-14 |
| 20 | RF Cable-R03m | Jye Bao | RG142 | CB021 | 2018-06-16 | 2019-06-15 |
| 21 | RF Cable-HIGH | SUHNER | SUCOFLEX 106 | 03CH03-HY | 2018-06-16 | 2019-06-15 |
| 22 | 6dB Attenuator | / | 100W/6dB | 1172040 | 2018-06-16 | 2019-06-15 |
| 23 | 3dB Attenuator | / | 2N-3dB | / | 2018-06-16 | 2019-06-15 |
| 24 | Temperature & Humidity Chamber | GUANGZHOU GOGNWEN | GDS-100 | 70932 | 2018-10-10 | 2019-10-09 |

Note: All equipment is calibrated through GUANGZHOU LISAI CALIBRATION AND TEST CO.,LTD.

3.6 Measurement uncertainty

The data and results referenced in this document are true and accurate. The reader is cautioned that there may be errors within the calibration limits of the equipment and facilities. The measurement uncertainty was calculated for all measurements listed in this test report acc. to ETSI TR 100 028 “ Electromagnetic compatibility and Radio spectrum Matters (ERM); Uncertainties in the measurement of mobile radio equipment characteristics” and is documented in the Shenzhen LCS Compliance Testing Laboratory Ltd. quality system acc. to DIN EN ISO/IEC 17025. Furthermore, component and process variability of devices similar to that tested may result in additional deviation. The manufacturer has the sole responsibility of continued compliance of the device.

Hereafter the best measurement capability for Shenzhen LCS Compliance Testing Laboratory Ltd. is reported:

| Test | Range | Measurement Uncertainty | Notes |
|-------------------------------------|------------|-------------------------|-------|
| Radiated Emission | 30~1000MHz | 3.10 dB | (1) |
| Radiated Emission | 1~18GHz | 3.80 dB | (1) |
| Radiated Emission | 18-40GHz | 3.90 dB | (1) |
| Conducted Disturbance | 0.15~30MHz | 1.63 dB | (1) |
| Conducted Power | 9KHz~18GHz | 0.61 dB | (1) |
| Spurious RF Conducted Emission | 9KHz~40GHz | 1.22 dB | (1) |
| Band Edge Compliance of RF Emission | 9KHz~40GHz | 1.22 dB | (1) |
| Occuiped Bandwidth | 9KHz~40GHz | - | (1) |

(1) This uncertainty represents an expanded uncertainty expressed at approximately the 95% confidence level using a coverage factor of k=1.96.

4 TEST CONDITIONS AND RESULTS

4.1 Output Power

TEST APPLICABLE

During the process of testing, the EUT was controlled via R&S Digital Radio Communication tester (CMU200) to ensure max power transmission and proper modulation. This result contains output power and EIRP measurements for the EUT. In all cases, output power is within the specified limits.

4.1.1. Conducted Output Power

TEST CONFIGURATION

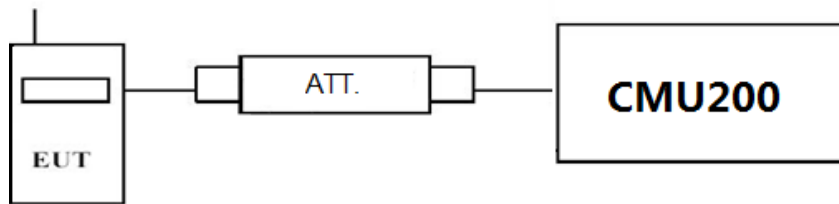

TEST PROCEDURE

Conducted Power Measurement:

- Place the EUT on a bench and set it in transmitting mode.
- Connect a low loss RF cable from the antenna port to a CMU200 by an Att.
- EUT Communicate with CMU200 then selects a channel for testing.
- Add a correction factor to the display CMU200, and then test.

TEST RESULTS

<SIM1>

| Item | band | WCDMA Band II result (dBm) | | | WCDMA Band V result (dBm) | | |
|-------|--------------|----------------------------|---------------|-----------------|---------------------------|----------------|----------------|
| | | Channel/Frequency(MHz) | | | Channel/Frequency(MHz) | | |
| | sub-test | 9262/ 1852.4 | 9400/ 1880 | 9538/ 1907.6 | 4132/ 826.4 | 4182/ 836.4 | 4233/ 846.6 |
| RMC | 12.2kbps RMC | 23.40 | 23.46 | 23.49 | 23.50 | 23.49 | 23.59 |
| HSDPA | Sub -Test 1 | 22.98 | 22.96 | 22.95 | 22.98 | 22.96 | 22.95 |
| | Sub -Test 2 | 22.89 | 22.85 | 22.88 | 22.83 | 22.87 | 22.87 |
| | Sub -Test 3 | 22.82 | 22.71 | 22.83 | 22.75 | 22.74 | 22.81 |
| | Sub -Test 4 | 22.77 | 22.75 | 22.83 | 22.72 | 22.73 | 22.75 |
| HSUPA | Sub -Test 1 | 22.84 | 22.71 | 22.79 | 22.73 | 22.71 | 22.78 |
| | Sub -Test 2 | 22.83 | 22.83 | 22.80 | 22.87 | 22.82 | 22.81 |
| | Sub -Test 3 | 22.80 | 22.78 | 22.70 | 22.82 | 22.71 | 22.81 |
| | Sub -Test 4 | 22.85 | 22.86 | 22.87 | 22.86 | 22.83 | 22.84 |
| | Sub -Test 5 | 22.80 | 22.74 | 22.71 | 22.76 | 22.78 | 22.80 |

<SIM2> (Not Supported)

4.1.1 Radiated Output Power

TEST DESCRIPTION

This is the test for the maximum radiated power from the EUT.

Rule Part 24.232(e) specifies that "Peak transmit power must be measured over any interval of continuous transmission using instrumentation calibrated in terms of an rms-equivalent voltage."

Rule Part 22.913(a) specifies "The ERP of mobile transmitters and auxiliary test transmitters must not exceed 7 Watts."

TEST CONFIGURATION

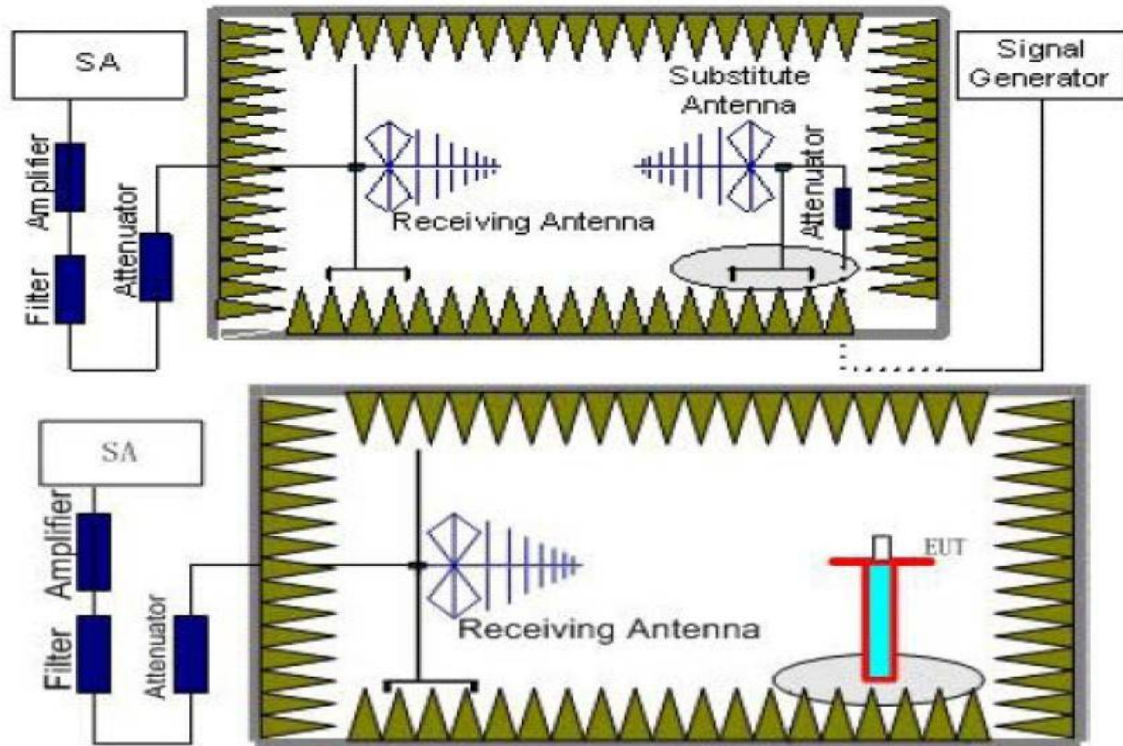

TEST PROCEDURE

1. EUT was placed on a 1.50 meter high non-conductive stand at a 3 meter test distance from the receive antenna. A receiving antenna was placed on the antenna mast 3 meters from the EUT for emission measurements. The height of receiving antenna is 1.50m. Detected emissions were maximized at each frequency by rotating the EUT through 360° and adjusting the receiving antenna polarization. The radiated emission measurements of all transmit frequencies in three channels (High, Middle, Low) were measured with peak detector.
2. A log-periodic antenna or double-ridged waveguide horn antenna shall be substituted in place of the EUT. The log-periodic antenna will be driven by a signal generator and the level will be adjusted till the same power value on the spectrum analyzer or receiver. The level of the spurious emissions can be calculated through the level of the signal generator, cable loss, the gain of the substitution antenna and the reading of the spectrum analyzer or receiver.
3. The EUT is then put into continuously transmitting mode at its maximum power level during the test. Set Test Receiver or Spectrum RBW=10MHz, VBW=10MHz, And the maximum value of the receiver should be recorded as (P_r).
4. The EUT shall be replaced by a substitution antenna. In the chamber, an substitution antenna for the frequency band of interest is placed at the reference point of the chamber. An RF Signal source for the frequency band of interest is connected to the substitution antenna with a cable that has been constructed to not interfere with the radiation pattern of the antenna. A power (P_{Mea}) is applied to the input of the substitution antenna, and adjust the level of the signal generator output until the value of the receiver reach the previously recorded (P_r). The power of signal source (P_{Mea}) is recorded. The test should be performed by rotating the test item and adjusting the receiving antenna polarization.

5. A amplifier should be connected to the Signal Source output port. And the cable should be connect between the Amplifier and the Substitution Antenna. The cable loss (P_{cl}), the Substitution Antenna Gain (G_a) and the Amplifier Gain (P_{Ag}) should be recorded after test.

The measurement results are obtained as described below:

$$\text{Power(EIRP)} = P_{\text{Mea}} + P_{\text{Ag}} - P_{\text{cl}} + G_a$$

6. This value is EIRP since the measurement is calibrated using an antenna of known gain (2.15 dBi) and known input power.
7. ERP can be calculated from EIRP by subtracting the gain of the dipole, $\text{ERP} = \text{EIRP} - 2.15\text{dBi}$.

TEST LIMIT

According to 22.913(a)(5), 24.232(c), the ERP(EIRP) should be not exceeding following table limits:

| | Burst Average EIRP |
|--------------|----------------------------------|
| UMTS Band II | FCC: $\leq 33.01\text{dBm}$ (2W) |

| | Burst Average ERP |
|-------------|----------------------------------|
| UMTS Band V | FCC: $\leq 38.45\text{dBm}$ (7W) |

TEST RESULTS

Remark:

- We were tested all Configuration refer 3GPP TS134 121.
- $\text{EIRP} = P_{\text{Mea}}(\text{dBm}) - P_{\text{cl}}(\text{dB}) + P_{\text{Ag}}(\text{dB}) + G_a(\text{dBi})$
- $\text{ERP} = \text{EIRP} - 2.15\text{dBi}$ as EIRP by subtracting the gain of the dipole.
- Margin = Emission Level - Limit
- We test the H direction and V direction recorded worst case.

UMTS/TM1/UMTS Band II

| Frequency (MHz) | P_{Mea} (dBm) | P_{cl} (dB) | G_a Antenna Gain (dB) | P_{Ag} (dB) | Burst Peak EIRP (dBm) | Limit (dBm) | Margin (dB) | Polarization |
|-----------------|------------------------|----------------------|-------------------------|----------------------|-----------------------|-------------|-------------|--------------|
| 1852.40 | -17.23 | 4.03 | 8.38 | 35.51 | 22.63 | 33.01 | -10.38 | V |
| 1880.00 | -16.33 | 4.08 | 8.33 | 35.56 | 23.48 | 33.01 | -9.53 | V |
| 1907.60 | -16.05 | 4.14 | 8.26 | 35.63 | 23.70 | 33.01 | -9.31 | V |

UMTS/TM1/UMTS Band V

| Frequency (MHz) | P_{Mea} (dBm) | P_{cl} (dB) | G_a Antenna Gain (dB) | Correction (dB) | P_{Ag} (dB) | Burst Peak ERP (dBm) | Limit (dBm) | Margin (dB) | Polarization |
|-----------------|------------------------|----------------------|-------------------------|-----------------|----------------------|----------------------|-------------|-------------|--------------|
| 826.40 | -17.09 | 3.45 | 8.45 | 33.79 | 2.15 | 19.55 | 38.45 | -18.90 | V |
| 836.40 | -17.31 | 3.49 | 8.45 | 33.85 | 2.15 | 19.35 | 38.45 | -19.10 | V |
| 846.60 | -16.37 | 3.55 | 8.36 | 33.88 | 2.15 | 20.17 | 38.45 | -18.28 | V |

4.2 Radiated Spurious Emission

TEST APPLICABLE

According to the ANSI/TIA-603-E-2016 and FCC Part 2.1033 test method, The Receiver or Spectrum was scanned from lowest frequency frequency generated within the equipment to the 10th harmonic of the highest frequency generated within the equipment, which is the transmitted carrier that can be as high as 1910 MHz. The resolution bandwidth is set as outlined in Part 24.238, Part 22.917, RSS-132 §5.5 and RSS-133 §6.5. The spectrum is scanned with the mobile station transmitting at carrier frequencies that pertain to low, mid and high channels of WCDMA Band II and WCDMA Band V.

TEST CONFIGURATION

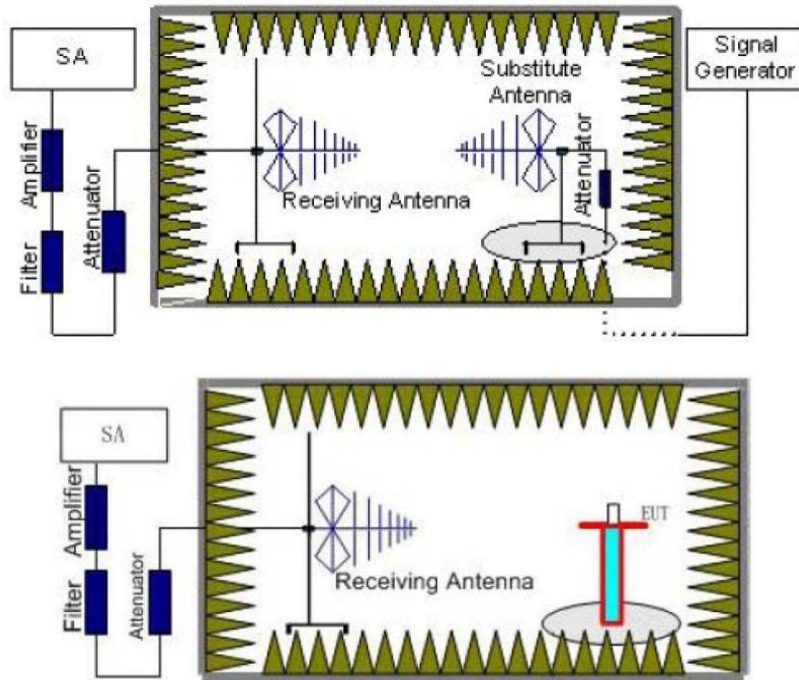

TEST PROCEDURE

1. EUT was placed on a 1.50 meter high non-conductive stand at a 3 meter test distance from the receive antenna. A receiving antenna was placed on the antenna mast 3 meters from the EUT for emission measurements. The height of receiving antenna is 1.50 m. Detected emissions were maximized at each frequency by rotating the EUT through 360° and adjusting the receiving antenna polarization. The radiated emission measurements of all transmit frequencies in three channels (High, Middle, Low) were measured with peak detector.
2. A log-periodic antenna or double-ridged waveguide horn antenna shall be substituted in place of the EUT. The log-periodic antenna will be driven by a signal generator and the level will be adjusted till the same power value on the spectrum analyzer or receiver. The level of the spurious emissions can be calculated through the level of the signal generator, cable loss, the gain of the substitution antenna and the reading of the spectrum analyzer or receiver.
3. The EUT is then put into continuously transmitting mode at its maximum power level during the test. Set Test Receiver or Spectrum RBW=1MHz, VBW=3MHz, And the maximum value of the receiver should be recorded as (P_r).
4. The EUT shall be replaced by a substitution antenna. In the chamber, an substitution antenna for the frequency band of interest is placed at the reference point of the chamber. An RF Signal source for the frequency band of interest is connected to the substitution antenna with a cable that has been constructed to not interfere with the radiation pattern of the antenna. A power (P_{Mea}) is applied to the input of the substitution antenna, and adjust the level of the signal generator output until the value of the receiver reach the previously recorded (P_r). The power of signal source (P_{Mea}) is recorded. The test should be performed by rotating the test item and adjusting the receiving antenna polarization.

5. A amplifier should be connected to the Signal Source output port. And the cable should be connect between the Amplifier and the Substitution Antenna. The cable loss (P_{cl}), the Substitution Antenna Gain (G_a) and the Amplifier Gain (P_{Ag}) should be recorded after test.

The measurement results are obtained as described below:

$$\text{Power(EIRP)} = P_{\text{Mea}} + P_{\text{Ag}} - P_{\text{cl}} + G_a$$

6. This value is EIRP since the measurement is calibrated using an antenna of known gain (2.15 dBi) and known input power.
7. ERP can be calculated from EIRP by subtracting the gain of the dipole, $\text{ERP} = \text{EIRP} - 2.15\text{dBi}$.
8. In order to make sure test results more clearly, we set frequency range and sweep time for difference frequency range as follows table:

| Working Frequency | Subrange (GHz) | RBW | VBW | Sweep time (s) |
|----------------------------|----------------|--------|--------|----------------|
| UMTS/TM1/ WCDMA Band V | 0.00009~0.15 | 1KHz | 3KHz | 30 |
| | 0.00015~0.03 | 10KHz | 30KHz | 10 |
| | 0.03~1 | 100KHz | 300KHz | 10 |
| | 1~2 | 1 MHz | 3 MHz | 2 |
| | 2~5 | 1 MHz | 3 MHz | 3 |
| | 5~8 | 1 MHz | 3 MHz | 3 |
| | 8~10 | 1 MHz | 3 MHz | 3 |
| UMTS/TM1/ WCDMA Band II | 0.00009~0.15 | 1KHz | 3KHz | 30 |
| | 0.00015~0.03 | 10KHz | 30KHz | 10 |
| | 0.03~1 | 100KHz | 300KHz | 10 |
| | 1~2 | 1 MHz | 3 MHz | 2 |
| | 2~5 | 1 MHz | 3 MHz | 3 |
| | 5~8 | 1 MHz | 3 MHz | 3 |
| | 8~11 | 1 MHz | 3 MHz | 3 |
| | 11~14 | 1 MHz | 3 MHz | 3 |
| | 14~18 | 1 MHz | 3 MHz | 3 |
| 18~20 | 1 MHz | 3 MHz | 2 | |

TEST LIMITS

According to 24.238 and 22.917 specify that the power of any emission outside of the authorized operating frequency ranges must be attenuated below the transmitting power (P) by a factor of at least $43 + 10 \log(P)$ dB. The specification that emissions shall be attenuated below the transmitter power (P) by at least $43 + 10 \log(P)$ dB, translates in the relevant power range (1 to 0.001 W) to -13 dBm. At 1 W the specified minimum attenuation becomes 43 dB and relative to a 30 dBm (1 W) carrier becomes a limit of -13 dBm. At 0.001 W (0 dBm) the minimum attenuation is 13 dB, which again yields a limit of -13 dBm. In this way a translation of the specification from relative to absolute terms is carried out.

| Frequency | Channel | Frequency Range | Verdict |
|----------------------------|---------|-----------------|---------|
| UMTS/TM1/ WCDMA Band V | Low | 9KHz - 10GHz | PASS |
| | Middle | 9KHz - 10GHz | PASS |
| | High | 9KHz - 10GHz | PASS |
| UMTS/TM1/ WCDMA Band II | Low | 9KHz - 18GHz | PASS |
| | Middle | 9KHz - 18GHz | PASS |
| | High | 9KHz - 18GHz | PASS |

TEST RESULTS

Remark:

1. We were tested all Configuration refer 3GPP TS134 121.
2. $EIRP = P_{Mea}(dBm) - P_{cl}(dB) + P_{Ag}(dB) + G_a(dBi)$
3. $ERP = EIRP - 2.15dB$ as EIRP by subtracting the gain of the dipole.
4. $Margin = EIRP - Limit$

UMTS/TM1/ WCDMA Band II _ Low Channel

| Frequency (MHz) | P _{Mea} (dBm) | P _{cl} (dB) | Diatance | G _a Antenna Gain(dB) | Peak EIRP (dBm) | Limit (dBm) | Margin (dB) | Polarization |
|-----------------|------------------------|----------------------|----------|---------------------------------|-----------------|-------------|-------------|--------------|
| 3704.8 | -40.10 | 5.26 | 3.00 | 9.88 | -35.48 | -13.00 | -22.48 | H |
| 5557.2 | -52.97 | 6.11 | 3.00 | 11.36 | -47.72 | -13.00 | -34.72 | H |
| 3704.8 | -43.22 | 5.26 | 3.00 | 9.88 | -38.60 | -13.00 | -25.60 | V |
| 5557.2 | -48.84 | 6.11 | 3.00 | 11.36 | -43.59 | -13.00 | -30.59 | V |

UMTS/TM1/ WCDMA Band II _ Middle Channel

| Frequency (MHz) | P _{Mea} (dBm) | P _{cl} (dB) | Diatance | G _a Antenna Gain(dB) | Peak EIRP (dBm) | Limit (dBm) | Margin (dB) | Polarization |
|-----------------|------------------------|----------------------|----------|---------------------------------|-----------------|-------------|-------------|--------------|
| 3760.0 | -40.69 | 5.32 | 3.00 | 10.03 | -35.98 | -13.00 | -22.98 | H |
| 5640.0 | -50.64 | 6.19 | 3.00 | 11.41 | -45.42 | -13.00 | -32.42 | H |
| 3760.0 | -44.27 | 5.32 | 3.00 | 10.03 | -39.56 | -13.00 | -26.56 | V |
| 5640.0 | -52.36 | 6.19 | 3.00 | 11.41 | -47.14 | -13.00 | -34.14 | V |

UMTS/TM1/ WCDMA Band II _ High Channel

| Frequency (MHz) | P _{Mea} (dBm) | P _{cl} (dB) | Diatance | G _a Antenna Gain(dB) | Peak EIRP (dBm) | Limit (dBm) | Margin (dB) | Polarization |
|-----------------|------------------------|----------------------|----------|---------------------------------|-----------------|-------------|-------------|--------------|
| 3815.2 | -43.59 | 5.36 | 3.00 | 9.62 | -39.33 | -13.00 | -26.33 | H |
| 5722.8 | -55.11 | 6.24 | 3.00 | 11.46 | -49.89 | -13.00 | -36.89 | H |
| 3815.2 | -44.74 | 5.36 | 3.00 | 9.62 | -40.48 | -13.00 | -27.48 | V |
| 5722.8 | -55.30 | 6.24 | 3.00 | 11.46 | -50.08 | -13.00 | -37.08 | V |

UMTS/TM1/ WCDMA Band V _ Low Channel

| Frequency (MHz) | P _{Mea} (dBm) | P _{cl} (dB) | Diatance | G _a Antenna Gain(dB) | Peak EIRP (dBm) | Limit (dBm) | Margin (dB) | Polarization |
|-----------------|------------------------|----------------------|----------|---------------------------------|-----------------|-------------|-------------|--------------|
| 1652.8 | -45.12 | 3.86 | 3.00 | 8.56 | -40.42 | -13.00 | -27.42 | H |
| 2479.2 | -49.82 | 4.29 | 3.00 | 6.98 | -47.13 | -13.00 | -34.13 | H |
| 1652.8 | -40.57 | 3.86 | 3.00 | 8.56 | -35.87 | -13.00 | -22.87 | V |
| 2479.2 | -48.01 | 4.29 | 3.00 | 6.98 | -45.32 | -13.00 | -32.32 | V |

UMTS/TM1/ WCDMA Band V _ Middle Channel

| Frequency (MHz) | P _{Mea} (dBm) | P _{cl} (dB) | Diatance | G _a Antenna Gain(dB) | Peak EIRP (dBm) | Limit (dBm) | Margin (dB) | Polarization |
|-----------------|------------------------|----------------------|----------|---------------------------------|-----------------|-------------|-------------|--------------|
| 1672.8 | -40.62 | 3.90 | 3.00 | 8.58 | -35.94 | -13.00 | -22.94 | H |
| 2509.2 | -48.70 | 4.32 | 3.00 | 6.80 | -46.22 | -13.00 | -33.22 | H |
| 1672.8 | -42.80 | 3.90 | 3.00 | 8.58 | -38.12 | -13.00 | -25.12 | V |
| 2509.2 | -49.50 | 4.32 | 3.00 | 6.80 | -47.02 | -13.00 | -34.02 | V |

UMTS/TM1/ WCDMA Band V _ High Channel

| Frequency (MHz) | P _{Mea} (dBm) | P _{cl} (dB) | Diatance | G _a Antenna Gain(dB) | Peak EIRP (dBm) | Limit (dBm) | Margin (dB) | Polarization |
|-----------------|------------------------|----------------------|----------|---------------------------------|-----------------|-------------|-------------|--------------|
| 1693.2 | -43.00 | 3.91 | 3.00 | 9.06 | -37.85 | -13.00 | -24.85 | H |
| 2539.8 | -46.34 | 4.32 | 3.00 | 6.65 | -44.01 | -13.00 | -31.01 | H |
| 1693.2 | -41.21 | 3.91 | 3.00 | 9.06 | -36.06 | -13.00 | -23.06 | V |
| 2539.8 | -52.80 | 4.32 | 3.00 | 6.65 | -50.47 | -13.00 | -37.47 | V |

4.3 Occupied Bandwidth and Emission Bandwidth

TEST APPLICABLE

Similar to conducted emissions; occupied bandwidth measurements are only provided for selected frequencies in order to reduce the amount of submitted data. The table below lists the measured 99% Bandwidth and -26dBc Bandwidth.

TEST CONFIGURATION

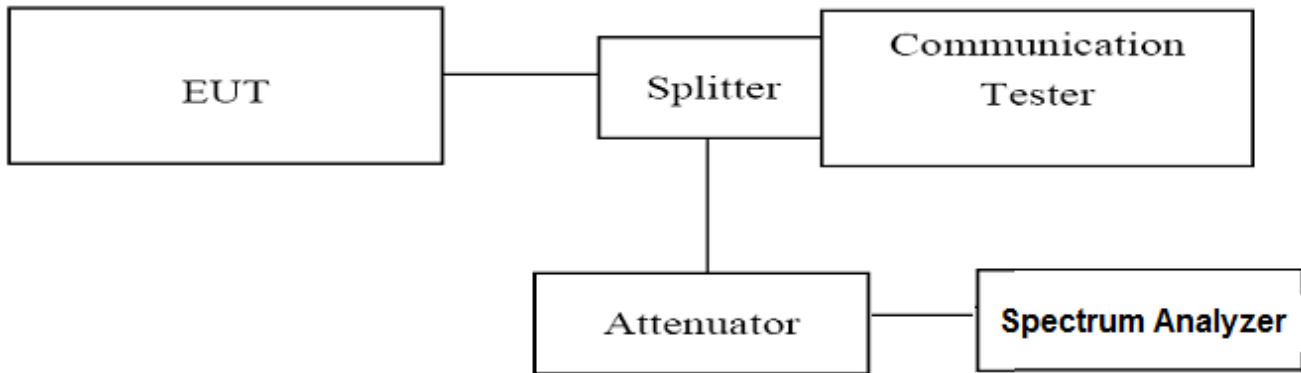

TEST PROCEDURE

1. The EUT was set up for the max output power with pseudo random data modulation;
2. The Occupied bandwidth and Emission Bandwidth were measured with Agilent Spectrum Analyzer N9020A (peak);
3. Set RBW=100KHz,VBW=300KHz,Span=10MHz,SWT=Auto;
4. Set SPA Max hold and View, Set 99% Occupied Bandwidth/ Set -26dBc Occupied Bandwidth
5. These measurements were done at 3 frequencies for WCDMA band II/V. (low, middle and high of operational frequency range).

TEST RESULTS

| Test Mode | Channel | Frequency (MHz) | Occupied Bandwidth (99% BW) (MHz) | Emission Bandwidth (-26 dBc BW) (MHz) | Verdict |
|------------------------------|---------|-----------------|-----------------------------------|---------------------------------------|---------|
| UMTS/TM1/ WCDMA Band II | 9262 | 1852.40 | 4.1735 | 4.710 | PASS |
| | 9400 | 1880.00 | 4.1756 | 4.724 | PASS |
| | 9538 | 1907.60 | 4.1707 | 4.744 | PASS |
| UMTS/TM1/ WCDMA Band V | 4132 | 826.40 | 4.1622 | 4.701 | PASS |
| | 4182 | 836.40 | 4.1753 | 4.718 | PASS |
| | 4233 | 846.60 | 4.1630 | 4.718 | PASS |

Remark:

1. Test results including cable loss;
2. Please refer to following plots;

Occupied Bandwidth and Emission Bandwidth

UMTS/TM1/ WCDMA Band II

UMTS/TM1/ WCDMA Band V

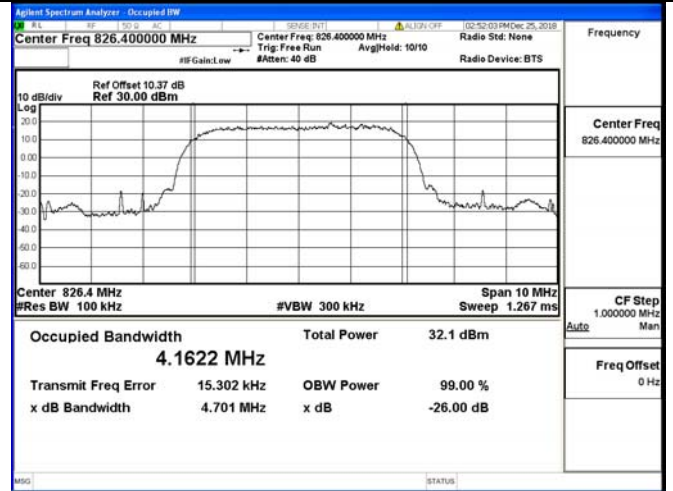
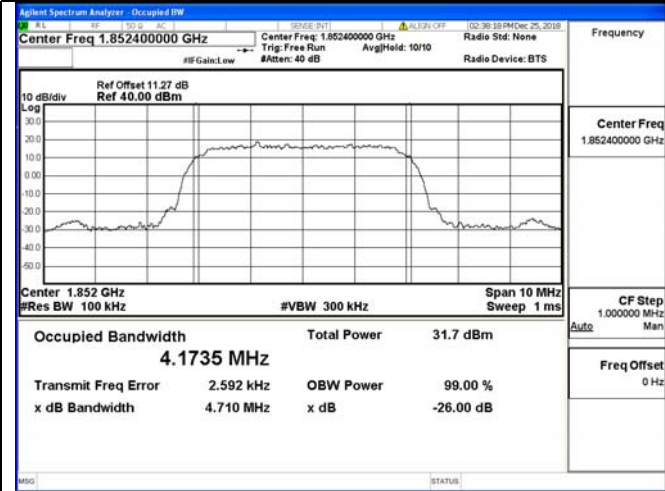

Channel 9262 / 1852.4 MHz

Channel 4132 / 826.4 MHz

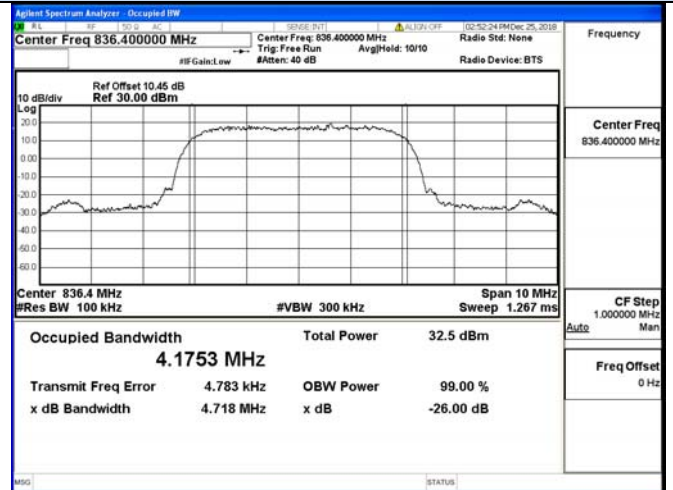
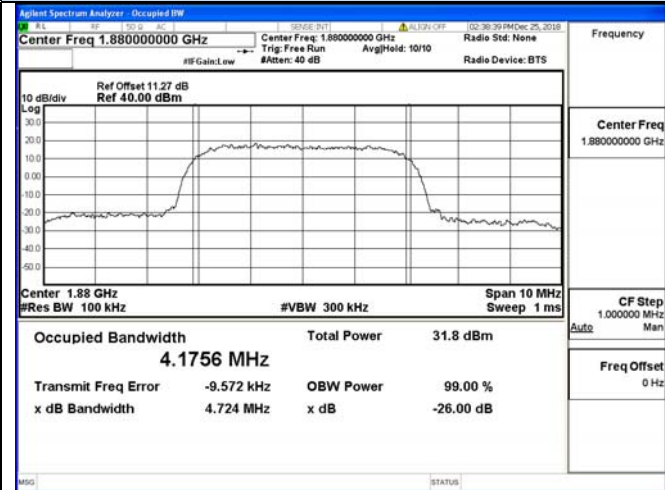

Channel 9400 / 1880.0 MHz

Channel 4182 / 836.4 MHz

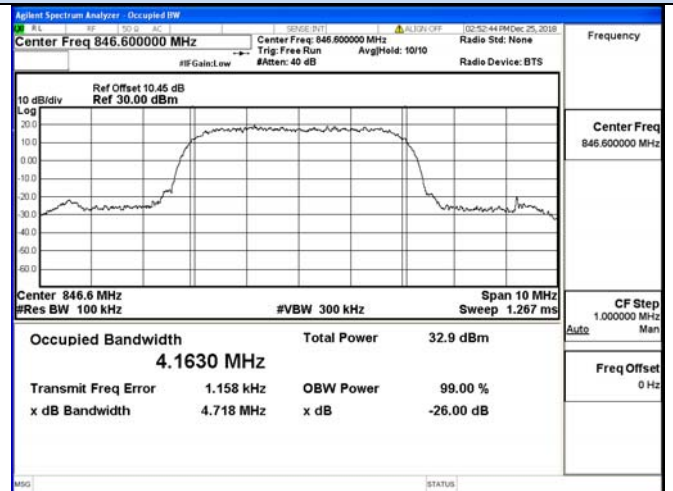
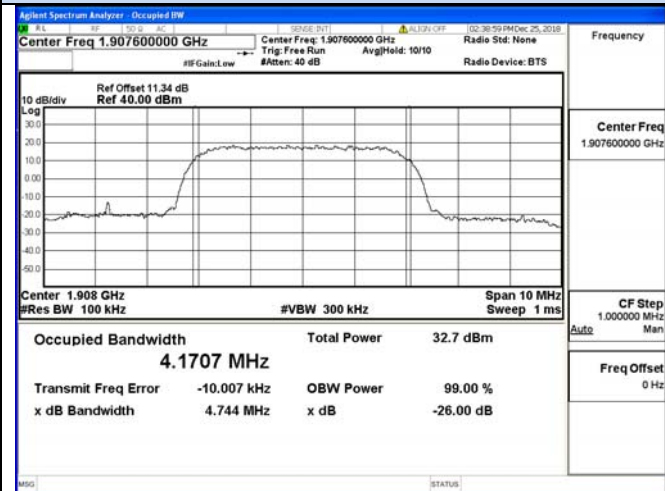

Channel 9538 / 1907.6 MHz

Channel 4233 / 846.6 MHz

4.4 Band Edge Compliance

TEST APPLICABLE

During the process of testing, the EUT was controlled via Digital Radio Communication tester (CMU200) to ensure max power transmission and proper modulation.

TEST CONFIGURATION

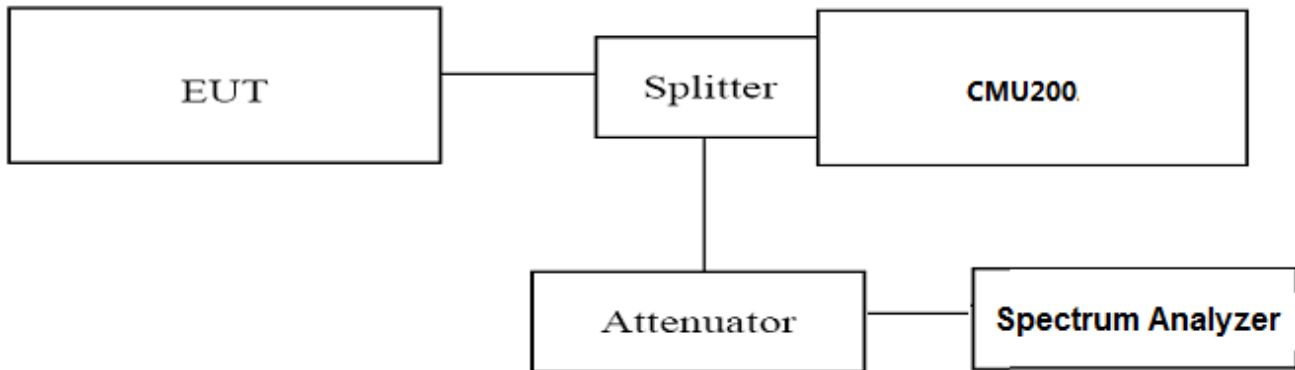

TEST PROCEDURE

1. The EUT was set up for the max output power with pseudo random data modulation;
 2. The power was measured with Spectrum Analyzer N9020A;
 3. Set RBW=51KHz,VBW=200KHz,Span=2MHz,SWT=Auto,Detector: RMS;
- These measurements were done at 2 frequencies for WCDMA Band II/V. (low and high of operational frequency range).

TEST RESULTS

| UMTS/TM1/WCDMA Band II | | | | | |
|------------------------|---------|-----------------|---------------------------|--------------|---------|
| Test Mode | Channel | Frequency (MHz) | Band Edg Compliance (dBm) | Limits (dBm) | Verdict |
| UMTS/TM1/WCDMA Band II | 9262 | 1852.40 | <-13dBm | -13dBm | PASS |
| | 9538 | 1907.60 | <-13dBm | -13dBm | |
| UMTS/TM1/WCDMA Band V | | | | | |
| Test Mode | Channel | Frequency (MHz) | Band Edg Compliance (dBm) | Limits (dBm) | Verdict |
| UMTS/TM1/WCDMA Band V | 4132 | 826.40 | <-13dBm | -13dBm | PASS |
| | 4233 | 846.60 | <-13dBm | -13dBm | |

Remark:

1. Test results including cable loss;
2. Please refer to following plots;

Band-edge Compliance

UMTS/TM1/WCDMA Band II

UMTS/TM1/WCDMA Band V

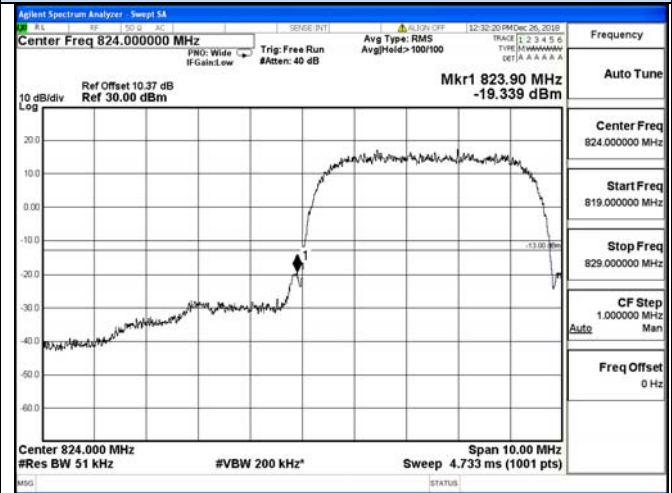
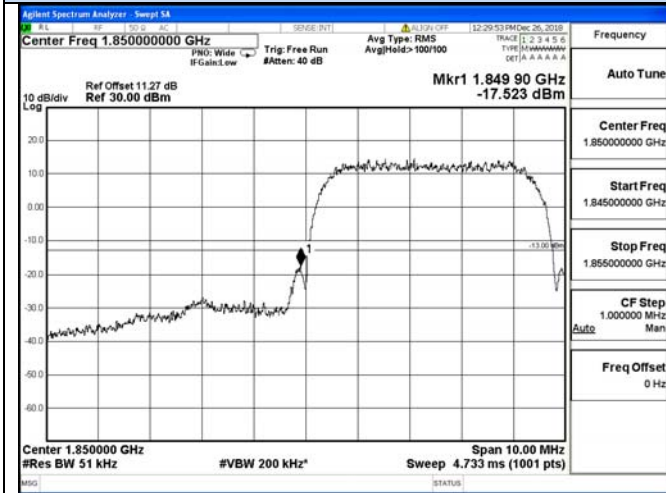

Channel 9262 / 1852.4 MHz

Channel 4132 / 826.4 MHz

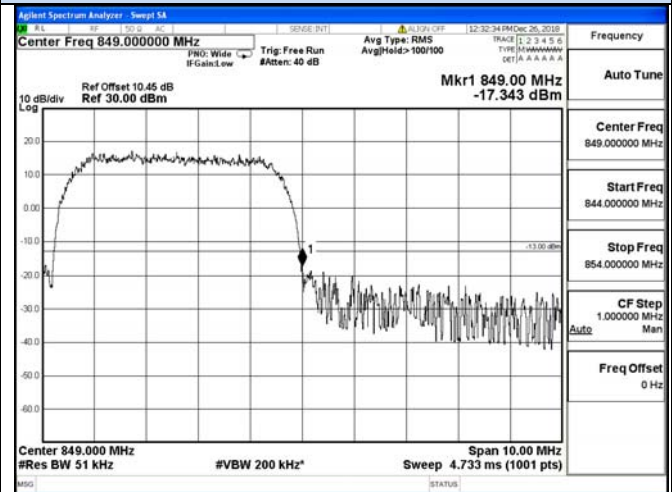
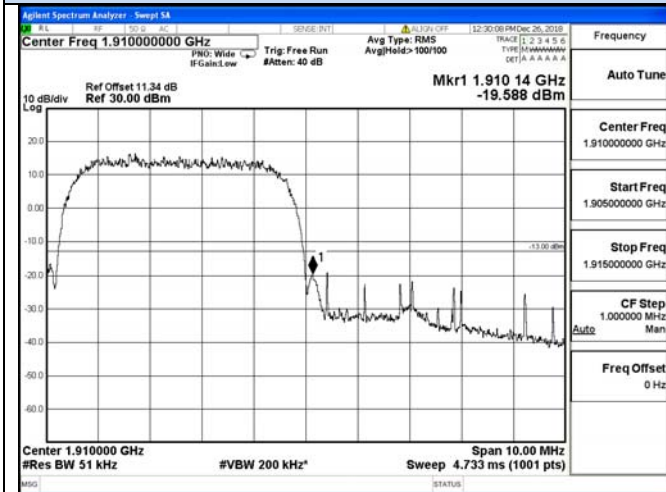

Channel 9538 / 1907.6 MHz

Channel 4233 / 846.6 MHz

4.5 Spurious Emission on Antenna Port

TEST APPLICABLE

The following steps outline the procedure used to measure the conducted emissions from the EUT.

1. Determine frequency range for measurements: From CFR 2.1057 the spectrum should be investigated from the lowest radio frequency generated in the equipment up to at least the 10th harmonic of the carrier frequency. For the equipment of WCDMA band II, this equates to a frequency range of 9 KHz to 20GHz, data taken from 30 MHz to 20 GHz. For WCDMA Band V, this equates to a frequency range of 9 KHz to 10 GHz, data taken from 30 MHz to 10 GHz.
2. The sweep time is set automatically by instrument itself. That should be the optimal sweep time for the span and the RBW. If the sweep time is too short, that is sweep is too fast, the sweep result is not accurate; if the sweep time is too long, that is sweep is too low, some frequency components may be lost. The instrument will give an optimal sweep time according the selected span and RBW.
3. The procedure to get the conducted spurious emission is as follows:
The trace mode is set to MaxHold to get the highest signal at each frequency;
Wait 25 seconds;
Get the result.
4. Determine EUT transmit frequencies: below outlines the band edge frequencies pertinent to conducted emissions testing.

TEST CONFIGURATION

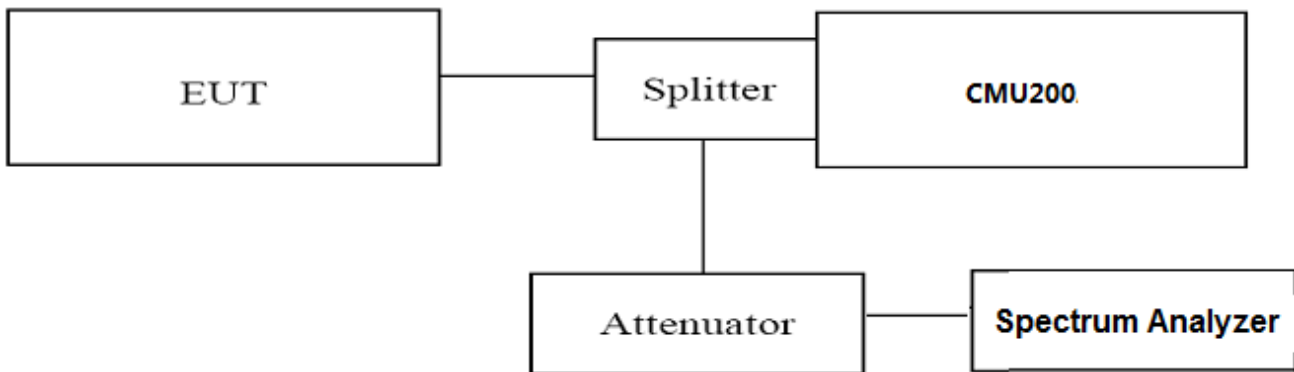

TEST PROCEDURE

1. The EUT was set up for the max output power with pseudo random data modulation;
2. The power was measured with Spectrum Analyzer N9020A;
3. These measurements were done at 3 frequencies for WCDMA band II/V. (low, middle and high of operational frequency range).

TEST LIMIT

Part 24.238 and Part 22.917 specify that the power of any emission outside of the authorized operating frequency ranges must be attenuated below the transmitting power (P) by a factor of at least $43 + 10 \log(P)$ dB.

The specification that emissions shall be attenuated below the transmitter power (P) by at least $43 + 10 \log(P)$ dB, translates in the relevant power range (1 to 0.001 W) to -13 dBm. At 1 W the specified minimum attenuation becomes 43 dB and relative to a 30 dBm (1 W) carrier becomes a limit of -13 dBm. At 0.001 W (0 dBm) the minimum attenuation is 13 dB, which again yields a limit of -13 dBm. In this way a translation of the specification from relative to absolute terms is carried out.

TEST RESULTS

| Test Mode | Channel | Frequency (MHz) | Spurious RF Conducted Emission (dBm) | Limits (dBm) | Verdict |
|---------------------------|---------|-----------------|--------------------------------------|--------------|---------|
| UMTS/TM1/WCDMA Band II | 9262 | 1852.40 | <-13dBm | -13dBm | PASS |
| | 9400 | 1880.00 | <-13dBm | -13dBm | |
| | 9538 | 1907.60 | <-13dBm | -13dBm | |
| UMTS/TM1/WCDMA Band V | 4132 | 826.40 | <-13dBm | -13dBm | PASS |
| | 4182 | 836.40 | <-13dBm | -13dBm | |
| | 4233 | 846.60 | <-13dBm | -13dBm | |

Remark:

1. Test results including cable loss;
2. Please refer to following plots;
3. Not recorded test plots from 9 KHz to 30 MHz as emission levels 20dB lower than emission limit;

Spurious Emssion on Antenna Port UMTS/TM1/WCDMA Band II Channel 9262 / 1852.4 MHz

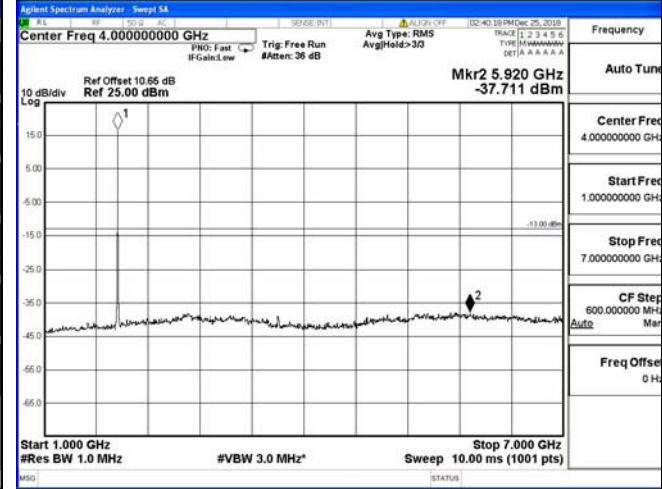
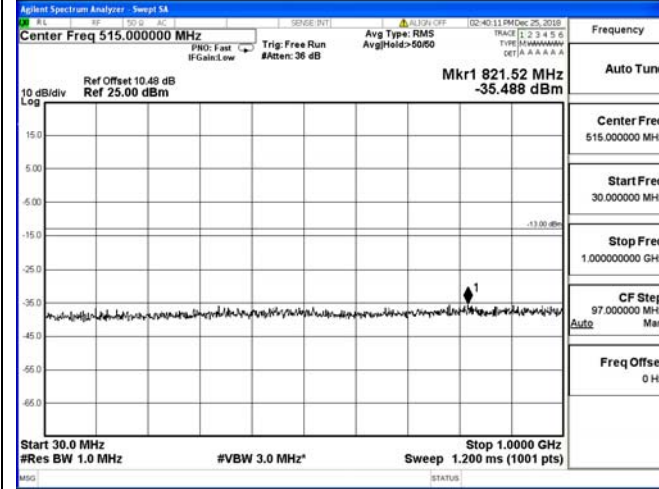

30 MHz – 1000 MHz

1 GHz – 7 GHz

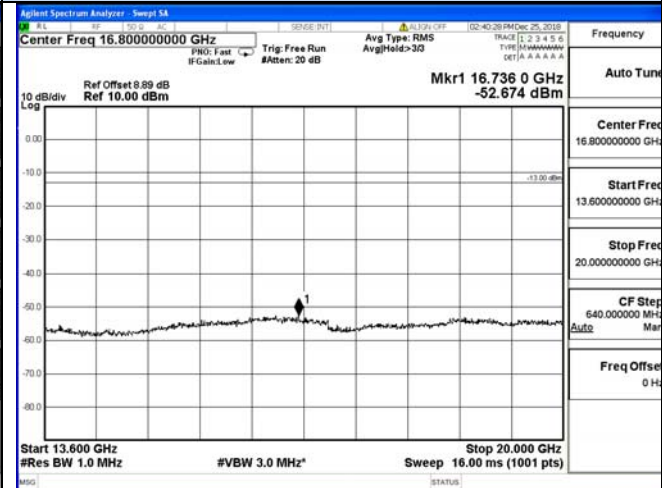
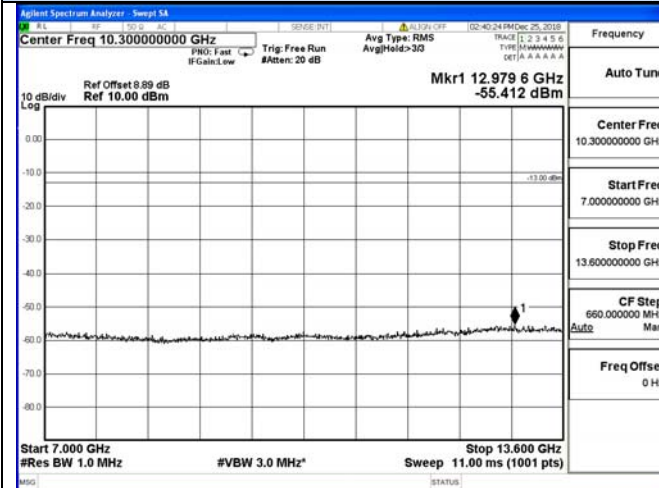

7 GHz – 13.6 GHz

13.6 GHz – 20 GHz

Spurious Emssion on Antenna Port
UMTS/TM1/WCDMA Band II
Channel 9400 / 1880 MHz

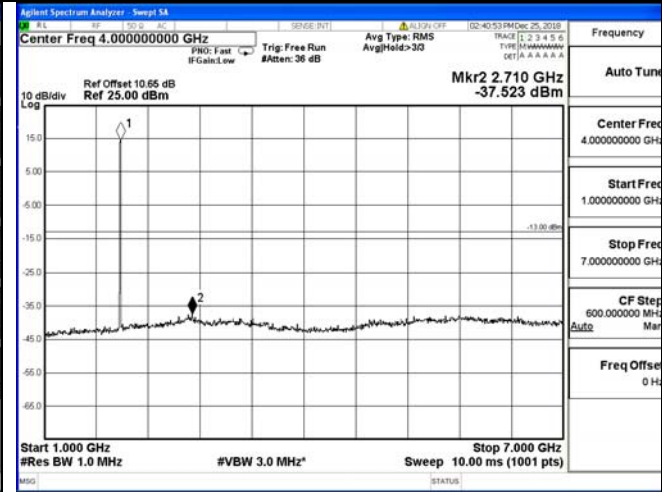
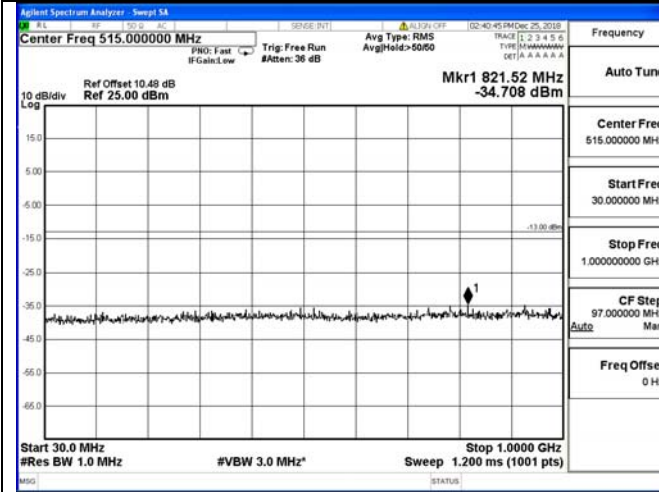

30 MHz – 1000 MHz

1 GHz – 7 GHz

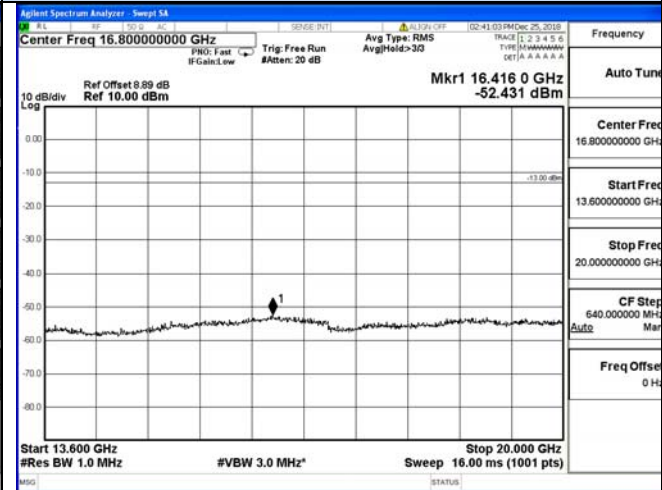
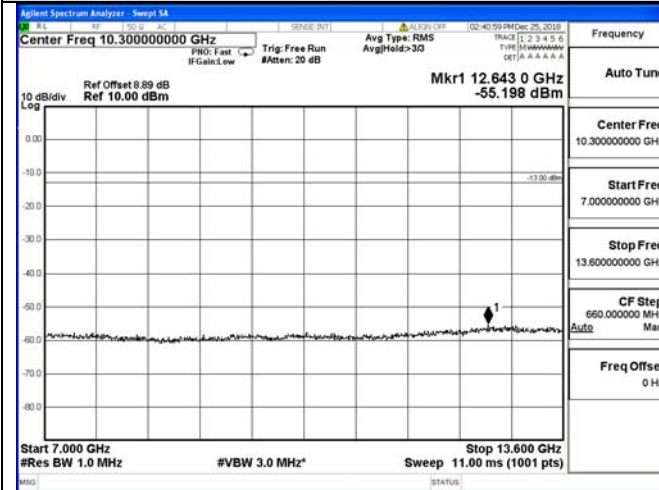

7 GHz – 13.6 GHz

13.6 GHz – 20 GHz

Spurious Emssion on Antenna Port UMTS/TM1/WCDMA Band II Channel 9538 / 1907.6 MHz

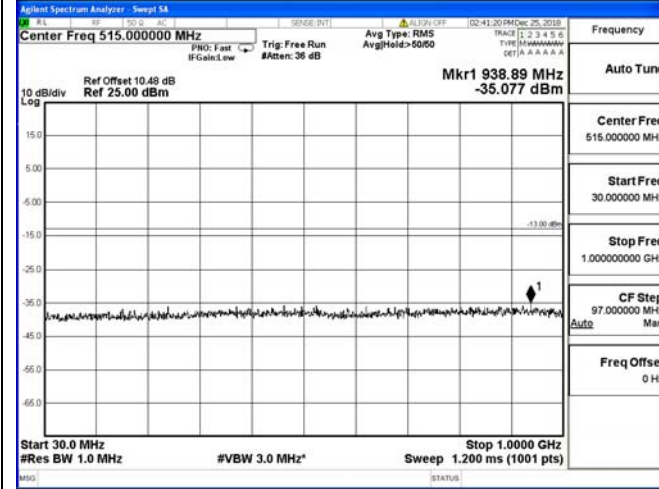

30 MHz – 1000 MHz

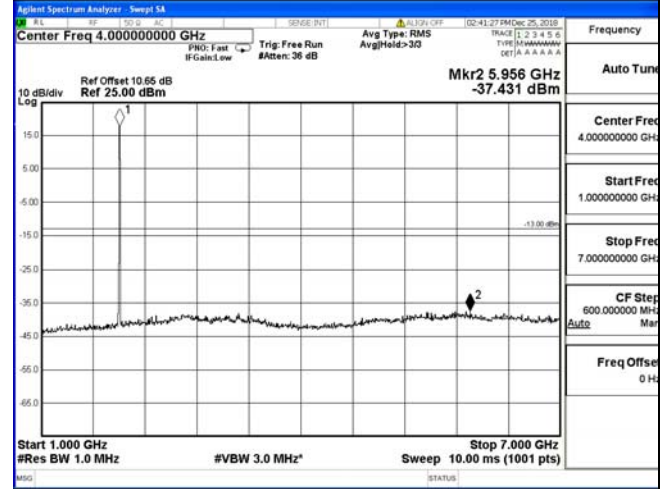

1 GHz – 7 GHz

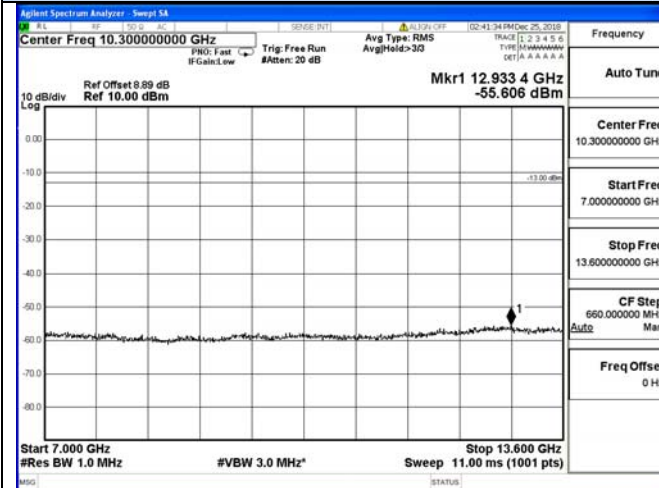

7 GHz – 13.6 GHz

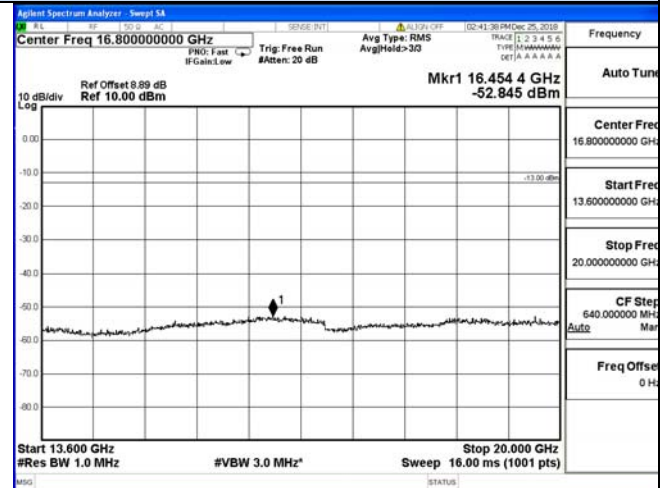

13.6 GHz – 20 GHz

Spurious Emission on Antenna Port
UMTS/TM1/WCDMA Band V

Channel 4132 / 826.4 MHz

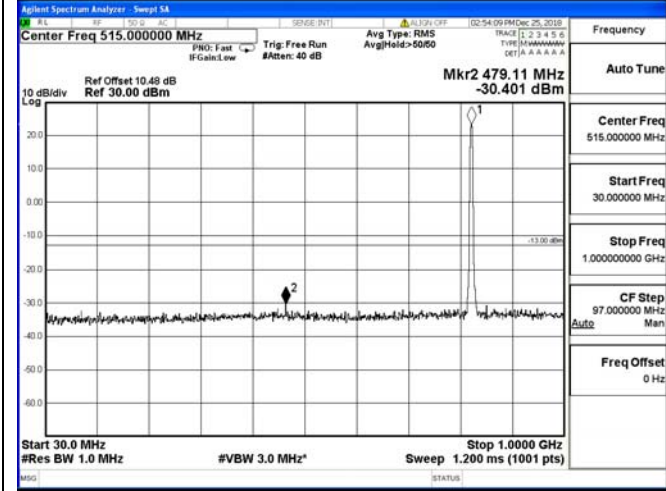

Channel 4182 / 836.4 MHz

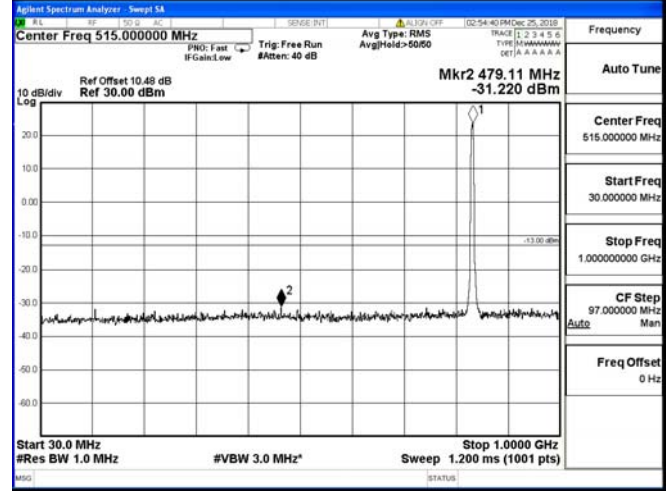

30 MHz – 1000 MHz

30 MHz – 1000 MHz

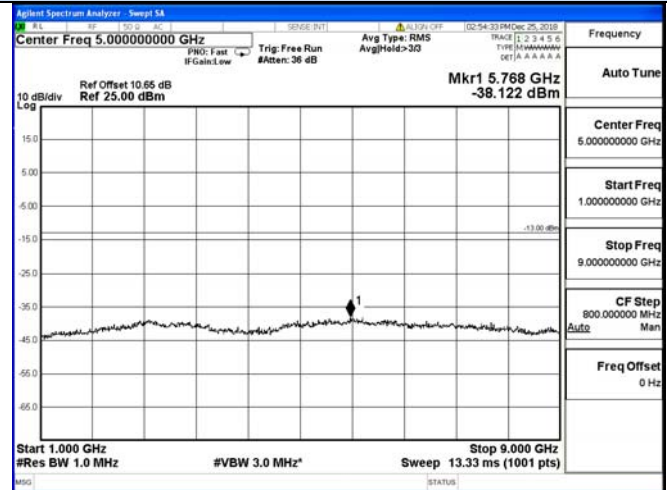
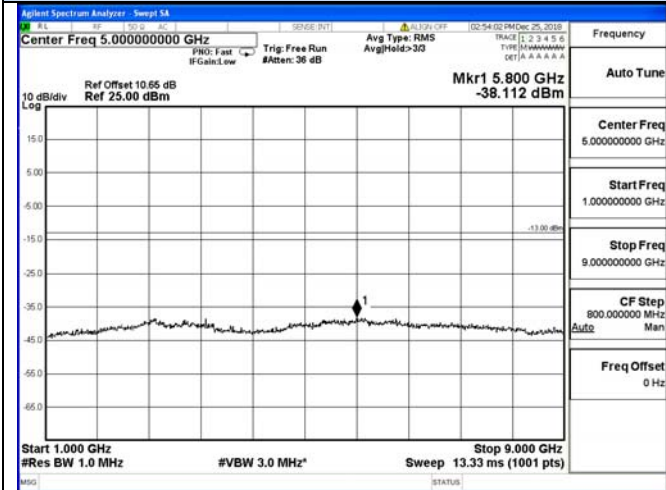

1 GHz – 9 GHz

1 GHz – 9 GHz

UMTS/TM1/WCDMA Band V

Channel 4233 / 846.6 MHz

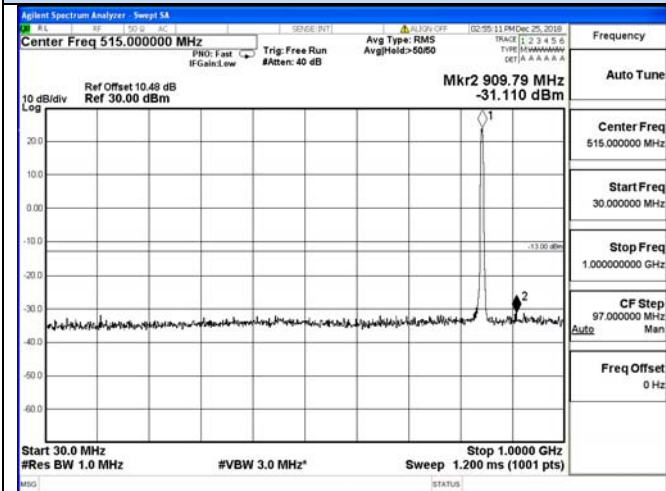

Channel 4233 / 846.6 MHz

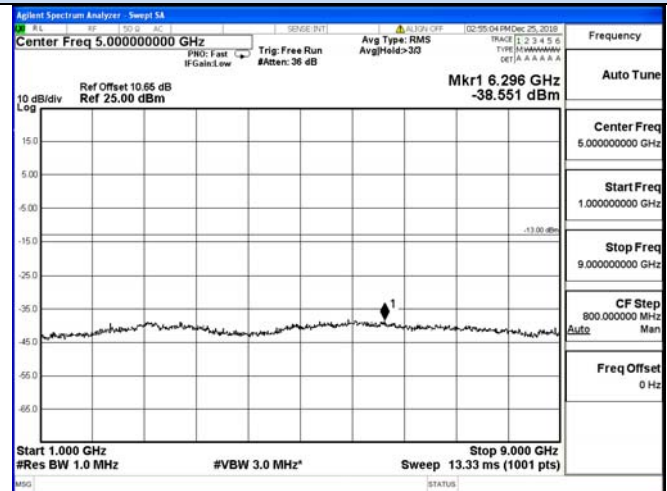

30 MHz – 1000 MHz

1 GHz – 9 GHz

4.6 Frequency Stability Test

TEST APPLICABLE

1. According to FCC Part 2 Section 2.1055 (a)(1), the frequency stability shall be measured with variation of ambient temperature from -30°C to +50°C centigrade.
2. According to FCC Part 2 Section 2.1055 (e)(2) and RSS-GEN, for battery powered equipment, the frequency stability shall be measured with reducing primary supply voltage to the battery operating end point, which is specified by the manufacture.
3. Vary primary supply voltage from 85 to 115 percent of the nominal value for other than hand carried voltage equipment and the end voltage point was 3.40V.

TEST PROCEDURE

In order to measure the carrier frequency under the condition of AFC lock, it is necessary to make measurements with the EUT in a "call mode". This is accomplished with the use of R&S CMU200 DIGITAL RADIO COMMUNICATION TESTER.

1. Measure the carrier frequency at room temperature;
2. Subject the EUT to overnight soak at -30°C;
3. With the EUT, powered via nominal voltage, connected to the CMU200 and in a simulated call on middle channel of WCDMA Band II/V, measure the carrier frequency. These measurements should be made within 2 minutes of Powering up the EUT, to prevent significant self-warming;
4. Repeat the above measurements at 10°C increments from -30°C to +50°C. Allow at least 0.5 hours at each temperature, unpowered, before making measurements;
5. Remeasure carrier frequency at room temperature with nominal voltage. Vary supply voltage from minimum voltage to maximum voltage, in 0.1Volt increments remeasuring carrier frequency at each voltage. Pause at nominal voltage for 0.5 hours unpowered, to allow any self-heating to stabilize, before continuing;
6. Subject the EUT to overnight soak at +50°C;
7. With the EUT, powered via nominal voltage, connected to the CMU200 and in a simulated call on the centre channel, measure the carrier frequency. These measurements should be made within 2 minutes of Powering up the EUT, to prevent significant self-warming;
8. Repeat the above measurements at 10°C increments from +50°C to -30°C. Allow at least 0.5 hours at each temperature, unpowered, before making measurements;
9. At all temperature levels hold the temperature to +/- 0.5°C during the measurement procedure;

TEST CONFIGURATION

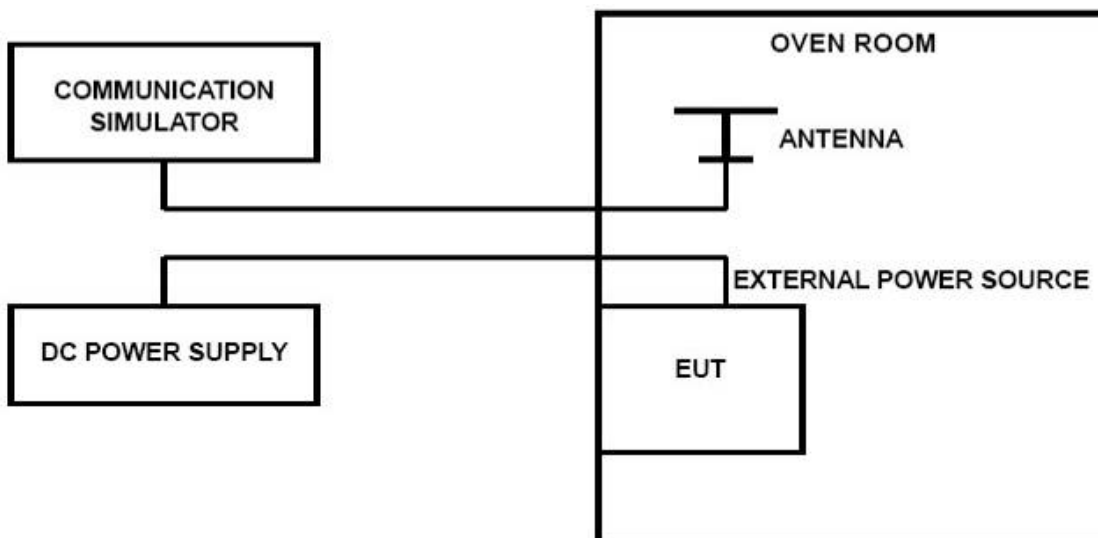

TEST LIMITS**For Hand carried battery powered equipment**

According to the JTC standard the frequency stability of the carrier shall be accurate to within 0.1 ppm of the received frequency from the base station. This accuracy is sufficient to meet Sec. 24.235, Frequency Stability. The frequency stability shall be sufficient to ensure that the fundamental emission stays within the authorized frequency block. As this transceiver is considered "Hand carried, battery powered equipment" Section 2.1055(d)(2) applies. This requires that the lower voltage for frequency stability testing be specified by the manufacturer. This transceiver is specified to operate with an input voltage of between 3.40VDC and 4.35VDC, with a nominal voltage of 3.80VDC. Operation above or below these voltage limits is prohibited by transceiver software in order to prevent improper operation as well as to protect components from overstress. These voltages represent a tolerance of -10 % and +12.5 %. For the purposes of measuring frequency stability these voltage limits are to be used.

For equipment powered by primary supply voltage

According to the JTC standard the frequency stability of the carrier shall be accurate to within 0.1 ppm of the received frequency from the base station. This accuracy is sufficient to meet Sec. 24.235, Frequency Stability. The frequency stability shall be sufficient to ensure that the fundamental emission stays within the authorized frequency block. For this EUT section 2.1055(d)(1) applies. This requires varying primary supply voltage from 85 to 115 percent of the nominal value for other than hand carried battery equipment.

TEST RESULTS

| UMTS/TM1/WCDMA Band II | | | | | |
|------------------------|------------------|---------------------|----------------------|-------------|---------|
| DC Power | Temperature (°C) | Frequency error(Hz) | Frequency error(ppm) | Limit (ppm) | Verdict |
| 3.40 | 25 | 8 | 0.004 | 2.50 | PASS |
| 3.80 | 25 | -20 | -0.011 | 2.50 | PASS |
| 4.35 | 25 | -2 | -0.001 | 2.50 | PASS |
| 3.80 | -30 | 7 | 0.004 | 2.50 | PASS |
| 3.80 | -20 | -1 | -0.001 | 2.50 | PASS |
| 3.80 | -10 | -10 | -0.005 | 2.50 | PASS |
| 3.80 | 0 | -1 | -0.001 | 2.50 | PASS |
| 3.80 | 10 | -9 | -0.005 | 2.50 | PASS |
| 3.80 | 20 | -20 | -0.011 | 2.50 | PASS |
| 3.80 | 30 | -16 | -0.009 | 2.50 | PASS |
| 3.80 | 40 | 8 | 0.004 | 2.50 | PASS |
| 3.80 | 50 | -8 | -0.004 | 2.50 | PASS |

| UMTS/TM1/WCDMA Band V | | | | | |
|-----------------------|------------------|---------------------|----------------------|-------------|---------|
| DC Power | Temperature (°C) | Frequency error(Hz) | Frequency error(ppm) | Limit (ppm) | Verdict |
| 3.40 | 25 | 9 | 0.011 | 2.50 | PASS |
| 3.80 | 25 | 1 | 0.001 | 2.50 | PASS |
| 4.35 | 25 | 2 | 0.002 | 2.50 | PASS |
| 3.80 | -30 | 14 | 0.017 | 2.50 | PASS |
| 3.80 | -20 | 0 | 0.000 | 2.50 | PASS |
| 3.80 | -10 | 1 | 0.001 | 2.50 | PASS |
| 3.80 | 0 | -12 | -0.015 | 2.50 | PASS |
| 3.80 | 10 | 13 | 0.016 | 2.50 | PASS |
| 3.80 | 20 | -3 | -0.004 | 2.50 | PASS |
| 3.80 | 30 | 7 | 0.008 | 2.50 | PASS |
| 3.80 | 40 | 2 | 0.002 | 2.50 | PASS |
| 3.80 | 50 | 17 | 0.021 | 2.50 | PASS |

4.7 Peak-to-Average Ratio (PAR)

LIMIT

The Peak-to-Average Ratio (PAR) of the transmission may not exceed 13 dB.

TEST CONFIGURATION

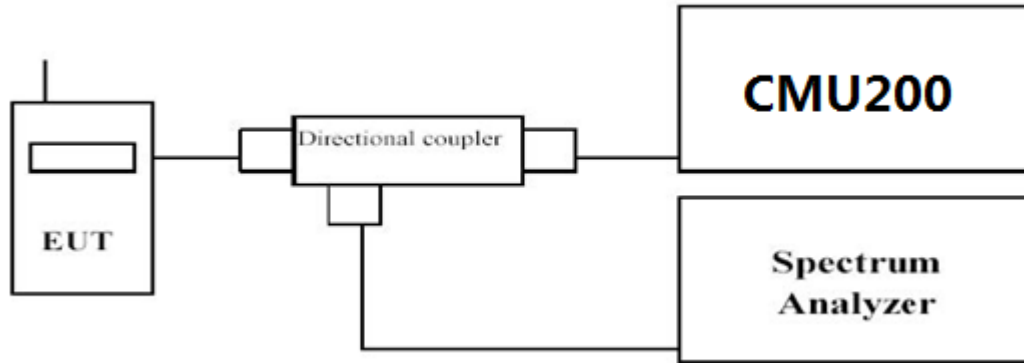

TEST PROCEDURE

1. Refer to instrument's analyzer instruction manual for details on how to use the power statistics/CCDF function;
2. Set resolution/measurement bandwidth \geq signal's occupied bandwidth;
3. Set the number of counts to a value that stabilizes the measured CCDF curve;
4. Set the measurement interval as follows:
 - 1). for continuous transmissions, set to 1 ms,
 - 2). for burst transmissions, employ an external trigger that is synchronized with the EUT burst timing sequence, or use the internal burst trigger with a trigger level that allows the burst to stabilize and set the measurement interval to a time that is less than or equal to the burst duration.
5. Record the maximum PAPR level associated with a probability of 0.1%.

TEST RESULTS

| Test Mode | Channel | Frequency (MHz) | PAPR Value (dB) | Limits (dB) | Verdict |
|----------------------------|---------|-----------------|-----------------|-------------|---------|
| UMTS/TM1/ WCDMA Band II | 9262 | 1852.40 | 2.62 | 13.0 | PASS |
| | 9400 | 1880.00 | 2.63 | 13.0 | PASS |
| | 9538 | 1907.60 | 2.61 | 13.0 | PASS |
| UMTS/TM1/ WCDMA Band V | 4132 | 826.40 | 2.65 | 13.0 | PASS |
| | 4182 | 836.40 | 2.61 | 13.0 | PASS |
| | 4233 | 846.60 | 2.62 | 13.0 | PASS |

Remark:

1. Test results including cable loss;
2. Please refer to following plots;

Peak-to-Average Ratio (PAR)

UMTS/TM1/ WCDMA Band II

UMTS/TM1/ WCDMA Band V

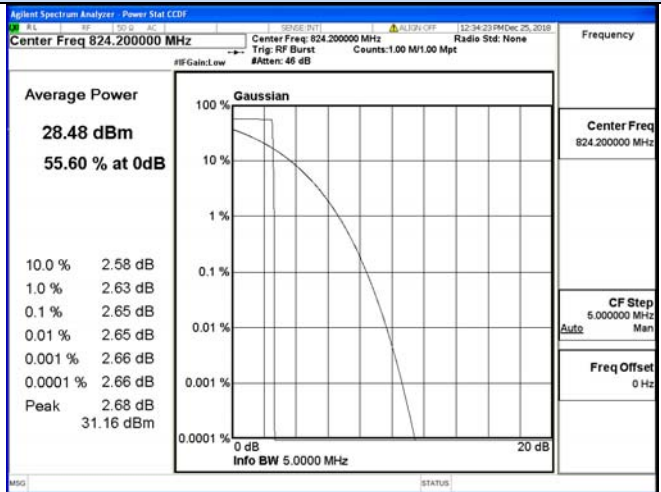
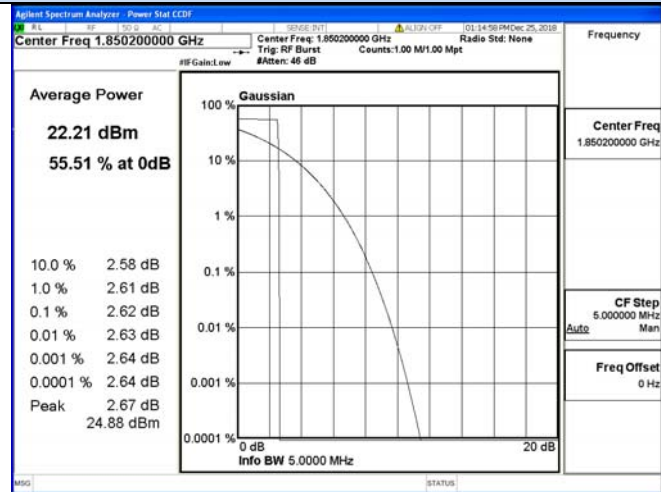

Channel 9262 / 1852.4 MHz

Channel 4132/ 826.4 MHz

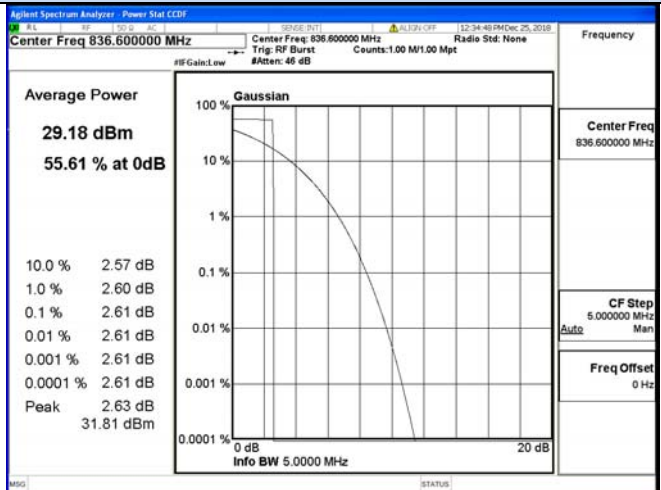
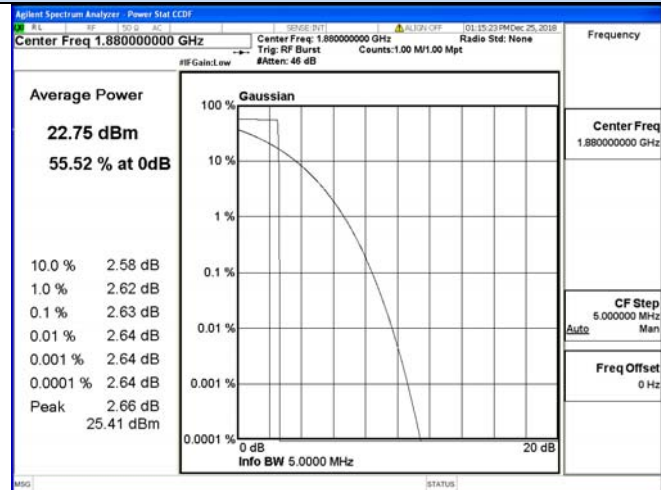

Channel 9400 / 1880.0 MHz

Channel 4182/ 836.4 MHz

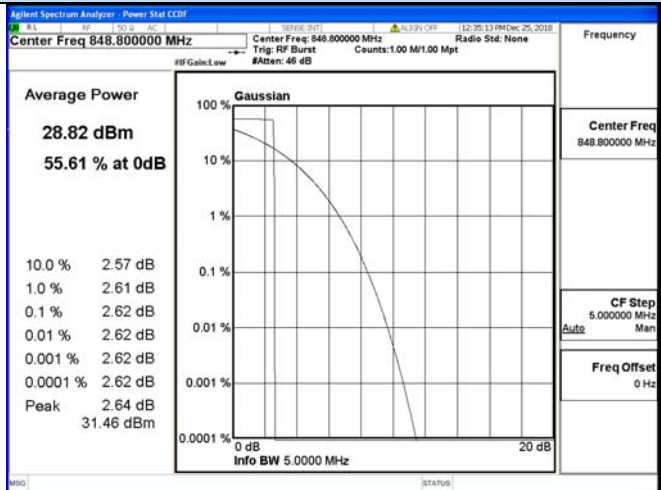
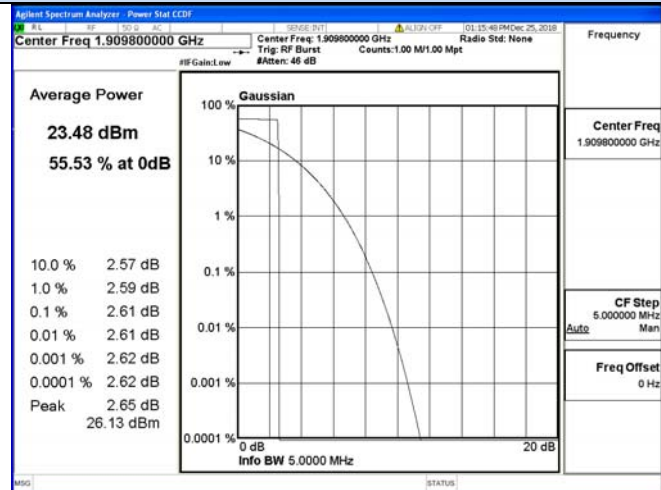

Channel 9538 / 1907.6 MHz

Channel 4233/ 846.6 MHz

5 Test Setup Photos of the EUT

Please refer to separated files for Test Setup Photos of the EUT.

6 External Photos of the EUT

Please refer to separated files for External Photos of the EUT.

7 Internal Photos of the EUT

Please refer to separated files for Internal Photos of the EUT.

.....**End of Report**.....