

# TEST REPORT

**Reference No.**..... : WTS14S1220946-3E  
**FCC ID** ..... : 2ADTE-DG580  
**Applicant**..... : Shenzhen KVD Communication Equipment  
**Address**..... : 13C, Block C, Shenzhen Electronic Technology Building, Shennan Middle Road, Futian District, Shenzhen, China  
**Manufacturer** ..... : The same as above  
**Address**..... : The same as above  
**Product Name**..... : Mobile Phone  
**Model No.**..... : KISSME DG580  
**Brand**..... : DOOGEE  
**Standards**..... : FCC CFR47 Part 22 Subpart H:2014  
FCC CFR47 Part 24 Subpart E:2014  
**Date of Receipt sample** .... : Dec. 6, 2014  
**Date of Test** ..... : Dec. 10, 2014 ~ Dec. 27, 2014  
**Date of Issue**..... : Dec. 27, 2014  
**Test Result**..... : **Pass**

Remarks:

The results shown in this test report refer only to the sample(s) tested, this test report cannot be reproduced, except in full, without prior written permission of the company. The report would be invalid without specific stamp of test institute and the signatures of compiler and approver.

**Prepared By:**

**Waltek Services (Shenzhen) Co., Ltd.**

Address: 1/F., Fukangtai Building, West Baima Road, Songgang Street, Baoan District, Shenzhen, Guangdong, China  
Tel :+86-755-83551033  
Fax:+86-755-83552400

Compiled by:



Zero Zhou / Project Engineer

Approved by:



Philo Zhong / Manager

## 2 Test Summary

Test Items	Test Requirement	Result
RF Output Power	2.1046 22.913 (a) 24.232 (c)	PASS
Peak-to-Average Ratio	24.232 (d)	PASS
Bandwidth	2.1049 22.905 22.917 24.238	PASS
Spurious Emissions at Antenna Terminal	2.1051 22.917 (a) 24.238 (a)	PASS
Field Strength of Spurious Radiation	2.1053 22.917 (a) 24.238 (a)	PASS
Out of band emission, Band Edge	22.917 (a) 24.238 (a)	PASS
Frequency Stability	2.1055 22.355 24.235	PASS
Maximum Permissible Exposure (SAR)	1.1307 2.1093	PASS

### 3 Contents

	<b>Page</b>
<b>1 COVER PAGE.....</b>	<b>1</b>
<b>2 TEST SUMMARY .....</b>	<b>2</b>
<b>3 CONTENTS .....</b>	<b>3</b>
<b>4 GENERAL INFORMATION.....</b>	<b>4</b>
4.1 GENERAL DESCRIPTION OF E.U.T. ....	4
4.2 DETAILS OF E.U.T. ....	4
4.3 TEST MODE .....	5
4.4 TEST FACILITY.....	6
<b>5 EQUIPMENT USED DURING TEST .....</b>	<b>7</b>
5.1 EQUIPMENTS LIST .....	7
5.2 MEASUREMENT UNCERTAINTY .....	8
5.3 TEST EQUIPMENT CALIBRATION .....	8
<b>6 RF OUTPUT POWER .....</b>	<b>9</b>
6.1 EUT OPERATION.....	9
6.2 TEST PROCEDURE .....	9
6.3 TEST RESULT .....	10
<b>7 PEAK-TO-AVERAGE RATIO.....</b>	<b>14</b>
7.1 EUT OPERATION.....	14
7.2 TEST PROCEDURE .....	14
7.3 TEST RESULT .....	15
<b>8 BANDWIDTH.....</b>	<b>17</b>
8.1 EUT OPERATION.....	17
8.2 TEST PROCEDURE .....	17
8.3 TEST RESULT .....	18
<b>9 SPURIOUS EMISSIONS AT ANTENNA TERMINALS .....</b>	<b>26</b>
9.1 EUT OPERATION.....	26
9.2 TEST PROCEDURE .....	26
9.3 TEST RESULT .....	27
<b>10 SPURIOUS RADIATED EMISSIONS.....</b>	<b>33</b>
10.1 EUT OPERATION .....	33
10.2 TEST SETUP .....	33
10.3 SPECTRUM ANALYZER SETUP .....	34
10.4 TEST PROCEDURE.....	35
10.5 SUMMARY OF TEST RESULTS .....	36
<b>11 BAND EDGE MEASUREMENT .....</b>	<b>38</b>
11.1 EUT OPERATION.....	38
11.2 TEST PROCEDURE.....	38
11.3 TEST RESULT .....	39
<b>12 FREQUENCY STABILITY.....</b>	<b>44</b>
12.1 EUT OPERATION.....	44
12.2 TEST PROCEDURE.....	44
12.3 TEST RESULT .....	45
<b>13 RF EXPOSURE.....</b>	<b>49</b>

## 4 General Information

### 4.1 General Description of E.U.T.

Product Name	: Mobile Phone
Model No.	: KISSME DG580
Model Description	: N/A
GSM Band(s)	: GSM 850/900/1800/1900MHz
GPRS/EGPRS Class	: 12
WCDMA Band(s)	: FDD Band I/II/V
Wi-Fi Specification	: 802.11b/g/n HT20/n HT40
Bluetooth Version	: Bluetooth v4.0 with BLE
GPS	: Support
NFC	: N/A
Hardware Version	: 619B-C2
Software Version	: DOOGEE-KISSME-DG580

### 4.2 Details of E.U.T.

Operation Frequency	: GSM/GPRS/EDGE 850: 824~849MHz GSM/GPRS/EDGE 900: 925-960MHz DCS 1800: 1805-1880MHz PCS 1900: 1850~1910MHz WCDMA Band I: 1920-1980MHz WCDMA Band II: 1850-1910MHz WCDMA Band V: 824~849MHz WiFi: 802.11b/g/n HT20: 2412-2462MHz 802.11n HT40: 2422-2452MHz Bluetooth: 2402-2480MHz GPS: 1.57GHz
Max. RF output power	: GSM 850: 32.59dBm PCS1900: 29.75dBm WCDMA Band II: 21.97dBm WCDMA Band V: 22.78dBm WiFi: 9.35dBm Bluetooth: -0.44dBm

Type of Modulation	: GSM,GPRS: GMSK EDGE: 8PSK WCDMA: QPSK WiFi: CCK, OFDM Bluetooth: GFSK, Pi/4 DQPSK,8DPSK
Antenna installation	: GSM/WCDMA: Wire antenna WiFi/Bluetooth: Metal Dome
Antenna Gain	: GSM 850: -4.0dBi PCS1900: -4.0dBi WCDMA Band II: -4.0dBi WCDMA Band V: -4.0dBi WiFi: -1.0dBi Bluetooth: -1.0dBi
Technical Data	: Battery DC 3.7V 2500mAh DC 5V, 1.0A, charging from adapter (Adapter Input: 100-240V~50/60Hz, 0.15A)
Adapter	: Manufacture: Shenzhen KVD Communication Equipment Model No.: TN-050100UZ
Type of Emission	: GSM850: 251KGXW,PCS1900: 249KGXW EDGE850:250KG7W,EDGE1900:250KG7W WCDMA850: 4M19F9W, WCDMA1900: 4M17F9W

#### 4.3 Test Mode

All test mode(s) and condition(s) mentioned were considered and evaluated respectively by performing full tests, the worst data were recorded and reported.

Support Band	Test Mode	Channel Frequency	Channel Number
GSM 850	GSM/GPRS/EDGE	824.2 MHz	128
		836.6 MHz	190
		848.8 MHz	251
PCS 1900	GSM/GPRS/EDGE	1850.2 MHz	512
		1880.0 MHz	661
		1909.8 MHz	810
WCDMA Band V	WCDMA/HSUPA/HSDPA	826.4 MHz	4132
		836.6 MHz	4183
		846.6 MHz	4233
WCDMA Band II	WCDMA/HSUPA/HSDPA	1852.4MHz	9262
		1880.0MHz	9400
		1907.6MHz	9538

Remark: All mode(s) were tested and the worst data was recorded.
--

#### 4.4 Test Facility

The test facility has a test site registered with the following organizations:

- **IC – Registration No.: 7760A**

Waltek Services(Shenzhen) Co., Ltd. Has been registered and fully described in a report filed with the Industry Canada. The acceptance letter from the Industry Canada is maintained in our files. Registration number 7760A, July 12, 2012.

- **FCC Test Site 1#– Registration No.: 880581**

Waltek Services(Shenzhen) Co., Ltd. EMC Laboratory `has been registered and fully described in a report filed with the (FCC) Federal Communications Commission. The acceptance letter from the FCC is maintained in our files. Registration 880581, April 29, 2014.

- **FCC Test Site 2#– Registration No.: 328995**

Waltek Services(Shenzhen) Co., Ltd. EMC Laboratory `has been registered and fully described in a report filed with the (FCC) Federal Communications Commission. The acceptance letter from the FCC is maintained in our files. Registration 328995, December 3, 2014.

## 5 Equipment Used during Test

### 5.1 Equipments List

RF Conducted Test						
Item	Equipment	Manufacturer	Model No.	Serial No.	Last Calibration Date	Calibration Due Date
1.	EMC Analyzer (9k~26.5GHz)	Agilent	E7405A	MY45114943	Aug. 15,2014	Aug. 14,2015
2.	Spectrum Analyzer (9k-6GHz)	R&S	FSL6	100959	Aug. 15,2014	Aug. 14,2015
3.	Humidity Chamber	GF	GTH-225-40-1P	IAA061213	Aug. 15,2014	Aug. 14,2015
4.	Universal Radio Communication Tester	R&S	CMU 200	112461	Apr.11,2014	Apr.10,2015
3m Semi-anechoic Chamber for Radiated Emissions						
Item	Equipment	Manufacturer	Model No.	Serial No.	Last Calibration Date	Calibration Due Date
1	EMC Analyzer	Agilent	E7405A	MY45114943	Sep.15,2014	Sep.14,2015
2	Active Loop Antenna	Beijing Dazhi	ZN30900A	-	Sep.15,2014	Sep.14,2015
3	Trilog Broadband Antenna	SCHWARZBECK	VULB9163	336	Apr.19,2014	Apr.18,2015
4	Coaxial Cable (below 1GHz)	Top	TYPE16(13M)	-	Sep.15,2014	Sep.14,2015
5	Broad-band Horn Antenna	SCHWARZBECK	BBHA 9120 D	667	Apr.19,2014	Apr.18,2015
6	Broad-band Horn Antenna	SCHWARZBECK	BBHA 9120 D	669	Apr.19,2014	Apr.18,2015
7	Broadband Preamplifier	COMPLIANCE DIRECTION	PAP-1G18	2004	Mar.17,2014	Mar.16,2015
8	Coaxial Cable (above 1GHz)	Top	1000MHz- 25GHz	EW02014-7	Apr.10,2014	Apr.09,2015
9	Broad-band Horn Antenna	SCHWARZBECK	BBHA 9170	335	Sep.15,2014	Sep.14,2015
10	Universal Radio Communication Tester	R&S	CMU 200	112461	Apr.11,2014	Apr.10,2015
11	Signal Generator	R&S	SMR20	100046	Sep.15,2014	Sep.14,2015

## 5.2 Measurement Uncertainty

Parameter	Uncertainty
Radio Frequency	$\pm 1 \times 10^{-6}$
RF Power	$\pm 1.0$ dB
RF Power Density	$\pm 2.2$ dB
Radiated Spurious Emissions test	$\pm 5.03$ dB (Bilog antenna 30M~1000MHz)
	$\pm 5.47$ dB (Horn antenna 1000M~25000MHz)
Conducted Spurious Emissions test	$\pm 3.64$ dB (AC mains 150KHz~30MHz)

## 5.3 Test Equipment Calibration

All the test equipments used are valid and calibrated by CEPREI Certification Body that address is No.110 Dongguan Zhuang RD. Guangzhou, P.R.China.



## 6 RF OUTPUT POWER

Test Requirement:	FCC Part 2.1046,22.913 (a),24.232 (c)
Test Method:	ANSI C63.4:2003, TIA/EIA-603-D:2010
Test Mode:	Transmitting

### 6.1 EUT Operation

Operating Environment :

Temperature:	22.5 °C
Humidity:	52.1 % RH
Atmospheric Pressure:	101.2kPa

### 6.2 Test Procedure

Conducted method:

The RF output of the transmitter was connected to the wireless test set and the spectrum analyzer through sufficient attenuation.



Radiated method:

1. The setup of EUT is according with per TIA/EIA Standard 603D:2010 and ANSI C63.4-2003 measurement procedure.
2. The measurement antenna was placed at a distance of 3 meters from the EUT. During the tests, the antenna height and polarization as well as EUT azimuth were varied in order to identify the maximum level of emissions from the EUT. The test was performed by placing the EUT on 3-orthogonal axis.
3. The frequency range up to tenth harmonic of the fundamental frequency was investigated.
4. Remove the EUT and replace it with substitution antenna. A signal generator was connected to the substitution antenna by a non-radiating cable. The absolute levels of the spurious emissions were measured by the substitution.

### 6.3 Test Result

#### Conducted Power

##### Cellular Band (Part 22H)

Test Mode	Channel	Frequency (MHz)	Peak Output Power(dBm)	Limit (dBm)
GSM 850	128	824.2	32.58	38.45
	190	836.6	32.59	38.45
	251	848.8	32.59	38.45

Test Mode	Channel	Frequency (MHz)	Peak Output Power(dBm)				Limit(dBm)
			Slot 1	Slot 2	Slot 3	Slot 4	
GPRS	128	824.2	32.54	31.67	29.79	28.98	38.45
	190	836.6	32.57	31.67	29.79	28.97	38.45
	251	848.8	32.57	31.61	29.77	28.95	38.45

Test Mode	Channel	Frequency (MHz)	Peak Output Power(dBm)				Limit(dBm)
			Slot 1	Slot 2	Slot 3	Slot 4	
EDGE	128	824.2	28.73	27.83	25.89	24.89	38.45
	190	836.6	28.70	27.80	25.83	24.83	38.45
	251	848.8	28.57	27.65	25.68	24.67	38.45

Test Mode	Channel	Frequency (MHz)	Peak Output Power(dBm)					Limit (dBm)
			RMC12.2k	HSDPA1	HSDPA2	HSDPA3	HSDPA4	
WCDMA Band V	4132	826.4	22.78	21.62	21.63	21.57	21.49	38.45
	4183	836.6	22.61	21.53	21.54	21.60	21.47	38.45
	4233	846.6	22.53	21.36	21.34	21.25	21.37	38.45

Test Mode	Channel	Frequency (MHz)	Peak Output Power(dBm)					Limit (dBm)
			HSUPA1	HSUPA2	HSUPA3	HSUPA4	HSUPA5	
WCDMA Band V	4132	826.4	21.69	21.68	21.54	21.47	21.66	38.45
	4183	836.6	21.52	21.53	21.48	21.55	21.49	38.45
	4233	846.6	21.39	21.42	21.37	21.36	21.38	38.45

## Cellular Band (Part 24E)

Test Mode	Channel	Frequency (MHz)	Peak Output Power(dBm)	Limit (dBm)
PCS 1900	512	1850.2	29.57	33
	661	1880.0	29.75	33
	810	1909.8	29.68	33

Test Mode	Channel	Frequency (MHz)	Peak Output Power(dBm)				Limit(dBm)
			Slot 1	Slot 2	Slot 3	Slot 4	
GPRS	512	1850.2	29.58	28.54	26.80	25.96	33
	661	1880.0	29.74	28.73	26.97	26.16	33
	810	1909.8	29.67	28.68	26.91	26.11	33

Test Mode	Channel	Frequency (MHz)	Peak Output Power(dBm)				Limit(dBm)
			Slot 1	Slot 2	Slot 3	Slot 4	
EDGE	512	1850.2	25.91	25.04	23.19	22.04	33
	661	1880.0	26.23	25.35	23.52	22.42	33
	810	1909.8	26.25	25.39	23.54	22.39	33

Test Mode	Channel	Frequency (MHz)	Peak Output Power(dBm)					Limit (dBm)
			RMC12.2k	HSDPA1	HSDPA2	HSDPA3	HSDPA4	
WCDMA Band II	9262	1852.4	21.67	20.57	20.53	20.49	20.55	33
	9400	1880.0	21.97	20.94	20.88	20.74	20.86	33
	9538	1907.6	21.93	20.82	20.81	20.77	20.86	33

Test Mode	Channel	Frequency (MHz)	Peak Output Power(dBm)					Limit (dBm)
			HSUPA1	HSUPA2	HSUPA3	HSUPA4	HSUPA5	
WCDMA Band II	9262	1852.4	20.62	20.59	20.45	20.63	20.51	33
	9400	1880.0	20.90	20.88	20.73	20.86	20.92	33
	9538	1907.6	20.84	20.81	20.83	20.74	20.86	33

**Radiated Power(Measured at max. conducted power channel)**

ERP and EIRP

Cellular Band (Part 22H)

Frequency	Receiver Reading	Turn table Angle	RX Antenna		Substituted			Absolute Level	Part 22H Part 24E	
			Height	Polar	SG Level	Cable	Antenna Gain		Limit	Margin
(MHz)	(dBμV)	Degree	(m)	(H/V)	(dBm)	(dB)	(dB)	(dBm)	(dBm)	(dB)
GSM 850 Channel 190										
836.6	128.33	31	1.1	H	29.7	0.20	0.00	29.50	38.45	-8.95
836.6	119.52	214	1.1	V	19.9	0.20	0.00	19.69	38.45	-18.76
GPRS Channel 190										
836.6	128.74	125	1.2	H	30.1	0.20	0.00	29.91	38.45	-8.54
836.6	119.28	279	1.1	V	19.7	0.20	0.00	19.45	38.45	-19.00
EDGE Channel 190										
836.6	127.15	205	1.4	H	28.5	0.20	0.00	28.32	38.45	-10.13
836.6	116.65	87	1.1	V	17.0	0.20	0.00	16.82	38.45	-21.63

Frequency	Receiver Reading	Turn table Angle	RX Antenna		Substituted			Absolute Level	Part 22H Part 24E	
			Height	Polar	SG Level	Cable	Antenna Gain		Limit	Margin
(MHz)	(dBμV)	Degree	(m)	(H/V)	(dBm)	(dB)	(dB)	(dBm)	(dBm)	(dB)
WCDMA Band V Channel 4183										
836.6	118.45	5	1.7	H	19.8	0.20	0.00	19.62	38.45	-18.83
836.6	110.65	237	1.4	V	11.0	0.20	0.00	10.82	38.45	-27.63
WCDMA Band V HSDPA Channel 4183										
836.6	118.67	241	1.4	H	20.0	0.20	0.00	19.84	38.45	-18.61
836.6	110.63	311	1.9	V	11.0	0.20	0.00	10.80	38.45	-27.65
WCDMA Band V HSUPA Channel 4183										
836.6	118.36	316	1.8	H	19.7	0.20	0.00	19.53	38.45	-18.92
836.6	110.29	91	1.5	V	10.7	0.20	0.00	10.46	38.45	-27.99

## Cellular Band (Part 24E)

Frequency	Receiver Reading	Turn table Angle	RX Antenna		Substituted			Absolute Level	Part 22H Part 24E	
			Height	Polar	SG Level	Cable	Antenna Gain		Limit	Margin
(MHz)	(dB $\mu$ V)	Degree	(m)	(H/V)	(dBm)	(dB)	(dB)	(dBm)	(dBm)	(dB)
PCS 1900 Channel 512										
1880.0	123.35	360	1.7	H	17.7	2.72	12.63	27.63	33	-5.37
1880.0	115.25	301	1.8	V	8.4	2.72	12.63	18.35	33	-14.65
GPRS Channel 512										
1880.0	123.65	142	1.8	H	18.0	2.72	12.63	27.93	33	-5.07
1880.0	114.29	23	1.7	V	7.5	2.72	12.63	17.39	33	-15.61
EDGE Channel 512										
1880.0	122.24	109	1.0	H	16.6	2.72	12.63	26.52	33	-6.48
1880.0	114.68	9	1.3	V	7.9	2.72	12.63	17.78	33	-15.22

Frequency	Receiver Reading	Turn table Angle	RX Antenna		Substituted			Absolute Level	Part 22H Part 24E	
			Height	Polar	SG Level	Cable	Antenna Gain		Limit	Margin
(MHz)	(dB $\mu$ V)	Degree	(m)	(H/V)	(dBm)	(dB)	(dB)	(dBm)	(dBm)	(dB)
WCDMA Band II Channel 9400										
1880.0	115.67	350	1.4	H	10.0	2.72	12.63	19.95	33	-13.05
1880.0	109.57	250	1.1	V	2.8	2.72	12.63	12.67	33	-20.33
WCDMA Band II HSDPA Channel 9400										
1880.0	115.63	215	1.9	H	10.0	2.72	12.63	19.91	33	-13.09
1880.0	109.87	319	1.2	V	3.1	2.72	12.63	12.97	33	-20.03
WCDMA Band II HSUPA Channel 9400										
1880.0	115.86	58	1.6	H	10.2	2.72	12.63	20.14	33	-12.86
1880.0	109.37	239	1.5	V	2.6	2.72	12.63	12.47	33	-20.53

## 7 Peak-to-Average Ratio

Test Requirement:	24.232 (d)
Test Method:	N/A
Test Mode:	Transmitting

### 7.1 EUT Operation

Operating Environment :

Temperature:	22.5 °C
Humidity:	52.3% RH
Atmospheric Pressure:	101.2kPa

### 7.2 Test Procedure

1. The EUT was connected to spectrum analyzer and system simulator via a power divider.
2. Set EUT to transmit at maximum output power.
3. When the duty cycle is less than 98%, then signal gating will be implemented on the spectrum analyzer by triggering from the system simulator.
4. Set the CCDF (Complementary Cumulative Distribution Function) option of the spectrum analyzer. Record the maximum PAPR level associated with a probability of 0.1%.

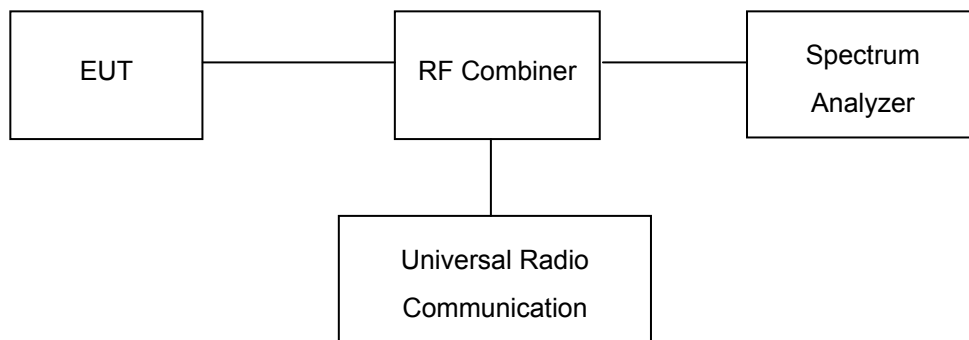

### 7.3 Test Result

Cellular Band (Part 24E)

Mode	PCS 1900			EDGE			WCDMA Band II		
	Channel	512	661	810	512	661	810	9262	9400
Frequency (MHz)	1850.2	1880.0	1909.8	1850.2	1880.0	1909.8	1852.4	1880.0	1907.6
Peak-to-Average Ratio (dB)	9.62	9.43	9.51	9.42	9.17	9.72	1.35	1.22	1.18

Test Plots (Part 24E)

PCS1900 Middle Channel

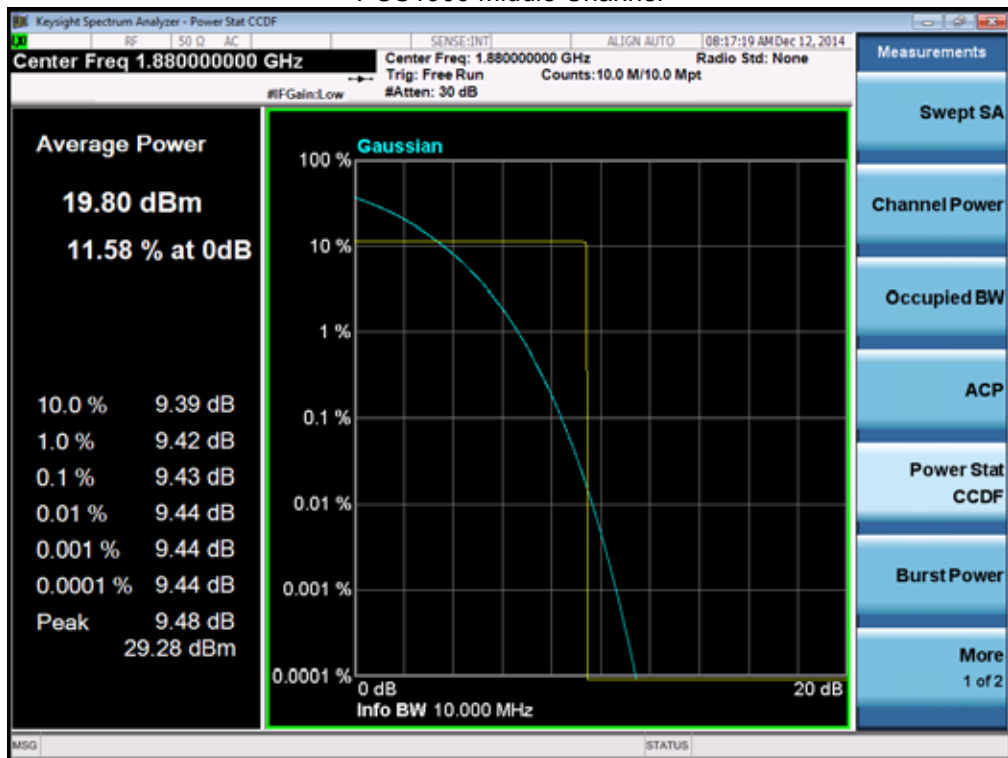

EDGE1900 Middle Channel

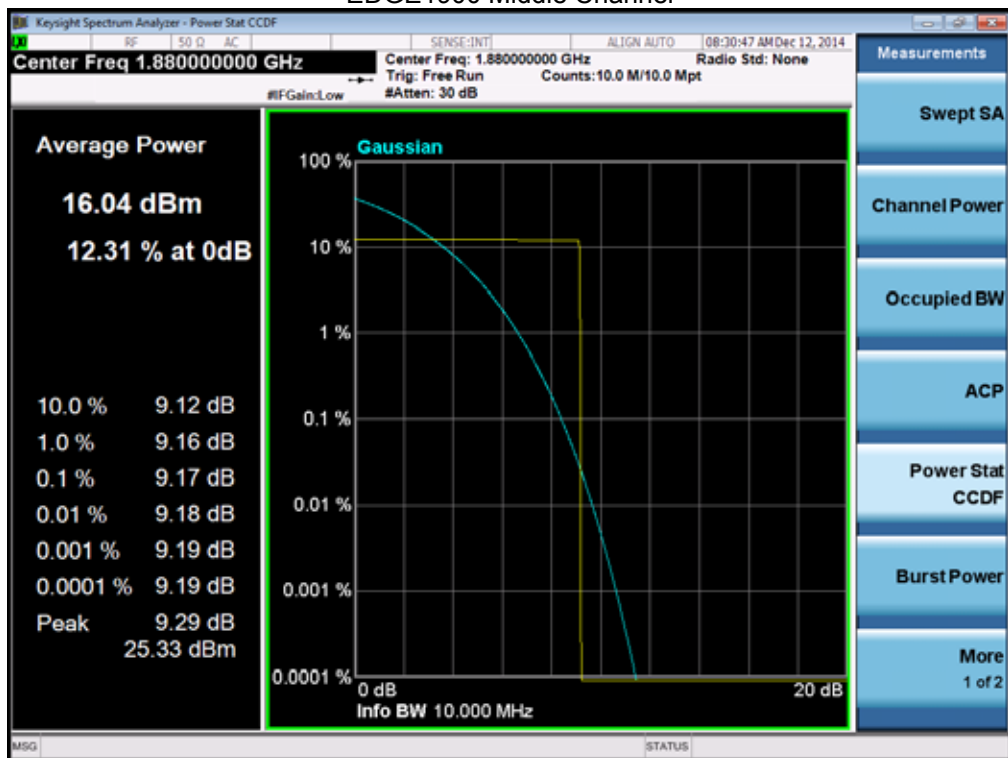

WCDMA Band II Middle Channel

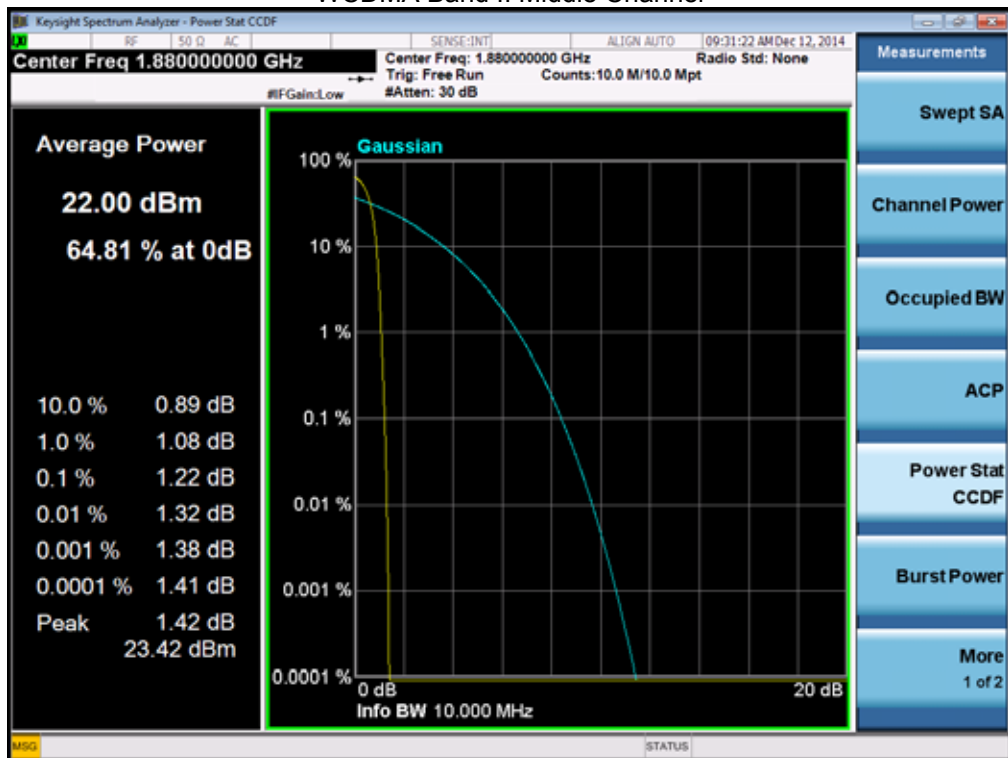



## 8 BANDWIDTH

Test Requirement:	FCC Part 2.1049,22.917,22.905,24.238
Test Method:	ANSI C63.4:2003, TIA/EIA-603-D:2010
Test Mode:	Transmitting

### 8.1 EUT Operation

Operating Environment :

Temperature:	22.5 °C
Humidity:	52.3% RH
Atmospheric Pressure:	101.2kPa

### 8.2 Test Procedure

The RF output of the transmitter was connected to the wireless test set and the spectrum analyzer through sufficient attenuation.

The resolution bandwidth of the spectrum analyzer was set at 3 kHz (Cellular /PCS) and the 26 dB & 99%bandwidth was recorded.

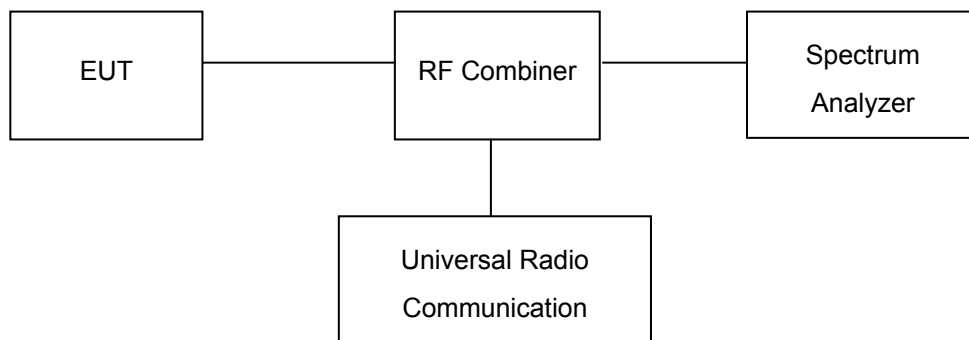

### 8.3 Test Result

Cellular Band (Part 22H)

Test Mode	Channel	Frequency (MHz)	99% Occupied Bandwidth(kHz)	26 dB Emission Bandwidth(kHz)
GSM 850	128	824.20	246.98	315.01
	190	836.60	246.13	314.40
	251	848.80	245.66	313.89
GPRS	128	824.20	250.58	319.92
	190	836.60	249.71	318.70
	251	848.80	249.40	320.04
EDGE	128	824.20	250.10	319.49
	190	836.60	248.52	318.20
	251	848.80	249.94	319.56

Test Mode	Channel	Frequency (MHz)	99% Occupied Bandwidth(MHz)	26 dB Emission Bandwidth(MHz)	
WCDMA Band V	RMC12.2k	4132	826.40	4.16	4.69
		4183	836.60	4.17	4.72
		4233	846.60	4.12	4.70
	HSDPA(16QAM)	4132	826.40	4.09	4.67
		4183	836.60	4.17	4.73
		4233	846.60	4.17	4.64
	HSUPA(BPSK)	4132	826.40	4.15	4.64
		4183	836.60	4.19	4.73
		4233	846.60	4.11	4.72

Cellular Band (Part 24E)

Test Mode	Channel	Frequency (MHz)	99% Occupied Bandwidth(kHz)	26 dB Emission Bandwidth(kHz)
PCS 1900	512	1850.20	249.23	312.42
	661	1880.00	248.02	312.60
	810	1909.80	248.78	314.05
GPRS	512	1850.20	246.96	310.72
	661	1880.00	245.55	310.30
	810	1909.80	244.68	310.36
EDGE	512	1850.20	250.41	315.59
	661	1880.00	249.82	313.90
	810	1909.80	249.54	315.60

Test Mode	Channel	Frequency (MHz)	99% Occupied Bandwidth(MHz)	26 dB Emission Bandwidth(MHz)	
WCDMA Band II	RMC12.2k	9262	1852.40	4.10	4.62
		9400	1880.00	4.16	4.68
		9538	1907.60	4.09	4.64
	HSDPA(16QAM)	9262	1852.40	4.15	4.58
		9400	1880.00	4.16	4.66
		9538	1907.60	4.11	4.57
	HSUPA(BPSK)	9262	1852.40	4.12	4.57
		9400	1880.00	4.17	4.65
		9538	1907.60	4.13	4.60

Test Plots  
 Cellular Band (Part 22H)  
 GSM 850

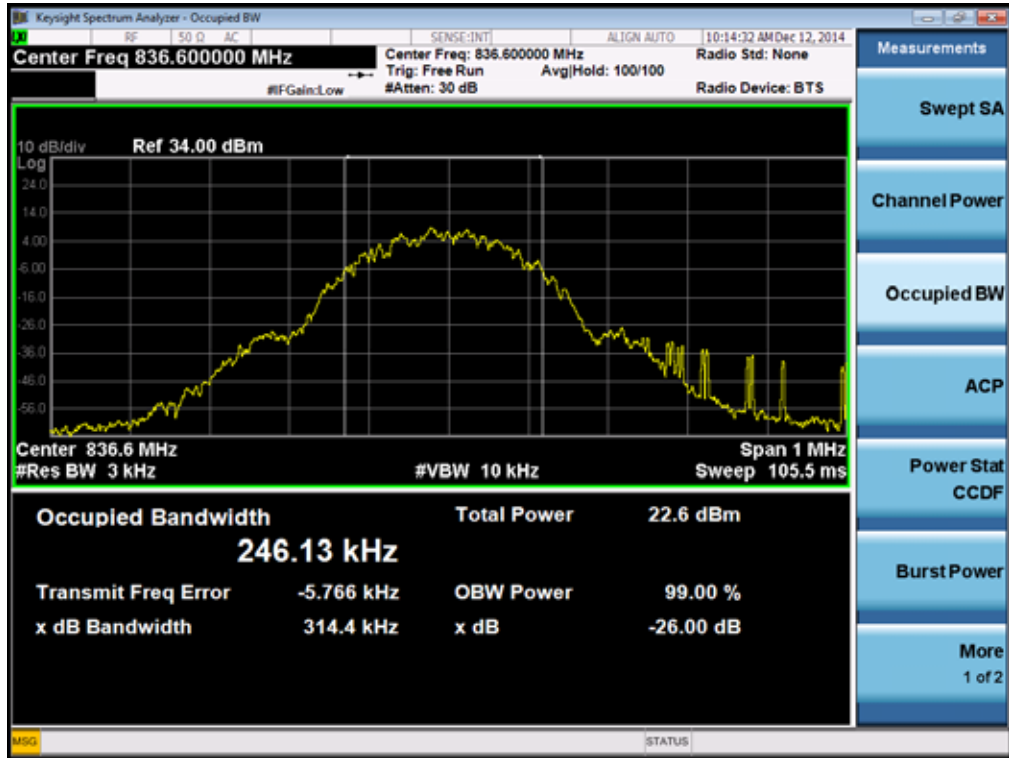

GPRS

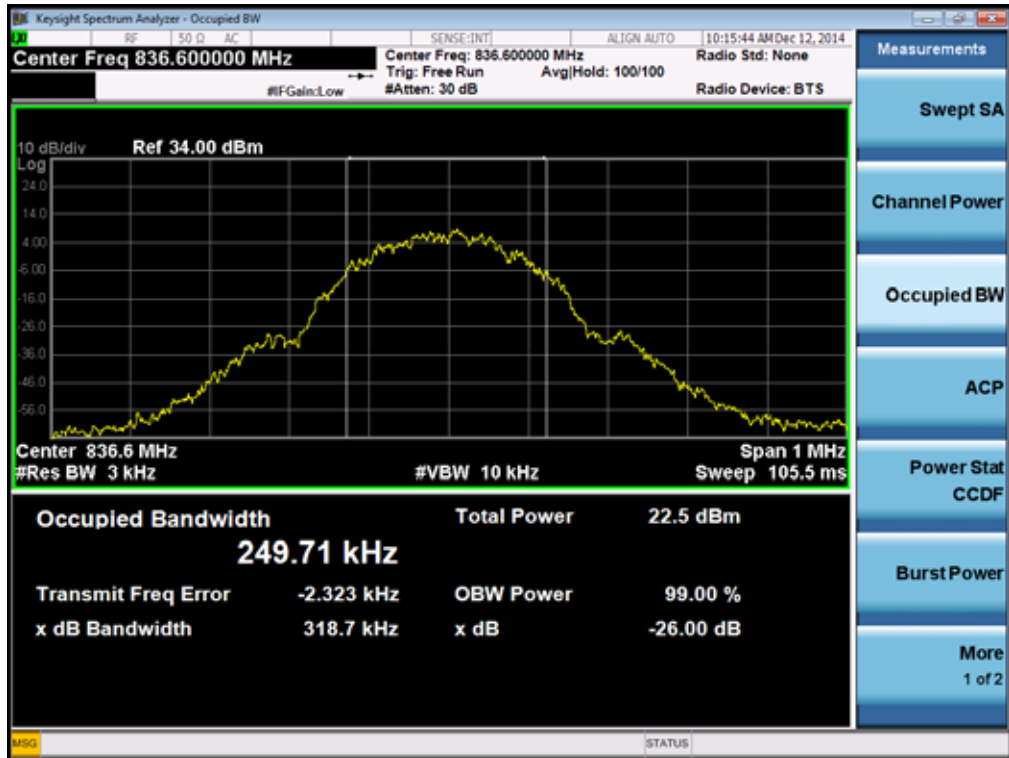

EDGE

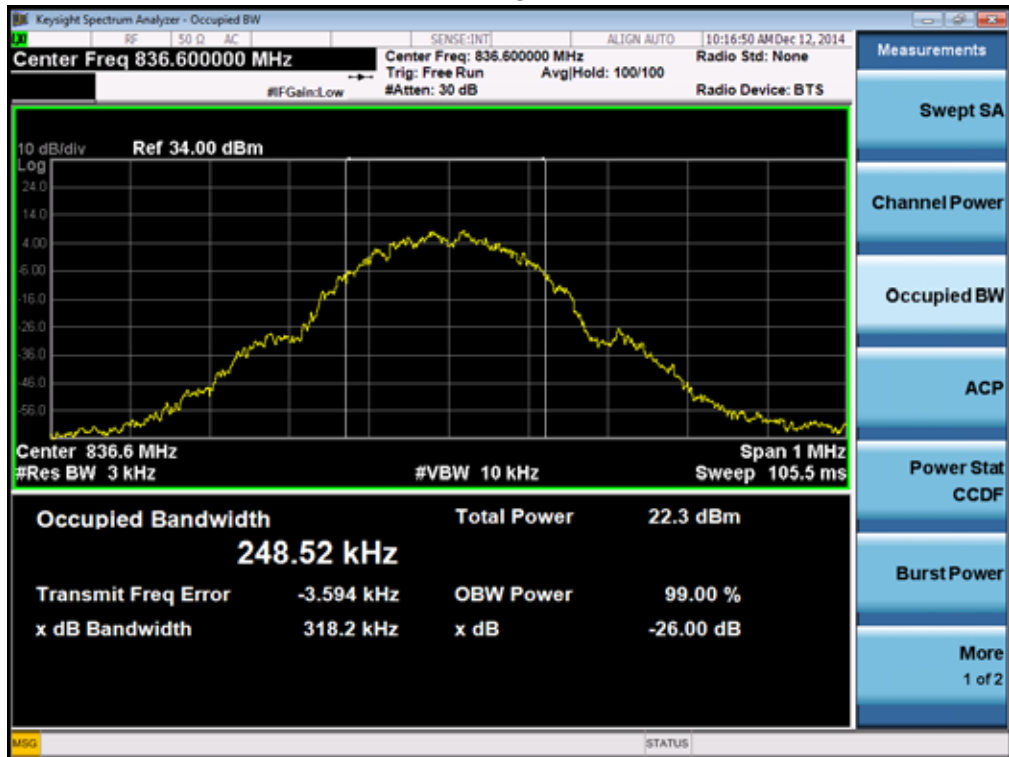

WCDMA band V

RMC12.2k

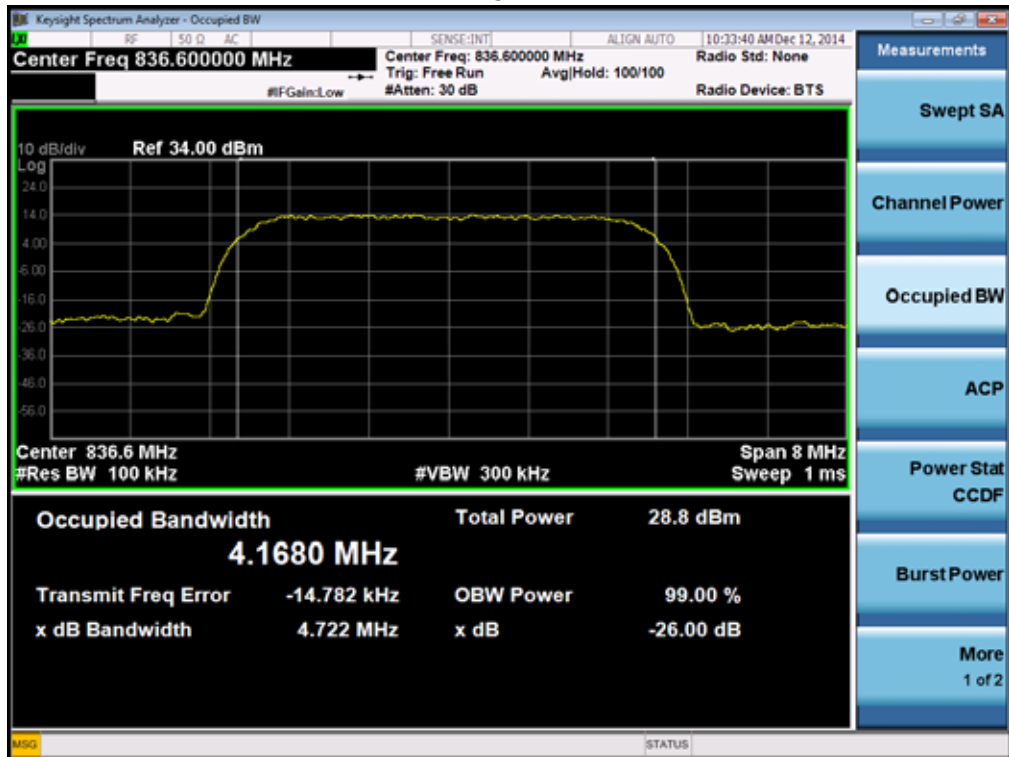

HSDPA

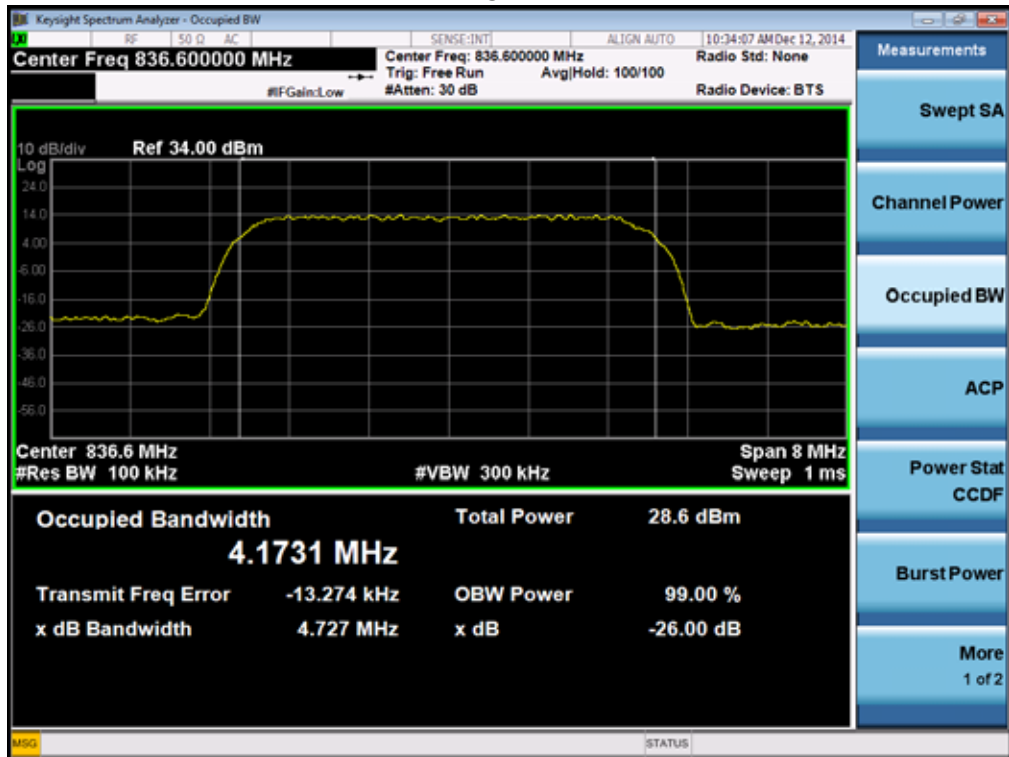

HSUPA

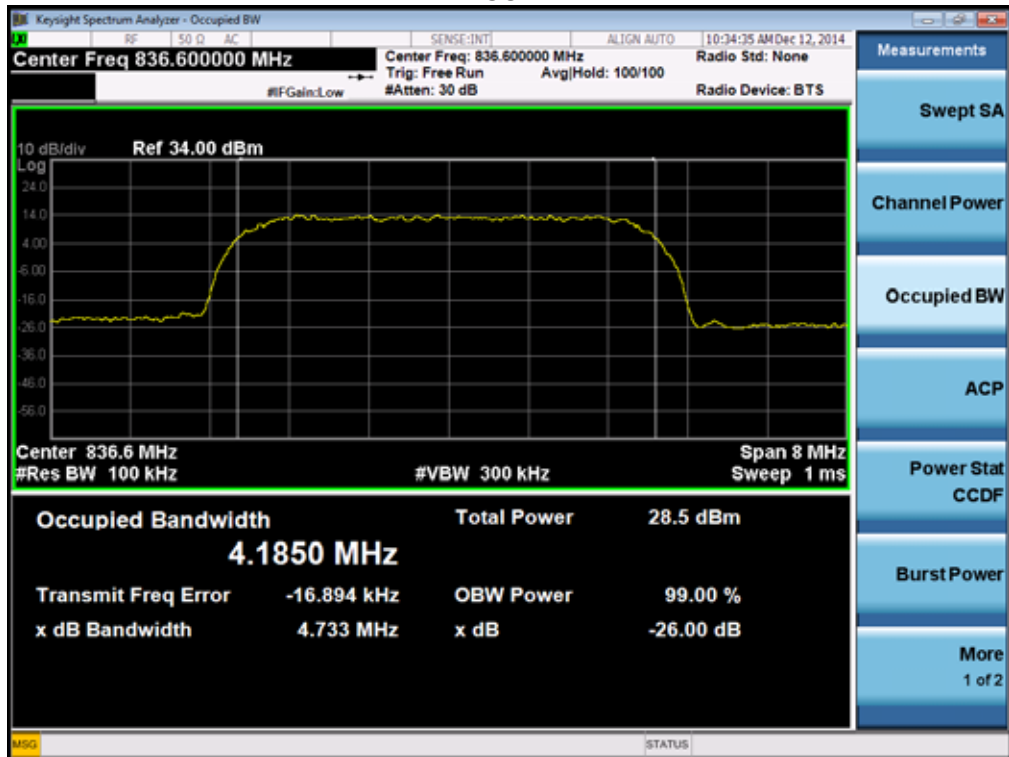

Cellular Band (Part 24E)

PCS 1900



GPRS

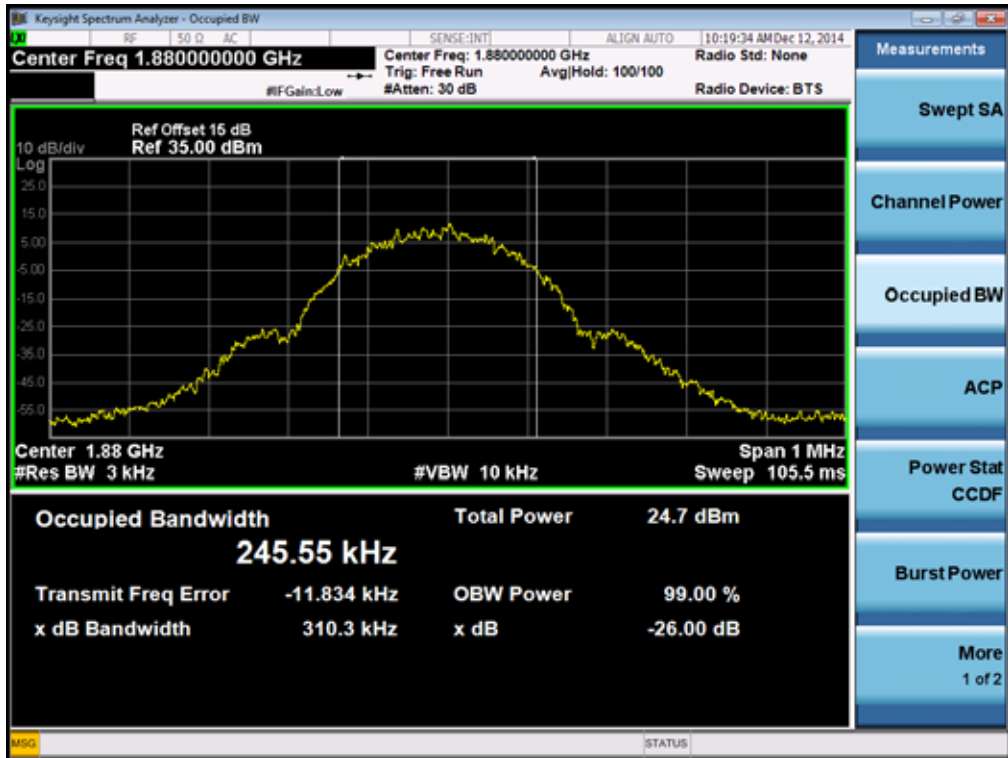

EDGE

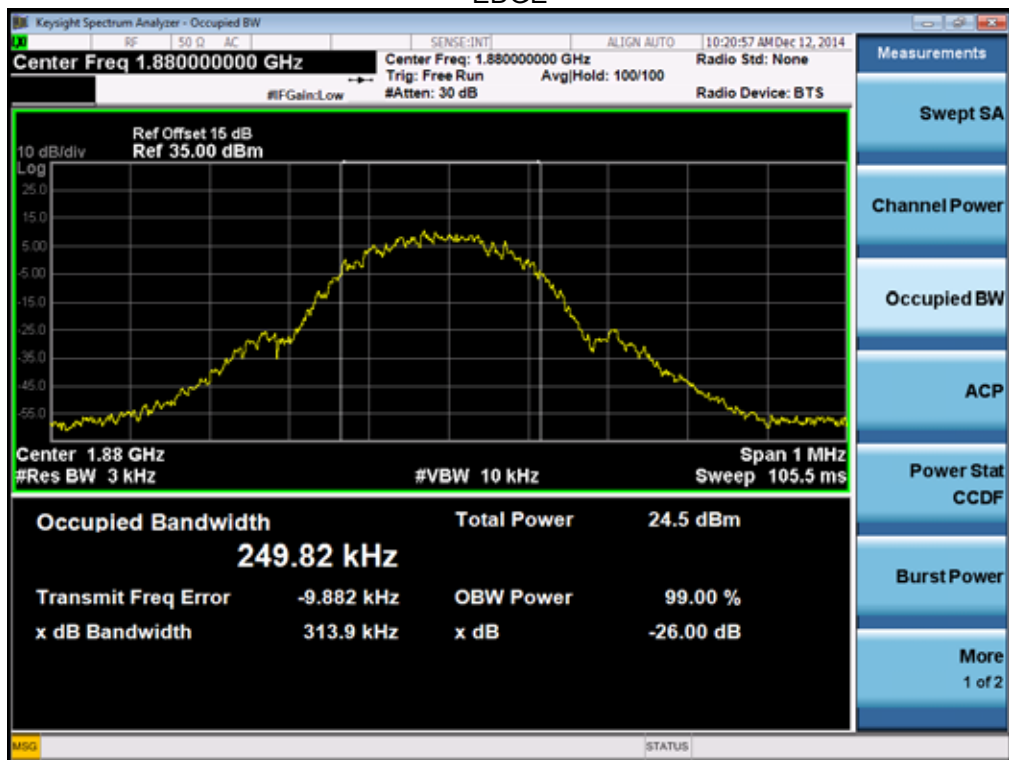

WCDMA band II

RMC12.2k

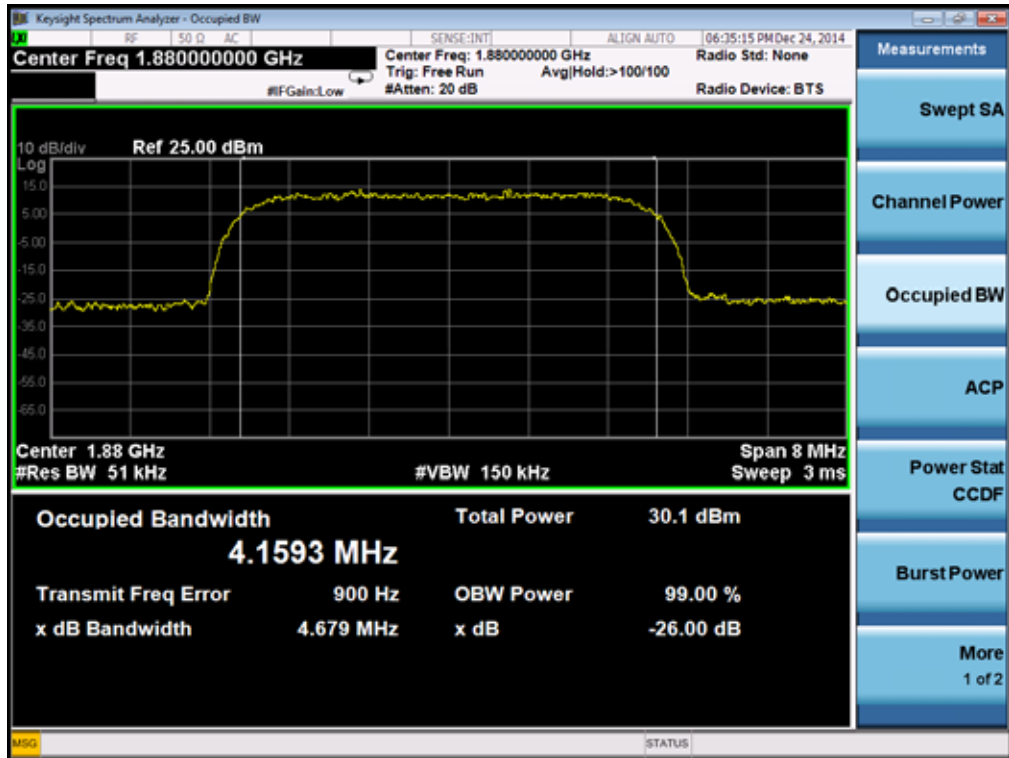



HSDPA

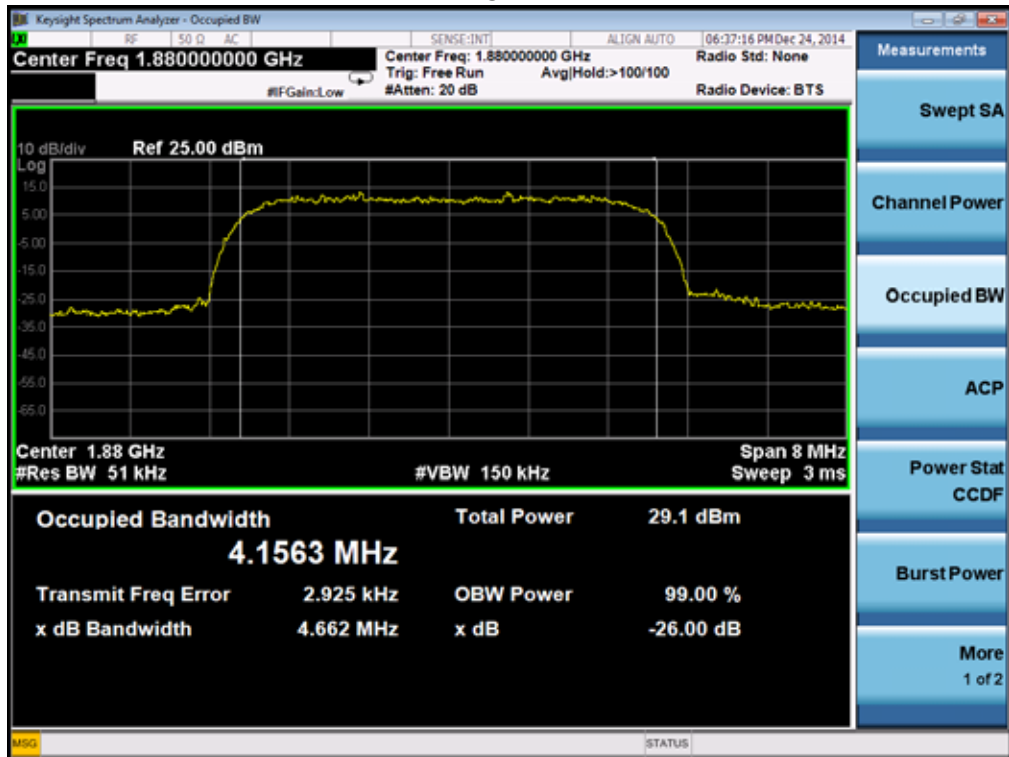

HSUPA

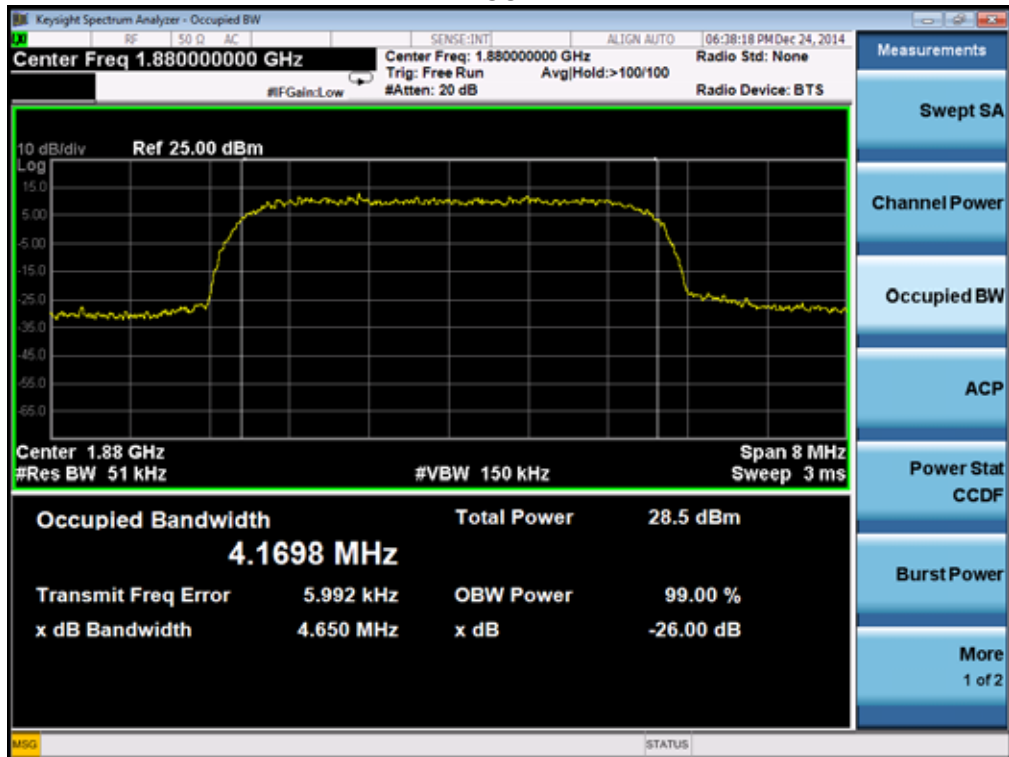

## 9 SPURIOUS EMISSIONS AT ANTENNA TERMINALS

Test Requirement:	FCC Part 2.1051,22.917(a),24.238(a)
Test Method:	ANSI C63.4:2003, TIA/EIA-603-D:2010
Test Mode:	Transmitting

### 9.1 EUT Operation

Operating Environment :

Temperature:	23.5 °C
Humidity:	52.1 % RH
Atmospheric Pressure:	101.3kPa

### 9.2 Test Procedure

The RF output of the transceiver was connected to a spectrum analyzer and simulator through appropriate attenuation. The resolution bandwidth of the spectrum analyzer was set at 1MHz. Sufficient scans were taken to show any out of band emissions up to 10th harmonics.

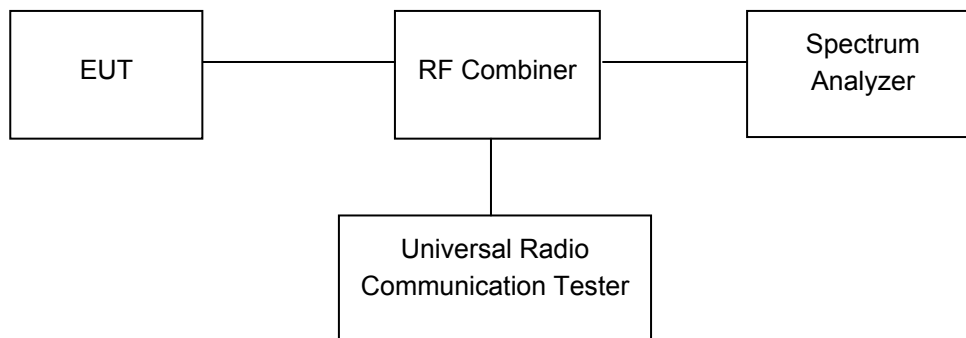

### 9.3 Test Result

Remark: only the worst data were recorded.

Cellular Band (Part 22H)

GSM 850

30MHz-1GHz

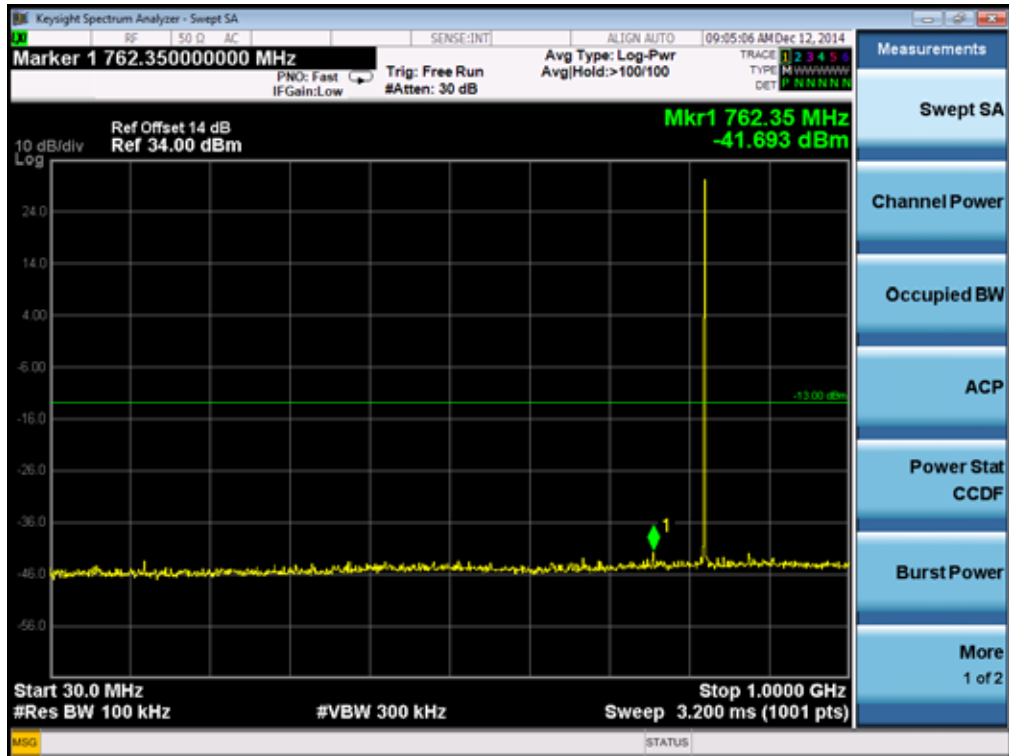

Above 1GHz



EDGE 850

30MHz-1GHz

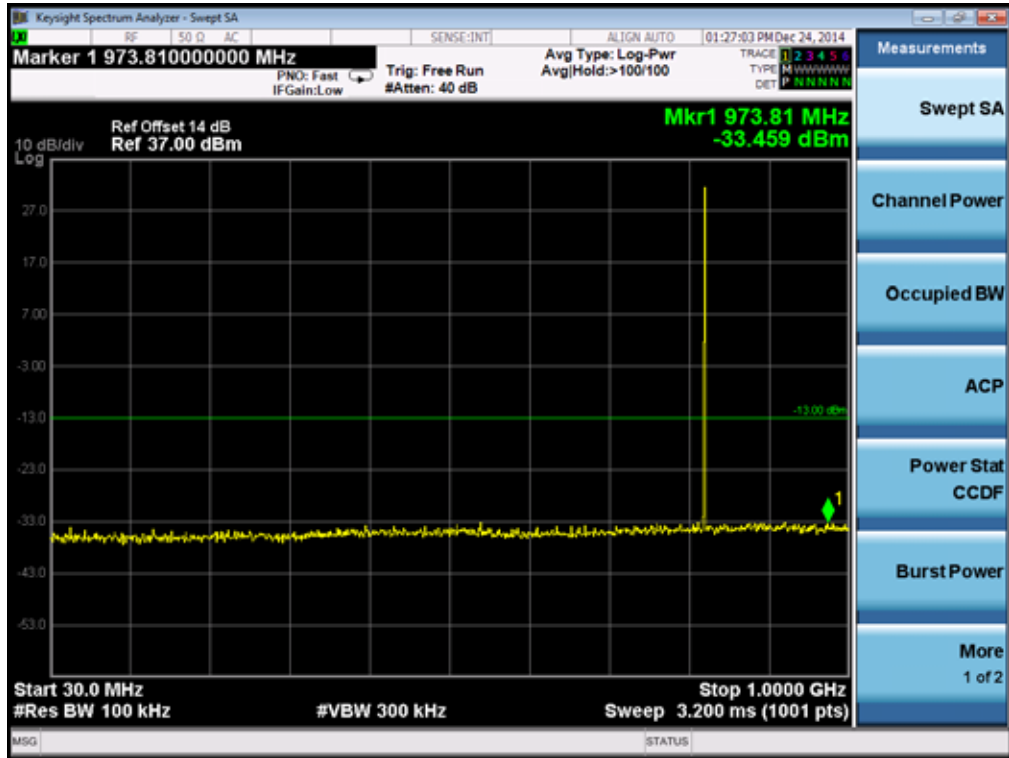

Above 1GHz



WCDMA band V  
30MHz-1GHz

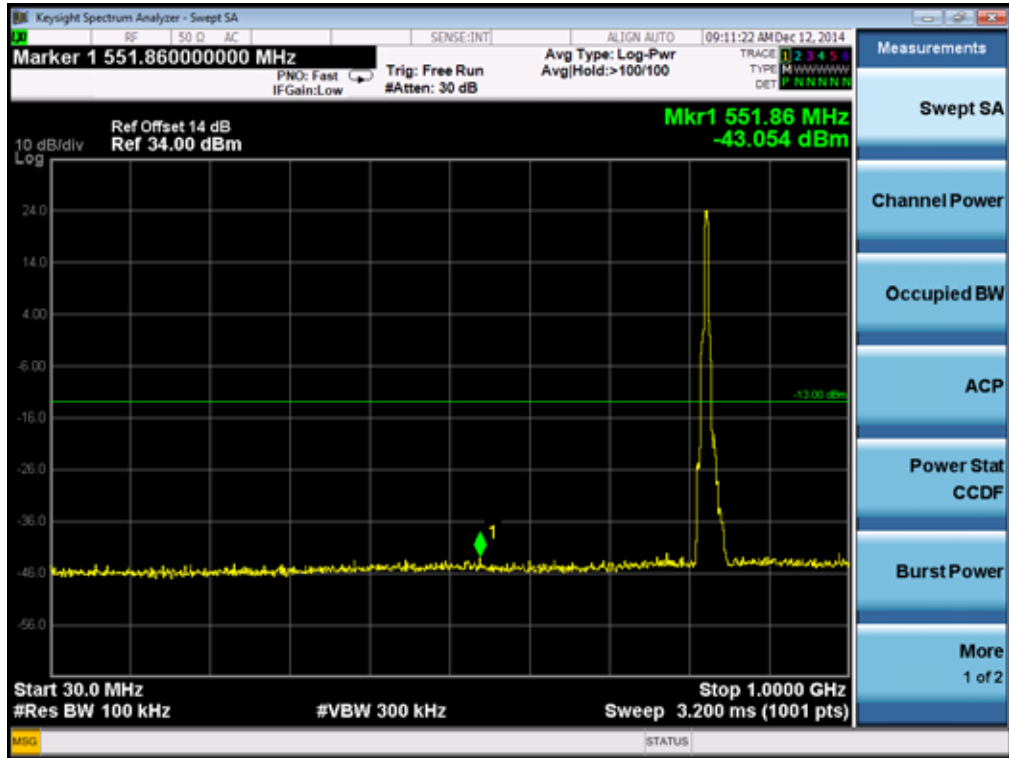

Above 1GHz

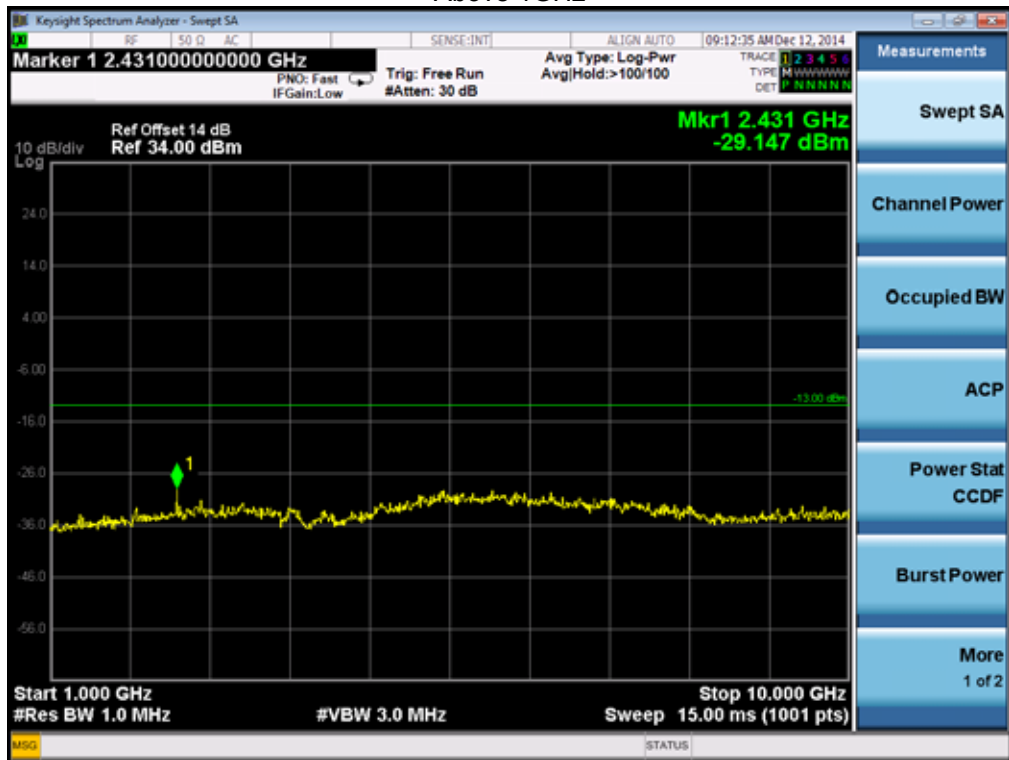

Cellular Band (Part 24E)  
PCS 1900  
30MHz-1GHz

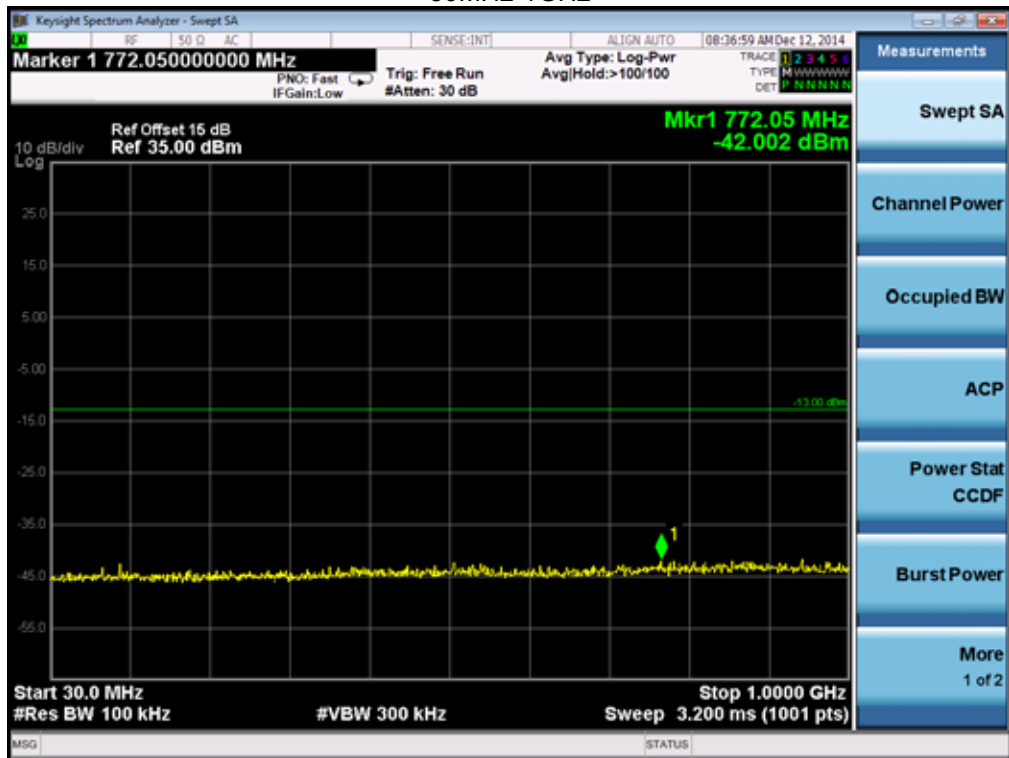

Above 1GHz



EDGE 1900

30MHz-1GHz

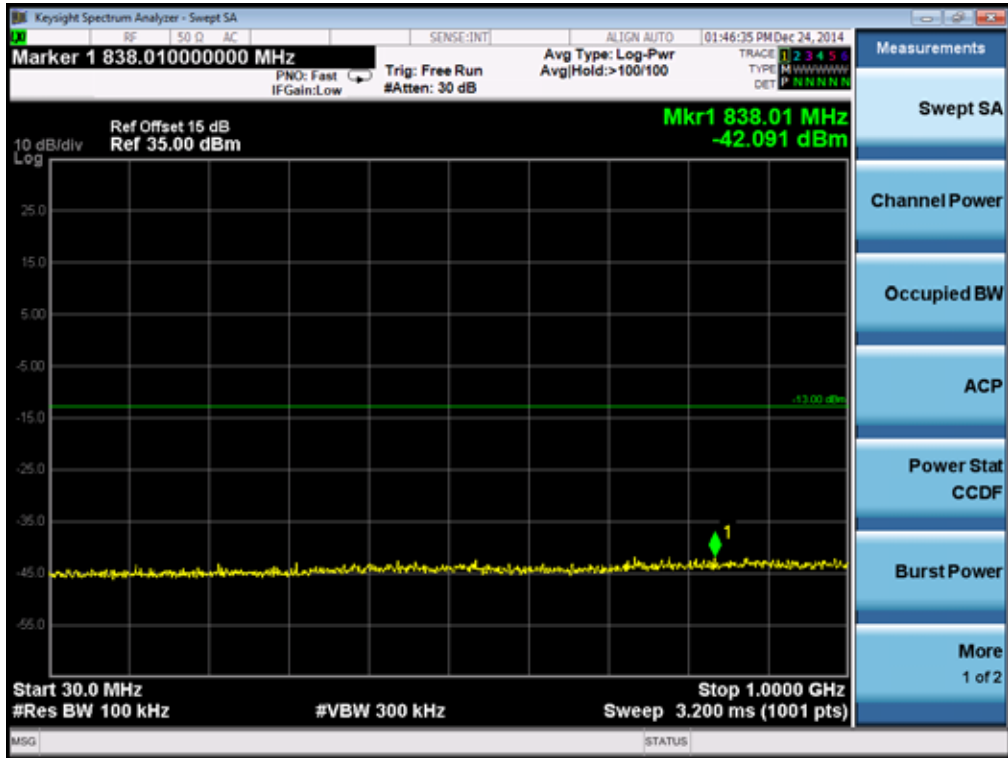

Above 1GHz



WCDMA band II  
30MHz-1GHz

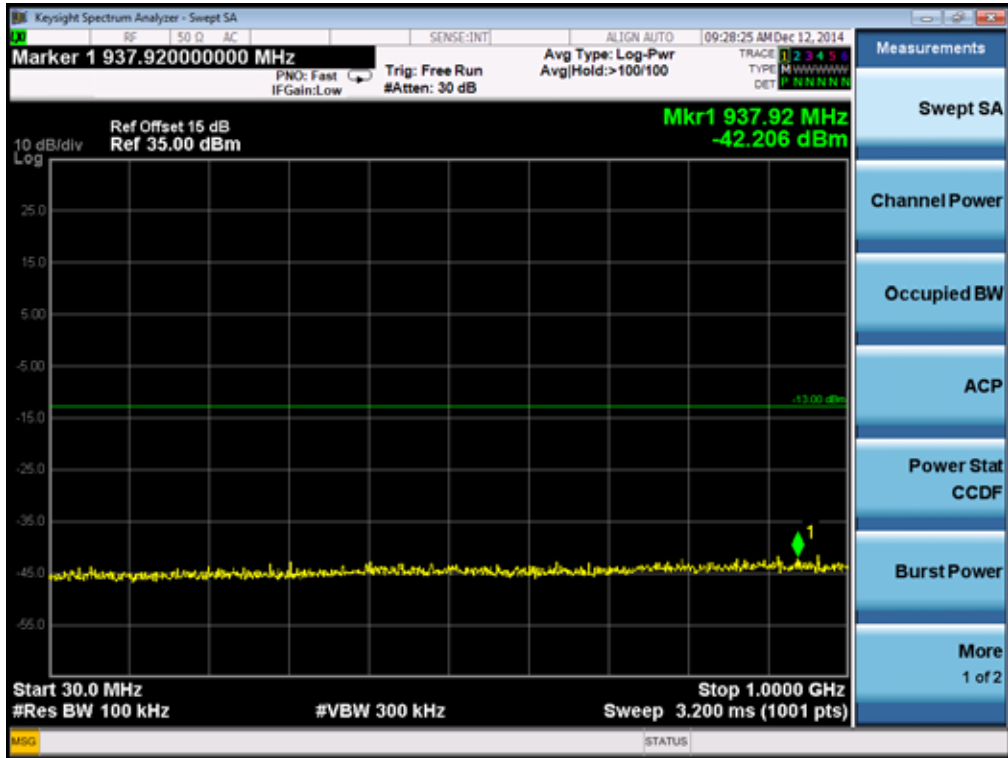

Above 1GHz





## 10 SPURIOUS RADIATED EMISSIONS

Test Requirement:	FCC Part 2.1053,22.917,24.238.
Test Method:	ANSI C63.4:2003, TIA/EIA-603-D:2010
Test Mode:	Transmitting

### 10.1 EUT Operation

Operating Environment :	
Temperature:	23.5 °C
Humidity:	52.1 % RH
Atmospheric Pressure:	101.2kPa

### 10.2 Test Setup

The radiated emission tests were performed in the 3m Semi- Anechoic Chamber test site, using the setup accordance with the ANSI C63.4: 2003.  
The test setup for emission measurement from 30 MHz to 1 GHz.

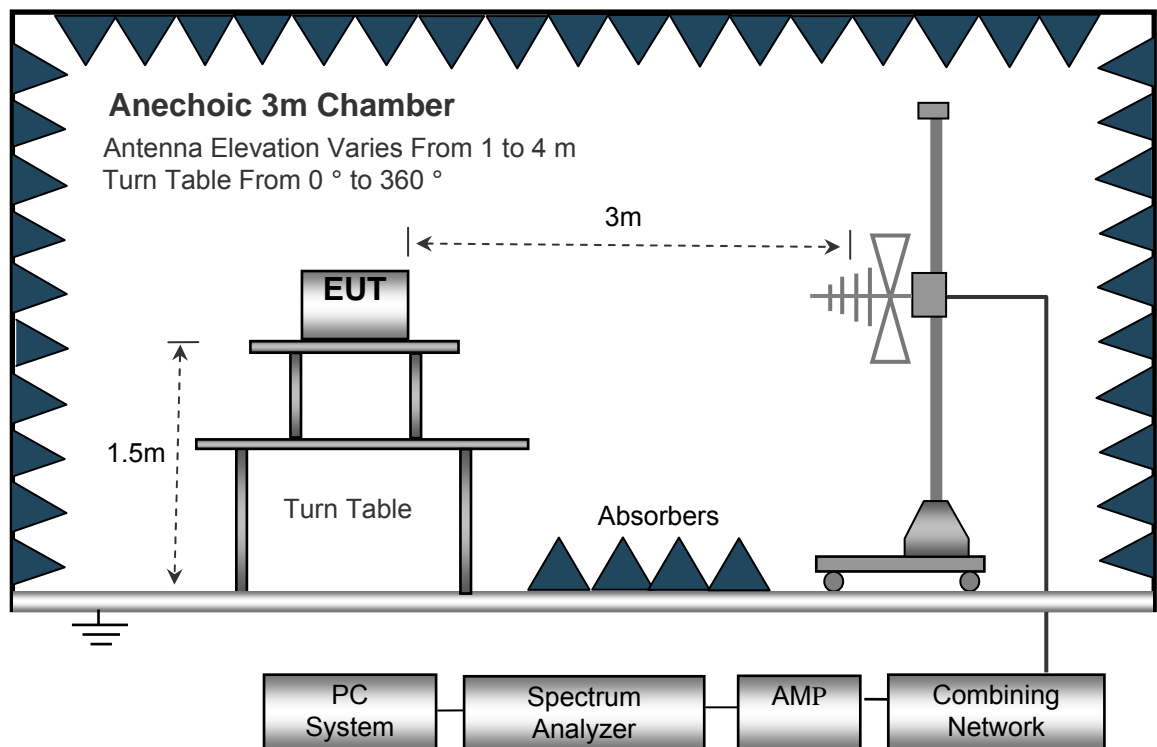

The test setup for emission measurement above 1 GHz.

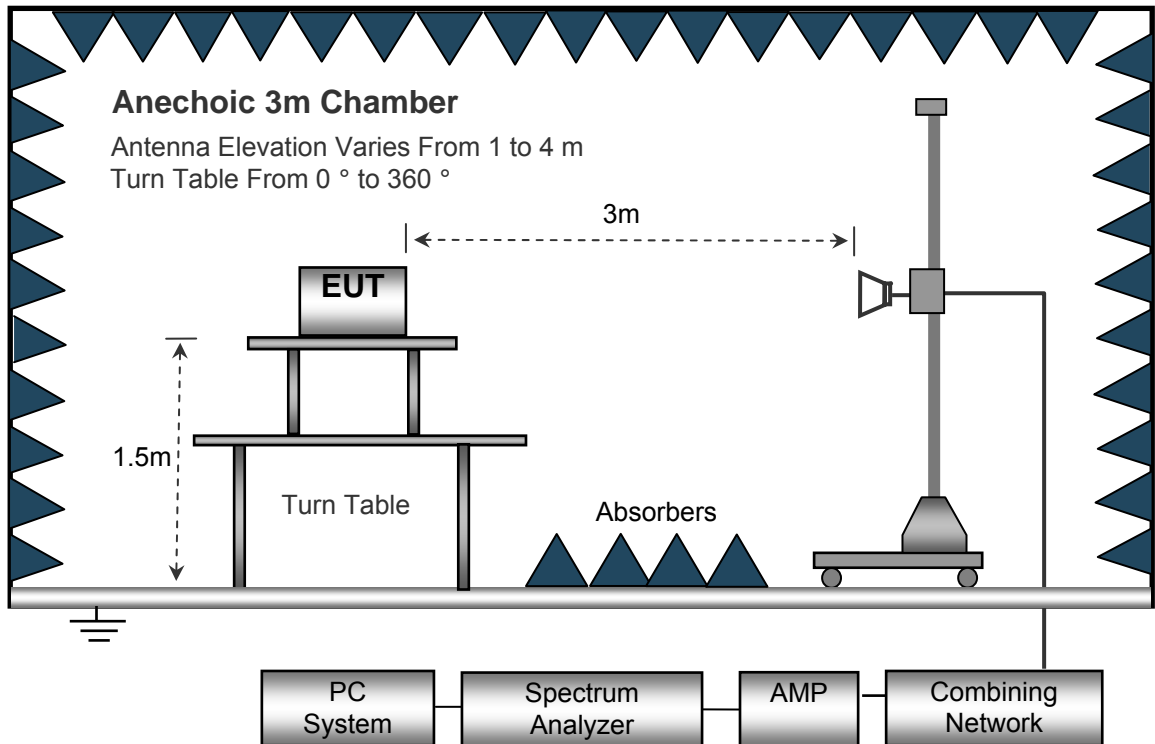

### 10.3 Spectrum Analyzer Setup

30MHz ~ 1GHz

Sweep Speed ..... Auto  
 Detector ..... PK  
 Resolution Bandwidth..... 100kHz  
 Video Bandwidth..... 300kHz

Above 1GHz

Sweep Speed ..... Auto  
 Detector ..... PK  
 Resolution Bandwidth..... 1MHz  
 Video Bandwidth..... 3MHz  
 Detector ..... Ave.  
 Resolution Bandwidth..... 1MHz  
 Video Bandwidth..... 10Hz

## 10.4 Test Procedure

1. The EUT is placed on a turntable, which is 1.5m above ground plane.
2. The turntable shall be rotated for 360 degrees to determine the position of maximum emission level.
3. EUT is set 3m away from the receiving antenna, which is moved from 1m to 4m to find out the maximum emissions. The spectrum was investigated from 30MHz up to the tenth harmonic of the highest fundamental frequency.
4. Maximum procedure was performed on the six highest emissions to ensure EUT compliance.
5. And also, each emission was to be maximized by changing the polarization of receiving antenna both horizontal and vertical.
6. The radiation measurements are tested under 3-axes(X,Y,Z) position(X denotes lying on the table, Y denotes side stand and Z denotes vertical stand), After pre-test, It was found that the worse radiation emission was get at the X position. So the data shown was the X position only.
7. Remove the EUT and replace it with substitution antenna. A signal generator was connected to the substitution antenna by a non-radiating cable. The absolute levels of the spurious emissions were measured by the substitution.  
Spurious emissions in dB =  $10 \lg(\text{TXpwr in Watts}/0.001)$  – the absolute level  
Spurious attenuation limit in dB =  $43 + 10 \text{Log}_{10}(\text{power out in Watts})$
8. Repeat above procedures until the measurements for all frequencies are completed.

## 10.5 Summary of Test Results

Remark: Test performed from 30MHz to 10<sup>th</sup> harmonics with low/middle/high channels, only the worst data were recorded.

### Cellular Band (Part 22H)

Frequency	Receiver Reading	Turn table Angle	RX Antenna		Substituted			Absolute Level	Result	
			Height	Polar	SG Level	Cable	Antenna Gain		Limit	Margin
(MHz)	(dBμV)	Degree	(m)	(H/V)	(dBm)	(dB)	(dB)	(dBm)	(dBm)	(dB)
GSM 850 Channel 190										
365.2	46.86	112	1.0	H	-51.8	0.20	0.00	-51.97	-13	-38.97
365.2	40.95	144	1.3	V	-58.7	0.20	0.00	-58.88	-13	-45.88
1673.2	63.87	247	1.8	H	-43.7	2.64	12.70	-33.59	-13	-20.59
1673.2	52.76	111	1.6	V	-54.1	2.64	12.70	-44.02	-13	-31.02
2509.8	55.68	154	1.2	H	-51.0	2.90	12.34	-41.59	-13	-28.59
2509.8	47.93	16	1.9	V	-60.4	2.90	12.34	-50.95	-13	-37.95
EDGE 850 Channel 190										
365.2	48.80	60	1.9	H	-49.8	0.20	0.00	-50.03	-13	-37.03
365.2	41.50	43	2.0	V	-58.1	0.20	0.00	-58.33	-13	-45.33
1673.2	63.27	319	1.3	H	-44.3	2.64	12.70	-34.19	-13	-21.19
1673.2	52.32	217	1.9	V	-54.5	2.64	12.70	-44.46	-13	-31.46
2509.8	54.70	231	1.0	H	-52.0	2.90	12.34	-42.57	-13	-29.57
2509.8	47.47	52	1.2	V	-60.8	2.90	12.34	-51.41	-13	-38.41
WCDMA Band V Channel 4183										
365.2	45.96	336	1.1	H	-52.7	0.20	0.00	-52.87	-13	-39.87
365.2	42.33	292	1.6	V	-57.3	0.20	0.00	-57.50	-13	-44.50
1673.2	63.82	234	1.7	H	-41.8	2.72	12.63	-31.90	-13	-18.90
1673.2	54.49	255	1.9	V	-52.3	2.72	12.63	-42.41	-13	-29.41
2509.8	55.07	229	1.8	H	-51.7	3.00	11.86	-42.81	-13	-29.81
2509.8	48.99	189	1.2	V	-57.0	3.00	11.86	-48.11	-13	-35.11

## Cellular Band (Part 24E)

Frequency	Receiver Reading	Turn table Angle	RX Antenna		Substituted			Absolute Level	Result	
			Height	Polar	SG Level	Cable	Antenna Gain		Limit	Margin
(MHz)	(dBμV)	Degree	(m)	(H/V)	(dBm)	(dB)	(dB)	(dBm)	(dBm)	(dB)
PCS 1900 Channel 512										
365.2	46.68	15	1.4	H	-52.0	0.20	0.00	-52.15	-13	-39.15
365.2	41.54	129	2.0	V	-58.1	0.20	0.00	-58.29	-13	-45.29
3760.0	62.17	294	1.3	H	-45.4	2.64	12.70	-35.29	-13	-22.29
3760.0	51.33	344	1.7	V	-55.5	2.64	12.70	-45.45	-13	-32.45
5640.0	55.12	38	2.0	H	-51.6	2.90	12.34	-42.15	-13	-29.15
5640.0	47.35	135	1.7	V	-61.0	2.90	12.34	-51.53	-13	-38.53
EDGE 1900 Channel 512										
365.2	46.86	59	1.4	H	-51.8	0.20	0.00	-51.97	-13	-38.97
365.2	41.39	308	1.9	V	-58.2	0.20	0.00	-58.44	-13	-45.44
3760.0	64.08	78	1.7	H	-43.4	2.64	12.70	-33.38	-13	-20.38
3760.0	51.35	15	1.7	V	-55.5	2.64	12.70	-45.43	-13	-32.43
5640.0	56.63	30	1.8	H	-50.1	2.90	12.34	-40.64	-13	-27.64
5640.0	48.72	353	1.5	V	-59.6	2.90	12.34	-50.16	-13	-37.16
WCDMA Band II Channel 9400										
365.2	48.02	62	1.1	H	-50.6	0.20	0.00	-50.81	-13	-37.81
365.2	43.41	338	1.8	V	-56.2	0.20	0.00	-56.42	-13	-43.42
3760.0	61.93	59	1.5	H	-43.7	2.72	12.63	-33.79	-13	-20.79
3760.0	52.69	17	1.7	V	-54.1	2.72	12.63	-44.21	-13	-31.21
5640.0	55.08	309	1.7	H	-51.7	3.00	11.86	-42.80	-13	-29.80
5640.0	46.93	271	1.4	V	-59.0	3.00	11.86	-50.17	-13	-37.17

Note: 1) Absolute Level = SG Level - Cable loss + Antenna Gain

2) Margin = Limit- Absolute Level

## 11 Band Edge Measurement

Test Requirement:	FCC Part 2.1051,22.917(a),24.238(a)
Test Method:	ANSI C63.4:2003, TIA/EIA-603-D:2010
Test Mode:	Transmitting

### 11.1 EUT Operation

Operating Environment :

Temperature:	23.5 °C
Humidity:	52.3 % RH
Atmospheric Pressure:	101.3kPa

### 11.2 Test Procedure

The RF output of the transmitter was connected to the input of the spectrum analyzer through sufficient attenuation.

According to FCC Part 22.917(a), the power of any emissions outside of the authorized operating frequency ranges must be attenuated below the transmitting power (P) by a factor of at least  $43 + 10 \log(P)$  dB.

According to FCC Part 24.238(a), the power of any emissions outside of the authorized operating frequency ranges must be attenuated below the transmitting power (P) by a factor of at least  $43 + 10 \log(P)$  dB.

The center of the spectrum analyzer was set to block edge frequency

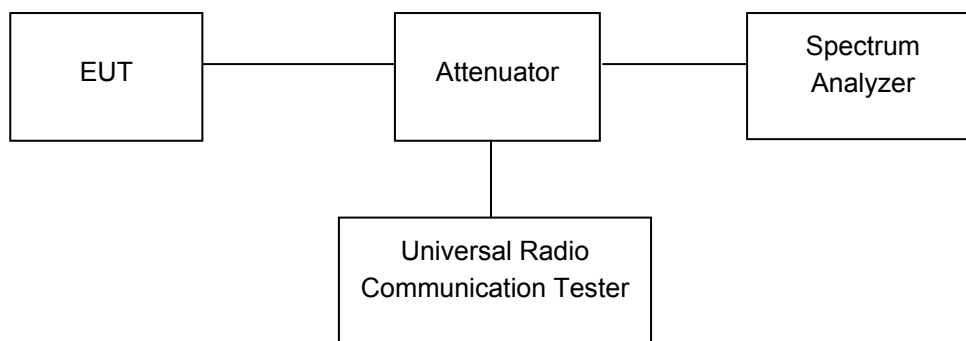

**11.3 Test Result**

Cellular Band (Part 22H)

Test Mode	Frequency(MHz)	Emission(dBm)	Limit(dBm)
GSM 850	823.987	-19.56	-13
	849.015	-18.08	-13

Test Mode	Frequency(MHz)	Emission(dBm)	Limit(dBm)
EDGE 850	823.982	-19.91	-13
	849.017	-18.44	-13

Test Mode	Frequency(MHz)	Emission(dBm)	Limit(dBm)
WCDMA Band V	823.912	-21.54	-13
	849.056	-22.28	-13

Cellular Band (Part 24E)

Test Mode	Frequency(MHz)	Emission(dBm)	Limit(dBm)
PCS 1900	1849.963	-14.87	-13
	1910.007	-16.39	-13

Test Mode	Frequency(MHz)	Emission(dBm)	Limit(dBm)
EDGE 1900	1849.968	-14.43	-13
	1910.012	-16.71	-13

Test Mode	Frequency(MHz)	Emission(dBm)	Limit(dBm)
WCDMA Band II	1849.992	-23.42	-13
	1910.008	-18.27	-13

Test plots  
Cellular Band (Part 22H)  
GSM 850 band edge-left side

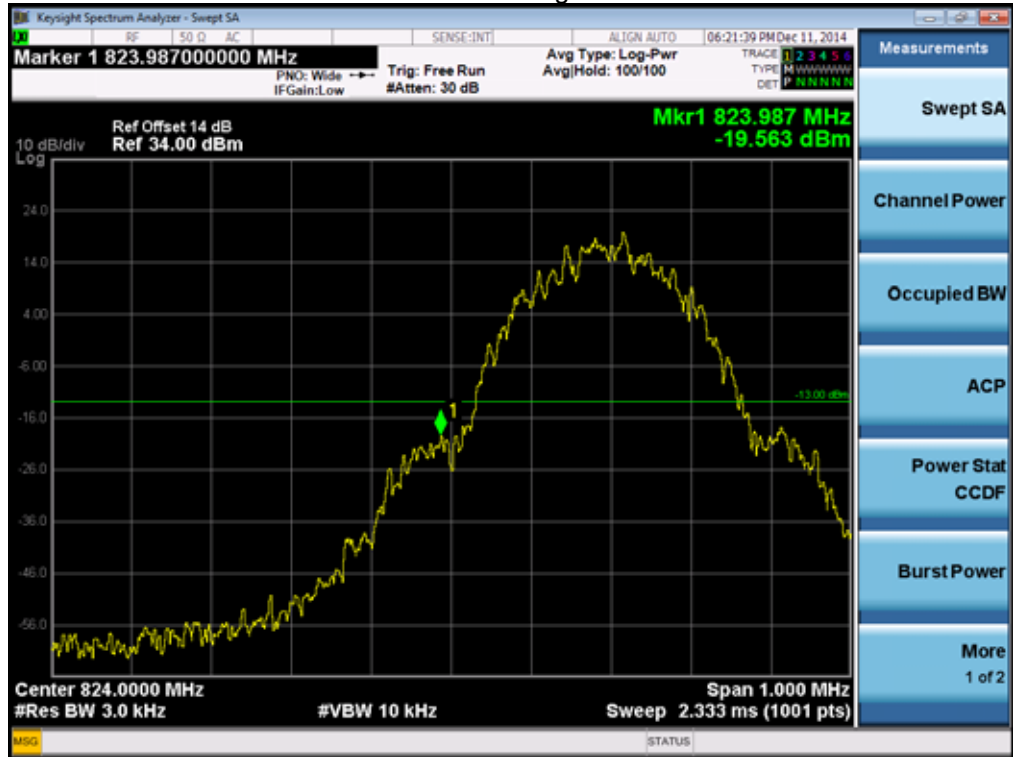

GSM 850 band edge-right side





WCDMA band V band edge-left side

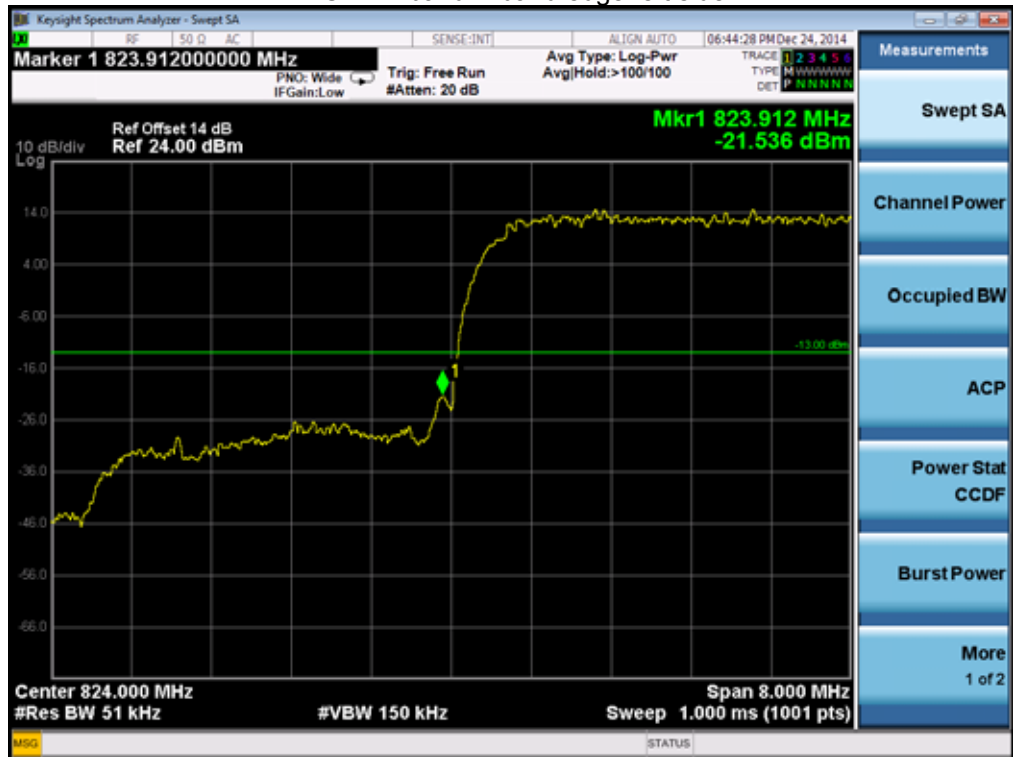

WCDMA band V band edge-right side



Cellular Band (Part 24E)

PCS 1900 band edge-left side

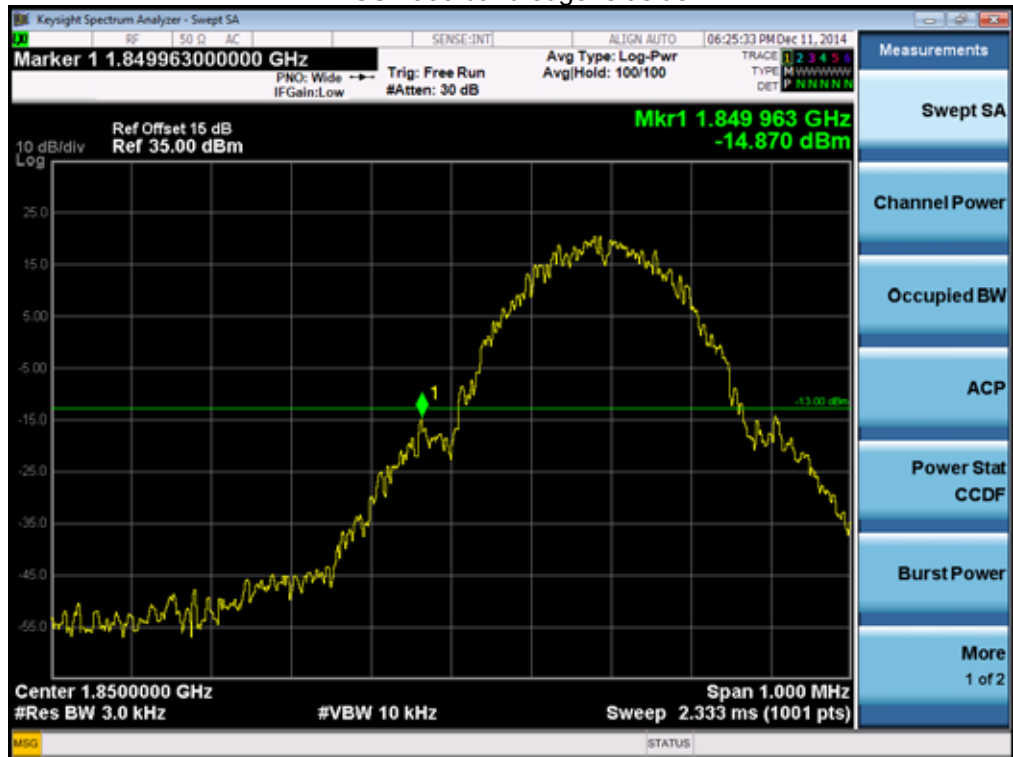

PCS 1900 band edge-right side

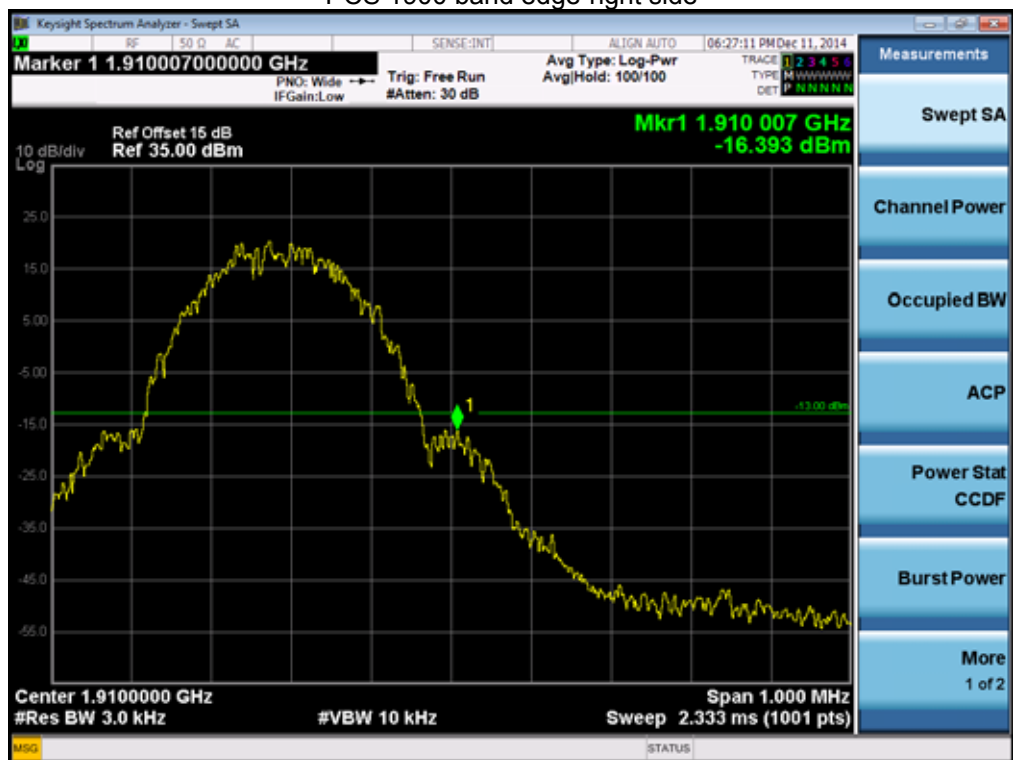

WCDMA band II band edge-left side

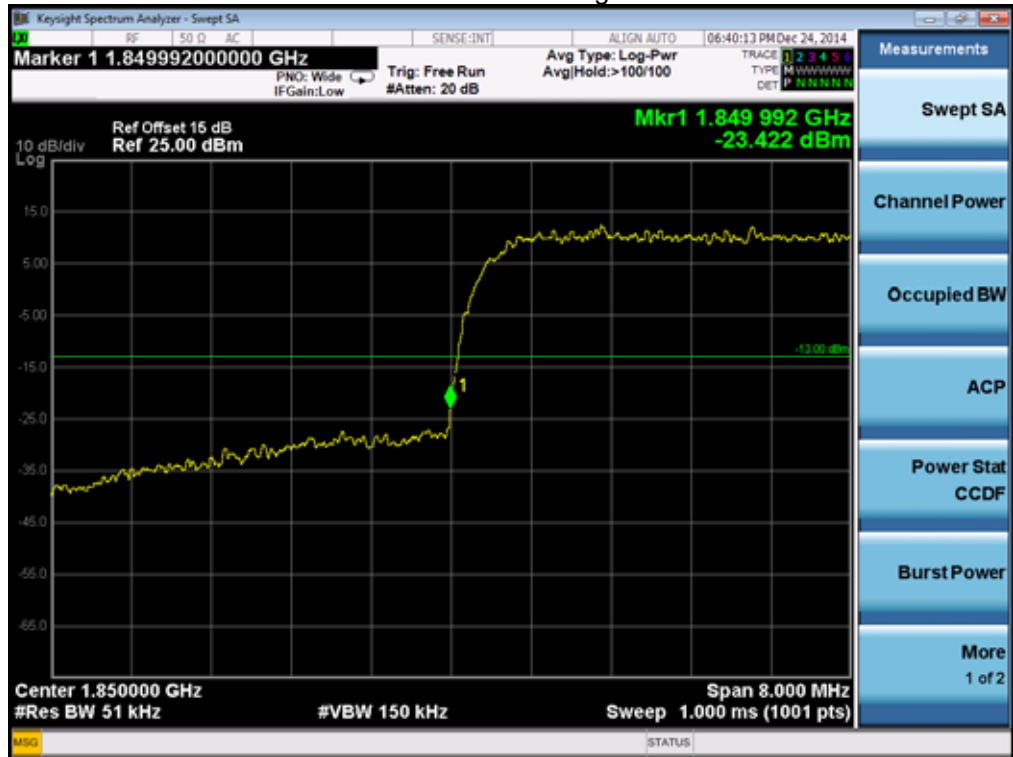

WCDMA band II band edge-right side



## 12 FREQUENCY STABILITY

Test Requirement:	FCC Part 2.1055,22.355,24.235
Test Method:	ANSI C63.4:2003, TIA/EIA-603-D:2010
Test Mode:	Transmitting

### 12.1 EUT Operation

Operating Environment :	
Temperature:	22.9 °C
Humidity:	52.0 % RH
Atmospheric Pressure:	101.3kPa

### 12.2 Test Procedure

Frequency Stability vs. Temperature: The equipment under test was connected to an external DC power supply and the RF output was connected to communication test set via feed-through attenuators. The EUT was placed inside the temperature chamber. The DC leads and RF output cable exited the chamber through an opening made for the purpose.

After the temperature stabilized for approximately 20 minutes, the frequency output was recorded from the communication test set.

Frequency Stability vs. Voltage: For hand carried, battery powered equipment; reduce primary supply voltage to the battery operating end point which shall be specified by the manufacturer.

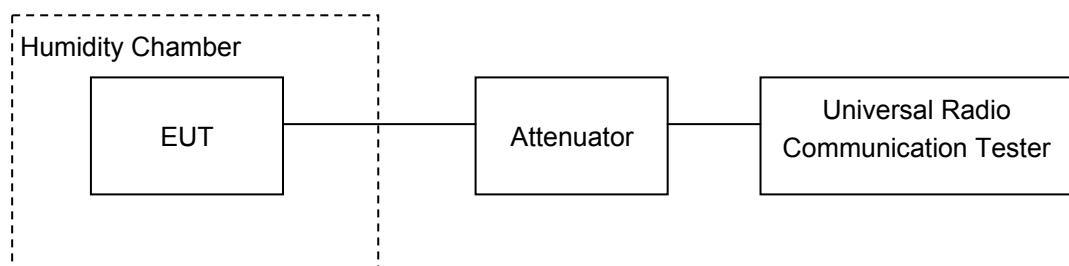

### 12.3 Test Result

#### Cellular Band (Part 22H)

GSM 850 Test Frequency:836.6MHz				
Temperature ( )	Power Supply (VDC)	Frequency Error (Hz)	Frequency Error (ppm)	Limit (ppm)
50	3.7	12	0.0143	2.5
40		12	0.0141	2.5
30		12	0.0139	2.5
20		11	0.0137	2.5
10		10	0.0124	2.5
0		10	0.0116	2.5
-10		9	0.0104	2.5
-20		8	0.0098	2.5
-30		7	0.0088	2.5
20		3.3	7	0.0079
20	4.2	6	0.0070	2.5

GPRS 850 Test Frequency:836.6MHz				
Temperature ( )	Power Supply (VDC)	Frequency Error (Hz)	Frequency Error (ppm)	Limit (ppm)
50	3.7	15	0.0179	2.5
40		14	0.0167	2.5
30		14	0.0166	2.5
20		14	0.0163	2.5
10		13	0.0160	2.5
0		13	0.0151	2.5
-10		12	0.0141	2.5
-20		12	0.0140	2.5
-30		12	0.0139	2.5
20		3.3	11	0.0135
20	4.2	11	0.0126	2.5

EDGE 850 Test Frequency:836.6MHz				
Temperature ( )	Power Supply (VDC)	Frequency Error (Hz)	Frequency Error (ppm)	Limit (ppm)
50	3.7	16	0.0191	2.5
40		16	0.0189	2.5
30		15	0.0177	2.5
20		15	0.0174	2.5
10		14	0.0168	2.5
0		13	0.0158	2.5
-10		13	0.0151	2.5
-20		12	0.0138	2.5
-30		11	0.0137	2.5
20		3.3	11	0.0134
20	4.2	10	0.0125	2.5

WCDMA Band V Test Frequency:836.6MHz				
Temperature ( )	Power Supply (VDC)	Frequency Error (Hz)	Frequency Error (ppm)	Limit (ppm)
50	3.7	5	0.0060	2.5
40		6	0.0068	2.5
30		7	0.0079	2.5
20		7	0.0086	2.5
10		8	0.0097	2.5
0		9	0.0110	2.5
-10		10	0.0115	2.5
-20		10	0.0122	2.5
-30		11	0.0134	2.5
20		3.3	12	0.0141
20	4.2	5	0.0060	2.5

## PCS Band (Part 24E)

PCS 1900 Test Frequency:1880.0MHz				
Temperature ( )	Power Supply (VDC)	Frequency Error (Hz)	Frequency Error (ppm)	Limit (ppm)
50	3.7	13	0.0069	2.5
40		13	0.0071	2.5
30		14	0.0072	2.5
20		14	0.0077	2.5
10		15	0.0082	2.5
0		16	0.0085	2.5
-10		16	0.0086	2.5
-20		17	0.0089	2.5
-30		18	0.0094	2.5
20		3.3	18	0.0096
20	4.2	18	0.0096	2.5

GPRS 1900 Test Frequency:1880.0MHz				
Temperature ( )	Power Supply (VDC)	Frequency Error (Hz)	Frequency Error (ppm)	Limit (ppm)
50	3.7	15	0.0080	2.5
40		16	0.0085	2.5
30		17	0.0091	2.5
20		18	0.0096	2.5
10		19	0.0102	2.5
0		19	0.0104	2.5
-10		20	0.0106	2.5
-20		21	0.0111	2.5
-30		22	0.0116	2.5
20		3.3	22	0.0117
20	4.2	23	0.0120	2.5

EDGE 1900 Test Frequency:1880.0MHz				
Temperature ( )	Power Supply (VDC)	Frequency Error (Hz)	Frequency Error (ppm)	Limit (ppm)
50	3.7	17	0.0090	2.5
40		17	0.0091	2.5
30		17	0.0092	2.5
20		17	0.0093	2.5
10		18	0.0094	2.5
0		19	0.0099	2.5
-10		19	0.0102	2.5
-20		19	0.0102	2.5
-30		20	0.0108	2.5
20		3.3	21	0.0113
20	4.2	21	0.0114	2.5

WCDMA Band II Test Frequency:1880.0MHz				
Temperature ( )	Power Supply (VDC)	Frequency Error (Hz)	Frequency Error (ppm)	Limit (ppm)
50	3.7	7	0.0037	2.5
40		7	0.0035	2.5
30		6	0.0032	2.5
20		6	0.0032	2.5
10		6	0.0031	2.5
0		6	0.0030	2.5
-10		5	0.0028	2.5
-20		5	0.0024	2.5
-30		4	0.0020	2.5
20		3.3	4	0.0019
20	4.2	3	0.0014	2.5



### **13 RF Exposure**

Remark: refer to SAR test report: STR14128113H.

===== End of Report =====