



# **Video Intercom Module Door Station**

**User Manual**

# Legal Information

©2021 Hangzhou Hikvision Digital Technology Co., Ltd. All rights reserved.

## About this Manual

The Manual includes instructions for using and managing the Product. Pictures, charts, images and all other information hereinafter are for description and explanation only. The information contained in the Manual is subject to change, without notice, due to firmware updates or other reasons. Please find the latest version of this Manual at the Hikvision website ( <https://www.hikvision.com/> ).

Please use this Manual with the guidance and assistance of professionals trained in supporting the Product.

## Trademarks

**HIKVISION** and other Hikvision's trademarks and logos are the properties of Hikvision in various jurisdictions.

Other trademarks and logos mentioned are the properties of their respective owners.

## Disclaimer

TO THE MAXIMUM EXTENT PERMITTED BY APPLICABLE LAW, THIS MANUAL AND THE PRODUCT DESCRIBED, WITH ITS HARDWARE, SOFTWARE AND FIRMWARE, ARE PROVIDED "AS IS" AND "WITH ALL FAULTS AND ERRORS". HIKVISION MAKES NO WARRANTIES, EXPRESS OR IMPLIED, INCLUDING WITHOUT LIMITATION, MERCHANTABILITY, SATISFACTORY QUALITY, OR FITNESS FOR A PARTICULAR PURPOSE. THE USE OF THE PRODUCT BY YOU IS AT YOUR OWN RISK. IN NO EVENT WILL HIKVISION BE LIABLE TO YOU FOR ANY SPECIAL, CONSEQUENTIAL, INCIDENTAL, OR INDIRECT DAMAGES, INCLUDING, AMONG OTHERS, DAMAGES FOR LOSS OF BUSINESS PROFITS, BUSINESS INTERRUPTION, OR LOSS OF DATA, CORRUPTION OF SYSTEMS, OR LOSS OF DOCUMENTATION, WHETHER BASED ON BREACH OF CONTRACT, TORT (INCLUDING NEGLIGENCE), PRODUCT LIABILITY, OR OTHERWISE, IN

CONNECTION WITH THE USE OF THE PRODUCT, EVEN IF HIKVISION HAS BEEN ADVISED OF THE POSSIBILITY OF SUCH DAMAGES OR LOSS.



YOU ACKNOWLEDGE THAT THE NATURE OF THE INTERNET PROVIDES FOR INHERENT SECURITY RISKS, AND HIKVISION SHALL NOT TAKE ANY RESPONSIBILITIES FOR ABNORMAL OPERATION, PRIVACY LEAKAGE OR OTHER DAMAGES RESULTING FROM CYBER-ATTACK, HACKER ATTACK, VIRUS INFECTION, OR OTHER INTERNET SECURITY RISKS; HOWEVER, HIKVISION WILL PROVIDE TIMELY TECHNICAL SUPPORT IF REQUIRED.

YOU AGREE TO USE THIS PRODUCT IN COMPLIANCE WITH ALL APPLICABLE LAWS, AND YOU ARE SOLELY RESPONSIBLE FOR ENSURING THAT YOUR USE CONFORMS TO THE APPLICABLE LAW. ESPECIALLY, YOU ARE RESPONSIBLE, FOR USING THIS PRODUCT IN A MANNER THAT DOES NOT INFRINGE ON THE RIGHTS OF THIRD PARTIES, INCLUDING WITHOUT LIMITATION, RIGHTS OF PUBLICITY, INTELLECTUAL PROPERTY RIGHTS, OR DATA PROTECTION AND OTHER PRIVACY RIGHTS. YOU SHALL NOT USE THIS PRODUCT FOR ANY PROHIBITED END-USES, INCLUDING THE DEVELOPMENT OR PRODUCTION OF WEAPONS OF MASS DESTRUCTION, THE DEVELOPMENT OR PRODUCTION OF CHEMICAL OR BIOLOGICAL WEAPONS, ANY ACTIVITIES IN THE CONTEXT RELATED TO ANY NUCLEAR EXPLOSIVE OR UNSAFE NUCLEAR FUEL-CYCLE, OR IN SUPPORT OF HUMAN RIGHTS ABUSES.

IN THE EVENT OF ANY CONFLICTS BETWEEN THIS MANUAL AND THE APPLICABLE LAW, THE LATER PREVAILS.

# Symbol Conventions

The symbols that may be found in this document are defined as follows.

Symbol	Description
 <b>Danger</b>	Indicates a hazardous situation which, if not avoided, will or could result in death or serious injury.
 <b>Caution</b>	Indicates a potentially hazardous situation which, if not avoided, could result in equipment damage, data loss, performance degradation, or unexpected results.
 <b>Note</b>	Provides additional information to emphasize or supplement important points of the main text.

## Regulatory Information

### FCC Information

Please take attention that changes or modification not expressly approved by the party responsible for compliance could void the user's authority to operate the equipment.

FCC compliance: This equipment has been tested and found to comply with the limits for a Class B digital device, pursuant to part 15 of the FCC Rules. These limits are designed to provide reasonable protection against harmful interference in a residential installation. This equipment generates, uses and can radiate radio frequency energy and, if not installed and used in accordance with the instructions, may cause harmful interference to radio communications. However, there is no guarantee that interference will not occur in a particular installation. If this equipment does cause harmful interference to radio or television reception, which can be determined by turning the equipment off and on, the user is encouraged to try to correct the interference by one or more of the following measures:

- Reorient or relocate the receiving antenna.
- Increase the separation between the equipment and receiver.
- Connect the equipment into an outlet on a circuit different from that to which the receiver is connected.
- Consult the dealer or an experienced radio/TV technician for help

### FCC Conditions

This device complies with part 15 of the FCC Rules. Operation is subject to the following two conditions:

1. This device may not cause harmful interference.
2. This device must accept any interference received, including interference that may cause undesired operation.

This equipment complies with FCC radiation exposure limits set forth for an uncontrolled environment. This equipment should be installed and operated with minimum distance 20cm between the radiator & your body.

## EU Conformity Statement



This product and - if applicable - the supplied accessories too are marked with "CE" and comply therefore with the applicable harmonized European standards listed under the EMC Directive 2014/30/EU, the RoHS Directive 2011/65/EU



2012/19/EU (WEEE directive): Products marked with this symbol cannot be disposed of as unsorted municipal waste in the European Union. For proper recycling, return this product to your local supplier upon the purchase of equivalent new equipment, or dispose of it at designated collection points. For more information see: [www.recyclethis.info](http://www.recyclethis.info)



2006/66/EC (battery directive): This product contains a battery that cannot be disposed of as unsorted municipal waste in the European Union. See the product documentation for specific battery information. The battery is marked with this symbol, which may include lettering to indicate cadmium (Cd), lead (Pb), or mercury (Hg). For proper recycling, return the battery to your supplier or to a designated collection point. For more information see: [www.recyclethis.info](http://www.recyclethis.info)

## Industry Canada ICES-003 Compliance

This device meets the CAN ICES-3 (B)/NMB-3(B) standards requirements.

# Contents

1 Appearance .....	1
2 Terminal and Wiring .....	8
2.1 Terminal Description .....	8
2.2 Module Door Station Wiring .....	12
2.2.1 Door Lock Wiring .....	12
2.2.2 Door Contact Wiring .....	12
2.2.3 Exit Button Wiring .....	13
2.2.4 RS-485 Card Reader Wiring .....	14
3 Installation .....	15
3.1 Configure Sub Module Address .....	15
3.2 One-Module Installation .....	16
3.2.1 One-Module Surface Mounting .....	16
3.2.2 One-Module Flush Mounting .....	19
3.3 Two-Module Installation .....	23
3.3.1 Two-Module Surface Mounting .....	23
3.3.2 Two-Module Flush Mounting .....	28
3.4 Three-Module Installation .....	32
3.4.1 Three-Module Surface Installation .....	32
3.4.2 Three-Module Flush Mounting .....	36
3.5 More-Than-Three Module Installation .....	40
3.5.1 More-than-Three Module Surface Mounting .....	40
3.5.2 More-Than-Three Module Flush Mounting .....	46

4	Activation .....	54
4.1	Activate Device via Client Software .....	54
4.2	Edit Network Parameters .....	54
5	Configuration via Client Software .....	56
5.1	Device Management .....	56
5.1.1	Add Online Device .....	56
5.1.2	Add Device by IP Address .....	57
5.1.3	Add Device by IP Segment .....	57
5.2	Live View via Door Station .....	58
5.3	Remote Configuration .....	58
5.3.1	Device Management .....	58
5.3.2	Local Parameters Settings .....	60
5.3.3	System Settings .....	61
5.3.4	Network Settings .....	65
5.3.5	Video & Audio Settings .....	69
5.3.6	Image Settings .....	71
5.3.7	Schedule Settings .....	73
5.3.8	Intercom Settings .....	75
5.3.9	Access Control Settings .....	80
5.3.10	Theme Settings .....	84
5.4	Organization Management .....	84
5.4.1	Add Organization .....	84
5.4.2	Modify and Delete Organization .....	85
5.5	Person Management .....	85



5.5.1 Add Person .....	85
5.5.2 Modify and Delete Person .....	87
5.5.3 Import and Export Person Information .....	87
5.5.4 Get Person Information from Device .....	88
5.5.5 Change Person to Other Organization .....	88
5.5.6 Issue Card in Batch .....	89
5.5.7 Permission Settings .....	90
6 Video Intercom Operation .....	92
6.1 Video Intercom Operation via Device .....	92
6.1.1 Call Resident .....	92
6.1.2 Issue Card .....	93
6.1.3 Unlock Door .....	93
6.2 Video Intercom Operation via Client Software .....	94
6.2.1 Receive Call from Door Station .....	95
6.2.2 Live View via Door Station .....	96
6.2.3 View Call Logs .....	96
6.2.4 Search Video Intercom Information .....	97
A. Communication Matrix and Device Command .....	101

# 1 Appearance

## Main Unit

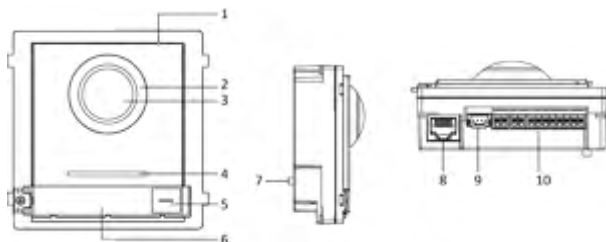

**Figure 1-1 Main Unit Appearance**

**Table 1-1 Appearance Description**

No.	Description
1	Microphone
2	Low Illumination IR Supplement Light
3	Built-in Camera
4	Loudspeaker
5	Call Button
6	Nametag
7	TAMPER
8	Network Interface
9	Module-Connecting Interface (output)
10	Terminals

 **Note**

- Nametag area supports insert customized name card. The suggested card size is: 58 (L) x 11.7(W) mm.
- The module connecting interface is used to connect other function module, such as nametag module, keypad module, card reader module, etc. All these modules are known as sub module.

**Two-Wire Main Unit**

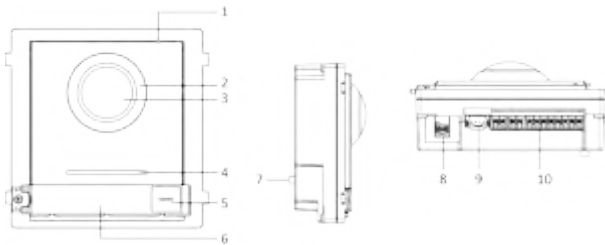

**Figure 1-2 Two-Wire Main Unit**  
**Table 1-2 Appearance Description**

No.	Description
1	Microphone
2	Low Illumination IR Supplement Light
3	Built-in Camera
4	Loudspeaker
5	Call Button
6	Nametag
7	TAMPER
8	Two-Wire Interface
9	Module-Connecting Interface (output)
10	Terminals

 **Note**

- Nametag area supports insert customized name card. The suggested card size is: 58 (L) x 11.7(W) mm.
- The module connecting interface is used to connect other function module, such as nametag module, keypad module, card reader module, etc. All these modules are known as sub module.

**Nametag Module**

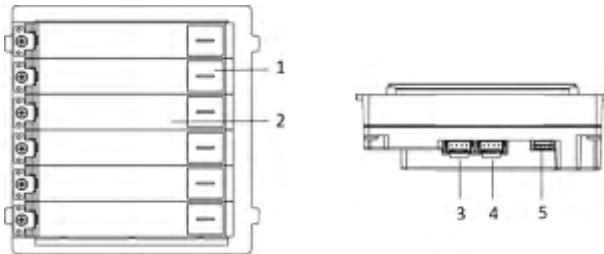

**Figure 1-3 Nametag Module Appearance**

**Table 1-3 Appearance Description**

No.	Description
1	Call Button
2	Nametag
3	Module-Connecting Interface (output)
4	Module-Connecting Interface (input)
5	Debugging Port

### Keypad Module

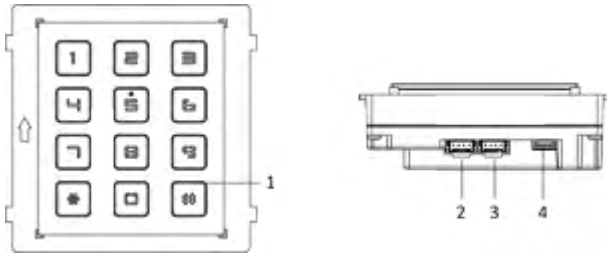

Figure 1-4 Keypad Module Appearance

Table 1-4 Appearance Description

No.	Description
1	Button
2	Module-Connecting Interface (output)
3	Module-Connecting Interface (input)
4	Debugging Port

### Indicator Module

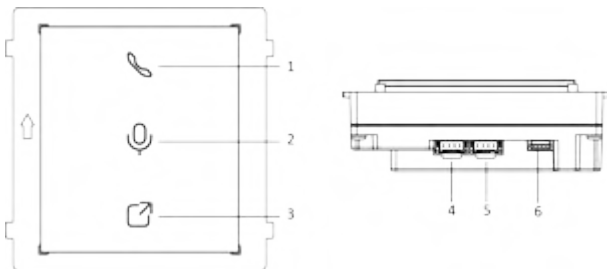
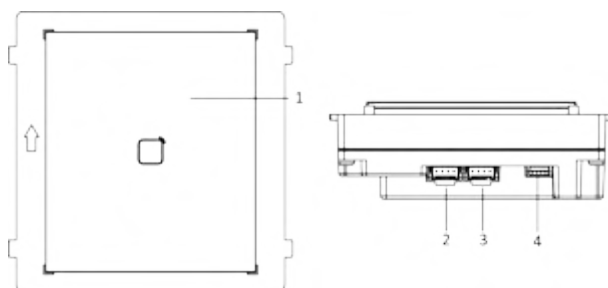

Figure 1-5 Indicator Module

**Table 1-5 Appearance Description**

No.	Description
1	Calling Indicator
2	Two-way Audio Indicator
3	Unlock Indicator
4	Module-connecting Interface (output)
5	Module-connecting Interface(input)
6	Debugging Port

**Card Reader Module**

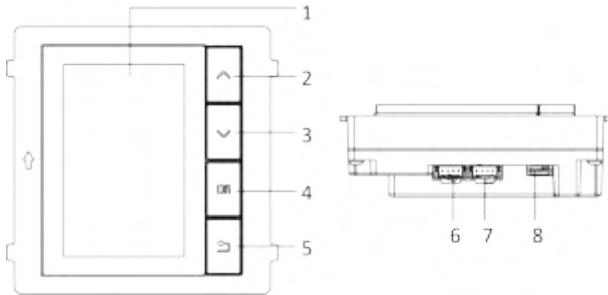

**Figure 1-6 Card Reader Module**

**Table 1-6 Appearance Description**

No.	Description
1	Card Reading Area
2	Module-connecting Interface (output)
3	Module-connecting Interface(input)
4	Debugging Port

**Display Module**

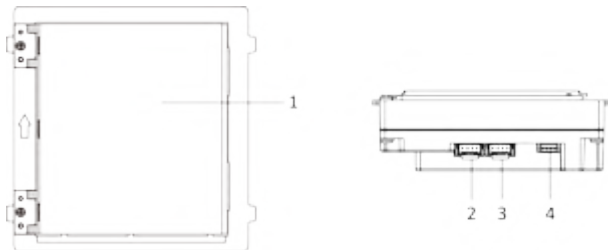

**Figure 1-7 Display Module**

**Table 1-7 Description**

No.	Description	No.	Description
1	Screen	5	Back Button
2	Up Button	6	Module-connecting Interface (output)
3	Down Button	7	Module-connecting Interface (input)
4	Confirm Button	8	Debug Port

**Information Module**

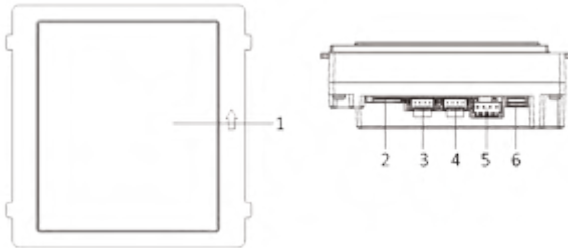

**Figure 1-8 Information Module**

**Table 1-8 Description**

No.	Description
1	Display Area
2	Module-connecting Interface (output)
3	Module-connecting Interface (input)
4	Debugging Port

**Touch-Display Module**



**Figure 1-9 Touch-Display Module**

**Table 1-9 Description**

No.	Description
1	Touch-Display Area
2	TF Card Slot
3	Module-connecting Interface (output)
4	Module-connecting Interface (input)
5	Video & Audio Terminal
6	Debugging Port

**Note**

The debugging port is used for debugging only.



## 2 Terminal and Wiring

### 2.1 Terminal Description

#### Main Unit Terminals

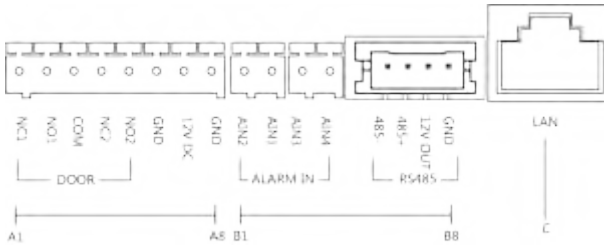

Figure 2-1 Main Unit Terminals

Table 2-1 Descriptions of Terminals and Interfaces

No.	Interface	Description
A1	NC1	Door Lock Relay Output (NC)
A2	NO1	Door Lock Relay Output (NO)
A3	COM	Common Interface
A4	NC2	Door Lock Relay Output (NC)
A5	NO2	Door Lock Relay Output (NO)
A6	GND	Grounding
A7	12 VDC	Power Input
A8	GND	Grounding
B1	AIN2	For the access of Door Magnetic 2
B2	AIN1	For the access of Door Magnetic 1
B3	AIN3	For the access of Exit Button 1

No.	Interface	Description
B4	AIN4	For the access of Exit Button 2
B5	485-	Module-connecting Interface
B6	485+	
B7	12 V OUT	
B8	GND	
C	LAN	PoE Network Interface(Supports IEEE 802.3af/at-Compliant Devices)

### Two-Wire Main Unit Terminal

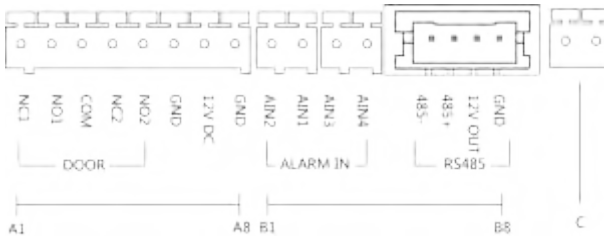

**Figure 2-2 Two-Wire Main Unit Terminal**  
**Table 2-2 Descriptions of Terminals and Interfaces**

No.	Interface	Description
A1	NC1	Door Lock Relay Output (NC)
A2	NO1	Door Lock Relay Output (NO)
A3	COM	Common Interface
A4	NC2	Door Lock Relay Output (NC)
A5	NO2	Door Lock Relay Output (NO)
A6	GND	Grounding
A7	12 VDC	Reserved

No.	Interface	Description
A8	GND	Grounding
B1	AIN2	For the access of Door Magnetic 2
B2	AIN1	For the access of Door Magnetic 1
B3	AIN3	For the access of Exit Button 1
B4	AIN4	For the access of Exit Button 2
B5	485-	Module-connecting Interface
B6	485+	
B7	12 V OUT	
B8	GND	
C	Two-Wire Interface	Two-Wire Interface

### Sub Module Terminal (Except Touch-Display Module)

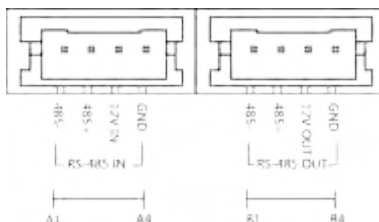

Figure 2-3 Sub Module Terminal (Except Touch-Display Module)

Table 2-3 Description

No.	Interface	Description
A1	485-	Module-Connecting Interface (Input)
A2	485+	
A3	12V IN	
A4	GND	

No.	Interface	Description
B1	485-	Module-Connecting Interface (Output)
B2	485+	
B3	12V OUT	
B4	GND	

### Touch-Display Module

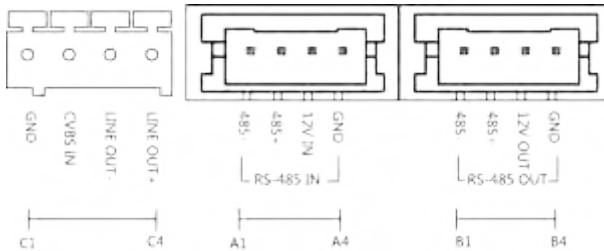

Figure 2-4 Touch-Display Module

Table 2-4 Description

No.	Interface	Description
A1	485-	Module-Connecting Interface (Input)
A2	485+	
A3	12V IN	
A4	GND	
B1	485-	Module-Connecting Interface (Output)
B2	485+	
B3	12V OUT	
B4	GND	
C1	GND	Grounding Interface

No.	Interface	Description
C2	CVSB IN	Composite Video Broadcast Signal Input (Reserved)
C3	LINEOUT-	Audio Output (Reserved)
C4	LINEOUT+	

## 2.2 Module Door Station Wiring

### 2.2.1 Door Lock Wiring

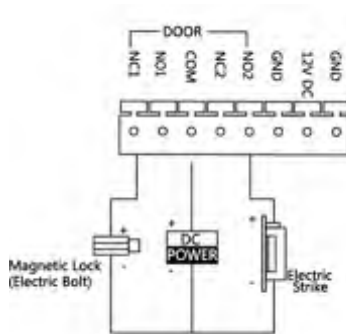

Figure 2-5 Door Lock Wiring

#### Note

Terminal NC1/COM is set as default for accessing magnetic lock/electric bolt; terminal NO2/COM is set as default for accessing electric strike.

### 2.2.2 Door Contact Wiring

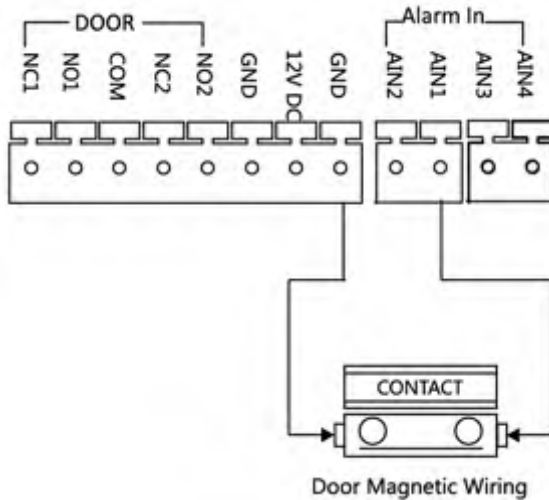

Figure 2-6 Door Contact Wiring

 **Note**

AIN1 and AIN2 are defaulted to connect door contact. Door contact connected to AIN1 detects status of the lock that connected to NC1/NO1; Door contact connected to AIN2 detects the status of the lock connected to NC2/NO2.

### 2.2.3 Exit Button Wiring

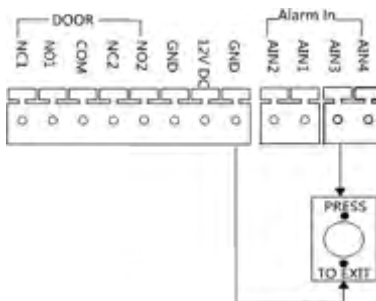

Figure 2-7 Exit Button Wiring

 **Note**

AIN3 and AIN4 are set as default for connecting exit button. Exit button connected to AIN3 opens the lock connected to NC1/NO1; Exit button connected to AIN4 controls the lock that connected to NC2/NO2.

---

### 2.2.4 RS-485 Card Reader Wiring

To connect RS-485 card reader, refer to the picture below.

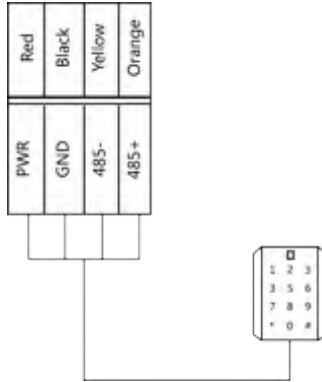

**Figure 2-8 RS-485 Card Reader Wiring**

## 3 Installation

### Note

- Make sure the device in the package is in good condition and all the assembly parts are included.
- Sub module must work along with the main unit.
- Set the sub module address before start the installation steps.
- Make sure the place for surface mounting is flat.
- Make sure all the related equipment is power-off during the installation.
- Tools that you need to prepare for installation:  
Drill ( $\varnothing 6$ ), cross screwdriver (PH1\*150 mm), and gradienter.

### 3.1 Configure Sub Module Address

You need to set the sub module address via DIP switch before installation.

#### Steps

1. Remove the rubber cover on the rear panel of the sub module to expose the DIP switch.

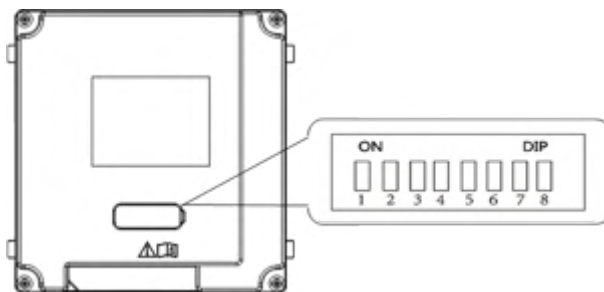

Figure 3-1 DIP Switch

2. Set the sub module address according to the DIP rules, and install the rubber cover back.



 **Note**

- Bit 1, 2, 3, 4 are used to coding the sub module address. Bit 5, 6, 7 are reserved. Set Bit 8 as on to enable a resistance (120Ω).
- Valid sub module address is from 1 to 8. The address should be unique for connecting to the main unit.  
The sub module address and its corresponding switch status are displayed as below.

**Table 3-1 Description**

<b>Sub Module Address</b>	<b>1</b>	<b>2</b>	<b>3</b>	<b>4</b>	<b>5</b>	<b>6</b>	<b>7</b>	<b>8</b>
Bit 1	ON	OFF	ON	OFF	ON	OFF	ON	OFF
Bit 2	OFF	ON	ON	OFF	OFF	ON	ON	OFF
Bit 3	OFF	OFF	OFF	ON	ON	ON	ON	OFF
Bit 4	OFF	OFF	OFF	OFF	OFF	OFF	OFF	ON

## 3.2 One-Module Installation

### 3.2.1 One-Module Surface Mounting

### Before You Start

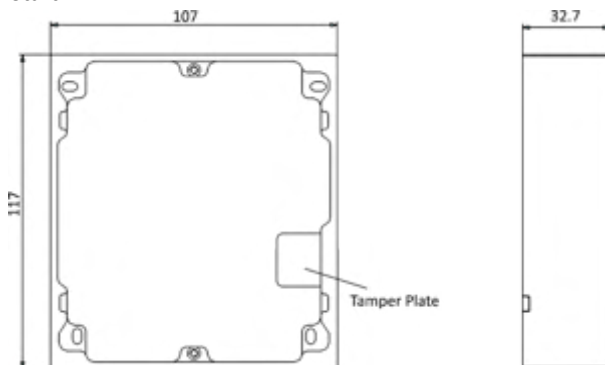

**Figure 3-2 Mounting Frame**

---

#### **Note**

- The dimension of one module mounting frame (W × H × D) is: 117 mm × 107 mm × 32.7 mm.
- The dimensions above are for reference only. The actual size can be slightly different from the theoretical dimension.

---

#### **Steps**

1. Paste the installation Sticker 1 onto the wall. Make sure the sticker is placed horizontally via measuring with the gradienter.
2. Drill 4 holes according to the screw holes on the sticker.

---

#### **Note**

- The suggested size of hole is 6 (diameter) × 25 (depth) mm.
  - The suggested length of cables left outside is 100 mm.
-

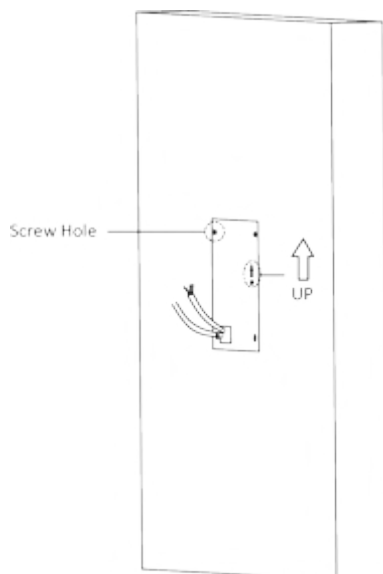

**Figure 3-3 Drill Screw Holes**

3. Remove the stricker and insert the expansion sleeves into the screw holes.
4. Fix the mounting frame onto the wall with 4 expansion bolts.

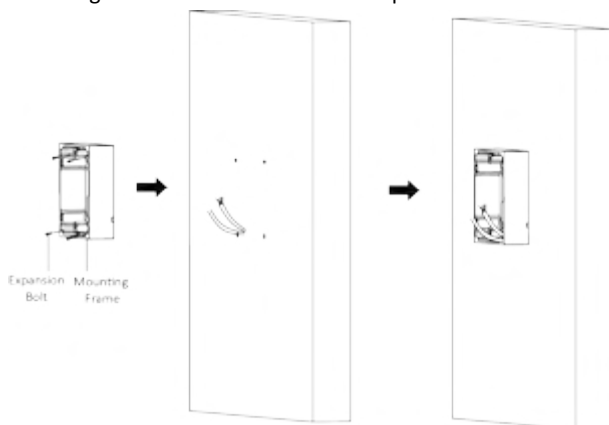

**Figure 3-4 Fix the Mounting Frame**

5. Connect the cables to the corresponding interfaces of the main unit and insert the main unit into the frame.

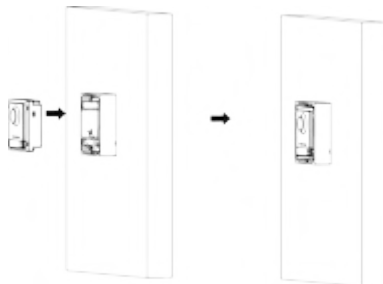

**Figure 3-5 Insert the Main Unit**

6. Fix the cover onto the frame.

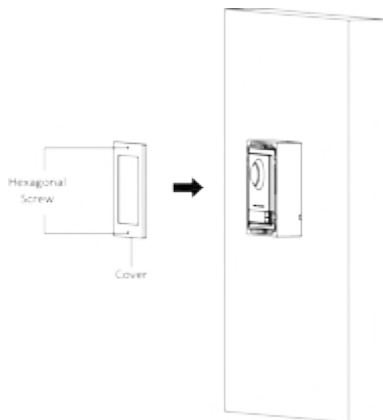

**Figure 3-6 Fix the Cover**

### 3.2.2 One-Module Flush Mounting

### Before You Start

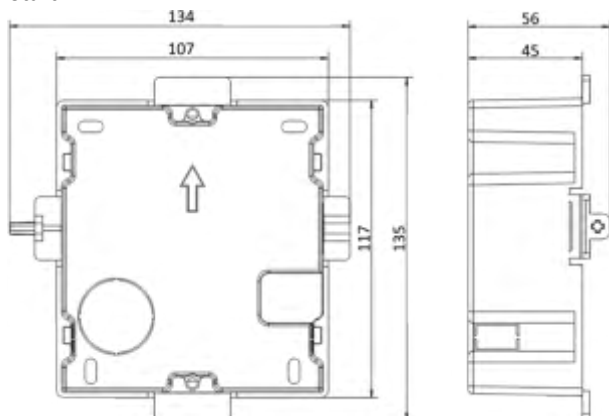

Figure 3-7 Front and Side View of the Gang Box

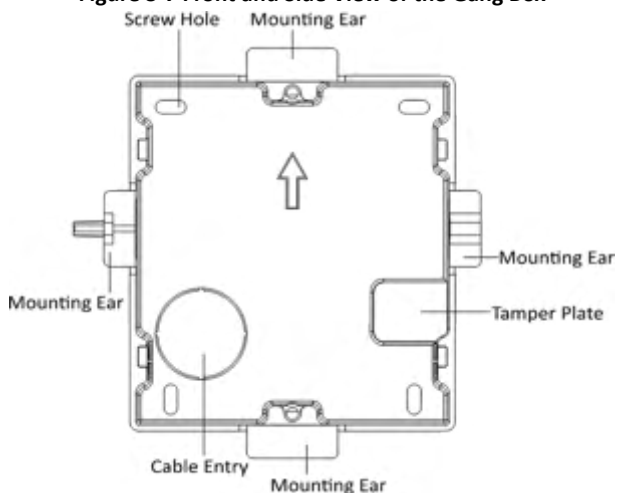

Figure 3-8 Gang Box

---

 **Note**

The dimension of one-module gang box is: 115 (W) × 134 (H) × 56 (D) mm. The dimension is for reference only.

---

**Steps**

1. Drill an installation hole, and pull the cables out.

---

 **Note**

- The suggested dimension of installation hole is 118 (W) × 108 (H) × 45.5 (D) mm.
  - The suggested length of cables left outside is 100 mm.
- 

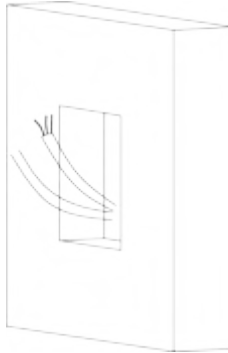

**Figure 3-9 Drill Installation Hole**

2. Remove the plastic sheet of the cable entry.
3. Mark the gang box screw holes on the wall.
  - 1) Route the cables through the gang box hole.
  - 2) Insert the gang box into the installation hole.
  - 3) Mark the gang box screw holes' position with a marker, and take out the gang box.

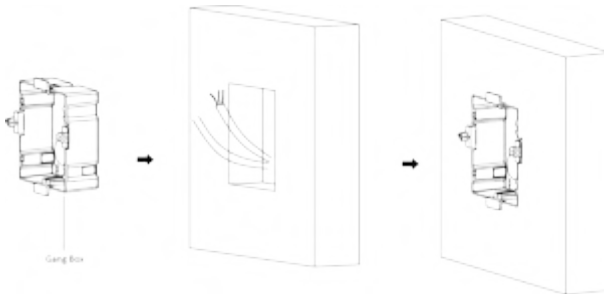

**Figure 3-10 Mark the Screw Holes**

4. Drill 4 holes according to marks on the wall, and insert the expansion sleeves into the screw holes.

 **Note**

The suggested size of the hole is 6 (diameter) × 45 (depth) mm.

5. Route the cables through the gang box hole. Insert the gang box into the installation hole. Fix the gang box with 4 expansion bolts.

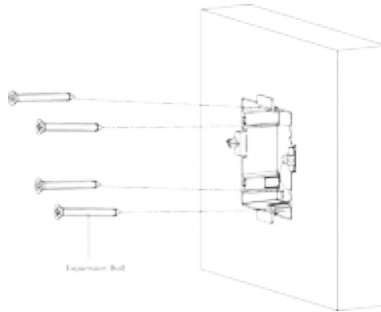

**Figure 3-11 Fix the Gang Box**

6. Fill the gap between the gang box and the wall with concrete. Remove the 4 mounting ears with tool after concrete is dry.

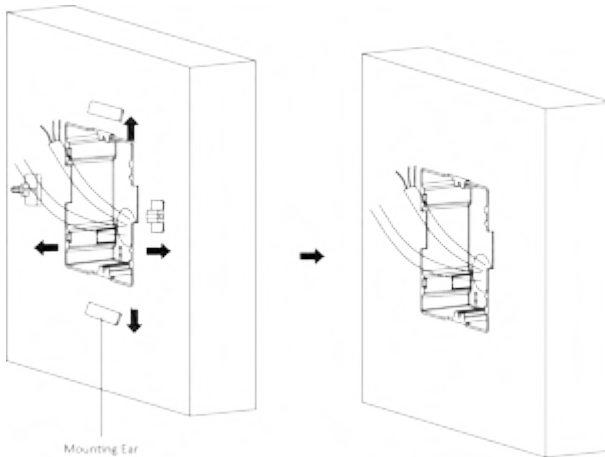

**Figure 3-12 Remove the Mounting Ears**

7. Connect the cables to the corresponding interfaces of the main unit and insert the unit into the gang box.

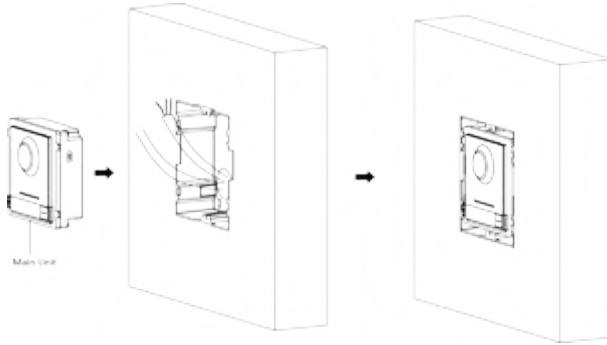

**Figure 3-13 Insert the Main Unit**

8. Fix the cover and the main unit with 2 socket head cap screws by using a hexagon wrench (supplied).

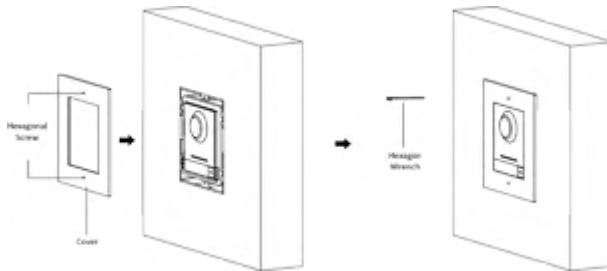

**Figure 3-14 Fix the Cover**

## 3.3 Two-Module Installation

### 3.3.1 Two-Module Surface Mounting



### Before You Start

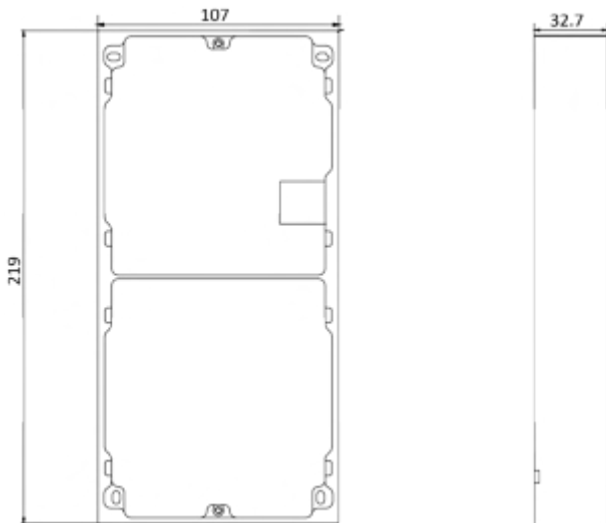

**Figure 3-15 Mounting Frame**

---

 **Note**

- The dimension of two-module mounting frame (W × H × D) is: 219 mm × 107 mm × 32.7 mm.
- The dimensions above are for reference only. The actual size can be slightly different from the theoretical dimension.

---

### Steps

1. Paste the installation Sticker 1 onto the wall. Make sure the sticker is placed horizontally via measuring with the gradienter.
2. Drill 4 holes according to the screw holes on the sticker. The suggested size of hole is 6 (diameter) × 25 (depth) mm. The suggested length of cables left outside is 270 mm.

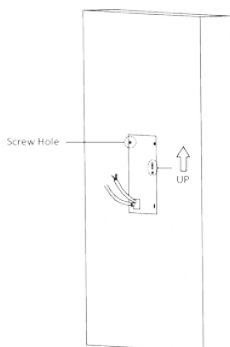

**Figure 3-16 Drill Screw Holes**

3. Remove the sticker and insert the expansion sleeves into the screw holes.
4. Fix the mounting frame onto the wall with 4 expansion bolts.

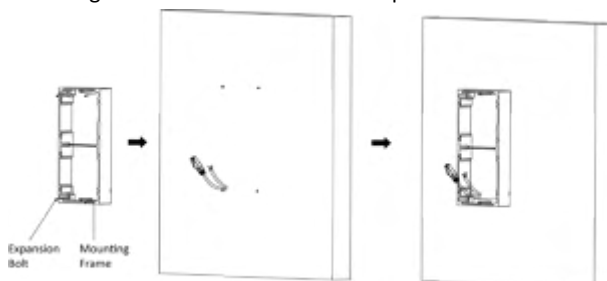

**Figure 3-17 Fix the Mounting Frame**

5. Thread the module-connecting line across the thread hole of the frame. Pass the main unit connecting lines across the thread hole to the upper grid.

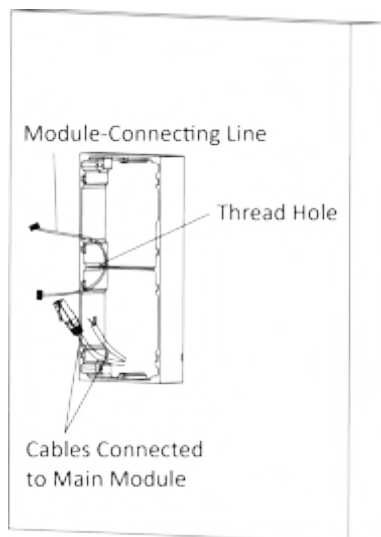

**Figure 3-18 Placement of Lines**

6. Connect the cables.
  - 1) Connect the lines and module-connecting line to the corresponding interfaces of the main unit, then place the main unit into the upper grid.
  - 2) Connect the other end of the module-connecting line to the input interface of the sub module.
  - 3) Organize the cable with cable tie in the package. The suggested cable connection picture as shown below.

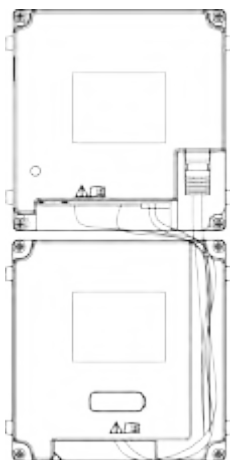

**Figure 3-19 Line Connection Effect Picture**

7. Insert the modules into the frame after wiring. The main unit must be placed in the top grid.

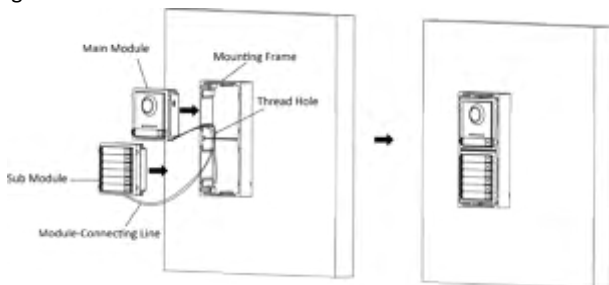

**Figure 3-20 Insert the Modules**

8. Use the hexagon wrench in the package to fix the cover onto the frame.

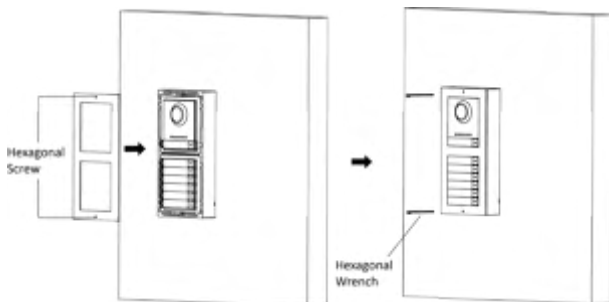

Figure 3-21 Fix the Cover

### 3.3.2 Two-Module Flush Mounting

#### Before You Start

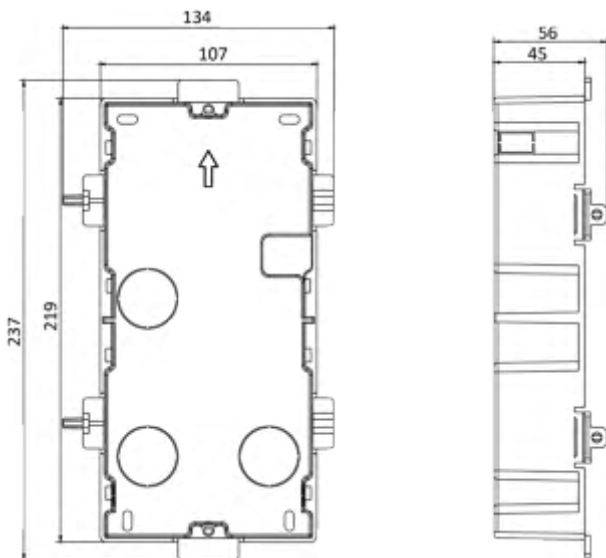

Figure 3-22 Gang Box

 **Note**

The dimension of two-module gang box is: 237 (W) × 134 (H) × 56 (D) mm. The dimension is for reference only.

---

**Steps**

1. Drill the installation hole, and pull the cable out.
- 

 **Note**

- The suggested dimension of installation hole is 220 (W) × 108 (H) × 45.5 (D) mm.
  - The suggested length of cables left outside is 270 mm.
- 

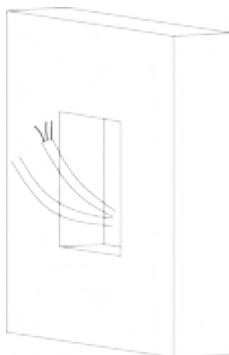

**Figure 3-23 Drill the Installation Hole**

2. Select a cable entry and remove the plastic sheet.
3. Mark the gang box screw holes on the hole.
  - 1) Route the cables through the gang box hole.
  - 2) Insert the gang box into the installation hole.
  - 3) Mark the gang box screw holes' position with a marker, and take out the gang box.

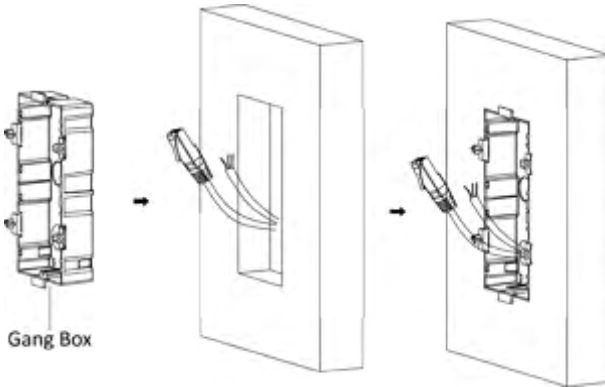

**Figure 3-24 Mark the Screw Holes**

4. Drill 4 holes according to the marks on the wall, and insert the expansion sleeves into the screw holes. The suggested size of hole is 6 (diameter) × 45 (depth) mm.
5. Fix the gang box with 4 expansion bolts.

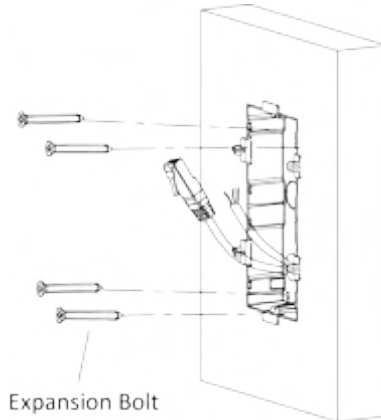

**Figure 3-25 Fix the Gang Box**

6. Fill the gap between the gang box and the wall with concrete. Remove the mounting ears with tool after concrete is dry.

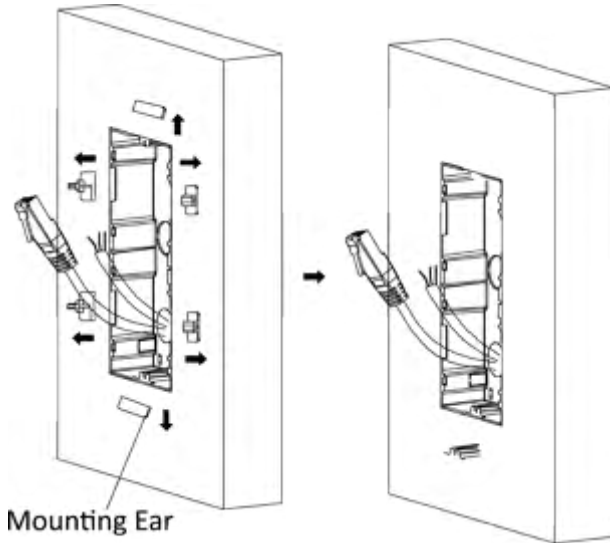

**Figure 3-26 Remove the Mounting Ears**

**7. Connect cables and insert the modules.**

- 1) Connect Cable 1 and one end of Cable 2 to the corresponding interfaces of the main unit, then insert the main unit into the upper grid.
- 2) Connect the other end of Cable 2 to the input interface of the sub module. Insert it into the lower grid.

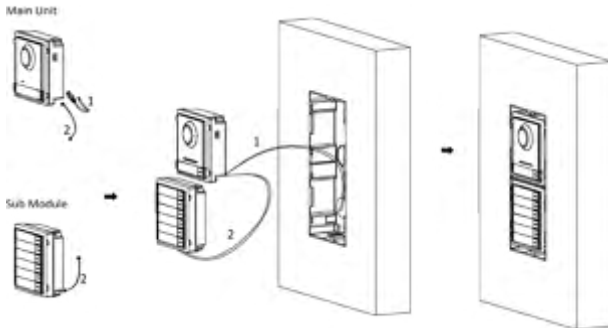

**Figure 3-27 Connect Cables and Insert the Modules**



 **Note**

Cable 1 refers to the cables pulled out from the wall that connected to the main unit. Cable 2 refers to the module-connecting line in the accessory package.

8. Fix the cover with 2 socket head cap screws by using a hexagon wrench (supplied).

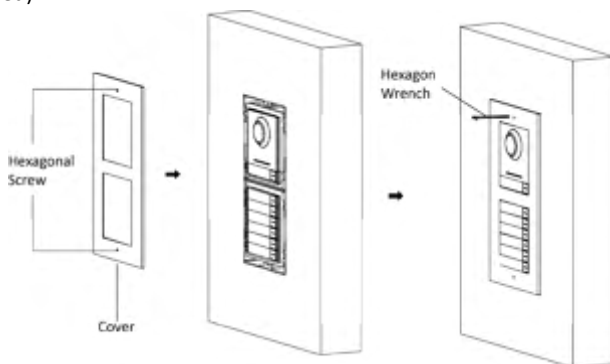

Figure 3-28 Fix the Cover

## 3.4 Three-Module Installation

### 3.4.1 Three-Module Surface Installation

#### Before You Start

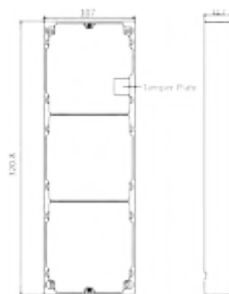

Figure 3-29 Mounting Frame

 **Note**

- The dimension of two-module mounting frame (W × H × D) is: 320.8 mm × 107 mm × 32.7 mm.
  - The dimensions above are for reference only. The actual size can be slightly different from the theoretical dimension.
- 

**Steps**

1. Paste the installation sticker 1 onto the wall. Make sure the sticker is placed horizontally via measuring with the gradienter.
2. Drill 4 holes according to the screw holes on the sticker. The suggested size of hole is 6 (diameter) × 25 (depth) mm. The suggested length of cables left outside is 270 mm.

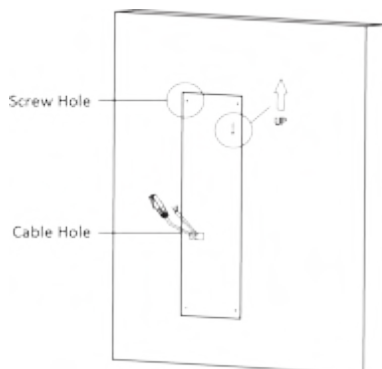

**Figure 3-30 Drill Screw Holes**

3. Remove the sticker and insert the expansion sleeves into the screw holes.
4. Fix the mounting frame onto the wall with 4 expansion bolts.

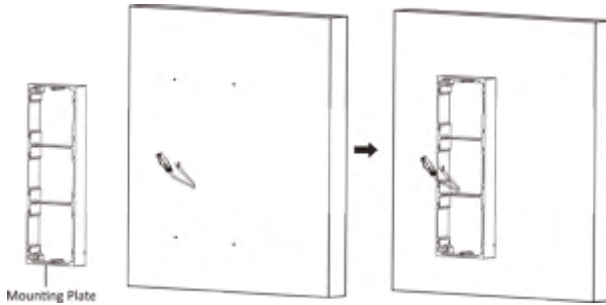
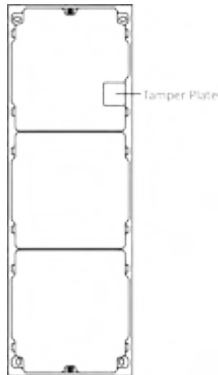

**Figure 3-31 Fix the Mounting Frame**

---

 **Note**

The mounting frame should be placed exactly as shown below for this step. The tamper plate should be at the low right of the first grid.



**Figure 3-32 Mounting Frame**

- 
5. Thread the module-connecting line across the thread holes of the frame. Pass the main unit connecting line across the thread hole to the top grid.

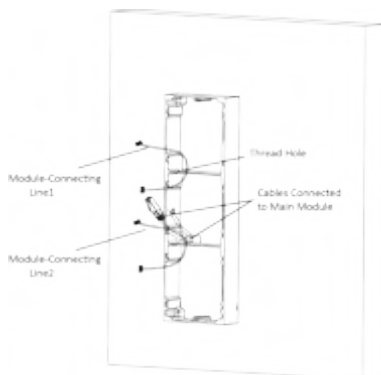

**Figure 3-33 Placement of Lines**

6. Connect the cables.
  - 1) Connect the lines and module-connecting line 1 to the corresponding interfaces of the main unit, then place the main unit into the upper grid.
  - 2) Connect the other end of the module-connecting line 1 to the input interface of the sub module. Connect two sub modules via module-connecting line 2.
  - 3) Organize the cables with cable tie in the package. The suggested cable connection picture as shown below.

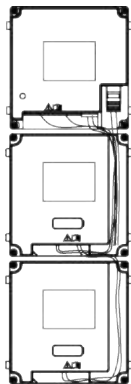

**Figure 3-34 Line Connection Effect Picture**

7. Insert the modules into the frame after wiring. The main unit must be placed in the top grid.

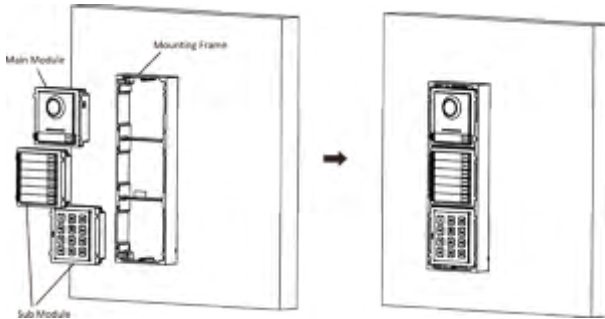

**Figure 3-35 Insert the Modules into the Frame**

8. Use the hexagon wrench in the package to fix the cover onto the frame.

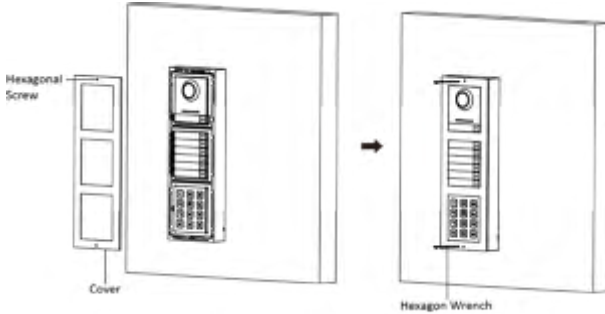

**Figure 3-36 Fix the Cover**

### 3.4.2 Three-Module Flush Mounting

### Before You Start

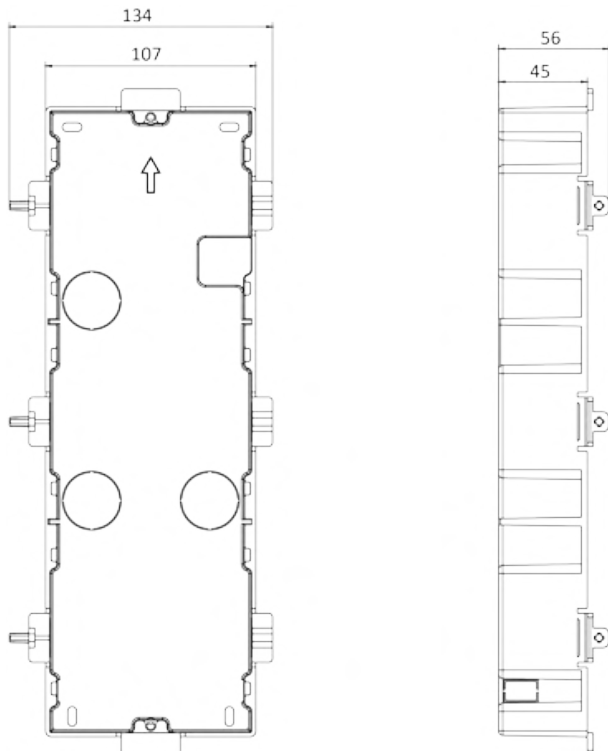

**Figure 3-37 Gang Box**

---

### Note

- The dimension of one-module gang box is: 338.8(W)×134(H)×56(D) mm.
- The dimensions above are for reference only. The actual size can be slightly different from the theoretical dimension.

---

### Steps

1. Cave the installation hole, and pull the cable out. The suggested dimension of installation hole is 321.8(W)×108(H)×45.5(D) mm. The suggested length of cables left outside is 270 mm.



**Figure 3-38** Cave the Installation Hole

2. Select a cable entry and remove the plastic sheet.
3. Mark the gang box screw holes on the wall.
  - 1) Route the cables through the gang box hole.
  - 2) Insert the gang box into the installation hole.
  - 3) Mark the gang box screw holes' position with a marker, and take out the gang box.

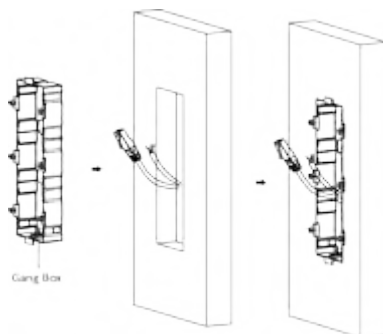

**Figure 3-39** Mark the Screw Holes

4. Drill 4 holes according to marks on the wall, and insert the expansion sleeves into the screw holes. The suggested size of hole is 6 (diameter) × 45 (depth) mm.
5. Fix the gang box with 4 expansion bolts.

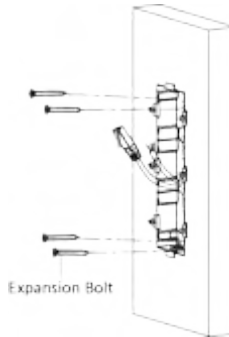

**Figure 3-40 Fix the Gang Box**

6. Fill the gap between the gang box and wall with concrete. Remove the mounting ears with tool after concrete is dry.



**Figure 3-41 Remove the Mounting Ears**

7. Connect cables and insert the modules.
  - 1) Connect Cable 1 and one end of Cable 2 to the corresponding interfaces of the main unit, then insert the main unit into the upper grid.
  - 2) Connect the other end of Cable 2 to the input interface of Sub Module 1. Connect one end of Cable 3 to the output interface of Sub Module 1 and insert it into the middle grid.
  - 3) Connect the other end of Cable 3 to the input interface of Sub Module 2. Insert it into the bottom grid.



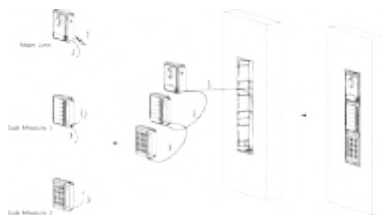

**Figure 3-42 Connect Cables and Insert Modules**

---

 **Note**

Cable 1 refers to the cables pulled out from the wall that connected to the main unit. Cable 2 and Cable 3 refer to the module-connecting line in the accessory package.

---

8. Fix the cover and the main unit with 2 socket head cap screws by using a hexagon wrench (supplied).

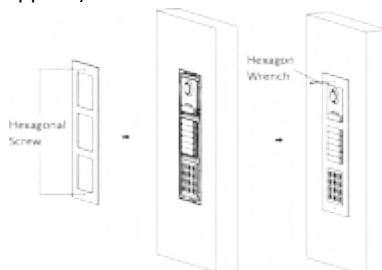
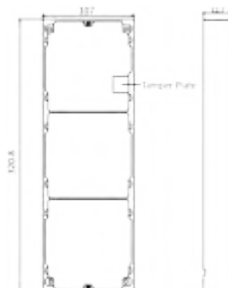

**Figure 3-43 Fix the Cover**

## 3.5 More-Than-Three Module Installation

### 3.5.1 More-than-Three Module Surface Mounting

## Before You Start



**Figure 3-44 Mounting Frame**

---

### Note

- It takes two three-module mounting frames. The dimension of three-module mounting frame (W × H × D) is: 320.8 mm × 107 mm × 32.7 mm.
- The dimensions above are for reference only. The actual size can be slightly different from the theoretical dimension.

---

### Steps

1. Paste two Sticker 1 onto the wall. Make sure the stickers are placed horizontally via measuring with the gradienter.
2. Drill 8 holes according to the screw holes on the sticker.

---

### Note

- The suggested size of hole is 6 (diameter) × 25 (depth) mm.
  - The suggested length of cables left outside is 270 mm.
- 
3. Pull out the cable through the cable hole of the left sticker.

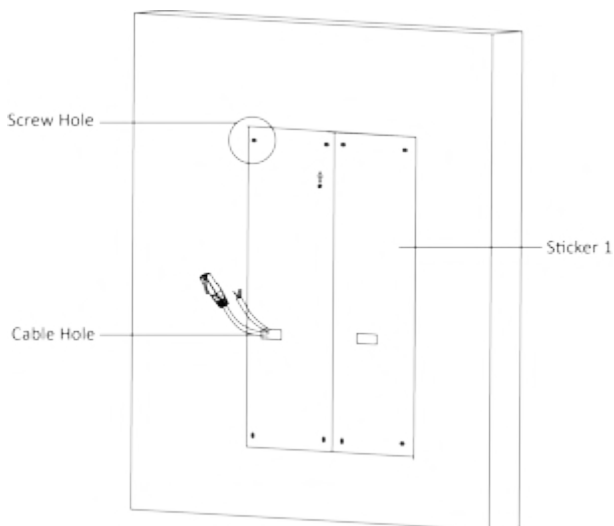

**Figure 3-45 Drill Screw Holes**

4. Remove the stickers and insert the expansion sleeves into the screw holes.
5. Thread the module-connecting line (400 mm) and grounding line across the thread hole of both frames.

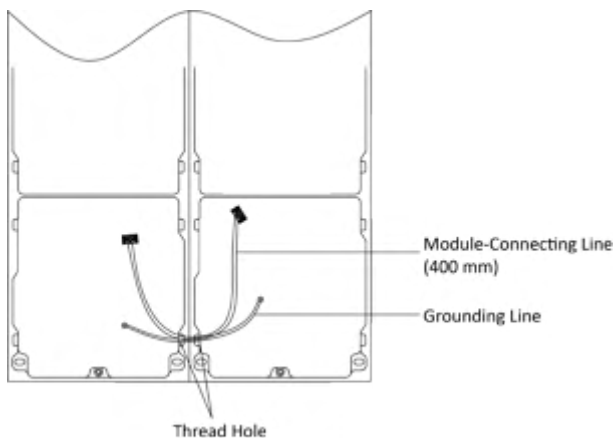
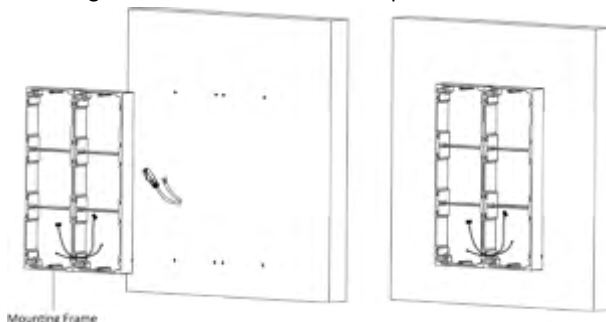

**Figure 3-46 Place the Grounding Line and Module-Connecting Line**

 **Note**

- There are 6 module-connecting lines in the package: 190 mm × 4 and 400 mm × 2.
- Take the 400 mm module-connecting line for this step.
- The green-yellow line in the package is for grounding.

6. Fix the mounting frame onto the wall with 8 expansion bolts.



**Figure 3-47 Fix the Mounting Frame**

7. Pass the main unit connecting line across the thread hole to the top grid of the left frame. Thread the module-connecting line (190 mm) across the thread hole of the frame. The lines should be placed as shown below.

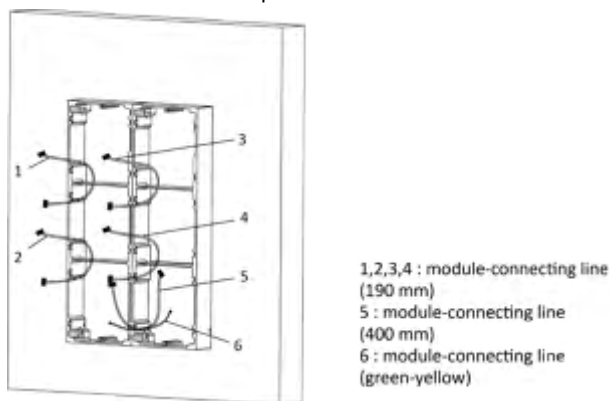

**Figure 3-48 Placement of Lines**

8. Connect the cables.

- 1) Connect the cables from the wall and module-connecting line 1 to the corresponding interfaces of the main unit, then place the main unit into the upper grid.
- 2) Connect the other end of the module-connecting line 1 to the input interface of the sub module. Connect all sub modules via module-connecting lines.
- 3) Organize the cable with cable tie in the package. The suggested cable connection picture as shown below.

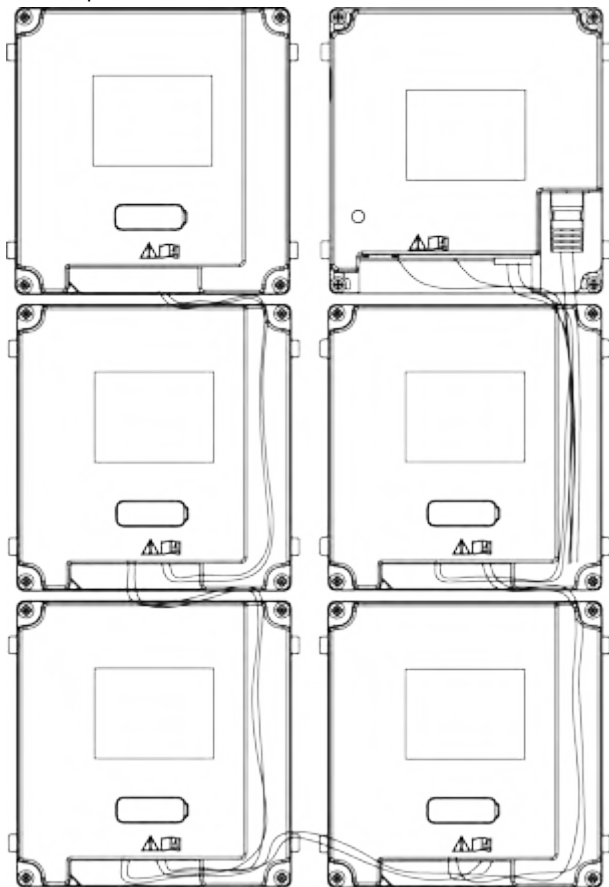

**Figure 3-49 Line Connection Effect Picture**

9. Insert the modules into the frame after wiring. The main unit must be placed in the top grid on the left.

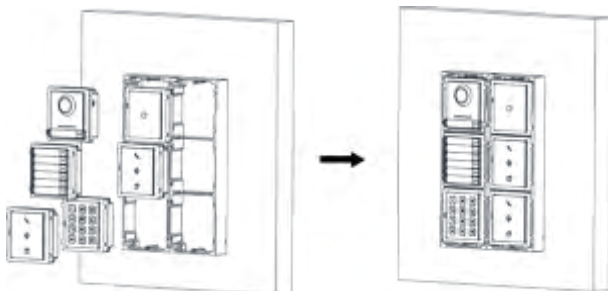

**Figure 3-50 Insert the Modules**

10. Pull the grounding line out and fixed its two end to the screw on the cover.

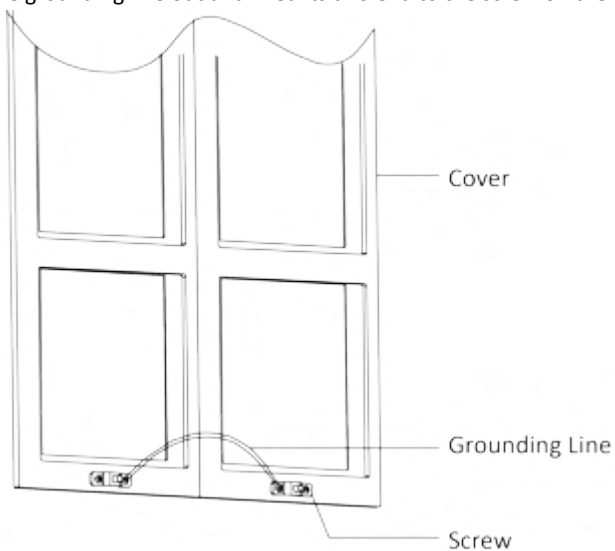

**Figure 3-51 Connect the Grounding Line to the Cover**

11. Use the hexagon wrench in the package to fix the cover onto the frame.

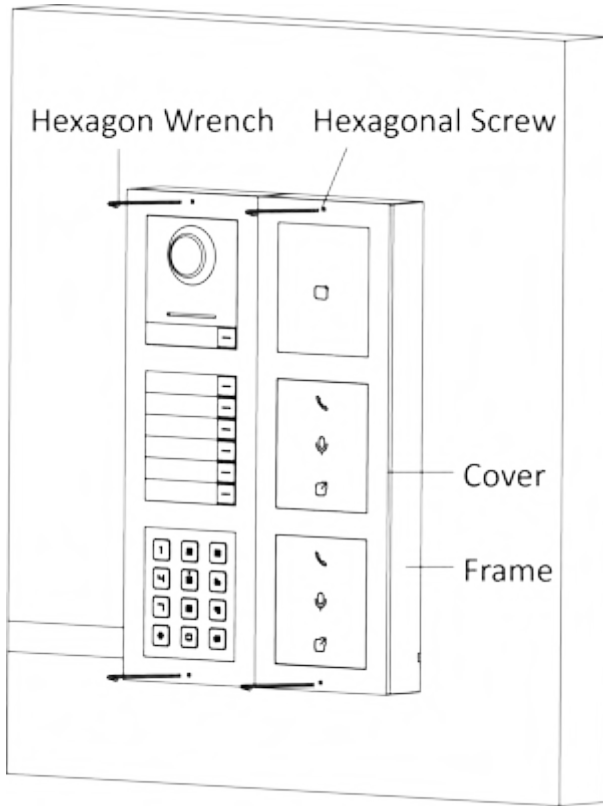
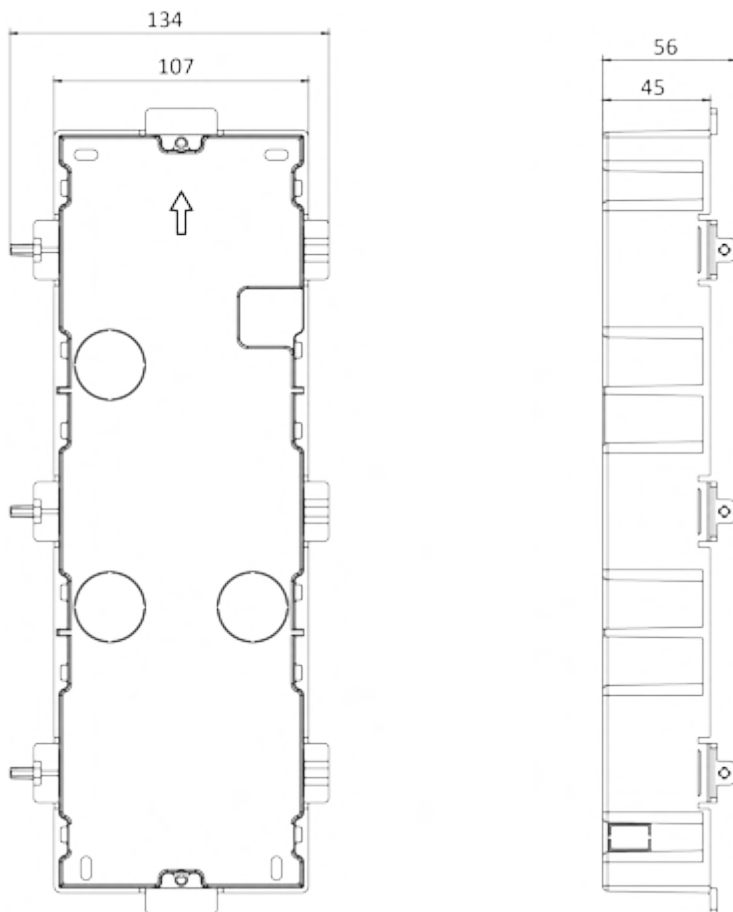

Figure 3-52 Fix the Cover

### 3.5.2 More-Than-Three Module Flush Mounting

**Before You Start**



**Figure 3-53 Gang Box**

---

 **Note**

It takes two three-module gang boxes. The dimension of the gang box is: 338.8 (W) × 134 (H) × 56 (D) mm. The dimension is for reference only.

---



**Steps**

1. Drill the installation hole, and pull the cable out. The suggested dimension of installation hole is 321.8 (W) × 315 (H) × 45.5 (D) mm. The suggested length of cables left outside is 270 mm.

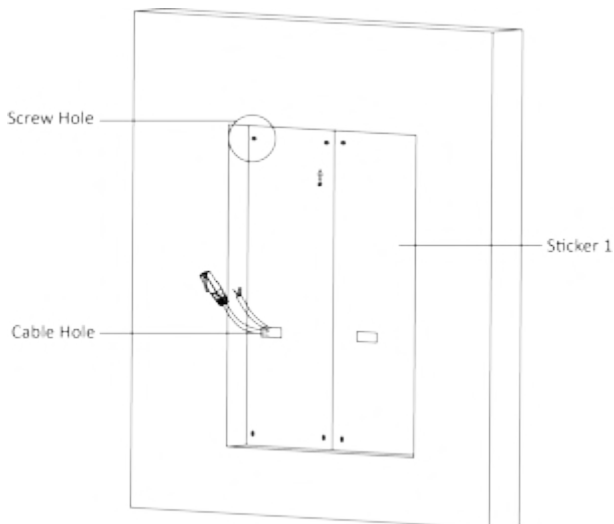

**Figure 3-54 Cave the Installation Hole**

2. Connect two gang boxes as below.

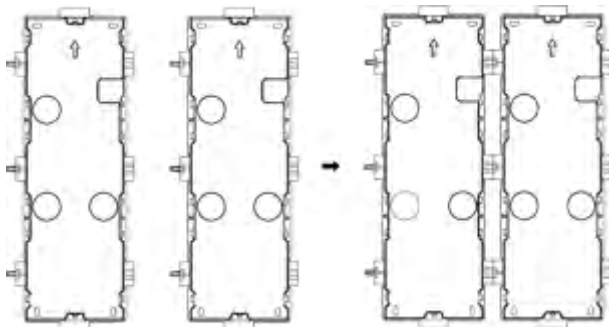

**Figure 3-55 Connect Two Gang Boxes**

3. Select a cable entry and remove the plastic sheet.

4. Remove the plastic sheets on the side of the gang boxes (shown as 1 and 2) below:

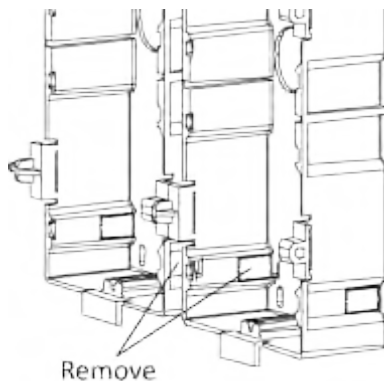

**Figure 3-56 Remove the Plastic Sheets**

5. Mark the gang box screw holes on the wall.
  - 1) Route the cables through the gang box hole.
  - 2) Insert the gang box into the installation hole.
  - 3) Mark the gang box screw holes' position with a marker, and take out the gang box.

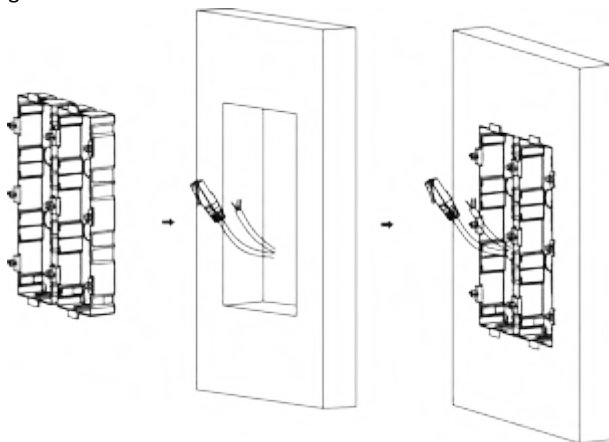

**Figure 3-57 Mark the Screw Holes**

6. Drill 8 holes according to the marks on the wall, and insert the expansion sleeves into the screw holes. The suggested size of hole is 6 (diameter) × 45 (depth) mm.
7. Fix the gang boxes with 8 expansion bolts.

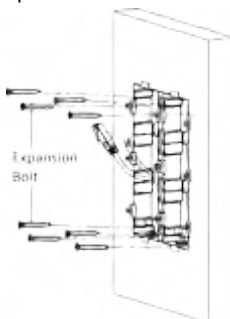

**Figure 3-58 Fix the Gang Boxes**

8. Fill the gap between the gang box and wall with concrete. Remove the mounting ears with tool after concrete is dry. Route the grounding line through the cable entries.

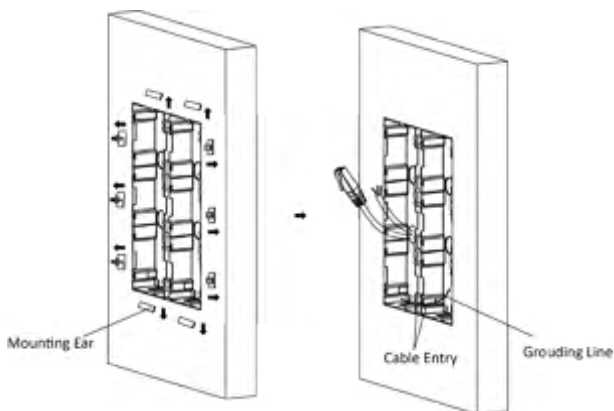

**Figure 3-59 Remove the Mounting Ears**

---

**Note**

The green-yellow line in the package is for grounding.

---

9. Connect cables and insert the modules.

- 1) Connect Cable 1 and one end of Cable 2 to the corresponding interfaces of the Main Unit, then place the Main Unit into the upper grid of the left gang box.
- 2) Connect the other end of Cable 2 to the input interface of Sub Module 1. Connect one end of Cable 3 to the output interface of Sub Module 1 and insert it into the middle grid of the left gang box.
- 3) Finish the wiring and inserting according to the cable number and the position shown as below.

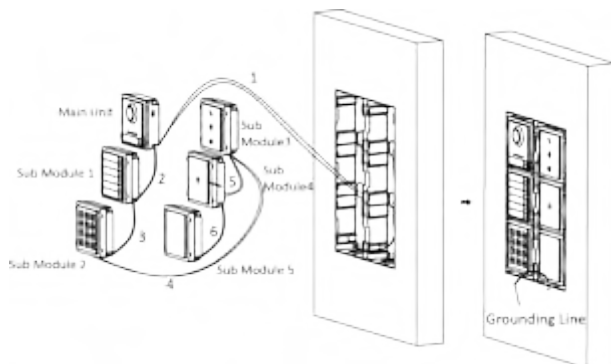

**Figure 3-60 Install Mounting Frame**

The cables connect to each module shown as below.

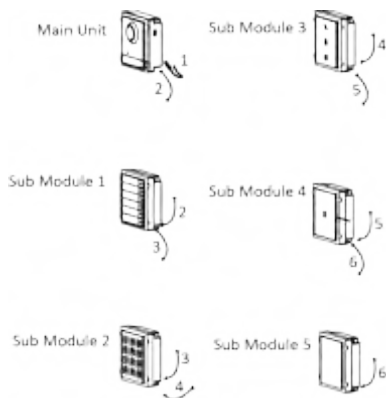
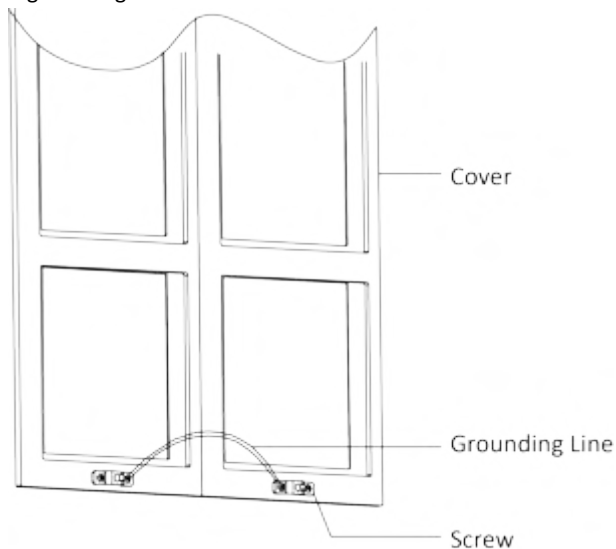

**Figure 3-61 Cables Connection**

 **Note**

- Cable 2,3,5 and 6 are the module-connecting lines (190 mm) in the package.
  - Cable 4 is the module-connecting line (400 mm) in the package.
  - Main unit must be put in the top grid.
- 

10. Pull the grounding line out and fixed its two end to the screw on the cover.



**Figure 3-62 Connect the Grounding Line to the Cover**

11. Fix the cover with 2 socket head cap screws by using a hexagon wrench (supplied).

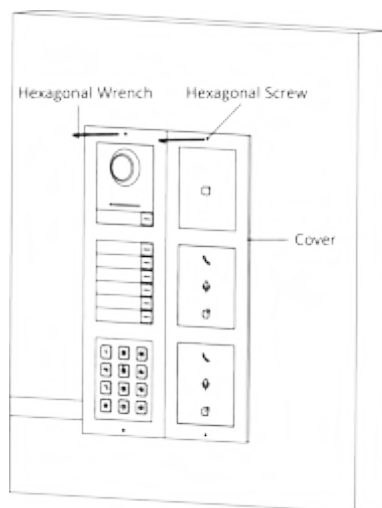

**Figure 3-63 Fix the Cover**

## 4 Activation

### 4.1 Activate Device via Client Software

You can only configure and operate the door station after creating a password for the device activation.

Default parameters of door station are as follows:

- Default IP Address: 192.0.0.65.
- Default Port No.: 8000.
- Default User Name: admin.

#### Steps

1. Run the client software, click **Maintenance and Management** → **Device Management** → **Device** to enter the page.
2. Click **Online Device**.
3. Select an inactivated device and click **Activate**.
4. Create a password, and confirm the password.

---

#### **Note**

We highly recommend you to create a strong password of your own choosing (using a minimum of 8 characters, including at least three kinds of following categories: upper case letters, lower case letters, numbers, and special characters) in order to increase the security of your product. And we recommend you change your password regularly, especially in the high security system, changing the password monthly or weekly can better protect your product.

---

5. Click **OK** to activate the device.

---

#### **Note**

- When the device is not activated, the basic operation and remote operation of device cannot be performed.
  - You can hold the **Ctrl** or **Shift** key to select multiple devices in the online devices, and click the **Activate** button to activate devices in batch.
- 

### 4.2 Edit Network Parameters

To operate and configure the device via LAN (Local Area Network), you need connect the device in the same subnet with your PC. You can edit network parameters via **iVMS-4200** client software.

### Steps

1. Select an online activated device and click the **Modify Netinfo**.
2. Edit the device IP address and gateway address to the same subnet with your computer.
3. Enter the password and click **OK** to save the network parameters modification.

---

### Note

- The default port No. is 8000.
  - The default IP address of the door station is 192.0.0.65.
  - After editing the network parameters of device, you should add the devices to the device list again.
-



## 5 Configuration via Client Software

### 5.1 Device Management

Device management includes device activation, adding device, editing device, and deleting device, and so on.

After running the iVMS-4200, video intercom devices should be added to the client software for remote configuration and management.

#### 5.1.1 Add Online Device

##### Before You Start

Make sure the device to be added is in the same subnet with your computer. Otherwise, please edit network parameters first.

##### Steps

1. Click **Online Device** to select an active online device.
2. Click **Add**.
3. Enter corresponding information, and click **Add**.

**Add** [Close]

Adding Mode  IP/Domain  IP Segment  Cloud P2P  
 EHome  HiDDNS  Batch Import

Add Offline Device

\* Name 10.6.112.48  
\* Address 10.6.112.48  
\* Port 8000  
\* User Name admin  
\* Password ••••••••

Synchronize Time   
Import to Group

ⓘ Set the device name as the group name and add all the channels connected to the device to the group.

**Add and New** **Add** Cancel

Figure 5-1 Add to the Client

### 5.1.2 Add Device by IP Address

#### Steps

1. Click **+Add** to pop up the adding devices dialog box.
2. Select **IP/Domain** as **Adding Mode**.
3. Enter corresponding information.
4. Click **Add**.

### 5.1.3 Add Device by IP Segment

You can add many devices at once whose IP addresses are among the IP segment.

#### Steps

1. Click **+Add** to pop up the dialog box.
2. Select **IP Segment** as **Adding Mode**.
3. Enter corresponding information, and click **Add**.

## 5.2 Live View via Door Station

#### Steps

1. On the main page of the client software, click **Main View** to enter the Live View page.
2. In the left list of the window, double-click the device IP or click the play icon to live view.
3. **Optional:** On the Live View page, control-click and select **Capture** to get the picture of the live view.

## 5.3 Remote Configuration

Click  to set the parameters of the device.



#### Note

Run the browser, click  → **Internet Options** → **Security** to disable the Protected Mode.

---

### 5.3.1 Device Management

You can manage the linked device on the page.

Click **Device Management** to enter the settings page.



**Figure 5-2 Device Management**

### **Add Device**

- Click **Add** to add the indoor station or sub door station. Enter the parameters and click **OK** to add.
- Click **Import**. Enter the information of the device in the template to import devices in batch.

### **Export**

Click **Export** to export the information to the PC.

### **Delete**

Select the device and click **Delete** to remove the selected device from the list.

### **Synchronize**

Click **Synchronize**, enable **Synchronize**, and click **OK** to synchronize the device list.

### **Upgrade**

#### **Upgrade Automatically**

Click **Timing Upgrade** to pop-up the settings dialog.

Enable upgrading device automatically. Edit the start time and end time and click **OK** to save the settings.

The upgrading will start at the set time automatically.

### Upgrade Manually



Click **Upload Upgrading Package** to import the upgrading package.

Click **Upgrade Now** to start upgrading.

### View Version

Put the mouse on the Upgrading button to view the upgrading version and time.

### Optional: Set Device Information.

- Click  to edit device information.
- Click  to delete device information from the list.
- Select **Status** and **Device Type** to search devices.

## 5.3.2 Local Parameters Settings

You can configure the parameters of the live view, record files and captured pictures. The record files and captured pictures are the ones you record and capture by using the web browser. You can also set and view the saving paths of the captured pictures and recorded videos on the PC that running the web browser.

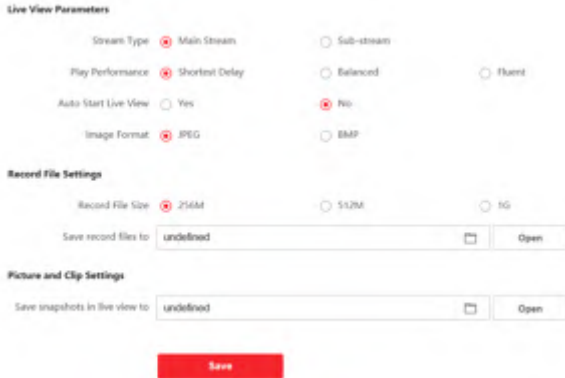

The screenshot shows a web interface for configuring local parameters. It is divided into three main sections:

- Live View Parameters:** Includes radio buttons for Stream Type (Main Stream selected, Sub-stream), Play Performance (Shortest Delay selected, Balanced, Fluent), Auto Start Live View (Yes, No selected), and Image Format (JPEG selected, BMP).
- Record File Settings:** Includes radio buttons for Record File Size (256M selected, 512M, 1G) and a text input field for 'Save record files to' with an 'Open' button.
- Picture and Clip Settings:** Includes a text input field for 'Save snapshots in live view to' with an 'Open' button.

A red 'Save' button is located at the bottom of the form.

Figure 5-3 Local Parameters

### Live View Parameters

#### Stream Type

Set the stream type as **Main Stream** or **Sub-stream**.

### **Play Performance**

Set the live view performance to **Shortest Delay**, **Balanced** or **Fluent**.

### **Auto Start Live View**

Check **Yes** to enable the function.

### **Image Format**

Select the image format for picture capture.

Click **Save** to enable the settings.

### **Record File Parameters**

#### **Record File Size**

Select the packed size of the manually recorded and downloaded video files to **256M**, **512M** or **1G**. After the selection, the maximum record file size is the value you selected.

#### **Save record files to**

Set the saving path for the manually recorded video files.

Click **Save** to enable the settings.

### **Picture and Clip Settings**

#### **Save snapshots in live view to**

Set the saving path of the manually captured pictures in live view mode.

---

#### **Note**

You can click **Browse** to change the directory for saving the clips and pictures, and click **Open** to open the set folder of clips and picture saving.

---

Click **Save** to enable the settings.

### **5.3.3 System Settings**

Follow the instructions below to configure the system settings, include System Settings, Maintenance, Security, and User Management, etc.

Click **System** to enter the settings page.

## Basic Information

Click **System Settings** → **Basic Information** to enter the settings page. On the page, you can edit **Device Name** and **Device No.** Set the **Language** and **System Type** according to your needs.

Click **Save** to enable the settings.

## Time Settings

Click **System Settings** → **Time Settings** to enter the settings page. Select the **Time Zone** of your location from the drop-down list.

- Enable **NTP**, set the **Server Address**, **NTP Port** and **Interval**.
- Enable **Manual Time Sync.**, set the time manually or check the **Sync. with computer time**.

Click **Save** to enable the settings.

## DST

Click **System Settings** → **DST** to check **Enable DST**. Set the parameters according to your needs and click **Save** to enable the settings.

## About

Click **System Settings** → **About** to enter the page. Click **View Licenses** to view open source software Licenses.

## Maintenance

Click **Maintenance** → **Upgrade & Maintenance** to enter the settings page.



**Figure 5-4 Maintenance**

- **Reboot**: Click **Reboot** to reboot the device.
- **Default**  
Click **Default** to restore all parameters to default settings.
- **Restore All**  
Click **Restore All** to reset all the parameters, except the IP parameters and user information, to the default settings.
- **Export parameters**:
  1. Select **Device Parameters**, and click **Export** to pop up the dialog box.
  2. Set and confirm the encryption password.
  3. Click **OK** to export parameters.
- **Import Config. File**:
  1. Click browse icon to select the configuration file.
  2. Click **Import** and enter the encryption password to import.
- **Upgrade**:
  1. Click browse icon to select the upgrade file.
  2. Click **Upgrade**.

---

 **Note**

- The upgrading process will last 1 to 10 minutes, do not power off during the upgrading. The device reboots automatically after upgrading.
  - You can select controller, display module and sub modules to upgrade.
-



### Authentication

Click **Security** → **Authentication** to enter the settings page. On the page, you can select **RTSP Authentication** according to your actual needs.

Click **Save** to enable the settings.

### Security Service

Click **Security** → **Security Service** to enter the settings page. On the page, you can enable SSH according to your actual needs.

Click **Save** to enable the settings.

### User Management

Click **User Management** to enter the settings page.

Administrator can edit the permission for the users.

---

#### Note

We highly recommend you to create a strong password of your own choosing (using a minimum of 8 characters, including at least three kinds of following categories: upper case letters, lower case letters, numbers, and special characters) in order to increase the security of your product. And we recommend you change your password regularly, especially in the high security system, changing the password monthly or weekly can better protect your product.

---

### Online Users

Click **User Management** → **Online Users** to enter the page.



ID	User Name	Role	Last Login Time	View Operations Time
1	admin	Administrator	2021-12-20	2021-12-27 14:02:21
2	admin	Administrator	2021-12-20	2021-12-27 14:02:21

Figure 5-5 Online Users

Click **Refresh** to get the present information.

## Arming/Disarming Information

Click **User Management** → **Arming/Disarming Information** to view the information. Click **Refresh** to get the present information.

### 5.3.4 Network Settings

#### TCP/IP Settings

TCP/IP settings must be properly configured before you operate the device over network. The device supports IPv4.

##### Steps

1. Click **Network** → **Basic Settings** → **TCP/IP** to enter the settings page.

DHCP

IPv4 Address

IPv4 Subnet Mask

IPv4 Default Gateway

Mac Address

MTU

**DNS Server**

Preferred DNS Server

Alternate DNS Server

Figure 5-6 TCP/IP Settings

2. Configure the network parameters.
  - Check **DHCP**, the device will get the parameters automatically.

- Set the **IPv4 Address**, **IPv4 Subnet Mask** and **IPv4 Default Gateway** manually.
3. Configure the corresponding DNS server parameters.
  4. Click **Save** to enable the settings.

## Port Settings

### Steps

1. Click **Network** → **Basic Settings** → **Port** to enter the settings page.

The screenshot shows a settings page with four input fields and a Save button. The fields are labeled as follows:

HTTP Port	80
RTSP Port	554
HTTPS Port	443
Server Port	8000

Below the fields is a red button labeled "Save".

**Figure 5-7 Port Settings**

2. Set the ports of the device.

#### **HTTP Port**

The default port number is 80, and it can be changed to any port No. which is not occupied.

#### **HTTPS Port**

The default port number is 443, and it can be changed to any port No. which is not occupied.

#### **RTSP Port**

The default port number is 554.

#### **Server Port**

The default server port number is 8000, and it can be changed to any port No. ranges from 2000 to 65535.

3. Click **Save** to enable the settings.

## SIP Setting

### Steps

1. Click **Network** → **Basic Settings** → **SIP** to enter the settings page.

Enable VOIP Gateway

Register User Name

Registration Password

Server Address

Server Port

Expiry Time  minutes

Register Status

Number

Display User Name

**Figure 5-8 SIP Settings**

2. Check **Enable VOIP Gateway**.
3. Configure the SIP parameters.
4. Click **Save** to enable the settings.

### FTP Settings

#### Steps

1. Click **Network** → **Advanced** → **FTP** to enter the settings page.

Enable FTP

Server Type

Server IP Address

Port

Enable Anonymous

User Name

Password

Directory Structure

Parent Directory

Child Directory

**Picture Naming Rules**

Delimiter

Named Item

Named Element

**Save**

Figure 5-9 FTP Settings

2. Check **Enable FTP**.
3. Select **Server Type**.
4. Input the **Server IP Address** and **Port**.
5. Configure the FTP Settings, and the user name and password are required for the server login.
6. Set the **Directory Structure**, **Parent Directory** and **Child Directory**.
7. Set the picture naming rules.
8. Click **Save** to enable the settings.

### 5.3.5 Video & Audio Settings

#### Video Parameters

##### Steps

1. Click **Video/Audio** → **Video** to enter the settings page.

Stream Type	Main Stream	
Video Type	Video&Audio	
Resolution	1280*720P	
Bitrate Type	Variable	
Video Quality	Medium	
Frame Rate	25	fps
Max. Bitrate	2048	Kbps
Video Encoding	H.264	
I Frame Interval	50	

Save

Figure 5-10 Video Parameters

2. Select the **Stream Type**.
3. Configure the video parameters.

##### **Stream Type**

Select the stream type to main stream or sub stream.

##### **Video Type**

Select the stream type to video stream, or video & audio composite stream.  
The audio signal will be recorded only when the **Video Type** is **Video & Audio**.

##### **Resolution**

Select the resolution of the video output.

##### **Bitrate Type**

Select the bitrate type to constant or variable.

##### **Video Quality**

When bitrate type is selected as Variable, 6 levels of video quality are selectable.

### Frame Rate

Set the frame rate. The frame rate is to describe the frequency at which the video stream is updated and it is measured by frames per second (fps). A higher frame rate is advantageous when there is movement in the video stream, as it maintains image quality throughout.

### Max. Bitrate

Set the max. bitrate from 32 to 16384 Kbps. The higher value corresponds to the higher video quality, but the better bandwidth is required.

### Video Encoding

The device supports H.264.

### I Frame Interval

Set I Frame Interval from 1 to 400.

4. Click **Save** to save the settings.

## Audio Parameters

### Steps

1. Click **Video/Audio** → **Audio** to enter the settings page.

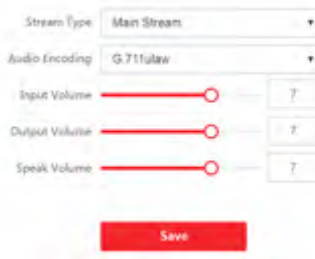

**Figure 5-11 Audio Settings**

2. Configure the stream type and the audio encoding type.

### Stream Type

Select the stream type to main stream or sub stream.

### Audio Encoding

The device support G.711ulaw and G.711 alaw.

3. Adjust the **Input Volume**, **Output Volume** and **Speak Volume**.

 **Note**

Available range of volume: 0 to 10.

4. Click **Save** to save the settings.

### 5.3.6 Image Settings

#### Display Settings

Configure the image adjustment, backlight settings and other parameters in display settings.

#### Steps

1. Click **Image** → **Display Settings** to enter the display settings page.



**Figure 5-12 Display Settings**

2. Select the **Format**.
3. Set the display parameters.

#### **WDR**

Wide Dynamic Range can be used when there is a high contrast of the bright area and the dark area of the scene.

#### **Brightness**

Brightness describes bright of the image, which ranges from 1 to 100.

#### **Contrast**

Contrast describes the contrast of the image, which ranges from 1 to 100.



### Saturation

Saturation describes the colorfulness of the image color, which ranges from 1 to 100.

### Sharpness

Sharpness describes the edge contrast of the image, which ranges from 1 to 100.

#### 4. Set the **Day/Night Mode**.

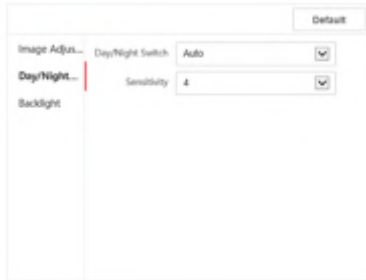

**Figure 5-13 Day/Night Mode**

- Set **Day Mode** or **Night Mode** manually.
- Set the mode as **Auto** and edit the sensitivity according to your needs.
- Set the mode as **Scheduled-Switch**. Set the start time and end time.

---

#### **Note**

Daytime is from configured start time to configured time. The rest of the time is set as night by default.

---

#### 5. Set the backlight parameters.

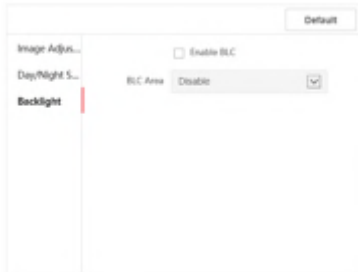

**Figure 5-14 Backlight**

- 1) Check the checkbox to enable BLC.
  - 2) Select **BLC Area**.
6. Click **Save** to enable the settings.

## OSD Settings



You can customize the camera name, time/date format, display mode, and OSD size displayed on the live view.

### Steps

1. Click **Image** → **OSD Settings** to enter the settings page.
2. Check the corresponding checkbox to select the display of camera name, date or week if required.
3. Edit the **Camera Name**.
4. Select from the drop-down list to set the **Time Format** and **Date Format**.
5. Adjust the OSD position.
6. Click **Save** to enable the settings.

## Target Cropping

### Steps

1. Click **Image** → **Crop** to enter the page.
2. Check **Enable Target Cropping** to enable the function.
3. Click  to crop photo.
4. Click  to crop video.
5. Select **Cropping Resolution**.
6. Click **Save**.

---

### Note

- You can select **Cropping Resolution** as **704\*576**, **1280\*720**, or **1920\*1080**.
  - You can zoom in or zoom out the image by selecting **Cropping Resolution** after clicking **Save**.
- 

## 5.3.7 Schedule Settings

You can create call schedule, or else the device will call indoor station all day by default.

### Steps

1. Click **Schedule** → **Video Intercom** → **Call Schedule** .
2. Click the next row below **Enable Indoor Station All Day by Default**.
3. Enter **Schedule Name**.
4. Select **Call Type**.
5. Set **Weekly Schedule**.
  - 1) Click **Weekly Schedule**.

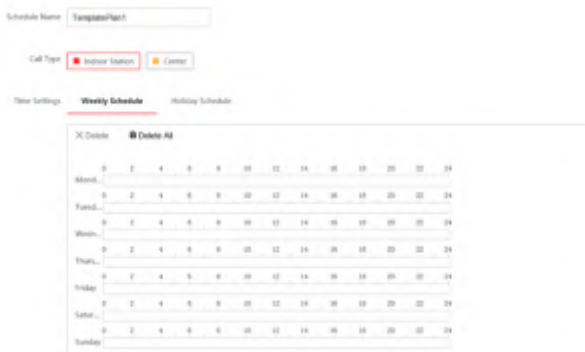

**Figure 5-15 Weekly Schedule**

- 2) Drag mouse to set the schedule according to the actual needs.
- 3) **Optional:** Click the copy icon to copy the schedule to other days according to the actual needs.
- 4) Click **Save**.
6. Set **Holiday Schedule**.
  - 1) Click **Holiday Schedule**.

Screenshot of the Holiday Schedule configuration interface. The interface includes a 'Schedule Name' field with the value 'Template/Plan 1', a 'Call Type' dropdown menu with 'Indoor Station' selected, and 'Time Settings' tabs for 'Weekly Schedule' and 'Holiday Schedule'. The 'Holiday Schedule' tab is active, showing an empty table with columns: No., Start Time, End Time, Time Period, and Operation. There are '+ Add' and 'Clear' buttons above the table.

**Figure 5-16 Holiday Schedule**

- 2) Click **Add**.
- 3) Set **Start Time** and **End Time**.
- 4) Select **Call Type**.
- 5) Drag mouse to set the schedule according to the actual needs.
- 6) Click **OK**.
- 7) You can edit or delete the schedule according to the actual needs.
- 8) Click **Save**.

---

 **Note**

The holiday schedule have higher priority than weekly schedule when you set the two schedule at the same time.

---

### 5.3.8 Intercom Settings

#### Device No. Settings

##### Steps

1. Click **Device No.** to enter the page.

The screenshot shows a configuration form for a door station. It has the following fields and values:

- Device Type: Villa Door Station (dropdown menu)
- Building No.: 1 (text input)
- Floor No.: 1 (dropdown menu)
- Door Station No.: 0 (text input)
- Advanced Settings: (expanded section)
- Community No.: 1 (text input)
- Unit No.: 1 (text input)
- Save: (red button)

**Figure 5-17 Device No. Settings**

2. Select the device type from the drop-down list, and set the corresponding information including **Building No.**, **Floor No.**, **Door Station No.**, **Community No.** and **Unit No.**

---

 **Note**

When you select **Outer Door Station** as **Device Type**, only **Outer Door Station No.** and **Community No.** can be set.

---

3. Click **Save** to enable the device number configuration.

---

 **Note**

- For main door station (D series or V series), the No. is 0.
  - For sub door station (D series or V series), the No. cannot be 0. The No. of sub door station ranges from 1 to 99.
  - For each villa or building, at least one main door station (D series or V series) should be configured, and one sub door stations (D series or V series) can be customized.
  - For one main door station (D series or V series), up to 8 sub door stations can be configured.
- 

## Linked Network Settings

### Steps

1. Go to **Intercom** → **Session Settings** to enter the settings page.
2. Set **Register Number** and **Registration Password**.

3. Set **Main Station IP** and **VideoIntercom Server IP**.
4. Enable Protocol 1.0.
5. Click **Save** to enable the settings.

## Time Parameters

Go to **Intercom** → **Time Parameters** to enter the page.

Configure **Max. Call Duration**, **Max. Message Duration**, **Max. Ring Duration**, and click **Save**.



### Note

- Max. call duration between the module indoor station and client ranges from 90 s to 120 s. The call will end automatically when the actual calling duration is longer than the configured one.
  - Max. message duration ranges from 30 s to 60 s. The message will end automatically when the actual message duration is longer than the configured one.
  - Max. ring duration refers to the maximum duration of the module indoor station when it is called without being accepted. Max. ring duration ranges from 65 s to 255 s.
- 

## Ring-Back Tone Settings

Click **Intercom** → **Ringbacktone Settings** to enter the settings page.

Click **Add** to select the ring tone from PC.



### Note

Available Audio Format: WAV、AAC、Size: Less than 600 KB, Sample Rate: 8000Hz, Mono.

---

## Press Button to Call

### Steps

1. Go to **Intercom** → **Press Button to Call** to enter the settings page.



**Figure 5-18 Press Button to Call**

2. Edit room No. in the button settings and select **Link Time Schedule**.

 **Note**

- The number of buttons may vary with different models. Please refer to the actual product.
- The schedule settings refers to **Schedule Settings** for details.

3. Click **Save** to enable the settings.

## Input and Output

Go to **Intercom** → **I/O Settings** to enter the settings page.



**Figure 5-19 IO Input and Output**

Select **I/O Input No.**, **Input**, **I/O Output No.** and **Output**.

Click **Save** to enable the settings.

 **Note**

- I/O Input supports 4-channel inputs.

**Table 5-1 I/O Input**

I/O Input No.	Input
1	Door Status
2	Disable/Door Status
3	Exit Button
4	Disable/Exit Button

- I/O Output supports 2-channel outputs.

**Table 5-2 I/O Output**

I/O Output No.	Output
1	Electric Lock
2	Disable/Electric Lock

---

## Sub Module Configuration

### Steps

1. Click **Intercom** → **Sub Module Configuration** , and you can view the sub module information, including No., module type, status, and version.
2. Click  to edit the sub module.

#### Display Module

 Slide to adjust **Screen Backlight Brightness**.

 Slide **Enable Buzzer** to enable the function.

#### Touch-Display Module

 Slide to adjust **Screen Backlight Brightness**.

 Slide **Enable Buzzer** to enable the function.

 Select **Address Book Display Mode** according to actual needs.

 Enable **Homepage Shortcut Dial**, you can tap contact on the main page to call.

 Click **Add** to add custom buttons.



 **Note**

- The module address is used to differentiate the sub modules. See *Configure Sub Module Address* for detailed configuration instructions.
  - For the other sub modules (indicator module, keypad module and card reader module), it prompts **Not supported**.
  - The room No. for the main unit's call button is 1 by default; and the room No. for the nametag modules call buttons are 2 to 7 by default.
- 

## Number Settings

### Steps

1. Click **Intercom** → **Number Settings** , and you can view the No., room No., and SIP number.
2. Add the number.
  - 1) Click **Add**.
  - 2) Enter **Room No.**, and **SIP**.
  - 3) **Optional**: Click **Add** to add SIP according to the actual needs.
  - 4) Click **OK**.
3. **Optional**: Click  to edit the number.

## 5.3.9 Access Control Settings

### Permission Password

#### Steps

1. Click **Access Control** → **Password Settings** to enter the settings page.

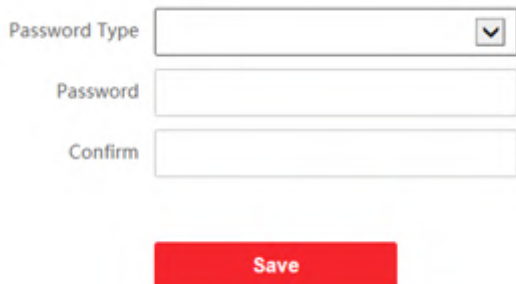

The screenshot shows a form for password settings. It includes a dropdown menu for 'Password Type', two text input fields for 'Password' and 'Confirm', and a red 'Save' button at the bottom.

**Figure 5-20 Password Settings**

2. Select **Password Type**.
3. Enter and confirm the password.
4. Click **Save** to enable the settings.

## Door Parameters

### Steps

1. Click **Access Control** → **Door Parameters** to enter the settings page.

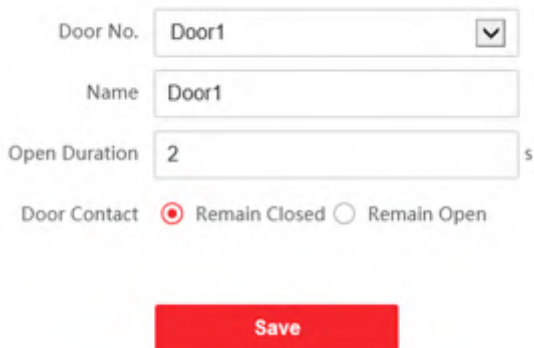

The screenshot shows a form for door parameters. It includes a dropdown menu for 'Door No.' (set to 'Door1'), a text input field for 'Name' (set to 'Door1'), a text input field for 'Open Duration' (set to '2' with a 's' suffix), and radio buttons for 'Door Contact' (selected 'Remain Closed', unselected 'Remain Open'). A red 'Save' button is at the bottom.

**Figure 5-21 Door Parameters**

2. Select the door and edit the door name.
3. Edit **Open Duration**.

4. Set door contact status.
5. Click **Save** to enable the settings.

## **Card Security**

Click **Access Control** → **Card Security** to enter the settings page.

Slide to enable card encryption parameters.

Click **Save** to enable the settings.

## **Elevator Control**

### **Before You Start**

Make sure that the door station is in the mode of main door station. Only the main door station supports elevator control function.

### **Steps**

1. Click **Access Control** → **Elevator Control Parameter** to enter the settings page.

Enable elevator control

Elevator No.

Elevator Controller Type

Interface Type

Negative Floor Capacity

Alarm Receiver Type

Server IP Address

Port

User Name

Password

**Save**

**Figure 5-22 Elevator Control**

2. Check to enable elevator control function.
3. Select an Elevator No., and select an elevator controller type for the elevator.
4. Select **Interface Type**.
5. Enter **Negative Floor Capacity**, and select **Alarm Receiver Type**.
6. Enter the elevator controller's **Server IP Address**, **Port No.**, **User Name**, and **Password**.
7. Click **Save** to enable the settings.

---

 **Note**

- Up to 4 elevator controllers can be connected to one door station.
  - Up to 10 negative floors can be added.
  - Make sure the interface types of elevator controllers, which are connected to the same door station are consistent.
-

### 5.3.10 Theme Settings

Set the advertisement on the main page of the device.

#### Steps

1. Click **Configuration** → **Theme** to enter the settings page.
2. Check to enable screen saving function.
3. Set the advertisement theme.
  - 1) Click **+ Add Theme**.
  - 2) Create a theme name, and select the advertisement body as **picture** or **Video**.
  - 3) Click **Save**.
4. Click **+** to select a picture from the local as the material to be played in standby, and click **upload**.
5. Set the play schedule.
  - 1) Select a theme and drag the time interval to be played on the timeline.
  - 2) **Optional**: Click the drawn area to edit the time manually.
  - 3) Click **Delete** to delete the selected area. Click **Delete All** to delete all selected areas.
6. Adjust **Slide Show Interval**.

Drag the block or enter the number to set the slide show interval. The picture will be changed according to the interval.
7. **Optional**: Slide to enable show custom content and edit custom content.

The custom content displays on the main page of the device.
8. Click **Save**.

## 5.4 Organization Management

On the main page of the Client Software, click  **PersonalManagement** to enter the configuration page.

### 5.4.1 Add Organization

### Steps

1. In the organization list on the left, click **+Add**.
2. Enter the **Organization Name** as desired.
3. Click **OK** to save the adding.
4. **Optional:** You can add multiple levels of organizations according to the actual needs.
  - 1) You can add multiple levels of organizations according to the actual needs.
  - 2) Then the added organization will be the sub-organization of the upper-level organization.

---

 **Note**

Up to 10 levels of organizations can be created.

---

## 5.4.2 Modify and Delete Organization

You can select the added organization and click  to modify its name.

You can select an organization, and click **X** button to delete it.

---

 **Note**

- The lower-level organizations will be deleted as well if you delete an organization.
  - Make sure there is no person added under the organization, or the organization cannot be deleted.
- 

## 5.5 Person Management

After adding the organization, you can add person to the organization and manage the added person such as issuing cards in batch, importing and exporting person's information in batch, etc.

---

 **Note**

- Up to 2,000 persons can be added.
  - Up to 5 cards can be added to each person.
- 

### 5.5.1 Add Person

Person information is necessary for the video intercom system. And when you set linked device for the person, the intercom between intercom devices can be realized.

### Steps

1. Select an organization in the organization list and click **Add** on the Person panel to pop up the adding person dialog.

---

 **Note**

The Person No. will be generated automatically and is editable.

---

2. Set basic person information.
  - 1) Enter basic information: name, gender, tel, birthday details, effective period and email address.

---

 **Note**

The length of person name should be less than 15 characters.

---

- 2) Click **Add** face to upload the photo.

---

 **Note**

The picture should be in \*.jpg format.

---

- |                                |   |
|--------------------------------|---|
| <b>Click Upload</b>            | Select the person picture from the local PC to upload it to the client. |
| <b>Click Take Phone</b>        | Take the person's photo with the PC camera.                             |
| <b>Click Remote Collection</b> | Take the person's photo with the collection device.                     |

3. Issue the card for the person.
  - 1) Click **Credential** → **Card** .
  - 2) Click **+** to pop up the Add Card dialog.
  - 3) Select **Normal Card** as **Card Type**.
  - 4) Enter the **Card No.**
  - 5) Click **Read** and the card(s) will be issued to the person.
4. Link the device to the person.
  - 1) Set the linked devices.

**Linked Device**

You can bind the indoor station to the person.

 **Note**

If you select **Analog Indoor Station** in the Linked Device, the **Door Station** field will display and you are required to select the door station to communicate with the analog indoor station.

---

**Room No.**

You can enter the room No. of the person.

- 2) Click **OK** to save the settings.
5. Click **Add** to save the settings.

### 5.5.2 Modify and Delete Person

Select the person and click **Edit** to open the editing person dialog.

To delete the person, select a person and click **Delete** to delete it.

---

 **Note**

If a card is issued to the current person, the linkage will be invalid after the person is deleted.

---

### 5.5.3 Import and Export Person Information

The person information can be imported and exported in batch.

**Steps**

1. Exporting Person: You can export the added persons' information in Excel format to the local PC.
  - 1) After adding the person, you can click **Export Person** to pop up the following dialog.
  - 2) Click ... to select the path of saving the exported Excel file.
  - 3) Check the checkboxes to select the person information to export.
  - 4) Click **OK** to start exporting.
2. Importing Person: You can import the Excel file with persons information in batch from the local PC.
  - 1) Click **Import Person**.
  - 2) You can click **Download Template for Importing Person** to download the template first.
  - 3) Input the person information to the downloaded template.



- 4) Click ... to select the Excel file with person information.
- 5) Click **OK** to start importing.

### 5.5.4 Get Person Information from Device

If the added device has been configured with person information (including person details, fingerprint, issued card information), you can get the person information from the device and import to the client for further operation.

#### Steps

---

##### **Note**

This function is only supported by the device the connection method of which is TCP/IP when adding the device.

---

1. In the organization list on the left, click to select an organization to import the persons.
  2. Click **Get from Device** to pop up the dialog box.
  3. The added device will be displayed.
  4. Click to select the device and then click **Get** to start getting the person information from the device.
- 

##### **Note**

- The person information, including person details, person's fingerprint information (if configured), and the linked card (if configured), will be imported to the selected organization.
  - If the person name stored in the device is empty, the person name will be filled with the issued card No. after importing to the client.
  - The gender of the persons will be **Male** by default.
- 

### 5.5.5 Change Person to Other Organization

You can move the person to another organization if needed.

#### Steps

1. Select the person in the list and click **Change Organization**.
2. Select the organization to move the person to.
3. Click **OK** to save the settings.

## 5.5.6 Issue Card in Batch

You can issue multiple cards for the person with no card issued in batch.

### Steps

1. Click **Batch Issue Cards** to enter the dialog page. All the added person with no card issued will display in the Person(s) with No Card Issued list.

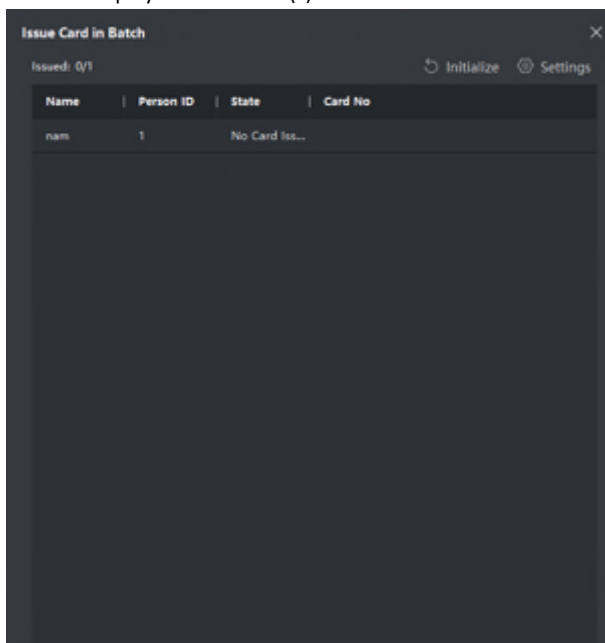

Figure 5-23 Issue Card in Batch

2. Click **Settings**.

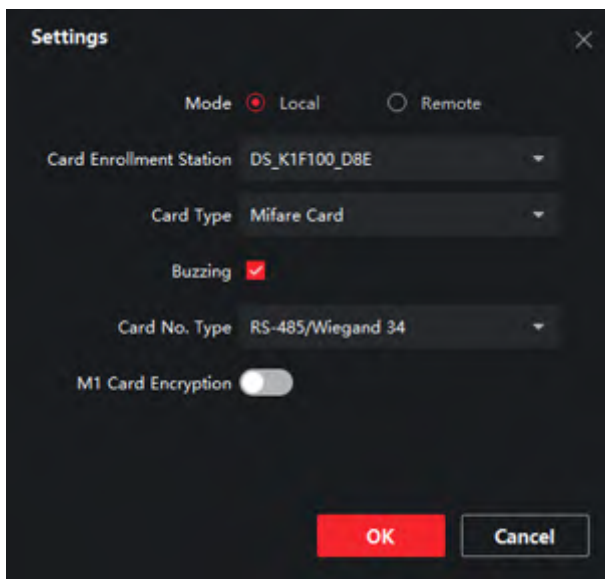

Figure 5-24 Card Settings

3. Select **Card Type** and **Card No. Type**.
4. Click **OK** to save the settings.

#### Result

After issuing the card to the person, the person and card information will display in the Person(s) with Card Issued list.

## 5.5.7 Permission Settings

### Add Permissions

#### Steps

1. On the main page, click  **AccessControlInfo** → **Access Group** to enter the page.
2. Click **+Add** to pop up the adding dialog box.
3. Configure the parameters.
  - 1) Enter the **Name** of the permission.

- 2) Select the **Template** of the schedule.
- 3) Check the person to **Selected** according to your needs.
- 4) Check the device to **Selected** according to your needs.
4. Click **Save**.
5. Check the permission and click **Apply All to Device**.  
The status of the permission displays as **Applied**.
6. **Optional**: Click **Applying Status** to check the details.

### **Modify/Delete Permissions**

On the page of the permission settings, click  to edit the parameters of the permission.

Select one or more permissions, click **Delete** to remove the permissions.

# 6 Video Intercom Operation

## 6.1 Video Intercom Operation via Device

### 6.1.1 Call Resident



#### Note

- Make sure you have configured the room No. of the device.
  - Make sure you have add contacts to the device via **iVMS-4200 Client Software**.
- 

#### Call Resident via Main Module or Nametag Module

Press the call button on the main unit or on the nametag unit.

#### Call Resident via Keypad Module

Enter the Room No. on the keypad module, and press # to start calling.

---



#### Note

You can press \* via keypad module to hang up.

---

#### Call Resident via Display Module

Press ^ or v on the display module to enter the contact list.

Press or hold ^/v to select a contact.

Press **OK** and confirm to call.

---



#### Note

- Hold ^ or v to scroll the page up or down faster.
  - You can press **Back button** via display module to hang up.
- 

#### Call Resident via Touch-Display Module

You can call corresponding resident in the two ways. They are:

- On the main page of the touch-display module, tap and enter the No. to call.
- On the main page of the touch-display module, tap to select a contact in the list to call.

---

 **Note**

Two themes of the main page are supported. You can change it remotely via client software.

---

### 6.1.2 Issue Card

#### Before You Start

Make sure you have issue the card locally or remotely. See *Person Management for issuing card via Client software* for details.

Issue Card via Main Card: You can swipe card to issue it after swiping the main card in advance.

#### Steps

1. Present the main card on the card reading area, and hear two beeps.
2. Present the unauthorized sub cards in turn after hearing a beep.
3. Present the main card again to end the card issuing process.

---

 **Note**

- DS-KD-M/DS-KD-TDM supports Mifare card, DS-KD-E/DS-KD-TDE supports EM card.
  - If the amount of sub cards exceeds 10000, no more sub cards can be issued.
  - Up to 5 sub cards can be issued once. The issued frequency is no more than 2000.
- 

### 6.1.3 Unlock Door

#### Unlock Door by Password

You can unlock the door by entering the password via the keypad module or touch-display module.

 **Note**

On the main page of touch-display module, tap to enter the call/unlock page to unlock the door.

---

Four formats of password are supported. They are:

- **【#】 + Public Password + 【#】**
  - **【#】 + Password + 【#】**
  - **【#】 + Duress Password + 【#】**
- 

 **Note**

- Password contains 6 digits.
  - You're allowed to set 3 public passwords via iVMS-4200 client software.
  - The password varies according to different rooms.
- 

### Unlock Door by Card

---

 **Note**

Make sure the card has been issued. You can issue the card via the door station, or via **iVMS-4200** client software.

---

Present the card on the card induction area via card reader module or touch-display module (with card reading function) to unlock the door.

---

 **Note**

The main card does not support unlocking the door.

---

## 6.2 Video Intercom Operation via Client Software

The Video Intercom Management module provides the function of video intercom, checking call logs and managing notice via the **iVMS-4200 Client Software**.

---

 **Note**

For the user with access control module permissions, the user can enter the Access Control module and manage video intercom and search information.

---

You should add the device to the software and configure the person to link the device in Access Control module before your configuration remotely.

Click  **AccessControlInfo** → **Video Intercom** → **Video Intercom** on the left bar to enter the Video Intercom page.

## 6.2.1 Receive Call from Door Station

### Steps

1. Select the client software in door station page to start calling the client and an incoming call dialog will pop up in the client software.

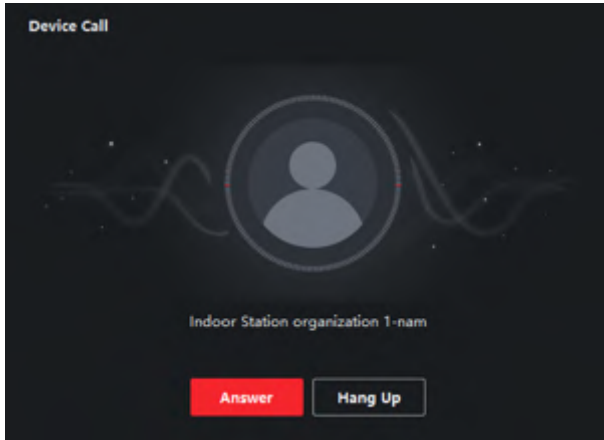

**Figure 6-1 Device Call**

2. Click **Answer** to answer the call. Or click **Hang Up** to decline the call.
3. After you answer the call, you will enter the In Call page.

#### **Adjust the Volume of Loudspeaker**

Click  to adjust the volume of loudspeaker.

#### **Hang Up**

Click **Hang Up** to hang up.

#### **Adjust the Volume of Microphone**

Click  to adjust the volume of the microphone.

#### **Unlock Remotely**

For door station, you can click  to open the door remotely.



 **Note**

- One video intercom device can only connect with one client software.
  - The maximum ring duration can be set from 15s to 60s via the Remote Configuration of the video intercom device.
  - The maximum speaking duration between indoor station and iVMS-4200 can be set from 120s to 600s via the Remote Configuration of indoor station.
  - The maximum speaking duration between door station and iVMS-4200 can be set from 90s to 120s via the Remote Configuration of door station.
- 

## 6.2.2 Live View via Door Station

You can get the live view of the main unit in the Main View module and control the door station remotely.

In the Main View module, double-click a door station or drag the device to a display window to start the live view.

Right click on the live view page, click the unlock icon to remote unlock the door.

## 6.2.3 View Call Logs

### Before You Start

You can check all the call logs, including dialed call logs, received call logs and missed call logs. You can also directly dial via the log list and clear the logs.

### Steps

1. In the Video Intercom page, click **Call Log** to enter the Call Log page.

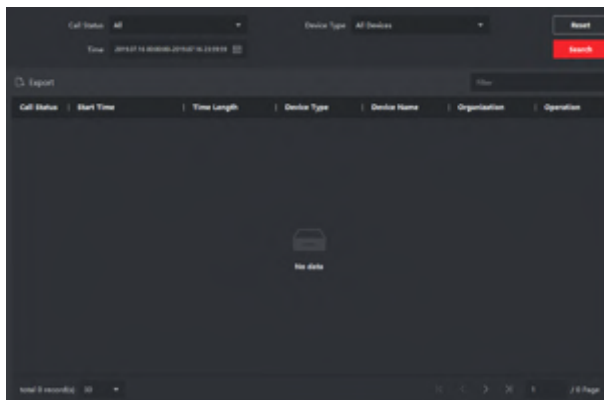

**Figure 6-2 View Call Logs**

All the call logs will display on this page and you can check the log information, e.g., call status, start time, resident's organization and name, device name and ring or speaking duration.

2. **Optional:** Click the call button to re-dial the resident.

### 6.2.4 Search Video Intercom Information

You can search the call logs between the iVMS-4200 client software and video intercom devices, device unlocking logs and the sent notice information.

In the main page, click  **AccessControlInfo** to enter the access control module.

In the Access Control module, click **Video Intercom**.

### Search Call Logs

#### Steps

1. In the Video Intercom page, click **Call Log** to enter the Call Log page.

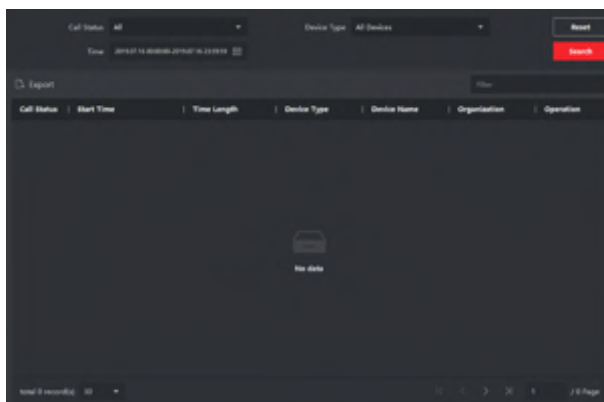

**Figure 6-3 Call Logs**

2. Set the search conditions, including call status, device type, start time and end time.

### **Call Status**

Click  $\nabla$  to unfold the drop-down list and select the call status as **Dialed**, **Received** or **Missed**. Or select **All** to search logs with all statuses.

### **Device Type**

Click  $\nabla$  to unfold the drop-down list and select the device type as **Indoor Station**, **Door Station**, **Outer Door Station** or **Analog Indoor Station**. Or select **All Devices** to search logs with all device types.

### **Day Mode Start Time/Day Mode End Time**

Click  to specify the start time and end time of a time period to search the logs.

**Reset the Settings** Click **Reset** to reset all the configured search conditions.

3. Click **Search** and all the matched call logs will display on this page.
4. **Optional:** Check the detailed information of searched call logs, such as call status, ring/speaking duration, device name, resident organization, etc.
5. **Optional:** Input keywords in the Search field to filter the desired log.
6. **Optional:** Click **Export** to export the call logs to your PC.

## **Search Unlocking Logs**

**Steps**

1. In the Information Search page, click **Unlocking Log** to enter the Unlocking Log page.

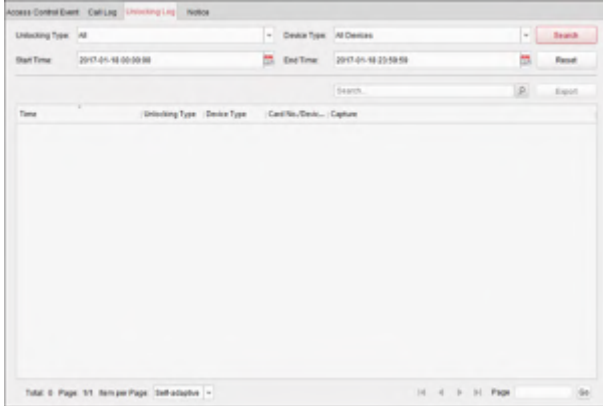

**Figure 6-4 Unlocking Logs**

2. Set the search conditions, including unlocking type, device type, start time and end time.

**Unlocking Type**

Click **∨** to unfold the drop-down list and select the unlocking type as **Unlock by Password**, **Unlock by Duress**, **Unlock by Card**, **Unlock by Resident** or **Unlock by Center**. Or select **All** to search logs with all unlocking types.

**Device Type**

Click **∨** to unfold the drop-down list and select the device type as **Door Station** or **Door Station (V Series)**. Or select **All Devices** to search logs with all device types.

**Start Time/End Time**

Click **📅** to specify the start time and end time of a time period to search the logs.

**Reset the Settings** Click **Reset** to reset all the configured search conditions.

3. Click **Search** and all the matched unlocking logs will display on the page.
4. **Optional:** Check the detailed information of searched unlocking logs, such as unlocked time, card No., device No., etc.
5. **Optional:** Input keywords in the Search field to filter the searching result.

6. **Optional:** Click  on the Capture column to view the captured pictures.

---

 **Note**

Viewing captured picture should be supported by device.

---

7. **Optional:** Click **Export** to export the unlocking logs to your PC.

# A. Communication Matrix and Device Command

## Communication Matrix

Scan the following QR code to get the device communication matrix.

Note that the matrix contains all communication ports of Hikvision access control and video intercom devices.



Figure A-1 QR Code of Communication Matrix

## Device Command

Scan the following QR code to get the device common serial port commands.

Note that the command list contains all commonly used serial ports commands for all Hikvision access control and video intercom devices.



Figure A-2 Device Command

