

FCC SAR TEST REPORT

Application No.: KSEM2009001278CR
Applicant: Hangzhou Hikvision Digital Technology Co.,Ltd
Address of Applicant: No.555 Qianmo Road,Binjiang Dis trict,Hangzhou,310052,China
Manufacturer: Hangzhou Hikvision Digital Technology Co.,Ltd
Address of Manufacturer: No.555 Qianmo Road,Binjiang District,Hangzhou,310052,China
Factory: Hangzhou Hikvision Technology Co.,Ltd
Address of Factory: No.700,Dongliu Road,Binjiang District,Hangzhou City,Zhejiang,310052,China
Product Name: Helmet Camera
Model No.(EUT): DS-MCH508
 DS-MCH508/GLE, DS-MCH508/GPS/WIFI,
 DS-MCH508/GLE/GPS/WIFI, DS-MCH508/3/W/GLE,
 DS-MCH508/3/I/GLE, DS-MCH508/3/W/GPS/WIFI,
Series Model: DS-MCH508/3/I/GPS/WIFI, DS-MCH508/3/W/32G/GPS/WIFI,
 DS-MCH508/3/I/32G/GPS/WIFI, DS-MCH508/3/W/32G/GLE,
 DS-MCH508/3/I/32G/GLE,
 DS-MCHX08/YYYYYYYY/ZZZZZZZ,'X','Y','Z' can be uppercase or lowercase English letter, digital number, or '/', '-', or empty.
Trade mark: HIKVISION
FCC ID: 2ADTD-MCH508
Standard(s) : FCC 47CFR §2.1093
Date of Receipt: 2020-10-09
Date of Test: 2020-10-14 to 2020-10-16
Date of Issue: 2020-10-23

Test Result:	Pass*
---------------------	--------------

* In the configuration tested, the EUT complied with the standards specified above.

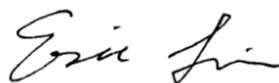

Eric Lin

Laboratory Manager

The manufacturer should ensure that all products in series production are in conformity with the product sample detailed in this report.

If the product in this report is used in any configuration other than that detailed in the report, the manufacturer must ensure the new system complies with all relevant standards. Any mention of SGS International Electrical Approvals or testing done by SGS International Electrical Approvals in connection with, distribution or use of the product described in this report must be approved by SGS International Electrical Approvals in writing.



Unless otherwise agreed in writing, this document is issued by the Company subject to its General Conditions of Service printed overleaf, available on request or accessible at <http://www.sgs.com/en/Terms-and-Conditions.aspx> and, for electronic format documents, subject to Terms and Conditions for Electronic Documents at <http://www.sgs.com/en/Terms-and-Conditions/Terms-e-Document.aspx>. Attention is drawn to the limitation of liability, indemnification and jurisdiction issues defined therein. Any holder of this document is advised that information contained hereon reflects the Company's findings at the time of its intervention only and within the limits of Client's instructions, if any. The Company's sole responsibility is to its Client and this document does not exonerate parties to a transaction from exercising all their rights and obligations under the transaction documents. This document cannot be reproduced except in full, without prior written approval of the Company. Any unauthorized alteration, forgery or falsification of the content or appearance of this document is unlawful and offenders may be prosecuted to the fullest extent of the law. Unless otherwise stated the results shown in this test report refer only to the sample(s) tested and such sample(s) are retained for 30 days only.
Attention: To check the authenticity of testing/inspection report & certificate, please contact us at telephone: (86-755) 8307 1443, or email: CN.Doccheck@sgs.com

No.10, Weiye Road, Innovation Park, Kunshan, Jiangsu, China 215300
 中国·江苏·昆山市留学院创业园伟业路10号 邮编 215300

t(86-512)57355888 f(86-512)57370818 www.sgs.com.cn
 t(86-512)57355888 f(86-512)57370818 sgs.china@sgs.com

REVISION HISTORY

Revision Record			
Version	Description	Date	Remark
00	Original	2020-10-23	Original

Authorized for issue by:				
		Richard.Kong/ Project Engineer		
		Eric.Lin/Reviewer		

TEST SUMMARY

Frequency Band	Test position	Test mode	Max Reported SAR1g (W/kg)	SAR limit (W/kg)	Verdict
GSM850	Head	GPRS2TS	0.33	1.6	PASS
GSM1900	Head	GPRS4TS	1.09	1.6	PASS
WCDMA Band II	Head	RMC	0.49	1.6	PASS
WCDMA Band V	Head	RMC	0.16	1.6	PASS
LTE Band 2	Head	QPSK	0.50	1.6	PASS
LTE Band 4	Head	QPSK	0.20	1.6	PASS
LTE Band 5	Head	QPSK	0.15	1.6	PASS
LTE Band 7	Head	QPSK	0.42	1.6	PASS
WIFI2.4G	Head	802.11g	0.01	1.6	PASS
Scenario			Head		
Sum SAR			1.36		
SPLSR			NA		
SPLSR Limited			0.04		

CONTENTS

1	GENERAL INFORMATION	6
1.1	GENERAL DESCRIPTION OF EUT	6
1.1.1	<i>DUT Antenna Locations(Unit: mm)</i>	<i>7</i>
1.2	TEST SPECIFICATION.....	9
1.3	RF EXPOSURE LIMITS	10
1.4	TEST LOCATION	11
1.5	TEST FACILITY	11
2	LABORATORY ENVIRONMENT	12
3	SAR MEASUREMENTS SYSTEM CONFIGURATION.....	13
3.1	THE SAR MEASUREMENT SYSTEM	13
3.2	ISOTROPIC E-FIELD PROBE EX3DV4	14
3.3	DATA ACQUISITION ELECTRONICS (DAE)	15
3.4	SAM TWIN PHANTOM.....	15
3.5	ELI PHANTOM.....	16
3.6	DEVICE HOLDER FOR TRANSMITTERS.....	17
3.7	MEASUREMENT PROCEDURE.....	18
3.7.1	<i>Scanning procedure</i>	<i>18</i>
3.7.2	<i>Data Storage</i>	<i>20</i>
3.7.3	<i>Data Evaluation by SEMCAD.....</i>	<i>20</i>
4	SAR MEASUREMENT VARIABILITY AND UNCERTAINTY	22
4.1	SAR MEASUREMENT VARIABILITY	22
4.2	SAR MEASUREMENT UNCERTAINTY	23
5	DESCRIPTION OF TEST POSITION	24
5.1	THE BODY TEST POSITION.....	24
6	SAR SYSTEM VERIFICATION PROCEDURE	25
6.1	TISSUE SIMULATE LIQUID.....	25
6.1.1	<i>Recipes for Tissue Simulate Liquid</i>	<i>25</i>
6.1.2	<i>Test Liquids Confirmation.....</i>	<i>26</i>
6.1.3	<i>Measurement for Tissue Simulate Liquid</i>	<i>27</i>
6.2	SAR SYSTEM CHECK	28
6.2.1	<i>Justification for Extended SAR Dipole Calibrations</i>	<i>29</i>
6.2.2	<i>Summary System Check Result(s)</i>	<i>30</i>
6.2.3	<i>Detailed System Check Results</i>	<i>30</i>
7	TEST CONFIGURATION.....	31
7.1	3G SAR TEST REDUCTION PROCEDURE	31
7.2	OPERATION CONFIGURATIONS	31
7.2.1	<i>WCDMA Test Configuration</i>	<i>31</i>
7.2.2	<i>WCDMA Test Configuration</i>	<i>32</i>
7.2.3	<i>Wi-Fi Test Configuration.....</i>	<i>37</i>
7.2.4	<i>Bluetooth Test Configuration.....</i>	<i>40</i>
7.2.5	<i>LTE Test Configuration.....</i>	<i>41</i>
8	TEST RESULT	43
8.1	MEASUREMENT OF RF CONDUCTED POWER	43
8.1.1	<i>Conducted Power Of GSM.....</i>	<i>43</i>
8.1.2	<i>Conducted Power Of WCDMA</i>	<i>44</i>
8.1.3	<i>Conducted Power Of LTE</i>	<i>45</i>

8.1.4	Conducted Power Of Wi-Fi and BT	52
8.2	STAND-ALONE SAR TEST EVALUATION	53
8.3	THE EUT SIDES FOR SAR TEST.....	54
8.4	MEASUREMENT OF SAR DATA.....	56
8.4.1	SAR Result Of GSM850.....	56
8.4.2	SAR Result Of GSM1900.....	57
8.4.3	SAR Result Of WCDMA Band II.....	58
8.4.4	SAR Result Of WCDMA Band V	59
8.4.5	SAR Result Of LTE Band 2	60
8.4.6	SAR Result Of LTE Band 4	61
8.4.7	SAR Result Of LTE Band 5.....	62
8.4.8	SAR Result Of LTE Band 7.....	63
8.4.9	SAR Result Of 2.4GHz Wi-Fi	64
8.4.10	Repeat SAR Measurement	65
8.5	MULTIPLE TRANSMITTER EVALUATION.....	66
8.5.1	Simultaneous SAR SAR test evaluation.....	66
8.5.2	Estimated SAR	67
9	EQUIPMENT LIST	69
10	CALIBRATION CERTIFICATE.....	70
11	PHOTOGRAPHS	70
	APPENDIX A: DETAILED SYSTEM CHECK RESULTS	71
	APPENDIX B: DETAILED TEST RESULTS	77
	APPENDIX C: CALIBRATION CERTIFICATE	87
	APPENDIX D: PHOTOGRAPHS.....	87

1 General Information

1.1 General Description of EUT

Device Type :	portable device		
Exposure Category:	uncontrolled environment / general population		
Product Phase:	production unit		
SN:	E55001866/ E55001865		
Hardware Version:	V1.0		
Software Version:	V1.3.0 build200620		
Antenna Type:	PIFA Antenna		
Device Operating Configurations :			
Modulation Mode:	GSM: GMSK, 8PSK; WCDMA: QPSK; LTE: QPSK,16QAM,; Wi-Fi: CCK, DSSS, OFDM; BT: GFSK, π/4DQPSK,8DPSK		
Antenna Gain:	Wi-Fi & Bluetooth	1.83dBi (Provided by the manufacturer)	
Device Class:	B		
GPRS Multi-slots Class:	33	EGPRS Multi-slots Class:	33
HSDPA UE Category:	24	HSUPA UE Category	6
DC-HSDPA UE Category:	24	LTE UE Category:	4
Power Class:	4, tested with power level 5(GSM850)		
	1, tested with power level 0(GSM1900)		
	3, tested with power control "all 1"(WCDMA Band II/V)		
	3, tested with power control Max Power(LTE Band 2/4/5/7)		
Frequency Bands:	Band	Tx (MHz)	Rx (MHz)
	GSM850	824-849	869-894
	GSM1900	1850-1910	1930-1990
	WCDMA Band V	824~849	869~894
	WCDMA Band II	1850~1910	1930~1990
	LTE Band 2	1850~1910	1930~1990
	LTE Band 4	1710~1755	2110~2155
	LTE Band 5	824-849	869-894
	LTE Band 7	2500-2570	2620- 2690
	WI-FI2.4G	2412~2462	2412~2462
Bluetooth	2402~2480	2402~2480	
Battery1 Information:	Model: TK-S20-973037		
	Rated capacity: 2700mAh/10.26Wh		
	Manufacturer: Li Fun Technology Co.,Ltd		

Note1:

Model No.: DS-MCH508/GLE, DS-MCH508/GPS/WIFI,

DS-MCH508/GLE/GPS/WIFI, DS-MCH508/3/W/GLE,

DS-MCH508/3/I/GLE, DS-MCH508/3/W/GPS/WIFI,

DS-MCH508/3/I/GPS/WIFI, DS-MCH508/3/W/32G/GPS/WIFI,

DS-MCH508/3/I/32G/GPS/WIFI, DS-MCH508/3/W/32G/GLE, DS-MCH508/3/I/32G/GLE,

DS-MCHX08/YYYYYYY/ZZZZZZ,'X','Y','Z' can be uppercase or lowercase English letter, digital number, or '/', '-',' or empty.

There are series models mentioned in this report, and they are the similar in electrical and electronic characters. Only the model DS-MCH508 was tested since their differences were the model number.

Note2:

The antenna gain value is provided by the customer. The test lab will not be responsible for wrong test result due to incorrect information about antenna gain values.

1.1.1 DUT Antenna Locations(Unit: mm)

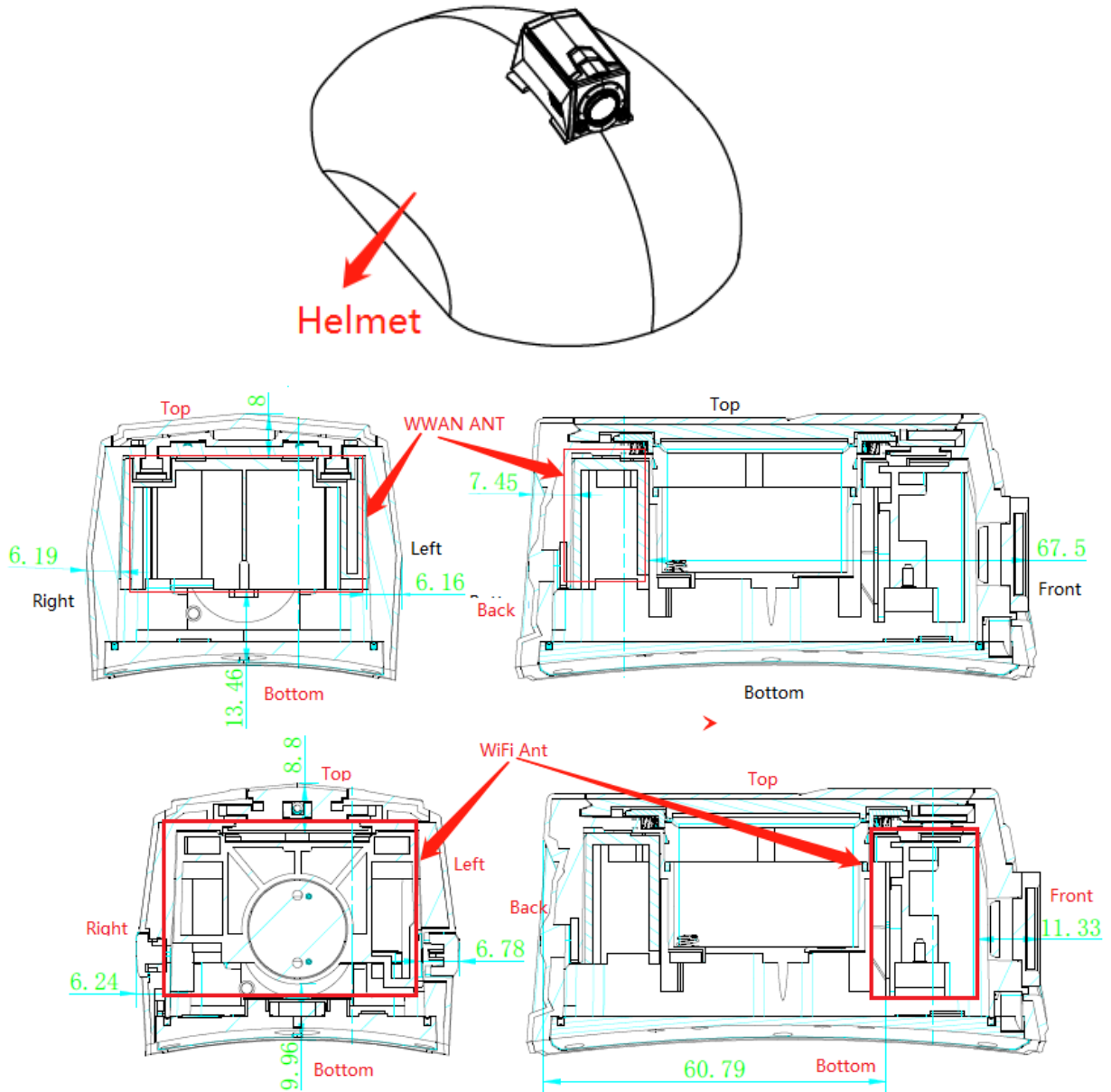

The test device is a DS-MCH508.

According to the distance between WWAN/Wi-Fi/BT antennas and the sides of the EUT we can draw the conclusion that:

EUT Sides for SAR Testing						
Mode	Front	Back	Left	Right	Top	Bottom
Distance for WWAN antenna(mm)	67.5	7.45	6.16	6.19	8	13.46
Distance for Wi-Fi antenna(mm)	11.33	60.79	6.78	6.24	8.8	9.96
WWAN	No	No	No	No	No	Yes
Bluetooth	No	No	No	No	No	No
2.4G Wi-Fi	No	No	No	No	No	Yes

Table 1: EUT Sides for SAR Testing

Note:

- 1) Details please see Section 8.2 and 8.3
- 2) Wifi antenna and the BT antenna share the same antenna.
- 3) In fact, there would be only the surface of Bottom side contact with human's head.
- 4) Head-mounted products can't direct application to the Head Phantom, adopts Flat Phantom to simulate test the device, so this approach is to use Flat Phantom, Head Liquid to test the device.

1.2 Test Specification

Identity	Document Title
FCC 47CFR §2.1093	Radio frequency Radiation Exposure Evaluation: Portable Devices
ANSI/IEEE Std C95.1 – 1992	Safety Levels with Respect to Human Exposure to Radio Frequency Electromagnetic Fields, 3 kHz – 300 GHz.
IEEE 1528-2013	Recommended Practice for Determining the Peak Spatial-Average Specific Absorption Rate (SAR) in the Human Head from Wireless Communications Devices: Measurement Techniques
KDB 941225 D01 3G SAR Procedures v03r01	3G SAR Measurement Procedures
KDB 248227 D01 802.11 Wi-Fi SAR v02r02	SAR GUIDANCE FOR IEEE 802.11 (Wi-Fi) TRANSMITTERS
KDB 941225 D05 SAR for LTE Devices v02r05	SAR EVALUATION CONSIDERATIONS FOR LTE DEVICES
KDB447498 D01 General RF Exposure Guidance v06	Mobile and Portable Devices RF Exposure Procedures and Equipment Authorization Policies
KDB 865664 D01 SAR Measurement 100 MHz to 6 GHz v01r04	SAR Measurement Requirements for 100 MHz to 6 GHz
KDB 865664 D02 RF Exposure Reporting v01r02	RF Exposure Compliance Reporting and Documentation Considerations

1.3 RF exposure limits

Human Exposure	Uncontrolled Environment General Population	Controlled Environment Occupational
Spatial Peak SAR* (Brain*Trunk)	1.60 W/kg	8.00 W/kg
Spatial Average SAR** (Whole Body)	0.08 W/kg	0.40 W/kg
Spatial Peak SAR*** (Hands/Feet/Ankle/Wrist)	4.00 W/kg	20.00 W/kg

Notes:

* The Spatial Peak value of the SAR averaged over any 1 gram of tissue (defined as a tissue volume in the shape of a cube) and over the appropriate averaging time

** The Spatial Average value of the SAR averaged over the whole body.

*** The Spatial Peak value of the SAR averaged over any 10 grams of tissue (defined as a tissue volume in the shape of a cube) and over the appropriate averaging time.

Uncontrolled Environments are defined as locations where there is the exposure of individuals who have no knowledge or control of their exposure.

Controlled Environments are defined as locations where there is exposure that may be incurred by persons who are aware of the potential for exposure, (i.e. as a result of employment or occupation.)

1.4 Test Location

Company: Compliance Certification Services Inc. Kun shan Laboratory
Address: No.10 Weiye Rd., Innovation park, Eco&Tec, Development Zone, Kunshan City, Jiangsu, China
Post code: 215300
Telephone: 86-512-57355888
Fax: 86-512-57370818
E-mail: sgs.china@sgs.com

1.5 Test Facility

The test facility is recognized, certified, or accredited by the following organizations:

- **CNAS (No. CNAS L4354)**

CNAS has accredited Compliance Certification Services (Kunshan) Inc. to ISO/IEC 17025:2017 General Requirements for the Competence of Testing and Calibration Laboratories (CNAS-CL01 Accreditation Criteria for the Competence of Testing and Calibration Laboratories) for the competence in the field of testing.

- **A2LA (Certificate No. 2541.01)**

Compliance Certification Services (Kunshan) Inc. is accredited by the American Association for Laboratory Accreditation (A2LA). Certificate No. 2541.01.

- **FCC –Designation Number: CN1172**

Compliance Certification Services Inc. has been recognized as an accredited testing laboratory.

Designation Number: CN1172.

- **ISED (CAB identifier: CN0072)**

Compliance Certification Services (Kunshan) Inc. has been recognized by Innovation, Science and Economic Development Canada (ISED) as an accredited testing laboratory

CAB Identifier: CN0072.

- **VCCI (Member No.: 1938)**

The 3m and 10m Semi-anechoic chamber and Shielded Room of Compliance Certification Services (Kunshan) Inc. has been registered in accordance with the Regulations for Voluntary Control Measures with Registration No.: R-1600, C-1707, T-1499, G-10216 respectively.

2 Laboratory Environment

Temperature	Min. = 18°C, Max. = 25 °C
Relative humidity	Min. = 30%, Max. = 70%
Ground system resistance	< 0.5 Ω
Ambient noise is checked and found very low and in compliance with requirement of standards.	
Reflection of surrounding objects is minimized and in compliance with requirement of standards.	

Table 2: The Ambient Conditions

3 SAR Measurements System Configuration

3.1 The SAR Measurement System

This SAR Measurement System uses a Computer-controlled 3-D stepper motor system (SPEAG DASY5 professional system). A E-field probe is used to determine the internal electric fields. The SAR can be obtained from the equation $SAR = \sigma (|E|^2) / \rho$ where σ and ρ are the conductivity and mass density of the tissue-Simulate.

The DASY5 system for performing compliance tests consists of the following items:

A standard high precision 6-axis robot (Stabile RX family) with controller, teach pendant and software .An arm extension for accommodation the data acquisition electronics (DAE).

A dosimetric probe, i.e., an isotropic E-field probe optimized and calibrated for usage in tissue simulating liquid. The probe is equipped with an optical surface detector system.

A data acquisition electronics (DAE) which performs the signal amplification, signal multiplexing, AD-conversion, offset measurements, mechanical surface detection, collision detection, etc. The unit is battery powered with standard or rechargeable batteries. The signal is optically transmitted to the EOC.

The Electro-optical converter (EOC) performs the conversion between optical and electrical of the signals for the digital communication to DAE and for the analog signal from the optical surface detection. The EOC is connected to the measurement server.

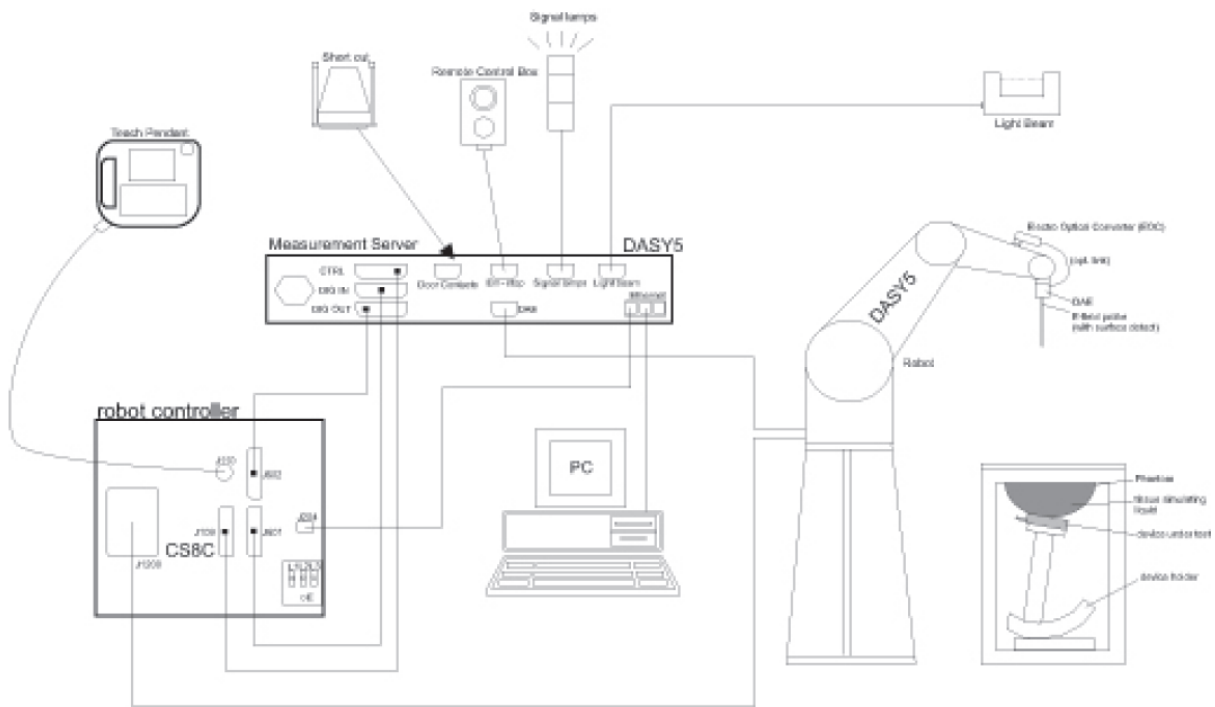

F-1. SAR Measurement System Configuration

- The function of the measurement server is to perform the time critical tasks such as signal filtering, control of the robot operation and fast movement interrupts.

- A probe alignment unit which improves the (absolute) accuracy of the probe positioning.
- A computer operating Windows 7.
- DASY5 software.
- Remote control with teach pendant and additional circuitry for robot safety such as warning lamps, etc.
- The SAM twin phantom enabling testing left-hand, right-hand and Body Worn usage.
- The device holder for handheld mobile phones.
- Tissue simulating liquid mixed according to the given recipes.
- Validation dipole kits allowing to validate the proper functioning of the system.

3.2 Isotropic E-field Probe EX3DV4

	<p>Symmetrical design with triangular core Built-in shielding against static charges PEEK enclosure material (resistant to organic solvents, e.g., DGBE)</p>
<p>Calibration</p>	<p>ISO/IEC 17025 calibration service available.</p>
<p>Frequency</p>	<p>10 MHz to > 6 GHz Linearity: ± 0.2 dB (30 MHz to 6 GHz)</p>
<p>Directivity</p>	<p>± 0.3 dB in TSL (rotation around probe axis) ± 0.5 dB in TSL (rotation normal to probe axis)</p>
<p>Dynamic Range</p>	<p>10 μW/g to > 100 mW/g Linearity: ± 0.2 dB (noise: typically < 1 μW/g)</p>
<p>Dimensions</p>	<p>Overall length: 337 mm (Tip: 20 mm) Tip diameter: 2.5 mm (Body: 12 mm) Typical distance from probe tip to dipole centers: 1 mm</p>
<p>Application</p>	<p>High precision dosimetric measurements in any exposure scenario (e.g., very strong gradient fields); the only probe that enables compliance testing for frequencies up to 6 GHz with precision of better 30%.</p>
<p>Compatibility</p>	<p>DASY3, DASY4, DASY52 SAR and higher, EASY4/MRI</p>

3.3 Data Acquisition Electronics (DAE)

Model	DAE4	
Construction	Signal amplifier, multiplexer, A/D converter and control logic. Serial optical link for communication with DASY4/5 embedded system (fully remote controlled). Two step probe touch detector for mechanical surface detection and emergency robot stop.	
Measurement Range	-100 to +300 mV (16 bit resolution and two range settings: 4mV,400mV)	
Input Offset Voltage	< 5μV (with auto zero)	
Input Bias Current	< 50 f A	
Dimensions	60 x 60 x 68 mm	

3.4 SAM Twin Phantom

Material	Vinylester, glass fiber reinforced (VE-GF)	
Liquid Compatibility	Compatible with all SPEAG tissue simulating liquids (incl. DGBE type)	
Shell Thickness	2 ± 0.2 mm (6 ± 0.2 mm at ear point)	
Dimensions (incl. Wooden Support)	Length: 1000 mm Width: 500 mm Height: adjustable feet	
Filling Volume	approx. 25 liters	
Wooden Support	SPEAG standard phantom table	

The shell corresponds to the specifications of the Specific Anthropomorphic Mannequin (SAM) phantom defined in IEEE 1528 and IEC 62209-1. It enables the dosimetric evaluation of left and right hand phone usage as well as body mounted usage at the flat phantom region. A cover prevents evaporation of the liquid. Reference markings on the phantom allow the complete setup of all predefined phantom positions and measurement grids by teaching three points with the robot.

Twin SAM V5.0 has the same shell geometry and is manufactured from the same material as Twin SAM V4.0, but has reinforced top structure.

3.5 ELI Phantom

Material	Vinylester, glass fiber reinforced (VE-GF)	
Liquid Compatibility	Compatible with all SPEAG tissue simulating liquids (incl. DGBE type)	
Shell Thickness	2.0 ± 0.2 mm (bottom plate)	
Dimensions	Major axis: 600 mm Minor axis: 400 mm	
Filling Volume	approx. 30 liters	
Wooden Support	SPEAG standard phantom table	

Phantom for compliance testing of handheld and body-mounted wireless devices in the frequency range of 30 MHz to 6 GHz. ELI is fully compatible with the IEC 62209-2 standard and all known tissue simulating liquids. ELI has been optimized regarding its performance and can be integrated into our standard phantom tables. A cover prevents evaporation of the liquid. Reference markings on the phantom allow installation of the complete setup, including all predefined phantom positions and measurement grids, by teaching three points. The phantom is compatible with all SPEAG dosimetric probes and dipoles.

ELI V5.0 has the same shell geometry and is manufactured from the same material as ELI4, but has reinforced top structure.

3.6 Device Holder for Transmitters



F-2. Device Holder for Transmitters

- The DASY device holder is designed to cope with different positions given in the standard. It has two scales for the device rotation (with respect to the body axis) and the device inclination (with respect to the line between the ear reference points). The rotation centres for both scales are the ear reference point (ERP). Thus the device needs no repositioning when changing the angles.
- The DASY device holder has been made out of low-loss POM material having the following dielectric parameters: relative permittivity $\epsilon=3$ and loss tangent $\delta=0.02$. The amount of dielectric material has been reduced in the closest vicinity of the device, since measurements have suggested that the influence of the clamp on the test results could thus be lowered.

3.7 Measurement procedure

3.7.1 Scanning procedure

Step 1: Power reference measurement

The “reference” and “drift” measurements are located at the beginning and end of the batch process. They measure the field drift at one single point in the liquid over the complete procedure.

Step 2: Area scan

The SAR distribution at the exposed side of the head was measured at a distance of 4mm from the inner surface of the shell. The area covered the entire dimension of the head and the horizontal grid spacing was 15mm*15mm or 12mm*12mm or 10mm*10mm. Based on the area scan data, the area of the maximum absorption was determined by spline interpolation.

Step 3: Zoom scan

Around this point, a volume of 30mm*30mm*30mm (fine resolution volume scan, zoom scan) was assessed by measuring 5x5x7 points (≤ 2 GHz) and 7x7x7 points (≥ 2 GHz). On this basis of this data set, the spatial peak SAR value was evaluated with the following procedure:

The data at the surface was extrapolated, since the centre of the dipoles is 2.0mm away from the tip of the probe and the distance between the surface and the lowest measuring point is 1.2mm. (This can be variable. Refer to the probe specification). The extrapolation was based on a least square algorithm. A polynomial of the fourth order was calculated through the points in z-axes. This polynomial was then used to evaluate the points between the surface and the probe tip. The maximum interpolated value was searched with a straight-forward algorithm. Around this maximum the SAR values averaged over the spatial volumes (1g or 10g) were computed using the 3D-Spline interpolation algorithm. The volume was integrated with the trapezoidal algorithm. One thousand points were interpolated to calculate the average. All neighbouring volumes were evaluated until no neighboring volume with a higher average value was found.

The area and zoom scan resolutions specified in the table below must be applied to the SAR measurements. Probe boundary effect error compensation is required for measurements with the probe tip closer than half a probe tip diameter to the phantom surface. Both the probe tip diameter and sensor offset distance must satisfy measurement protocols; to ensure probe boundary effect errors are minimized and the higher fields closest to the phantom surface can be correctly measured and extrapolated to the phantom surface for computing 1-g SAR. Tolerances of the post-processing algorithms must be verified by the test laboratory for the scan resolutions used in the SAR measurements, according to the reference distribution functions specified in IEEE Std. 1528-2003.

		≤ 3 GHz	> 3 GHz	
Maximum distance from closest measurement point (geometric center of probe sensors) to phantom surface		5 ± 1 mm	$\frac{1}{2} \cdot \delta \cdot \ln(2) \pm 0.5$ mm	
Maximum probe angle from probe axis to phantom surface normal at the measurement location		$30^\circ \pm 1^\circ$	$20^\circ \pm 1^\circ$	
Maximum area scan spatial resolution: Δx_{Area} , Δy_{Area}		≤ 2 GHz: ≤ 15 mm 2 – 3 GHz: ≤ 12 mm	3 – 4 GHz: ≤ 12 mm 4 – 6 GHz: ≤ 10 mm	
		When the x or y dimension of the test device, in the measurement plane orientation, is smaller than the above, the measurement resolution must be \leq the corresponding x or y dimension of the test device with at least one measurement point on the test device.		
Maximum zoom scan spatial resolution: Δx_{Zoom} , Δy_{Zoom}		≤ 2 GHz: ≤ 8 mm 2 – 3 GHz: ≤ 5 mm*	3 – 4 GHz: ≤ 5 mm* 4 – 6 GHz: ≤ 4 mm*	
Maximum zoom scan spatial resolution, normal to phantom surface	uniform grid: $\Delta z_{Zoom}(n)$	≤ 5 mm	3 – 4 GHz: ≤ 4 mm 4 – 5 GHz: ≤ 3 mm 5 – 6 GHz: ≤ 2 mm	
	graded grid	$\Delta z_{Zoom}(1)$: between 1 st two points closest to phantom surface	≤ 4 mm	3 – 4 GHz: ≤ 3 mm 4 – 5 GHz: ≤ 2.5 mm 5 – 6 GHz: ≤ 2 mm
		$\Delta z_{Zoom}(n>1)$: between subsequent points	$\leq 1.5 \cdot \Delta z_{Zoom}(n-1)$	
Minimum zoom scan volume	x, y, z	≥ 30 mm	3 – 4 GHz: ≥ 28 mm 4 – 5 GHz: ≥ 25 mm 5 – 6 GHz: ≥ 22 mm	
<p>Note: δ is the penetration depth of a plane-wave at normal incidence to the tissue medium; see draft standard IEEE P1528-2011 for details.</p> <p>* When zoom scan is required and the <i>reported</i> SAR from the <i>area scan based 1-g SAR estimation</i> procedures of KDB 447498 is ≤ 1.4 W/kg, ≤ 8 mm, ≤ 7 mm and ≤ 5 mm zoom scan resolution may be applied, respectively, for 2 GHz to 3 GHz, 3 GHz to 4 GHz and 4 GHz to 6 GHz.</p>				

Step 4: Power reference measurement (drift)

The Power Drift Measurement job measures the field at the same location as the most recent power reference measurement job within the same procedure, and with the same settings. The indicated drift is mainly the variation of the DUT's output power and should vary max. $\pm 5\%$

3.7.2 Data Storage

The DASY software stores the acquired data from the data acquisition electronics as raw data (in microvolt readings from the probe sensors), together with all necessary software parameters for the data evaluation (probe calibration data, liquid parameters and device frequency and modulation data) in measurement files with the extension “.DAE3”. The software evaluates the desired unit and format for output each time the data is visualized or exported. This allows verification of the complete software setup even after the measurement and allows correction of incorrect parameter settings. For example, if a measurement has been performed with a wrong crest factor parameter in the device setup, the parameter can be corrected afterwards and the data can be re-evaluated. The measured data can be visualized or exported in different units or formats, depending on the selected probe type ([V/m], [A/m], [°C], [m W/g], [m W/cm²], [dBrel], etc.). Some of these units are not available in certain situations or show meaningless results, e.g., a SAR output in a lossless media will always be zero. Raw data can also be exported to perform the evaluation with other software packages.

3.7.3 Data Evaluation by SEMCAD

The SEMCAD software automatically executes the following procedures to calculate the field units from the microvolt readings at the probe connector. The parameters used in the evaluation are stored in the configuration modules of the software:

Probe parameters:	- Sensitivity	Normi, ai0, ai1, ai2
	- Conversion factor	ConvFi
	- Diode compression point	Dcpi
Device parameters:	- Frequency	f
	- Crest factor	cf
Media parameters:	- Conductivity	ε
	- Density	ρ

These parameters must be set correctly in the software. They can be found in the component documents or they can be imported into the software from the configuration files issued for the DASY components. In the direct measuring mode of the multimeter option, the parameters of the actual system setup are used. In the scan visualization and export modes, the parameters stored in the corresponding document files are used.

The first step of the evaluation is a linearization of the filtered input signal to account for the compression characteristics of the detector diode. The compensation depends on the input signal, the diode type and the DC-transmission factor from the diode to the evaluation electronics.

If the exciting field is pulsed, the crest factor of the signal must be known to correctly compensate for peak power. The formula for each channel can be given as:

$$V_i = U_i + U_i^2 \cdot cf / dcpi$$

With V_i = compensated signal of channel i ($i = x, y, z$)

U_i = input signal of channel i ($i = x, y, z$)

cf = crest factor of exciting field (DASY parameter)

dcpi = diode compression point (DASY parameter)

From the compensated input signals the primary field data for each channel can be evaluated:

E-field probes:

$$E_i = (V_i / Norm_i \cdot ConvF)^{1/2}$$

H-field probes:

$$H_i = (V_i)^{1/2} \cdot (a_{i0} + a_{i1}f + a_{i2}f^2) / f$$

With V_i = compensated signal of channel i ($i = x, y, z$)

Norm i = sensor sensitivity of channel i ($i = x, y, z$)

[mV/(V/m)²] for E-field Probes

ConvF = sensitivity enhancement in solution

a_{ij} = sensor sensitivity factors for H-field probes

f = carrier frequency [GHz]

E_i = electric field strength of channel i in V/m

H_i = magnetic field strength of channel i in A/m

The RSS value of the field components gives the total field strength (Hermitian magnitude):

$$E_{tot} = (E_x^2 + E_y^2 + E_z^2)^{1/2}$$

The primary field data are used to calculate the derived field units.

$$SAR = (E_{tot}^2 \cdot \sigma) / (\epsilon \cdot 1000)$$

With SAR = local specific absorption rate in mW/g

E_{tot} = total field strength in V/m

σ = conductivity in [mho/m] or [Siemens/m]

ϵ = equivalent tissue density in g/cm³

Note that the density is normally set to 1 (or 1.06), to account for actual brain density rather than the density of the simulation liquid. The power flow density is calculated assuming the excitation field to be a free space field.

$$P_{pwe} = E_{tot}^2 / 3770 \quad \text{or} \quad P_{pwe} = H_{tot}^2 \cdot 37.7$$

with P_{pwe} = equivalent power density of a plane wave in mW/cm²

E_{tot} = total electric field strength in V/m

H_{tot} = total magnetic field strength in A/m

4 SAR measurement variability and uncertainty

4.1 SAR measurement variability

Per KDB865664 D01 SAR measurement 100 MHz to 6 GHz v01r04, SAR measurement variability must be assessed for each frequency band, which is determined by the SAR probe calibration point and tissue-equivalent medium used for the device measurements. The additional measurements are repeated after the completion of all measurements requiring the same head or body tissue-equivalent medium in a frequency band. The test device should be returned to ambient conditions (normal room temperature) with the battery fully charged before it is re-mounted on the device holder for the repeated measurement(s) to minimize any unexpected variations in the repeated results.

1) Repeated measurement is not required when the original highest measured SAR is < 0.80 W/kg; steps 2) through 4) do not apply.

2) When the original highest measured SAR is ≥ 0.80 W/kg, repeat that measurement once.

3) Perform a second repeated measurement only if the ratio of largest to smallest SAR for the original and first repeated measurements is > 1.20 or when the original or repeated measurement is ≥ 1.45 W/kg ($\sim 10\%$ from the 1-g SAR limit).

4) Perform a third repeated measurement only if the original, first or second repeated measurement is ≥ 1.5 W/kg and the ratio of largest to smallest SAR for the original, first and second repeated measurements is > 1.20 .

The same procedures should be adapted for measurements according to extremity and occupational exposure limits by applying a factor of 2.5 for extremity exposure and a factor of 5 for occupational exposure to the corresponding SAR thresholds.

4.2 SAR measurement uncertainty

Per KDB865664 D01 SAR Measurement 100 MHz to 6 GHz, when the highest measured 1-g SAR within a frequency band is < 1.5 W/kg, the extensive SAR measurement uncertainty analysis described in IEEE Std 1528-2013 is not required in SAR reports submitted for equipment approval. The equivalent ratio (1.5/1.6) is applied to extremity and occupational exposure conditions.

5 Description of Test Position

5.1 The Body Test Position

SAR can test the sides near the antenna, the surface of the device should be tested for SAR compliance with the device touching the phantom. The SAR Exclusion Threshold in KDB 447498 D01 can be applied to determine SAR test exclusion for adjacent edge configurations. The closest distance from the antenna to an adjacent device surface is used to determine if SAR testing is required for the adjacent surfaces, with the adjacent surface positioned against the phantom and the surface containing the antenna positioned perpendicular to the phantom.

Head-mounted products can't direct application to the Head Phantom, adopts Flat Phantom to simulate test the device, so this approach is to use Flat Phantom, Head Liquid to test the device.

6 SAR System Verification Procedure

6.1 Tissue Simulate Liquid

6.1.1 Recipes for Tissue Simulate Liquid

The following tables give the recipes for tissue simulating liquids to be used in different frequency bands:

Ingredients (% by weight)	Frequency (MHz)									
	450		835		915		1900		2450	
Tissue Type	Head	Body	Head	Body	Head	Body	Head	Body	Head	Body
Water	38.56	51.16	41.45	52.4	41.05	56.0	54.9	40.4	62.7	73.2
Salt (NaCl)	3.95	1.49	1.45	1.4	1.35	0.76	0.18	0.5	0.5	0.04
Sugar	56.32	46.78	56.0	45.0	56.5	41.76	0.0	58.0	0.0	0.0
HEC	0.98	0.52	1.0	1.0	1.0	1.21	0.0	1.0	0.0	0.0
Bactericide	0.19	0.05	0.1	0.1	0.1	0.27	0.0	0.1	0.0	0.0
Triton X-100	0.0	0.0	0.0	0.0	0.0	0.0	0.0	0.0	36.8	0.0
DGBE	0.0	0.0	0.0	0.0	0.0	0.0	44.92	0.0	0.0	26.7
Dielectric Constant	43.42	58.0	42.54	56.1	42.0	56.8	39.9	54.0	39.8	52.5
Conductivity (S/m)	0.85	0.83	0.91	0.95	1.0	1.07	1.42	1.45	1.88	1.78

HSL5GHz is composed of the following ingredients:
 Water: 50-65%
 Mineral oil: 10-30%
 Emulsifiers: 8-25%
 Sodium salt: 0-1.5%

MSL5GHz is composed of the following ingredients:
 Water: 64-78%
 Mineral oil: 11-18%
 Emulsifiers: 9-15%
 Sodium salt: 2-3%

Table 3: Recipe of Tissue Simulate Liquid

6.1.2 Test Liquids Confirmation

Simulated tissue liquid parameter confirmation

The dielectric parameters were checked prior to assessment using the SPEAG DAK3.5 dielectric probe kit. The dielectric parameters measured are reported in each correspondent section.

IEEE SCC-34/SC-2 P1528 recommended tissue dielectric parameters

The head tissue dielectric parameters recommended by the IEEE SCC-34/SC-2 in P1528 have been incorporated in the following table. These head parameters are derived from planar layer models simulating the highest expected SAR for the dielectric properties and tissue thickness variations in a human head. Other head and body tissue parameters that have not been specified in P1528 are derived from the tissue dielectric parameters computed from the 4-Cole-Cole equations and extrapolated according to the head parameters specified in P1528

Target Frequency (MHz)	Head		Body	
	ϵ_r	σ (S/m)	ϵ_r	σ (S/m)
150	52.3	0.76	61.9	0.80
300	45.3	0.87	58.2	0.92
450	43.5	0.87	56.7	0.94
835	41.5	0.90	55.2	0.97
900	41.5	0.97	55.0	1.05
915	41.5	0.98	55.0	1.06
1450	40.5	1.20	54.0	1.30
1610	40.3	1.29	53.8	1.40
1800-2000	40.0	1.40	53.3	1.52
2450	39.2	1.80	52.7	1.95
3000	38.5	2.40	52.0	2.73
5800	35.3	5.27	48.2	6.00

(ϵ_r = relative permittivity, σ = conductivity and $\rho = 1000 \text{ kg/m}^3$)

6.1.3 Measurement for Tissue Simulate Liquid

The dielectric properties for this Tissue Simulate Liquids were measured by using the Agilent Model 85070E Dielectric Probe in conjunction with Agilent E5071C Network Analyzer (300 KHz-8500 MHz). The Conductivity (σ) and Permittivity (ρ) are listed in bellow table. For the SAR measurement given in this report. The temperature variation of the Tissue Simulate Liquids was $22\pm 2^{\circ}\text{C}$.

Tissue Type	Measured Frequency (MHz)	Target Tissue ($\pm 5\%$)		Measured Tissue		Liquid Temp. ($^{\circ}\text{C}$)	Measured Date
		ϵ_r	$\sigma(\text{S/m})$	ϵ_r	$\sigma(\text{S/m})$		
835 Head	835	41.5 (39.43~43.58)	0.90 (0.86~0.95)	40.798	0.886	22.1	2020/10/15
1800 Head	1800	40.0 (38.00~42.00)	1.40 (1.33~1.47)	40.188	1.443	22.2	2020/10/14
1900 Head	1900	40.0 (38.00~42.00)	1.40 (1.33~1.47)	39.062	1.431	22.3	2020/10/14
2450 Head	2450	39.20 (37.24~41.16)	1.80 (1.71~1.89)	38.226	1.802	21.8	2020/10/16
2600 Head	2600	39.0 (37.05~40.95)	1.96 (1.86~2.06)	37.767	1.968	22.1	2020/10/16

Table 4: Measurement result of Tissue electric parameters

6.2 SAR System Check

The microwave circuit arrangement for system check is sketched in bellow figure. The daily system accuracy verification occurs within the flat section of the SAM phantom. A SAR measurement was performed to see if the measured SAR was within +/- 10% from the target SAR values. The tests were conducted on the same days as the measurement of the EUT. The obtained results from the system accuracy verification are displayed in the following table. During the tests, the ambient temperature of the laboratory was in the range $22\pm 2^{\circ}\text{C}$, the relative humidity was in the range 60% and the liquid depth above the ear reference points was above 15 cm in all the cases. It is seen that the system is operating within its specification, as the results are within acceptable tolerance of the reference values.

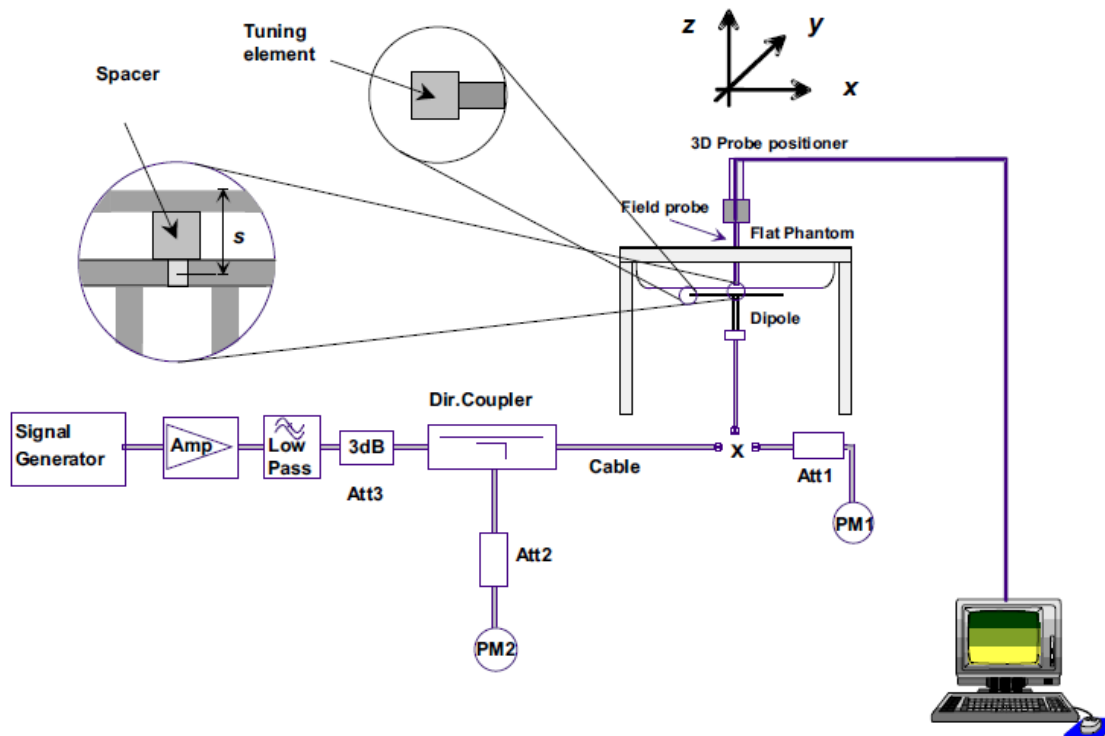

F-3. the microwave circuit arrangement used for SAR system verification

6.2.1 Justification for Extended SAR Dipole Calibrations

1) Referring to KDB865664 D01 requirements for dipole calibration, instead of the typical annual calibration recommended by measurement standards, longer calibration intervals of up to three years may be considered when it is demonstrated that the SAR target, impedance and return loss of a dipole have remain stable according to the following requirements. Each measured dipole is expected to evaluate with the following criteria at least on annual interval in Appendix C.

- a) There is no physical damage on the dipole;
- b) System check with specific dipole is within 10% of calibrated value;
- c) Return-loss is within 10% of calibrated measurement;
- d) Impedance is within 5Ω from the previous measurement.

2) Network analyzer probe calibration against air, distilled water and a shorting block performed before measuring liquid parameters.

6.2.2 Summary System Check Result(s)

Validation Kit		Measured SAR 250mW	Measured SAR 250mW	Measured SAR (normalized to 1w)	Measured SAR (normalized to 1w)	Target SAR (normalized to 1w) (±10%)	Target SAR (normalized to 1w) (±10%)	Liquid Temp. (°C)	Measured Date
		1g (W/kg)	10g (W/kg)	1g (W/kg)	10g (W/kg)	1-g(W/kg)	10-g(W/kg)		
D835 V2	Head	2.37	1.54	9.48	6.16	9.41 (8.47~10.35)	6.25 (5.63~6.88)	22.1	2020/10/15
D1800 V2	Head	9.89	5.1	39.56	20.4	38.4 (34.56~42.24)	20.2 (18.18~22.22)	22.2	2020/10/14
D1900 V2	Head	10.1	5.06	40.44	20.24	39.7 (35.73~43.67)	20.5 (18.45~22.55)	22.3	2020/10/14
D2450 V2	Head	12	5.9	48	23.6	53 (47.70~58.30)	24.6 (22.14~27.60)	21.8	2020/10/16
D2600 V2	Head	12.9	6.1	51.6	24.4	56.2 (50.58~61.82)	25 (22.50~27.50)	22.1	2020/10/16

Table 5: SAR System Check Result

6.2.3 Detailed System Check Results

Please see the Appendix A

7 Test Configuration

7.1 3G SAR Test Reduction Procedure

According to KDB 941225D01, in the following procedures, the mode tested for SAR is referred to as the primary mode. The equivalent modes considered for SAR test reduction are denoted as secondary modes. Both primary and secondary modes must be in the same frequency band. When the maximum output power and tune-up tolerance specified for production units in a secondary mode is $\leq \frac{1}{4}$ dB higher than the primary mode or when the highest reported SAR of the primary mode is scaled by the ratio of specified maximum output power and tune-up tolerance of secondary to primary mode and the adjusted SAR is ≤ 1.2 W/kg, SAR measurement is not required for the secondary mode. This is referred to as the 3G SAR test reduction procedure in the following SAR test guidance, where the primary mode is identified in the applicable wireless mode test procedures and the secondary mode is wireless mode being considered for SAR test reduction by that procedure. When the 3G SAR test reduction procedure is not satisfied, it is identified as “otherwise” in the applicable procedures; SAR measurement is required for the secondary mode.

7.2 Operation Configurations

7.2.1 WCDMA Test Configuration

SAR tests for GSM 850 and GSM 1900, a communication link is set up with a base station by air link. Using CMW500 the power level is set to “5” and “0” in SAR of GSM 850 and GSM 1900. The tests in the band of GSM 850 and GSM 1900 are performed in the mode of GPRS/EGPRS function. Since the GPRS class is 33 for this EUT, it has at most 4 timeslots in uplink and at most 5 timeslots in downlink, the maximum total timeslot is 6. The EGPRS class is 33 for this EUT, it has at most 4 timeslots in uplink, and at most 5 timeslots in downlink, the maximum total timeslot is 6.

SAR test reduction for GPRS and EDGE modes is determined by the source-based time-averaged output power specified for production units, including tune-up tolerance. The data mode with highest specified time-averaged output power should be tested for SAR compliance in the applicable exposure conditions. For modes with the same specified maximum output power and tolerance, the higher number time-slot configuration should be tested.

When SAR tests for EGPRS mode is necessary, GMSK modulation should be used to minimize SAR measurement error due to higher peak-to-average power (PAR) ratios inherent in 8-PSK.

The 3G SAR test reduction procedure is applied to 8-PSK EDGE with GMSK GPRS/EDGE as the primary mode.

7.2.2 WCDMA Test Configuration

1) . Output Power Verification

Maximum output power is verified on the high, middle and low channels according to procedures described in section 5.2 of 3GPP TS 34.121, using the appropriate RMC or AMR with TPC (transmit power control) set to all “1’s” for WCDMA/HSDPA or by applying the required inner loop power control procedures to maintain maximum output power while HSUPA is active. Results for all applicable physical channel configurations (DPCCH, DPDCHn and spreading codes, HSDPA, HSPA) are required in the SAR report. All configurations that are not supported by the handset or cannot be measured due to technical or equipment limitations must be clearly identified.

2) . Head SAR

SAR for next to the ear head exposure is measured using a 12.2 kbps RMC with TPC bits configured to all “1’s”. The 3G SAR test reduction procedure is applied to AMR configurations with 12.2 kbps RMC as the primary mode. Otherwise, SAR is measured for 12.2 kbps AMR in 3.4 kbps SRB (signaling radio bearer) using the highest reported SAR configuration in 12.2 kbps RMC for head exposure

3) . Body SAR

SAR for body configurations is measured using a 12.2 kbps RMC with TPC bits configured to all “1’s”. The 3G SAR test reduction procedure is applied to other spreading codes and multiple DPDCHn configurations supported by the handset with 12.2 kbps RMC as the primary mode. Otherwise, SAR is measured using an applicable RMC configuration with the corresponding spreading code or DPDCHn, for the highest reported body-worn accessory exposure SAR configuration in 12.2 kbps RMC. When more than 2 DPDCHn are supported by the handset, it may be necessary to configure additional DPDCHn using FTM (Factory Test Mode) or other chipset based test approaches with parameters similar to those used in 384 kbps and 768 kbps RMC.

4) . HSDPA / HSUPA / DC-HSDPA

According to KDB 941225 D01v03, RMC 12.2kbps setting is used to evaluate SAR. If the maximum output power and tune-up tolerance specified for production units in HSDPA / HSUPA / DC-HSDPA is $\leq \frac{1}{4}$ dB higher than RMC 12.2Kbps or when the highest reported SAR of the RMC12.2Kbps is scaled by the ratio of specified maximum output power and tune-up tolerance of HSDPA / HSUPA / DC-HSDPA to RMC12.2Kbps and the adjusted SAR is ≤ 1.2 W/kg, SAR measurement is not required for HSDPA / HSUPA / DC-HSDPA

a) HSDPA

HSDPA is configured according to the applicable UE category of a test device. The number of HS-DSCH/HS-PDSCHs, HARQ processes, minimum inter-TTI interval, transport block sizes and RV coding sequence are defined by the H-set. To maintain a consistent test configuration and stable transmission conditions, QPSK is used in the H-set for SAR testing. HS-DPCCH should be configured with a CQI feedback cycle of 4 ms and a CQI repetition factor of 2 to maintain a constant rate of active CQI slots. DPCCH and DPDCH gain factors (β_c , β_d), and HS-DPCCH power offset parameters (Δ_{ACK} , Δ_{NACK} , Δ_{CQI}) are set according to values indicated in the following table. The CQI value is determined by the UE category, transport block size, number of HS-PDSCHs and modulation used in the H-set.

Sub-test	β_c	Bd	β_d (SF)	β_c/β_d	β_{hs}	CM(dB)	MPR (dB)
1	2/15	15/15	64	2/15	4/15	0.0	0
2	12/15(3)	15/15(3)	64	12/15(3)	24/15	1.0	0
3	15/15	8/15	64	15/8	30/15	1.5	0.5
4	15/15	4/15	64	15/4	30/15	1.5	0.5

Note1: ΔACK , ΔNACK and $\Delta\text{CQI} = 8$ $A_{hs} = \beta_{hs}/\beta_c = 30/15$ $\beta_{hs} = 30/15 * \beta_c$

Note2: For the HS-DPCCH power mask requirement test in clause 5.2C, 5.7A, and the Error Vector Magnitude (EVM) with HS-DPCCH test in clause 5.13.1.A, and HSDPA EVM with phase discontinuity in clause 5.13.1AA, ΔACK and $\Delta\text{NACK} = 8$ ($A_{hs} = 30/15$) with $\beta_{hs} = 30/15 * \beta_c$, and $\Delta\text{CQI} =$

7 ($A_{hs} = 24/15$) with $\beta_{hs} = 24/15 * \beta_c$.

Note3: $CM = 1$ for $\beta_c/\beta_d = 12/15$, $\beta_{hs}/\beta_c = 24/15$. For all other combinations of DPDCH, DPCCH and HS-DPCCH the MPR is based on the relative CM difference. This is applicable for only UEs that support HSDPA in release 6 and later releases.

The measurements were performed with a Fixed Reference Channel (FRC) and H-Set 1 QPSK.

Parameter	Value
Nominal average inf. bit rate	534 kbit/s
Inter-TTI Distance	3 TTI"s
Number of HARQ Processes	2 Processes
Information Bit Payload	3202 Bits
MAC-d PDU size	336 Bits
Number Code Blocks	1 Block
Binary Channel Bits Per TTI	4800 Bits
Total Available SMLs in UE	19200 SMLs
Number of SMLs per HARQ Process	9600 SMLs
Coding Rate	0.67
Number of Physical Channel Codes	5

Table 6: settings of required H-Set 1 QPSK acc. to 3GPP 34.121

HS-DSCH Category	Maximum HS-DSCH Codes Received	Minimum Inter-TTI Interval	Maximum HS-DSCH Transport Block Bits/HS-DSCH TTI	Total Soft Channel Bits
1	5	3	7298	19200
2	5	3	7298	28800
3	5	2	7298	28800
4	5	2	7298	38400
5	5	1	7298	57600
6	5	1	7298	67200
7	10	1	14411	115200
8	10	1	14411	134400
9	15	1	25251	172800
10	15	1	27952	172800
11	5	2	3630	14400
12	5	1	3630	28800
13	15	1	34800	259200
14	15	1	42196	259200
15	15	1	23370	345600
16	15	1	27952	345600

Table 7: HSDPA UE category

b) HSUPA

Due to inner loop power control requirements in HSUPA, a commercial communication test set should be used for the output power and SAR tests. The 12.2 kbps RMC, FRC H-set 1 and E-DCH configurations for HSUPA should be configured according to the values indicated below as well as other applicable procedures described in the „WCDMA Handset“ and „Release 5 HSUPA Data Device“ sections of 3G device.

Sub-test ¹	β_c ²	β_{d1} ²	β_d (SF) ³	β_c/β_{d1}	β_{hs} ⁽¹⁾	β_{ec} ²	β_{ed} ²	β_c (SF) ²	β_{ed} (code) ²	CM ⁽²⁾ (dB) ²	MP R ² (dB) ²	AG ⁽⁴⁾ Index ²	E-TFC I ²
1 ²	11/15 ⁽³⁾ ²	15/15 ⁽³⁾ ²	64 ²	11/15 ⁽³⁾ ²	22/15 ²	209/225 ²	1039/225 ²	4 ²	1 ²	1.0 ²	0.0 ²	20 ²	75 ²
2 ²	6/15 ²	15/15 ²	64 ²	6/15 ²	12/15 ²	12/15 ²	94/75 ²	4 ²	1 ²	3.0 ²	2.0 ²	12 ²	67 ²
3 ²	15/15 ²	9/15 ²	64 ²	15/9 ²	30/15 ²	30/15 ²	$\beta_{ed1}:47/15$ $\beta_{ed2}:47/15$ ²	4 ²	2 ²	2.0 ²	1.0 ²	15 ²	92 ²
4 ²	2/15 ²	15/15 ²	64 ²	2/15 ²	4/15 ²	2/15 ²	56/75 ²	4 ²	1 ²	3.0 ²	2.0 ²	17 ²	71 ²
5 ²	15/15 ⁽⁴⁾ ²	15/15 ⁽⁴⁾ ²	64 ²	15/15 ⁽⁴⁾ ²	30/15 ²	24/15 ²	134/15 ²	4 ²	1 ²	1.0 ²	0.0 ²	21 ²	81 ²

Note 1: $\Delta ACK, \Delta NACK$ and $\Delta CQI=8$ $A_{hs} = \beta_{hs}/\beta_c = 30/15$ $\beta_{hs} = 30/15 * \beta_c$
 Note 2: CM = 1 for $\beta_c/\beta_d = 12/15, \beta_{hs}/\beta_c = 24/15$. For all other combinations of DPDCH, DPCCH, HS-DPCCH, E-DPDCH and E-DPCCH the MPR is based on the relative CM difference²
 Note 3 : For subtest 1 the β_c/β_{d1} ratio of 11/15 for the TFC during the measurement period (TF1, TF0) is achieved by setting the signalled gain factors for the reference TFC (TF1, TF1) to $\beta_c = 10/15$ and $\beta_{d1} = 15/15$ ²
 Note 4 : For subtest 5 the β_c/β_{d1} ratio of 15/15 for the TFC during the measurement period (TF1, TF0) is achieved by setting the signalled gain factors for the reference TFC (TF1, TF1) to $\beta_c = 14/15$ and $\beta_{d1} = 15/15$ ²
 Note 5 : Testing UE using E-DPDCH Physical Layer category 1 Sub-test 3 is not required according to TS 25.306 Table 5.1g²
 Note 6: β_{ed} can not be set directly; it is set by Absolute Grant Value.²

Table 8: Subtests for WCDMA Release 6 HSUPA

UE E-DCH Category	Maximum E-DCH Codes Transmitted	Number of HARQ Processes	E-DCH TTI(ms)	Minimum Spreading Factor	Maximum E-DCH Transport Block Bits	Max Rate (Mbps)
1	1	4	10	4	7110	0.7296
2	2	8	2	4	2798	1.4592
	2	4	10	4	14484	
3	2	4	10	4	14484	1.4592
4	2	8	2	2	5772	2.9185
	2	4	10	2	20000	2.00
5	2	4	10	2	20000	2.00
6 (No DPDCH)	4	8	10	2SF2&2SF	11484	5.76
	4	4	2	4	20000	2.00
7 (No DPDCH)	4	8	2	2SF2&2SF	22996	?
	4	4	10	4	20000	?

NOTE: When 4 codes are transmitted in parallel, two codes shall be transmitted with SF2 and two with SF4. UE categories 1 to 6 support QPSK only. UE category 7 supports QPSK and 16QAM.(TS25.306-7.3.0).

Table 9: HSUPA UE category

c) DC-HSDPA

SAR is required for Rel. 8 DC-HSDPA when SAR is required for Rel. 5 HSDPA; otherwise, the 3G SAR test reduction procedure is applied to DC-HSDPA with 12.2 kbps RMC as the primary mode. Power is measured for DC-HSDPA according to the H-Set 12, FRC configuration in Table C.8.1.12 of 3GPP TS 34.121-1 to determine SAR test reduction. A primary and a Second serving HS-DSCH Cell are required to perform the power measurement and for the results to be acceptable.

The following tests were completed according to procedures in section 7.3.13 of 3GPP TS 34.108 v9.5.0.

A summary of these settings are illustrated below:

Downlink Physical Channels are set as per 3GPP TS34.121-1 v9.0.0 E.5.0

Table E.5.0: Levels for HSDPA connection setup

Parameter During Connection setup	Unit	Value
P-CPICH_Ec/Ior	dB	-10
P-CCPCH and SCH_Ec/Ior	dB	-12
PICH_Ec/Ior	dB	-15
HS-PDSCH	dB	off
HS-SCCH_1	dB	off
DPCH_Ec/Ior	dB	-5
OCNS_Ec/Ior	dB	-3.1

Call is set up as per 3GPP TS34.108 v9.5.0 sub clause 7.3.13.

The configurations of the fixed reference channels for HSDPA RF tests are described in 3GPP TS 34.121, annex C for FDD and 3GPP TS 34.122.

The measurements were performed with a Fixed Reference Channel (FRC) H-Set 12 with QPSK.

Parameter	Value
Nominal average inf. bit rate	60 kbit/s
Inter-TTI Distance	1 TTI's
Number of HARQ Processes	6 Processes
Information Bit Payload	120 Bits
Number Code Blocks	1 Block
Binary Channel Bits Per TTI	960 Bits
Total Available SMLs in UE	19200 SMLs
Number of SMLs per HARQ Process	3200 SMLs
Coding Rate	0.15
Number of Physical Channel Codes	1

Table 2: settings of required H-Set 12 QPSK acc. to 3GPP 34.121

Note:

1. The RMC is intended to be used for DC-HSDPA mode and both cells shall transmit with identical parameters as listed in the table above.
2. Maximum number of transmission is limited to 1, i.e., retransmission is not allowed. The redundancy and constellation version 0 shall be used.

7.2.3 Wi-Fi Test Configuration

A Wi-Fi device must be configured to transmit continuously at the required data rate, channel bandwidth and signal modulation, using the highest transmission duty factor supported by the test mode tools for SAR measurement.

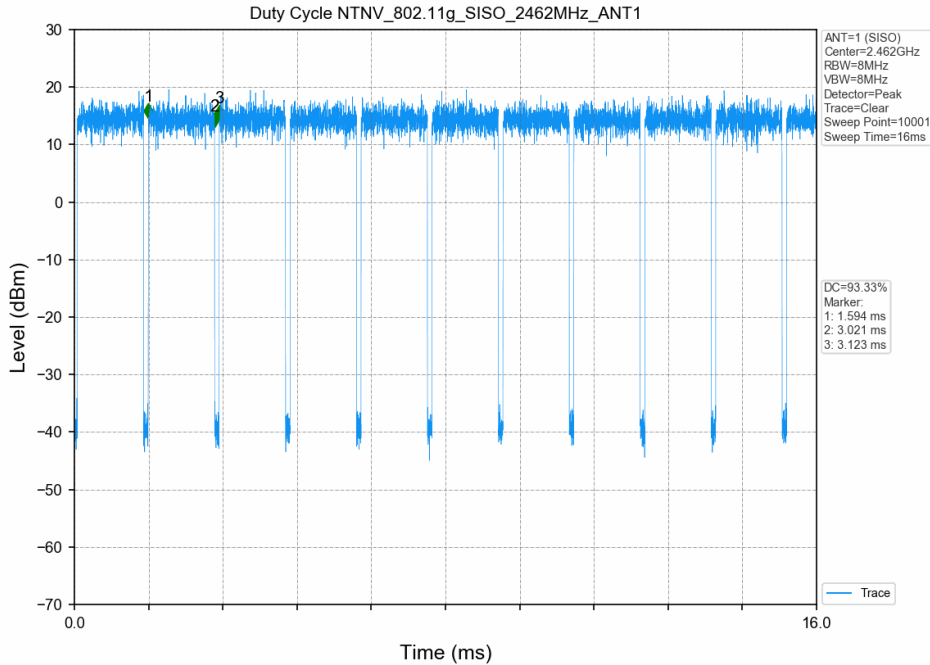

7.2.3.1 Duty cycle

1) 2.4GHz Wi-Fi 802.11g:

$$\text{Wi-Fi 802.11g 6M: Duty cycle} = (3.021 - 1.594) / (3.123 - 1.594) = 93.33\%$$

7.2.3.2 Initial Test Position SAR Test Reduction Procedure

DSSS and OFDM configurations are considered separately according to the required SAR procedures. SAR is measured in the initial test position using the 802.11 transmission mode configuration required by the DSSS procedure or initial test configuration and subsequent test configuration(s) according to the OFDM procedures. The initial test position procedure is described in the following:

- 1) .When the reported SAR of the initial test position is ≤ 0.4 W/kg, further SAR measurement is not required for the other (remaining) test positions in that exposure configuration and 802.11 transmission mode combinations within the frequency band or aggregated band. SAR is also not required for that exposure configuration in the subsequent test configuration(s).
- 2) .When the reported SAR of the initial test position is > 0.4 W/kg, SAR is repeated for the 802.11 transmission mode configuration tested in the initial test position using subsequent highest extrapolated or estimated 1-g SAR conditions determined by area scans or next closest/smallest test separation distance and maximum RF coupling test positions based on manufacturer justification, on the highest maximum output power channel, until the reported SAR is ≤ 0.8 W/kg or all required test positions (left, right, touch, tilt or subsequent surfaces and edges) are tested.
- 3) .For all positions/configurations tested using the initial test position and subsequent test positions, when the reported SAR is > 0.8 W/kg, SAR is measured for these test positions/configurations on the subsequent next highest measured output power channel(s) until the reported SAR is ≤ 1.2 W/kg or all required channels are tested. a) Additional

power measurements may be required for this step, which should be limited to those necessary for identifying the subsequent highest output power channels.

7.2.3.3 Initial Test Configuration Procedures

An initial test configuration is determined for OFDM transmission modes according to the channel bandwidth, modulation and data rate combination(s) with the highest maximum output power specified for production units in each standalone and aggregated frequency band. SAR is measured using the highest measured maximum output power channel. For configurations with the same specified or measured maximum output power, additional transmission mode and test channel selection procedures are required. SAR test reduction for subsequent highest output test channels is determined according to *reported* SAR of the initial test configuration.

For next to the ear, hotspot mode and UMC mini-tablet exposure configurations where multiple test positions are required, the initial test position procedure is applied to minimize the number of test positions required for SAR measurement using the initial test configuration transmission mode. For fixed exposure conditions that do not have multiple SAR test positions, SAR is measured in the transmission mode determined by the initial test configuration.

When the *reported* SAR of the initial test configuration is > 0.8 W/kg, SAR measurement is required for subsequent next highest measured output power channel(s) in the initial test configuration until *reported* SAR is ≤ 1.2 W/kg or all required channels are tested.

7.2.3.4 Subsequent Test Configuration Procedures

SAR measurement requirements for the remaining 802.11 transmission mode configurations that have not been tested in the initial test configuration are determined separately for each standalone and aggregated frequency band, in each exposure condition, according to the maximum output power specified for production units. The initial test position procedure is applied to next to the ear, UMPC mini-tablet and hotspot mode configurations. When the same maximum output power is specified for multiple transmission modes, additional power measurements may be required to determine if SAR measurements are required for subsequent highest output power channels in a subsequent test configuration. The subsequent test configuration and SAR measurement procedures are described in the following.

- 1) . When SAR test exclusion provisions of KDB Publication 447498 are applicable and SAR measurement is not required for the initial test configuration, SAR is also not required for the next highest maximum output power transmission mode subsequent test configuration(s) in that frequency band or aggregated band and exposure configuration.
- 2) . When the highest *reported* SAR for the initial test configuration (when applicable, include subsequent highest output channels), according to the initial test position or fixed exposure position requirements, is adjusted by the ratio of the subsequent test configuration to initial test configuration specified maximum output power and the adjusted SAR is ≤ 1.2 W/kg, SAR is not required for that subsequent test configuration.
- 3) . The number of channels in the initial test configuration and subsequent test configuration can be different due to differences in channel bandwidth. When SAR measurement is required for a subsequent test configuration and the channel bandwidth is smaller than that in the initial test configuration, all channels in the subsequent test configuration that overlap with the larger bandwidth channel tested in the initial test configuration should be used to determine the highest maximum output power channel. This step requires additional power measurement to identify the highest maximum output power channel in the subsequent test configuration to determine SAR test reduction.
 - a) SAR should first be measured for the channel with highest measured output power in the subsequent test configuration.
 - b) SAR for subsequent highest measured maximum output power channels in the subsequent test configuration is required only when the *reported* SAR of the preceding higher maximum output power channel(s) in the subsequent test configuration is > 1.2 W/kg or until all required channels are tested. i) For channels with the same measured maximum output power, SAR should be measured using the channel closest to the center frequency of the larger channel bandwidth channel in the initial test configuration.
- 4) . SAR measurements for the remaining highest specified maximum output power OFDM transmission mode configurations that have not been tested in the initial test configuration (highest maximum output) or subsequent test configuration(s) (subsequent next highest maximum output power) is determined by recursively applying the subsequent test configuration procedures in this section to the remaining configurations according to the following:

- a) replace “subsequent test configuration” with “next subsequent test configuration” (i.e., subsequent next highest specified maximum output power configuration)
- b) replace “initial test configuration” with “all tested higher output power configurations”

7.2.3.5 2.4 GHz Wi-Fi SAR Procedures

Separate SAR procedures are applied to DSSS and OFDM configurations in the 2.4 GHz band to simplify DSSS test requirements. For 802.11b DSSS SAR measurements, DSSS SAR procedure applies to fixed exposure test position and initial test position procedure applies to multiple exposure test positions. When SAR measurement is required for an OFDM configuration, the initial test configuration, subsequent test configuration and initial test position procedures are applied. The SAR test exclusion requirements for 802.11g/n OFDM configurations are described in following.

- **802.11b DSSS SAR Test Requirements**

SAR is measured for 2.4 GHz 802.11b DSSS using either a fixed test position or, when applicable, the initial test position procedure. SAR test reduction is determined according to the following:

- 1) . When the reported SAR of the highest measured maximum output power channel for the exposure configuration is ≤ 0.8 W/kg, no further SAR testing is required for 802.11b DSSS in that exposure configuration.
- 2) . When the reported SAR is > 0.8 W/kg, SAR is required for that exposure configuration using the next highest measured output power channel. When any reported SAR is > 1.2 W/kg, SAR is required for the third channel; i.e., all channels require testing.

- **2.4 GHz 802.11g/n OFDM SAR Test Exclusion Requirements**

When SAR measurement is required for 2.4 GHz 802.11g/n OFDM configurations, the measurement and test reduction procedures for OFDM are applied (section 5.3, including sub-sections). SAR is not required for the following 2.4 GHz OFDM conditions.

- 1) . When KDB Publication 447498 SAR test exclusion applies to the OFDM configuration.
- 2) . When the highest reported SAR for DSSS is adjusted by the ratio of OFDM to DSSS specified maximum output power and the adjusted SAR is ≤ 1.2 W/kg.

7.2.4 BluetoothTest Configuration

For the Bluetooth SAR tests, a communication link is set up with the test mode software for BT mode test. Bluetooth USES frequency hopping technology to divide the transmitted data into packets and transmit the packets respectively through 79 designated Bluetooth channels, 1MHz Bandwidth, frequency hops at 1600 hops/second per the Bluetooth standard. The Radio Frequency Channel Number (RFCN) is allocated to 0, 39 and 78 respectively in the case of 2402~2480 MHz during the test at each test frequency channel, the EUT is operated at the RF continuous emission mode.

7.2.5 LTE Test Configuration

LTE modes were tested according to FCC KDB 941225 D05 publication. Please see notes after the tabulated SAR data for required test configurations. Establishing connections with base station simulators ensure a consistent means for testing SAR and are recommended for evaluating SAR [4]. The R&S CMW500 was used for LTE output power measurements and SAR testing. Max power control was used so the UE transmits with maximum output power during SAR testing. SAR must be measured with the maximum TTI (transmit time interval) supported by the device in each LTE configuration.

A) Spectrum Plots for RB Configurations

A properly configured base station simulator was used for SAR tests and power measurements. Therefore, spectrum plots for RB configurations were not required to be included in this report.

B) MPR

MPR is permanently implemented for this device by the manufacturer. The specific manufacturer target MPR is indicated alongside the SAR results. MPR is enabled for this device, according to 3GPP TS36.101 V13.5.0 (201609) Section 6.2.3 – 6.2.5 under Table 6.2.3-1.

Modulation	Channel bandwidth / Transmission bandwidth (N_{RB})						MPR (dB)
	1.4 MHz	3.0 MHz	5 MHz	10 MHz	15 MHz	20 MHz	
QPSK	> 5	> 4	> 8	> 12	> 16	> 18	≤ 1
16 QAM	≤ 5	≤ 4	≤ 8	≤ 12	≤ 16	≤ 18	≤ 1
16 QAM	> 5	> 4	> 8	> 12	> 16	> 18	≤ 2

C) A-MPR

A-MPR (Additional MPR) has been disabled for all SAR tests by setting NS=01 on the base station simulator.

D) Largest channel bandwidth standalone SAR test requirements

1) QPSK with 1 RB allocation

Start with the largest channel bandwidth and measure SAR for QPSK with 1 RB allocation, using the RB offset and required test channel combination with the highest maximum output power for RB offsets at the upper edge, middle and lower edge of each required test channel. When the reported SAR is ≤ 0.8 W/kg, testing of the remaining RB offset configurations and required test channels is not required for 1 RB allocation; otherwise, SAR is required for the remaining required test channels and only for the RB offset configuration with the highest output power for that channel. When the reported SAR of a required test channel is > 1.45 W/kg, SAR is required for all three RB offset configurations for that required test channel.

2) QPSK with 50% RB allocation

The procedures required for 1 RB allocation in 1) are applied to measure the SAR for QPSK with 50% RB allocation.

3) QPSK with 100% RB allocation

For QPSK with 100% RB allocation, SAR is not required when the highest maximum output power for 100 % RB allocation is less than the highest maximum output power in 50% and 1 RB allocations and the highest reported SAR for 1 RB and 50% RB allocation in 1) and 2) are ≤ 0.8 W/kg. Otherwise, SAR is measured for the highest output power channel and if the reported SAR is > 1.45 W/kg, the remaining required test channels must also be tested.

4) Higher order modulations

For each modulation besides QPSK; e.g., 16-QAM, 64-QAM, apply the QPSK procedures in above sections to determine the QAM configurations that may need SAR measurement. For each configuration identified as required for testing, SAR is required only when the highest maximum output power for the configuration in the higher order modulation is > ½ dB higher than the same configuration in QPSK or when the reported SAR for the QPSK configuration is > 1.45 W/kg.

E) Other channel bandwidth standalone SAR test requirements

For the other channel bandwidths used by the device in a frequency band, apply all the procedures required for the largest channel bandwidth in section A) to determine the channels and RB configurations that need SAR testing and only measure SAR when the highest maximum output power of a configuration requiring testing in the smaller channel bandwidth is $> \frac{1}{2}$ dB higher than the equivalent channel configurations in the largest channel bandwidth configuration or the reported SAR of a configuration for the largest channel bandwidth is > 1.45 W/kg..

8 Test Result

8.1 Measurement of RF Conducted Power

8.1.1 Conducted Power Of GSM

GSM 850										
Burst Output Power(dBm)					Tune up	Division Factors	Frame-Average Output Power(dBm)			Tune up
Channel	128	190	251				128	190	251	
GPRS/ EGPRS (GMSK)	1 TX Slot	33.75	33.48	33.65	34	-9.19	24.56	24.29	24.46	24.81
	2 TX Slots	33.65	33.42	33.6	34	-6.18	27.47	27.24	27.42	27.82
	3 TX Slots	30.95	30.78	30.84	31.5	-4.42	26.53	26.36	26.42	27.08
	4 TX Slots	29.6	29.54	29.61	30	-3.17	26.43	26.37	26.44	26.83
EGPRS (8PSK)	1 TX Slot	29.56	29.4	29.58	30	-9.19	20.37	20.21	20.39	20.81
	2 TX Slots	28.48	28.35	28.51	29	-6.18	22.3	22.17	22.33	22.82
	3 TX Slots	28.33	28.24	28.3	29	-4.42	23.91	23.82	23.88	24.58
	4 TX Slots	28.14	28.13	28.19	29	-3.17	24.97	24.96	25.02	25.83
GSM 1900										
Burst Output Power(dBm)					Tune up	Division Factors	Frame-Average Output Power(dBm)			Tune up
Channel	512	661	810				512	661	810	
GPRS/ EGPRS (GMSK)	1 TX Slot	29.84	29.82	29.89	30	-9.19	20.65	20.63	20.7	20.81
	2 TX Slots	29.79	29.76	29.85	30	-6.18	23.61	23.58	23.67	23.82
	3 TX Slots	29.67	29.73	29.79	30	-4.42	25.25	25.31	25.37	25.58
	4 TX Slots	29.57	29.61	29.71	30	-3.17	26.4	26.44	26.54	26.83
EGPRS (8PSK)	1 TX Slot	28.73	28.81	28.82	29	-9.19	19.54	19.62	19.63	19.81
	2 TX Slots	27.63	27.72	27.74	28	-6.18	21.45	21.54	21.56	21.82
	3 TX Slots	27.15	27.21	27.12	28	-4.42	22.73	22.79	22.7	23.58
	4 TX Slots	26.51	26.64	26.68	27	-3.17	23.34	23.47	23.51	23.83

Table 10: Conducted Power Of GSM

Note:

1) CMW500 measures GSM peak and average output power for active timeslots. For SAR the time-based average power is relevant. The difference in between depends on the duty cycle of the TDMA signal:

No. of timeslots	1	2	3	4
Duty Cycle	1:8.3	1:4.15	1:2.77	1:2.075
Time based avg. power compared to slotted avg. power	-9.19	-6.18	-4.42	-3.17

2) The frame-averaged power is linearly proportion to the slot number configured and it is linearly scaled the maximum burst-averaged power based on time slots.

8.1.2 Conducted Power Of WCDMA

WCDMA Band II					
Average Conducted Power(dBm)					
Channel		9262	9400	9538	Tune up
WCDMA	12.2kbps RMC	23.78	23.78	23.57	24
HSDPA	Subtest 1	22.89	22.8	22.88	23
	Subtest 2	22.81	22.7	22.71	23
	Subtest 3	22.32	22.3	22.33	23
	Subtest 4	22.31	22.37	22.39	23
HSUPA	Subtest 1	23.19	23.19	22.98	23.5
	Subtest 2	21.85	21.85	21.64	22
	Subtest 3	22.58	22.58	22.53	23
	Subtest 4	21.8	21.8	21.62	23
	Subtest 5	23.25	23.25	23.04	23.5
DC-HSDPA	Subtest 1	23.24	23.2	22.99	23.5
	Subtest 2	23.23	23.19	22.98	23.5
	Subtest 3	22.72	22.68	22.47	23.5
	Subtest 4	22.71	22.77	22.45	23.5
WCDMA Band V					
Average Conducted Power(dBm)					
Channel		4132	4182	4233	Tune up
WCDMA	12.2kbps RMC	23.8	23.98	23.89	24.5
HSDPA	Subtest 1	23.88	23.91	23.92	24
	Subtest 2	23.84	23.89	23.9	24
	Subtest 3	23.61	23.7	23.69	24
	Subtest 4	23.62	23.64	23.63	24
HSUPA	Subtest 1	23.63	23.9	23.81	24
	Subtest 2	21.88	22.06	21.97	23
	Subtest 3	22.7	22.88	22.79	23
	Subtest 4	21.89	22.07	21.98	23
	Subtest 5	23.68	23.86	23.77	24
DC-HSDPA	Subtest 1	23.15	23.33	23.24	24
	Subtest 2	23.24	23.31	23.23	24
	Subtest 3	22.73	22.8	22.72	24
	Subtest 4	22.72	22.79	22.71	24

Table 11: Conducted Power Of WCDMA

8.1.3 Conducted Power Of LTE

LTE Band 2				Conducted Power(dBm)			
Bandwidth	Modulation	RB size	RB offset	Channel	Channel	Channel	Tune up
				18607	18900	19193	
1.4MHz	QPSK	1	0	23.03	23.66	23.44	24
		1	2	23.52	23.61	23.56	24
		1	5	23.46	23.58	23.24	24
		3	0	23.36	23.57	23.14	24
		3	2	23.37	23.6	23.17	24
		3	3	23.39	23.55	23.29	24
		6	0	22.41	22.65	22.27	23
	16QAM	1	0	22.51	22.47	22.71	23
		1	2	22.55	22.91	22.67	23
		1	5	22.22	22.77	22.87	23
		3	0	22.38	22.92	22.61	23
		3	2	22.47	22.57	22.67	23
		3	3	22.59	22.66	22.61	23
		6	0	21.39	21.57	21.59	22
Bandwidth	Modulation	RB size	RB offset	Channel	Channel	Channel	Tune up
3MHz	QPSK	1	0	23.05	23.48	23.47	24
		1	7	23.55	23.38	23.6	24
		1	14	23.49	23.27	23.28	24
		8	0	22.46	22.7	22.27	23
		8	4	22.49	22.84	22.29	23
		8	7	22.49	22.65	22.39	23
		15	0	22.44	22.62	22.3	23
	16QAM	1	0	22.54	22.72	22.74	23
		1	7	22.58	22.78	22.68	23
		1	14	22.24	22.32	22.79	23
		8	0	21.49	21.51	21.73	22
		8	4	21.58	21.63	21.79	22
		8	7	21.69	21.68	21.74	22
		15	0	21.42	21.5	21.62	22
Bandwidth	Modulation	RB size	RB offset	Channel	Channel	Channel	Tune up
5MHz	QPSK	1	0	23.02	23.46	23.43	24
		1	13	23.53	23.34	23.57	24
		1	24	23.46	23.22	23.24	24
		12	0	22.43	22.65	22.23	23
		12	6	22.47	22.8	22.24	23
		12	13	22.47	22.63	22.35	23
		25	0	22.42	22.61	22.28	23
	16QAM	1	0	22.51	22.68	22.71	23
		1	13	22.55	22.76	22.78	23
		1	24	22.21	22.3	22.69	23
		12	0	21.47	21.47	21.7	22

Bandwidth	Modulation	RB size	RB offset	Channel	Channel	Channel	Tune up
				18650	18900	19150	
10MHz	QPSK	12	6	21.55	21.58	21.75	22
		12	13	21.66	21.63	21.7	22
		25	0	21.4	21.46	21.57	22
		1	0	23.04	23.47	23.46	24
		1	25	23.56	23.39	23.61	24
		1	49	23.48	23.26	23.27	24
		25	0	22.46	22.7	22.27	23
	16QAM	25	13	22.5	22.85	22.28	23
		25	25	22.49	22.67	22.4	23
		50	0	22.5	22.63	22.32	23
		1	0	22.53	22.71	22.73	23
		1	25	22.58	22.8	22.63	23
		1	49	22.24	22.32	22.58	23
		25	0	21.5	21.52	21.74	22
15MHz	QPSK	25	13	21.57	21.62	21.78	22
		25	25	21.69	21.68	21.74	22
		50	0	21.43	21.51	21.61	22
		1	0	23.03	23.43	23.44	24
		1	38	23.54	23.38	23.58	24
		1	74	23.45	23.21	23.23	24
		36	0	22.44	22.66	22.24	23
	16QAM	36	18	22.47	22.8	22.24	23
		36	39	22.46	22.64	22.36	23
		75	0	22.48	22.59	22.27	23
		1	0	22.48	22.69	22.71	23
		1	38	22.56	22.77	22.81	23
		1	74	22.21	22.28	22.75	23
		36	0	21.47	21.5	21.71	22
20MHz	QPSK	36	18	21.54	21.57	21.74	22
		36	39	21.67	21.64	21.71	22
		75	0	21.4	21.46	21.57	22
		1	0	23	23.34	23.41	24.5
		1	50	23.53	23.38	23.56	24.5
		1	99	23.43	23.2	23.2	24.5
		50	0	22.41	22.61	22.2	23.5
	16QAM	50	25	22.45	22.76	22.21	23.5
		50	50	22.43	22.59	22.32	23.5
		100	0	22.45	22.54	22.23	23.5
		1	0	22.46	22.65	22.66	23.5
		1	50	22.52	22.75	22.97	23.5
		1	99	22.19	22.25	23.03	23.5
		50	0	21.44	21.46	21.68	22.5

		50	25	21.51	21.55	21.71	22.5
		50	50	21.64	21.59	21.67	22.5
		100	0	21.38	21.42	21.54	22.5

LTE Band 4				Conducted Power(dBm)			
Bandwidth	Modulation	RB size	RB offset	Channel	Channel	Channel	Tune up
				19957	20175	20393	
1.4MHz	QPSK	1	0	23.68	23.84	23.81	24.5
		1	2	23.77	23.6	23.79	24.5
		1	5	23.63	23.71	23.75	24.5
		3	0	23.82	23.9	24.07	24.5
		3	2	23.61	23.85	23.99	24.5
		3	3	23.73	23.62	23.88	24.5
		6	0	23.01	22.79	22.96	23.5
	16QAM	1	0	23.43	22.31	23.15	23.5
		1	2	23.44	22.95	23.23	23.5
		1	5	23.33	22.74	23.19	23.5
		3	0	22.55	22.66	22.64	23.5
		3	2	22.62	22.59	22.57	23.5
		3	3	22.62	22.65	22.58	23.5
		6	0	21.53	21.77	21.64	22.5
Bandwidth	Modulation	RB size	RB offset	Channel	Channel	Channel	Tune up
				19965	20175	20385	
3MHz	QPSK	1	0	23.59	23.88	23.84	24.5
		1	7	23.87	23.65	23.83	24.5
		1	14	23.5	23.76	23.79	24.5
		8	0	22.88	23.02	23.2	23.5
		8	4	22.93	22.95	23.11	23.5
		8	7	23.01	22.73	22.98	23.5
		15	0	22.87	22.83	22.99	23.5
	16QAM	1	0	23.16	22.33	23.18	23.5
		1	7	23.16	23	23.27	23.5
		1	14	22.77	22.78	23.22	23.5
		8	0	21.66	21.79	21.76	22.5
		8	4	21.73	21.72	21.69	22.5
		8	7	21.72	21.77	21.71	22.5
		15	0	21.56	21.81	21.67	22.5
Bandwidth	Modulation	RB size	RB offset	Channel	Channel	Channel	Tune up
				19975	20175	20375	
5MHz	QPSK	1	0	23.56	23.86	23.8	24.5
		1	13	23.85	23.61	23.8	24.5
		1	24	23.47	23.71	23.75	24.5
		12	0	22.85	22.97	23.16	23.5
		12	6	22.91	22.91	23.06	23.5
		12	13	22.99	22.71	22.94	23.5
		25	0	22.85	22.82	22.97	23.5
	16QAM	1	0	23.13	22.29	23.15	23.5

Bandwidth	Modulation	RB size	RB offset	Channel	Channel	Channel	Tune up
				20000	20175	20350	
10MHz	QPSK	1	13	23.13	22.98	23.24	23.5
		1	24	22.74	22.76	23.18	23.5
		12	0	21.64	21.75	21.73	22.5
		12	6	21.7	21.67	21.65	22.5
		12	13	21.69	21.72	21.67	22.5
		25	0	21.54	21.77	21.62	22.5
		25	0	21.54	21.77	21.62	22.5
	16QAM	1	0	23.58	23.87	23.83	24.5
		1	25	23.88	23.66	23.84	24.5
		1	49	23.49	23.75	23.78	24.5
		25	0	22.88	23.02	23.2	23.5
		25	13	22.94	22.96	23.1	23.5
		25	25	23.01	22.75	22.99	23.5
		50	0	22.93	22.84	23.01	23.5
15MHz	QPSK	1	0	23.15	22.32	23.17	23.5
		1	25	23.16	23.02	23.27	23.5
		1	49	22.77	22.78	23.21	23.5
		25	0	21.67	21.8	21.77	22.5
		25	13	21.72	21.71	21.68	22.5
		25	25	21.72	21.77	21.71	22.5
		50	0	21.57	21.82	21.66	22.5
20MHz	QPSK	1	0	23.57	23.83	23.81	24.5
		1	38	23.86	23.65	23.81	24.5
		1	74	23.46	23.7	23.74	24.5
		36	0	22.86	22.98	23.17	23.5
		36	18	22.91	22.91	23.06	23.5
		36	39	22.98	22.72	22.95	23.5
		75	0	22.91	22.8	22.96	23.5
	16QAM	1	0	23.1	22.3	23.15	23.5
		1	38	23.14	22.99	23.25	23.5
		1	74	22.74	22.74	23.18	23.5
		36	0	21.64	21.78	21.74	22.5
		36	18	21.69	21.66	21.64	22.5
		36	39	21.7	21.73	21.68	22.5
		75	0	21.54	21.77	21.62	22.5
20MHz	QPSK	1	0	23.54	23.65	23.78	24.5
		1	50	23.85	23.69	23.79	24.5
		1	99	23.44	23.69	23.71	24.5
		50	0	22.83	22.93	23.13	23.5
		50	25	22.89	22.87	23.03	23.5
		50	50	22.95	22.67	22.91	23.5
		100	0	22.88	22.75	22.92	23.5
	16QAM	1	0	23.08	22.26	23.1	23.5

		1	50	23.1	22.97	23.21	23.5
		1	99	22.72	22.71	23.16	23.5
		50	0	21.61	21.74	21.71	22.5
		50	25	21.66	21.64	21.61	22.5
		50	50	21.67	21.68	21.64	22.5
		100	0	21.52	21.73	21.59	22.5

LTE Band 5				Conducted Power(dBm)			
Bandwidth	Modulation	RB size	RB offset	Channel	Channel	Channel	Tune up
				20407	20525	20643	
1.4MHz	QPSK	1	0	23.59	23.93	23.92	24.5
		1	2	23.91	23.79	23.92	24.5
		1	5	23.84	23.77	24.17	24.5
		3	0	23.93	24.1	23.92	24.5
		3	2	23.88	24.08	23.83	24.5
		3	3	24.02	23.85	23.99	24.5
		6	0	23.07	23.03	23.07	23.5
	16QAM	1	0	23.45	23.35	22.59	23.5
		1	2	23.27	23.43	22.95	23.5
		1	5	23.08	23.11	23.4	23.5
		3	0	22.59	22.69	22.57	23.5
		3	2	22.6	22.42	22.55	23.5
		3	3	22.54	22.59	22.57	23.5
		6	0	21.52	21.72	21.77	22.5
Bandwidth	Modulation	RB size	RB offset	Channel	Channel	Channel	Tune up
3MHz	QPSK	1	0	23.6	24.05	23.94	24.5
		1	7	23.95	23.86	23.97	24.5
		1	14	23.86	23.68	24.2	24.5
		8	0	23.03	23.22	23.05	23.5
		8	4	23.01	23.19	22.94	23.5
		8	7	23.12	23.09	23.1	23.5
		15	0	23.16	23.08	23.12	23.5
	16QAM	1	0	23.47	23.34	22.61	23.5
		1	7	23.3	23.41	22.99	23.5
		1	14	23.1	23.35	23.42	23.5
		8	0	21.71	21.83	21.7	22.5
		8	4	21.7	21.54	21.66	22.5
		8	7	21.64	21.71	21.7	22.5
		15	0	21.56	21.77	21.79	22.5
Bandwidth	Modulation	RB size	RB offset	Channel	Channel	Channel	Tune up
5MHz	QPSK	1	0	23.59	24.01	23.92	24.5
		1	13	23.93	23.85	23.94	24.5
		1	24	23.83	23.63	24.16	24.5
		12	0	23.01	23.18	23.02	23.5
		12	6	22.98	23.14	22.9	23.5

Bandwidth	Modulation	RB size	RB offset	Channel	Channel	Channel	Tune up
				20450	20525	20600	
10MHz	16QAM	12	13	23.09	23.06	23.06	23.5
		25	0	23.14	23.04	23.07	23.5
		1	0	23.42	23.32	22.59	23.5
		1	13	23.28	23.38	22.97	23.5
		1	24	23.07	23.31	23.39	23.5
		12	0	21.68	21.81	21.67	22.5
		12	6	21.67	21.49	21.62	22.5
		12	13	21.62	21.67	21.67	22.5
	25	0	21.53	21.72	21.75	22.5	
	QPSK	1	0	23.56	23.8	23.89	24.5
		1	25	23.92	23.83	24.03	24.5
		1	49	23.81	23.62	24.13	24.5
		25	0	22.98	23.01	23.12	23.5
		25	13	22.96	23.1	22.87	23.5
		25	25	23.01	23.01	23.02	23.5
		50	0	22.91	22.99	23.11	23.5
16QAM		1	0	23.4	23.28	22.54	23.5
	1	25	23.24	23.36	22.93	23.5	
	1	49	23.05	23.28	23.37	23.5	
	25	0	21.65	21.77	21.64	22.5	
	25	13	21.64	21.47	21.59	22.5	
	25	25	21.59	21.62	21.63	22.5	
	50	0	21.51	21.68	21.72	22.5	

LTE Band 7				Conducted Power(dBm)			
Bandwidth	Modulation	RB size	RB offset	Channel	Channel	Channel	Tune up
				20775	21100	21425	
5MHz	QPSK	1	0	23.23	23.77	23.92	24.5
		1	13	23.65	23.67	24.15	24.5
		1	24	23.68	23.38	24.17	24.5
		12	0	22.7	23.22	23.19	23.5
		12	6	22.87	23.11	23.21	23.5
		12	13	23.16	22.99	23.34	23.5
		25	0	22.98	23.11	23.25	23.5
	16QAM	1	0	23.17	22.95	22.96	23.5
		1	13	23.12	23.16	22.86	23.5
		1	24	23.01	22.75	23.07	23.5
		12	0	21.9	21.9	21.78	22.5
		12	6	21.83	21.99	21.83	22.5
		12	13	21.87	21.95	21.86	22.5
		25	0	22	22.06	21.84	22.5
Bandwidth	Modulation	RB size	RB offset	Channel	Channel	Channel	Tune up
				20800	21100	21400	
10MHz	QPSK	1	0	23.25	23.78	23.57	24.5
		1	25	23.68	23.72	24.16	24.5

Bandwidth	Modulation	RB size	RB offset	Channel	Channel	Channel	Tune up
				20825	21100	21375	
15MHz	QPSK	1	0	23.24	23.74	23.55	24.5
		1	38	23.66	23.71	24.13	24.5
		1	74	23.67	23.37	23.91	24.5
		36	0	22.71	23.23	23.09	23.5
		36	18	22.87	23.11	23.16	23.5
		36	39	23.15	23	23.16	23.5
		75	0	23.04	23.09	23.06	23.5
	16QAM	1	0	23.14	22.96	23.15	24
		1	38	23.13	23.17	23.81	24
		1	74	23.01	22.73	23.95	24
		36	0	21.9	21.93	21.79	22.5
		36	18	21.82	21.98	21.82	22.5
		36	39	21.88	21.96	21.87	22.5
		75	0	22	22.06	21.84	22.5
Bandwidth	Modulation	RB size	RB offset	Channel	Channel	Channel	Tune up
				20850	21100	21350	
20MHz	QPSK	1	0	23.21	23.7	23.52	24.5
		1	50	23.65	23.67	24.11	24.5
		1	99	23.65	23.36	23.88	24.5
		50	0	22.68	23.02	23.07	23.5
		50	25	22.85	23.07	23.13	23.5
		50	50	23.12	22.95	23.12	23.5
		100	0	23.01	23.01	23.04	23.5
	16QAM	1	0	23.12	22.92	23.1	24
		1	50	23.09	23.15	23.77	24
		1	99	22.99	22.7	23.93	24
		50	0	21.87	21.89	21.76	22.5
		50	25	21.79	21.96	21.79	22.5
		50	50	21.85	21.91	21.83	22.5
		100	0	21.98	22.02	21.81	22.5

Table 12: Conducted Power Of LTE

8.1.4 Conducted Power Of Wi-Fi and BT

Mode	Channel	Frequency (MHz)	Data Rate (Mbps)	Average Power (dBm)	Tune up	Power setting
802.11b	1	2412	1	15.69	16.5	15
	6	2437		16.03	16.5	15
	11	2462		16.03	16.5	15
802.11g	1	2412	6	15.91	17	12
	6	2437		16.17	17	12
	11	2462		16.52	17	12
802.11n HT20 SISO	1	2412	6.5	15.74	17	12
	6	2437		16.09	17	12
	11	2462		16.57	17	12

Table 13: Conducted Power Of Wi-Fi

Note:

- a) Power must be measured at each transmit antenna port according to the DSSS and OFDM transmission configurations in each standalone and aggregated frequency band.
- b) Power measurement is required for the transmission mode configuration with the highest maximum output power specified for production units.
 - 1) When the same highest maximum output power specification applies to multiple transmission modes, the largest channel bandwidth configuration with the lowest order modulation and lowest data rate is measured.
 - 2) When the same highest maximum output power is specified for multiple largest channel bandwidth configurations with the same lowest order modulation or lowest order modulation and lowest data rate, power measurement is required for all equivalent 802.11 configurations with the same maximum output power.
- c) For each transmission mode configuration, power must be measured for the highest and lowest channels; and at the mid-band channel(s) when there are at least 3 channels. For configurations with multiple mid-band channels, due to an even number of channels, both channels should be measured.

BT			Average Conducted Power (dBm)	Tune up (dBm)	Power setting
Modulation	Channel	Frequency (MHz)			
GFSK	0	2402	7.83	8	default
	39	2441	7.86	8	default
	78	2480	7.92	8	default
$\pi/4$ DQPSK	0	2402	5.72	6.5	default
	39	2441	6.02	6.5	default
	78	2480	6.1	6.5	default
8DPSK	0	2402	5.94	6.5	default
	39	2441	6.04	6.5	default
	78	2480	6.15	6.5	default

BLE_1Mbps			Average Conducted Power (dBm)	Tune up (dBm)	Power setting
Modulation	Channel	Frequency (MHz)			
GFSK	0	2402	5.15	6	default
	19	2440	5.79	6	default
	39	2480	5.79	6	default

Table 14: Conducted Power Of BT

8.2 Stand-alone SAR test evaluation

Unless specifically required by the published RF exposure KDB procedures, standalone 1-g head or body and 10-g extremity SAR evaluation for general population exposure conditions, by measurement or numerical simulation, is not required when the corresponding SAR Test Exclusion Threshold condition is satisfied. These test exclusion conditions are based on source-based time-averaged maximum conducted output power of the RF channel requiring evaluation, adjusted for tune-up tolerance, and the minimum test separation distance required for the exposure conditions.

Freq. Band	Frequency (GHz)	Position	Average Power		Test Separation (mm)	Calculate Value	Exclusion Threshold	Exclusion (Y/N)
			dBm	mW				
GSM850	0.848	Head	34	2511.9	0	462.6	3	N
GSM1900	1.909	Head	30	1000.0	0	276.3	3	N
WCDMA Band II	1.97	Head	24	251.2	0	70.5	3	N
WCDMA Band V	0.846	Head	24.5	281.8	0	51.8	3	N
LTE Band 2	1.909	Head	24.5	281.8	0	77.9	3	N
LTE Band 4	1.754	Head	24.5	281.8	0	74.7	3	N
LTE Band 5	0.848	Head	24.5	281.8	0	51.9	3	N
LTE Band 7	2.57	Head	24.5	281.8	0	90.4	3	N
Wi-Fi	2.45	Head	17	50.1	0	15.7	3	N
Bluetooth	2.48	Head	8	6.3	0	2.0	3	Y

The 1-g and 10-g SAR test exclusion thresholds for 100 MHz to 6 GHz at test separation distances ≤ 50 mm are determined by:

$[(\text{max. power of channel, including tune-up tolerance, mW}) / (\text{min. test separation distance, mm})] \cdot [\sqrt{f(\text{GHz})}] \leq 3.0$ for 1-g SAR and ≤ 7.5 for 10-g extremity SAR, where

- $f(\text{GHz})$ is the RF channel transmit frequency in GHz
- Power and distance are rounded to the nearest mW and mm before calculation
- The result is rounded to one decimal place for comparison

The test exclusions are applicable only when the minimum test separation distance is ≤ 50 mm and for transmission frequencies between 100 MHz and 6 GHz. When the minimum test separation distance is < 5 mm, a distance of 5 mm is applied to determine SAR test exclusion.

8.3 The EUT Sides For SAR Test

The following SAR test exclusion Thresholds based on KDB 447498 D01 General RF Exposure Guidance v06) 4.3.1)

Exposure Position	Wireless Interface	WCDMA Band V	WCDMA Band II	LTE Band 4	LTE Band 2	2.4GHz WLAN ANT 1
	Calculated Frequency	846MHz	1907MHz	1754MHz	1909MHz	2462MHz
	Maximum power (dBm)	24.5	24	24.5	24.5	17
	Maximum rated power(mW)	281.8	251.2	281.8	281.8	50.0
Front	Separation distance(mm)	-				
	exclusion threshold	-	-	-	-	-
	Testing required?	No (Remark)	No (Remark)	No (Remark)	No (Remark)	No (Remark)
Back	Separation distance(mm)	-				
	exclusion threshold	-	-	-	-	-
	Testing required?	No (Remark)	No (Remark)	No (Remark)	No (Remark)	No (Remark)
Left	Separation distance(mm)	-				
	exclusion threshold	-	-	-	-	-
	Testing required?	No (Remark)	No (Remark)	No (Remark)	No (Remark)	No (Remark)
Right	Separation distance(mm)	-				
	exclusion threshold	-	-	-	-	-
	Testing required?	No (Remark)	No (Remark)	No (Remark)	No (Remark)	No (Remark)
Top	Separation distance(mm)	-				
	exclusion threshold	-	-	-	-	-
	Testing required?	No (Remark)	No (Remark)	No (Remark)	No (Remark)	No (Remark)
Bottom	Separation distance(mm)	13.46				
	exclusion threshold	19.3	25.8	27.7	28.9	7.9
	Testing required?	Yes	Yes	Yes	Yes	Yes

Exposure Position	Wireless Interface	GSM850	GSM1900	LTE Band 5	LTE Band 7	
	Calculated Frequency	848MHz	1909MHz	848MHz	2570MHz	
	Maximum power (dBm)	34	30	24	24	
	Maximum rated power(mW)	2511.9	1000.0	281.8	281.8	
Front	Separation distance(mm)	-				
	exclusion threshold	-	-	-	-	
	Testing required?	No (Remark)	No (Remark)	No (Remark)	No (Remark)	
Back	Separation distance(mm)	-				
	exclusion threshold	-	-	-	-	
	Testing required?	No (Remark)	No (Remark)	No (Remark)	No (Remark)	
Left	Separation distance(mm)	-				
	exclusion threshold	-	-	-	-	
	Testing required?	No (Remark)	No (Remark)	No (Remark)	No (Remark)	
Right	Separation distance(mm)	-				
	exclusion threshold	-	-	-	-	
	Testing required?	No (Remark)	No (Remark)	No (Remark)	No (Remark)	
Top	Separation distance(mm)	-				
	exclusion threshold	-	-	-	-	
	Testing required?	No (Remark)	No (Remark)	No (Remark)	No (Remark)	
Bottom	Separation distance(mm)	13.46				
	exclusion threshold	171.9	102.7	24.7	25.8	
	Testing required?	Yes	Yes	Yes	Yes	

Remark:

In fact, there would be only the surface of Bottom side contact with human's head.

Note:

1. Maximum power is the source-based time-average power and represents the maximum RF output power among production units
2. Per KDB 447498 D01, for larger devices, the test separation distance of adjacent edge configuration is determined by the closest separation between the antenna and the user.
3. Per KDB 447498 D01, standalone SAR test exclusion threshold is applied; If the distance of the antenna to the user is < 5mm, 5mm is used to determine SAR exclusion threshold
4. Per KDB 447498 D01, the 1-g and 10-g SAR test exclusion thresholds for 100 MHz to 6 GHz at test separation distances ≤ 50 mm are determined by:

$[(\text{max. power of channel, including tune-up tolerance, mW}) / (\text{min. test separation distance, mm})] \cdot [\sqrt{f(\text{GHz})}] \leq 3.0$
for

1-g SAR and ≤ 7.5 for 10-g extremity SAR

$f(\text{GHz})$ is the RF channel transmit frequency in GHz

Power and distance are rounded to the nearest mW and mm before calculation

The result is rounded to one decimal place for comparison

For < 50 mm distance, we just calculate mW of the exclusion threshold value (3.0) to do compare.

This formula is $[3.0] / [\sqrt{f(\text{GHz})}] \cdot [(\text{min. test separation distance, mm})] = \text{exclusion threshold of mW}$.

5. Per KDB 447498 D01, at 100 MHz to 6 GHz and for test separation distances > 50 mm, the SAR test exclusion threshold is determined according to the following

a) [Threshold at 50 mm in step 1) + (test separation distance - 50 mm) · ($f(\text{MHz})/150$)] mW, at 100 MHz to 1500 MHz

b) [Threshold at 50 mm in step 1) + (test separation distance - 50 mm) · 10] mW at > 1500 MHz and ≤ 6 GHz

6. When the minimum test separation distance is < 5 mm, a distance of 5 mm according to 5) in section 4.1 is applied to determine SAR test exclusion.

8.4 Measurement of SAR Data

8.4.1 SAR Result Of GSM850

Test position	Test mode	Test Ch./Freq.	Duty Cycle	SAR (W/kg) 1-g	SAR (W/kg) 10-g	Power Drift (dB)	Conducted Power (dBm)	Tune up Limit (dBm)	Scaled factor	Scaled SAR (W/kg) 1-g	Liquid Temp	SAR limit (W/kg)
Test data With SIM1(0mm)												
Bottom side	GPRS 2TS	190/836.6	1:4.15	0.286	0.159	-0.12	33.42	34	1.143	0.327	22.1	1.6
Bottom side	EGPRS 2TS	190/836.6	1:4.15	0.093	0.051	-0.02	28.35	29	1.161	0.108	22.1	1.6

Table 15: SAR Result Of GSM850

Note:

- 1) The maximum Scaled SAR value is marked in bold. Graph Results refer to Appendix B
- 2) Per FCC KDB Publication 447498 D01, if the reported (scaled) SAR measured at the middle channel or highest output power channel for each test configuration is ≤ 0.8 W/kg then testing at the other channels is not required for such test configuration(s).

8.4.2 SAR Result Of GSM1900

Test position	Test mode	Test Ch./Freq.	Duty Cycle	SAR (W/kg) 1-g	SAR (W/kg) 10-g	Power Drift (dB)	Conducted Power (dBm)	Tune up Limit (dBm)	Scaled factor	Scaled SAR (W/kg) 1-g	Liquid Temp	SAR limit (W/kg)
Test data With SIM1(0mm)												
Bottom side	GPRS 4TS	661/1880	1:2.075	0.861	0.468	0.09	29.61	30	1.094	0.942	22.3	1.6
Bottom side	GPRS 4TS	512/1850.2	1:2.075	0.942	0.5	-0.07	29.57	30	1.104	1.040	22.3	1.6
Bottom side	GPRS 4TS	810/1909.8	1:2.075	1.02	0.553	0.05	29.71	30	1.069	1.090	22.3	1.6
Bottom side repeat SAR	GPRS 4TS	810/1909.8	1:2.075	0.993	0.549	-0.18	29.71	30	1.069	1.062	22.3	1.6
Bottom side	EGPRS 4TS	810/1909.8	1:2.075	0.289	0.156	0.03	26.68	27	1.076	0.311	22.3	1.6

Table 16: SAR Result Of GSM1900

Note:

- 1) The maximum Scaled SAR value is marked in bold. Graph Results refer to Appendix B
- 2) Per FCC KDB Publication 447498 D01, if the reported (scaled) SAR measured at the middle channel or highest output power channel for each test configuration is ≤ 0.8 W/kg then testing at the other channels is not required for such test configuration(s).

8.4.3 SAR Result Of WCDMA Band II

Test position	Test mode	Test Ch./Freq.	SAR (W/kg) 1-g	SAR (W/kg) 10-g	Power Drift (dB)	Conducted Power (dBm)	Tune up Limit (dBm)	Scaled factor	Scaled SAR (W/kg) 1-g	Liquid Temp	SAR limit (W/kg)
Test data With SIM1(0mm)											
Bottom side	RMC	9400/1880	0.461	0.266	-0.03	23.78	24	1.052	0.485	22.3	1.6

Table 17: SAR Result of WCDMA Band II

Note:

- 1) The maximum Scaled SAR value is marked in bold. Graph Results refer to Appendix B
- 2) If the reported (scaled) SAR measured at the middle channel or highest output power channel for each test configuration is ≤ 0.8 W/kg then testing at the other channels is not required for such test configuration(s).

8.4.4 SAR Result Of WCDMA Band V

Test position	Test mode	Test Ch./Freq.	SAR (W/kg) 1-g	SAR (W/kg) 10-g	Power Drift (dB)	Conducted Power (dBm)	Tune up Limit (dBm)	Scaled factor	Scaled SAR (W/kg) 1-g	Liquid Temp	SAR limit (W/kg)
Test data With SIM1(0mm)											
Bottom side	RMC	4182/836.4	0.141	0.097	-0.06	23.98	24.5	1.127	0.159	22.1	1.6

Table 18: SAR Result of WCDMA Band V

Note:

- 1) The maximum Scaled SAR value is marked in bold. Graph Results refer to Appendix B
- 2) If the reported (scaled) SAR measured at the middle channel or highest output power channel for each test configuration is ≤ 0.8 W/kg then testing at the other channels is not required for such test configuration(s).

8.4.5 SAR Result Of LTE Band 2

Test position	BW.	Test mode	Test Ch./Freq.	SAR (W/kg) 1-g	SAR (W/kg) 10-g	Power Drift (dB)	Conducted power (dBm)	Tune up Limit (dBm)	Scaled factor	Scaled SAR (W/kg) 1-g	Liquid Temp.	SAR limit (W/kg)
Test data With SIM1(0mm)												
Bottom side	20	QPSK 1RB_50	19100/1900	0.401	0.226	-0.09	23.56	24.5	1.242	0.498	22.3	1.6
Bottom side	20	QPSK 50RB_25	18900/1880	0.318	0.185	-0.02	22.76	23.5	1.186	0.377	22.3	1.6

Table 19: SAR Result of LTE Band 2

Note:

- 1) The maximum Scaled SAR value is marked in bold. Graph results refer to Appendix B
- 2) If the reported (scaled) SAR measured at the middle channel or highest output power channel for each test configuration is ≤ 0.8 W/kg then testing at the other channels is not required for such test configuration(s).

8.4.6 SAR Result Of LTE Band 4

Test position	BW.	Test mode	Test Ch./Freq.	SAR (W/kg) 1-g	SAR (W/kg) 10-g	Power Drift (dB)	Conducted power (dBm)	Tune up Limit (dBm)	Scaled factor	Scaled SAR (W/kg) 1-g	Liquid Temp.	SAR limit (W/kg)
Test data With SIM1(0mm)												
Bottom side	20	QPSK 1RB_50	20050/1720	0.176	0.104	-0.02	23.85	24.5	1.161	0.204	22.2	1.6
Bottom side	20	QPSK 50RB_0	20050/1720	0.148	0.087	0.13	23.13	23.5	1.089	0.161	22.2	1.6

Table 20: SAR Result of LTE Band 4

Note:

- 3) The maximum Scaled SAR value is marked in bold. Graph results refer to Appendix B
- 4) If the reported (scaled) SAR measured at the middle channel or highest output power channel for each test configuration is ≤ 0.8 W/kg then testing at the other channels is not required for such test configuration(s).

8.4.7 SAR Result Of LTE Band 5

Test position	BW.	Test mode	Test Ch./Freq.	SAR (W/kg) 1-g	SAR (W/kg) 10-g	Power Drift (dB)	Conducted power (dBm)	Tune up Limit (dBm)	Scaled factor	Scaled SAR (W/kg) 1-g	Liquid Temp.	SAR limit (W/kg)
Test data With SIM1(0mm)												
Bottom side	20	QPSK 1RB_25	20600/844	0.131	0.088	-0.06	24.03	24.5	1.114	0.146	22.1	1.6
Bottom side	20	QPSK 25RB_0	20600/844	0.105	0.071	0.17	23.12	23.5	1.091	0.115	22.1	1.6

Table 21: SAR Result of LTE Band 5

Note:

- 5) The maximum Scaled SAR value is marked in bold. Graph results refer to Appendix B
- 6) If the reported (scaled) SAR measured at the middle channel or highest output power channel for each test configuration is ≤ 0.8 W/kg then testing at the other channels is not required for such test configuration(s).

8.4.8 SAR Result Of LTE Band 7

Test position	BW.	Test mode	Test Ch./Freq.	SAR (W/kg) 1-g	SAR (W/kg) 10-g	Power Drift (dB)	Conducted power (dBm)	Tune up Limit (dBm)	Scaled factor	Scaled SAR (W/kg) 1-g	Liquid Temp.	SAR limit (W/kg)
Test data With SIM1(0mm)												
Bottom side	20	QPSK 1RB_50	21350/2560	0.382	0.201	0.04	24.11	24.5	1.094	0.418	22.1	1.6
Bottom side	20	QPSK 50RB_0	21350/2560	0.311	0.166	-0.07	23.07	23.5	1.104	0.343	22.1	1.6

Table 22: SAR Result of LTE Band 7

Note:

- 7) The maximum Scaled SAR value is marked in bold. Graph results refer to Appendix B
- 8) If the reported (scaled) SAR measured at the middle channel or highest output power channel for each test configuration is ≤ 0.8 W/kg then testing at the other channels is not required for such test configuration(s).

8.4.9 SAR Result Of 2.4GHz Wi-Fi

Test position	Test mode	Test Ch./Freq.	Duty Cycle	Duty Cycle Scaled factor	SAR (W/kg) 1-g	SAR (W/kg) 10-g	Power drift (dB)	Conducted power (dBm)	Tune up Limit (dBm)	Scaled factor	Scaled SAR (W/kg)	Liquid Temp.
Test data(0mm)												
Bottom side	802.11g	11/2462	93.33%	1.071	0.009	0.003	-0.04	16.52	17.00	1.117	0.011	22.0

Table 23: SAR Result Of 2.4GHz Wi-Fi

Note:

- 1) The maximum Scaled SAR value is marked in bold. Graph results refer to Appendix B
- 2) If the reported (scaled) SAR measured at the middle channel or highest output power channel for each test configuration is ≤ 0.8 W/kg then testing at the other channels is not required for such test configuration(s). Per Kdb248227 D01, When the reported SAR is > 0.8 W/kg, SAR is required for that exposure configuration using the next highest measured output power channel.
- 3) Each channel was tested at the lowest data rate.

8.4.10 Repeat SAR Measurement

Band	Mode	Test Position	Test Ch./Freq.	Original Measured SAR1g (mW/g)	1st Repeated SAR1g (mW/g)	Ratio
GSM1900	GPRS 4TS	Bottom side	810/1909.8	1.02	0.993	-2.65

Note:

- 1) Per KDB 865664 D01v01, for each frequency band, repeated SAR measurement is required only when the measured SAR is $\geq 0.8W/Kg$
- 2) Per KDB 865664 D01v01, if the ratio of largest to smallest SAR for the original and first repeated measurement is ≤ 1.2 and the measured SAR $< 1.45W/Kg$, only one repeated measurement is required
- 3) The ratio is the difference in percentage between original and repeated measured SAR.

8.5 Multiple Transmitter Evaluation

8.5.1 Simultaneous SAR SAR test evaluation

Simultaneous Transmission

NO.	Simultaneous Transmission Configuration	Head
1	GPRS / EDGE(Data) + WiFi	Yes
2	GPRS / EDGE(Data) + BT	Yes
3	WCDMA(Data) + WiFi	Yes
4	WCDMA(Data) + BT	Yes
5	LTE(Data) + WiFi	Yes
6	LTE(Data) + BT	Yes
7	BT+WIFI (They share the same antenna and cannot transmit at the same time by design.)	No

Note:

- 1) Wi-Fi and Bluetooth share the same Tx antenna and can't transmit simultaneously.

8.5.2 Estimated SAR

When the standalone SAR test exclusion is applied to an antenna that transmits simultaneously with other antennas, the standalone SAR must be estimated according to the following to determine simultaneous transmission SAR test exclusion:

- $(\text{max. power of channel, including tune-up tolerance, mW}) / (\text{min. test separation distance, mm}) \cdot [\sqrt{f(\text{GHz})} / x]$ W/kg for test separation distances ≤ 50 mm;

Where $x = 7.5$ for 1-g SAR, and $x = 18.75$ for 10-g SAR.

- 0.4 W/kg for 1-g SAR and 1.0 W/kg for 10-g SAR, when the test separation distances is > 50 mm.

Estimated SAR Result

Freq. Band	Frequency (MHz)	Test Position	Test Separation (mm)	max. power(dBm)	Estimated 1g SAR (W/kg)
Bluetooth	2480	Head	0	8.00	0.265

1) Simultaneous Transmission SAR Summation Scenario for head

WWAN Band	Exposure position	①MAX. WWAN SAR(W/kg)	②MAX. WLAN 2.4GHz SAR(W/kg)	③MAX. BT SAR (W/kg)	Summed SAR ①+②	Summed SAR ①+③	SPLSR No.
GSM850	Bottom	0.327	0.011	0.265	0.338	0.592	No
GSM1900	Bottom	1.09	0.011	0.265	1.101	1.355	No
WCDMA Band II	Bottom	0.485	0.011	0.265	0.496	0.75	No
WCDMA Band V	Bottom	0.159	0.011	0.265	0.17	0.424	No
LTE Band 2	Bottom	0.498	0.011	0.265	0.509	0.763	No
LTE Band 4	Bottom	0.204	0.011	0.265	0.215	0.469	No
LTE Band 5	Bottom	0.146	0.011	0.265	0.157	0.411	No
LTE Band 7	Bottom	0.418	0.011	0.265	0.429	0.683	No

9 Equipment list

Test Platform	SPEAG DASY5 Professional					
Location	SGS-CCS Standards Technical Services Co., Ltd. Kunshan Branch					
Description	SAR Test System (Frequency range 300MHz-6GHz)					
Software Reference	DASY52 52.8.8(1222); SEMCAD X 14.6.10(7331)					
Hardware Reference						
Equipment	Manufacturer	Model	Serial Number	Calibration Date	Due date of calibration	
<input checked="" type="checkbox"/> P C	HP	Core(rm)3.16G	CZCO48171H	N/A	N/A	
<input checked="" type="checkbox"/> Signal Generator	Agilent	E8257C	MY43321570	2019/10/24	2020/10/23	
<input checked="" type="checkbox"/> S-Parameter Network Analyzer	Agilent	E5071B	MY42301382	2020/02/24	2021/02/23	
<input checked="" type="checkbox"/> DAK-3.5 probe	SPEAG	DAK-3.5	1102	N/A	N/A	
<input checked="" type="checkbox"/> Power meter	Anritsu	ML2495A	1445010	2020/04/21	2021/04/20	
<input checked="" type="checkbox"/> Power sensor	Anritsu	MA2411B	1339220	2020/04/21	2021/04/20	
<input checked="" type="checkbox"/> universal Radio communication tester	R&S	CMW500	159275	2019/12/19	2020/12/18	
<input checked="" type="checkbox"/> DAE	SPEAG	DAE4	1245	2020/05/27	2021/05/26	
<input checked="" type="checkbox"/> E-field PROBE	SPEAG	EX3DV4	3798	2020/05/29	2021/05/28	
<input checked="" type="checkbox"/> Dipole	SPEAG	D835V2	4d114	2019/06/11	2022/06/10	
<input checked="" type="checkbox"/> Dipole	SPEAG	D1800V2	2d170	2019/06/11	2021/06/10	
<input checked="" type="checkbox"/> Dipole	SPEAG	D1900V2	5d136	2019/06/11	2021/06/10	
<input checked="" type="checkbox"/> Dipole	SPEAG	D2450V2	817	2019/06/10	2022/06/09	
<input checked="" type="checkbox"/> Dipole	SPEAG	D2600V2	1158	2019/03/08	2022/03/07	
<input checked="" type="checkbox"/> Electro Thermometer	DTM	DTM3000	3030	2019/12/20	2020/12/19	
<input checked="" type="checkbox"/> Amplifier	Mini-circuits	ZVE-8G	110405	N/A	N/A	
<input checked="" type="checkbox"/> Amplifier	Mini-circuits	ZHL-42	QA1331003	N/A	N/A	
<input checked="" type="checkbox"/> 3db ATTENUATOR	MINI	MCL BW-S3W5	0533	N/A	N/A	
<input checked="" type="checkbox"/> DUMMY PROBE	SPEAG	DP_2	SPDP2001AA	N/A	N/A	
<input checked="" type="checkbox"/> Dual Directional Coupler	Woken	20W couple	DOM2BHW1A1	N/A	N/A	
<input checked="" type="checkbox"/> SAM PHANTOM (ELI4 v4.0)	SPEAG	QDOVA001BB	1102	N/A	N/A	
<input checked="" type="checkbox"/> Twin SAM Phantom	SPEAG	QD000P40CD	1609	N/A	N/A	
<input checked="" type="checkbox"/> ROBOT	SPEAG	TX60	F10/5E6AA1/A101	N/A	N/A	
<input checked="" type="checkbox"/> ROBOT KRC	SPEAG	CS8C	F10/5E6AA1/C101	N/A	N/A	
<input checked="" type="checkbox"/> LIQUID CALIBRATION KIT	ANTENNESSA	41/05 OCP9	00425167	N/A	N/A	

Note: All the equipments are within the valid period when the tests are performed.

All measurement facilities used to collect the measurement data are located at

No.10, Weiye Rd., Innovation Park, Eco & Tec. Development Part, Kunshan City, Jiangsu Province, China.

10 Calibration certificate

Please see the Appendix C

11 Photographs

Please see the Appendix D



Appendix A: Detailed System Check Results

The plots are showing as followings.

Test Laboratory: Compliance Certification Services Inc.

System Performance Check-Head 835MHz

DUT: Dipole 835 MHz; Type: D835V2; Serial: 4d114

Communication System: UID 0, CW; Frequency: 835 MHz; Duty Cycle: 1:1
 Medium parameters used: $f = 835 \text{ MHz}$; $\sigma = 0.886 \text{ S/m}$; $\epsilon_r = 40.798$; $\rho = 1000 \text{ kg/m}^3$
 Phantom section: Flat Section
 Measurement Standard: DASY5 (IEEE/IEC/ANSI C63.19-2007)

DASY5 Configuration:

- Probe: EX3DV4 - SN3798; ConvF(9.41, 9.41, 9.41); Calibrated: 2020/05/29;
- Sensor-Surface: 1.4mm (Mechanical Surface Detection)
- Electronics: DAE4 Sn1245; Calibrated: 2020/05/27
- Phantom: ELI v4.0; Type: QDOVA001BB; Serial: TP:1102
- Measurement SW: DASY52, Version 52.8 (8); SEMCAD X Version 14.6.10 (7331)

Body/dist=15mm, Pin=250 mW(EX-Probe)/Area Scan (7x12x1): Measurement grid:

$dx=15\text{mm}$, $dy=15\text{mm}$

Maximum value of SAR (measured) = 3.13 W/kg

Body/dist=15mm, Pin=250 mW(EX-Probe)/Zoom Scan (7x7x7) (7x7x7)/Cube 0:

Measurement grid: $dx=5\text{mm}$, $dy=5\text{mm}$, $dz=5\text{mm}$

Reference Value = 61.43 V/m; Power Drift = -0.05 dB

Peak SAR (extrapolated) = 3.59 W/kg

SAR(1 g) = 2.37 W/kg; SAR(10 g) = 1.54 W/kg

Maximum value of SAR (measured) = 3.05 W/kg

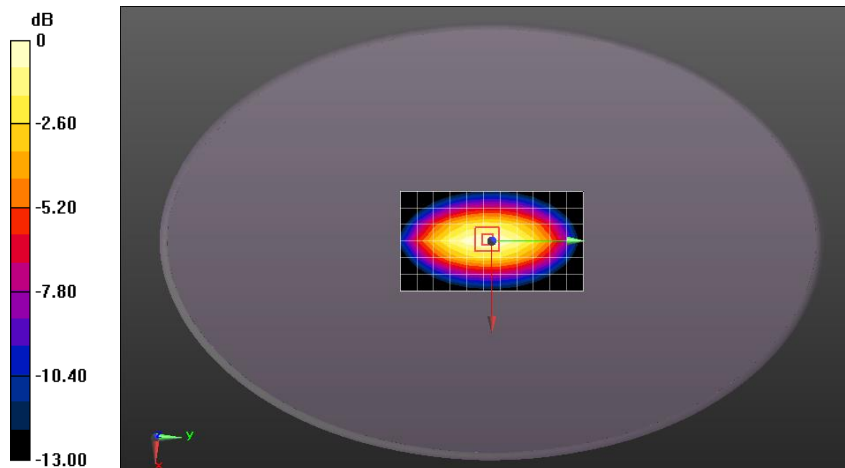

0 dB = 3.05 W/kg = 4.84 dBW/kg

Test Laboratory: Compliance Certification Services Inc.

System Performance Check-Head 1800MHz

DUT: Dipole 1800 MHz; Type: D1800V2; Serial: 2d170

Communication System: UID 10000, CW; Frequency: 1800 MHz; Duty Cycle: 1:1
 Medium parameters used: $f = 1800 \text{ MHz}$; $\sigma = 1.443 \text{ S/m}$; $\epsilon_r = 40.188$; $\rho = 1000 \text{ kg/m}^3$
 Phantom section: Flat Section
 Measurement Standard: DASYS (IEEE/IEC/ANSI C63.19-2007)

DASY5 Configuration:

- Probe: EX3DV4 - SN3798; ConvF(8.13, 8.13, 8.13); Calibrated: 2020/05/29;
- Sensor-Surface: 1.4mm (Mechanical Surface Detection)
- Electronics: DAE4 Sn1245; Calibrated: 2020/05/27
- Phantom: Twin SAM Phantom; Type: QD 000 P40 CD; Serial: 1609
- Measurement SW: DASYS2, Version 52.8 (8); SEMCAD X Version 14.6.10 (7331)

Body/d=10mm, Pin=250 mW, dist=3.0mm (EX-Probe) (23.6 dBm)/Area Scan

(7x7x1): Measurement grid: $dx=15\text{mm}$, $dy=15\text{mm}$
 Maximum value of SAR (measured) = 13.1 W/kg

Body/d=10mm, Pin=250 mW, dist=3.0mm (EX-Probe) (23.6 dBm)/Zoom Scan

(7x7x7) (7x7x7)/Cube 0: Measurement grid: $dx=5\text{mm}$, $dy=5\text{mm}$, $dz=5\text{mm}$
 Reference Value = 95.45 V/m; Power Drift = 0.05 dB
 Peak SAR (extrapolated) = 19.0 W/kg
SAR(1 g) = 9.89 W/kg; SAR(10 g) = 5.1 W/kg
 Maximum value of SAR (measured) = 14.5 W/kg

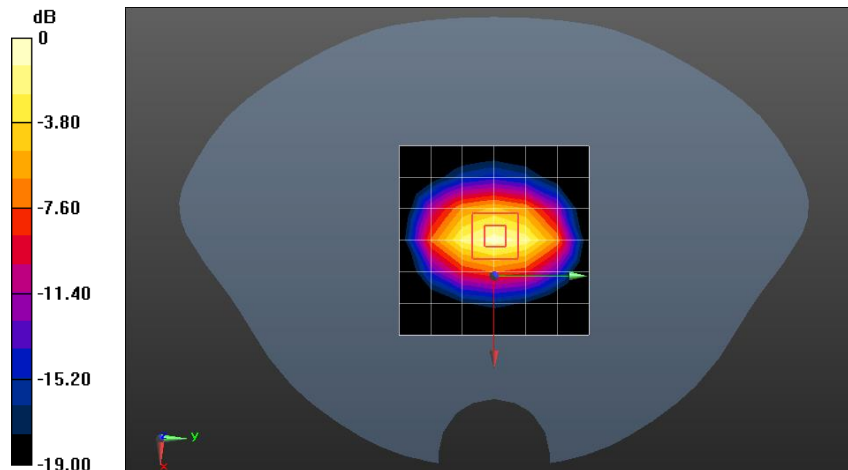

0 dB = 14.5 W/kg = 11.61 dBW/kg

Test Laboratory: Compliance Certification Services Inc.

System Performance Check-Head 1900MHz

DUT: Dipole 1900 MHz; Type: D1900V2; Serial: 5d136

Communication System: UID 0, CW; Frequency: 1900 MHz; Duty Cycle: 1:1
 Medium parameters used: $f = 1900 \text{ MHz}$; $\sigma = 1.431 \text{ S/m}$; $\epsilon_r = 39.062$; $\rho = 1000 \text{ kg/m}^3$
 Phantom section: Flat Section
 Measurement Standard: DASYS (IEEE/IEC/ANSI C63.19-2007)

DASY5 Configuration:

- Probe: EX3DV4 - SN3798; ConvF(7.9, 7.9, 7.9); Calibrated: 2020/05/29;
- Sensor-Surface: 1.4mm (Mechanical Surface Detection)
- Electronics: DAE4 Sn1245; Calibrated: 2020/05/27
- Phantom: Twin SAM Phantom; Type: QD 000 P40 CD; Serial: 1609
- Measurement SW: DASYS2, Version 52.8 (8); SEMCAD X Version 14.6.10 (7331)

Body/Pin=250 mW, dist=10mm (EX-Probe)/Area Scan (7x8x1): Measurement grid:
 $dx=15\text{mm}$, $dy=15\text{mm}$
 Maximum value of SAR (measured) = 16.6 W/kg

Body/Pin=250 mW, dist=10mm (EX-Probe)/Zoom Scan (7x7x7) (7x7x7)/Cube 0:
 Measurement grid: $dx=5\text{mm}$, $dy=5\text{mm}$, $dz=5\text{mm}$
 Reference Value = 114.4 V/m; Power Drift = -0.00 dB
 Peak SAR (extrapolated) = 25.9 W/kg
SAR(1 g) = 10.1 W/kg; SAR(10 g) = 5.06 W/kg
 Maximum value of SAR (measured) = 18.2 W/kg

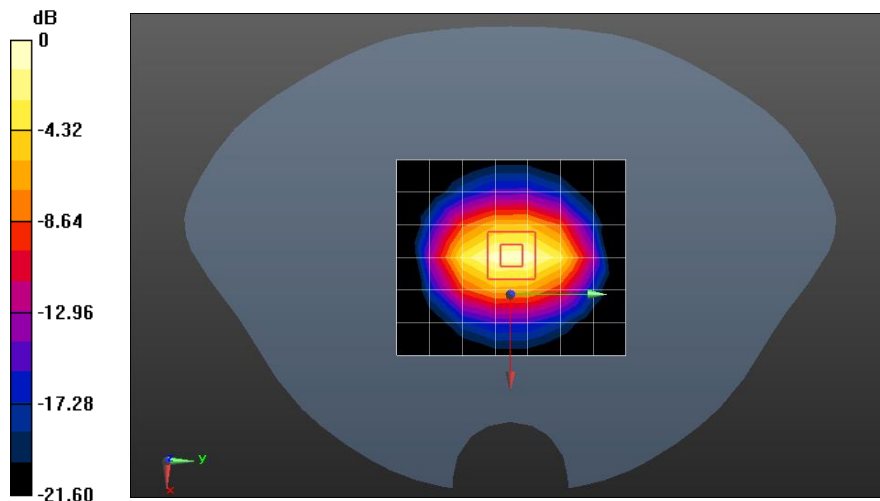

0 dB = 18.2 W/kg = 12.60 dBW/kg

Test Laboratory: Compliance Certification Services Inc.

System Performance Check-Head 2450MHz

DUT: Dipole 2450 MHz; Type: D2450V2; Serial: 817

Communication System: UID 0, CW; Frequency: 2450 MHz; Duty Cycle: 1:1
 Medium parameters used: $f = 2450$ MHz; $\sigma = 1.802$ S/m; $\epsilon_r = 38.226$; $\rho = 1000$ kg/m³
 Phantom section: Flat Section
 Measurement Standard: DASYS (IEEE/IEC/ANSI C63.19-2007)

DASY5 Configuration:

- Probe: EX3DV4 - SN3798; ConvF(7.27, 7.27, 7.27); Calibrated: 2020/05/29;
- Sensor-Surface: 1.4mm (Mechanical Surface Detection)
- Electronics: DAE4 Sn1245; Calibrated: 2020/05/27
- Phantom: ELI v4.0; Type: QDOVA001BB; Serial: TP:1102
- Measurement SW: DASYS2, Version 52.8 (8); SEMCAD X Version 14.6.10 (7331)

Body/d=10mm, Pin=250 mW, dist=2.0mm (EX-Probe)/Area Scan (9x9x1):

Measurement grid: dx=12mm, dy=12mm
 Maximum value of SAR (measured) = 13.4 W/kg

**Body/d=10mm, Pin=250 mW, dist=2.0mm (EX-Probe)/Zoom Scan (7x7x7)
(7x7x7)/Cube 0:**

Measurement grid: dx=5mm, dy=5mm, dz=5mm
 Reference Value = 87.70 V/m; Power Drift = 0.11 dB
 Peak SAR (extrapolated) = 21.5 W/kg
SAR(1 g) = 12 W/kg; SAR(10 g) = 5.9 W/kg
 Maximum value of SAR (measured) = 16.2 W/kg

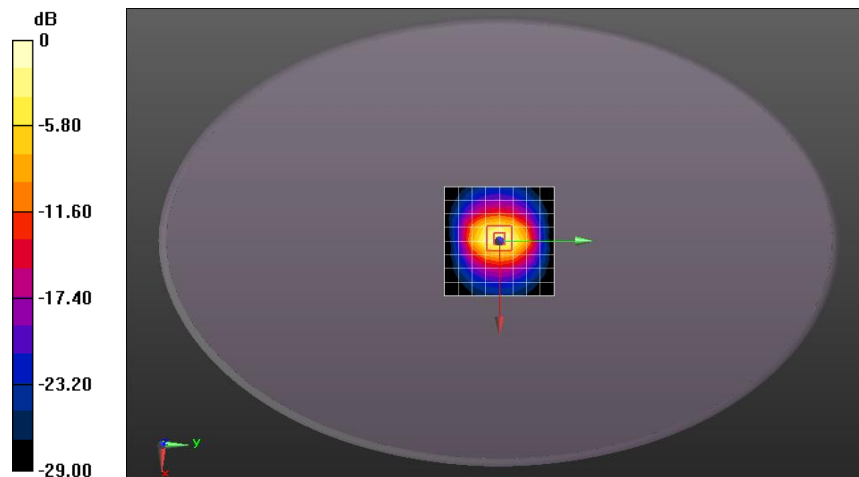

0 dB = 16.2 W/kg = 12.10 dBW/kg

Test Laboratory: Compliance Certification Services Inc.

System Performance Check-Head 2600MHz

DUT: Dipole 2600 MHz; Type: D2600V2; Serial: 1158

Communication System: UID 0, CW (0); Frequency: 2600 MHz; Duty Cycle: 1:1
 Medium parameters used: $f = 2600$ MHz; $\sigma = 1.968$ S/m; $\epsilon_r = 37.767$; $\rho = 1000$ kg/m³
 Phantom section: Flat Section
 Measurement Standard: DASYS (IEEE/IEC/ANSI C63.19-2007)

DASY5 Configuration:

- Probe: EX3DV4 - SN3798; ConvF(7.06, 7.06, 7.06); Calibrated: 2020/05/29;
- Sensor-Surface: 1.4mm (Mechanical Surface Detection)
- Electronics: DAE4 Sn1245; Calibrated: 2020/05/27
- Phantom: ELI v4.0; Type: QDOVA001BB; Serial: TP:1102
- Measurement SW: DASYS2, Version 52.8 (8); SEMCAD X Version 14.6.10 (7331)

Body/Pin=250 mW, dist=10mm (EX-Probe)/Area Scan (9x10x1): Measurement grid:
 dx=12mm, dy=12mm
 Maximum value of SAR (measured) = 18.4 W/kg

Body/Pin=250 mW, dist=10mm (EX-Probe)/Zoom Scan (7x7x7) (7x7x7)/Cube 0:
 Measurement grid: dx=5mm, dy=5mm, dz=5mm
 Reference Value = 101.9 V/m; Power Drift = 0.05 dB
 Peak SAR (extrapolated) = 30.5 W/kg
SAR(1 g) = 12.9 W/kg; SAR(10 g) = 6.1 W/kg
 Maximum value of SAR (measured) = 20.1 W/kg

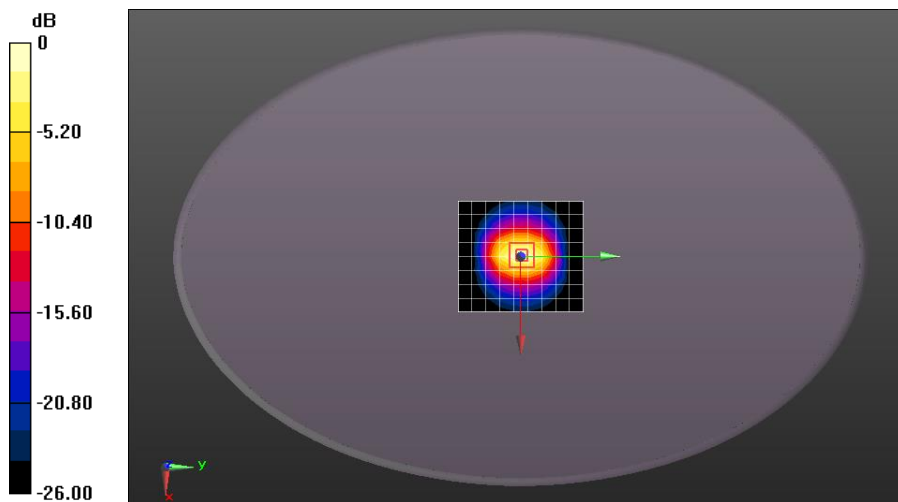

0 dB = 20.1 W/kg = 13.03 dBW/kg



Appendix B: Detailed Test Results

The plots of worse case are showing as followings.

Date: 2020/10/15

Test Laboratory: Compliance Certification Services Inc.

07_GSM850 GPRS2TS Bottom side Ch190 0mm

DUT: helmet Camera; Type: DS-MCH508; Serial: E55001866

Communication System: UID 0, GPRS/EGPRS 2TX Slots (0); Frequency: 836.6 MHz; Duty Cycle: 1:4.15

Medium parameters used: $f = 837 \text{ MHz}$; $\sigma = 0.887 \text{ S/m}$; $\epsilon_r = 40.787$; $\rho = 1000 \text{ kg/m}^3$

Phantom section: Flat Section

Measurement Standard: DASYS (IEEE/IEC/ANSI C63.19-2007)

DASY5 Configuration:

- Probe: EX3DV4 - SN3798; ConvF(9.41, 9.41, 9.41); Calibrated: 2020/05/29;
- Sensor-Surface: 1.4mm (Mechanical Surface Detection)
- Electronics: DAE4 Sn1245; Calibrated: 2020/05/27
- Phantom: ELI v4.0; Type: QDOVA001BB; Serial: TP:1102
- Measurement SW: DASYS2, Version 52.8 (8); SEMCAD X Version 14.6.10 (7331)

Configuration/Body/Area Scan (6x9x1): Measurement grid: $dx=15\text{mm}$, $dy=15\text{mm}$
Maximum value of SAR (measured) = 0.426 W/kg

Configuration/Body/Zoom Scan (5x5x7)/Cube 0: Measurement grid: $dx=8\text{mm}$, $dy=8\text{mm}$, $dz=5\text{mm}$

Reference Value = 18.99 V/m; Power Drift = -0.12 dB

Peak SAR (extrapolated) = 0.747 W/kg

SAR(1 g) = 0.286 W/kg; SAR(10 g) = 0.159 W/kg

Maximum value of SAR (measured) = 0.587 W/kg

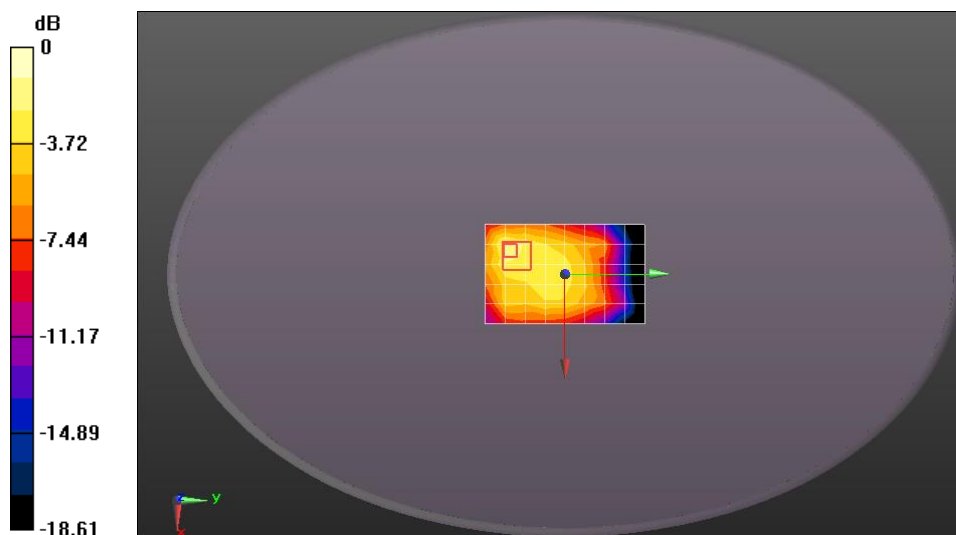

0 dB = 0.587 W/kg = -2.31 dBW/kg

Test Laboratory: Compliance Certification Services Inc.

06_GSM1900 GPRS4TS Bottom side Ch810 0mm

DUT: helmet Camera; Type: DS-MCH508; Serial: E55001866

Communication System: UID 0, GPRS/EGPRS 4TX Slots (0); Frequency: 1909.8 MHz; Duty Cycle: 1:2.0797

Medium parameters used: $f = 1910 \text{ MHz}$; $\sigma = 1.441 \text{ S/m}$; $\epsilon_r = 38.892$; $\rho = 1000 \text{ kg/m}^3$

Phantom section: Flat Section

Measurement Standard: DASYS5 (IEEE/IEC/ANSI C63.19-2007)

DASY5 Configuration:

- Probe: EX3DV4 - SN3798; ConvF(7.9, 7.9, 7.9); Calibrated: 2020/05/29;
- Sensor-Surface: 1.4mm (Mechanical Surface Detection)
- Electronics: DAE4 Sn1245; Calibrated: 2020/05/27
- Phantom: Twin SAM Phantom; Type: QD 000 P40 CD; Serial: 1609
- Measurement SW: DASYS52, Version 52.8 (8); SEMCAD X Version 14.6.10 (7331)

Configuration/Body/Area Scan (6x9x1): Measurement grid: $dx=15\text{mm}$, $dy=15\text{mm}$

Maximum value of SAR (measured) = 1.67 W/kg

Configuration/Body/Zoom Scan (5x5x7)/Cube 0: Measurement grid: $dx=8\text{mm}$, $dy=8\text{mm}$, $dz=5\text{mm}$

Reference Value = 8.757 V/m; Power Drift = 0.05 dB

Peak SAR (extrapolated) = 2.17 W/kg

SAR(1 g) = 1.02 W/kg; SAR(10 g) = 0.553 W/kg

Maximum value of SAR (measured) = 1.79 W/kg

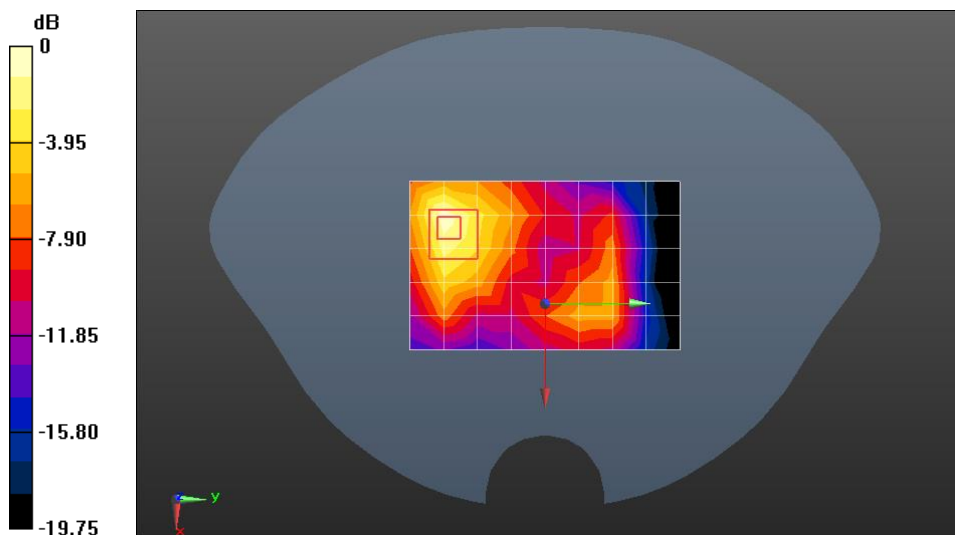

0 dB = 1.79 W/kg = 2.53 dBW/kg

Test Laboratory: Compliance Certification Services Inc.

WCDMA Band II RMC12.2Kbps Bottom side Ch9400 0mm

DUT: helmet Camera; Type: DS-MCH508; Serial: E55001866

Communication System: UID 0, WCDMA / UMTS (0); Frequency: 1880 MHz; Duty Cycle: 1:1
Medium parameters used: $f = 1880 \text{ MHz}$; $\sigma = 1.413 \text{ S/m}$; $\epsilon_r = 39.34$; $\rho = 1000 \text{ kg/m}^3$

Phantom section: Flat Section

Measurement Standard: DASYS (IEEE/IEC/ANSI C63.19-2007)

DASY5 Configuration:

- Probe: EX3DV4 - SN3798; ConvF(7.9, 7.9, 7.9); Calibrated: 2020/05/29;
- Sensor-Surface: 1.4mm (Mechanical Surface Detection)
- Electronics: DAE4 Sn1245; Calibrated: 2020/05/27
- Phantom: Twin SAM Phantom; Type: QD 000 P40 CD; Serial: 1609
- Measurement SW: DASYS2, Version 52.8 (8); SEMCAD X Version 14.6.10 (7331)

Configuration/Body/Area Scan (7x9x1): Measurement grid: $dx=15\text{mm}$, $dy=15\text{mm}$
Maximum value of SAR (measured) = 0.576 W/kg

Configuration/Body/Zoom Scan (5x5x7)/Cube 0: Measurement grid: $dx=8\text{mm}$,
 $dy=8\text{mm}$, $dz=5\text{mm}$

Reference Value = 7.907 V/m; Power Drift = -0.03 dB

Peak SAR (extrapolated) = 0.794 W/kg

SAR(1 g) = 0.461 W/kg; SAR(10 g) = 0.266 W/kg

Maximum value of SAR (measured) = 0.656 W/kg

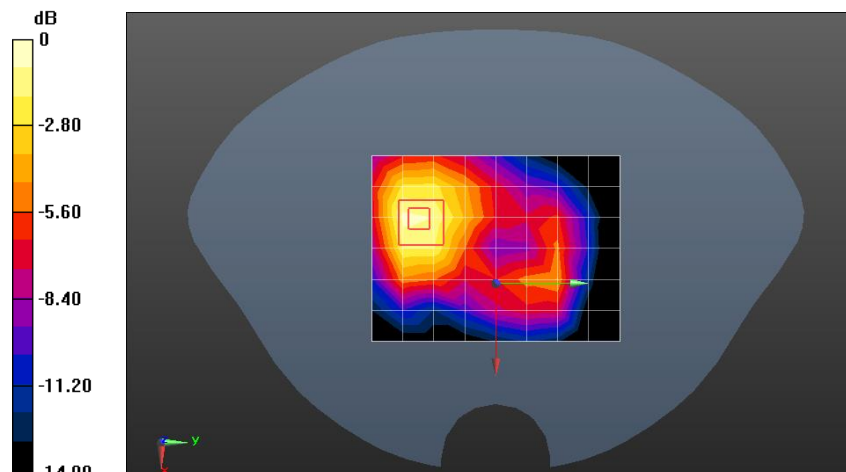

0 dB = 0.656 W/kg = -1.83 dBW/kg

Test Laboratory: Compliance Certification Services Inc.

WCDMA Band V RMC12.2Kbps Bottom side Ch4182 0mm

DUT: helmet Camera; Type: DS-MCH508; Serial: E55001866

Communication System: UID 0, WCDMA / UMTS (0); Frequency: 836.4 MHz; Duty Cycle: 1:1
Medium parameters used: $f = 836.4 \text{ MHz}$; $\sigma = 0.887 \text{ S/m}$; $\epsilon_r = 40.79$; $\rho = 1000 \text{ kg/m}^3$

Phantom section: Flat Section

Measurement Standard: DASYS (IEEE/IEC/ANSI C63.19-2007)

DASY5 Configuration:

- Probe: EX3DV4 - SN3798; ConvF(9.41, 9.41, 9.41); Calibrated: 2020/05/29;
- Sensor-Surface: 1.4mm (Mechanical Surface Detection)
- Electronics: DAE4 Sn1245; Calibrated: 2020/05/27
- Phantom: ELI v4.0; Type: QDOVA001BB; Serial: TP:1102
- Measurement SW: DASYS2, Version 52.8 (8); SEMCAD X Version 14.6.10 (7331)

Configuration/Body/Area Scan (7x9x1): Measurement grid: dx=15mm, dy=15mm

Maximum value of SAR (measured) = 0.201 W/kg

Configuration/Body/Zoom Scan (5x5x7)/Cube 0: Measurement grid: dx=8mm, dy=8mm, dz=5mm

Reference Value = 16.11 V/m; Power Drift = -0.06 dB

Peak SAR (extrapolated) = 0.235 W/kg

SAR(1 g) = 0.141 W/kg; SAR(10 g) = 0.097 W/kg

Maximum value of SAR (measured) = 0.195 W/kg

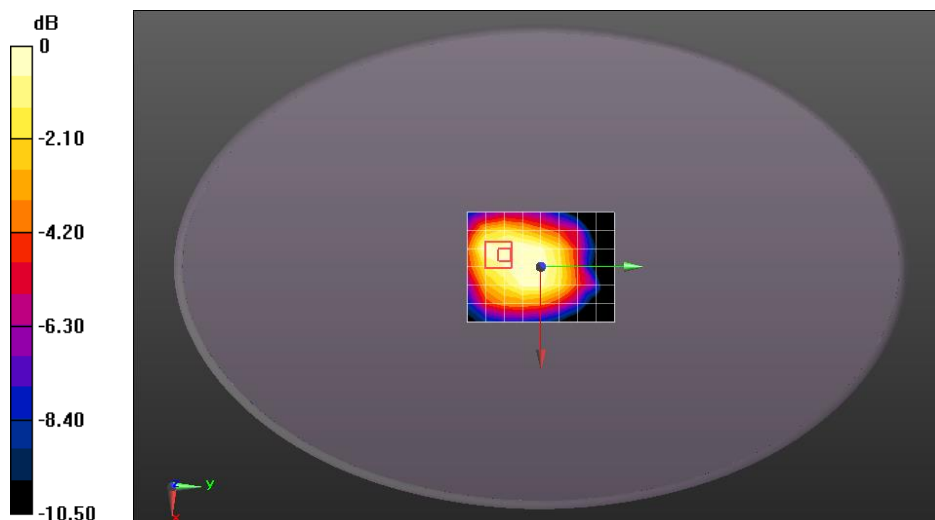

0 dB = 0.195 W/kg = -7.10 dBW/kg

Test Laboratory: Compliance Certification Services Inc.

LTE Band 2 20M QPSK 1RB50 Bottom side Ch18900 0mm

DUT: helmet Camera; Type: DS-MCH508; Serial: E55001866

Communication System: UID 0, FDD_LTE (0); Frequency: 1880 MHz; Duty Cycle: 1:1

Medium parameters used: $f = 1880$ MHz; $\sigma = 1.413$ S/m; $\epsilon_r = 39.34$; $\rho = 1000$ kg/m³

Phantom section: Flat Section

Measurement Standard: DASYS (IEEE/IEC/ANSI C63.19-2007)

DASY5 Configuration:

- Probe: EX3DV4 - SN3798; ConvF(7.9, 7.9, 7.9); Calibrated: 2020/05/29;
- Sensor-Surface: 1.4mm (Mechanical Surface Detection)
- Electronics: DAE4 Sn1245; Calibrated: 2020/05/27
- Phantom: Twin SAM Phantom; Type: QD 000 P40 CD; Serial: 1609
- Measurement SW: DASYS2, Version 52.8 (8); SEMCAD X Version 14.6.10 (7331)

Configuration/Body/Area Scan (7x9x1): Measurement grid: dx=15mm, dy=15mm

Maximum value of SAR (measured) = 0.529 W/kg

Configuration/Body/Zoom Scan (5x5x7)/Cube 0: Measurement grid: dx=8mm, dy=8mm, dz=5mm

Reference Value = 7.945 V/m; Power Drift = -0.09 dB

Peak SAR (extrapolated) = 0.716 W/kg

SAR(1 g) = 0.401 W/kg; SAR(10 g) = 0.226 W/kg

Maximum value of SAR (measured) = 0.593 W/kg

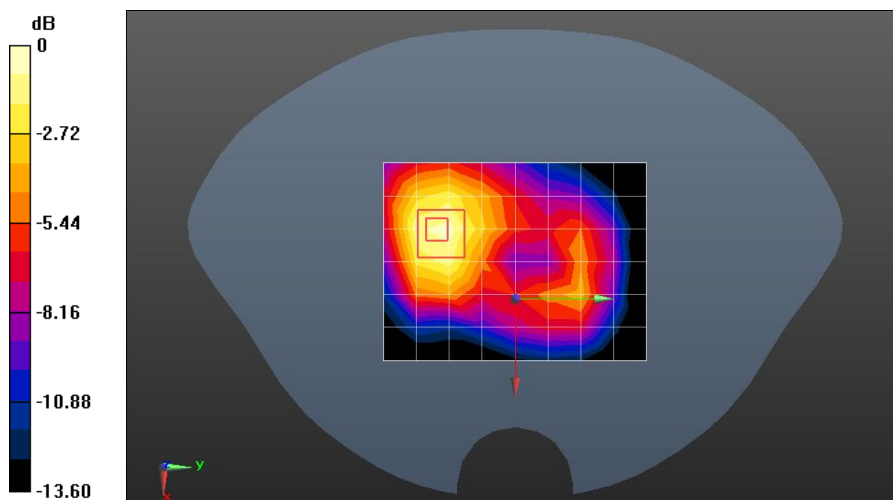

0 dB = 0.593 W/kg = -2.27 dBW/kg

Test Laboratory: Compliance Certification Services Inc.

LTE Band 4 20M QPSK 1RB50 Bottom side Ch20050 0mm

DUT: helmet Camera; Type: DS-MCH508; Serial: E55001866

Communication System: UID 0, FDD_LTE (0); Frequency: 1720 MHz; Duty Cycle: 1:1
 Medium parameters used: $f = 1720$ MHz; $\sigma = 1.379$ S/m; $\epsilon_r = 40.404$; $\rho = 1000$ kg/m³
 Phantom section: Flat Section
 Measurement Standard: DASYS (IEEE/IEC/ANSI C63.19-2007)

DASY5 Configuration:

- Probe: EX3DV4 - SN3798; ConvF(8.13, 8.13, 8.13); Calibrated: 2020/05/29;
- Sensor-Surface: 1.4mm (Mechanical Surface Detection)
- Electronics: DAE4 Sn1245; Calibrated: 2020/05/27
- Phantom: Twin SAM Phantom; Type: QD 000 P40 CD; Serial: 1609
- Measurement SW: DASYS2, Version 52.8 (8); SEMCAD X Version 14.6.10 (7331)

Configuration/Body/Area Scan (7x9x1): Measurement grid: dx=15mm, dy=15mm
 Maximum value of SAR (measured) = 0.226 W/kg

Configuration/Body/Zoom Scan (5x5x7)/Cube 0: Measurement grid: dx=8mm, dy=8mm, dz=5mm

Reference Value = 8.709 V/m; Power Drift = -0.02 dB

Peak SAR (extrapolated) = 0.314 W/kg

SAR(1 g) = 0.176 W/kg; SAR(10 g) = 0.104 W/kg

Maximum value of SAR (measured) = 0.250 W/kg

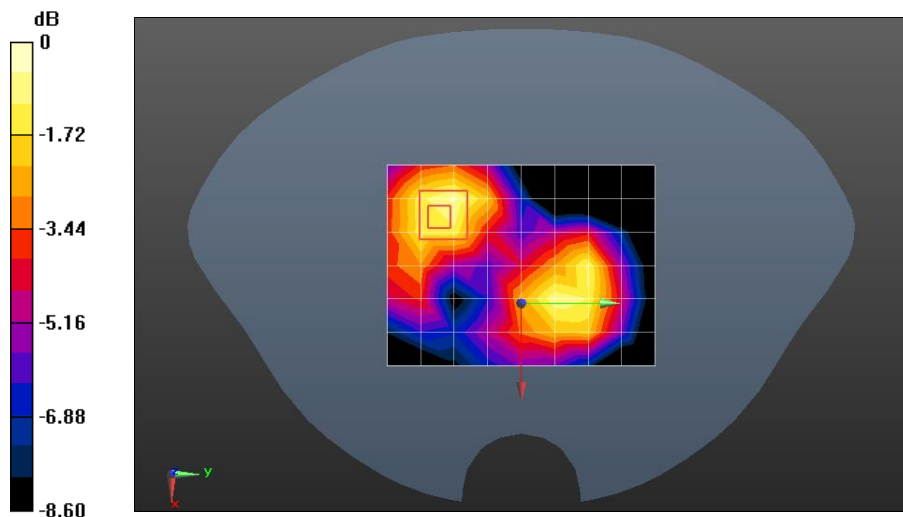

0 dB = 0.250 W/kg = -6.02 dBW/kg

Test Laboratory: Compliance Certification Services Inc.

10_LTE Band 5 10M QPSK 1RB25 Bottom side Ch20600 0mm

DUT: helmet Camera; Type: DS-MCH508; Serial: E55001866

Communication System: UID 0, FDD_LTE (0); Frequency: 844 MHz; Duty Cycle: 1:1

Medium parameters used: $f = 844 \text{ MHz}$; $\sigma = 0.892 \text{ S/m}$; $\epsilon_r = 40.742$; $\rho = 1000 \text{ kg/m}^3$

Phantom section: Flat Section

Measurement Standard: DASYS (IEEE/IEC/ANSI C63.19-2007)

DASY5 Configuration:

- Probe: EX3DV4 - SN3798; ConvF(9.41, 9.41, 9.41); Calibrated: 2020/05/29;
- Sensor-Surface: 1.4mm (Mechanical Surface Detection)
- Electronics: DAE4 Sn1245; Calibrated: 2020/05/27
- Phantom: ELI v4.0; Type: QDOVA001BB; Serial: TP:1102
- Measurement SW: DASYS2, Version 52.8 (8); SEMCAD X Version 14.6.10 (7331)

Configuration/Body/Area Scan (6x9x1): Measurement grid: $dx=15\text{mm}$, $dy=15\text{mm}$

Maximum value of SAR (measured) = 0.232 W/kg

Configuration/Body/Zoom Scan (5x5x7)/Cube 0: Measurement grid: $dx=8\text{mm}$,

$dy=8\text{mm}$, $dz=5\text{mm}$

Reference Value = 15.39 V/m; Power Drift = -0.06 dB

Peak SAR (extrapolated) = 0.208 W/kg

SAR(1 g) = 0.131 W/kg; SAR(10 g) = 0.088 W/kg

Maximum value of SAR (measured) = 0.174 W/kg

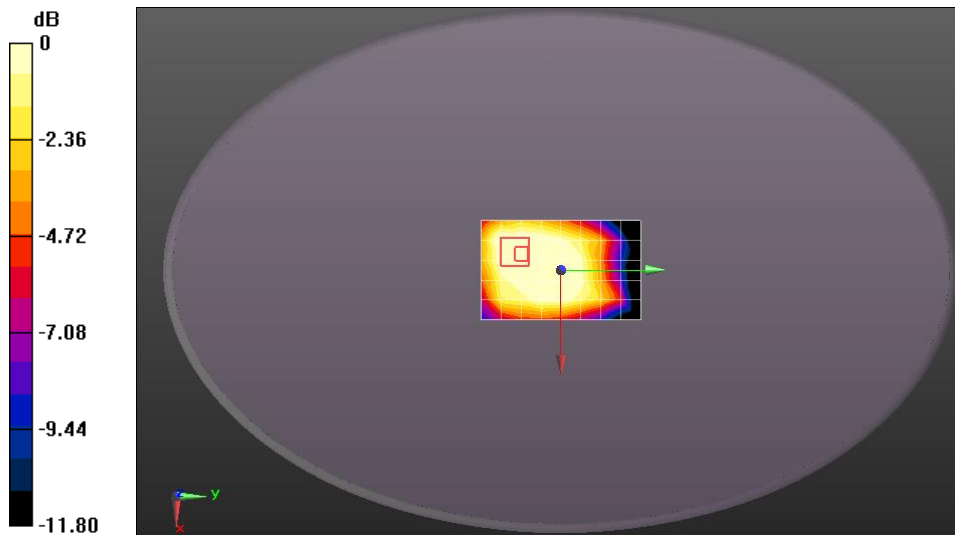

0 dB = 0.174 W/kg = -7.59 dBW/kg

Test Laboratory: Compliance Certification Services Inc.

01_LTE Band 7 20M QPSK 1RB50 Bottom side Ch21350 0mm

DUT: helmet Camera; Type: DS-MCH508; Serial: E55001866

Communication System: UID 0, FDD_LTE (0); Frequency: 2560 MHz; Duty Cycle: 1:1
 Medium parameters used: $f = 2560$ MHz; $\sigma = 1.922$ S/m; $\epsilon_r = 37.871$; $\rho = 1000$ kg/m³
 Phantom section: Flat Section
 Measurement Standard: DASYS (IEEE/IEC/ANSI C63.19-2007)

DASY5 Configuration:

- Probe: EX3DV4 - SN3798; ConvF(7.06, 7.06, 7.06); Calibrated: 2020/05/29;
- Sensor-Surface: 1.4mm (Mechanical Surface Detection)
- Electronics: DAE4 Sn1245; Calibrated: 2020/05/27
- Phantom: ELI v4.0; Type: QDOVA001BB; Serial: TP:1102
- Measurement SW: DASYS2, Version 52.8 (8); SEMCAD X Version 14.6.10 (7331)

Configuration/Body/Area Scan (7x9x1): Measurement grid: dx=15mm, dy=15mm
 Maximum value of SAR (measured) = 0.458 W/kg

Configuration/Body/Zoom Scan (5x5x7)/Cube 0: Measurement grid: dx=8mm, dy=8mm, dz=5mm

Reference Value = 5.012 V/m; Power Drift = 0.04 dBss

Peak SAR (extrapolated) = 0.789 W/kg

SAR(1 g) = 0.382 W/kg; SAR(10 g) = 0.201 W/kg

Maximum value of SAR (measured) = 0.617 W/kg

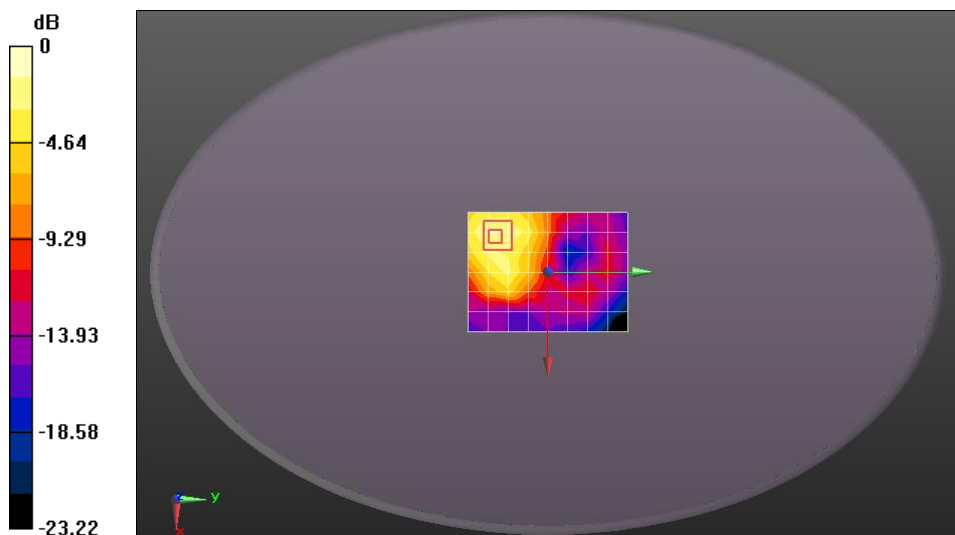

0 dB = 0.617 W/kg = -2.10 dBW/kg

Test Laboratory: Compliance Certification Services Inc.

WLAN2.4GHz 802.11g 6Mbps Bottom side Ch11 0mm

DUT: helmet Camera; Type: DS-MCH508; Serial: E55001865

Communication System: UID 0, WiFi (0); Frequency: 2462 MHz; Duty Cycle: 1:1
 Medium parameters used: $f = 2462$ MHz; $\sigma = 1.818$ S/m; $\epsilon_r = 38.234$; $\rho = 1000$ kg/m³
 Phantom section: Flat Section
 Measurement Standard: DASYS (IEEE/IEC/ANSI C63.19-2007)

DASY5 Configuration:

- Probe: EX3DV4 - SN3798; ConvF(7.27, 7.27, 7.27); Calibrated: 2020/05/29;
- Sensor-Surface: 1.4mm (Mechanical Surface Detection)
- Electronics: DAE4 Sn1245; Calibrated: 2020/05/27
- Phantom: ELI v4.0; Type: QDOVA001BB; Serial: TP:1102
- Measurement SW: DASYS2, Version 52.8 (8); SEMCAD X Version 14.6.10 (7331)

Configuration/Body/Area Scan (8x11x1): Measurement grid: dx=12mm, dy=12mm
 Maximum value of SAR (measured) = 0.0327 W/kg

Configuration/Body/Zoom Scan (7x7x7)/Cube 0: Measurement grid: dx=5mm, dy=5mm, dz=5mm

Reference Value = 1.773 V/m; Power Drift = -0.04 dB

Peak SAR (extrapolated) = 0.0880 W/kg

SAR(1 g) = 0.009 W/kg; SAR(10 g) = 0.003 W/kg

Maximum value of SAR (measured) = 0.0378 W/kg

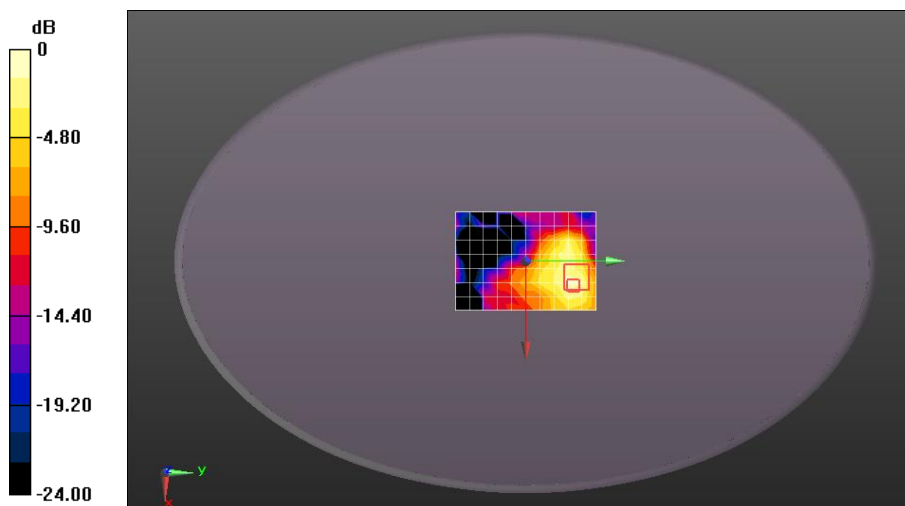

0 dB = 0.0378 W/kg = -14.23 dBW/kg



**Compliance Certification Services
(Kunshan) Inc.**

Report No.: KSEM200900127801

Page: 87 of 87

Appendix C: Calibration certificate

Appendix D: Photographs

---END---
