

Test Report

Application No.: KSCR2210001874AT
FCC ID: 2ADTD-K3B631TXMED
Applicant: Hangzhou Hikvision Digital Technology Co., Ltd.
Address of Applicant: No.555 Qianmo Road,Binjiang District Hangzhou 310052,China
Manufacturer: Hangzhou Hikvision Digital Technology Co., Ltd.
Address of Manufacturer: No.555 Qianmo Road,Binjiang District Hangzhou 310052,China
Factory:
1.Hangzhou Hikvision Technology Co., Ltd.
2.Hangzhou Hikvision Electronics Co., Ltd.
3.Chongqing Hikvision Technology Co., Ltd.,
4.WuHan Hikvision Technology Co. Ltd
Address of Factory:
1.No.700,Dongliu Road, Binjiang District, Hangzhou Ctiy,Zhejiang, 310052, China
2.No.299,Qiushi Road,Tonglu Economic Development Zone,Tonglu County, Hangzhou,Zhejiang, 311500,China.
3.NO.118.Haikang Road,Area C,Jianqiao Industrial Park,Dadukou District,Chongqing,401325,China.
4.No. 12, Wenhua Road, Zhifang Street, Jiangxia District, Wuhan City
Equipment Under Test (EUT):
EUT Name: Swing Barrier
Model No.: Refer to page2[□]
□ Please refer to section 2 of this report which indicates which model was actually tested and which were electrically identical.
Standard(s) : 47 CFR Part 15, Subpart C 15.209
Date of Receipt: 2022-10-11
Date of Test: 2022-11-02 to 2022-11-02
Date of Issue: 2022-11-04

Test Result:	Pass*
---------------------	--------------

* In the configuration tested, the EUT complied with the standards specified above.

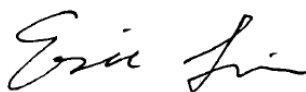

Eric Lin
Laboratory Manager



Unless otherwise agreed in writing, this document is issued by the Company subject to its General Conditions of Service printed overleaf, available on request or accessible at <http://www.sgs.com/en/Terms-and-Conditions.aspx> and, for electronic format documents, subject to Terms and Conditions for Electronic Documents at <http://www.sgs.com/en/Terms-and-Conditions/Terms-e-Document.aspx>. Attention is drawn to the limitation of liability, indemnification and jurisdiction issues defined therein. Any holder of this document is advised that information contained hereon reflects the Company's findings at the time of its intervention only and within the limits of Client's instructions, if any. The Company's sole responsibility is to its Client and this document does not exonerate parties to a transaction from exercising all their rights and obligations under the transaction documents. This document cannot be reproduced except in full, without prior written approval of the Company. Any unauthorized alteration, forgery or falsification of the content or appearance of this document is unlawful and offenders may be prosecuted to the fullest extent of the law. Unless otherwise stated the results shown in this test report refer only to the sample(s) tested and such sample(s) are retained for 30 days only.
Attention: To check the authenticity of testing /inspection report & certificate, please contact us at telephone: (86-755) 8307 1443, or email: CN.Doccheck@sgs.com

No.10, Weiye Road, Innovation Park, Kunshan, Jiangsu, China 215300
中国·江苏·昆山市留学生创业园伟业路10号 邮编 215300

t(86-512)57355888 f(86-512)57370818 www.sgsgroup.com.cn
t(86-512)57355888 f(86-512)57370818 sgs.china@sgs.com

Compliance Certification Services (Kunshan) Inc.

Report No.: KSCR221000187404

Page: 2 of 31

Model No.:

DS-K3B631TX-L,DS-K3B631TX-M,DS-K3B631TX-R,DS-K3B631TX-UHK,DS-K3B631TX-CKV,
DS-K3B631TX-UVS,DS-K3B631TX-KVO,DS-K3B631TX-HUN,DS-K3B631TX-L/D,DS-K3B631TX-M/D,
DS-K3B631TX-R/D,DS-K3B631TX-L/ED,DS-K3B631TX-M/ED,DS-K3B631TX-R/ED,DS-K3B631TX-L/M,
DS-K3B631TX-M/M,DS-K3B631TX-R/M,DS-K3B631TX-L/E,DS-K3B631TX-M/E,DS-K3B631TX-R/E



Compliance Certification Services (Kunshan) Inc.
EMC Laboratory

Unless otherwise agreed in writing, this document is issued by the Company subject to its General Conditions of Service printed overleaf, available on request or accessible at <http://www.sgs.com/en/Terms-and-Conditions.aspx> and, for electronic format documents, subject to Terms and Conditions for Electronic Documents at <http://www.sgs.com/en/Terms-and-Conditions/Terms-e-Documents.aspx>. Attention is drawn to the limitation of liability, indemnification and jurisdiction issues defined therein. Any holder of this document is advised that information contained hereon reflects the Company's findings at the time of its intervention only and within the limits of Client's instructions, if any. The Company's sole responsibility is to its Client and this document does not exonerate parties to a transaction from exercising all their rights and obligations under the transaction documents. This document cannot be reproduced except in full, without prior written approval of the Company. Any unauthorized alteration, forgery or falsification of the content or appearance of this document is unlawful and offenders may be prosecuted to the fullest extent of the law. Unless otherwise stated the results shown in this test report refer only to the sample(s) tested and such sample(s) are retained for 30 days only.
Attention: To check the authenticity of testing /inspection report & certificate, please contact us at telephone: (86-755) 8307 1443, or email: CN.Doccheck@sgs.com

No.10, Weiye Road, Innovation Park, Kunshan, Jiangsu, China 215300
中国·江苏·昆山市留学生创业园伟业路10号 邮编 215300

t(86-512)57355888 f(86-512)57370818 www.sgs.com.cn
t(86-512)57355888 f(86-512)57370818 sgs.china@sgs.com

Revision Record			
Version	Description	Date	Remark
00	Original	2022-11-04	/

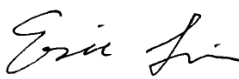
Authorized for issue by:			
			
		<hr/> Eric_Liu/Project Engineer	
			
		<hr/> Eric Lin /Reviewer	



Unless otherwise agreed in writing, this document is issued by the Company subject to its General Conditions of Service printed overleaf, available on request or accessible at <http://www.sgs.com/en/Terms-and-Conditions.aspx> and, for electronic format documents, subject to Terms and Conditions for Electronic Documents at <http://www.sgs.com/en/Terms-and-Conditions/Terms-e-Documents.aspx>. Attention is drawn to the limitation of liability, indemnification and jurisdiction issues defined therein. Any holder of this document is advised that information contained hereon reflects the Company's findings at the time of its intervention only and within the limits of Client's instructions, if any. The Company's sole responsibility is to its Client and this document does not exonerate parties to a transaction from exercising all their rights and obligations under the transaction documents. This document cannot be reproduced except in full, without prior written approval of the Company. Any unauthorized alteration, forgery or falsification of the content or appearance of this document is unlawful and offenders may be prosecuted to the fullest extent of the law. Unless otherwise stated the results shown in this test report refer only to the sample(s) tested and such sample(s) are retained for 30 days only.

Attention: To check the authenticity of testing /inspection report & certificate, please contact us at telephone: (86-755) 8307 1443, or email: CN.Doccheck@sgs.com

No.10, Weiye Road, Innovation Park, Kunshan, Jiangsu, China 215300
 中国·江苏·昆山市留学生创业园伟业路10号 邮编 215300

t(86-512)57355888 f(86-512)57370818 www.sgs.com.cn
 t(86-512)57355888 f(86-512)57370818 sgs.china@sgs.com

2 Test Summary

Radio Spectrum Technical Requirement				
Item	Standard	Method	Requirement	Result
Antenna Requirement	47 CFR Part 15, Subpart C	N/A	47 CFR Part 15, Subpart C 15.203	Customer Declaration

Radio Spectrum Matter Part				
Item	Standard	Method	Requirement	Result
20dB Bandwidth	47 CFR Part 15, Subpart C	ANSI C63.10 (2013) Section 6.9.2	47 CFR Part 15, Subpart C 15.215	Pass
Radiated Emissions (9kHz-30MHz)		ANSI C63.10 (2013) Section 6.4	47 CFR Part 15, Subpart C 15.205 & 15.209	Pass
Radiated Emissions (30MHz-1GHz)		ANSI C63.10 (2013) Section 6.5	47 CFR Part 15, Subpart C 15.205 & 15.209	Pass
Conducted Emissions at AC Mains Power Port (150kHz-30MHz)		ANSI C63.10 (2013) Section 6.2	47 CFR Part 15, Subpart C 15.207	Pass

Declaration of EUT Family Grouping:

Note: There are series models mentioned in this report, and they are the identical in electrical and electronic characters. Only the model DS-K3B631TXM/ED was tested since their differences were the model number and appearance (product support one side or two sides card reader function).



Unless otherwise agreed in writing, this document is issued by the Company subject to its General Conditions of Service printed overleaf, available on request or accessible at <http://www.sgs.com/en/Terms-and-Conditions.aspx> and, for electronic format documents, subject to Terms and Conditions for Electronic Documents at <http://www.sgs.com/en/Terms-and-Conditions/Terms-e-Documents.aspx>. Attention is drawn to the limitation of liability, indemnification and jurisdiction issues defined therein. Any holder of this document is advised that information contained hereon reflects the Company's findings at the time of its intervention only and within the limits of Client's instructions, if any. The Company's sole responsibility is to its Client and this document does not exonerate parties to a transaction from exercising all their rights and obligations under the transaction documents. This document cannot be reproduced except in full, without prior written approval of the Company. Any unauthorized alteration, forgery or falsification of the content or appearance of this document is unlawful and offenders may be prosecuted to the fullest extent of the law. Unless otherwise stated the results shown in this test report refer only to the sample(s) tested and such sample(s) are retained for 30 days only.
Attention: To check the authenticity of testing /inspection report & certificate, please contact us at telephone: (86-755) 8307 1443, or email: CN.Doccheck@sgs.com

No.10, Weiye Road, Innovation Park, Kunshan, Jiangsu, China 215300
 中国·江苏·昆山市留学生创业园伟业路10号 邮编 215300

t(86-512)57355888 f(86-512)57370818 www.sgsgroup.com.cn
 t(86-512)57355888 f(86-512)57370818 sgs.china@sgs.com

3 Contents

	Page
1 COVER PAGE	1
2 TEST SUMMARY	4
3 CONTENTS	5
4 GENERAL INFORMATION	7
4.1 DETAILS OF E.U.T.	7
4.2 DESCRIPTION OF SUPPORT UNITS	7
4.3 MEASUREMENT UNCERTAINTY	8
4.4 TEST LOCATION.....	9
4.5 TEST FACILITY.....	9
4.6 DEVIATION FROM STANDARDS	9
4.7 ABNORMALITIES FROM STANDARD CONDITIONS	9
5 EQUIPMENT LIST.....	10
6 RADIO SPECTRUM TECHNICAL REQUIREMENT	11
6.1 ANTENNA REQUIREMENT	11
6.1.1 Test Requirement:	11
6.1.2 Conclusion	11
7 RADIO SPECTRUM MATTER TEST RESULTS.....	12
7.1 20dB BANDWIDTH	12
7.1.1 E.U.T. Operation	12
7.1.2 Test Mode Description	12
7.1.3 Test Setup Diagram	12
7.1.4 Measurement Procedure and Data.....	12
7.2 RADIATED EMISSIONS (9KHz-30MHz).....	13
7.2.1 E.U.T. Operation	13
7.2.2 Test Mode Description	14
7.2.3 Test Setup Diagram	14
7.2.4 Measurement Procedure and Data.....	14
7.3 RADIATED EMISSIONS (30MHz-1GHz).....	15
7.3.1 E.U.T. Operation	15
7.3.2 Test Mode Description	15
7.3.3 Test Setup Diagram	15
7.3.4 Measurement Procedure and Data.....	16
7.4 CONDUCTED EMISSIONS AT AC MAINS POWER PORT (150kHz-30MHz)	17
7.4.1 E.U.T. Operation	17
7.4.2 Test Mode Description	17
7.4.3 Test Setup Diagram	18
7.4.4 Measurement Procedure and Data.....	18
8 TEST SETUP PHOTO.....	21



Unless otherwise agreed in writing, this document is issued by the Company subject to its General Conditions of Service printed overleaf, available on request or accessible at <http://www.sgs.com/en/Terms-and-Conditions.aspx> and, for electronic format documents, subject to Terms and Conditions for Electronic Documents at <http://www.sgs.com/en/Terms-and-Conditions/Terms-e-Documents.aspx>. Attention is drawn to the limitation of liability, indemnification and jurisdiction issues defined therein. Any holder of this document is advised that information contained hereon reflects the Company's findings at the time of its intervention only and within the limits of Client's instructions, if any. The Company's sole responsibility is to its Client and this document does not exonerate parties to a transaction from exercising all their rights and obligations under the transaction documents. This document cannot be reproduced except in full, without prior written approval of the Company. Any unauthorized alteration, forgery or falsification of the content or appearance of this document is unlawful and offenders may be prosecuted to the fullest extent of the law. Unless otherwise stated the results shown in this test report refer only to the sample(s) tested and such sample(s) are retained for 30 days only.

Attention: To check the authenticity of testing /inspection report & certificate, please contact us at telephone: (86-755) 8307 1443, or email: CN.Doccheck@sgs.com

No.10, Weiye Road, Innovation Park, Kunshan, Jiangsu, China 215300
 中国·江苏·昆山市留学生创业园伟业路10号 邮编 215300

t(86-512)57355888 f(86-512)57370818 www.sgs.com.cn
 t(86-512)57355888 f(86-512)57370818 sgs.china@sgs.com

Compliance Certification Services (Kunshan) Inc.

Report No.: KSCR221000187404

Page: 6 of 31

9 EUT CONSTRUCTIONAL DETAILS (EUT PHOTOS)21

10 APPENDIX.....22



Unless otherwise agreed in writing, this document is issued by the Company subject to its General Conditions of Service printed overleaf, available on request or accessible at <http://www.sgs.com/en/Terms-and-Conditions.aspx> and, for electronic format documents, subject to Terms and Conditions for Electronic Documents at <http://www.sgs.com/en/Terms-and-Conditions/Terms-e-Documents.aspx>. Attention is drawn to the limitation of liability, indemnification and jurisdiction issues defined therein. Any holder of this document is advised that information contained hereon reflects the Company's findings at the time of its intervention only and within the limits of Client's instructions, if any. The Company's sole responsibility is to its Client and this document does not exonerate parties to a transaction from exercising all their rights and obligations under the transaction documents. This document cannot be reproduced except in full, without prior written approval of the Company. Any unauthorized alteration, forgery or falsification of the content or appearance of this document is unlawful and offenders may be prosecuted to the fullest extent of the law. Unless otherwise stated the results shown in this test report refer only to the sample(s) tested and such sample(s) are retained for 30 days only.
Attention: To check the authenticity of testing /inspection report & certificate, please contact us at telephone: (86-755) 8307 1443, or email: CN.Doccheck@sgs.com

No.10, Weiye Road, Innovation Park, Kunshan, Jiangsu, China 215300
中国·江苏·昆山市留学生创业园伟业路10号 邮编 215300

t(86-512)57355888 f(86-512)57370818 www.sgs.com.cn
t(86-512)57355888 f(86-512)57370818 sgs.china@sgs.com

4 General Information

4.1 Details of E.U.T.

Power supply:	AC100-240V,50/60Hz, 3A-1.25A
Antenna Type	Loop Antenna
Modulation Type	ASK
Number of Channels	1
Operation Frequency	125kHz

4.2 Description of Support Units

Description	Manufacturer	Model No.	Serial No.
The EUT has been tested as an independent unit.			



Unless otherwise agreed in writing, this document is issued by the Company subject to its General Conditions of Service printed overleaf, available on request or accessible at <http://www.sgs.com/en/Terms-and-Conditions.aspx> and, for electronic format documents, subject to Terms and Conditions for Electronic Documents at <http://www.sgs.com/en/Terms-and-Conditions/Terms-e-Document.aspx>. Attention is drawn to the limitation of liability, indemnification and jurisdiction issues defined therein. Any holder of this document is advised that information contained hereon reflects the Company's findings at the time of its intervention only and within the limits of Client's instructions, if any. The Company's sole responsibility is to its Client and this document does not exonerate parties to a transaction from exercising all their rights and obligations under the transaction documents. This document cannot be reproduced except in full, without prior written approval of the Company. Any unauthorized alteration, forgery or falsification of the content or appearance of this document is unlawful and offenders may be prosecuted to the fullest extent of the law. Unless otherwise stated the results shown in this test report refer only to the sample(s) tested and such sample(s) are retained for 30 days only.

Attention: To check the authenticity of testing /inspection report & certificate, please contact us at telephone: (86-755) 8307 1443, or email: CN.Doccheck@sgs.com

No.10, Weiye Road, Innovation Park, Kunshan, Jiangsu, China 215300
 中国·江苏·昆山市留学院创业园伟业路10号 邮编 215300

t(86-512)57355888 f(86-512)57370818 www.sgsgroup.com.cn
 t(86-512)57355888 f(86-512)57370818 sgs.china@sgs.com

4.3 Measurement Uncertainty

No.	Item	Measurement Uncertainty
1	Radio Frequency	8.4 x 10 ⁻⁸
2	Timeout	2s
3	Duty Cycle	0.37%
4	Occupied Bandwidth	3%
5	RF Conducted Power	0.6dB
6	RF Power Density	2.9dB
7	Conducted Spurious Emissions	0.75dB
8	RF Radiated Power	5.2dB (Below 1GHz)
		5.9dB (Above 1GHz)
9	Radiated Spurious Emission Test	4.2dB (Below 30MHz)
		4.5dB (30MHz-1GHz)
		5.1dB (1GHz-18GHz)
		5.4dB (Above 18GHz)
10	Temperature Test	1°C
11	Humidity Test	3%
12	Supply Voltages	1.5%
13	Time	3%

Note: The measurement uncertainty represents an expanded uncertainty expressed at approximately the 95% confidence level using a coverage factor of k=2.



Unless otherwise agreed in writing, this document is issued by the Company subject to its General Conditions of Service printed overleaf, available on request or accessible at <http://www.sgs.com/en/Terms-and-Conditions.aspx> and, for electronic format documents, subject to Terms and Conditions for Electronic Documents at <http://www.sgs.com/en/Terms-and-Conditions/Terms-e-Documents.aspx>. Attention is drawn to the limitation of liability, indemnification and jurisdiction issues defined therein. Any holder of this document is advised that information contained hereon reflects the Company's findings at the time of its intervention only and within the limits of Client's instructions, if any. The Company's sole responsibility is to its Client and this document does not exonerate parties to a transaction from exercising all their rights and obligations under the transaction documents. This document cannot be reproduced except in full, without prior written approval of the Company. Any unauthorized alteration, forgery or falsification of the content or appearance of this document is unlawful and offenders may be prosecuted to the fullest extent of the law. Unless otherwise stated the results shown in this test report refer only to the sample(s) tested and such sample(s) are retained for 30 days only.
Attention: To check the authenticity of testing /inspection report & certificate, please contact us at telephone: (86-755) 8307 1443, or email: CN.Doccheck@sgs.com

No.10, Weiye Road, Innovation Park, Kunshan, Jiangsu, China 215300
 中国·江苏·昆山市留学生创业园伟业路10号 邮编 215300

t(86-512)57355888 f(86-512)57370818 www.sgsgroup.com.cn
 t(86-512)57355888 f(86-512)57370818 sgs.china@sgs.com

4.4 Test Location

All tests were performed at:

Compliance Certification Services (Kunshan) Inc.

No.10 Weiye Rd, Innovation Park, Eco&Tec, Development Zone, Kunshan City, Jiangsu, China.

Tel: +86 512 5735 5888 Fax: +86 512 5737 0818

No tests were sub-contracted.

Note:

1.SGS is not responsible for wrong test results due to incorrect information (e.g., max. internal working frequency, antenna gain, cable loss, etc) is provided by the applicant. (If applicable).

2.SGS is not responsible for the authenticity, integrity and the validity of the conclusion based on results of the data provided by applicant. (If applicable).

4.5 Test Facility

The test facility is recognized, certified, or accredited by the following organizations:

• CNAS

Compliance Certification Services (Kunshan) Inc. is accredited by the China National Accreditation Service for Conformity Assessment (CNAS). Registration No. CNAS L4354

• A2LA

Compliance Certification Services (Kunshan) Inc. is accredited by the American Association for Laboratory Accreditation (A2LA). Certificate No. 2541.01.

• FCC

Compliance Certification Services (Kunshan) Inc. has been recognized as an accredited testing laboratory. Designation Number: CN1172.

• ISED

Compliance Certification Services (Kunshan) Inc. has been recognized by Innovation, Science and Economic Development Canada (ISED) as an accredited testing laboratory. Company Number: 2324E

• VCCI

The 3m and 10m Semi-anechoic chamber and Shielded Room of Compliance Certification Services (Kunshan) Inc. has been registered in accordance with the Regulations for Voluntary Control Measures with Registration No.: R-20134, R-11600, C-11707, T-11499, G-10216 respectively.

4.6 Deviation from Standards

None

4.7 Abnormalities from Standard Conditions

None



Unless otherwise agreed in writing, this document is issued by the Company subject to its General Conditions of Service printed overleaf, available on request or accessible at <http://www.sgs.com/en/Terms-and-Conditions.aspx> and, for electronic format documents, subject to Terms and Conditions for Electronic Documents at <http://www.sgs.com/en/Terms-and-Conditions/Terms-e-Documents.aspx>. Attention is drawn to the limitation of liability, indemnification and jurisdiction issues defined therein. Any holder of this document is advised that information contained hereon reflects the Company's findings at the time of its intervention only and within the limits of Client's instructions, if any. The Company's sole responsibility is to its Client and this document does not exonerate parties to a transaction from exercising all their rights and obligations under the transaction documents. This document cannot be reproduced except in full, without prior written approval of the Company. Any unauthorized alteration, forgery or falsification of the content or appearance of this document is unlawful and offenders may be prosecuted to the fullest extent of the law. Unless otherwise stated the results shown in this test report refer only to the sample(s) tested and such sample(s) are retained for 30 days only.
Attention: To check the authenticity of testing /inspection report & certificate, please contact us at telephone: (86-755) 8307 1443, or email: CN.Doccheck@sgs.com

No.10, Weiye Road, Innovation Park, Kunshan, Jiangsu, China 215300
中国·江苏·昆山市留学院创业园伟业路10号 邮编 215300

t(86-512)57355888 f(86-512)57370818 www.sgs.com
t(86-512)57355888 f(86-512)57370818 sgs.china@sgs.com

5 Equipment List

Item	Equipment	Manufacturer	Model	Inventory No	Cal Date	Cal. Due Date
Conducted Emission at Mains Terminals (150kHz-30MHz)						
1	EMI Test Receive	R&S	ESCI	KS301101	01/22/2022	01/21/2023
2	LISN	R&S	ENV216	KS301197	01/22/2022	01/21/2023
3	LISN	Schwarzbeck	NNLK 8129	KS301091	01/22/2022	01/21/2023
4	Pulse Limiter	R&S	ESH3-Z2	KUS1902E001	01/22/2022	01/21/2023
5	CE test Cable	Thermax	/	CZ301102	11/14/2021	11/13/2022
6	Test Software	Farad	EZ-EMC	/	N.C.R	N.C.R
RF Radiated Test						
1	Spectrum Analyzer	R&S	FSV40	KUS1806E003	08/22/2022	08/21/2023
2	Universal Radio Communication Tester	R&S	CMW500	KSEM009-1	04/01/2022	03/31/2023
3	Signal Generator	Agilent	E8257C	KS301066	08/22/2022	08/21/2023
4	Loop Antenna	COM-POWER	AL-130R	KUS1806E001	04/13/2021	04/12/2023
5	Bilog Antenna	TESEQ	CBL 6112D	KUS1806E005	06/29/2021	06/28/2023
6	Bilog Antenna	SCHWARZBECK	VULB9160	CZ301016	04/13/2021	04/12/2024
7	Horn-antenna(1-18GHz)	Schwarzbeck	BBHA9120D	KS301079	04/02/2022	04/01/2024
8	Horn-antenna(1-18GHz)	ETS-LINDGREN	3117	KS301186	02/22/2021	02/21/2023
9	Horn Antenna(18-40GHz)	Schwarzbeck	BBHA9170	CZ301058	03/17/2022	03/16/2023
10	Amplifier(30MHz~18GHz)	PANSHAN TECHNOLOGY	LNA:1~18G	KSEM010-1	01/22/2022	01/21/2023
11	Amplifier(18~40GHz)	COM-POWER	PAM-840A	KUS1710E001	01/22/2022	01/21/2023
12	RE Test Cable	REBES MICROWAVE	/	CZ301097	11/14/2021	11/13/2022
13	Temperature & Humidity Recorder	Renke Control	RS-WS-N01-6J	KSEM024-4	01/04/2022	31/03/2023
14	Software	Faratronic	EZ_EMC-v 3A1	/	N/A	N/A



Unless otherwise agreed in writing, this document is issued by the Company subject to its General Conditions of Service printed overleaf, available on request or accessible at <http://www.sgs.com/en/Terms-and-Conditions.aspx> and, for electronic format documents, subject to Terms and Conditions for Electronic Documents at <http://www.sgs.com/en/Terms-and-Conditions/Terms-e-Documents.aspx>. Attention is drawn to the limitation of liability, indemnification and jurisdiction issues defined therein. Any holder of this document is advised that information contained hereon reflects the Company's findings at the time of its intervention only and within the limits of Client's instructions, if any. The Company's sole responsibility is to its Client and this document does not exonerate parties to a transaction from exercising all their rights and obligations under the transaction documents. This document cannot be reproduced except in full, without prior written approval of the Company. Any unauthorized alteration, forgery or falsification of the content or appearance of this document is unlawful and offenders may be prosecuted to the fullest extent of the law. Unless otherwise stated the results shown in this test report refer only to the sample(s) tested and such sample(s) are retained for 30 days only.
Attention: To check the authenticity of testing / inspection report & certificate, please contact us at telephone: (86-755) 8307 1443, or email: CN.Doccheck@sgs.com

No.10, Weiye Road, Innovation Park, Kunshan, Jiangsu, China 215300
 中国·江苏·昆山市留学生创业园伟业路10号 邮编 215300

t(86-512)57355888 f(86-512)57370818 www.sgsgroup.com.cn
 t(86-512)57355888 f(86-512)57370818 sgs.china@sgs.com

6 Radio Spectrum Technical Requirement

6.1 Antenna Requirement

6.1.1 Test Requirement:

47 CFR Part 15, Subpart C 15.203

6.1.2 Conclusion

Standard Requirement:

An intentional radiator shall be designed to ensure that no antenna other than that furnished by the responsible party shall be used with the device. The use of a antenna that uses a unique coupling to the intentional radiator, the manufacturer may design the unit permanently attached antenna or of an so that a broken antenna can be replaced by the user, but the use of a standard antenna jack or electrical connector is prohibited.

EUT Antenna:

The antenna is integrated on the main PCB and no consideration of replacement.
Refer to internal photos



Unless otherwise agreed in writing, this document is issued by the Company subject to its General Conditions of Service printed overleaf, available on request or accessible at <http://www.sgs.com/en/Terms-and-Conditions.aspx> and, for electronic format documents, subject to Terms and Conditions for Electronic Documents at <http://www.sgs.com/en/Terms-and-Conditions/Terms-e-Documents.aspx>. Attention is drawn to the limitation of liability, indemnification and jurisdiction issues defined therein. Any holder of this document is advised that information contained hereon reflects the Company's findings at the time of its intervention only and within the limits of Client's instructions, if any. The Company's sole responsibility is to its Client and this document does not exonerate parties to a transaction from exercising all their rights and obligations under the transaction documents. This document cannot be reproduced except in full, without prior written approval of the Company. Any unauthorized alteration, forgery or falsification of the content or appearance of this document is unlawful and offenders may be prosecuted to the fullest extent of the law. Unless otherwise stated the results shown in this test report refer only to the sample(s) tested and such sample(s) are retained for 30 days only.
Attention: To check the authenticity of testing /inspection report & certificate, please contact us at telephone: (86-755) 8307 1443, or email: CN_Doccheck@sgs.com

No.10, Weiye Road, Innovation Park, Kunshan, Jiangsu, China 215300
中国·江苏·昆山市留学生创业园伟业路10号 邮编 215300

t(86-512)57355888 f(86-512)57370818 www.sgs.com.cn
t(86-512)57355888 f(86-512)57370818 sgs.china@sgs.com

7 Radio Spectrum Matter Test Results

7.1 20dB Bandwidth

Test Requirement 47 CFR Part 15, Subpart C 15.215

Test Method: ANSI C63.10 (2013) Section 6.9.2

Limit:

For report reference only

7.1.1 E.U.T. Operation

Operating Environment:

Temperature: 23.8 °C

Humidity: 57.1 % RH

Atmospheric Pressure: 1010 mbar

7.1.2 Test Mode Description

Pre-scan / Final test	Mode Code	Description
Final test	04	Tx mode_ Keep module a 125KHz working continuously
Final test	05	Tx mode_ Keep module b 125KHz working continuously

7.1.3 Test Setup Diagram

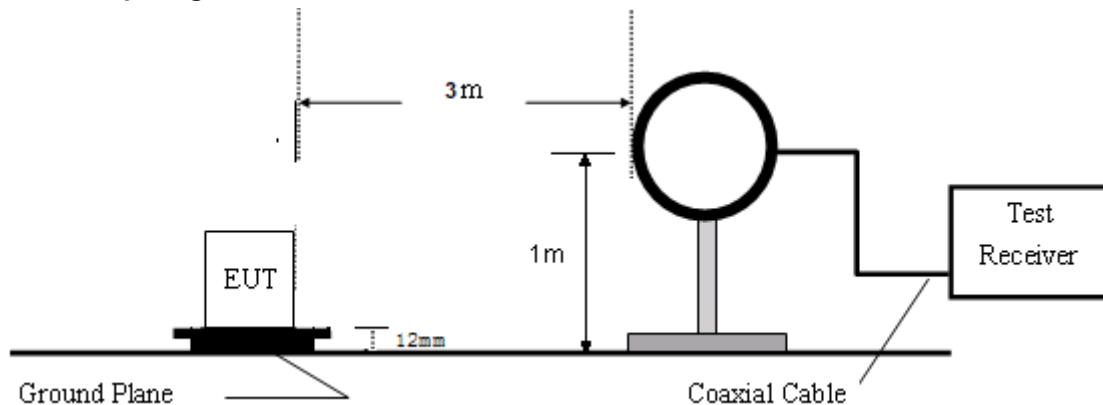

7.1.4 Measurement Procedure and Data

Please Refer to Appendix for Details



Unless otherwise agreed in writing, this document is issued by the Company subject to its General Conditions of Service printed overleaf, available on request or accessible at <http://www.sgs.com/en/Terms-and-Conditions.aspx> and, for electronic format documents, subject to Terms and Conditions for Electronic Documents at <http://www.sgs.com/en/Terms-and-Conditions/Terms-e-Documents.aspx>. Attention is drawn to the limitation of liability, indemnification and jurisdiction issues defined therein. Any holder of this document is advised that information contained hereon reflects the Company's findings at the time of its intervention only and within the limits of Client's instructions, if any. The Company's sole responsibility is to its Client and this document does not exonerate parties to a transaction from exercising all their rights and obligations under the transaction documents. This document cannot be reproduced except in full, without prior written approval of the Company. Any unauthorized alteration, forgery or falsification of the content or appearance of this document is unlawful and offenders may be prosecuted to the fullest extent of the law. Unless otherwise stated the results shown in this test report refer only to the sample(s) tested and such sample(s) are retained for 30 days only.
Attention: To check the authenticity of testing / inspection report & certificate, please contact us at telephone: (86-755) 8307 1443, or email: CN.Doccheck@sgs.com

No.10, Weiye Road, Innovation Park, Kunshan, Jiangsu, China 215300

中国·江苏·昆山市留学生创业园伟业路10号 邮编 215300

t(86-512)57355888 f(86-512)57370818 www.sgs.com.cn

t(86-512)57355888 f(86-512)57370818 sgs.china@sgs.com

7.2 Radiated Emissions (9kHz-30MHz)

Test Requirement 47 CFR Part 15, Subpart C 15.205 & 15.209

Test Method: ANSI C63.10 (2013) Section 6.4

Limit:

Frequency(MHz)	Field strength(microvolts/meter)	Measurement distance(meters)
0.009-0.490	2400/F(kHz)	300
0.490-1.705	24000/F(kHz)	30
1.705-30.0	30	30

Remark: The emission limits shown in the above table are based on measurements employing a CISPR quasi-peak detector except for the frequency bands 9-90kHz, 110-490kHz. Radiated emission limits in these three bands are based on measurements employing an average detector, the peak field strength of any emission shall not exceed the maximum permitted average limits specified above by more than 20 dB under any condition of modulation.

If field strength is measured at only a single point, then that point shall be at the radial from the EUT that produces the maximum emission at the frequency being measured, as described in 5.4. If that point is closer to the EUT than $\lambda/2\pi$ and the limit distance is greater than $\lambda/2\pi$, the measurement shall be extrapolated to the limit distance by conservatively presuming that the field strength decreases at a 40 dB/decade of distance rate to the $\lambda/2\pi$ distance, and at a 20 dB/decade of distance rate beyond $\lambda/2\pi$. This shall be accomplished using Equation (2):

$$FS_{(10m)} = FS_{(30/300m)} + 40\log\{d_{(near\ field)}/d_{(10m)}\} + 20\log\{d_{(30/300m)}/d_{(near\ field)}\} \quad (2)$$

If the single point measured is at a distance greater than $\lambda/2\pi$, then extrapolation to the limit distance shall be calculated using Equation (3):

$$FS_{(10m)} = FS_{(30/300m)} + 20\log\{d_{(30/300m)}/d_{(10m)}\} \quad (3)$$

If both the single point and the limit distance are equal to or closer to the EUT than $\lambda/2\pi$, then extrapolation to the limit distance shall be calculated using Equation (4):

$$FS_{(10m)} = FS_{(30/300m)} + 40\log\{d_{(30/300m)}/d_{(10m)}\} \quad (4)$$

Remark:

$$d_{near\ field} = 47.77 / f_{MHz}$$

where f_{MHz} is the frequency of the emission being measured in MHz.

7.2.1 E.U.T. Operation

Operating Environment:



Unless otherwise agreed in writing, this document is issued by the Company subject to its General Conditions of Service printed overleaf, available on request or accessible at <http://www.sgs.com/en/Terms-and-Conditions.aspx> and, for electronic format documents, subject to Terms and Conditions for Electronic Documents at <http://www.sgs.com/en/Terms-and-Conditions/Terms-e-Documents.aspx>. Attention is drawn to the limitation of liability, indemnification and jurisdiction issues defined therein. Any holder of this document is advised that information contained hereon reflects the Company's findings at the time of its intervention only and within the limits of Client's instructions, if any. The Company's sole responsibility is to its Client and this document does not exonerate parties to a transaction from exercising all their rights and obligations under the transaction documents. This document cannot be reproduced except in full, without prior written approval of the Company. Any unauthorized alteration, forgery or falsification of the content or appearance of this document is unlawful and offenders may be prosecuted to the fullest extent of the law. Unless otherwise stated the results shown in this test report refer only to the sample(s) tested and such sample(s) are retained for 30 days only.
Attention: To check the authenticity of testing /inspection report & certificate, please contact us at telephone: (86-755) 8307 1443, or email: CN.Doccheck@sgs.com

No.10, Weiye Road, Innovation Park, Kunshan, Jiangsu, China 215300
 中国·江苏·昆山市留学生创业园伟业路10号 邮编 215300

t(86-512)57355888 f(86-512)57370818 www.sgsgroup.com.cn
 t(86-512)57355888 f(86-512)57370818 sgs.china@sgs.com

Temperature: 23.8 °C Humidity: 57.1 % RH Atmospheric Pressure: 1010 mbar

7.2.2 Test Mode Description

Pre-scan / Final test	Mode Code	Description
Final test	04	Tx mode_ Keep module a 125KHz working continuously
Final test	05	Tx mode_ Keep module b 125KHz working continuously

7.2.3 Test Setup Diagram

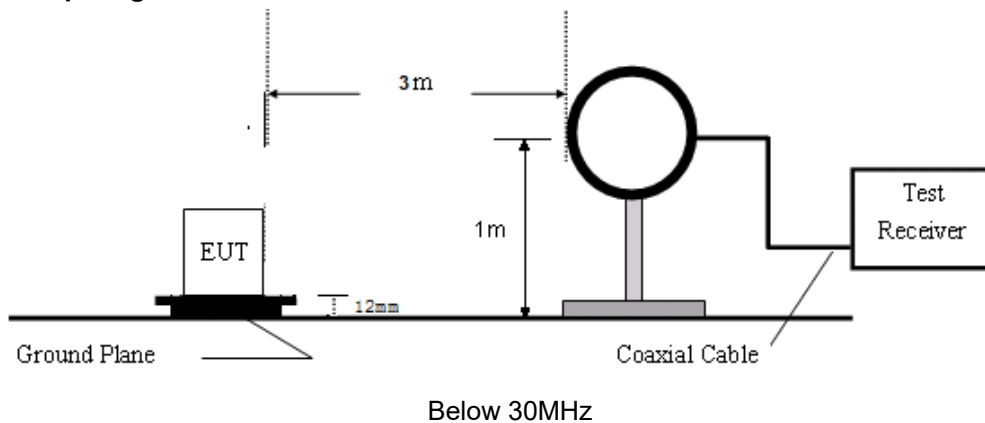

7.2.4 Measurement Procedure and Data

- a. All radiated emission measurements in terms of magnetic field strength shall be performed with a shielded loop antenna.
- b. For all radiated emission measurements in terms of magnetic field strength, the loop antenna were placed such that:
 - i. its centre shall be at 1.3 m height above the ground plane;
 - ii. the projection of its centre onto the ground plane shall be at the specified measurement distance from the projection on the ground plane of the closest point on the boundary of the equipment under test (EUT); and
 - iii. measurements shall be performed with the loop antenna placed vertically, in turn, in two polarizations (the measurement axis specified below is the line segment connecting the projections on the ground plane of the centre of the loop antenna and the centre of the EUT arrangement):
 - coaxial (loop plane perpendicular to the ground plane and to the measurement axis); and
 - coplanar (loop plane perpendicular to the ground plane and coplanar with the measurement axis).

Please Refer to Appendix for Details



Unless otherwise agreed in writing, this document is issued by the Company subject to its General Conditions of Service printed overleaf, available on request or accessible at <http://www.sgs.com/en/Terms-and-Conditions.aspx> and, for electronic format documents, subject to Terms and Conditions for Electronic Documents at <http://www.sgs.com/en/Terms-and-Conditions/Terms-e-Documents.aspx>. Attention is drawn to the limitation of liability, indemnification and jurisdiction issues defined therein. Any holder of this document is advised that information contained hereon reflects the Company's findings at the time of its intervention only and within the limits of Client's instructions, if any. The Company's sole responsibility is to its Client and this document does not exonerate parties to a transaction from exercising all their rights and obligations under the transaction documents. This document cannot be reproduced except in full, without prior written approval of the Company. Any unauthorized alteration, forgery or falsification of the content or appearance of this document is unlawful and offenders may be prosecuted to the fullest extent of the law. Unless otherwise stated the results shown in this test report refer only to the sample(s) tested and such sample(s) are retained for 30 days only.
Attention: To check the authenticity of testing / inspection report & certificate, please contact us at telephone: (86-755) 8307 1443, or email: CN.Doccheck@sgs.com

No.10, Weiye Road, Innovation Park, Kunshan, Jiangsu, China 215300
中国·江苏·昆山市留学生创业园伟业路10号 邮编 215300

t(86-512)57355888 f(86-512)57370818 www.sgsgroup.com.cn
t(86-512)57355888 f(86-512)57370818 sgs.china@sgs.com

7.3 Radiated Emissions (30MHz-1GHz)

Test Requirement 47 CFR Part 15, Subpart C 15.205 & 15.209

Test Method: ANSI C63.10 (2013) Section 6.5

Limit:

Frequency(MHz)	Field strength(microvolts/meter)	Measurement distance(meters)
30-88	100	3
88-216	150	3
216-960	200	3
Above 960	500	3

Remark: The emission limits shown in the above table are based on measurements employing a CISPR quasi-peak detector.

7.3.1 E.U.T. Operation

Operating Environment:

Temperature: 23.8 °C Humidity: 57.0 % RH Atmospheric Pressure: 1010 mbar

7.3.2 Test Mode Description

Pre-scan / Final test	Mode Code	Description
Final test	04	Tx mode_ Keep module a 125KHz working continuously
Final test	05	Tx mode_ Keep module b 125KHz working continuously

7.3.3 Test Setup Diagram

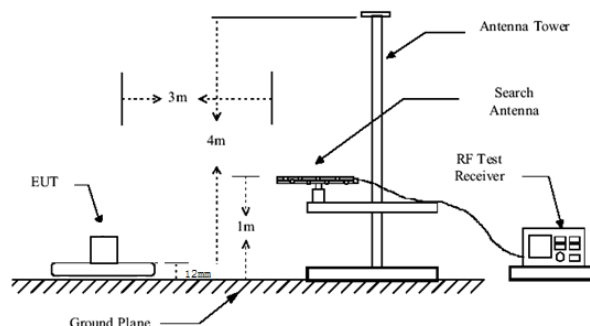

30MHz-1GHz



Unless otherwise agreed in writing, this document is issued by the Company subject to its General Conditions of Service printed overleaf, available on request or accessible at <http://www.sgs.com/en/Terms-and-Conditions.aspx> and, for electronic format documents, subject to Terms and Conditions for Electronic Documents at <http://www.sgs.com/en/Terms-and-Conditions/Terms-e-Documents.aspx>. Attention is drawn to the limitation of liability, indemnification and jurisdiction issues defined therein. Any holder of this document is advised that information contained hereon reflects the Company's findings at the time of its intervention only and within the limits of Client's instructions, if any. The Company's sole responsibility is to its Client and this document does not exonerate parties to a transaction from exercising all their rights and obligations under the transaction documents. This document cannot be reproduced except in full, without prior written approval of the Company. Any unauthorized alteration, forgery or falsification of the content or appearance of this document is unlawful and offenders may be prosecuted to the fullest extent of the law. Unless otherwise stated the results shown in this test report refer only to the sample(s) tested and such sample(s) are retained for 30 days only.

Attention: To check the authenticity of testing / inspection report & certificate, please contact us at telephone: (86-755) 8307 1443, or email: CN.Doccheck@sgs.com

No.10, Weiye Road, Innovation Park, Kunshan, Jiangsu, China 215300

t(86-512)57355888 f(86-512)57370818 www.sgs.com.cn

中国·江苏·昆山市留学院创业园伟业路10号 邮编 215300

t(86-512)57355888 f(86-512)57370818 sgs.china@sgs.com

7.3.4 Measurement Procedure and Data

- a. The EUT was placed on the top of a rotating table 12mm above the ground for below 1GHz at a 3 meter semi-anechoic chamber. The table was rotated 360 degrees to determine the position of the highest radiation.
- b. The EUT was set 3 meters away from the interference-receiving antenna, which was mounted on the top of a variable-height antenna tower.
- c. The antenna height is varied from one meter to four meters above the ground to determine the maximum value of the field strength. Both horizontal and vertical polarizations of the antenna are set to make the measurement.
- d. For each suspected emission, the EUT was arranged to its worst case and then the antenna was tuned to heights from 1 meter to 4 meters (for the test frequency of below 30MHz, the antenna was tuned to heights 1 meter) and the rotatable table was turned from 0 degrees to 360 degrees to find the maximum reading.
- e. The test-receiver system was set to Peak Detect Function and Specified Bandwidth with Maximum Hold Mode.
- f. If the emission level of the EUT in peak mode was 10dB lower than the limit specified, then testing could be stopped and the peak values of the EUT would be reported. Otherwise the emissions that did not have 10dB margin would be re-tested one by one using peak, quasi-peak or average method as specified and then reported in a data sheet.
- g. The radiation measurements are performed in X, Y, Z axis positioning. And found the X axis positioning which it is worse case, only the test worst case mode is recorded in the report.

Remark: Level= Read Level+ Cable Loss+ Antenna Factor- Preamp Factor

Please Refer to Appendix for Details



Unless otherwise agreed in writing, this document is issued by the Company subject to its General Conditions of Service printed overleaf, available on request or accessible at <http://www.sgs.com/en/Terms-and-Conditions.aspx> and, for electronic format documents, subject to Terms and Conditions for Electronic Documents at <http://www.sgs.com/en/Terms-and-Conditions/Terms-e-Documents.aspx>. Attention is drawn to the limitation of liability, indemnification and jurisdiction issues defined therein. Any holder of this document is advised that information contained hereon reflects the Company's findings at the time of its intervention only and within the limits of Client's instructions, if any. The Company's sole responsibility is to its Client and this document does not exonerate parties to a transaction from exercising all their rights and obligations under the transaction documents. This document cannot be reproduced except in full, without prior written approval of the Company. Any unauthorized alteration, forgery or falsification of the content or appearance of this document is unlawful and offenders may be prosecuted to the fullest extent of the law. Unless otherwise stated the results shown in this test report refer only to the sample(s) tested and such sample(s) are retained for 30 days only.
Attention: To check the authenticity of testing /inspection report & certificate, please contact us at telephone: (86-755) 8307 1443, or email: CN_Doccheck@sgs.com

No.10, Weiye Road, Innovation Park, Kunshan, Jiangsu, China 215300
中国·江苏·昆山市留学生创业园伟业路10号 邮编 215300

t(86-512)57355888 f(86-512)57370818 www.sgs.com.cn
t(86-512)57355888 f(86-512)57370818 sgs.china@sgs.com

7.4 Conducted Emissions at AC Mains Power Port (150kHz-30MHz)

Test Requirement 47 CFR Part 15, Subpart C 15.207

Test Method: ANSI C63.10 (2013) Section 6.2

Limit:

Frequency of emission(MHz)	Conducted limit(dBµV)	
	Quasi-peak	Average
0.15-0.5	66 to 56*	56 to 46*
0.5-5	56	46
5-30	60	50

*Decreases with the logarithm of the frequency.

7.4.1 E.U.T. Operation

Operating Environment:

Temperature: 23.8 °C Humidity: 56.9 % RH Atmospheric Pressure: 1010 mbar

7.4.2 Test Mode Description

Pre-scan / Final test	Mode Code	Description
Final test	04	Tx mode_ Keep module a 125KHz working continuously
Final test	05	Tx mode_ Keep module b 125KHz working continuously



Unless otherwise agreed in writing, this document is issued by the Company subject to its General Conditions of Service printed overleaf, available on request or accessible at <http://www.sgs.com/en/Terms-and-Conditions.aspx> and, for electronic format documents, subject to Terms and Conditions for Electronic Documents at <http://www.sgs.com/en/Terms-and-Conditions/Terms-e-Document.aspx>. Attention is drawn to the limitation of liability, indemnification and jurisdiction issues defined therein. Any holder of this document is advised that information contained hereon reflects the Company's findings at the time of its intervention only and within the limits of Client's instructions, if any. The Company's sole responsibility is to its Client and this document does not exonerate parties to a transaction from exercising all their rights and obligations under the transaction documents. This document cannot be reproduced except in full, without prior written approval of the Company. Any unauthorized alteration, forgery or falsification of the content or appearance of this document is unlawful and offenders may be prosecuted to the fullest extent of the law. Unless otherwise stated the results shown in this test report refer only to the sample(s) tested and such sample(s) are retained for 30 days only.
Attention: To check the authenticity of testing /inspection report & certificate, please contact us at telephone: (86-755) 8307 1443, or email: CN.Doccheck@sgs.com

No.10, Weiye Road, Innovation Park, Kunshan, Jiangsu, China 215300
 中国·江苏·昆山市留学生创业园伟业路10号 邮编 215300

t(86-512)57355888 f(86-512)57370818 www.sgsgroup.com.cn
 t(86-512)57355888 f(86-512)57370818 sgs.china@sgs.com

7.4.3 Test Setup Diagram

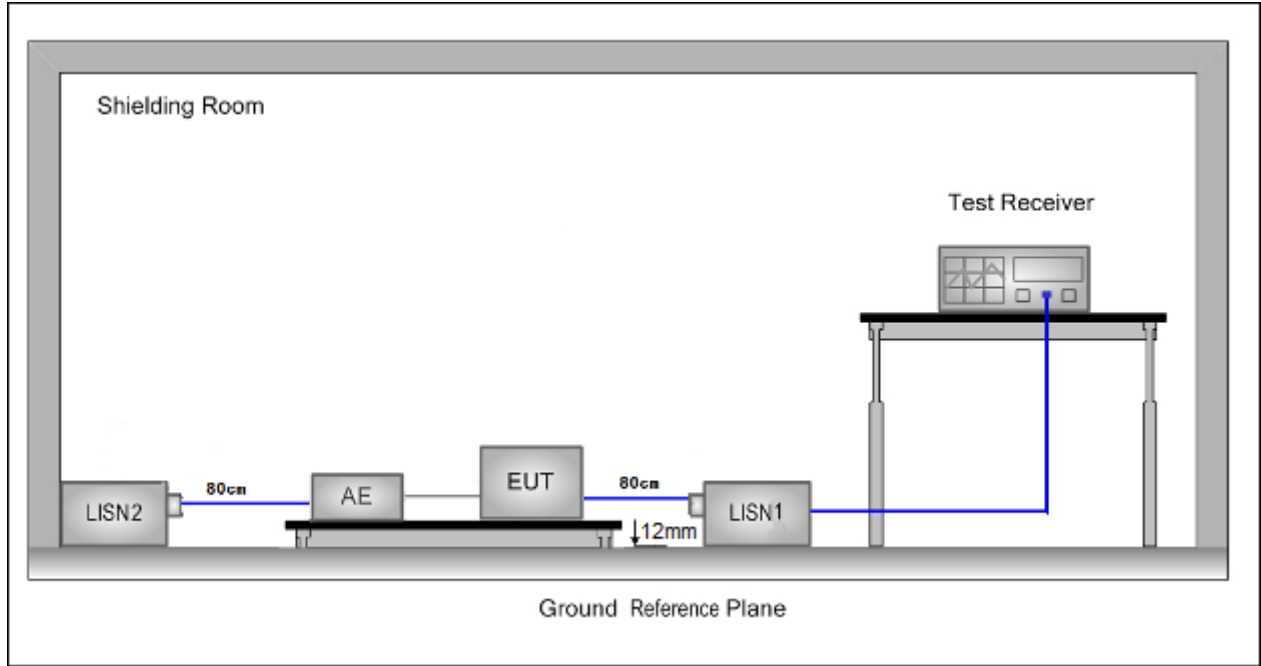

7.4.4 Measurement Procedure and Data

- 1) The mains terminal disturbance voltage test was conducted in a shielded room.
- 2) The EUT was connected to AC power source through a LISN 1 (Line Impedance Stabilization Network) which provides a 50ohm/50μH + 5ohm linear impedance. The power cables of all other units of the EUT were connected to a second LISN 2, which was bonded to the ground reference plane in the same way as the LISN 1 for the unit being measured. A multiple socket outlet strip was used to connect multiple power cables to a single LISN provided the rating of the LISN was not exceeded.
- 3) The tabletop EUT was placed upon a non-metallic mat 12mm above the ground reference plane. And for floor-standing arrangement, the EUT was placed on the horizontal ground reference plane,
- 4) The test was performed with a vertical ground reference plane. The rear of the EUT shall be 0.4 m from the vertical ground reference plane. The vertical ground reference plane was bonded to the horizontal ground reference plane. The LISN 1 was placed 0.8 m from the boundary of the unit under test and bonded to a ground reference plane for LISNs mounted on top of the ground reference plane. This distance was between the closest points of the LISN 1 and the EUT. All other units of the EUT and associated equipment was at least 0.8 m from the LISN 2.
- 5) In order to find the maximum emission, the relative positions of equipment and all of the interface cables must be changed according to ANSI C63.10 on conducted measurement.

Remark: Level=Read Level+ Cable Loss+ LISN Factor



Unless otherwise agreed in writing, this document is issued by the Company subject to its General Conditions of Service printed overleaf, available on request or accessible at <http://www.sgs.com/en/Terms-and-Conditions.aspx> and, for electronic format documents, subject to Terms and Conditions for Electronic Documents at <http://www.sgs.com/en/Terms-and-Conditions/Terms-e-Documents.aspx>. Attention is drawn to the limitation of liability, indemnification and jurisdiction issues defined therein. Any holder of this document is advised that information contained hereon reflects the Company's findings at the time of its intervention only and within the limits of Client's instructions, if any. The Company's sole responsibility is to its Client and this document does not exonerate parties to a transaction from exercising all their rights and obligations under the transaction documents. This document cannot be reproduced except in full, without prior written approval of the Company. Any unauthorized alteration, forgery or falsification of the content or appearance of this document is unlawful and offenders may be prosecuted to the fullest extent of the law. Unless otherwise stated the results shown in this test report refer only to the sample(s) tested and such sample(s) are retained for 30 days only.
Attention: To check the authenticity of testing /inspection report & certificate, please contact us at telephone: (86-755) 8307 1443, or email: CN.Doccheck@sgs.com

No.10, Weiye Road, Innovation Park, Kunshan, Jiangsu, China 215300
 中国·江苏·昆山市留学院创业园伟业路10号 邮编 215300

t(86-512)57355888 f(86-512)57370818 www.sgsgroup.com.cn
 t(86-512)57355888 f(86-512)57370818 sgs.china@sgs.com

Test Mode: 04; Line: Live line

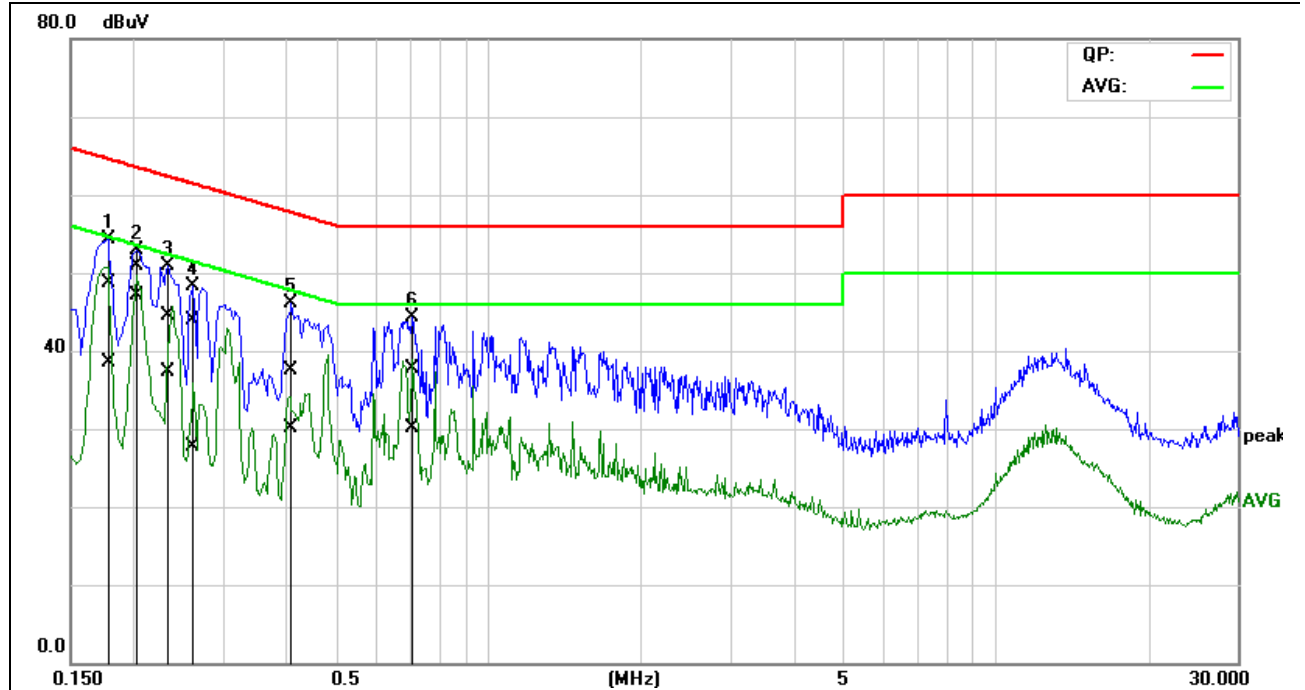

No.	Frequency (MHz)	QuasiPeak reading (dBuV)	Average reading (dBuV)	Correction factor (dB)	QuasiPeak result (dBuV)	Average result (dBuV)	QuasiPeak limit (dBuV)	Average limit (dBuV)	QuasiPeak margin (dB)	Average margin (dB)	Remark
1	0.1786	29.24	18.99	19.50	48.74	38.49	64.55	54.55	-15.81	-16.06	Pass
2*	0.2037	31.42	27.64	19.50	50.92	47.14	63.46	53.46	-12.54	-6.32	Pass
3	0.2332	25.01	17.77	19.50	44.51	37.27	62.33	52.33	-17.82	-15.06	Pass
4	0.2632	24.36	8.26	19.51	43.87	27.77	61.33	51.33	-17.46	-23.56	Pass
5	0.4076	17.97	10.55	19.54	37.51	30.09	57.70	47.70	-20.19	-17.61	Pass
6	0.7052	18.20	10.50	19.57	37.77	30.07	56.00	46.00	-18.23	-15.93	Pass



Unless otherwise agreed in writing, this document is issued by the Company subject to its General Conditions of Service printed overleaf, available on request or accessible at <http://www.sgs.com/en/Terms-and-Conditions.aspx> and, for electronic format documents, subject to Terms and Conditions for Electronic Documents at <http://www.sgs.com/en/Terms-and-Conditions/Terms-e-Documents.aspx>. Attention is drawn to the limitation of liability, indemnification and jurisdiction issues defined therein. Any holder of this document is advised that information contained hereon reflects the Company's findings at the time of its intervention only and within the limits of Client's instructions, if any. The Company's sole responsibility is to its Client and this document does not exonerate parties to a transaction from exercising all their rights and obligations under the transaction documents. This document cannot be reproduced except in full, without prior written approval of the Company. Any unauthorized alteration, forgery or falsification of the content or appearance of this document is unlawful and offenders may be prosecuted to the fullest extent of the law. Unless otherwise stated the results shown in this test report refer only to the sample(s) tested and such sample(s) are retained for 30 days only.
Attention: To check the authenticity of testing / inspection report & certificate, please contact us at telephone: (86-755) 8307 1443, or email: CN.Doccheck@sgs.com

No.10, Weiye Road, Innovation Park, Kunshan, Jiangsu, China 215300
 中国·江苏·昆山市留学院创业园伟业路10号 邮编 215300

t(86-512)57355888 f(86-512)57370818 www.sgsgroup.com.cn
 t(86-512)57355888 f(86-512)57370818 sgs.china@sgs.com

Test Mode: 04; Line: Neutral Line

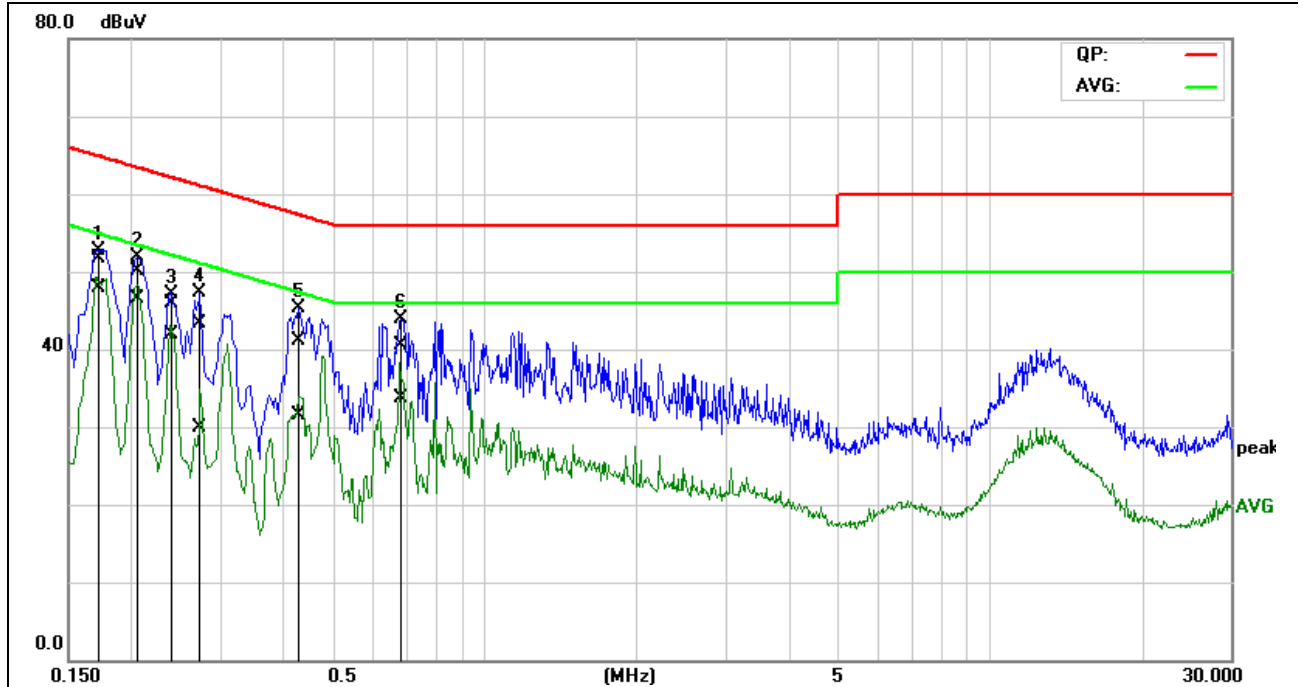

No.	Frequency (MHz)	QuasiPeak reading (dBuV)	Average reading (dBuV)	Correction factor (dB)	QuasiPeak result (dBuV)	Average result (dBuV)	QuasiPeak limit (dBuV)	Average limit (dBuV)	QuasiPeak margin (dB)	Average margin (dB)	Remark
1	0.1699	32.21	28.43	19.48	51.69	47.91	64.97	54.97	-13.28	-7.06	Pass
2*	0.2043	30.70	27.02	19.49	50.19	46.51	63.43	53.43	-13.24	-6.92	Pass
3	0.2403	26.36	22.50	19.49	45.85	41.99	62.09	52.09	-16.24	-10.10	Pass
4	0.2735	23.80	10.40	19.50	43.30	29.90	61.01	51.01	-17.71	-21.11	Pass
5	0.4286	21.64	12.04	19.54	41.18	31.58	57.28	47.28	-16.10	-15.70	Pass
6	0.6900	20.96	14.12	19.56	40.52	33.68	56.00	46.00	-15.48	-12.32	Pass



Unless otherwise agreed in writing, this document is issued by the Company subject to its General Conditions of Service printed overleaf, available on request or accessible at <http://www.sgs.com/en/Terms-and-Conditions.aspx> and, for electronic format documents, subject to Terms and Conditions for Electronic Documents at <http://www.sgs.com/en/Terms-and-Conditions/Terms-e-Documents.aspx>. Attention is drawn to the limitation of liability, indemnification and jurisdiction issues defined therein. Any holder of this document is advised that information contained hereon reflects the Company's findings at the time of its intervention only and within the limits of Client's instructions, if any. The Company's sole responsibility is to its Client and this document does not exonerate parties to a transaction from exercising all their rights and obligations under the transaction documents. This document cannot be reproduced except in full, without prior written approval of the Company. Any unauthorized alteration, forgery or falsification of the content or appearance of this document is unlawful and offenders may be prosecuted to the fullest extent of the law. Unless otherwise stated the results shown in this test report refer only to the sample(s) tested and such sample(s) are retained for 30 days only.
Attention: To check the authenticity of testing /inspection report & certificate, please contact us at telephone: (86-755) 8307 1443, or email: CN.Doccheck@sgs.com

No.10, Weiye Road, Innovation Park, Kunshan, Jiangsu, China 215300
中国·江苏·昆山市留学生创业园伟业路10号 邮编 215300

t(86-512)57355888 f(86-512)57370818 www.sgsgroup.com.cn
t(86-512)57355888 f(86-512)57370818 sgs.china@sgs.com

8 Test Setup Photo

Refer to Appendix - Test Setup Photo for KSCR2210001874AT

9 EUT Constructional Details (EUT Photos)

Refer to Appendix - Photographs of EUT Constructional Details for KSCR2210001874AT



Unless otherwise agreed in writing, this document is issued by the Company subject to its General Conditions of Service printed overleaf, available on request or accessible at <http://www.sgs.com/en/Terms-and-Conditions.aspx> and, for electronic format documents, subject to Terms and Conditions for Electronic Documents at <http://www.sgs.com/en/Terms-and-Conditions/Terms-e-Documents.aspx>. Attention is drawn to the limitation of liability, indemnification and jurisdiction issues defined therein. Any holder of this document is advised that information contained hereon reflects the Company's findings at the time of its intervention only and within the limits of Client's instructions, if any. The Company's sole responsibility is to its Client and this document does not exonerate parties to a transaction from exercising all their rights and obligations under the transaction documents. This document cannot be reproduced except in full, without prior written approval of the Company. Any unauthorized alteration, forgery or falsification of the content or appearance of this document is unlawful and offenders may be prosecuted to the fullest extent of the law. Unless otherwise stated the results shown in this test report refer only to the sample(s) tested and such sample(s) are retained for 30 days only.
Attention: To check the authenticity of testing /inspection report & certificate, please contact us at telephone: (86-755) 8307 1443, or email: CN.Doccheck@sgs.com

10 Appendix

1. 20dB Bandwidth

	20dB bandwidth (Hz)	Result
Module a	654.1	Pass
Module b	555.7	Pass

Test plot as follows:

Module a:

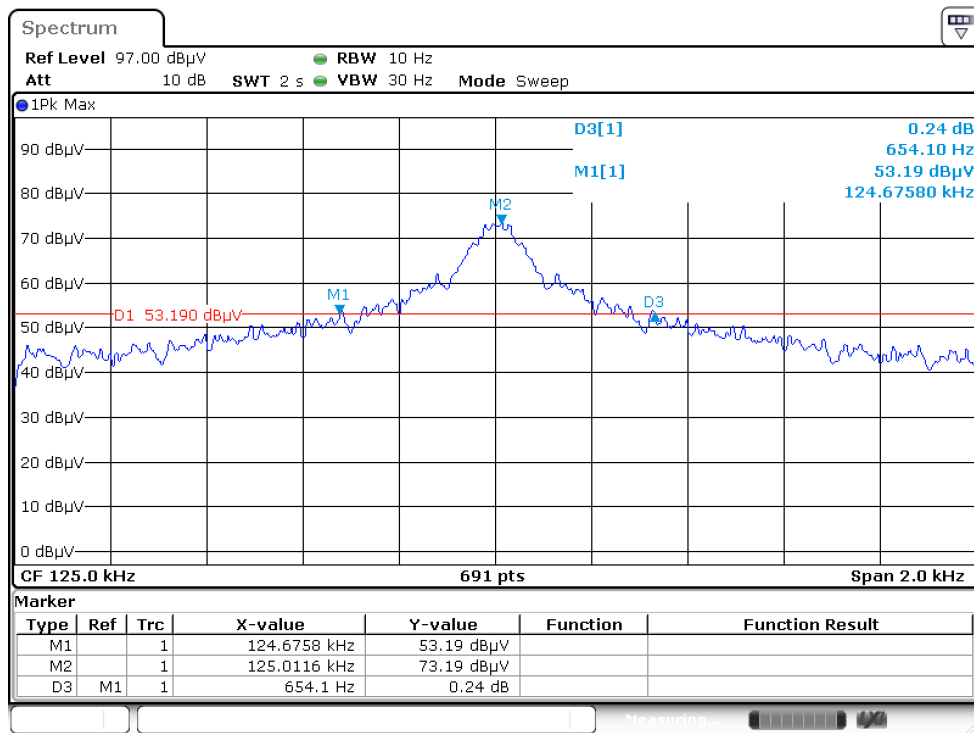

Unless otherwise agreed in writing, this document is issued by the Company subject to its General Conditions of Service printed overleaf, available on request or accessible at <http://www.sgs.com/en/Terms-and-Conditions.aspx> and, for electronic format documents, subject to Terms and Conditions for Electronic Documents at <http://www.sgs.com/en/Terms-and-Conditions/Terms-e-Documents.aspx>. Attention is drawn to the limitation of liability, indemnification and jurisdiction issues defined therein. Any holder of this document is advised that information contained hereon reflects the Company's findings at the time of its intervention only and within the limits of Client's instructions, if any. The Company's sole responsibility is to its Client and this document does not exonerate parties to a transaction from exercising all their rights and obligations under the transaction documents. This document cannot be reproduced except in full, without prior written approval of the Company. Any unauthorized alteration, forgery or falsification of the content or appearance of this document is unlawful and offenders may be prosecuted to the fullest extent of the law. Unless otherwise stated the results shown in this test report refer only to the sample(s) tested and such sample(s) are retained for 30 days only.

Attention: To check the authenticity of testing /inspection report & certificate, please contact us at telephone: (86-755) 8307 1443, or email: CN.Doccheck@sgs.com

No.10, Weiye Road, Innovation Park, Kunshan, Jiangsu, China 215300
中国·江苏·昆山市留学生创业园伟业路10号 邮编 215300

t(86-512)57355888 f(86-512)57370818 www.sgsgroup.com.cn
t(86-512)57355888 f(86-512)57370818 sgs.china@sgs.com

Module b:

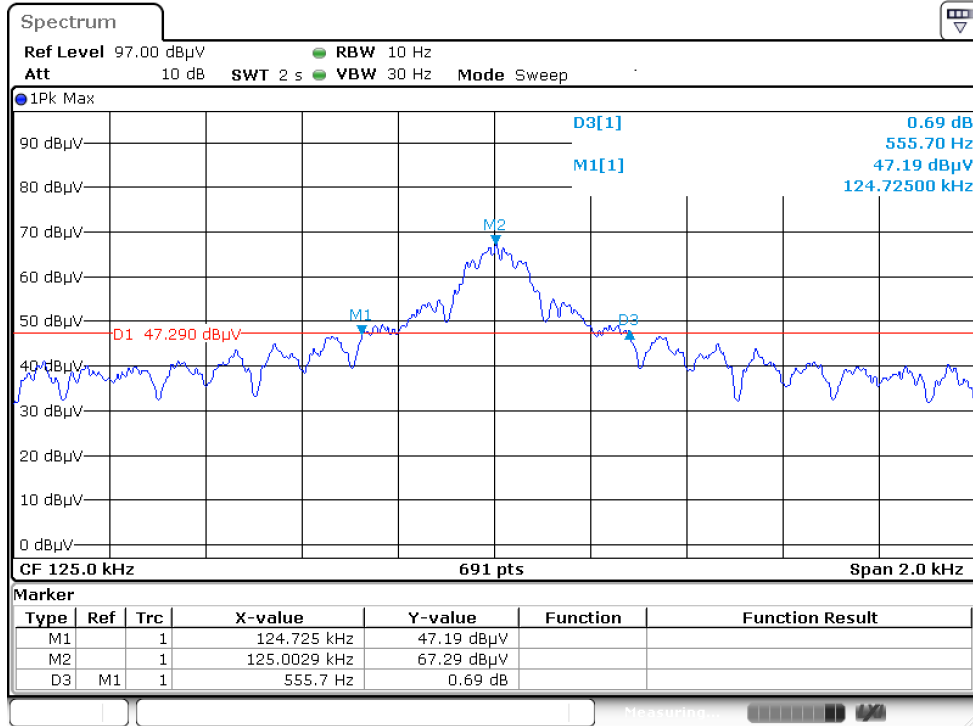

Unless otherwise agreed in writing, this document is issued by the Company subject to its General Conditions of Service printed overleaf, available on request or accessible at <http://www.sgs.com/en/Terms-and-Conditions.aspx> and, for electronic format documents, subject to Terms and Conditions for Electronic Documents at <http://www.sgs.com/en/Terms-and-Conditions/Terms-e-Documents.aspx>. Attention is drawn to the limitation of liability, indemnification and jurisdiction issues defined therein. Any holder of this document is advised that information contained hereon reflects the Company's findings at the time of its intervention only and within the limits of Client's instructions, if any. The Company's sole responsibility is to its Client and this document does not exonerate parties to a transaction from exercising all their rights and obligations under the transaction documents. This document cannot be reproduced except in full, without prior written approval of the Company. Any unauthorized alteration, forgery or falsification of the content or appearance of this document is unlawful and offenders may be prosecuted to the fullest extent of the law. Unless otherwise stated the results shown in this test report refer only to the sample(s) tested and such sample(s) are retained for 30 days only.
Attention: To check the authenticity of testing / inspection report & certificate, please contact us at telephone: (86-755) 8307 1443, or email: CN.Doccheck@sgs.com

Compliance Certification Services (Kunshan) Inc.
 EMC Laboratory

No.10, Weiye Road, Innovation Park, Kunshan, Jiangsu, China 215300
 中国·江苏·昆山市留学生创业园伟业路10号 邮编 215300

t(86-512)57355888 f(86-512)57370818 www.sgsgroup.com.cn
 t(86-512)57355888 f(86-512)57370818 sgs.china@sgs.com

2. Radiated Emissions(9kHz-30MHz)

Module a:

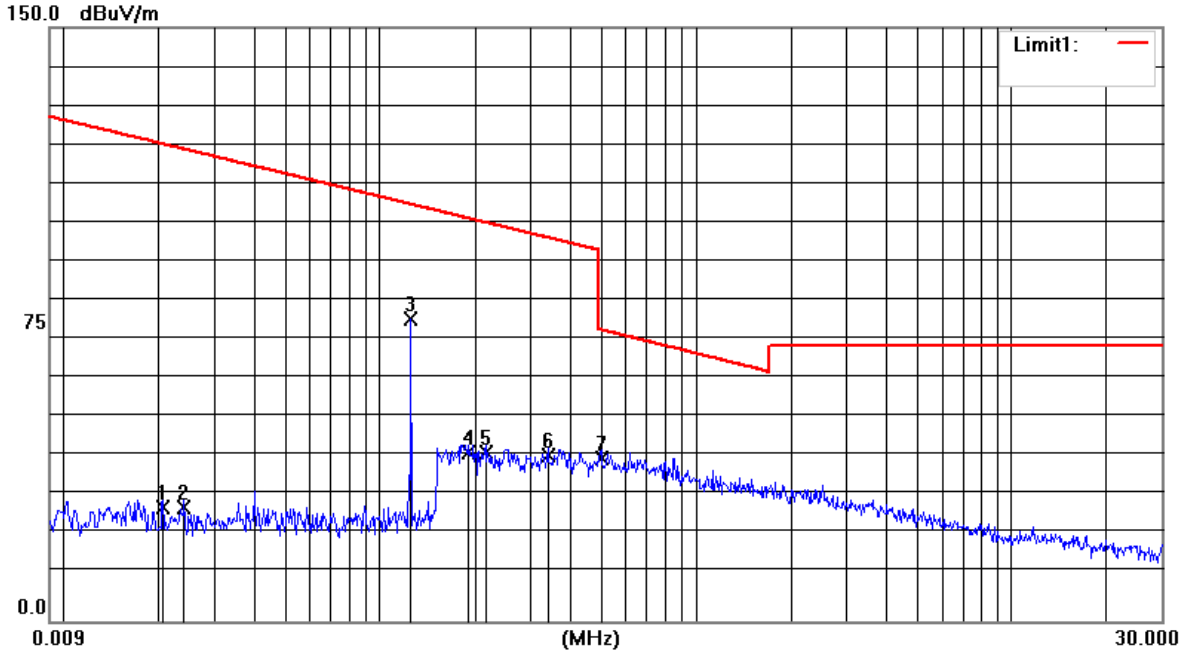

Item	Freq.	Read Level	Correct Factor	Result Level@3 m	Result Level@S PEC	Limit Line@SP EC	Over Limit	Detector	Polarity
(Mark)	(MHz)	(dBμV)	(dB/m)	(dBuV/m)	(dBuV/m)	(dBuV/m)	(dB)		
1	0.0205	12.71	15.88	28.59	-51.41	40.57	-91.98	QP	Coaxial
2	0.0240	12.78	15.84	28.62	-51.38	39.24	-90.62	QP	Coaxial
3	0.1252	61.75	14.72	76.47	-3.53	25.31	-28.84	Peak	Coaxial
4	0.1904	28.16	14.45	42.61	-37.39	21.77	-59.16	QP	Coaxial
5	0.2151	28.05	14.44	42.49	-37.51	20.74	-58.25	QP	Coaxial
6	0.3392	27.42	14.43	41.85	-38.15	16.90	-55.05	QP	Coaxial
7	0.4994	26.74	14.41	41.15	1.15	33.64	-32.49	QP	Coaxial



Unless otherwise agreed in writing, this document is issued by the Company subject to its General Conditions of Service printed overleaf, available on request or accessible at <http://www.sgs.com/en/Terms-and-Conditions.aspx> and, for electronic format documents, subject to Terms and Conditions for Electronic Documents at <http://www.sgs.com/en/Terms-and-Conditions/Terms-e-Documents.aspx>. Attention is drawn to the limitation of liability, indemnification and jurisdiction issues defined therein. Any holder of this document is advised that information contained hereon reflects the Company's findings at the time of its intervention only and within the limits of Client's instructions, if any. The Company's sole responsibility is to its Client and this document does not exonerate parties to a transaction from exercising all their rights and obligations under the transaction documents. This document cannot be reproduced except in full, without prior written approval of the Company. Any unauthorized alteration, forgery or falsification of the content or appearance of this document is unlawful and offenders may be prosecuted to the fullest extent of the law. Unless otherwise stated the results shown in this test report refer only to the sample(s) tested and such sample(s) are retained for 30 days only.
Attention: To check the authenticity of testing / inspection report & certificate, please contact us at telephone: (86-755) 8307 1443, or email: CN.Doccheck@sgs.com

No.10, Weiye Road, Innovation Park, Kunshan, Jiangsu, China 215300 t(86-512)57355888 f(86-512)57370818 www.sgsgroup.com.cn
 中国·江苏·昆山市留学院创业园伟业路10号 邮编 215300 t(86-512)57355888 f(86-512)57370818 sgs.china@sgs.com

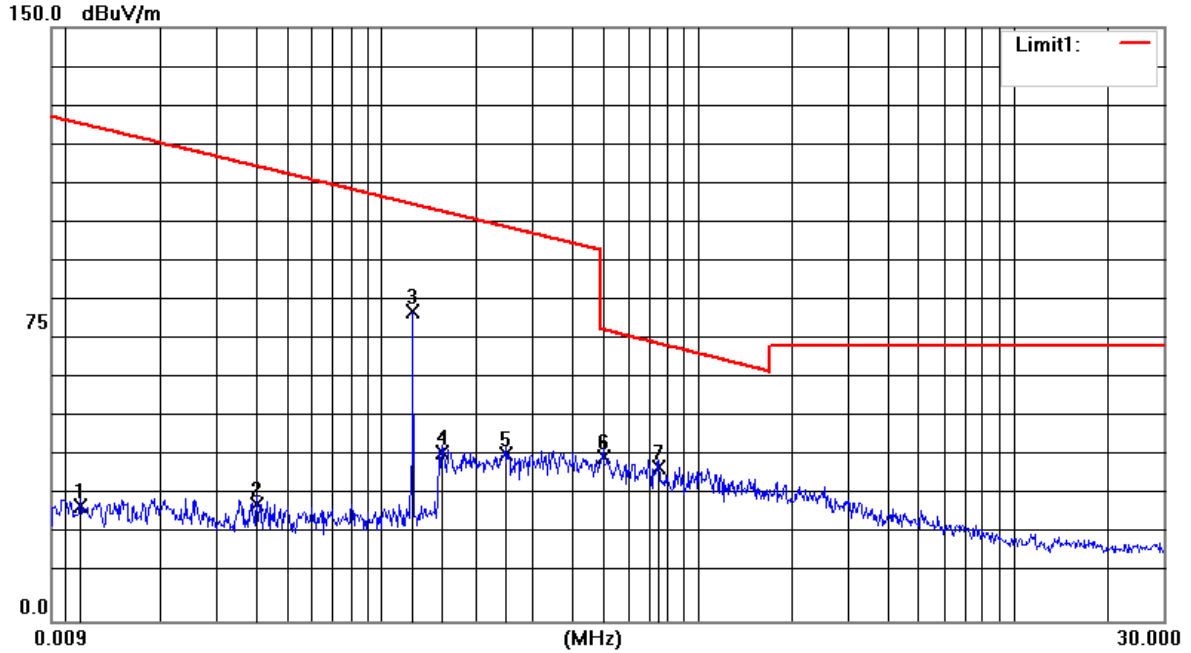

Item	Freq.	Read Level	Correct Factor	Result Level@3m	Result Level@S PEC	Limit Line@SP EC	Over Limit	Detector	Polarity
(Mark)	(MHz)	(dBμV)	(dB/m)	(dBuV/m)	(dBuV/m)	(dBuV/m)	(dB)		
1	0.0111	12.90	15.99	28.89	-51.11	45.74	-96.85	QP	Coplanar
2	0.0400	13.91	15.67	29.58	-50.42	34.93	-85.35	QP	Coplanar
3	0.1252	63.34	14.72	78.06	-1.94	25.31	-27.25	Peak	Coplanar
4	0.1547	27.94	14.45	42.39	-37.61	23.52	-61.13	QP	Coplanar
5	0.2454	27.66	14.44	42.10	-37.90	19.63	-57.53	QP	Coplanar
6	0.4994	27.10	14.41	41.51	1.51	33.64	-32.13	QP	Coplanar
7	0.7510	24.30	14.38	38.68	-1.32	30.10	-31.42	QP	Coplanar



Unless otherwise agreed in writing, this document is issued by the Company subject to its General Conditions of Service printed overleaf, available on request or accessible at <http://www.sgs.com/en/Terms-and-Conditions.aspx> and, for electronic format documents, subject to Terms and Conditions for Electronic Documents at <http://www.sgs.com/en/Terms-and-Conditions/Terms-e-Documents.aspx>. Attention is drawn to the limitation of liability, indemnification and jurisdiction issues defined therein. Any holder of this document is advised that information contained hereon reflects the Company's findings at the time of its intervention only and within the limits of Client's instructions, if any. The Company's sole responsibility is to its Client and this document does not exonerate parties to a transaction from exercising all their rights and obligations under the transaction documents. This document cannot be reproduced except in full, without prior written approval of the Company. Any unauthorized alteration, forgery or falsification of the content or appearance of this document is unlawful and offenders may be prosecuted to the fullest extent of the law. Unless otherwise stated the results shown in this test report refer only to the sample(s) tested and such sample(s) are retained for 30 days only.
Attention: To check the authenticity of testing /inspection report & certificate, please contact us at telephone: (86-755) 8307 1443, or email: CN.Doccheck@sgs.com

No.10, Weiye Road, Innovation Park, Kunshan, Jiangsu, China 215300 t(86-512)57355888 f(86-512)57370818 www.sgsgroup.com.cn
 中国·江苏·昆山市留学生创业园伟业路10号 邮编 215300 t(86-512)57355888 f(86-512)57370818 sgs.china@sgs.com

Module b:

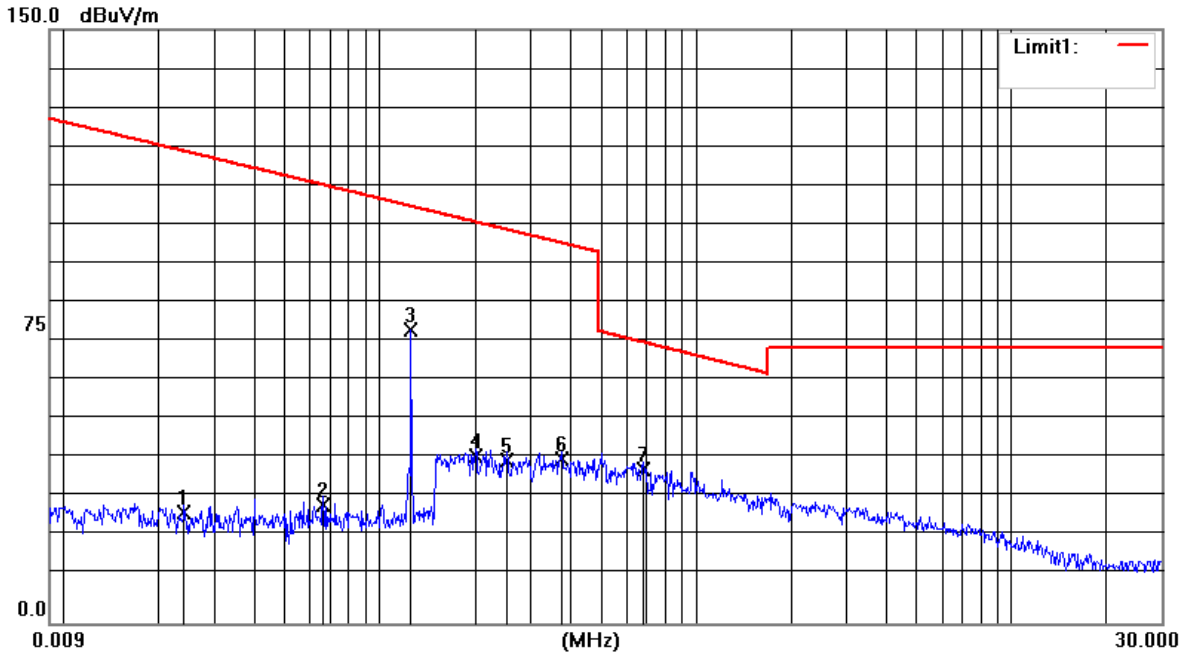

Item	Freq.	Read Level	Correct Factor	Result Level@3 m	Result Level@S PEC	Limit Line@SP EC	Over Limit	Detector	Polarity
(Mark)	(MHz)	(dBμV)	(dB/m)	(dBuV/m)	(dBuV/m)	(dBuV/m)	(dB)		
1	0.0240	12.04	15.84	27.88	-52.12	39.24	-91.36	QP	Coaxial
2	0.0661	14.60	15.38	29.98	-50.02	30.69	-80.71	QP	Coaxial
3	0.1252	59.25	14.72	73.97	-6.03	25.31	-31.34	Peak	Coaxial
4	0.1995	27.77	14.44	42.21	-37.79	21.38	-59.17	QP	Coaxial
5	0.2520	26.71	14.44	41.15	-38.85	19.41	-58.26	QP	Coaxial
6	0.3730	26.85	14.43	41.28	-38.72	16.10	-54.82	QP	Coaxial
7	0.6824	24.36	14.39	38.75	-1.25	30.93	-32.18	QP	Coaxial



Unless otherwise agreed in writing, this document is issued by the Company subject to its General Conditions of Service printed overleaf, available on request or accessible at <http://www.sgs.com/en/Terms-and-Conditions.aspx> and, for electronic format documents, subject to Terms and Conditions for Electronic Documents at <http://www.sgs.com/en/Terms-and-Conditions/Terms-e-Documents.aspx>. Attention is drawn to the limitation of liability, indemnification and jurisdiction issues defined therein. Any holder of this document is advised that information contained hereon reflects the Company's findings at the time of its intervention only and within the limits of Client's instructions, if any. The Company's sole responsibility is to its Client and this document does not exonerate parties to a transaction from exercising all their rights and obligations under the transaction documents. This document cannot be reproduced except in full, without prior written approval of the Company. Any unauthorized alteration, forgery or falsification of the content or appearance of this document is unlawful and offenders may be prosecuted to the fullest extent of the law. Unless otherwise stated the results shown in this test report refer only to the sample(s) tested and such sample(s) are retained for 30 days only.
Attention: To check the authenticity of testing /inspection report & certificate, please contact us at telephone: (86-755) 8307 1443, or email: CN.Doccheck@sgs.com

No.10, Weiye Road, Innovation Park, Kunshan, Jiangsu, China 215300
中国·江苏·昆山市留学生创业园伟业路10号 邮编 215300

(86-512)57355888 (86-512)57370818 www.sgsgroup.com.cn
(86-512)57355888 (86-512)57370818 sgs.china@sgs.com

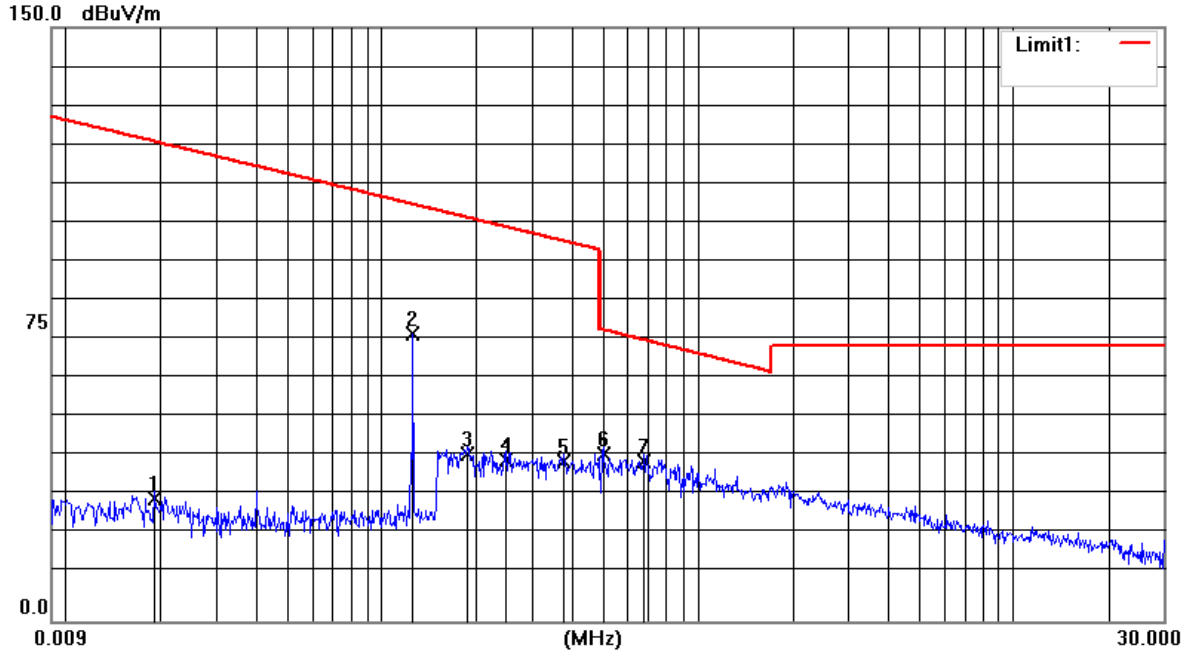

Item	Freq.	Read Level	Correct Factor	Result Level@3m	Result Level@S PEC	Limit Line@SP EC	Over Limit	Detector	Polarity
(Mark)	(MHz)	(dBμV)	(dB/m)	(dBuV/m)	(dBuV/m)	(dBuV/m)	(dB)		
1	0.0190	14.86	15.90	30.76	-49.24	41.21	-90.45	QP	Coplanar
2	0.1252	57.77	14.72	72.49	-7.51	25.31	-32.82	Peak	Coplanar
3	0.1864	27.60	14.45	42.05	-37.95	21.95	-59.9	QP	Coplanar
4	0.2454	26.40	14.44	40.84	-39.16	19.63	-58.79	QP	Coplanar
5	0.3750	25.71	14.43	40.14	-39.86	16.06	-55.92	QP	Coplanar
6	0.4994	27.67	14.41	42.08	2.08	33.64	-31.56	QP	Coplanar
7	0.6753	25.80	14.39	40.19	0.19	31.02	-30.83	QP	Coplanar



Unless otherwise agreed in writing, this document is issued by the Company subject to its General Conditions of Service printed overleaf, available on request or accessible at <http://www.sgs.com/en/Terms-and-Conditions.aspx> and, for electronic format documents, subject to Terms and Conditions for Electronic Documents at <http://www.sgs.com/en/Terms-and-Conditions/Terms-e-Documents.aspx>. Attention is drawn to the limitation of liability, indemnification and jurisdiction issues defined therein. Any holder of this document is advised that information contained hereon reflects the Company's findings at the time of its intervention only and within the limits of Client's instructions, if any. The Company's sole responsibility is to its Client and this document does not exonerate parties to a transaction from exercising all their rights and obligations under the transaction documents. This document cannot be reproduced except in full, without prior written approval of the Company. Any unauthorized alteration, forgery or falsification of the content or appearance of this document is unlawful and offenders may be prosecuted to the fullest extent of the law. Unless otherwise stated the results shown in this test report refer only to the sample(s) tested and such sample(s) are retained for 30 days only.
Attention: To check the authenticity of testing /inspection report & certificate, please contact us at telephone: (86-755) 8307 1443, or email: CN.Doccheck@sgs.com

No.10, Weiye Road, Innovation Park, Kunshan, Jiangsu, China 215300 t(86-512)57355888 f(86-512)57370818 www.sgsgroup.com.cn
 中国·江苏·昆山市留学院创业园伟业路10号 邮编 215300 t(86-512)57355888 f(86-512)57370818 sgs.china@sgs.com

3. Below 1GHz

Module a:

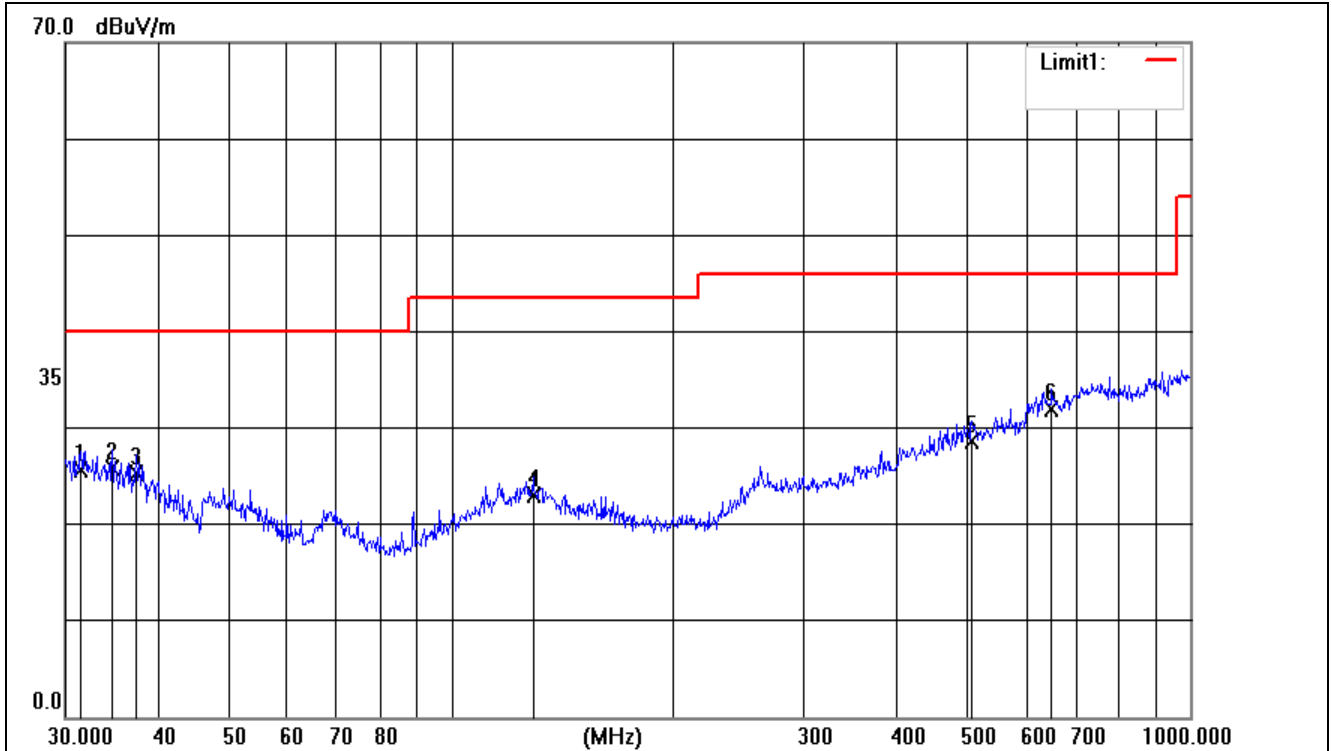

No.	Frequency (MHz)	Reading (dBuV)	Correct Factor(dB/m)	Result (dBuV/m)	Limit (dBuV/m)	Margin (dB)	Remark	Polarity
1	31.5094	0.45	25.14	25.59	40.00	-14.41	QP	Horizontal
2	34.7601	1.04	24.70	25.74	40.00	-14.26	QP	Horizontal
3	37.4164	1.83	23.39	25.22	40.00	-14.78	QP	Horizontal
4	129.0146	3.58	19.41	22.99	43.50	-20.51	QP	Horizontal
5	506.4791	2.85	25.80	28.65	46.00	-17.35	QP	Horizontal
6	649.6597	4.32	27.69	32.01	46.00	-13.99	QP	Horizontal



Unless otherwise agreed in writing, this document is issued by the Company subject to its General Conditions of Service printed overleaf, available on request or accessible at <http://www.sgs.com/en/Terms-and-Conditions.aspx> and, for electronic format documents, subject to Terms and Conditions for Electronic Documents at <http://www.sgs.com/en/Terms-and-Conditions/Terms-e-Documents.aspx>. Attention is drawn to the limitation of liability, indemnification and jurisdiction issues defined therein. Any holder of this document is advised that information contained hereon reflects the Company's findings at the time of its intervention only and within the limits of Client's instructions, if any. The Company's sole responsibility is to its Client and this document does not exonerate parties to a transaction from exercising all their rights and obligations under the transaction documents. This document cannot be reproduced except in full, without prior written approval of the Company. Any unauthorized alteration, forgery or falsification of the content or appearance of this document is unlawful and offenders may be prosecuted to the fullest extent of the law. Unless otherwise stated the results shown in this test report refer only to the sample(s) tested and such sample(s) are retained for 30 days only.
Attention: To check the authenticity of testing /inspection report & certificate, please contact us at telephone: (86-755) 8307 1443, or email: CN.Doccheck@sgs.com

No.10, Weiye Road, Innovation Park, Kunshan, Jiangsu, China 215300
中国·江苏·昆山市留学院创业园伟业路10号 邮编 215300

t(86-512)57355888 f(86-512)57370818 www.sgsgroup.com.cn
t(86-512)57355888 f(86-512)57370818 sgs.china@sgs.com

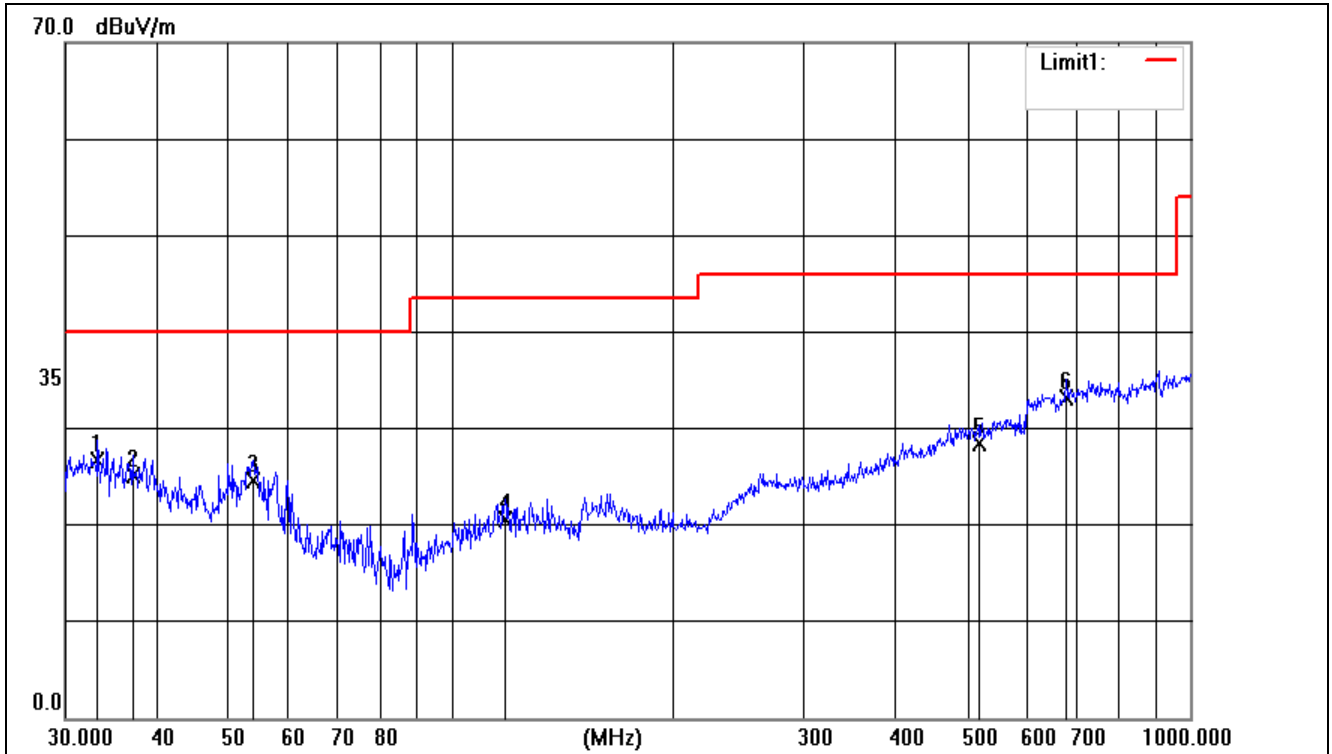

No.	Frequency (MHz)	Reading (dBuV)	Correct Factor(dB/m)	Result (dBuV/m)	Limit (dBuV/m)	Margin (dB)	Remark	Polarity
1	33.2111	1.71	25.00	26.71	40.00	-13.29	QP	Vertical
2	37.0250	1.58	23.57	25.15	40.00	-14.85	QP	Vertical
3	53.8817	8.15	16.47	24.62	40.00	-15.38	QP	Vertical
4	118.1861	1.31	19.29	20.60	43.50	-22.90	QP	Vertical
5	517.2480	2.57	25.86	28.43	46.00	-17.57	QP	Vertical
6	679.9600	30.64	2.44	33.08	46.00	-12.92	QP	Vertical



Unless otherwise agreed in writing, this document is issued by the Company subject to its General Conditions of Service printed overleaf, available on request or accessible at <http://www.sgs.com/en/Terms-and-Conditions.aspx> and, for electronic format documents, subject to Terms and Conditions for Electronic Documents at <http://www.sgs.com/en/Terms-and-Conditions/Terms-e-Documents.aspx>. Attention is drawn to the limitation of liability, indemnification and jurisdiction issues defined therein. Any holder of this document is advised that information contained hereon reflects the Company's findings at the time of its intervention only and within the limits of Client's instructions, if any. The Company's sole responsibility is to its Client and this document does not exonerate parties to a transaction from exercising all their rights and obligations under the transaction documents. This document cannot be reproduced except in full, without prior written approval of the Company. Any unauthorized alteration, forgery or falsification of the content or appearance of this document is unlawful and offenders may be prosecuted to the fullest extent of the law. Unless otherwise stated the results shown in this test report refer only to the sample(s) tested and such sample(s) are retained for 30 days only.
Attention: To check the authenticity of testing /inspection report & certificate, please contact us at telephone: (86-755) 8307 1443, or email: CN.Doccheck@sgs.com

No.10, Weiye Road, Innovation Park, Kunshan, Jiangsu, China 215300
 中国·江苏·昆山市留学院创业园伟业路10号 邮编 215300

t(86-512)57355888 f(86-512)57370818 www.sgsgroup.com.cn
 t(86-512)57355888 f(86-512)57370818 sgs.china@sgs.com

Module b:

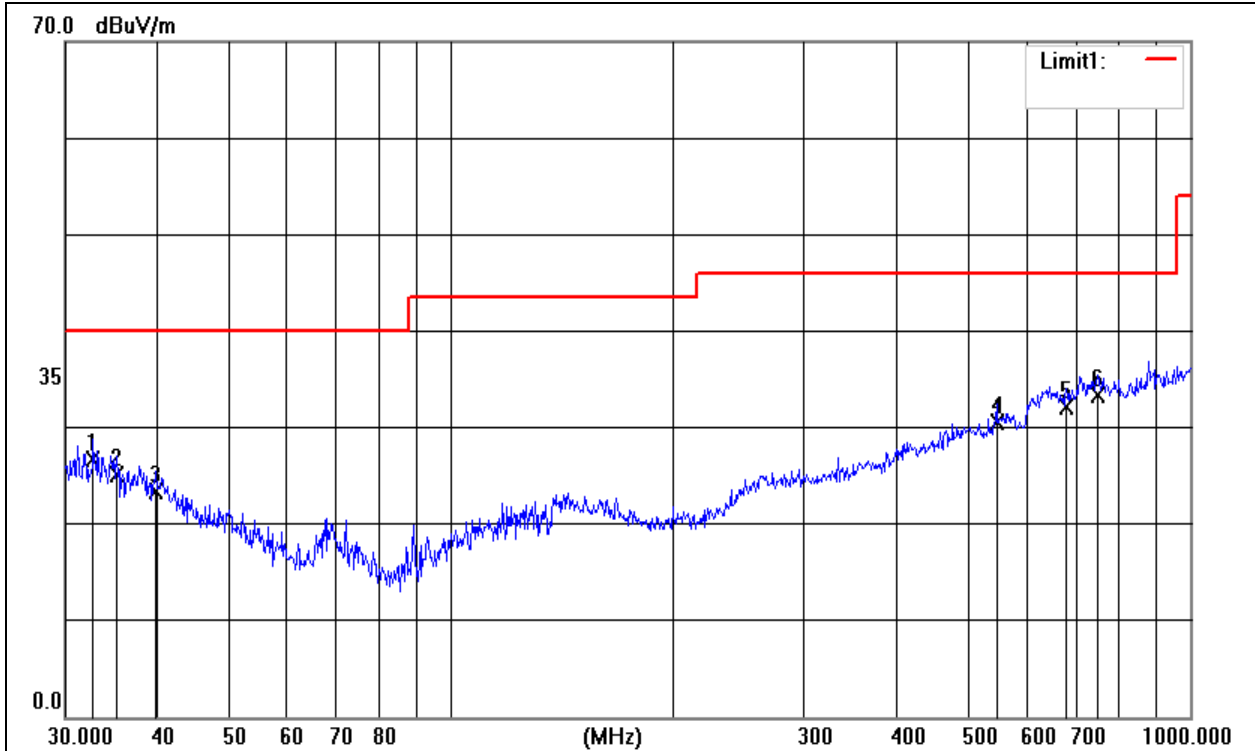

No.	Frequency (MHz)	Reading (dBuV)	Correct Factor(dB/m)	Result (dBuV/m)	Limit (dBuV/m)	Margin (dB)	Remark	Polarity
1	32.7486	1.71	25.06	26.77	40.00	-13.23	QP	Horizontal
2	35.2511	0.57	24.50	25.07	40.00	-14.93	QP	Horizontal
3	39.8541	1.06	22.36	23.42	40.00	-16.58	QP	Horizontal
4	547.0977	3.33	27.14	30.47	46.00	-15.53	QP	Horizontal
5	679.9600	29.67	2.44	32.11	46.00	-13.89	QP	Horizontal
6	750.1082	31.00	2.36	33.36	46.00	-12.64	QP	Horizontal



Unless otherwise agreed in writing, this document is issued by the Company subject to its General Conditions of Service printed overleaf, available on request or accessible at <http://www.sgs.com/en/Terms-and-Conditions.aspx> and, for electronic format documents, subject to Terms and Conditions for Electronic Documents at <http://www.sgs.com/en/Terms-and-Conditions/Terms-e-Documents.aspx>. Attention is drawn to the limitation of liability, indemnification and jurisdiction issues defined therein. Any holder of this document is advised that information contained hereon reflects the Company's findings at the time of its intervention only and within the limits of Client's instructions, if any. The Company's sole responsibility is to its Client and this document does not exonerate parties to a transaction from exercising all their rights and obligations under the transaction documents. This document cannot be reproduced except in full, without prior written approval of the Company. Any unauthorized alteration, forgery or falsification of the content or appearance of this document is unlawful and offenders may be prosecuted to the fullest extent of the law. Unless otherwise stated the results shown in this test report refer only to the sample(s) tested and such sample(s) are retained for 30 days only.
Attention: To check the authenticity of testing /inspection report & certificate, please contact us at telephone: (86-755) 8307 1443, or email: CN.Doccheck@sgs.com

No.10, Weiye Road, Innovation Park, Kunshan, Jiangsu, China 215300
中国·江苏·昆山市留学生创业园伟业路10号 邮编 215300

t(86-512)57355888 f(86-512)57370818 www.sgsgroup.com.cn
t(86-512)57355888 f(86-512)57370818 sgs.china@sgs.com

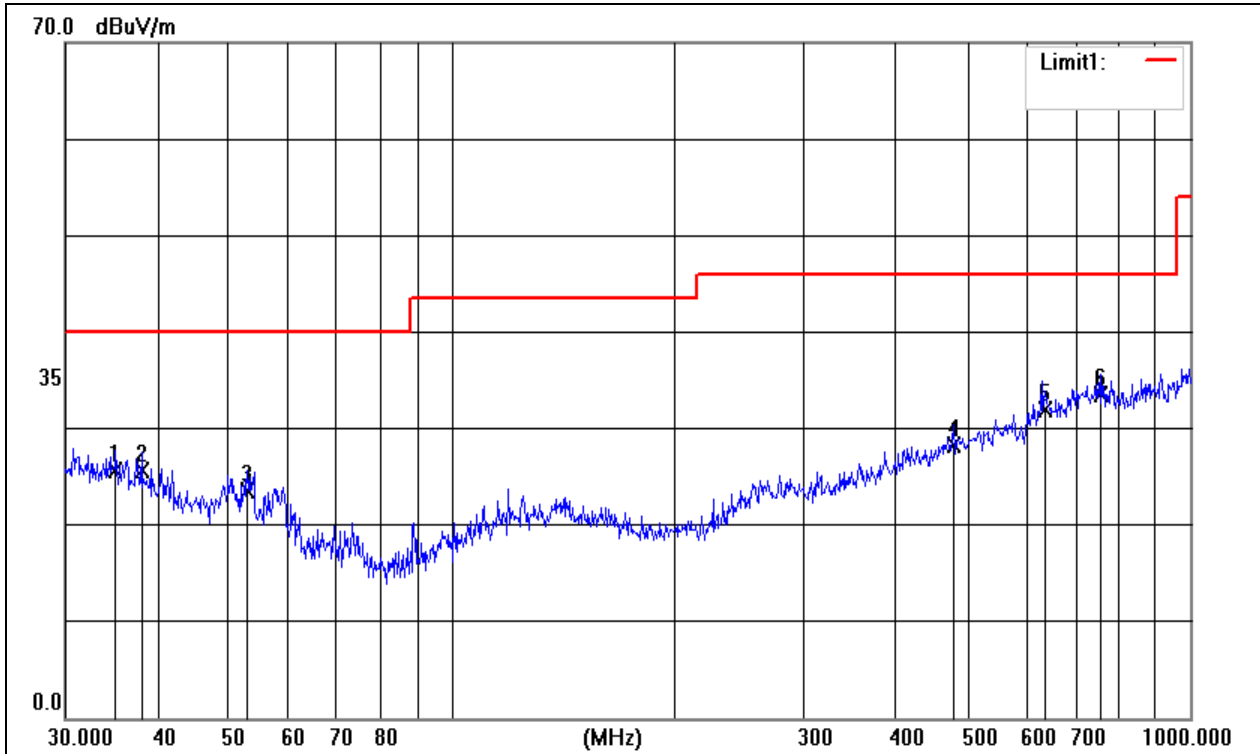

No.	Frequency (MHz)	Reading (dBuV)	Correct Factor(dB/m)	Result (dBuV/m)	Limit (dBuV/m)	Margin (dB)	Remark	Polarity
1	35.1278	1.09	24.57	25.66	40.00	-14.34	QP	Vertical
2	38.0782	2.54	23.08	25.62	40.00	-14.38	QP	Vertical
3	52.9453	6.83	16.77	23.60	40.00	-16.40	QP	Vertical
4	478.8455	3.20	25.15	28.35	46.00	-17.65	QP	Vertical
5	636.1340	4.23	27.70	31.93	46.00	-14.07	QP	Vertical
6	758.0407	31.21	2.34	33.55	46.00	-12.45	QP	Vertical

- End of the Report -



Unless otherwise agreed in writing, this document is issued by the Company subject to its General Conditions of Service printed overleaf, available on request or accessible at <http://www.sgs.com/en/Terms-and-Conditions.aspx> and, for electronic format documents, subject to Terms and Conditions for Electronic Documents at <http://www.sgs.com/en/Terms-and-Conditions/Terms-e-Documents.aspx>. Attention is drawn to the limitation of liability, indemnification and jurisdiction issues defined therein. Any holder of this document is advised that information contained hereon reflects the Company's findings at the time of its intervention only and within the limits of Client's instructions, if any. The Company's sole responsibility is to its Client and this document does not exonerate parties to a transaction from exercising all their rights and obligations under the transaction documents. This document cannot be reproduced except in full, without prior written approval of the Company. Any unauthorized alteration, forgery or falsification of the content or appearance of this document is unlawful and offenders may be prosecuted to the fullest extent of the law. Unless otherwise stated the results shown in this test report refer only to the sample(s) tested and such sample(s) are retained for 30 days only.
Attention: To check the authenticity of testing /inspection report & certificate, please contact us at telephone: (86-755) 8307 1443, or email: CN.Doccheck@sgs.com

No.10, Weiye Road, Innovation Park, Kunshan, Jiangsu, China 215300
 中国·江苏·昆山市留学生创业园伟业路10号 邮编 215300

t(86-512)57355888 f(86-512)57370818 www.sgsgroup.com.cn
 t(86-512)57355888 f(86-512)57370818 sgs.china@sgs.com