

**HIKVISION**

## Video Conference PTZ Camera

User Manual

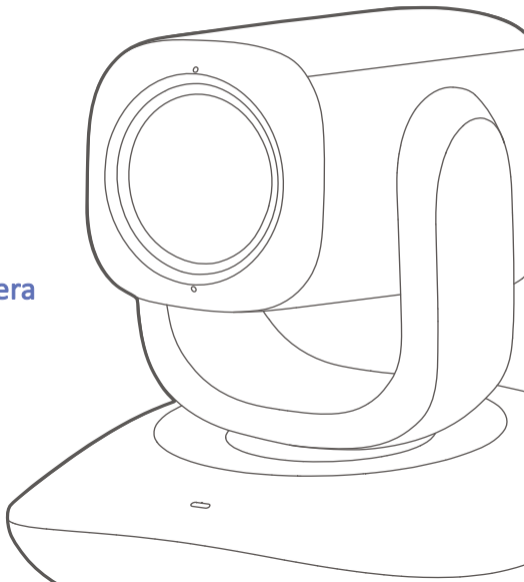



## Packing List



Camera



Remote Control



Battery



Quick Start Guide

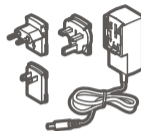

Power Adapter



Extension Cable

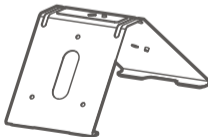

Bracket



Screws



USB Cable



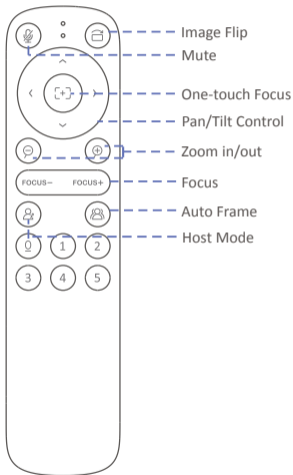

## Functions

	Supports four modes. The image flips as the following order every time pressing the button. "F" is the default status. <b>F 7 J E F</b>
	Turn on/off the audio of the remote control or the camera.
	Adjust the focus manually.
	Pan/tilt the camera Press the button to adjust the camera by level. Press and hold the button to adjust the camera continuously.
	Zoom in/out Press the button to adjust the camera by level. Press and hold the button to adjust the camera continuously.
<b>FOCUS- / +</b>	Focus Press the button to adjust the camera by level. Press and hold the button to adjust the camera continuously.
	Turn on/off the Auto Frame. Press the button to enable the function. Press and hold the button for 3 seconds to return to the normal view.
	Turn on/off the pickup function of the remote control. Press and hold the button to enable the function. Release the button to disable the function. Note: The pickup function of the camera is disabled when enabling the remote control pickup.

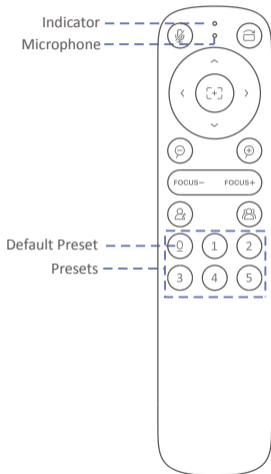



<p>①</p>	<p>If the preset 0 is predefined, the camera moves to the set position after powering on. If not, the camera moves to the default position after powering on.</p>
<p>① ~ ⑤</p>	<ol style="list-style-type: none"> <li>1. Adjust the image by remote control.</li> <li>2. Press and hold a preset number for 3 seconds, and the indicator flashes twice. It means the preset is successfully set.</li> <li>3. Press the preset number, and the device return to the defined position. Up to 6 presets can be set.</li> </ol>
<p>[+] + </p>	<p>Restore to the default settings Press and hold the buttons at the same time for 3 seconds, and the red indicator flashes three times.</p>
<p> + [+]</p>	<p>Wireless pairing Press and hold the buttons at the same time for 3 seconds, and the white indicator flashes continuously.</p>

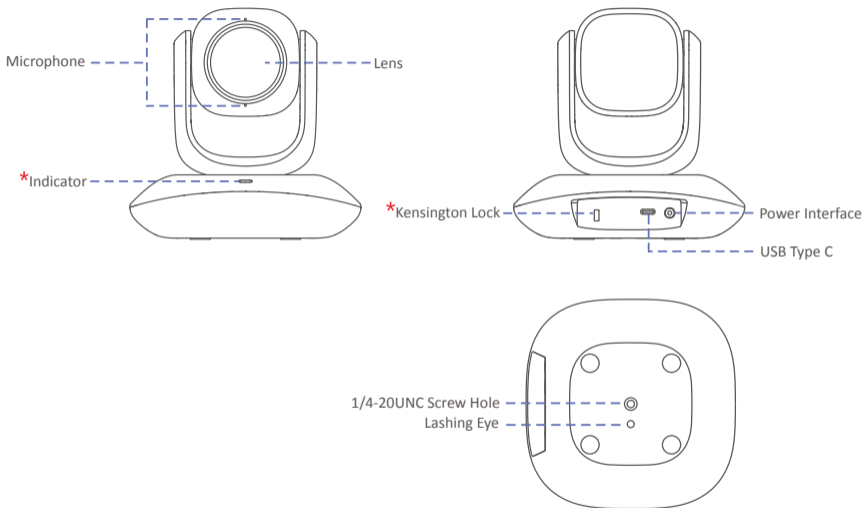

\* The lock shall be purchased separately.

\* When the indicator turns to red, it means the device is standby. When the indicator turns to blue, it means the device is working normally.



## Connection

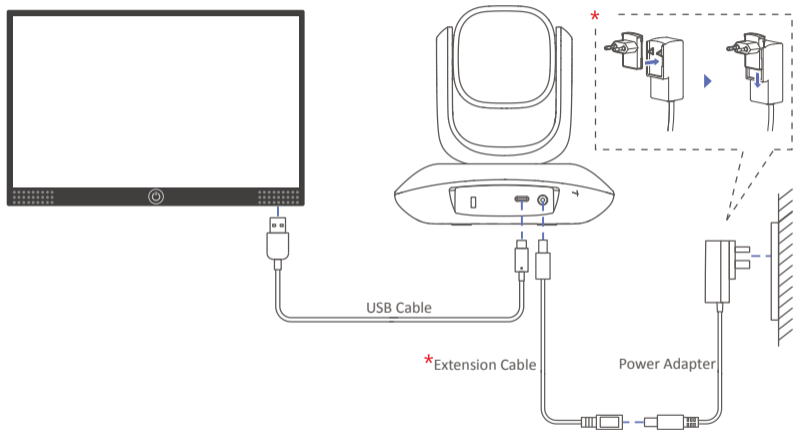

- \* The device supports connecting to intelligent terminal, such as the computer and conference display screen.
- \* Select the suitable power adapter plug according to the actual using environment.
- \* Extension cable is for long-distance connection.



## Installation

- Table Mounting

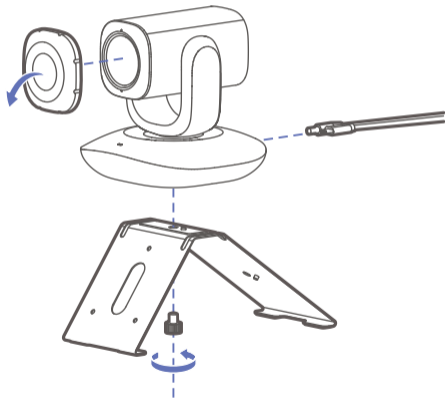

● Wall Mounting

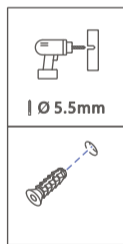
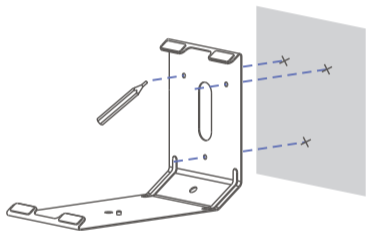



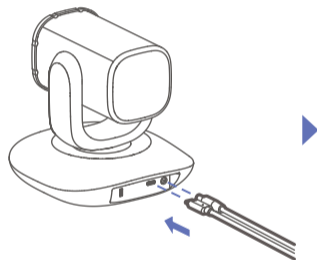
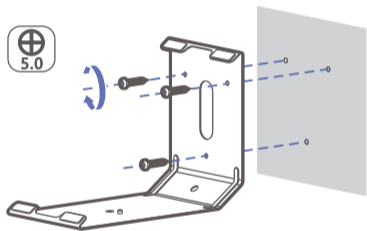

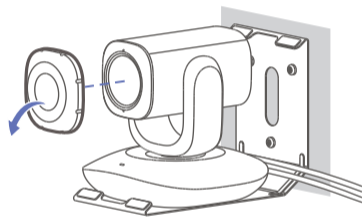
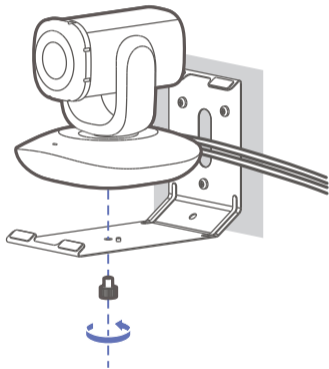

• Others

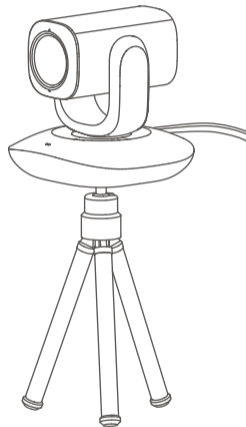
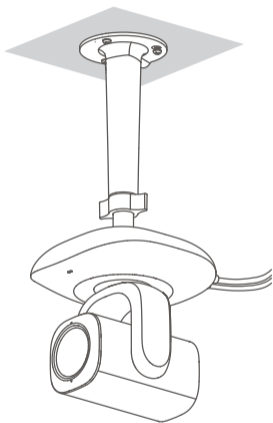

\*The brackets shall be purchased separately. Threaded hole: 1/4-20UNC.



## Angle Adjustment

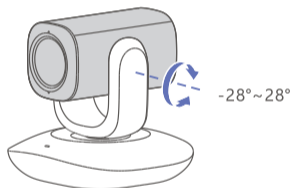
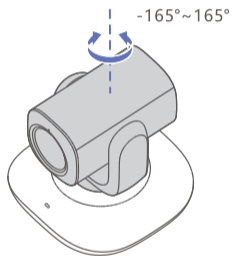

©2021 Hangzhou Hikvision Digital Technology Co., Ltd. All rights reserved.

## About this Manual

The Manual includes instructions for using and managing the Product. Pictures, charts, images and all other information hereinafter are for description and explanation only. The information contained in the Manual is subject to change, without notice, due to firmware updates or other reasons. Please find the latest version of this Manual at the Hikvision website (<https://www.hikvision.com/>).

Please use this Manual with the guidance and assistance of professionals trained in supporting the Product.

## Trademarks

**HIKVISION** and other Hikvision's trademarks and logos are the properties of Hikvision in various jurisdictions.

Other trademarks and logos mentioned are the properties of their respective owners.

## Disclaimer

TO THE MAXIMUM EXTENT PERMITTED BY APPLICABLE LAW, THIS MANUAL AND THE PRODUCT DESCRIBED, WITH ITS HARDWARE, SOFTWARE AND FIRMWARE, ARE PROVIDED "AS IS" AND "WITH ALL FAULTS AND ERRORS". HIKVISION MAKES NO WARRANTIES, EXPRESS OR IMPLIED, INCLUDING WITHOUT LIMITATION, MERCHANTABILITY, SATISFACTORY QUALITY, OR FITNESS FOR A PARTICULAR PURPOSE. THE USE OF THE PRODUCT BY YOU IS AT YOUR OWN RISK. IN NO EVENT WILL HIKVISION BE LIABLE TO YOU FOR ANY SPECIAL, CONSEQUENTIAL, INCIDENTAL, OR INDIRECT DAMAGES, INCLUDING, AMONG OTHERS, DAMAGES FOR LOSS OF BUSINESS PROFITS, BUSINESS INTERRUPTION, OR LOSS OF DATA, CORRUPTION OF SYSTEMS, OR LOSS OF DOCUMENTATION, WHETHER BASED ON BREACH OF CONTRACT, TORT (INCLUDING NEGLIGENCE), PRODUCT LIABILITY, OR OTHERWISE, IN CONNECTION WITH THE USE OF THE PRODUCT, EVEN IF HIKVISION HAS BEEN ADVISED OF THE POSSIBILITY OF SUCH DAMAGES OR LOSS.

YOU ACKNOWLEDGE THAT THE NATURE OF THE INTERNET PROVIDES FOR INHERENT SECURITY RISKS, AND HIKVISION SHALL NOT TAKE ANY RESPONSIBILITIES FOR ABNORMAL OPERATION, PRIVACY LEAKAGE OR OTHER DAMAGES RESULTING FROM CYBER-ATTACK, HACKER ATTACK, VIRUS INFECTION, OR OTHER INTERNET SECURITY RISKS; HOWEVER, HIKVISION WILL PROVIDE TIMELY TECHNICAL SUPPORT IF REQUIRED.

YOU AGREE TO USE THIS PRODUCT IN COMPLIANCE WITH ALL APPLICABLE LAWS, AND YOU ARE SOLELY RESPONSIBLE FOR ENSURING THAT YOUR USE CONFORMS TO THE APPLICABLE LAW. ESPECIALLY, YOU ARE RESPONSIBLE, FOR USING THIS PRODUCT IN A MANNER THAT DOES NOT INFRINGE ON THE RIGHTS OF THIRD PARTIES, INCLUDING WITHOUT LIMITATION, RIGHTS OF PUBLICITY, INTELLECTUAL PROPERTY RIGHTS, OR DATA PROTECTION AND OTHER PRIVACY RIGHTS. YOU SHALL NOT USE THIS PRODUCT FOR ANY PROHIBITED END-USES, INCLUDING THE DEVELOPMENT OR PRODUCTION OF WEAPONS OF MASS DESTRUCTION, THE DEVELOPMENT OR PRODUCTION OF CHEMICAL OR BIOLOGICAL WEAPONS, ANY ACTIVITIES IN THE CONTEXT RELATED TO ANY NUCLEAR EXPLOSIVE OR UNSAFE NUCLEAR FUEL-CYCLE, OR IN SUPPORT OF HUMAN RIGHTS ABUSES.

IN THE EVENT OF ANY CONFLICTS BETWEEN THIS MANUAL AND THE APPLICABLE LAW, THE LATER PREVAILS.

## **Regulatory Information**

### **FCC Information**

Please take attention that changes or modification not expressly approved by the party responsible for compliance could void the user's authority to operate the equipment.

FCC compliance: This equipment has been tested and found to comply with the limits for a Class B digital device, pursuant to part 15 of the FCC Rules. These limits are designed to provide reasonable protection against harmful interference when the equipment is operated in a commercial environment. This equipment generates, uses, and can radiate radio frequency energy and, if not installed and used in accordance with the instruction manual, may cause harmful interference to radio communications. Operation of this equipment in a residential area is likely to cause harmful interference in which case the user will be required to correct the interference at his own expense.

### **FCC Conditions**

This device complies with part 15 of the FCC Rules. Operation is subject to the following two conditions:

1. This device may not cause harmful interference.
2. This device must accept any interference received, including interference that may cause undesired operation.

This equipment complies with FCC radiation exposure limits set forth for an uncontrolled environment. This equipment should be installed and operated with minimum distance 20cm between the radiator & your body.

### **EU Conformity Statement**

**CE** This product and - if applicable - the supplied accessories too are marked with "CE" and comply therefore with the applicable harmonized European standards listed under the Low Voltage Directive 2014/35/EU, the EMC Directive 2014/30/EU, the RoHS Directive 2011/65/EU.

 2012/19/EU (WEEE directive): Products marked with this symbol cannot be disposed of as unsorted municipal waste in the European Union. For proper recycling, return this product to your local supplier upon the purchase of equivalent new equipment, or dispose of it at designated collection points. For more information see: [www.recyclethis.info](http://www.recyclethis.info).

 2006/66/EC (battery directive): This product contains a battery that cannot be disposed of as unsorted municipal waste in the European Union. See the product documentation for specific battery information. The battery is marked with this symbol, which may include lettering to indicate cadmium (Cd), lead (Pb), or mercury (Hg). For proper recycling, return the battery to your supplier or to a designated collection point. For more information, see: [www.recyclethis.info](http://www.recyclethis.info).

### **Industry Canada ICES-003 Compliance**

This device meets the CAN ICES-3 (B)/NMB-3(B) standards requirements.

## Safety Instruction



### Warnings

#### Laws and Regulations

The device should be used in compliance with local laws, electrical safety regulations, and fire prevention regulations.

#### Electrical Safety

The socket-outlet shall be installed near the equipment and shall be easily accessible.

#### Battery

**CAUTION:** Risk of explosion if the battery is replaced by an incorrect type.

Improper replacement of the battery with an incorrect type may defeat a safeguard (for example, in the case of some lithium battery types).

Do not dispose of the battery into fire or a hot oven, or mechanically crush or cut the battery, which may result in an explosion.

Do not leave the battery in an extremely high temperature surrounding environment, which may result in an explosion or the leakage of flammable liquid or gas.

Do not subject the battery to extremely low air pressure, which may result in an explosion or the leakage of flammable liquid or gas.

Dispose of used batteries according to the instructions.



### Cautions

#### Fire Prevention

No naked flame sources, such as lighted candles, should be placed on the equipment.

#### Installation

Install the equipment according to the instructions in this manual.

Never place the equipment in an unstable location. The equipment may fall, causing serious personal injury or death.

DO NOT touch the sharp edges or corners.

#### Transportation

Keep the device in original or similar packaging while transporting it.

DO NOT drop the product or subject it to physical shock.

#### Power Supply

EUT will be charged by specified source which the output circuit comply with LPS/PS 2.

Refer to the device label for the standard power supply. Please make sure your power supply matches with your device.

Use a power adapter provided by qualified manufacturers. It is recommended to provide an independent power adapter for each device as adapter overload may cause over-heating or a fire hazard.

#### Maintenance

If the product does not work properly, please contact your dealer or the nearest service center. We shall not assume any responsibility for problems caused by unauthorized repair or maintenance.

**Cleaning**

Please use a soft and dry cloth to clean the interior and exterior surfaces. Do not use alkaline detergents.

**Using Environment**

When any laser equipment is in use, make sure that the device lens is not exposed to the laser beam, or it may burn out.

DO NOT aim the lens at the sun or any other bright light.

To avoid heat accumulation, good ventilation is required for a proper operating environment.

DO NOT expose the device to extremely hot, cold, dusty, corrosive, saline-alkali, or damp environments. For temperature and humidity requirements, see device specification.

DO NOT expose the device to high electromagnetic radiation.

**Emergency**

If smoke, odor, or noise arises from the device, immediately turn off the power, unplug the power cable, and contact the service center.





See Far, Go Further