

# DFS TEST REPORT

**Application No.:** KSCR2109000086AT  
**FCC ID:** 2ADTD-03C5ACO  
**IC:** 20199-03C5ACO  
**Applicant:** Hangzhou Hikvision Digital Technology Co., Ltd.  
**Address of Applicant:** No.555 Qianmo Road, Binjiang District Hangzhou 310052, China  
**Manufacturer:** Hangzhou Hikvision Digital Technology Co., Ltd.  
**Address of Manufacturer:** No.555 Qianmo Road, Binjiang District Hangzhou 310052, China  
**Factory:** Hangzhou Hikvision Technology Co., Ltd.  
 Hangzhou Hikvision Electronics Co.,Ltd.  
 Hangzhou Hikvision Digital Technology Co., Ltd.  
**Address of Factory:** No.700, Dongliu Road, Binjiang District, Hangzhou Ctiy, Zhejiang, 310052, China  
 No.299, Qiushi Road, Tonglu Economic Development Zone, Tonglu County, Hangzhou, Zhejiang, 310052, China.  
 No.555 Qianmo Road, Binjiang District Hangzhou 310052, China

**Equipment Under Test (EUT):**

**EUT Name:** Wireless Bridge  
**Model No.:** DS-3WF03C-5AC/O, DS-3WF03C-5ACUHK/O, DS-3WF03C-5ACCKV/O, DS-3WF03C-5ACUVS/O, DS-3WF03C-5ACKVO/O, DS-3WF03C-5ACHUN/O, DS-XXXXXXXXXXXXX (X can be numbers 0-9 or A-Z or / or - or \* or blank) □

□ Please refer to section 2 of this report which indicates which model was actually tested and which were electrically identical.

**Standard(s) :** 47 CFR Part 15, Subpart E 15.407  
 KDB 905462 D02 UNII DFS Compliance Procedures New Rules v02  
 KDB 905462 D03 UNII Clients Without Radar Detection New Rules v01r02  
 KDB 905462 D04 Operational Modes for DFS Testing New Rules v01  
 RSS-247 Issue 2, February 2017

**Date of Receipt:** 2021-09-18  
**Date of Test:** 2021-10-18 to 2021-11-12  
**Date of Issue:** 2021-11-12

<b>Test Result:</b>	<b>Pass*</b>
---------------------	--------------

\* In the configuration tested, the EUT complied with the standards specified above.

Eric Lin  
Laboratory Manager



Unless otherwise agreed in writing, this document is issued by the Company subject to its General Conditions of Service printed overleaf, available on request or accessible at <http://www.sgs.com/en/Terms-and-Conditions.aspx> and, for electronic format documents, subject to Terms and Conditions for Electronic Documents at <http://www.sgs.com/en/Terms-and-Conditions/Terms-e-Document.aspx>. Attention is drawn to the limitation of liability, indemnification and jurisdiction issues defined therein. Any holder of this document is advised that information contained hereon reflects the Company's findings at the time of its intervention only and within the limits of Client's instructions, if any. The Company's sole responsibility is to its Client and this document does not exonerate parties to a transaction from exercising all their rights and obligations under the transaction documents. This document cannot be reproduced except in full, without prior written approval of the Company. Any unauthorized alteration, forgery or falsification of the content or appearance of this document is unlawful and offenders may be prosecuted to the fullest extent of the law. Unless otherwise stated the results shown in this test report refer only to the sample(s) tested and such sample(s) are retained for 30 days only.  
 Attention: To check the authenticity of testing /inspection report & certificate, please contact us at telephone: (86-755) 8307 1443, or email: [CN\\_Doccheck@sgs.com](mailto:CN_Doccheck@sgs.com)

No.10, Weiye Road, Innovation Park, Kunshan, Jiangsu, China 215300  
 中国·江苏·昆山市留学生创业园伟业路10号 邮编 215300  
 t(86-512)57355888 f(86-512)57370818 www.sgsgroup.com.cn  
 t(86-512)57355888 f(86-512)57370818 sgs.china@sgs.com



For IC Model No.: DS-3WF03C-5AC/O, DS-3WF03C-5ACUHK/O, DS-3WF03C-5ACCKV/O, DS-3WF03C-5ACUVS/O, DS-3WF03C-5ACKVO/O, DS-3WF03C-5ACHUN/O



Unless otherwise agreed in writing, this document is issued by the Company subject to its General Conditions of Service printed overleaf, available on request or accessible at <http://www.sgs.com/en/Terms-and-Conditions.aspx> and, for electronic format documents, subject to Terms and Conditions for Electronic Documents at <http://www.sgs.com/en/Terms-and-Conditions/Terms-e-Documents.aspx>. Attention is drawn to the limitation of liability, indemnification and jurisdiction issues defined therein. Any holder of this document is advised that information contained hereon reflects the Company's findings at the time of its intervention only and within the limits of Client's instructions, if any. The Company's sole responsibility is to its Client and this document does not exonerate parties to a transaction from exercising all their rights and obligations under the transaction documents. This document cannot be reproduced except in full, without prior written approval of the Company. Any unauthorized alteration, forgery or falsification of the content or appearance of this document is unlawful and offenders may be prosecuted to the fullest extent of the law. Unless otherwise stated the results shown in this test report refer only to the sample(s) tested and such sample(s) are retained for 30 days only. Attention: To check the authenticity of testing /inspection report & certificate, please contact us at telephone: (86-755) 8307 1443, or email: [CN.Doccheck@sgs.com](mailto:CN.Doccheck@sgs.com)

No.10, Weiye Road, Innovation Park, Kunshan, Jiangsu, China 215300  
中国·江苏·昆山市留学生创业园伟业路10号 邮编 215300

t(86-512)57355888 f(86-512)57370818 www.sgs.com.cn  
t(86-512)57355888 f(86-512)57370818 sgs.china@sgs.com



Revision Record			
Version	Description	Date	Remark
00	Original	2021-11-12	/

Authorized for issue by:			
		<i>Damon Zhou</i>	
		<b>Damon Zhou / Project Engineer</b>	
		<i>Eric Lin</i>	
		<b>Eric Lin / Reviewer</b>	



Unless otherwise agreed in writing, this document is issued by the Company subject to its General Conditions of Service printed overleaf, available on request or accessible at <http://www.sgs.com/en/Terms-and-Conditions.aspx> and, for electronic format documents, subject to Terms and Conditions for Electronic Documents at <http://www.sgs.com/en/Terms-and-Conditions/Terms-e-Documents.aspx>. Attention is drawn to the limitation of liability, indemnification and jurisdiction issues defined therein. Any holder of this document is advised that information contained hereon reflects the Company's findings at the time of its intervention only and within the limits of Client's instructions, if any. The Company's sole responsibility is to its Client and this document does not exonerate parties to a transaction from exercising all their rights and obligations under the transaction documents. This document cannot be reproduced except in full, without prior written approval of the Company. Any unauthorized alteration, forgery or falsification of the content or appearance of this document is unlawful and offenders may be prosecuted to the fullest extent of the law. Unless otherwise stated the results shown in this test report refer only to the sample(s) tested and such sample(s) are retained for 30 days only.

Attention: To check the authenticity of testing / inspection report & certificate, please contact us at telephone: (86-755) 8307 1443, or email: [CN.Doccheck@sgs.com](mailto:CN.Doccheck@sgs.com)  
 No.10, Weiye Road, Innovation Park, Kunshan, Jiangsu, China 215300      t(86-512)57355888      f(86-512)57370818      www.sgs.com.cn  
 中国·江苏·昆山市留学院创业园伟业路10号 邮编 215300      t(86-512)57355888      f(86-512)57370818      sgs.china@sgs.com

## 2 Test Summary

Item	FCC Standard	ISED Standard	Method	Requirement	Result
Channel Loading	47 CFR Part 15, Subpart E 15.407	RSS-247	KDB 905462 D02 Section 7.8.3	KDB 905462 D02 Section 5.1	Pass
Detection Bandwidth	47 CFR Part 15, Subpart E 15.407	RSS-247	KDB 905462 D02 Section 7.8.3	KDB 905462 D02 Section 5.1	Pass
Channel Available Check	47 CFR Part 15, Subpart E 15.407	RSS-247	KDB 905462 D02 Section 7.8.3	KDB 905462 D02 Section 5.1	Pass
Closing Move Time and Closing Transmission Time	47 CFR Part 15, Subpart E 15.407	RSS-247	KDB 905462 D02 Section 7.8.3	KDB 905462 D02 Section 5.1	Pass
Non-occupancy period	47 CFR Part 15, Subpart E 15.407	RSS-247	KDB 905462 D02 Section 7.8.3	KDB 905462 D02 Section 5.1	Pass
Statistical Performance Check	47 CFR Part 15, Subpart E 15.407	RSS-247	KDB 905462 D02 Section 7.8.3	KDB 905462 D02 Section 5.1	Pass

### Declaration of EUT Family Grouping:

Note: There are series models mentioned in this report, and they are the similar in electrical and electronic characters. Only the model DS-3WF03C-5AC/O was tested since their differences were the model number and appearance.



Unless otherwise agreed in writing, this document is issued by the Company subject to its General Conditions of Service printed overleaf, available on request or accessible at <http://www.sgs.com/en/Terms-and-Conditions.aspx> and, for electronic format documents, subject to Terms and Conditions for Electronic Documents at <http://www.sgs.com/en/Terms-and-Conditions/Terms-e-Documents.aspx>. Attention is drawn to the limitation of liability, indemnification and jurisdiction issues defined therein. Any holder of this document is advised that information contained hereon reflects the Company's findings at the time of its intervention only and within the limits of Client's instructions, if any. The Company's sole responsibility is to its Client and this document does not exonerate parties to a transaction from exercising all their rights and obligations under the transaction documents. This document cannot be reproduced except in full, without prior written approval of the Company. Any unauthorized alteration, forgery or falsification of the content or appearance of this document is unlawful and offenders may be prosecuted to the fullest extent of the law. Unless otherwise stated the results shown in this test report refer only to the sample(s) tested and such sample(s) are retained for 30 days only.

Attention: To check the authenticity of testing /inspection report & certificate, please contact us at telephone: (86-755) 8307 1443, or email: [CN.Doccheck@sgs.com](mailto:CN.Doccheck@sgs.com)  
 No.10, Weiye Road, Innovation Park, Kunshan, Jiangsu, China 215300      t(86-512)57355888      f(86-512)57370818      www.sgsgroup.com.cn  
 中国·江苏·昆山市留学生创业园伟业路10号 邮编 215300      t(86-512)57355888      f(86-512)57370818      sgs.china@sgs.com

### 3 Contents

	Page
1 COVER PAGE .....	1
2 TEST SUMMARY .....	4
3 CONTENTS .....	5
4 GENERAL INFORMATION .....	7
4.1 DETAILS OF E.U.T. ....	7
4.2 DESCRIPTION OF SUPPORT UNITS .....	8
4.3 TEST LOCATION .....	9
4.4 TEST FACILITY .....	9
4.5 DEVIATION FROM STANDARDS .....	9
4.6 ABNORMALITIES FROM STANDARD CONDITIONS .....	9
5 EQUIPMENT LIST .....	10
6 DYNAMIC FREQUENCY SELECTION .....	11
6.1 APPLICABILITY OF DFS REQUIREMENTS .....	11
6.2 DFS DETECTION THRESHOLDS .....	12
6.3 DFS RESPONSE REQUIREMENTS .....	12
6.4 PARAMETERS OF RADAR TEST WAVEFORMS .....	13
6.4.1 Short Pulse Radar Test Waveforms .....	13
6.4.2 Long Pulse Radar Test Waveform .....	15
6.4.3 Frequency Hopping Radar Test Waveform .....	16
6.5 CALIBRATION OF RADAR WAVEFORM .....	17
6.5.1 Radar Waveform Calibration Procedure .....	17
6.5.2 Conducted Calibration Setup .....	17
6.6 CHANNEL LOADING .....	18
6.7 TEST PROCEDURE .....	18
6.7.1 U-NII Detection Bandwidth .....	18
6.7.2 Channel Availability Check .....	18
6.7.3 Radar Burst at the Beginning of the Channel Availability Check Time .....	19
6.7.4 Radar Burst at the End of the Channel Availability Check Time .....	20
6.7.5 In-Service Monitoring for Channel Move Time, Channel Closing Transmission Time and Non-Occupancy Period .....	21
6.7.6 Statistical Performance Check .....	22
6.8 TEST SETUP .....	23
6.9 TEST RESULT .....	24
6.9.1 Radar Waveform Calibration Result .....	24
6.9.2 Channel Loading .....	45
6.9.3 Detection Bandwidth .....	48
6.9.4 Channel Available Check .....	60
6.9.5 In-Service Monitoring for Channel Move Time and Channel Closing Transmission Time .....	67
6.9.6 Non-occupancy period .....	70
6.9.7 Statistical Performance Check .....	73
7 TEST SETUP PHOTOGRAPHS .....	110



Unless otherwise agreed in writing, this document is issued by the Company subject to its General Conditions of Service printed overleaf, available on request or accessible at <http://www.sgs.com/en/Terms-and-Conditions.aspx> and, for electronic format documents, subject to Terms and Conditions for Electronic Documents at <http://www.sgs.com/en/Terms-and-Conditions/Terms-e-Documents.aspx>. Attention is drawn to the limitation of liability, indemnification and jurisdiction issues defined therein. Any holder of this document is advised that information contained hereon reflects the Company's findings at the time of its intervention only and within the limits of Client's instructions, if any. The Company's sole responsibility is to its Client and this document does not exonerate parties to a transaction from exercising all their rights and obligations under the transaction documents. This document cannot be reproduced except in full, without prior written approval of the Company. Any unauthorized alteration, forgery or falsification of the content or appearance of this document is unlawful and offenders may be prosecuted to the fullest extent of the law. Unless otherwise stated the results shown in this test report refer only to the sample(s) tested and such sample(s) are retained for 30 days only.

Attention: To check the authenticity of testing/inspection report & certificate, please contact us at telephone: (86-755) 8307 1443, or email: [CN.Doccheck@sgs.com](mailto:CN.Doccheck@sgs.com)

No.10, Weiye Road, Innovation Park, Kunshan, Jiangsu, China 215300  
中国·江苏·昆山市留学院创业园伟业路10号 邮编 215300

☎(86-512)57355888 ☎(86-512)57370818 [www.sgs.com](http://www.sgs.com)  
☎(86-512)57355888 ☎(86-512)57370818 [sgs.china@sgs.com](mailto:sgs.china@sgs.com)





8 EUT CONSTRUCTIONAL DETAILS..... 110



Unless otherwise agreed in writing, this document is issued by the Company subject to its General Conditions of Service printed overleaf, available on request or accessible at <http://www.sgs.com/en/Terms-and-Conditions.aspx> and, for electronic format documents, subject to Terms and Conditions for Electronic Documents at <http://www.sgs.com/en/Terms-and-Conditions/Terms-e-Document.aspx>. Attention is drawn to the limitation of liability, indemnification and jurisdiction issues defined therein. Any holder of this document is advised that information contained hereon reflects the Company's findings at the time of its intervention only and within the limits of Client's instructions, if any. The Company's sole responsibility is to its Client and this document does not exonerate parties to a transaction from exercising all their rights and obligations under the transaction documents. This document cannot be reproduced except in full, without prior written approval of the Company. Any unauthorized alteration, forgery or falsification of the content or appearance of this document is unlawful and offenders may be prosecuted to the fullest extent of the law. Unless otherwise stated the results shown in this test report refer only to the sample(s) tested and such sample(s) are retained for 30 days only. Attention: To check the authenticity of testing /inspection report & certificate, please contact us at telephone: (86-755) 8307 1443, or email: [CN.Doccheck@sgs.com](mailto:CN.Doccheck@sgs.com)

No.10, Weiye Road, Innovation Park, Kunshan, Jiangsu, China 215300  
中国·江苏·昆山市留学生创业园伟业路10号 邮编 215300

t(86-512)57355888 f(86-512)57370818 www.sgs.com.cn  
t(86-512)57355888 f(86-512)57370818 sgs.china@sgs.com

## 4 General Information

### 4.1 Details of E.U.T.

Power supply: DC 12V by Adapter or DC 12V by PoE  
Adapter:  
MODEL: ADS-12FG-12N 12012EPCU  
INPUT: 100-240~50/60Hz, Max. 0.3A  
OUTPUT: DC 12V, 1A

Test voltage: AC 120V/60Hz  
Serial Number: G31241650  
Firmware Version: V1.0.0 build210831

Operation Frequency:	Band	Mode	Frequency Range(MHz)	Number of channels
	UNII Band I	802.11a/n(HT20)/ac(VHT20)	5180-5240	4
		802.11n(HT40)/ac(VHT40)	5190-5230	2
		802.11ac(VHT80)	5210	1
	UNII Band II-A	802.11a/n(HT20)/ac(VHT20)	5260-5320	4
		802.11n(HT40)/ac(VHT40)	5270-5310	2
		802.11ac(VHT80)	5290	1
	UNII Band II-C	802.11a/n(HT20)/ac(VHT20)	5500-5720	12
		802.11n(HT40)/ac(VHT40)	5510-5710	6
		802.11ac(VHT80)	5530~5690	3
UNII Band III	802.11a/n(HT20)/ac(VHT20)	5745-5825	5	
	802.11n(HT40)/ac(VHT40)	5755-5795	2	
	802.11ac(VHT80)	5775	1	
Modulation Type:	802.11a: OFDM (64QAM, 16QAM, QPSK, BPSK) 802.11n: OFDM (BPSK, QPSK, 16QAM, 64QAM) 802.11ac: OFDM (BPSK, QPSK, 16QAM, 64QAM, 256QAM)			
Data Rate:	802.11a: 6/9/12/18/24/36/48/54Mbps 802.11n: up to 300Mbps 802.11ac: up to 866.6Mbps			
Channel Spacing:	802.11a/n(HT20)/ac(VHT20): 20MHz 802.11n(HT40)/ac(VHT40): 40MHz 802.11ac(VHT80): 80MHz			
Antenna Gain:	9dBi (Provided by manufacturer)			
Antenna Type:	PCB Antenna			

Remark: For frequencies falling between 5150-5250MHz and 5600-5650MHz will not be used in Canada.



Unless otherwise agreed in writing, this document is issued by the Company subject to its General Conditions of Service printed overleaf, available on request or accessible at <http://www.sgs.com/en/Terms-and-Conditions.aspx> and, for electronic format documents, subject to Terms and Conditions for Electronic Documents at <http://www.sgs.com/en/Terms-and-Conditions/Terms-e-Documents.aspx>. Attention is drawn to the limitation of liability, indemnification and jurisdiction issues defined therein. Any holder of this document is advised that information contained hereon reflects the Company's findings at the time of its intervention only and within the limits of Client's instructions, if any. The Company's sole responsibility is to its Client and this document does not exonerate parties to a transaction from exercising all their rights and obligations under the transaction documents. This document cannot be reproduced except in full, without prior written approval of the Company. Any unauthorized alteration, forgery or falsification of the content or appearance of this document is unlawful and offenders may be prosecuted to the fullest extent of the law. Unless otherwise stated the results shown in this test report refer only to the sample(s) tested and such sample(s) are retained for 30 days only.  
Attention: To check the authenticity of testing /inspection report & certificate, please contact us at telephone: (86-755) 8307 1443, or email: [CN.Doccheck@sgs.com](mailto:CN.Doccheck@sgs.com)  
No.10, Weiye Road, Innovation Park, Kunshan, Jiangsu, China 215300  
中国·江苏·昆山市留学院创业园伟业路10号 邮编 215300

(86-512)57355888    (86-512)57370818    [www.sgs.com.cn](http://www.sgs.com.cn)  
 (86-512)57355888    (86-512)57370818    [sgs.china@sgs.com](mailto:sgs.china@sgs.com)

Selected Test Channel for 802.11a/ac(VHT20)		
Band	Channel	Frequency
U-NII Band II-A	The middle channel (CH60)	5300MHz
U-NII Band II-C	The lowest channel (CH100)	5500MHz

Selected Test Channel for 802.11ac(VHT40)		
Band	Channel	Frequency
U-NII Band II-A	The highest channel (CH62)	5310MHz
U-NII Band II-C	The lowest channel (CH102)	5510MHz

Selected Test Channel for 802.11ac(VHT80)		
Band	Channel	Frequency
U-NII Band II-A	The highest channel (CH58)	5290MHz
U-NII Band II-C	The lowest channel (CH106)	5530MHz

## 4.2 Description of Support Units

Description	Manufacturer	Model No.	Serial No.
Wireless Bridge	HIKVISION	DS-3WF02C-5AC/O	/
Notebook	LENOVO	Thinkpad T420	/
Notebook	Acer	ZQT	NXM0QCN01031403EE876



Unless otherwise agreed in writing, this document is issued by the Company subject to its General Conditions of Service printed overleaf, available on request or accessible at <http://www.sgs.com/en/Terms-and-Conditions.aspx> and, for electronic format documents, subject to Terms and Conditions for Electronic Documents at <http://www.sgs.com/en/Terms-and-Conditions/Terms-e-Documents.aspx>. Attention is drawn to the limitation of liability, indemnification and jurisdiction issues defined therein. Any holder of this document is advised that information contained hereon reflects the Company's findings at the time of its intervention only and within the limits of Client's instructions, if any. The Company's sole responsibility is to its Client and this document does not exonerate parties to a transaction from exercising all their rights and obligations under the transaction documents. This document cannot be reproduced except in full, without prior written approval of the Company. Any unauthorized alteration, forgery or falsification of the content or appearance of this document is unlawful and offenders may be prosecuted to the fullest extent of the law. Unless otherwise stated the results shown in this test report refer only to the sample(s) tested and such sample(s) are retained for 30 days only.

Attention: To check the authenticity of testing / inspection report & certificate, please contact us at telephone: (86-755) 8307 1443, or email: [CN.Doccheck@sgs.com](mailto:CN.Doccheck@sgs.com)  
 No.10, Weiye Road, Innovation Park, Kunshan, Jiangsu, China 215300      ☎(86-512)57355888      ☎(86-512)57370818      [www.sgsgroup.com.cn](http://www.sgsgroup.com.cn)  
 中国·江苏·昆山市留学院创业园伟业路10号 邮编 215300      ☎(86-512)57355888      ☎(86-512)57370818      [sgs.china@sgs.com](mailto:sgs.china@sgs.com)



### 4.3 Test Location

All tests were performed at:

Compliance Certification Services (Kunshan) Inc.

No.10 Weiye Rd, Innovation park, Eco&Tec, Development Zone, Kunshan City, Jiangsu, China.

Tel: +86 512 5735 5888 Fax: +86 512 5737 0818

No tests were sub-contracted.

### 4.4 Test Facility

The test facility is recognized, certified, or accredited by the following organizations:

- **CNAS (No. CNAS L4354)**

CNAS has accredited Compliance Certification Services (Kunshan) Inc. to ISO/IEC 17025:2017 General Requirements for the Competence of Testing and Calibration Laboratories (CNAS-CL01 Accreditation Criteria for the Competence of Testing and Calibration Laboratories) for the competence in the field of testing.

- **A2LA (Certificate No. 2541.01)**

Compliance Certification Services (Kunshan) Inc. is accredited by the American Association for Laboratory Accreditation (A2LA). Certificate No. 2541.01.

- **FCC (Designation Number: CN1172)**

Compliance Certification Services Inc. has been recognized as an accredited testing laboratory. Designation Number: CN1172.

- **ISED (CAB identifier: CN0072)**

Compliance Certification Services (Kunshan) Inc. has been recognized by Innovation, Science and Economic Development Canada (ISED) as an accredited testing laboratory.

Company Number: 2324E

- **VCCI (Member No.: 1938)**

The 3m and 10m Semi-anechoic chamber and Shielded Room of Compliance Certification Services (Kunshan) Inc. has been registered in accordance with the Regulations for Voluntary Control Measures with Registration No.: R-20134, R-11600,C-11707, T-11499, G-10216 respectively.

### 4.5 Deviation from Standards

None

### 4.6 Abnormalities from Standard Conditions

None



Unless otherwise agreed in writing, this document is issued by the Company subject to its General Conditions of Service printed overleaf, available on request or accessible at <http://www.sgs.com/en/Terms-and-Conditions.aspx> and, for electronic format documents, subject to Terms and Conditions for Electronic Documents at <http://www.sgs.com/en/Terms-and-Conditions/Terms-e-Documents.aspx>. Attention is drawn to the limitation of liability, indemnification and jurisdiction issues defined therein. Any holder of this document is advised that information contained hereon reflects the Company's findings at the time of its intervention only and within the limits of Client's instructions, if any. The Company's sole responsibility is to its Client and this document does not exonerate parties to a transaction from exercising all their rights and obligations under the transaction documents. This document cannot be reproduced except in full, without prior written approval of the Company. Any unauthorized alteration, forgery or falsification of the content or appearance of this document is unlawful and offenders may be prosecuted to the fullest extent of the law. Unless otherwise stated the results shown in this test report refer only to the sample(s) tested and such sample(s) are retained for 30 days only.  
Attention: To check the authenticity of testing/inspection report & certificate, please contact us at telephone: (86-755) 8307 1443, or email: [CN.Doccheck@sgs.com](mailto:CN.Doccheck@sgs.com)

No.10, Weiye Road, Innovation Park, Kunshan, Jiangsu, China 215300  
中国·江苏·昆山市留学生创业园伟业路10号 邮编 215300

t(86-512)57355888 f(86-512)57370818 www.sgsgroup.com.cn  
t(86-512)57355888 f(86-512)57370818 sgs.china@sgs.com

## 5 Equipment List

Item	Equipment	Manufacturer	Model	Serial Number	Cal Date	Cal. Due Date
RF Conducted Test						
1	Spectrum Analyzer	Agilent	E4446A	MY44020154	04/16/2021	04/15/2022
2	Spectrum Analyzer	Keysight	N9020A	MY55370209	10/11/2021	10/10/2022
3	Spectrum Analyzer	Keysight	N9010A	MY56480443	02/01/2021	01/31/2022
4	Signal Generator	Agilent	N5182A	MY50142015	08/27/2021	08/26/2022
5	Power Meter	Anritsu	ML2495A	1445010	04/15/2021	04/14/2022
6	Switcher	CCSRF	FY562	KUS2001M001-3	10/12/2021	10/11/2022
7	6dB Attenuator	Mini-Circuits	NAT-6-2W	15542-1	N.C.R	N.C.R
8	Power Divider	AI SI	IOWOPE2068	PE2068	N.C.R	N.C.R
9	Filter	MICRO-TRONICS	BRM50701	5	N.C.R	N.C.R
10	Conducted test cable	/	RF01-RF04	/	04/15/2021	04/14/2022
11	Software	BST	TST-PASS	N/A	N/A	N/A
12	Temp. / Humidity Chamber	TERCHY	MHK-120AK	X30109	04/15/2021	04/14/2022
13	Thermometer	Anymetre	TH603	CCS007	10/14/2021	10/13/2022



Unless otherwise agreed in writing, this document is issued by the Company subject to its General Conditions of Service printed overleaf, available on request or accessible at <http://www.sgs.com/en/Terms-and-Conditions.aspx> and, for electronic format documents, subject to Terms and Conditions for Electronic Documents at <http://www.sgs.com/en/Terms-and-Conditions/Terms-e-Documents.aspx>. Attention is drawn to the limitation of liability, indemnification and jurisdiction issues defined therein. Any holder of this document is advised that information contained hereon reflects the Company's findings at the time of its intervention only and within the limits of Client's instructions, if any. The Company's sole responsibility is to its Client and this document does not exonerate parties to a transaction from exercising all their rights and obligations under the transaction documents. This document cannot be reproduced except in full, without prior written approval of the Company. Any unauthorized alteration, forgery or falsification of the content or appearance of this document is unlawful and offenders may be prosecuted to the fullest extent of the law. Unless otherwise stated the results shown in this test report refer only to the sample(s) tested and such sample(s) are retained for 30 days only.

Attention: To check the authenticity of testing / inspection report & certificate, please contact us at telephone: (86-755) 8307 1443, or email: [CN.Doccheck@sgs.com](mailto:CN.Doccheck@sgs.com)

No.10, Weiye Road, Innovation Park, Kunshan, Jiangsu, China 215300

t(86-512)57355888 f(86-512)57370818 www.sgsgroup.com.cn

中国·江苏·昆山市留学生创业园伟业路10号 邮编 215300

t(86-512)57355888 f(86-512)57370818 sgs.china@sgs.com

## 6 Dynamic Frequency Selection

### 6.1 Applicability of DFS requirements

Table 1: Applicability of DFS Requirements Prior to Use of a Channel

Requirement	Operational Mode		
	<input checked="" type="checkbox"/> Master	<input type="checkbox"/> Client Without Radar Detection	<input type="checkbox"/> Client with Radar Detection
Non-Occupancy Period	Yes	Not required	Yes
DFS Detection Threshold	Yes	Not required	Yes
Channel Availability Check Time	Yes	Not required	Not required
U-NII Detection Bandwidth	Yes	Not required	Yes

Table 2: Applicability of DFS requirements during normal operation

Requirement	Operational Mode	
	<input checked="" type="checkbox"/> Master Device or Client with Radar Detection	<input type="checkbox"/> Client Without Radar Detection
DFS Detection Threshold	Yes	Not required
Channel Closing Transmission Time	Yes	Yes
Channel Move Time	Yes	Yes
U-NII Detection Bandwidth	Yes	Not required

Additional requirements for devices with multiple bandwidth modes	<input checked="" type="checkbox"/> Master Device or Client with Radar Detection	<input type="checkbox"/> Client Without Radar Detection
U-NII Detection Bandwidth and Statistical Performance Check	All BW modes must be tested	Not required
Channel Move Time and Channel Closing Transmission Time	Test using widest BW mode available	Test using the widest BW mode available for the link
All other tests	Any single BW mode	Not required

Note: Frequencies selected for statistical performance check (Section 7.8.4) should include several frequencies within the radar detection bandwidth and frequencies near the edge of the radar detection bandwidth. For 802.11 devices, it is suggested to select frequencies in each of the bonded 20 MHz channels and the channel center frequency.



Unless otherwise agreed in writing, this document is issued by the Company subject to its General Conditions of Service printed overleaf, available on request or accessible at <http://www.sgs.com/en/Terms-and-Conditions.aspx> and, for electronic format documents, subject to Terms and Conditions for Electronic Documents at <http://www.sgs.com/en/Terms-and-Conditions/Terms-e-Documents.aspx>. Attention is drawn to the limitation of liability, indemnification and jurisdiction issues defined therein. Any holder of this document is advised that information contained hereon reflects the Company's findings at the time of its intervention only and within the limits of Client's instructions, if any. The Company's sole responsibility is to its Client and this document does not exonerate parties to a transaction from exercising all their rights and obligations under the transaction documents. This document cannot be reproduced except in full, without prior written approval of the Company. Any unauthorized alteration, forgery or falsification of the content or appearance of this document is unlawful and offenders may be prosecuted to the fullest extent of the law. Unless otherwise stated the results shown in this test report refer only to the sample(s) tested and such sample(s) are retained for 30 days only.  
Attention: To check the authenticity of testing /inspection report & certificate, please contact us at telephone: (86-755) 8307 1443, or email: [CN.Doccheck@sgs.com](mailto:CN.Doccheck@sgs.com)

### 6.2 DFS Detection Thresholds

Table 3: DFS Detection Thresholds for Master Devices and Client Devices with Radar Detection

Maximum Transmit Power	Value (See Notes 1, 2, and 3)
EIRP ≥ 200 milliwatt	-64 dBm
EIRP < 200 milliwatt and power spectral density < 10 dBm/MHz	-62 dBm
EIRP < 200 milliwatt that do not meet the power spectral density requirement	-64 dBm

Note 1: This is the level at the input of the receiver assuming a 0 dBi receive antenna.  
 Note 2: Throughout these test procedures an additional 1 dB has been added to the amplitude of the test transmission waveforms to account for variations in measurement equipment. This will ensure that the test signal is at or above the detection threshold level to trigger a DFS response.  
 Note3: EIRP is based on the highest antenna gain. For MIMO devices refer to KDB Publication 662911 D01.

### 6.3 DFS Response Requirements

Table 4: DFS Response Requirement Values

Parameter	Value
Non-occupancy period	Minimum 30 minutes
Channel Availability Check Time	60 seconds
Channel Move Time	10 seconds See Note 1.
Channel Closing Transmission Time	200 milliseconds + an aggregate of 60 milliseconds over remaining 10 second period. See Notes 1 and 2.
U-NII Detection Bandwidth	Minimum 100% of the U-NII 99% transmission power bandwidth. See Note 3.

Note 1: *Channel Move Time* and the *Channel Closing Transmission Time* should be performed with Radar Type 0. The measurement timing begins at the end of the Radar Type 0 burst.  
 Note 2: The *Channel Closing Transmission Time* is comprised of 200 milliseconds starting at the beginning of the *Channel Move Time* plus any additional intermittent control signals required facilitating a *Channel* move (an aggregate of 60 milliseconds) during the remainder of the 10 second period. The aggregate duration of control signals will not count quiet periods in between transmissions.  
 Note 3: During the *U-NII Detection Bandwidth* detection test, radar type 0 should be used. For each frequency step the minimum percentage of detection is 90 percent. Measurements are performed with no data traffic.



Unless otherwise agreed in writing, this document is issued by the Company subject to its General Conditions of Service printed overleaf, available on request or accessible at <http://www.sgs.com/en/Terms-and-Conditions.aspx> and, for electronic format documents, subject to Terms and Conditions for Electronic Documents at <http://www.sgs.com/en/Terms-and-Conditions/Terms-e-Document.aspx>. Attention is drawn to the limitation of liability, indemnification and jurisdiction issues defined therein. Any holder of this document is advised that information contained hereon reflects the Company's findings at the time of its intervention only and within the limits of Client's instructions, if any. The Company's sole responsibility is to its Client and this document does not exonerate parties to a transaction from exercising all their rights and obligations under the transaction documents. This document cannot be reproduced except in full, without prior written approval of the Company. Any unauthorized alteration, forgery or falsification of the content or appearance of this document is unlawful and offenders may be prosecuted to the fullest extent of the law. Unless otherwise stated the results shown in this test report refer only to the sample(s) tested and such sample(s) are retained for 30 days only.  
 Attention: To check the authenticity of testing /inspection report & certificate, please contact us at telephone: (86-755) 8307 1443, or email: [CN.Doccheck@sgs.com](mailto:CN.Doccheck@sgs.com)  
 No.10, Weiye Road, Innovation Park, Kunshan, Jiangsu, China 215300      t(86-512)57355888      f(86-512)57370818      www.sgs.com.cn  
 中国·江苏·昆山市留学院创业园伟业路10号 邮编 215300      t(86-512)57355888      f(86-512)57370818      sgs.china@sgs.com



## 6.4 Parameters of radar test Waveforms

This section provides the parameters for required test waveforms, minimum percentage of successful detections, and the minimum number of trials that must be used for determining DFS conformance. Step intervals of 0.1 microsecond for Pulse Width, 1 microsecond for PRI, 1 MHz for chirp width and 1 for the number of pulses will be utilized for the random determination of specific test waveforms.

### 6.4.1 Short Pulse Radar Test Waveforms

Table 5 Short Pulse Radar Test Waveforms

Radar Type	Pulse Width (μsec)	PRI (μsec)	Number of Pulses	Minimum Percentage of Successful Detection	Minimum Number of Trials
0	1	1428	18	See Note 1	See Note 1
1	1	Test A	Roundup $\left\{ \left( \frac{1}{360} \right) \cdot \left( \frac{19 \cdot 10^6}{\text{PRI}_{\mu\text{sec}}} \right) \right\}$	60%	30
		Test B			
2	1-5	150-230	23-29	60%	30
3	6-10	200-500	16-18	60%	30
4	11-20	200-500	12-16	60%	30
Aggregate (Radar Types 1-4)				80%	120
<p>Note 1: Short Pulse Radar Type 0 should be used for the detection bandwidth test, channel move time, and channel closing time tests.</p> <p>Test A: 15 unique PRI values randomly selected from the list of 23 PRI values in Table 5a</p> <p>Test B: 15 unique PRI values randomly selected within the range of 518-3066 μsec, with a minimum increment of 1 μsec, excluding PRI values selected in Test A</p>					

A minimum of 30 unique waveforms are required for each of the Short Pulse Radar Types 2 through 4. If more than 30 waveforms are used for Short Pulse Radar Types 2 through 4, then each additional waveform must also be unique and not repeated from the previous waveforms. If more than 30 waveforms are used for Short Pulse Radar Type 1, then each additional waveform is generated with Test B and must also be unique and not repeated from the previous waveforms in Tests A or B.

Test aggregate is average of the percentage of successful detections of short pulse radar types 1-4



Unless otherwise agreed in writing, this document is issued by the Company subject to its General Conditions of Service printed overleaf, available on request or accessible at <http://www.sgs.com/en/Terms-and-Conditions.aspx> and, for electronic format documents, subject to Terms and Conditions for Electronic Documents at <http://www.sgs.com/en/Terms-and-Conditions/Terms-e-Documents.aspx>. Attention is drawn to the limitation of liability, indemnification and jurisdiction issues defined therein. Any holder of this document is advised that information contained hereon reflects the Company's findings at the time of its intervention only and within the limits of Client's instructions, if any. The Company's sole responsibility is to its Client and this document does not exonerate parties to a transaction from exercising all their rights and obligations under the transaction documents. This document cannot be reproduced except in full, without prior written approval of the Company. Any unauthorized alteration, forgery or falsification of the content or appearance of this document is unlawful and offenders may be prosecuted to the fullest extent of the law. Unless otherwise stated the results shown in this test report refer only to the sample(s) tested and such sample(s) are retained for 30 days only.

No.10, Weiye Road, Innovation Park, Kunshan, Jiangsu, China 215300  
中国·江苏·昆山市留学生创业园伟业路10号 邮编 215300

☎(86-512)57355888 ☎(86-512)57370818 www.sgsgroup.com.cn  
☎(86-512)57355888 ☎(86-512)57370818 sgs.china@sgs.com



Table 5a - Pulse Repetition Intervals Values for Test A

Pulse Repetition Frequency Number	Pulse Repetition Frequency (Pulses Per Second)	Pulse Repetition Interval (Microseconds)
1	1930.5	518
2	1858.7	538
3	1792.1	558
4	1730.1	578
5	1672.2	598
6	1618.1	618
7	1567.4	638
8	1519.8	658
9	1474.9	678
10	1432.7	698
11	1392.8	718
12	1355	738
13	1319.3	758
14	1285.3	778
15	1253.1	798
16	1222.5	818
17	1193.3	838
18	1165.6	858
19	1139	878
20	1113.6	898
21	1089.3	918
22	1066.1	938
23	326.2	3066



Unless otherwise agreed in writing, this document is issued by the Company subject to its General Conditions of Service printed overleaf, available on request or accessible at <http://www.sgs.com/en/Terms-and-Conditions.aspx> and, for electronic format documents, subject to Terms and Conditions for Electronic Documents at <http://www.sgs.com/en/Terms-and-Conditions/Terms-e-Documents.aspx>. Attention is drawn to the limitation of liability, indemnification and jurisdiction issues defined therein. Any holder of this document is advised that information contained hereon reflects the Company's findings at the time of its intervention only and within the limits of Client's instructions, if any. The Company's sole responsibility is to its Client and this document does not exonerate parties to a transaction from exercising all their rights and obligations under the transaction documents. This document cannot be reproduced except in full, without prior written approval of the Company. Any unauthorized alteration, forgery or falsification of the content or appearance of this document is unlawful and offenders may be prosecuted to the fullest extent of the law. Unless otherwise stated the results shown in this test report refer only to the sample(s) tested and such sample(s) are retained for 30 days only.

Attention: To check the authenticity of testing / inspection report & certificate, please contact us at telephone: (86-755) 8307 1443, or email: [CN.Doccheck@sgs.com](mailto:CN.Doccheck@sgs.com)  
 No.10, Weiye Road, Innovation Park, Kunshan, Jiangsu, China 215300      t(86-512)57355888      f(86-512)57370818      www.sgsgroup.com.cn  
 中国·江苏·昆山市留学院创业园伟业路10号 邮编 215300      t(86-512)57355888      f(86-512)57370818      sgs.china@sgs.com

6.4.2 Long Pulse Radar Test Waveform

Table 6 - Long Pulse Radar Test Waveform

Radar Type	Pulse Width (µsec)	Chirp Width (MHz)	PRI (µsec)	Number of Pulses per Burst	Number of Bursts	Minimum Percentage of Successful Detection	Minimum Number of Trials
5	50-100	5-20	1000-2000	1-3	8-20	80%	30

The parameters for this waveform are randomly chosen. Thirty unique waveforms are required for the Long Pulse Radar Type waveforms. If more than 30 waveforms are used for the Long Pulse Radar Type waveforms, then each additional waveform must also be unique and not repeated from the previous waveforms.

Each waveform is defined as follows:

- 1) The transmission period for the Long Pulse Radar test signal is 12 seconds.
- 2) There are a total of 8 to 20 Bursts in the 12 second period, with the number of Bursts being randomly chosen. This number is Burst Count.
- 3) Each Burst consists of 1 to 3 pulses, with the number of pulses being randomly chosen. Each Burst within the 12 second sequence may have a different number of pulses.
- 4) The pulse width is between 50 and 100 microseconds, with the pulse width being randomly chosen. Each pulse within a Burst will have the same pulse width. Pulses in different Bursts may have different pulse widths.
- 5) Each pulse has a linear frequency modulated chirp between 5 and 20 MHz, with the chirp width being randomly chosen. Each pulse within a transmission period will have the same chirp width. The chirp is centered on the pulse. For example, with a radar frequency of 5300 MHz and a 20 MHz chirped signal, the chirp starts at 5290 MHz and ends at 5310 MHz.
- 6) If more than one pulse is present in a Burst, the time between the pulses will be between 1000 and 2000 microseconds, with the time being randomly chosen. If three pulses are present in a Burst, the random time interval between the first and second pulses is chosen independently of the random time interval between the second and third pulses.
- 7) The 12 second transmission period is divided into even intervals. The number of intervals is equal to Burst Count. Each interval is of length  $(12,000,000 / \text{Burst Count})$  microseconds. Each interval contains one Burst. The start time for the Burst, relative to the beginning of the interval, is between 1 and  $[(12,000,000 / \text{Burst Count}) - (\text{Total Burst Length}) + (\text{One Random PRI Interval})]$  microseconds, with the start time being randomly chosen. The step interval for the start time is 1 microsecond. The start time for each Burst is chosen randomly.

**A representative example of a Long Pulse Radar Type waveform:**

- 1) The total test waveform length is 12 seconds.
- 2) Eight (8) Bursts are randomly generated for the Burst Count.
- 3) Burst 1 has 2 randomly generated pulses.
- 4) The pulse width (for both pulses) is randomly selected to be 75 microseconds.
- 5) The PRI is randomly selected to be at 1213 microseconds.
- 6) Bursts 2 through 8 are generated using steps 3 - 5.
- 7) Each Burst is contained in even intervals of 1,500,000 microseconds. The starting location for Pulse 1, Burst 1 is randomly generated (1 to 1,500,000 minus the total Burst 1 length + 1 random PRI interval) at the 325,001 microsecond step. Bursts 2 through 8 randomly fall in successive 1,500,000 microsecond intervals (i.e. Burst 2 falls in the 1,500,001 – 3,000,000 microsecond range).



Unless otherwise agreed in writing, this document is issued by the Company subject to its General Conditions of Service printed overleaf, available on request or accessible at <http://www.sgs.com/en/Terms-and-Conditions.aspx> and, for electronic format documents, subject to Terms and Conditions for Electronic Documents at <http://www.sgs.com/en/Terms-and-Conditions/Terms-e-Document.aspx>. Attention is drawn to the limitation of liability, indemnification and jurisdiction issues defined therein. Any holder of this document is advised that information contained herein reflects the Company's findings at the time of its intervention only and within the limits of Client's instructions, if any. The Company's sole responsibility is to its Client and this document does not exonerate parties to a transaction from exercising all their rights and obligations under the transaction documents. This document cannot be reproduced except in full, without prior written approval of the Company. Any unauthorized alteration, forgery or falsification of the content or appearance of this document is unlawful and offenders may be prosecuted to the fullest extent of the law. Unless otherwise stated the results shown in this test report refer only to the sample(s) tested and such sample(s) are retained for 30 days only.  
Attention: To check the authenticity of testing / inspection report & certificate, please contact us at telephone: (86-755) 8307 1443, or email: [CN.Doccheck@sgs.com](mailto:CN.Doccheck@sgs.com)  
No.10, Weiye Road, Innovation Park, Kunshan, Jiangsu, China 215300  
中国·江苏·昆山市留学院创业园伟业路10号 邮编 215300

(86-512)57355888 (86-512)57370818 www.sgs.com.cn  
(86-512)57355888 (86-512)57370818 sgs.china@sgs.com

**6.4.3 Frequency Hopping Radar Test Waveform**

Table 7 - Frequency Hopping Radar Test Waveform

Type	Pulse Width (μsec)	PRI (μsec)	Pulses per Hop	Hopping Rate (kHz)	Hopping Sequence Length (msec)	Minimum Percentage of Successful Detection	Minimum Number of Trials
6	1	333	9	0.333	300	70%	30

For the Frequency Hopping Radar Type, the same Burst parameters are used for each waveform. The hopping sequence is different for each waveform and a 100-length segment is selected from the hopping sequence defined by the following algorithm:

The first frequency in a hopping sequence is selected randomly from the group of 475 integer frequencies from 5250 - 5724 MHz. Next, the frequency that was just chosen is removed from the group and a frequency is randomly selected from the remaining 474 frequencies in the group. This process continues until all 475 frequencies are chosen for the set. For selection of a random frequency, the frequencies remaining within the group are always treated as equally likely.



Unless otherwise agreed in writing, this document is issued by the Company subject to its General Conditions of Service printed overleaf, available on request or accessible at <http://www.sgs.com/en/Terms-and-Conditions.aspx> and, for electronic format documents, subject to Terms and Conditions for Electronic Documents at <http://www.sgs.com/en/Terms-and-Conditions/Terms-e-Documents.aspx>. Attention is drawn to the limitation of liability, indemnification and jurisdiction issues defined therein. Any holder of this document is advised that information contained hereon reflects the Company's findings at the time of its intervention only and within the limits of Client's instructions, if any. The Company's sole responsibility is to its Client and this document does not exonerate parties to a transaction from exercising all their rights and obligations under the transaction documents. This document cannot be reproduced except in full, without prior written approval of the Company. Any unauthorized alteration, forgery or falsification of the content or appearance of this document is unlawful and offenders may be prosecuted to the fullest extent of the law. Unless otherwise stated the results shown in this test report refer only to the sample(s) tested and such sample(s) are retained for 30 days only.  
Attention: To check the authenticity of testing /inspection report & certificate, please contact us at telephone: (86-755) 8307 1443, or email: [CN.Doccheck@sgs.com](mailto:CN.Doccheck@sgs.com)

## 6.5 Calibration of Radar Waveform

### 6.5.1 Radar Waveform Calibration Procedure

1. Description of calibration setup
  - a. Block diagram of equipment setup, clearly identifying if a radiated or conducted method was used.
2. Description of calibration procedure
  - a. Verify DFS Detection Threshold levels
    - i. Indicate DFS Detection Threshold levels used.
    - ii. Consider output power range and antenna gain.
  - b. For the Short Pulse Radar Types, spectrum analyzer plots of the burst of pulses on the Channel frequency should be provided.
  - c. For the Long Pulse Radar Type, spectrum analyzer plot of a single burst (1-3 pulses) on the Channel frequency should be provided.
  - d. Describe method used to generate frequency hopping signal.
  - e. The U-NII Detection Bandwidth
  - f. For the Frequency Hopping waveform, a spectrum analyzer plot showing 9 pulses on one frequency within the U-NII Detection Bandwidth should be provided.
  - g. Verify use of vertical polarization for testing when using a radiated test method.
3. When testing a Client Device with radar detection capability, verify that the Client Device is responding independently based on the Client Device's self-detection rather than responding to the Master Device. If required, provide a description of the method used to isolate the client from the transmissions from the Master Device to ensure Client Device self detection of the Radar Waveform.

### 6.5.2 Conducted Calibration Setup

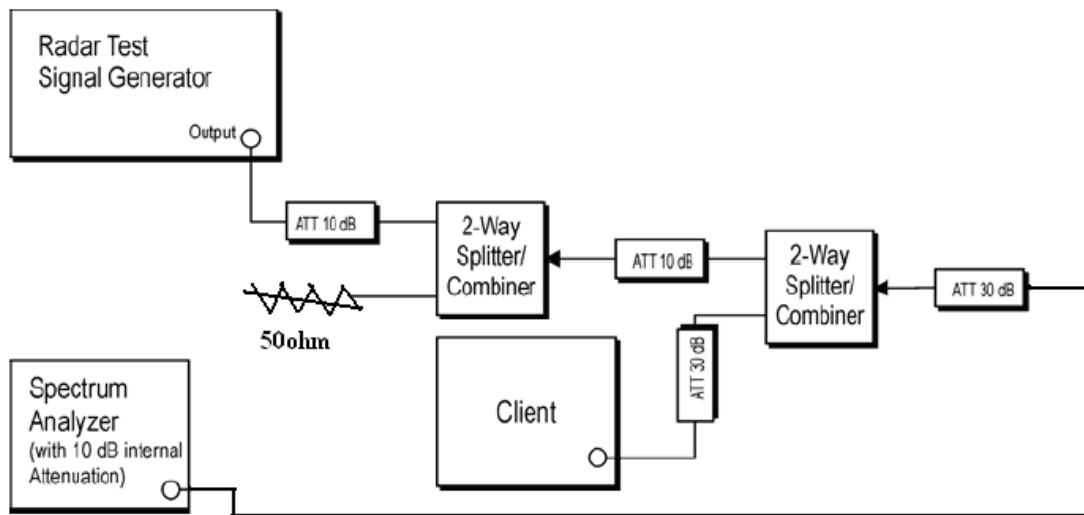

Remark: During the test, a lower radar signal level -62dBm was used.





## 6.6 Channel Loading

System testing will be performed with channel-loading using means appropriate to the data types that are used by the unlicensed device. The following requirements apply:

<input type="checkbox"/>	a) The data file must be of a type that is typical for the device (i.e., MPEG-2, MPEG-4, WAV, MP3, MP4, AVI, etc.) and must generally be transmitting in a streaming mode.
<input type="checkbox"/>	b) Software to ping the client is permitted to simulate data transfer but must have random ping intervals.
<input checked="" type="checkbox"/>	c) Timing plots are required with calculations demonstrating a minimum channel loading of approximately 17% or greater. For example, channel loading can be estimated by setting the spectrum analyzer for zero span and approximate the Time On/ (Time On + Off Time). This can be done with any appropriate channel BW and modulation type.
<input type="checkbox"/>	d) Unicast or Multicast protocols are preferable but other protocols may be used. The appropriate protocol used must be described in the test procedures.

## 6.7 Test Procedure

### 6.7.1 U-NII Detection Bandwidth

Set up the generating equipment as shown in Figure 1, or equivalent. Set up the DFS timing monitoring equipment as shown in Figure 1. Set up the overall system for either radiated or conducted coupling to the UUT.

Adjust the equipment to produce a single Burst of the Short Pulse Radar Type 1 at the center frequency of the UUT Operating Channel at the specified DFS Detection Threshold level.

Set the UUT up as a standalone device (no associated Client or Master, as appropriate) and no traffic. Frame based systems will be set to a talk/listen ratio of 0%/100% during this test. Generate a single radar Burst and note the response of the UUT. Repeat for a minimum of 10 trials. The UUT must detect the Radar Waveform using the specified U-NII Detection Bandwidth criterion.

Starting at the center frequency of the UUT operating Channel, increase the radar frequency in 1 MHz steps, repeating the above test sequence, until the detection rate falls below the U-NII Detection Bandwidth criterion. Record the highest frequency (denote as FH) at which detection is greater than or equal to the U-NII Detection Bandwidth criterion. Recording the detection rate at frequencies above FH is not required to demonstrate compliance.

Starting at the center frequency of the UUT operating Channel, decrease the radar frequency in 1 MHz steps, repeating the above test sequence, until the detection rate falls below the U-NII Detection Bandwidth criterion specified in Table 4. Record the lowest frequency (denote as FL) at which detection is greater than or equal to the U-NII Detection Bandwidth criterion. Recording the detection rate at frequencies below FL is not required to demonstrate compliance. The U-NII Detection Bandwidth is calculated as follows:

$$U-NII\ Detection\ Bandwidth = FH - FL$$

The U-NII Detection Bandwidth must meet the U-NII Detection Bandwidth criterion. Otherwise, the UUT does not comply with DFS requirements. This is essential to ensure that the UUT is capable of detecting Radar Waveforms across the same frequency spectrum that contains the significant energy from the system. In the case that the U-NII Detection Bandwidth is greater than or equal to the 99 percent power bandwidth for the measured FH and FL, the test can be truncated and the U-NII Detection Bandwidth can be reported as the measured FH and FL.

### 6.7.2 Channel Availability Check

The Initial Channel Availability Check Time tests that the UUT does not emit beacon, control, or data signals on the test Channel until the power-up sequence has been completed and the U-NII device



Unless otherwise agreed in writing, this document is issued by the Company subject to its General Conditions of Service printed overleaf, available on request or accessible at <http://www.sgs.com/en/Terms-and-Conditions.aspx> and, for electronic format documents, subject to Terms and Conditions for Electronic Documents at <http://www.sgs.com/en/Terms-and-Conditions/Terms-e-Documents.aspx>. Attention is drawn to the limitation of liability, indemnification and jurisdiction issues defined therein. Any holder of this document is advised that information contained hereon reflects the Company's findings at the time of its intervention only and within the limits of Client's instructions, if any. The Company's sole responsibility is to its Client and this document does not exonerate parties to a transaction from exercising all their rights and obligations under the transaction documents. This document cannot be reproduced except in full, without prior written approval of the Company. Any unauthorized alteration, forgery or falsification of the content or appearance of this document is unlawful and offenders may be prosecuted to the fullest extent of the law. Unless otherwise stated the results shown in this test report refer only to the sample(s) tested and such sample(s) are retained for 30 days only.

No.10, Weiye Road, Innovation Park, Kunshan, Jiangsu, China 215300  
中国·江苏·昆山市留学院创业园伟业路10号 邮编 215300

t(86-512)57355888 f(86-512)57370818 www.sgs.com.cn  
t(86-512)57355888 f(86-512)57370818 sgs.china@sgs.com



checks for Radar Waveforms for one minute on the test Channel. This test does not use any Radar Waveforms and only needs to be performed one time.

a) The U-NII devices will be powered on and be instructed to operate on the appropriate U-NII Channel that must incorporate DFS functions. At the same time the UUT is powered on, the spectrum analyzer will be set to zero span modes with a 3 MHz RBW and 3 MHz VBW on the Channel occupied by the radar (Chr) with a 2.5 minute sweep time. The spectrum analyzer's sweep will be started at the same time power is applied to the U-NII device.

b) The UUT should not transmit any beacon or data transmissions until at least 1 minute after the completion of the power-on cycle. This measurement can be used to determine the length of the power-on cycle if it is not supplied by the manufacturer. If the spectrum analyzer sweep is started at the same time the UUT is powered on and the UUT does not begin transmissions until it has completed the cycle, the power-on time can be determined

by comparing the two times.

### 6.7.3 Radar Burst at the Beginning of the Channel Availability Check Time

The steps below define the procedure to verify successful radar detection on the test Channel during a period equal to the Channel Availability Check Time and avoidance of operation on that Channel when a radar Burst with a level equal to the DFS Detection Threshold + 1 dB occurs at the beginning of the Channel Availability Check Time. This is illustrated as shown below.

a) The Radar Waveform generator and UUT are connected using the applicable test setup described in the sections on configuration for Conducted Tests (7.2) or Radiated Tests (7.3) and the power of the UUT is switched off.

b) The UUT is powered on at T0. T1 denotes the instant when the UUT has completed its power-up sequence (T<sub>power\_up</sub>). The Channel Availability Check Time commences on Chr at instant T1 and will end no sooner than T1 + T<sub>ch\_avail\_check</sub>.

c) A single Burst of one of the Short Pulse Radar Types 1-4 will commence within a 6 second window starting at T1. An additional 1 dB is added to the radar test signal to ensure it is at or above the DFS Detection Threshold, accounting for equipment variations/errors.

d) Visual indication or measured results on the UUT of successful detection of the radar Burst will be recorded and reported. Observation of Chr for UUT emissions will continue for 2.5 minutes after the radar Burst has been generated.

e) Verify that during the 2.5 minute measurement window no UUT transmissions occurred on Chr. The Channel Availability Check results will be recorded.



Unless otherwise agreed in writing, this document is issued by the Company subject to its General Conditions of Service printed overleaf, available on request or accessible at <http://www.sgs.com/en/Terms-and-Conditions.aspx> and, for electronic format documents, subject to Terms and Conditions for Electronic Documents at <http://www.sgs.com/en/Terms-and-Conditions/Terms-e-Document.aspx>. Attention is drawn to the limitation of liability, indemnification and jurisdiction issues defined therein. Any holder of this document is advised that information contained hereon reflects the Company's findings at the time of its intervention only and within the limits of Client's instructions, if any. The Company's sole responsibility is to its Client and this document does not exonerate parties to a transaction from exercising all their rights and obligations under the transaction documents. This document cannot be reproduced except in full, without prior written approval of the Company. Any unauthorized alteration, forgery or falsification of the content or appearance of this document is unlawful and offenders may be prosecuted to the fullest extent of the law. Unless otherwise stated the results shown in this test report refer only to the sample(s) tested and such sample(s) are retained for 30 days only.  
 Attention: To check the authenticity of testing /inspection report & certificate, please contact us at telephone: (86-755) 8307 1443, or email: [CN.Doccheck@sgs.com](mailto:CN.Doccheck@sgs.com)

No.10, Weiye Road, Innovation Park, Kunshan, Jiangsu, China 215300  
 中国·江苏·昆山市留学生创业园伟业路10号 邮编 215300

t(86-512)57355888 f(86-512)57370818 www.sgsgroup.com.cn  
 t(86-512)57355888 f(86-512)57370818 sgs.china@sgs.com

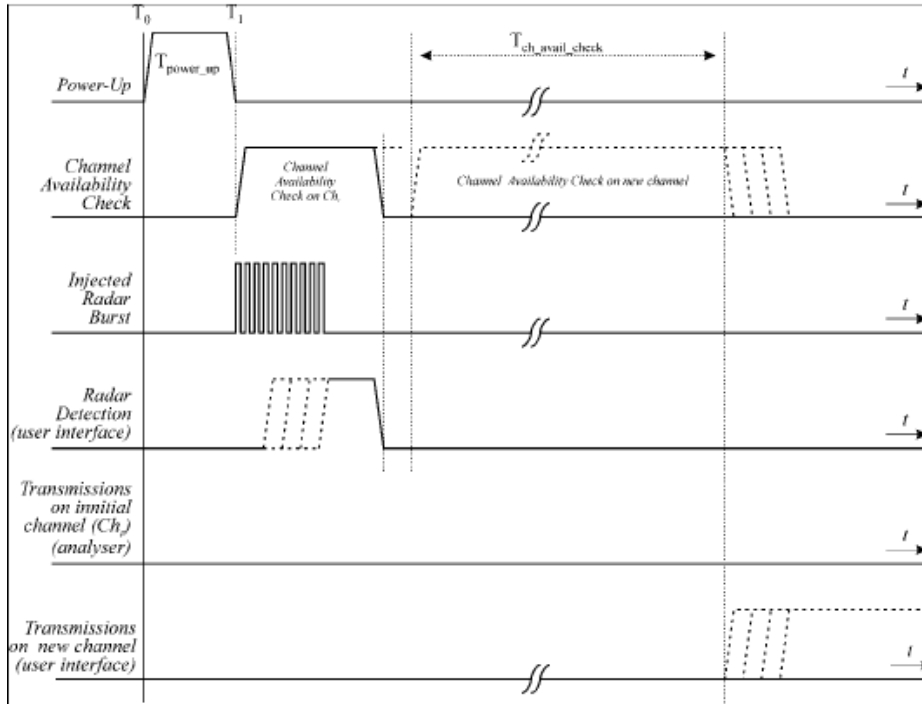

### 6.7.4 Radar Burst at the End of the Channel Availability Check Time

The steps below define the procedure to verify successful radar detection on the test Channel during a period equal to the Channel Availability Check Time and avoidance of operation on that Channel when a radar Burst with a level equal to the DFS Detection Threshold + 1dB occurs at the end of the Channel Availability Check Time. This is illustrated as shown below.

- The Radar Waveform generator and UUT are connected using the applicable test setup described in the sections for Conducted Tests (7.2) or Radiated Tests (7.3) and the power of the UUT is switched off.
- The UUT is powered on at  $T_0$ .  $T_1$  denotes the instant when the UUT has completed its power-up sequence ( $T_{power\_up}$ ). The Channel Availability Check Time commences on  $Ch_1$  at instant  $T_1$  and will end no sooner than  $T_1 + T_{ch\_avail\_check}$ .
- A single Burst of one of the Short Pulse Radar Types 1-4 will commence within a 6 second window starting at  $T_1 + 54$  seconds. An additional 1 dB is added to the radar test signal to ensure it is at or above the DFS Detection Threshold, accounting for equipment variations/errors.
- Visual indication or measured results on the UUT of successful detection of the radar Burst will be recorded and reported. Observation of  $Ch_1$  for UUT emissions will continue for 2.5 minutes after the radar Burst has been generated.
- Verify that during the 2.5 minute measurement window no UUT transmissions occurred on  $Ch_1$ . The Channel Availability Check results will be recorded.



Unless otherwise agreed in writing, this document is issued by the Company subject to its General Conditions of Service printed overleaf, available on request or accessible at <http://www.sgs.com/en/Terms-and-Conditions.aspx> and, for electronic format documents, subject to Terms and Conditions for Electronic Documents at <http://www.sgs.com/en/Terms-and-Conditions/Terms-e-Documents.aspx>. Attention is drawn to the limitation of liability, indemnification and jurisdiction issues defined therein. Any holder of this document is advised that information contained hereon reflects the Company's findings at the time of its intervention only and within the limits of Client's instructions, if any. The Company's sole responsibility is to its Client and this document does not exonerate parties to a transaction from exercising all their rights and obligations under the transaction documents. This document cannot be reproduced except in full, without prior written approval of the Company. Any unauthorized alteration, forgery or falsification of the content or appearance of this document is unlawful and offenders may be prosecuted to the fullest extent of the law. Unless otherwise stated the results shown in this test report refer only to the sample(s) tested and such sample(s) are retained for 30 days only.  
Attention: To check the authenticity of testing / inspection report & certificate, please contact us at telephone: (86-755) 8307 1443, or email: [CN.Doccheck@sgs.com](mailto:CN.Doccheck@sgs.com)

No.10, Weiye Road, Innovation Park, Kunshan, Jiangsu, China 215300  
中国·江苏·昆山市留学院创业园伟业路10号 邮编 215300

(86-512)57355888 (86-512)57370818 www.sgs.com.cn  
(86-512)57355888 (86-512)57370818 sgs.china@sgs.com

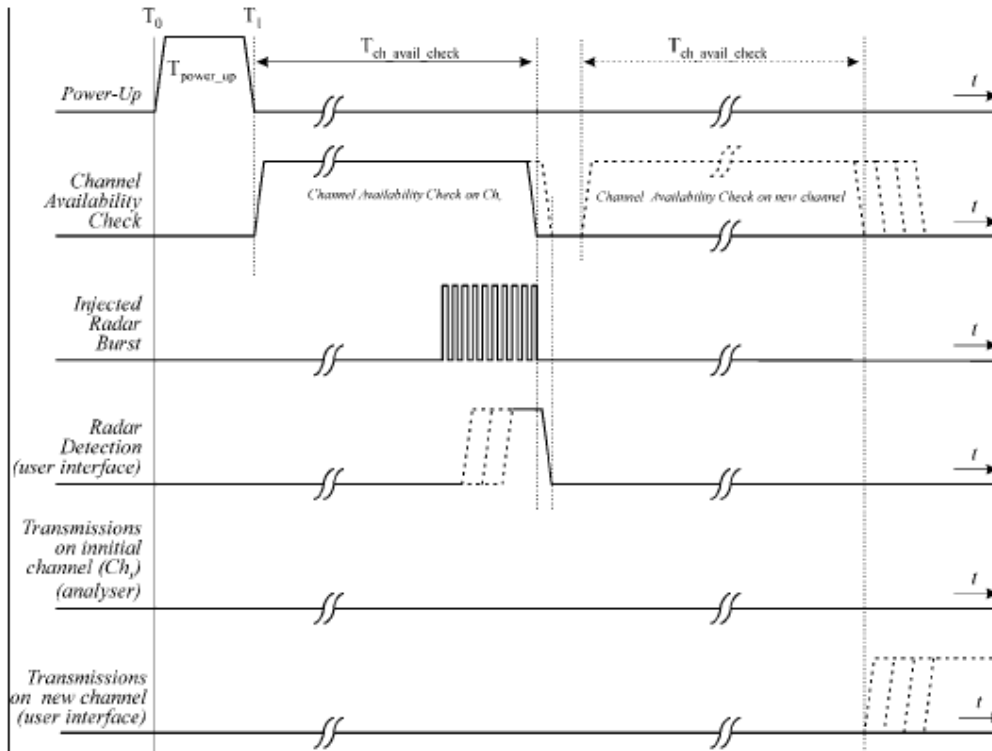

### 6.7.5 In-Service Monitoring for Channel Move Time, Channel Closing Transmission Time and Non-Occupancy Period

These tests define how the following DFS parameters are verified during In-Service Monitoring;

- Channel Closing Transmission Time
- Channel Move Time
- Non-Occupancy Period

The steps below define the procedure to determine the above mentioned parameters when a radar Burst with a level equal to the DFS Detection Threshold + 1dB is generated on the Operating Channel of the UUT device (In- Service Monitoring).

- a) One frequency will be chosen from the Operating Channels of the UUT within the 5250-5350 MHz or 5470-5725 MHz bands.
- b) In case the UUT is a U-NII device operating as a Client Device (with or without DFS), a UNII device operating as a Master Device will be used to allow the UUT (Client device) to Associate with the Master Device. In case the UUT is a Master Device, a U-NII device operating as a Client Device will be used and it is assumed that the Client will associate with the UUT (Master). In both cases for conducted tests, the Radar Waveform generator will be connected to the Master Device. For radiated tests, the emissions of the Radar Waveform generator will be directed towards the Master Device. If the Master Device has antenna gain, the main beam of the antenna will be directed toward the radar emitter. Vertical polarization is used for testing.
- c) Stream the MPEG test file from the Master Device to the Client Device on the test Channel for the entire period of the test.
- d) At time T0 the Radar Waveform generator sends a Burst of pulses for one of the Short Pulse Radar Types 1-4, on the Operating Channel. An additional 1 dB is added to the radar test signal to ensure it is at or above the DFS Detection Threshold, accounting for equipment variations/errors.



Unless otherwise agreed in writing, this document is issued by the Company subject to its General Conditions of Service printed overleaf, available on request or accessible at <http://www.sgs.com/en/Terms-and-Conditions.aspx> and, for electronic format documents, subject to Terms and Conditions for Electronic Documents at <http://www.sgs.com/en/Terms-and-Conditions/Terms-e-Documents.aspx>. Attention is drawn to the limitation of liability, indemnification and jurisdiction issues defined therein. Any holder of this document is advised that information contained hereon reflects the Company's findings at the time of its intervention only and within the limits of Client's instructions, if any. The Company's sole responsibility is to its Client and this document does not exonerate parties to a transaction from exercising all their rights and obligations under the transaction documents. This document cannot be reproduced except in full, without prior written approval of the Company. Any unauthorized alteration, forgery or falsification of the content or appearance of this document is unlawful and offenders may be prosecuted to the fullest extent of the law. Unless otherwise stated the results shown in this test report refer only to the sample(s) tested and such sample(s) are retained for 30 days only.  
Attention: To check the authenticity of testing /inspection report & certificate, please contact us at telephone: (86-755) 8307 1443, or email: [CN\\_Doccheck@sgs.com](mailto:CN_Doccheck@sgs.com)  
No.10, Weiye Road, Innovation Park, Kunshan, Jiangsu, China 215300  
中国·江苏·昆山市留学院创业园伟业路10号 邮编 215300

e) Observe the transmissions of the UUT at the end of the radar Burst on the Operating Channel for duration greater than 10 seconds. Measure and record the transmissions from the UUT during the observation time (Channel Move Time). Measure and record the Channel Move Time and Channel Closing Transmission Time if radar detection occurs. Figure shown below illustrates Channel Closing Transmission Time.

f) When operating as a Master Device, monitor the UUT for more than 30 minutes following instant T<sub>2</sub> to verify that the UUT does not resume any transmissions on this Channel. Perform this test once and record the measurement result.

g) In case the UUT is U-NII device operating as Client Device with In-Service Monitoring, perform steps a) to f).

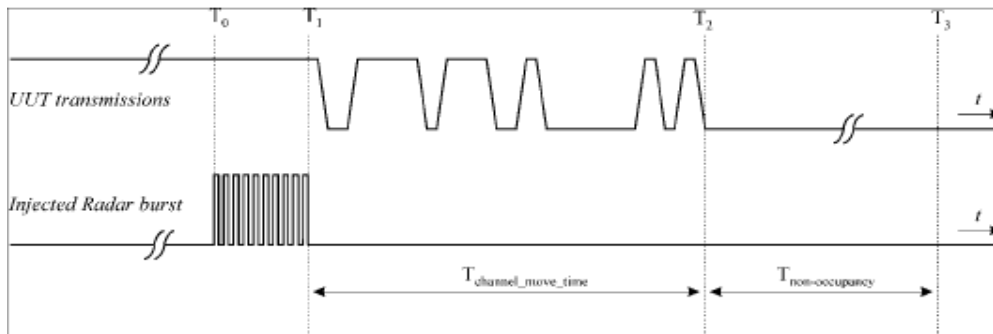

### 6.7.6 Statistical Performance Check

The steps below define the procedure to determine the minimum percentage of successful detection requirements when a radar burst with a level equal to the DFS Detection Threshold + 1dB is generated on the Operating Channel of the U-NII device (In-Service Monitoring).

a) One frequency will be chosen from the Operating Channels of the UUT within the 5250-5350 MHz or 5470-5725 MHz bands.

b) In case the UUT is a U-NII device operating as a Client Device (with or without Radar Detection), a U-NII device operating as a Master Device will be used to allow the UUT (Client device) to Associate with the Master Device. In case the UUT is a Master Device, a U-NII device operating as a Client Device will be used and it is assumed that the Client will associate with the UUT (Master). In both cases for conducted tests, the Radar Waveform generator will be connected to the Master Device. For radiated tests, the emissions of the Radar Waveform generator will be directed towards the Master Device. If the Master Device has antenna gain, the main beam of the antenna will be directed toward the radar emitter. Vertical polarization is used for testing.

c) Stream the MPEG test file from the Master Device to the Client Device on the test Channel for the entire period of the test.

d) At time T<sub>0</sub> the Radar Waveform generator sends the individual waveform for each of the Radar Types 1-6, at levels defined shown above, on the Operating Channel. An additional 1 dB is added to the radar test signal to ensure it is at or above the DFS Detection Threshold, accounting for equipment variations/errors.

e) Observe the transmissions of the UUT at the end of the Burst on the Operating Channel for duration greater than 10 seconds for Short Pulse Radar Types 1-4 and 6 to ensure detection occurs.

f) Observe the transmissions of the UUT at the end of the Burst on the Operating Channel for duration greater than 22 seconds for Long Pulse Radar Type 5 to ensure detection occurs.

g) In case the UUT is a U-NII device operating as a Client Device with In-Service Monitoring, perform steps a) to f).



Unless otherwise agreed in writing, this document is issued by the Company subject to its General Conditions of Service printed overleaf, available on request or accessible at <http://www.sgs.com/en/Terms-and-Conditions.aspx> and, for electronic format documents, subject to Terms and Conditions for Electronic Documents at <http://www.sgs.com/en/Terms-and-Conditions/Terms-e-Documents.aspx>. Attention is drawn to the limitation of liability, indemnification and jurisdiction issues defined therein. Any holder of this document is advised that information contained hereon reflects the Company's findings at the time of its intervention only and within the limits of Client's instructions, if any. The Company's sole responsibility is to its Client and this document does not exonerate parties to a transaction from exercising all their rights and obligations under the transaction documents. This document cannot be reproduced except in full, without prior written approval of the Company. Any unauthorized alteration, forgery or falsification of the content or appearance of this document is unlawful and offenders may be prosecuted to the fullest extent of the law. Unless otherwise stated the results shown in this test report refer only to the sample(s) tested and such sample(s) are retained for 30 days only.  
Attention: To check the authenticity of testing / inspection report & certificate, please contact us at telephone: (86-755) 8307 1443, or email: [CN.Doccheck@sgs.com](mailto:CN.Doccheck@sgs.com)

No.10, Weiye Road, Innovation Park, Kunshan, Jiangsu, China 215300  
中国·江苏·昆山市留学院创业园伟业路10号 邮编 215300

t(86-512)57355888 f(86-512)57370818 www.sgs.com.cn  
t(86-512)57355888 f(86-512)57370818 sgs.china@sgs.com



6.8 Test Setup

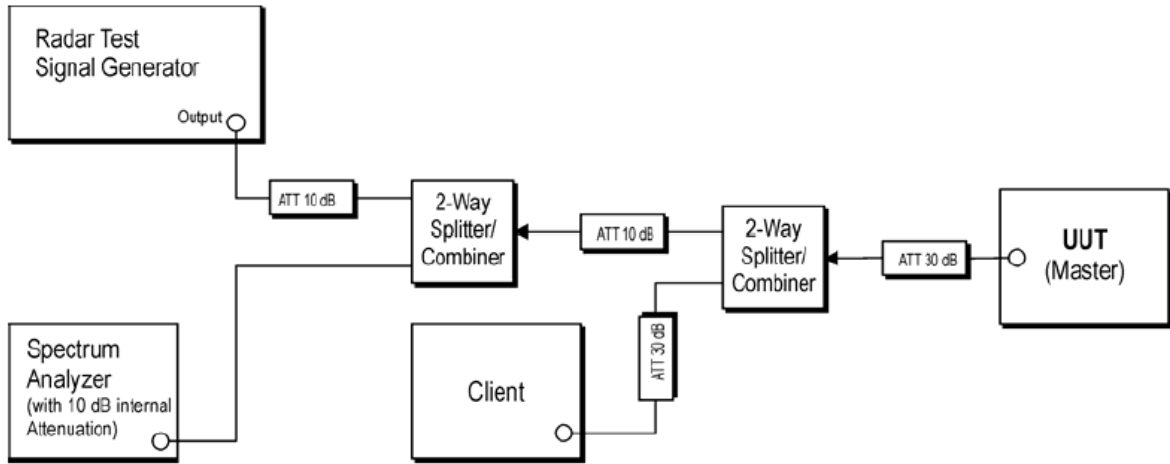

Unless otherwise agreed in writing, this document is issued by the Company subject to its General Conditions of Service printed overleaf, available on request or accessible at <http://www.sgs.com/en/Terms-and-Conditions.aspx> and, for electronic format documents, subject to Terms and Conditions for Electronic Documents at <http://www.sgs.com/en/Terms-and-Conditions/Terms-e-Documents.aspx>. Attention is drawn to the limitation of liability, indemnification and jurisdiction issues defined therein. Any holder of this document is advised that information contained hereon reflects the Company's findings at the time of its intervention only and within the limits of Client's instructions, if any. The Company's sole responsibility is to its Client and this document does not exonerate parties to a transaction from exercising all their rights and obligations under the transaction documents. This document cannot be reproduced except in full, without prior written approval of the Company. Any unauthorized alteration, forgery or falsification of the content or appearance of this document is unlawful and offenders may be prosecuted to the fullest extent of the law. Unless otherwise stated the results shown in this test report refer only to the sample(s) tested and such sample(s) are retained for 30 days only.

Attention: To check the authenticity of testing /inspection report & certificate, please contact us at telephone: (86-755) 8307 1443, or email: [CN.Doccheck@sgs.com](mailto:CN.Doccheck@sgs.com)  
 No.10, Weiye Road, Innovation Park, Kunshan, Jiangsu, China 215300      t(86-512)57355888      f(86-512)57370818      www.sgs.com.cn  
 中国·江苏·昆山市留学院创业园伟业路10号 邮编 215300      t(86-512)57355888      f(86-512)57370818      sgs.china@sgs.com



## 6.9 Test Result

### 6.9.1 Radar Waveform Calibration Result

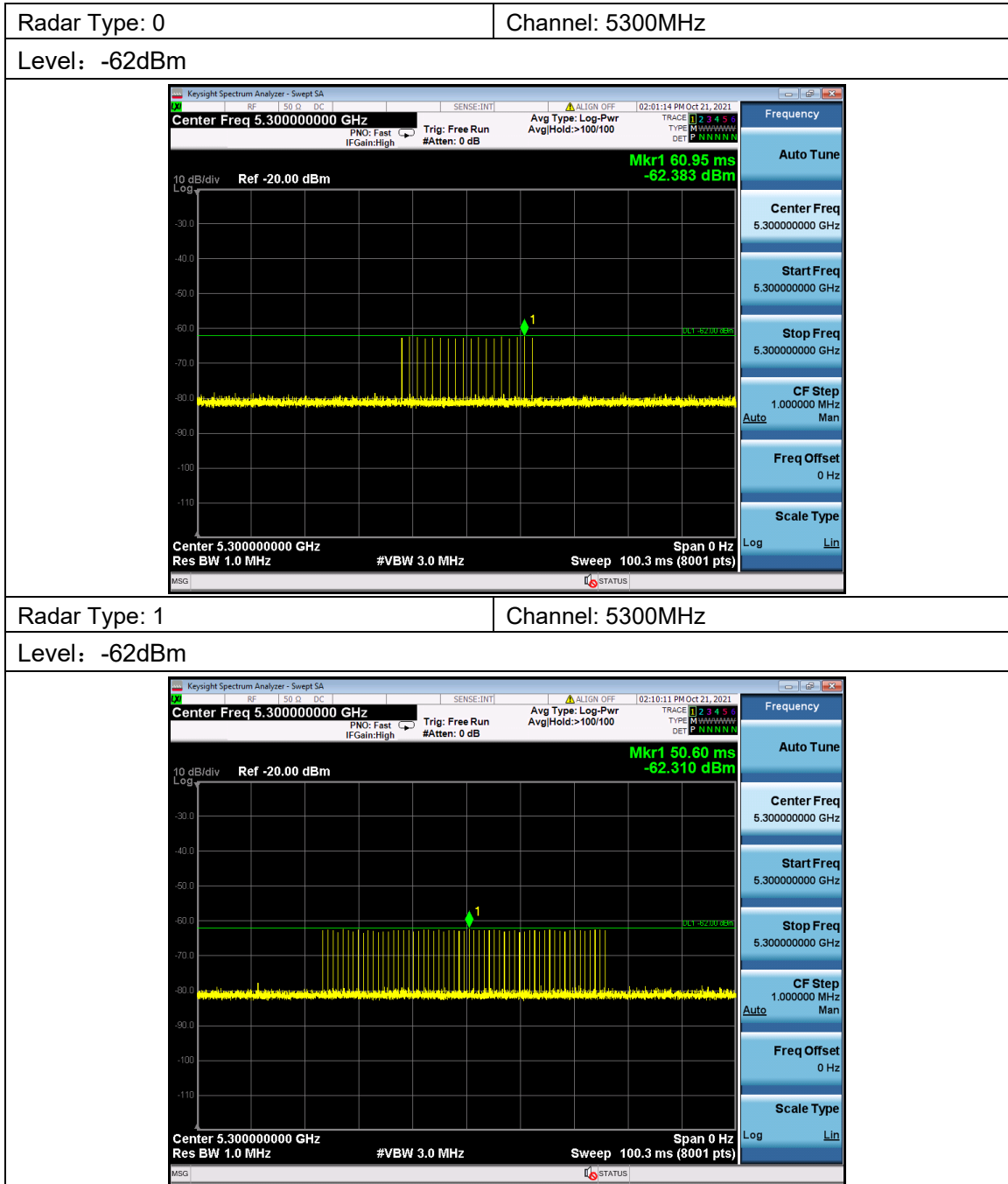

Unless otherwise agreed in writing, this document is issued by the Company subject to its General Conditions of Service printed overleaf, available on request or accessible at <http://www.sgs.com/en/Terms-and-Conditions.aspx> and, for electronic format documents, subject to Terms and Conditions for Electronic Documents at <http://www.sgs.com/en/Terms-and-Conditions/Terms-e-Documents.aspx>. Attention is drawn to the limitation of liability, indemnification and jurisdiction issues defined therein. Any holder of this document is advised that information contained hereon reflects the Company's findings at the time of its intervention only and within the limits of Client's instructions, if any. The Company's sole responsibility is to its Client and this document does not exonerate parties to a transaction from exercising all their rights and obligations under the transaction documents. This document cannot be reproduced except in full, without prior written approval of the Company. Any unauthorized alteration, forgery or falsification of the content or appearance of this document is unlawful and offenders may be prosecuted to the fullest extent of the law. Unless otherwise stated the results shown in this test report refer only to the sample(s) tested and such sample(s) are retained for 30 days only.

Attention: To check the authenticity of testing /inspection report & certificate, please contact us at telephone: (86-755) 8307 1443, or email: [CN\\_Doccheck@sgs.com](mailto:CN_Doccheck@sgs.com)

No.10, Weiye Road, Innovation Park, Kunshan, Jiangsu, China 215300      t(86-512)57355888      f(86-512)57370818      www.sgs.com.cn  
 中国·江苏·昆山市留学生创业园伟业路10号 邮编 215300      t(86-512)57355888      f(86-512)57370818      sgs.china@sgs.com

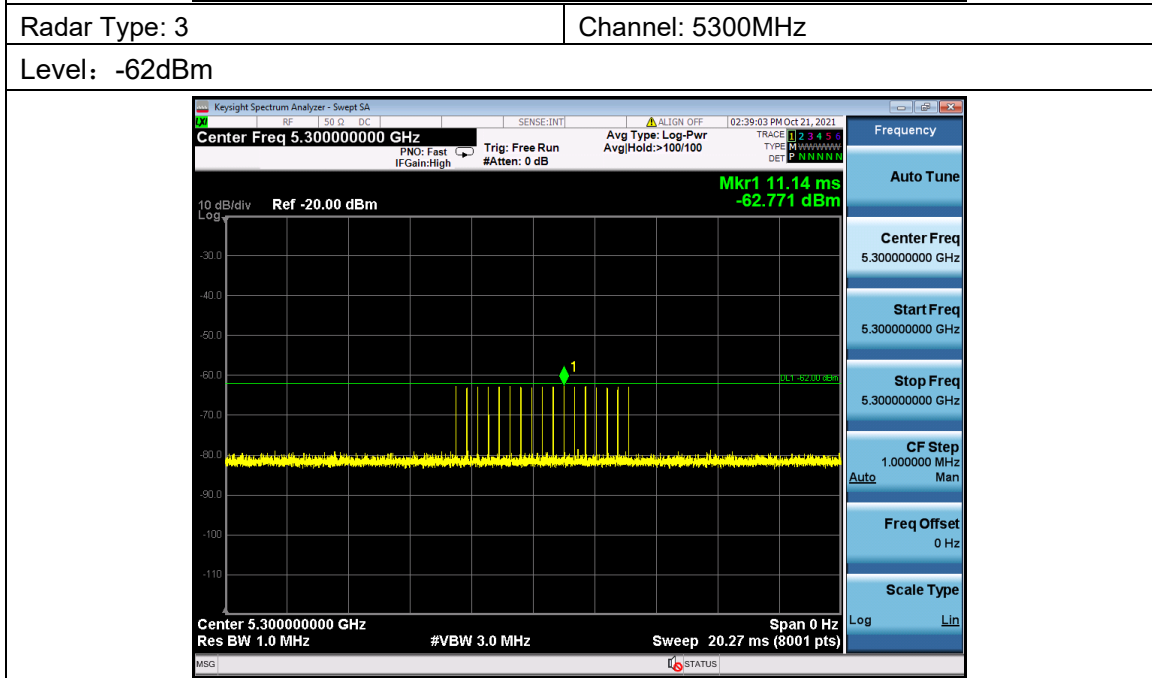
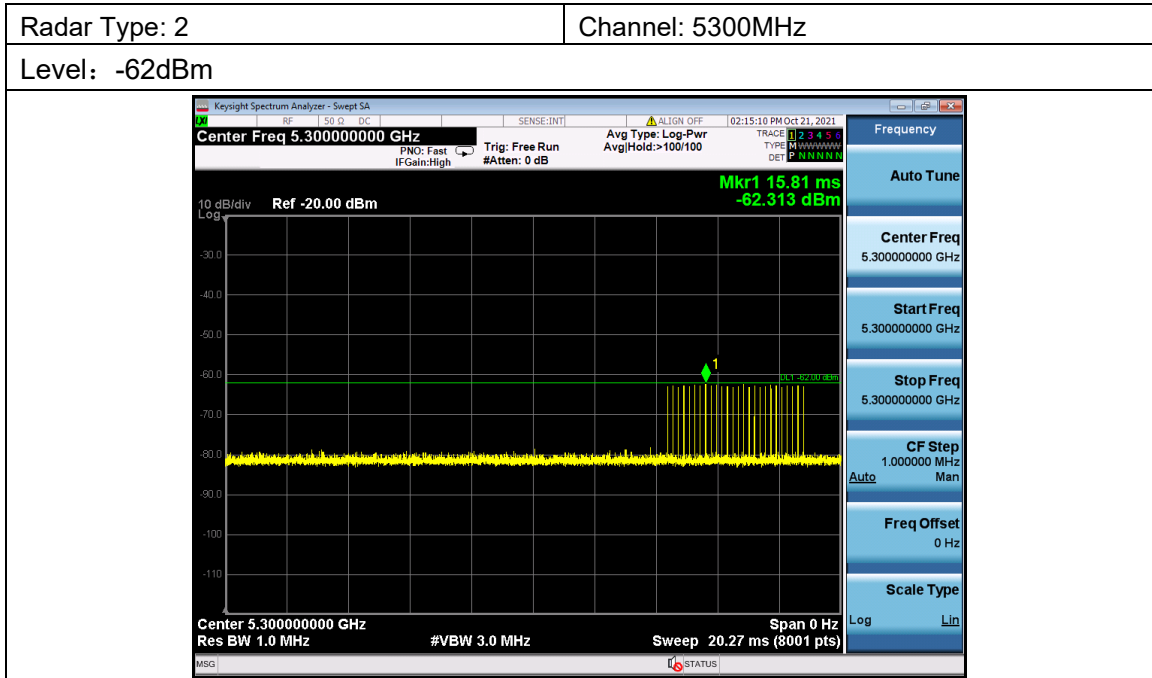

Unless otherwise agreed in writing, this document is issued by the Company subject to its General Conditions of Service printed overleaf, available on request or accessible at <http://www.sgs.com/en/Terms-and-Conditions.aspx> and, for electronic format documents, subject to Terms and Conditions for Electronic Documents at <http://www.sgs.com/en/Terms-and-Conditions/Terms-e-Documents.aspx>. Attention is drawn to the limitation of liability, indemnification and jurisdiction issues defined therein. Any holder of this document is advised that information contained hereon reflects the Company's findings at the time of its intervention only and within the limits of Client's instructions, if any. The Company's sole responsibility is to its Client and this document does not exonerate parties to a transaction from exercising all their rights and obligations under the transaction documents. This document cannot be reproduced except in full, without prior written approval of the Company. Any unauthorized alteration, forgery or falsification of the content or appearance of this document is unlawful and offenders may be prosecuted to the fullest extent of the law. Unless otherwise stated the results shown in this test report refer only to the sample(s) tested and such sample(s) are retained for 30 days only.  
Attention: To check the authenticity of testing /inspection report & certificate, please contact us at telephone: (86-755) 8307 1443, or email: [CN\\_Doccheck@sgs.com](mailto:CN_Doccheck@sgs.com)

Compliance Certification Services (Kunshan) Inc.  
EMC Laboratory

No.10, Weiye Road, Innovation Park, Kunshan, Jiangsu, China 215300  
中国·江苏·昆山市留学院创业园伟业路10号 邮编 215300

t(86-512)57355888 f(86-512)57370818 www.sgs.com.cn  
t(86-512)57355888 f(86-512)57370818 sgs.china@sgs.com

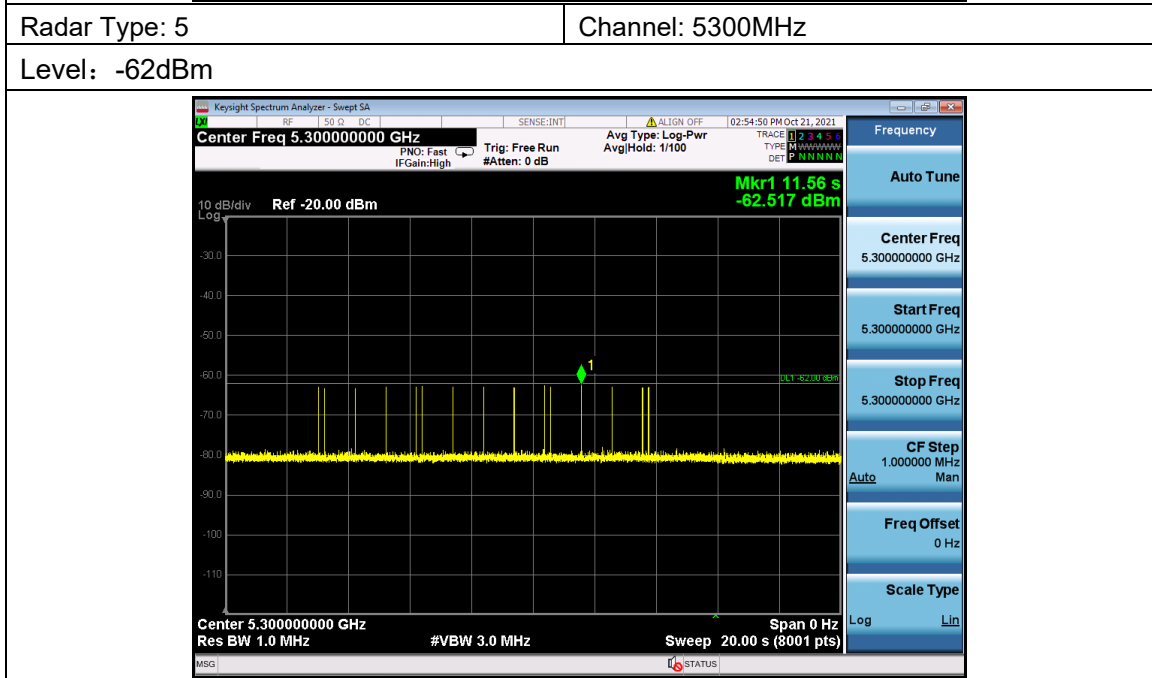
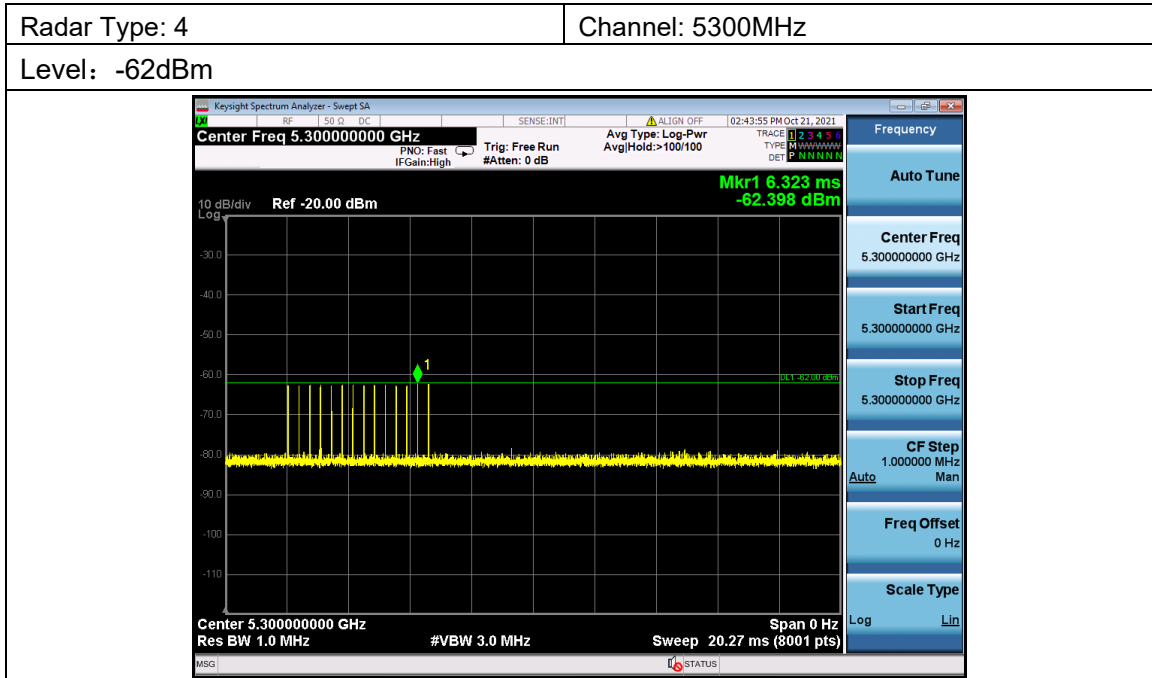

Unless otherwise agreed in writing, this document is issued by the Company subject to its General Conditions of Service printed overleaf, available on request or accessible at <http://www.sgs.com/en/Terms-and-Conditions.aspx> and, for electronic format documents, subject to Terms and Conditions for Electronic Documents at <http://www.sgs.com/en/Terms-and-Conditions/Terms-e-Documents.aspx>. Attention is drawn to the limitation of liability, indemnification and jurisdiction issues defined therein. Any holder of this document is advised that information contained hereon reflects the Company's findings at the time of its intervention only and within the limits of Client's instructions, if any. The Company's sole responsibility is to its Client and this document does not exonerate parties to a transaction from exercising all their rights and obligations under the transaction documents. This document cannot be reproduced except in full, without prior written approval of the Company. Any unauthorized alteration, forgery or falsification of the content or appearance of this document is unlawful and offenders may be prosecuted to the fullest extent of the law. Unless otherwise stated the results shown in this test report refer only to the sample(s) tested and such sample(s) are retained for 30 days only.

No.10, Weiye Road, Innovation Park, Kunshan, Jiangsu, China 215300  
 中国·江苏·昆山市留学院创业园伟业路10号 邮编 215300

tel: (86-512)57355888 tel: (86-512)57370818 www.sgs.com.cn  
 tel: (86-512)57355888 tel: (86-512)57370818 sgs.china@sgs.com

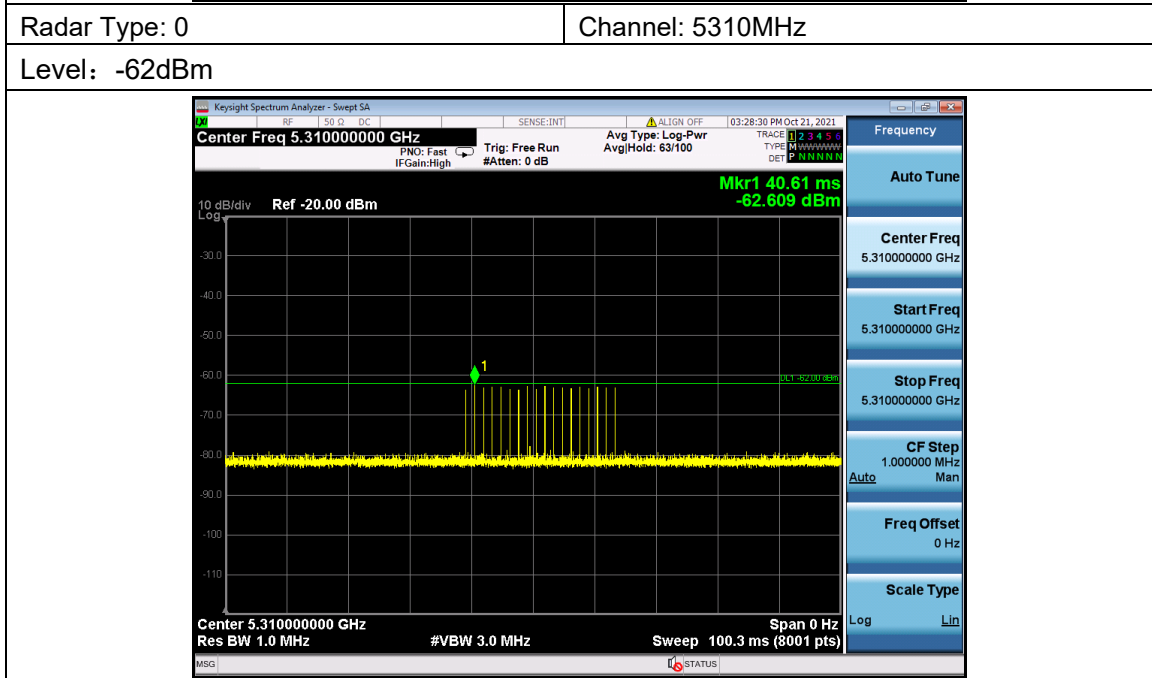
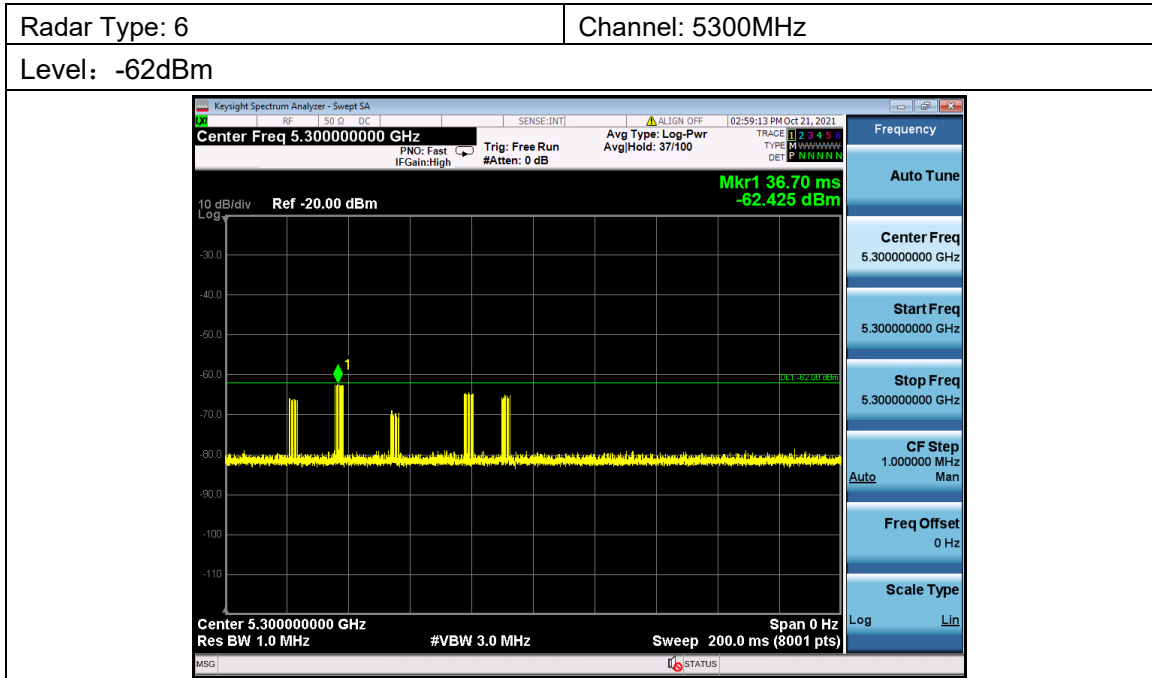

Unless otherwise agreed in writing, this document is issued by the Company subject to its General Conditions of Service printed overleaf, available on request or accessible at <http://www.sgs.com/en/Terms-and-Conditions.aspx> and, for electronic format documents, subject to Terms and Conditions for Electronic Documents at <http://www.sgs.com/en/Terms-and-Conditions/Terms-e-Documents.aspx>. Attention is drawn to the limitation of liability, indemnification and jurisdiction issues defined therein. Any holder of this document is advised that information contained hereon reflects the Company's findings at the time of its intervention only and within the limits of Client's instructions, if any. The Company's sole responsibility is to its Client and this document does not exonerate parties to a transaction from exercising all their rights and obligations under the transaction documents. This document cannot be reproduced except in full, without prior written approval of the Company. Any unauthorized alteration, forgery or falsification of the content or appearance of this document is unlawful and offenders may be prosecuted to the fullest extent of the law. Unless otherwise stated the results shown in this test report refer only to the sample(s) tested and such sample(s) are retained for 30 days only.

No.10, Weiye Road, Innovation Park, Kunshan, Jiangsu, China 215300  
中国·江苏·昆山市留学院创业园伟业路10号 邮编 215300

or email: [CN\\_Doccheck@sgs.com](mailto:CN_Doccheck@sgs.com)  
t(86-512)57355888 f(86-512)57370818 www.sgs.com.cn  
t(86-512)57355888 f(86-512)57370818 sgs.china@sgs.com

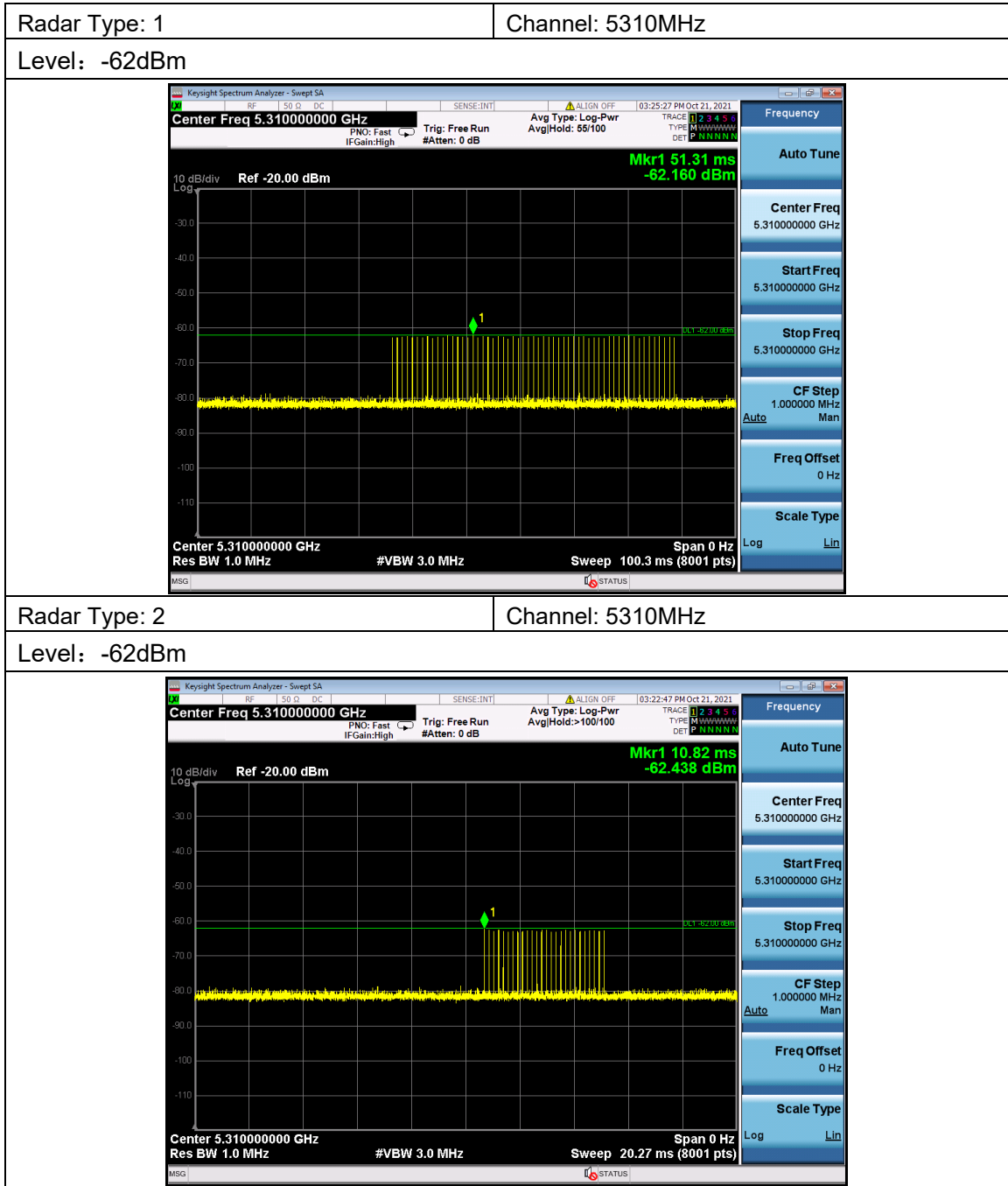

Unless otherwise agreed in writing, this document is issued by the Company subject to its General Conditions of Service printed overleaf, available on request or accessible at <http://www.sgs.com/en/Terms-and-Conditions.aspx> and, for electronic format documents, subject to Terms and Conditions for Electronic Documents at <http://www.sgs.com/en/Terms-and-Conditions/Terms-e-Document.aspx>. Attention is drawn to the limitation of liability, indemnification and jurisdiction issues defined therein. Any holder of this document is advised that information contained hereon reflects the Company's findings at the time of its intervention only and within the limits of Client's instructions, if any. The Company's sole responsibility is to its Client and this document does not exonerate parties to a transaction from exercising all their rights and obligations under the transaction documents. This document cannot be reproduced except in full, without prior written approval of the Company. Any unauthorized alteration, forgery or falsification of the content or appearance of this document is unlawful and offenders may be prosecuted to the fullest extent of the law. Unless otherwise stated the results shown in this test report refer only to the sample(s) tested and such sample(s) are retained for 30 days only.  
Attention: To check the authenticity of testing /inspection report & certificate, please contact us at telephone: (86-755) 8307 1443, or email: [CN\\_Doccheck@sgs.com](mailto:CN_Doccheck@sgs.com)



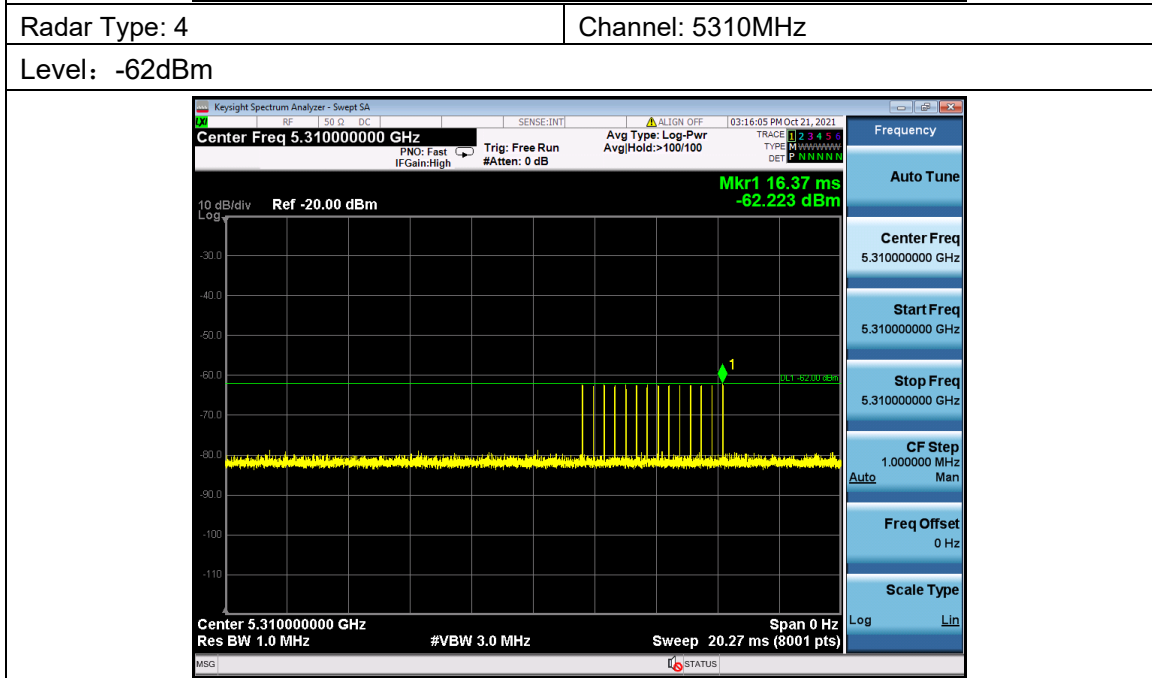
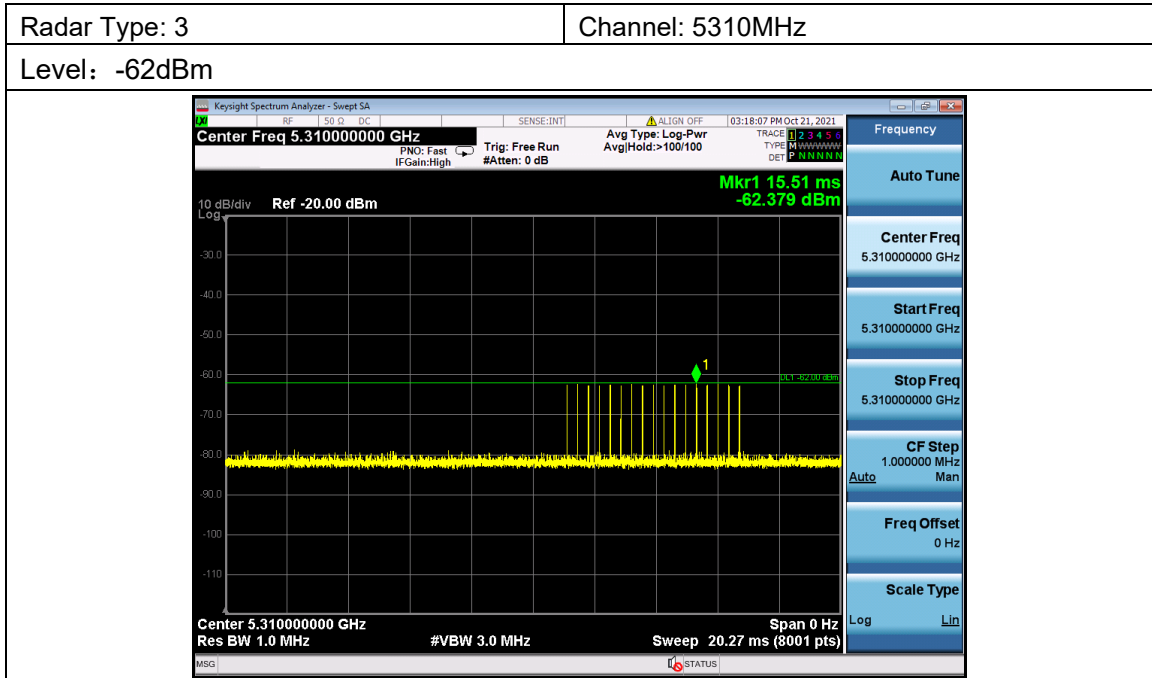

Unless otherwise agreed in writing, this document is issued by the Company subject to its General Conditions of Service printed overleaf, available on request or accessible at <http://www.sgs.com/en/Terms-and-Conditions.aspx> and, for electronic format documents, subject to Terms and Conditions for Electronic Documents at <http://www.sgs.com/en/Terms-and-Conditions/Terms-e-Documents.aspx>. Attention is drawn to the limitation of liability, indemnification and jurisdiction issues defined therein. Any holder of this document is advised that information contained hereon reflects the Company's findings at the time of its intervention only and within the limits of Client's instructions, if any. The Company's sole responsibility is to its Client and this document does not exonerate parties to a transaction from exercising all their rights and obligations under the transaction documents. This document cannot be reproduced except in full, without prior written approval of the Company. Any unauthorized alteration, forgery or falsification of the content or appearance of this document is unlawful and offenders may be prosecuted to the fullest extent of the law. Unless otherwise stated the results shown in this test report refer only to the sample(s) tested and such sample(s) are retained for 30 days only.  
Attention: To check the authenticity of testing /inspection report & certificate, please contact us at telephone: (86-755) 8307 1443, or email: [CN\\_Doccheck@sgs.com](mailto:CN_Doccheck@sgs.com)

Compliance Certification Services (Kunshan) Inc.  
EMC Laboratory

No.10, Weiye Road, Innovation Park, Kunshan, Jiangsu, China 215300  
中国·江苏·昆山市留学生创业园伟业路10号 邮编 215300

t(86-512)57355888 f(86-512)57370818 www.sgs.com.cn  
t(86-512)57355888 f(86-512)57370818 sgs.china@sgs.com

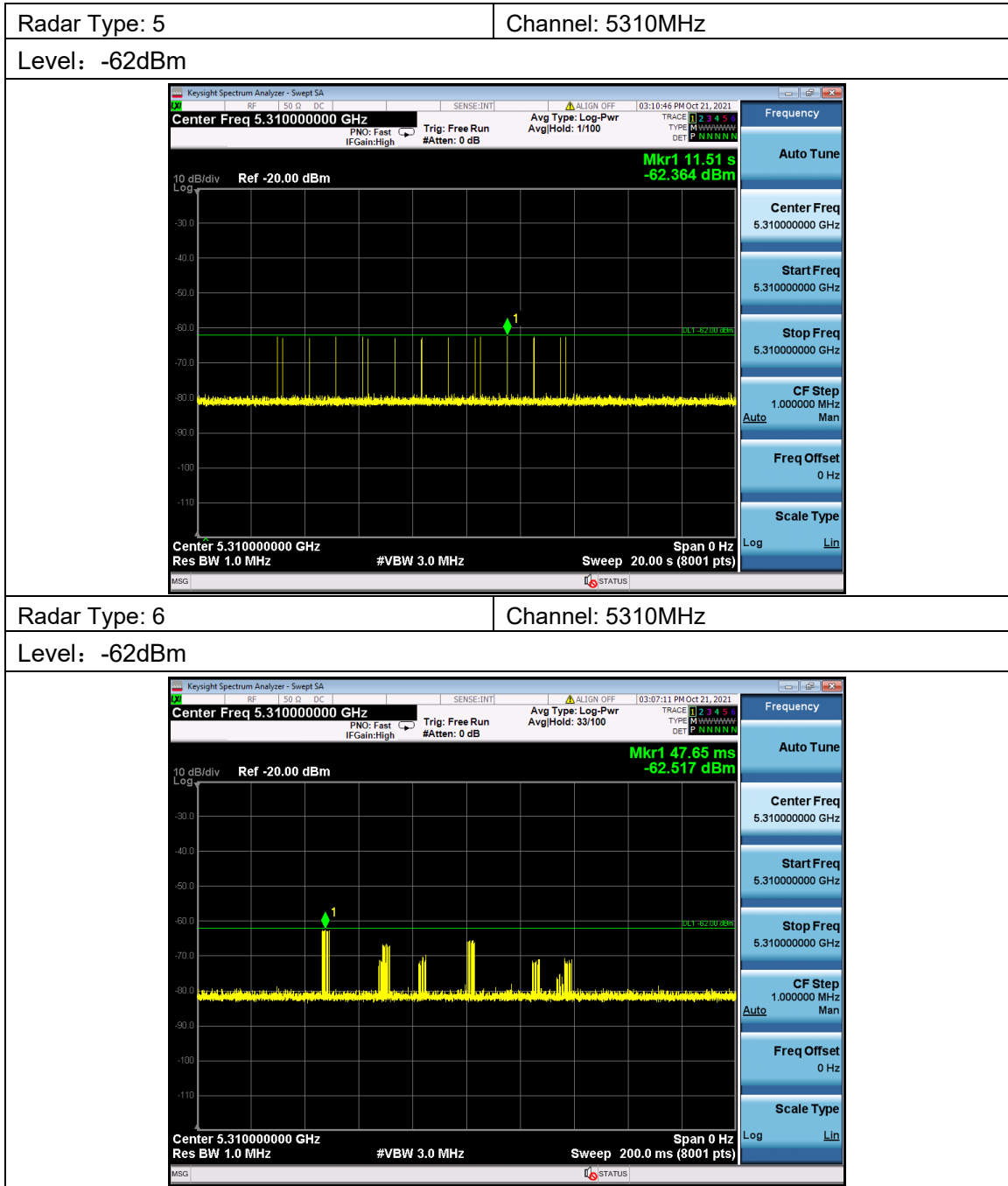

Unless otherwise agreed in writing, this document is issued by the Company subject to its General Conditions of Service printed overleaf, available on request or accessible at <http://www.sgs.com/en/Terms-and-Conditions.aspx> and, for electronic format documents, subject to Terms and Conditions for Electronic Documents at <http://www.sgs.com/en/Terms-and-Conditions/Terms-e-Documents.aspx>. Attention is drawn to the limitation of liability, indemnification and jurisdiction issues defined therein. Any holder of this document is advised that information contained hereon reflects the Company's findings at the time of its intervention only and within the limits of Client's instructions, if any. The Company's sole responsibility is to its Client and this document does not exonerate parties to a transaction from exercising all their rights and obligations under the transaction documents. This document cannot be reproduced except in full, without prior written approval of the Company. Any unauthorized alteration, forgery or falsification of the content or appearance of this document is unlawful and offenders may be prosecuted to the fullest extent of the law. Unless otherwise stated the results shown in this test report refer only to the sample(s) tested and such sample(s) are retained for 30 days only.

Attention: To check the authenticity of testing /inspection report & certificate, please contact us at telephone: (86-755) 8307 1443, or email: [CN\\_Doccheck@sgs.com](mailto:CN_Doccheck@sgs.com)

No.10, Weiye Road, Innovation Park, Kunshan, Jiangsu, China 215300  
中国·江苏·昆山市留学生创业园伟业路10号 邮编 215300

(86-512)57355888 (86-512)57370818 [www.sgs.com.cn](http://www.sgs.com.cn)  
(86-512)57355888 (86-512)57370818 [sgs.china@sgs.com](mailto:sgs.china@sgs.com)

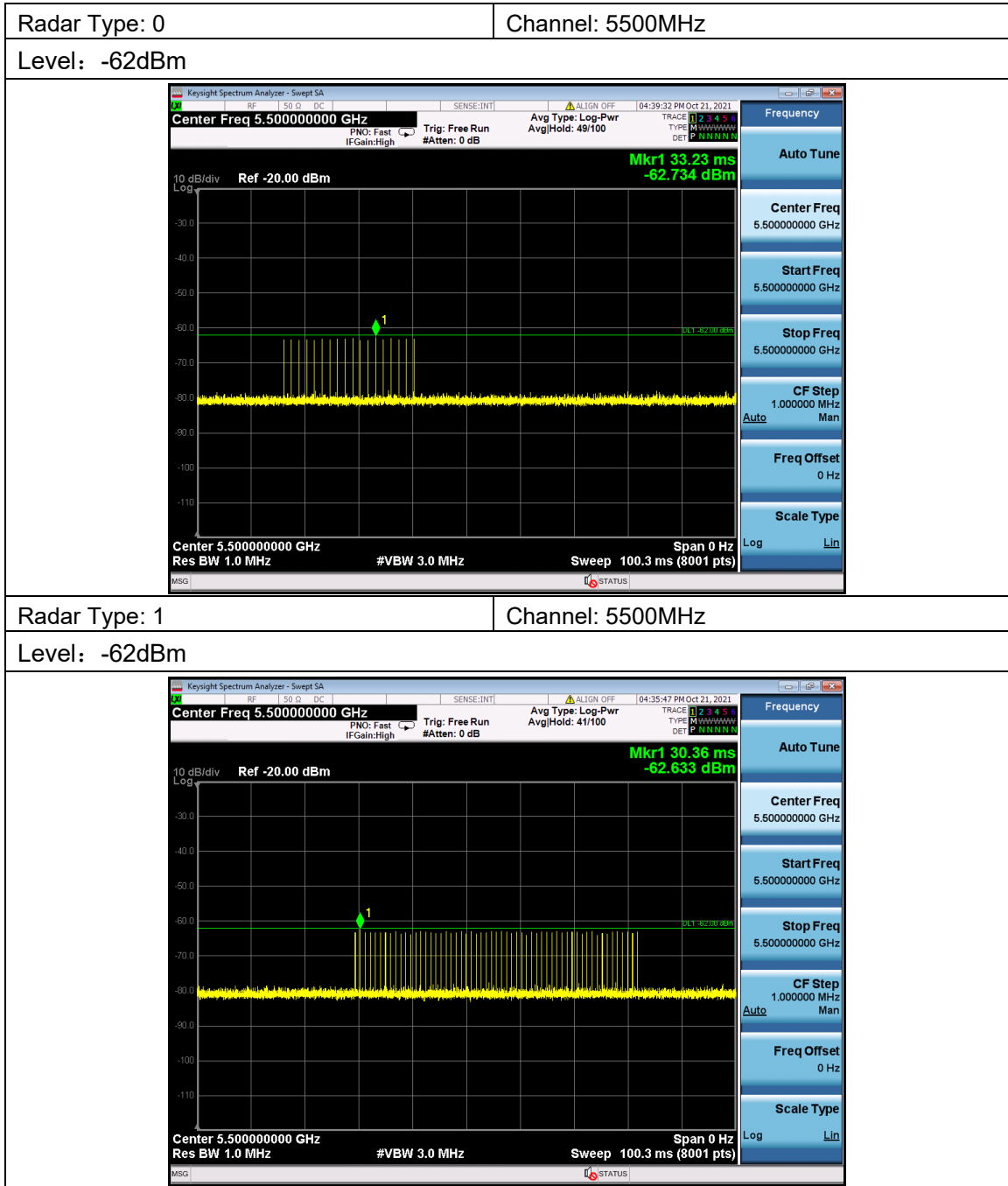

Unless otherwise agreed in writing, this document is issued by the Company subject to its General Conditions of Service printed overleaf, available on request or accessible at <http://www.sgs.com/en/Terms-and-Conditions.aspx> and, for electronic format documents, subject to Terms and Conditions for Electronic Documents at <http://www.sgs.com/en/Terms-and-Conditions/Terms-e-Documents.aspx>. Attention is drawn to the limitation of liability, indemnification and jurisdiction issues defined therein. Any holder of this document is advised that information contained hereon reflects the Company's findings at the time of its intervention only and within the limits of Client's instructions, if any. The Company's sole responsibility is to its Client and this document does not exonerate parties to a transaction from exercising all their rights and obligations under the transaction documents. This document cannot be reproduced except in full, without prior written approval of the Company. Any unauthorized alteration, forgery or falsification of the content or appearance of this document is unlawful and offenders may be prosecuted to the fullest extent of the law. Unless otherwise stated the results shown in this test report refer only to the sample(s) tested and such sample(s) are retained for 30 days only.

Attention: To check the authenticity of testing /inspection report & certificate, please contact us at telephone: (86-755) 8307 1443, or email: [CN\\_Doccheck@sgs.com](mailto:CN_Doccheck@sgs.com)

No.10, Weiye Road, Innovation Park, Kunshan, Jiangsu, China 215300      t(86-512)57355888    f(86-512)57370818    www.sgs.com.cn  
 中国·江苏·昆山市留学院创业园伟业路10号 邮编 215300      t(86-512)57355888    f(86-512)57370818    sgs.china@sgs.com

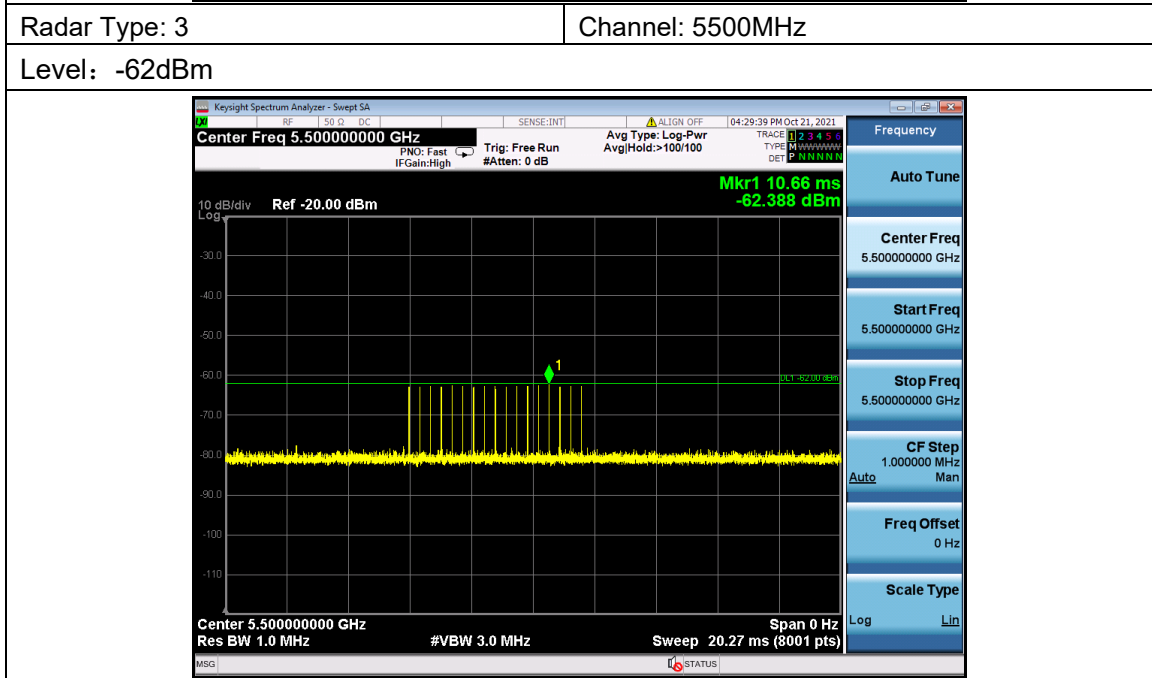
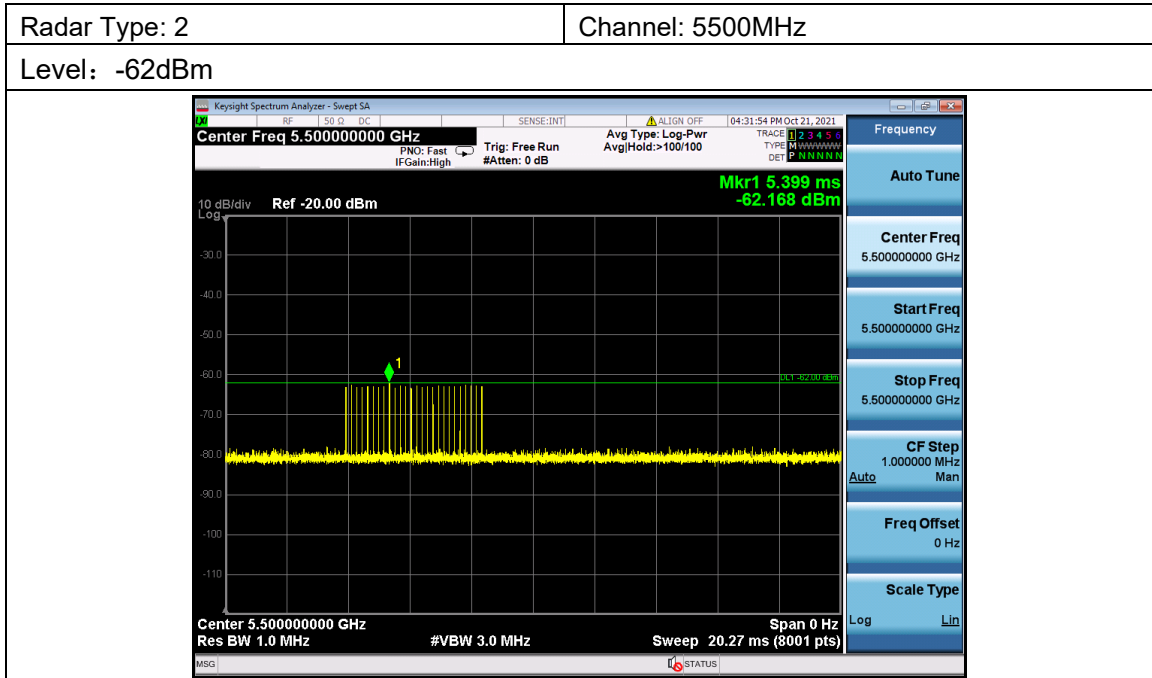

Unless otherwise agreed in writing, this document is issued by the Company subject to its General Conditions of Service printed overleaf, available on request or accessible at <http://www.sgs.com/en/Terms-and-Conditions.aspx> and, for electronic format documents, subject to Terms and Conditions for Electronic Documents at <http://www.sgs.com/en/Terms-and-Conditions/Terms-e-Documents.aspx>. Attention is drawn to the limitation of liability, indemnification and jurisdiction issues defined therein. Any holder of this document is advised that information contained hereon reflects the Company's findings at the time of its intervention only and within the limits of Client's instructions, if any. The Company's sole responsibility is to its Client and this document does not exonerate parties to a transaction from exercising all their rights and obligations under the transaction documents. This document cannot be reproduced except in full, without prior written approval of the Company. Any unauthorized alteration, forgery or falsification of the content or appearance of this document is unlawful and offenders may be prosecuted to the fullest extent of the law. Unless otherwise stated the results shown in this test report refer only to the sample(s) tested and such sample(s) are retained for 30 days only.  
Attention: To check the authenticity of testing / inspection report & certificate, please contact us at telephone: (86-755) 8307 1443, or email: [CN\\_Doccheck@sgs.com](mailto:CN_Doccheck@sgs.com)

Compliance Certification Services (Kunshan) Inc.  
EMC Laboratory

No.10, Weiye Road, Innovation Park, Kunshan, Jiangsu, China 215300  
中国·江苏·昆山市留学生创业园伟业路10号 邮编 215300

t(86-512)57355888 f(86-512)57370818 www.sgs.com.cn  
t(86-512)57355888 f(86-512)57370818 sgs.china@sgs.com

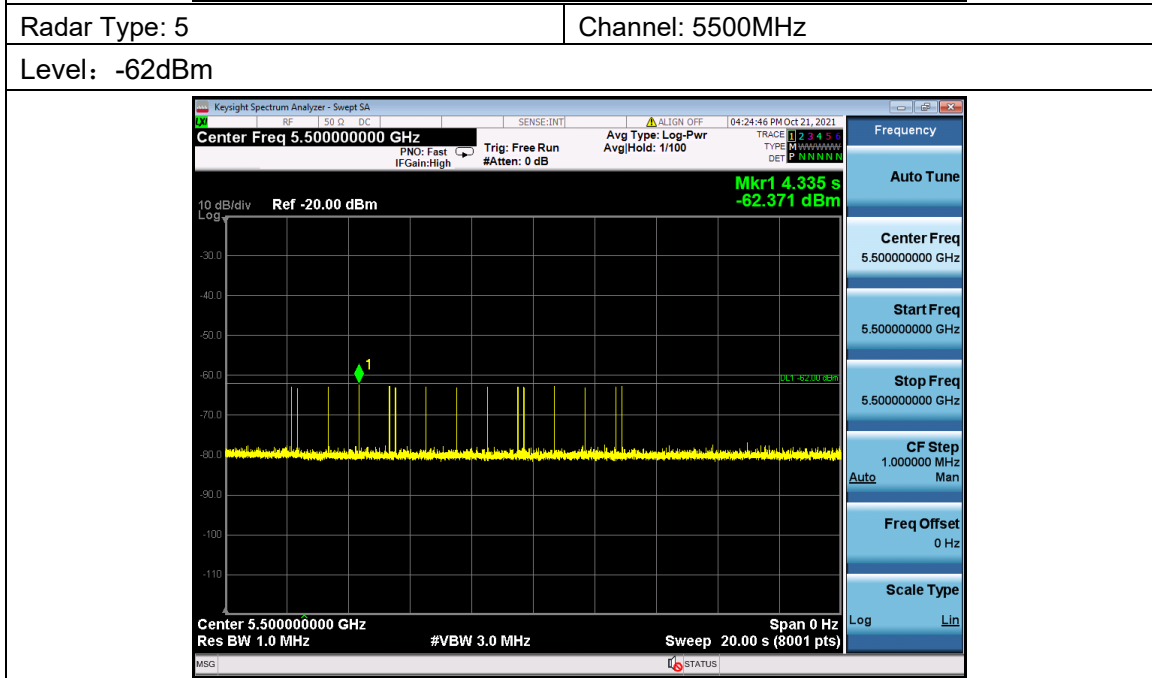
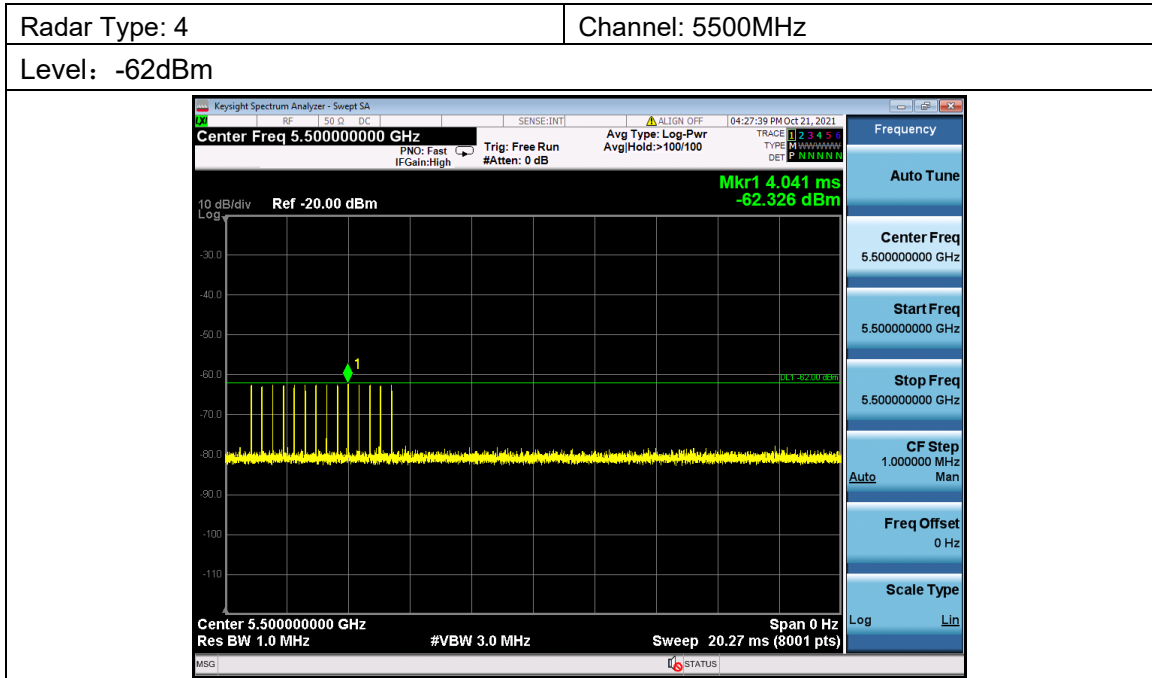

Unless otherwise agreed in writing, this document is issued by the Company subject to its General Conditions of Service printed overleaf, available on request or accessible at <http://www.sgs.com/en/Terms-and-Conditions.aspx> and, for electronic format documents, subject to Terms and Conditions for Electronic Documents at <http://www.sgs.com/en/Terms-and-Conditions/Terms-e-Documents.aspx>. Attention is drawn to the limitation of liability, indemnification and jurisdiction issues defined therein. Any holder of this document is advised that information contained hereon reflects the Company's findings at the time of its intervention only and within the limits of Client's instructions, if any. The Company's sole responsibility is to its Client and this document does not exonerate parties to a transaction from exercising all their rights and obligations under the transaction documents. This document cannot be reproduced except in full, without prior written approval of the Company. Any unauthorized alteration, forgery or falsification of the content or appearance of this document is unlawful and offenders may be prosecuted to the fullest extent of the law. Unless otherwise stated the results shown in this test report refer only to the sample(s) tested and such sample(s) are retained for 30 days only.  
Attention: To check the authenticity of testing /inspection report & certificate, please contact us at telephone: (86-755) 8307 1443, or email: [CN\\_Doccheck@sgs.com](mailto:CN_Doccheck@sgs.com)

Compliance Certification Services (Kunshan) Inc.  
EMC Laboratory

No.10, Weiye Road, Innovation Park, Kunshan, Jiangsu, China 215300  
中国·江苏·昆山市留学生创业园伟业路10号 邮编 215300

t(86-512)57355888 f(86-512)57370818 www.sgs.com.cn  
t(86-512)57355888 f(86-512)57370818 sgs.china@sgs.com



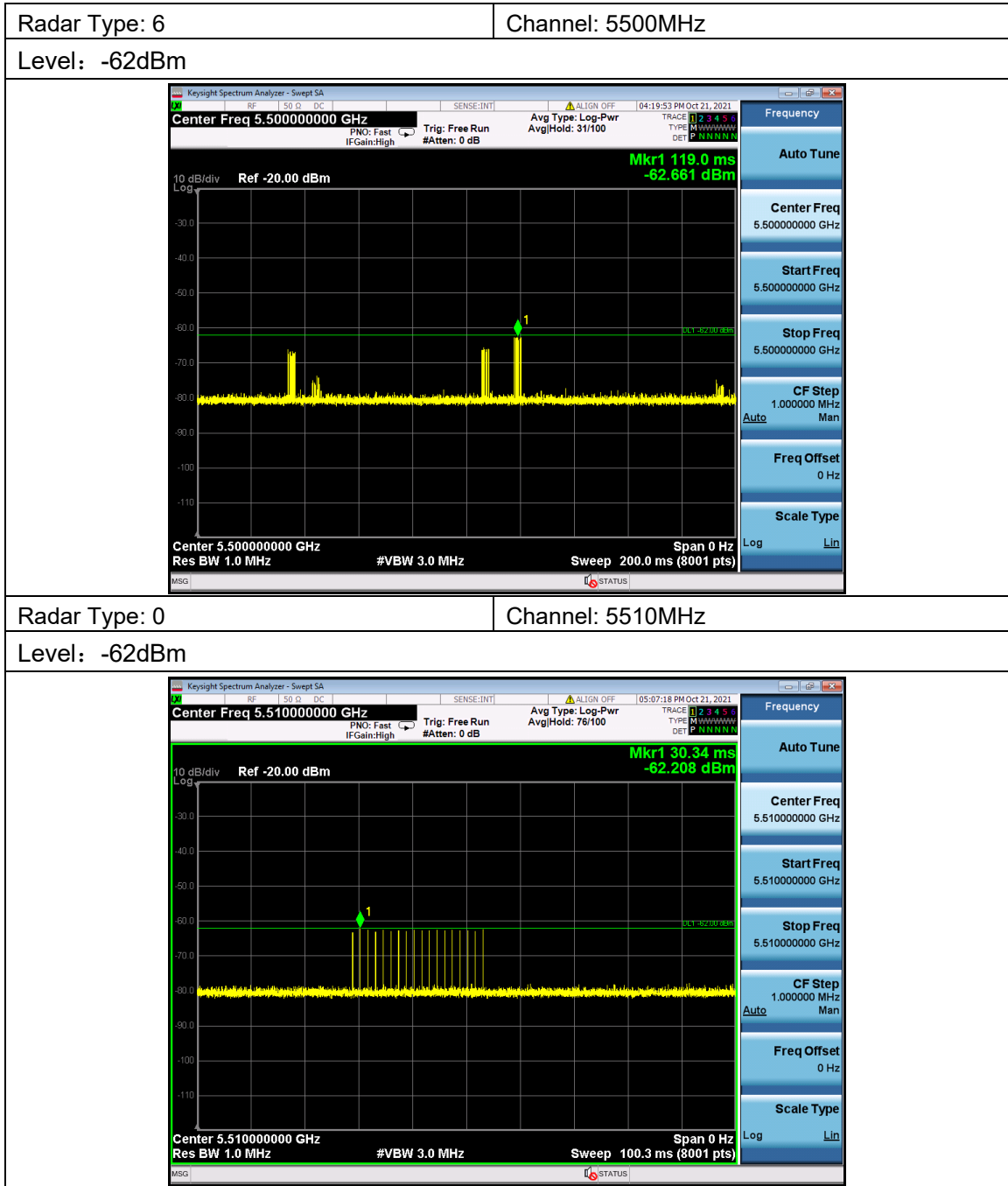

Unless otherwise agreed in writing, this document is issued by the Company subject to its General Conditions of Service printed overleaf, available on request or accessible at <http://www.sgs.com/en/Terms-and-Conditions.aspx> and, for electronic format documents, subject to Terms and Conditions for Electronic Documents at <http://www.sgs.com/en/Terms-and-Conditions/Terms-e-Documents.aspx>. Attention is drawn to the limitation of liability, indemnification and jurisdiction issues defined therein. Any holder of this document is advised that information contained hereon reflects the Company's findings at the time of its intervention only and within the limits of Client's instructions, if any. The Company's sole responsibility is to its Client and this document does not exonerate parties to a transaction from exercising all their rights and obligations under the transaction documents. This document cannot be reproduced except in full, without prior written approval of the Company. Any unauthorized alteration, forgery or falsification of the content or appearance of this document is unlawful and offenders may be prosecuted to the fullest extent of the law. Unless otherwise stated the results shown in this test report refer only to the sample(s) tested and such sample(s) are retained for 30 days only.

No.10, Weiye Road, Innovation Park, Kunshan, Jiangsu, China 215300  
中国·江苏·昆山市留学生创业园伟业路10号 邮编 215300

tel: (86-512)57355888 tel: (86-512)57370818 www.sgs.com.cn  
tel: (86-512)57355888 tel: (86-512)57370818 sgs.china@sgs.com

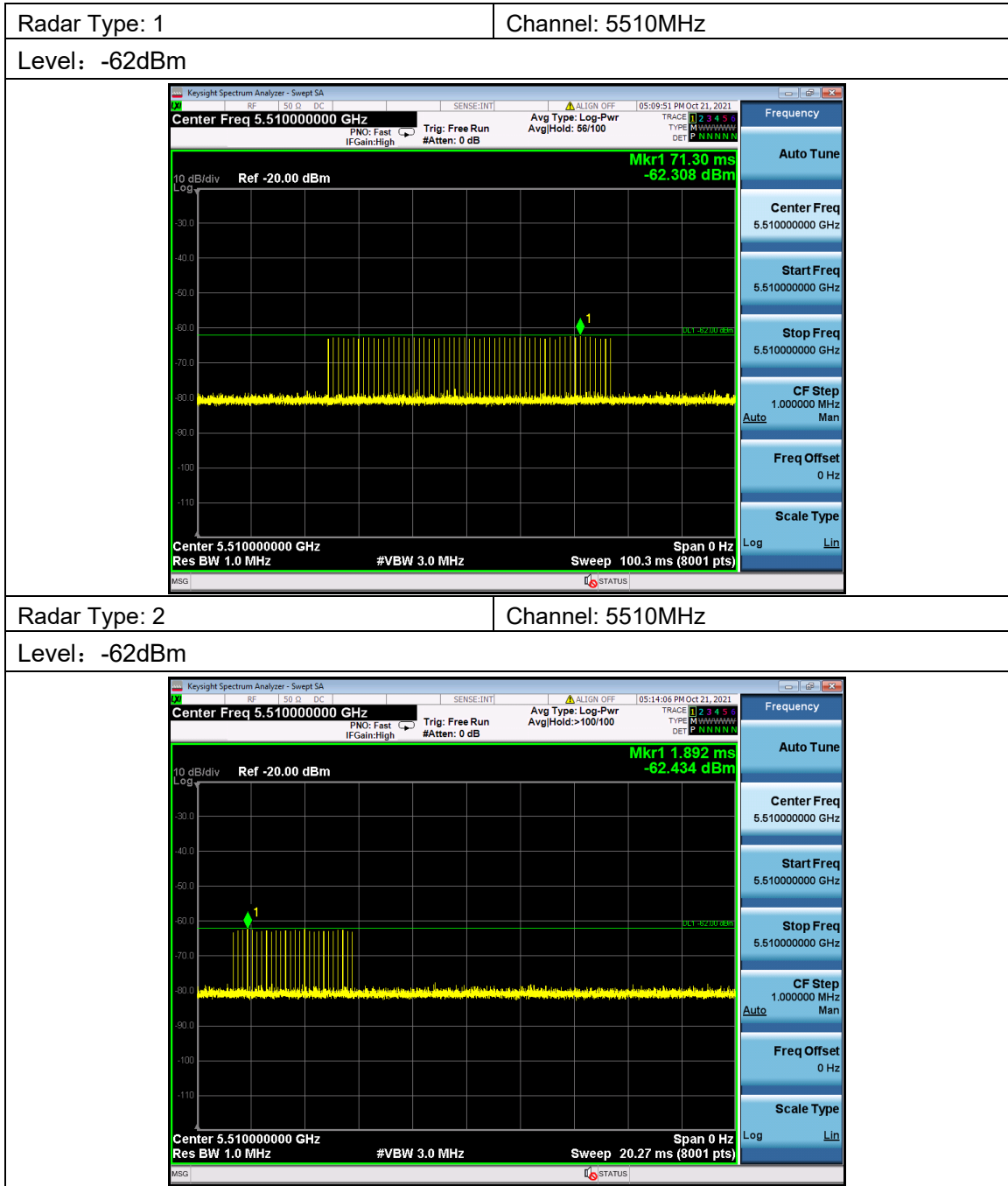

Unless otherwise agreed in writing, this document is issued by the Company subject to its General Conditions of Service printed overleaf, available on request or accessible at <http://www.sgs.com/en/Terms-and-Conditions.aspx> and, for electronic format documents, subject to Terms and Conditions for Electronic Documents at <http://www.sgs.com/en/Terms-and-Conditions/Terms-e-Documents.aspx>. Attention is drawn to the limitation of liability, indemnification and jurisdiction issues defined therein. Any holder of this document is advised that information contained hereon reflects the Company's findings at the time of its intervention only and within the limits of Client's instructions, if any. The Company's sole responsibility is to its Client and this document does not exonerate parties to a transaction from exercising all their rights and obligations under the transaction documents. This document cannot be reproduced except in full, without prior written approval of the Company. Any unauthorized alteration, forgery or falsification of the content or appearance of this document is unlawful and offenders may be prosecuted to the fullest extent of the law. Unless otherwise stated the results shown in this test report refer only to the sample(s) tested and such sample(s) are retained for 30 days only.

Attention: To check the authenticity of testing /inspection report & certificate, please contact us at telephone: (86-755) 8307 1443, or email: [CN\\_Doccheck@sgs.com](mailto:CN_Doccheck@sgs.com)

No.10, Weiye Road, Innovation Park, Kunshan, Jiangsu, China 215300  
中国·江苏·昆山市留学院创业园伟业路10号 邮编 215300

(86-512)57355888    (86-512)57370818    [www.sgs.com](http://www.sgs.com)  
(86-512)57355888    (86-512)57370818    [sgs.china@sgs.com](mailto:sgs.china@sgs.com)

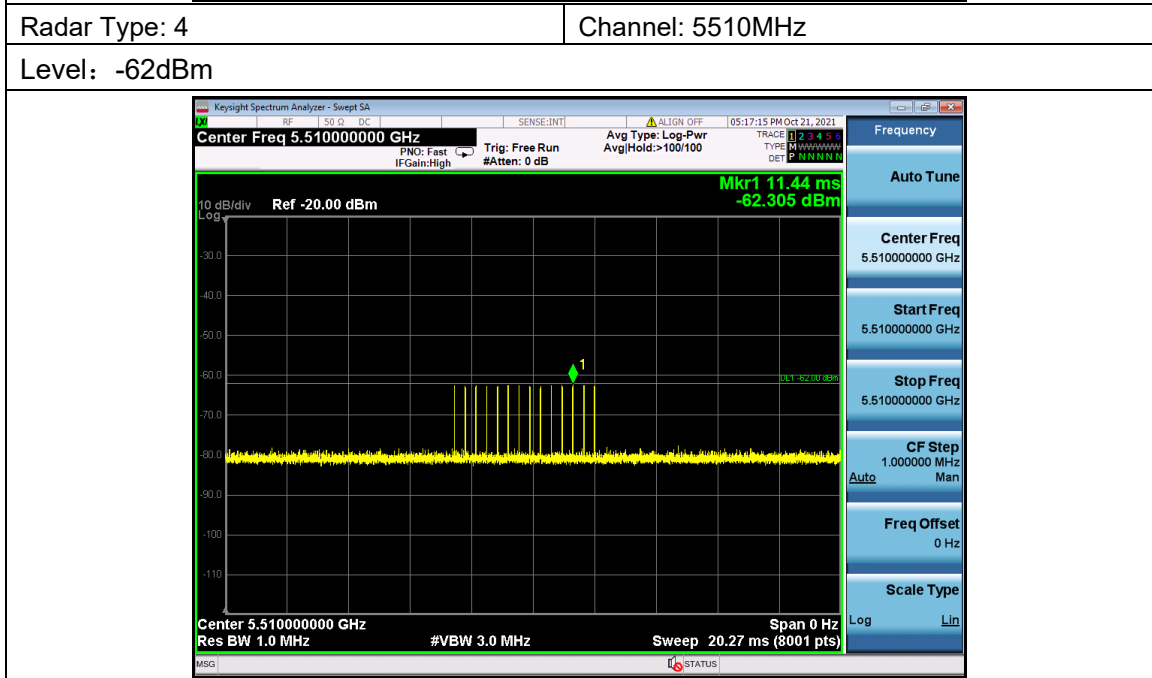
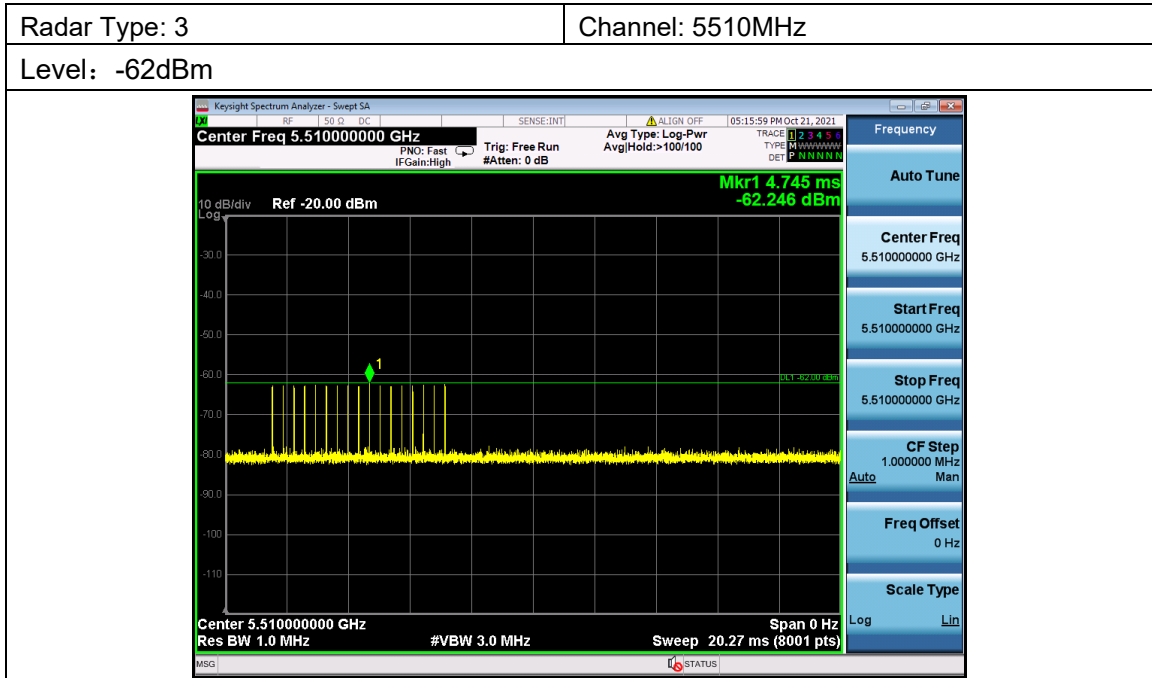

Unless otherwise agreed in writing, this document is issued by the Company subject to its General Conditions of Service printed overleaf, available on request or accessible at <http://www.sgs.com/en/Terms-and-Conditions.aspx> and, for electronic format documents, subject to Terms and Conditions for Electronic Documents at <http://www.sgs.com/en/Terms-and-Conditions/Terms-e-Documents.aspx>. Attention is drawn to the limitation of liability, indemnification and jurisdiction issues defined therein. Any holder of this document is advised that information contained hereon reflects the Company's findings at the time of its intervention only and within the limits of Client's instructions, if any. The Company's sole responsibility is to its Client and this document does not exonerate parties to a transaction from exercising all their rights and obligations under the transaction documents. This document cannot be reproduced except in full, without prior written approval of the Company. Any unauthorized alteration, forgery or falsification of the content or appearance of this document is unlawful and offenders may be prosecuted to the fullest extent of the law. Unless otherwise stated the results shown in this test report refer only to the sample(s) tested and such sample(s) are retained for 30 days only.

No.10, Weiye Road, Innovation Park, Kunshan, Jiangsu, China 215300  
中国·江苏·昆山市留学生创业园伟业路10号 邮编 215300

tel: (86-512) 57355888    tel: (86-512) 57370818    www.sgs.com.cn  
tel: (86-512) 57355888    tel: (86-512) 57370818    sgs.china@sgs.com

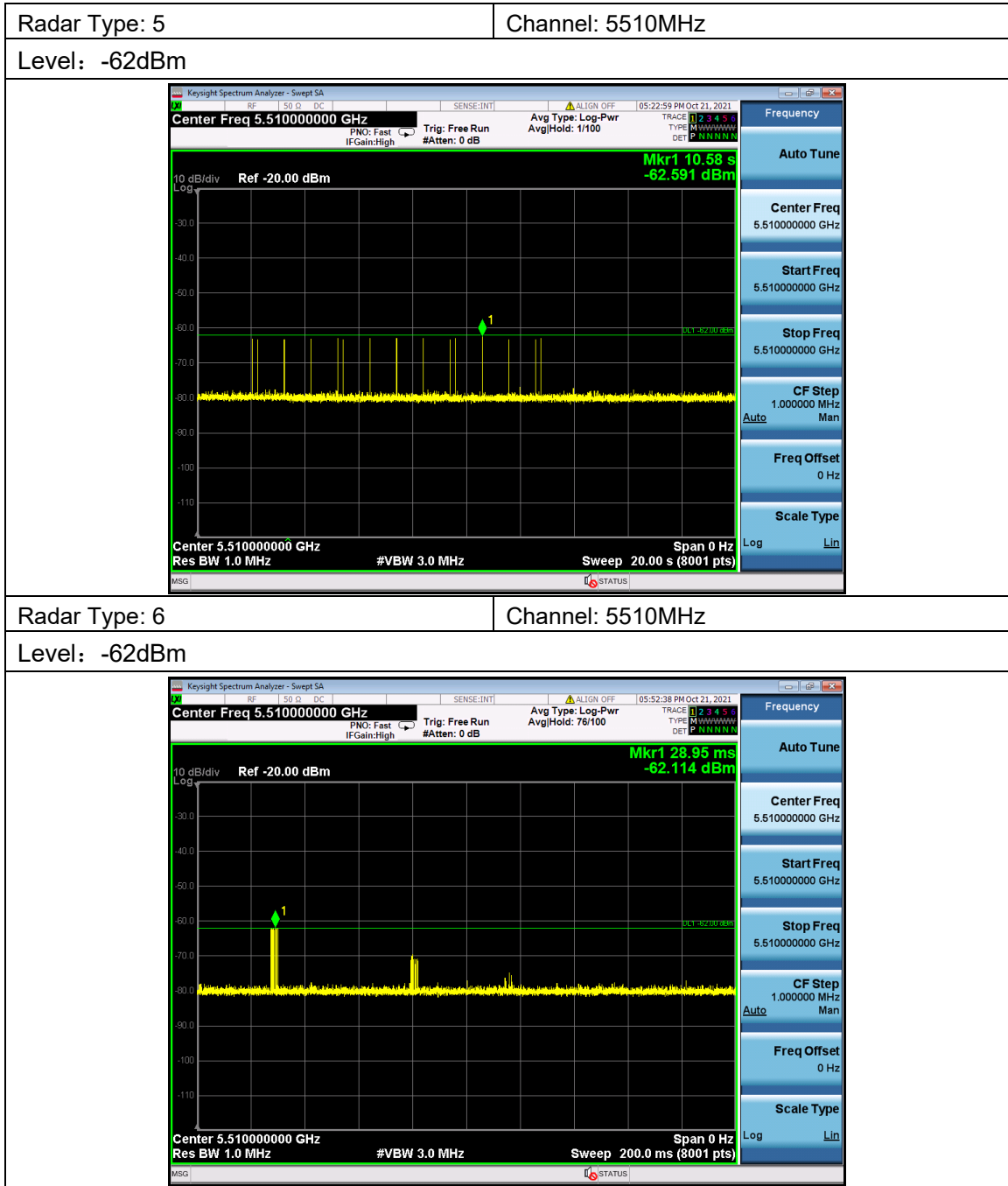

Unless otherwise agreed in writing, this document is issued by the Company subject to its General Conditions of Service printed overleaf, available on request or accessible at <http://www.sgs.com/en/Terms-and-Conditions.aspx> and, for electronic format documents, subject to Terms and Conditions for Electronic Documents at <http://www.sgs.com/en/Terms-and-Conditions/Terms-e-Documents.aspx>. Attention is drawn to the limitation of liability, indemnification and jurisdiction issues defined therein. Any holder of this document is advised that information contained hereon reflects the Company's findings at the time of its intervention only and within the limits of Client's instructions, if any. The Company's sole responsibility is to its Client and this document does not exonerate parties to a transaction from exercising all their rights and obligations under the transaction documents. This document cannot be reproduced except in full, without prior written approval of the Company. Any unauthorized alteration, forgery or falsification of the content or appearance of this document is unlawful and offenders may be prosecuted to the fullest extent of the law. Unless otherwise stated the results shown in this test report refer only to the sample(s) tested and such sample(s) are retained for 30 days only.

Attention: To check the authenticity of testing /inspection report & certificate, please contact us at telephone: (86-755) 8307 1443, or email: [CN\\_Doccheck@sgs.com](mailto:CN_Doccheck@sgs.com)  
 No.10, Weiye Road, Innovation Park, Kunshan, Jiangsu, China 215300      t(86-512)57355888      f(86-512)57370818      www.sgs.com.cn  
 中国·江苏·昆山市留学生创业园伟业路10号 邮编 215300      t(86-512)57355888      f(86-512)57370818      sgs.china@sgs.com



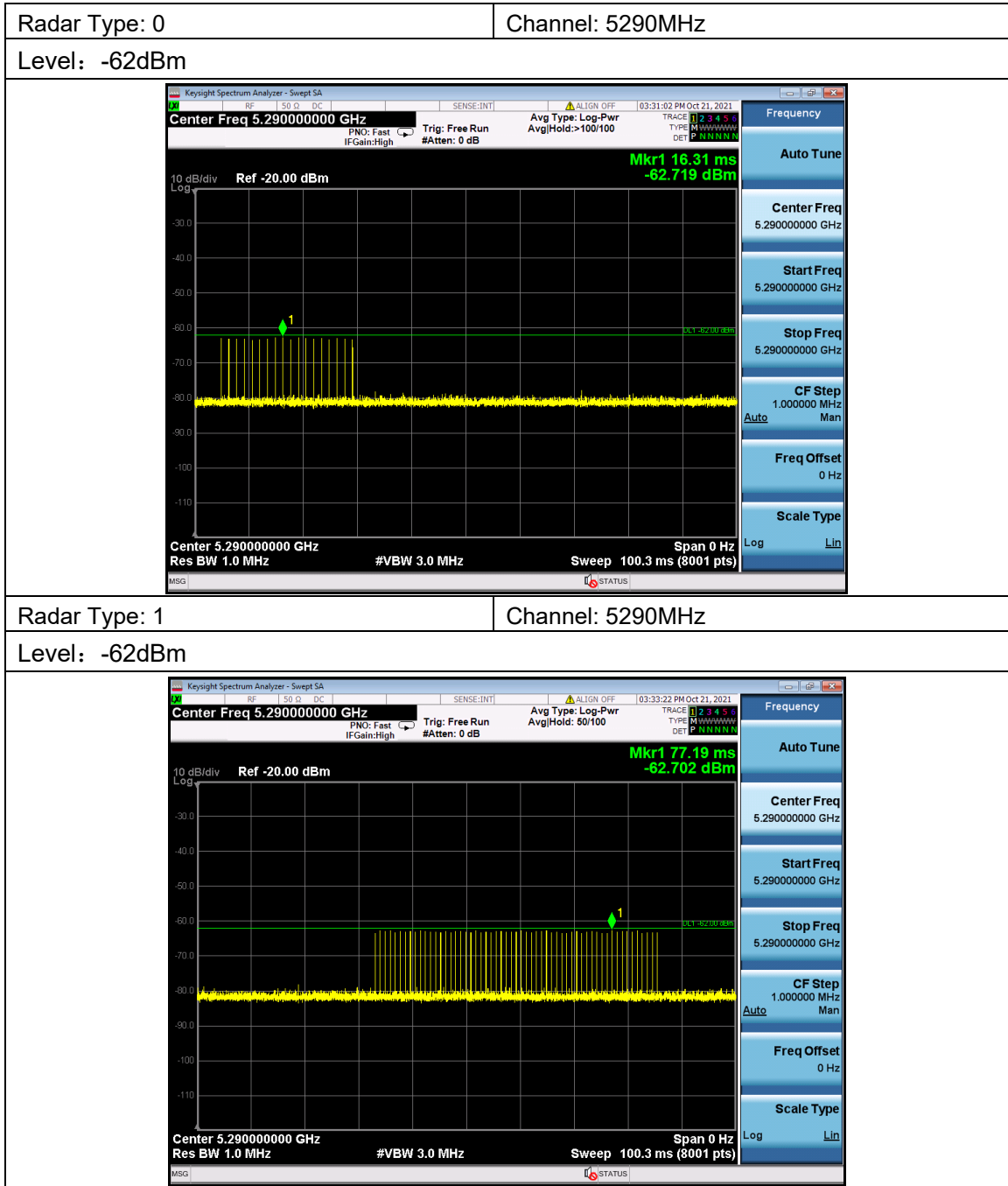

Unless otherwise agreed in writing, this document is issued by the Company subject to its General Conditions of Service printed overleaf, available on request or accessible at <http://www.sgs.com/en/Terms-and-Conditions.aspx> and, for electronic format documents, subject to Terms and Conditions for Electronic Documents at <http://www.sgs.com/en/Terms-and-Conditions/Terms-e-Documents.aspx>. Attention is drawn to the limitation of liability, indemnification and jurisdiction issues defined therein. Any holder of this document is advised that information contained hereon reflects the Company's findings at the time of its intervention only and within the limits of Client's instructions, if any. The Company's sole responsibility is to its Client and this document does not exonerate parties to a transaction from exercising all their rights and obligations under the transaction documents. This document cannot be reproduced except in full, without prior written approval of the Company. Any unauthorized alteration, forgery or falsification of the content or appearance of this document is unlawful and offenders may be prosecuted to the fullest extent of the law. Unless otherwise stated the results shown in this test report refer only to the sample(s) tested and such sample(s) are retained for 30 days only.

Attention: To check the authenticity of testing /inspection report & certificate, please contact us at telephone: (86-755) 8307 1443, or email: [CN\\_Doccheck@sgs.com](mailto:CN_Doccheck@sgs.com)

No.10, Weiye Road, Innovation Park, Kunshan, Jiangsu, China 215300  
中国·江苏·昆山市留学院创业园伟业路10号 邮编 215300

(86-512)57355888 (86-512)57370818 [www.sgs.com](http://www.sgs.com).cn  
(86-512)57355888 (86-512)57370818 [sgs.china@sgs.com](mailto:sgs.china@sgs.com)

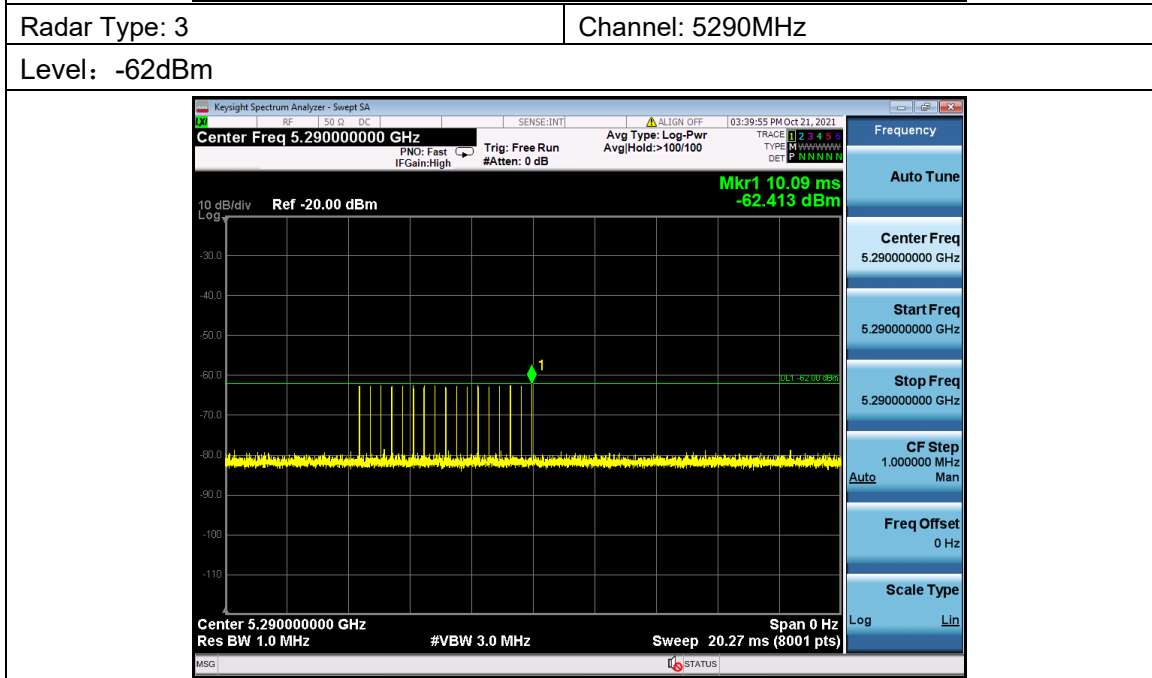
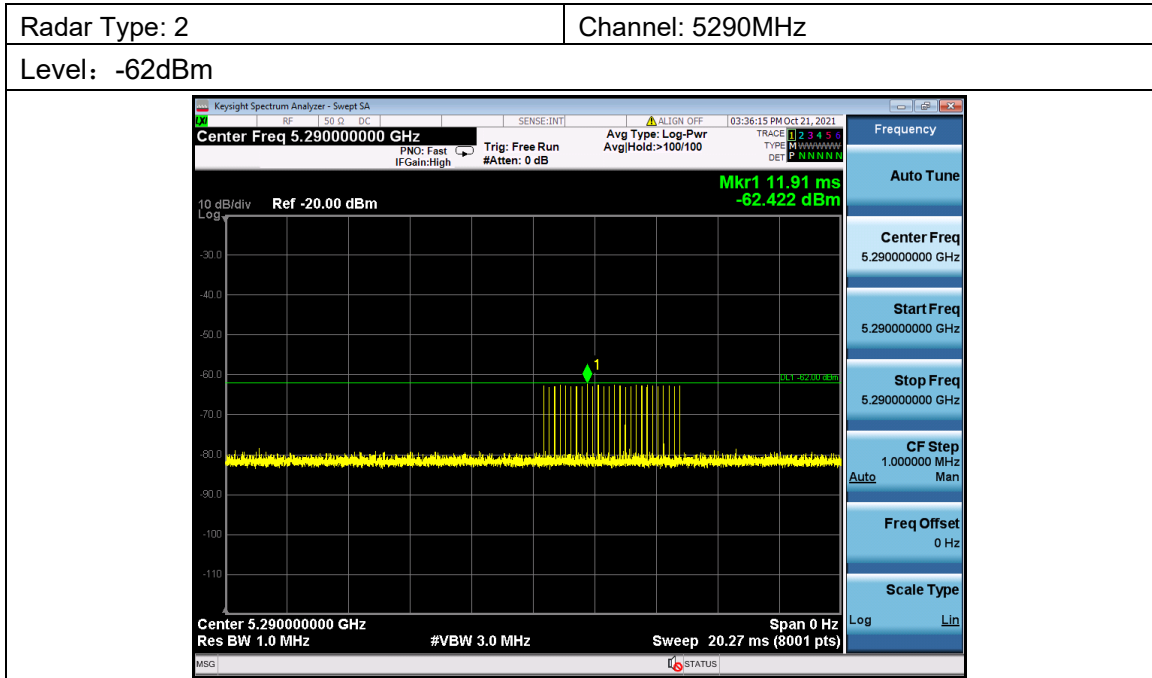

Unless otherwise agreed in writing, this document is issued by the Company subject to its General Conditions of Service printed overleaf, available on request or accessible at <http://www.sgs.com/en/Terms-and-Conditions.aspx> and, for electronic format documents, subject to Terms and Conditions for Electronic Documents at <http://www.sgs.com/en/Terms-and-Conditions/Terms-e-Documents.aspx>. Attention is drawn to the limitation of liability, indemnification and jurisdiction issues defined therein. Any holder of this document is advised that information contained hereon reflects the Company's findings at the time of its intervention only and within the limits of Client's instructions, if any. The Company's sole responsibility is to its Client and this document does not exonerate parties to a transaction from exercising all their rights and obligations under the transaction documents. This document cannot be reproduced except in full, without prior written approval of the Company. Any unauthorized alteration, forgery or falsification of the content or appearance of this document is unlawful and offenders may be prosecuted to the fullest extent of the law. Unless otherwise stated the results shown in this test report refer only to the sample(s) tested and such sample(s) are retained for 30 days only.  
Attention: To check the authenticity of testing /inspection report & certificate, please contact us at telephone: (86-755) 8307 1443, or email: [CN\\_Doccheck@sgs.com](mailto:CN_Doccheck@sgs.com)

Compliance Certification Services (Kunshan) Inc.  
EMC Laboratory

No.10, Weiye Road, Innovation Park, Kunshan, Jiangsu, China 215300  
中国·江苏·昆山市留学院创业园伟业路10号 邮编 215300

t(86-512)57355888 f(86-512)57370818 www.sgs.com.cn  
t(86-512)57355888 f(86-512)57370818 sgs.china@sgs.com

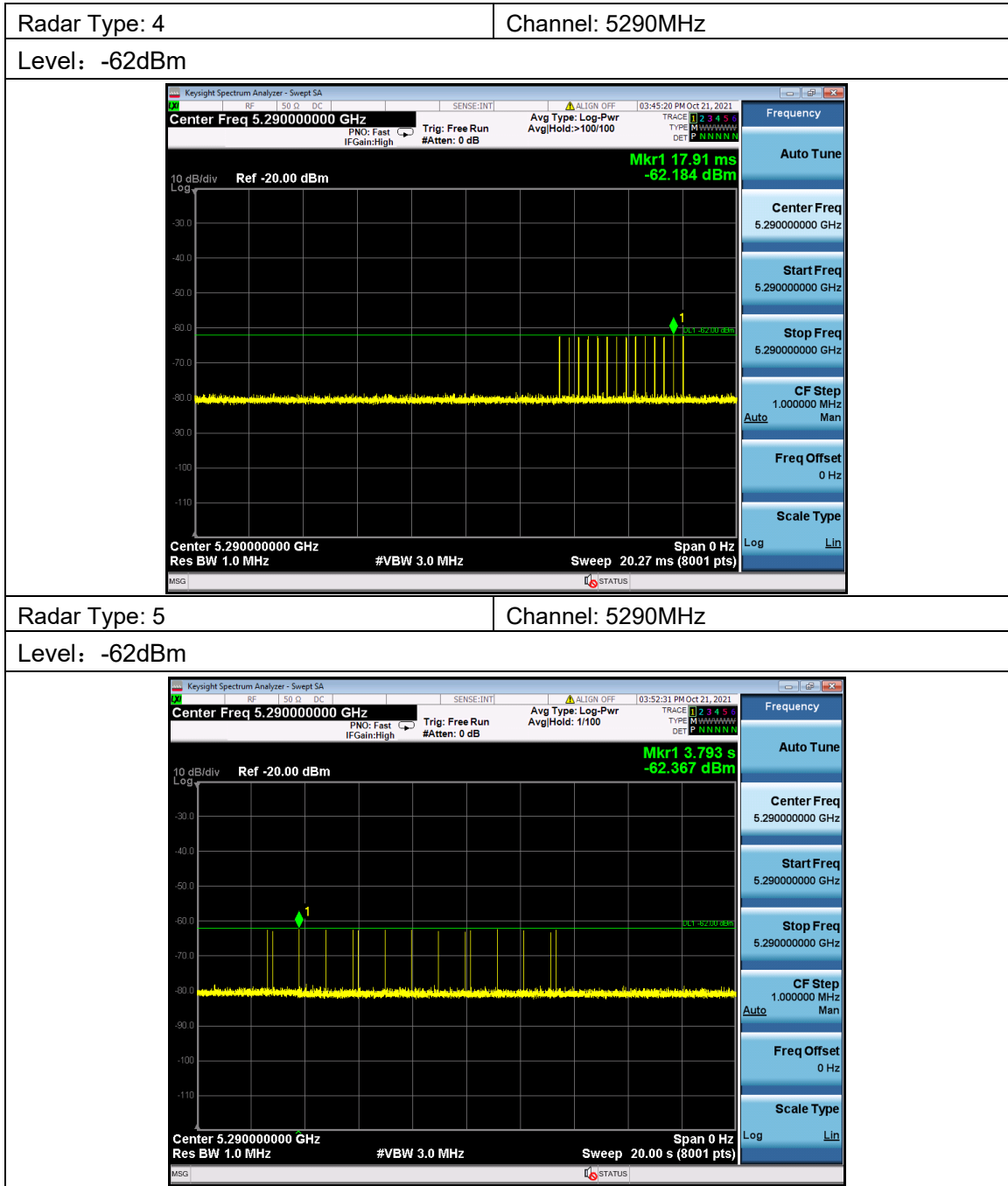

Unless otherwise agreed in writing, this document is issued by the Company subject to its General Conditions of Service printed overleaf, available on request or accessible at <http://www.sgs.com/en/Terms-and-Conditions.aspx> and, for electronic format documents, subject to Terms and Conditions for Electronic Documents at <http://www.sgs.com/en/Terms-and-Conditions/Terms-e-Documents.aspx>. Attention is drawn to the limitation of liability, indemnification and jurisdiction issues defined therein. Any holder of this document is advised that information contained hereon reflects the Company's findings at the time of its intervention only and within the limits of Client's instructions, if any. The Company's sole responsibility is to its Client and this document does not exonerate parties to a transaction from exercising all their rights and obligations under the transaction documents. This document cannot be reproduced except in full, without prior written approval of the Company. Any unauthorized alteration, forgery or falsification of the content or appearance of this document is unlawful and offenders may be prosecuted to the fullest extent of the law. Unless otherwise stated the results shown in this test report refer only to the sample(s) tested and such sample(s) are retained for 30 days only.

No.10, Weiye Road, Innovation Park, Kunshan, Jiangsu, China 215300  
中国·江苏·昆山市留学院创业园伟业路10号 邮编 215300

☎(86-512)57355888 ☎(86-512)57370818 www.sgs.com.cn  
☎(86-512)57355888 ☎(86-512)57370818 sgs.china@sgs.com

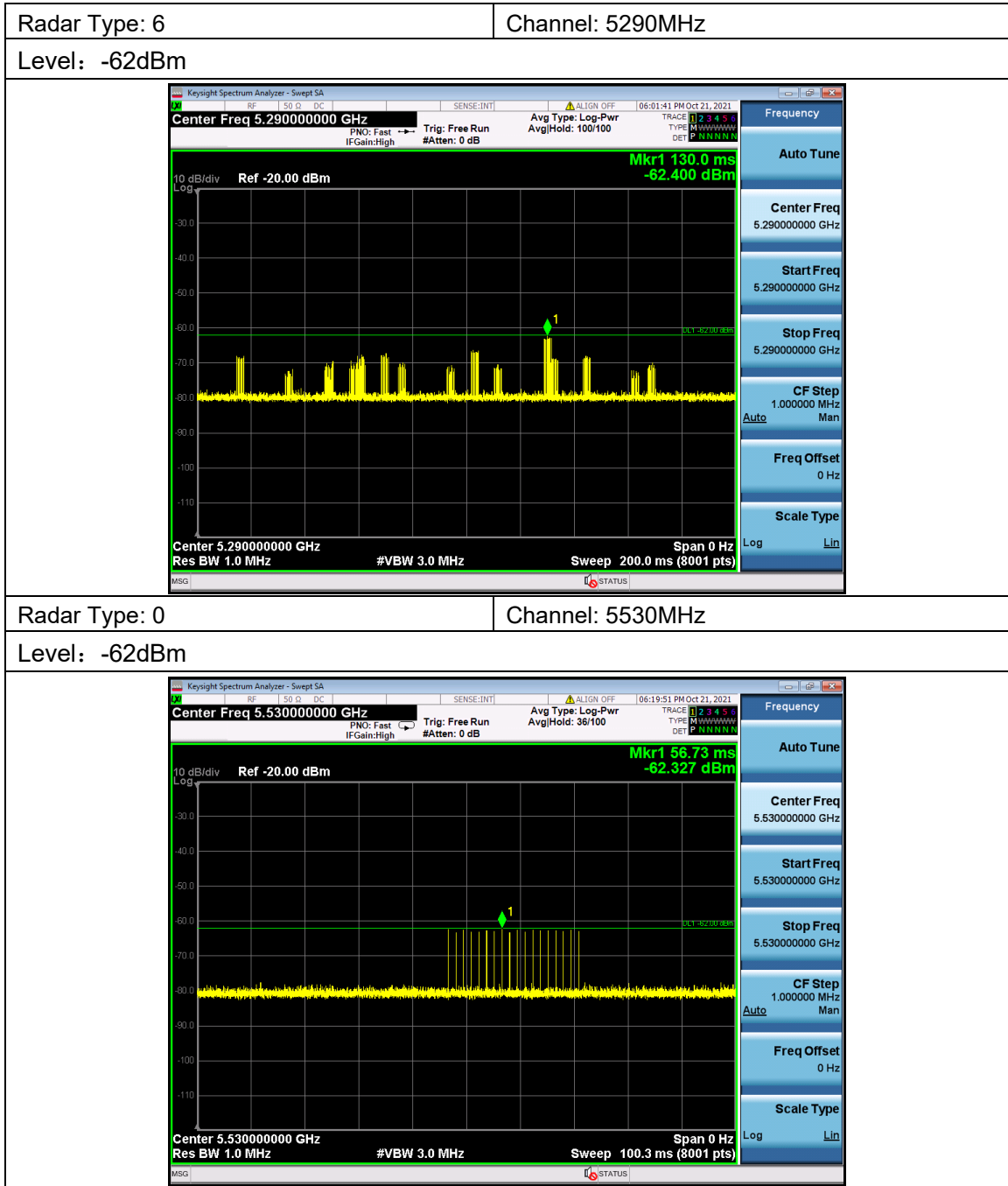

Unless otherwise agreed in writing, this document is issued by the Company subject to its General Conditions of Service printed overleaf, available on request or accessible at <http://www.sgs.com/en/Terms-and-Conditions.aspx> and, for electronic format documents, subject to Terms and Conditions for Electronic Documents at <http://www.sgs.com/en/Terms-and-Conditions/Terms-e-Documents.aspx>. Attention is drawn to the limitation of liability, indemnification and jurisdiction issues defined therein. Any holder of this document is advised that information contained hereon reflects the Company's findings at the time of its intervention only and within the limits of Client's instructions, if any. The Company's sole responsibility is to its Client and this document does not exonerate parties to a transaction from exercising all their rights and obligations under the transaction documents. This document cannot be reproduced except in full, without prior written approval of the Company. Any unauthorized alteration, forgery or falsification of the content or appearance of this document is unlawful and offenders may be prosecuted to the fullest extent of the law. Unless otherwise stated the results shown in this test report refer only to the sample(s) tested and such sample(s) are retained for 30 days only.

Attention: To check the authenticity of testing /inspection report & certificate, please contact us at telephone: (86-755) 8307 1443, or email: [CN\\_Doccheck@sgs.com](mailto:CN_Doccheck@sgs.com)

No.10, Weiye Road, Innovation Park, Kunshan, Jiangsu, China 215300  
中国·江苏·昆山市留学生创业园伟业路10号 邮编 215300

(86-512)57355888 (86-512)57370818 www.sgs.com.cn  
(86-512)57355888 (86-512)57370818 sgs.china@sgs.com



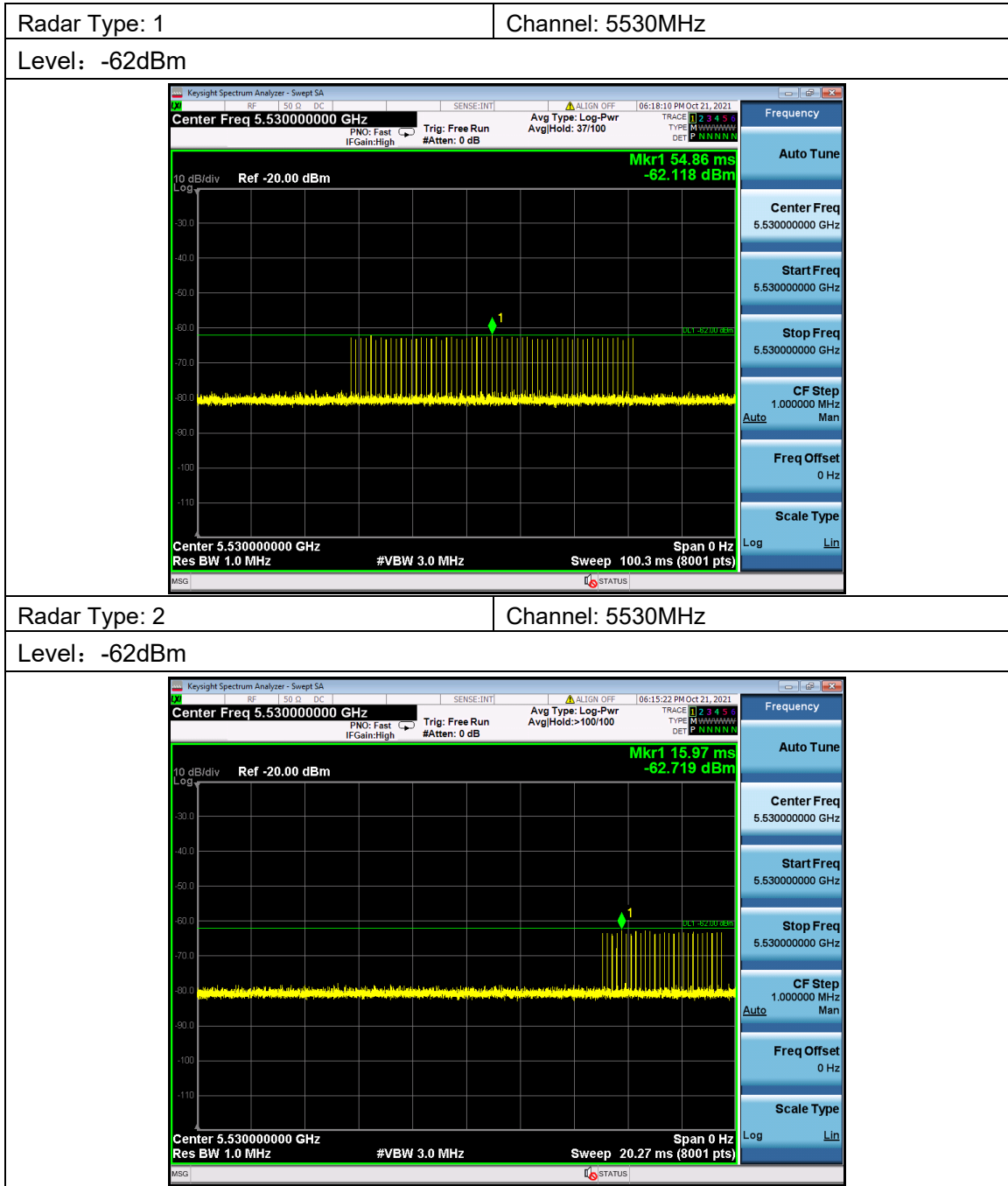

Unless otherwise agreed in writing, this document is issued by the Company subject to its General Conditions of Service printed overleaf, available on request or accessible at <http://www.sgs.com/en/Terms-and-Conditions.aspx> and, for electronic format documents, subject to Terms and Conditions for Electronic Documents at <http://www.sgs.com/en/Terms-and-Conditions/Terms-e-Documents.aspx>. Attention is drawn to the limitation of liability, indemnification and jurisdiction issues defined therein. Any holder of this document is advised that information contained hereon reflects the Company's findings at the time of its intervention only and within the limits of Client's instructions, if any. The Company's sole responsibility is to its Client and this document does not exonerate parties to a transaction from exercising all their rights and obligations under the transaction documents. This document cannot be reproduced except in full, without prior written approval of the Company. Any unauthorized alteration, forgery or falsification of the content or appearance of this document is unlawful and offenders may be prosecuted to the fullest extent of the law. Unless otherwise stated the results shown in this test report refer only to the sample(s) tested and such sample(s) are retained for 30 days only.

No.10, Weiye Road, Innovation Park, Kunshan, Jiangsu, China 215300  
中国·江苏·昆山市留学生创业园伟业路10号 邮编 215300

tel: (86-512)57355888 tel: (86-512)57370818 www.sgs.com.cn  
tel: (86-512)57355888 tel: (86-512)57370818 sgs.china@sgs.com

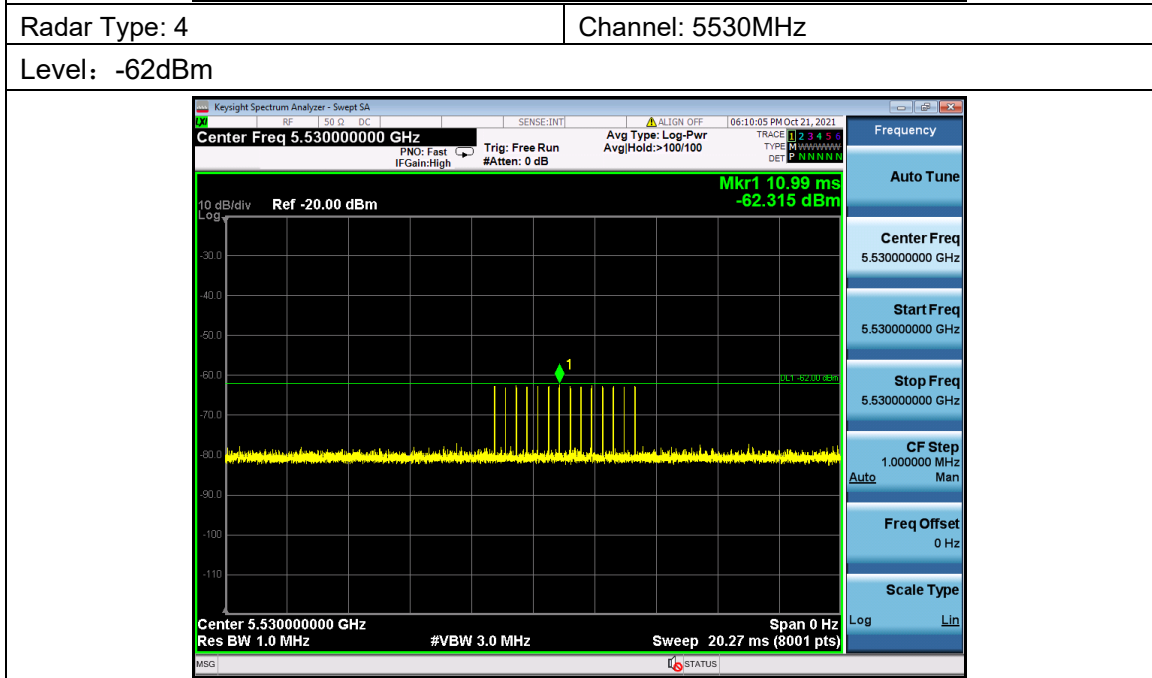
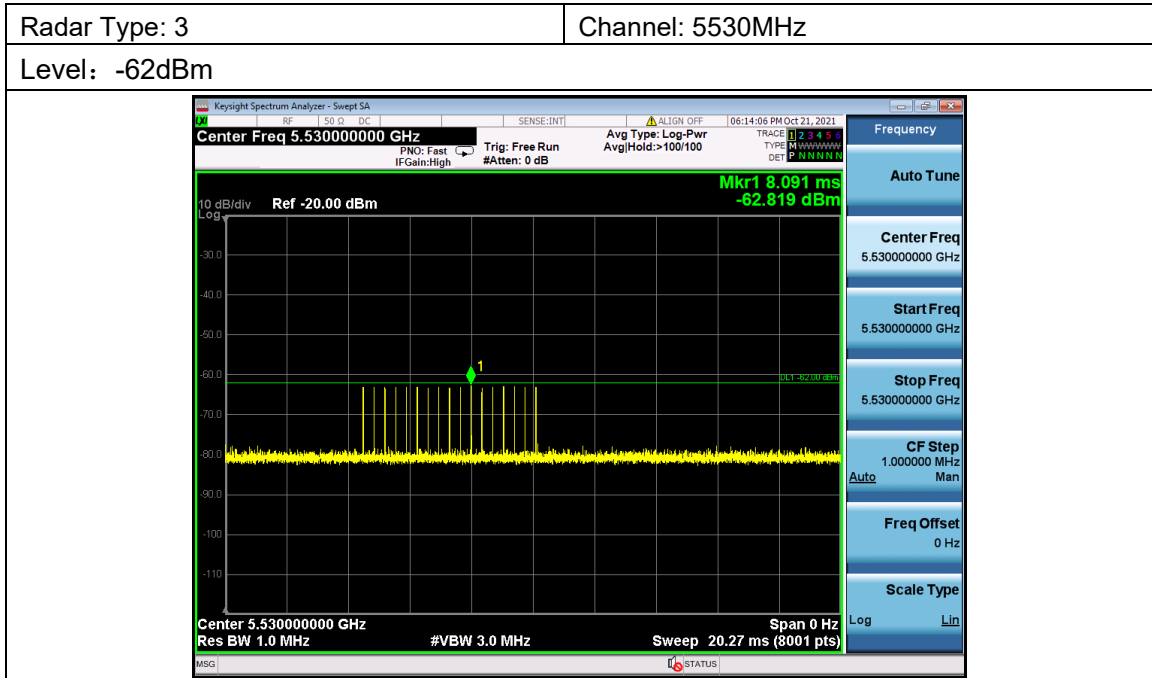

Unless otherwise agreed in writing, this document is issued by the Company subject to its General Conditions of Service printed overleaf, available on request or accessible at <http://www.sgs.com/en/Terms-and-Conditions.aspx> and, for electronic format documents, subject to Terms and Conditions for Electronic Documents at <http://www.sgs.com/en/Terms-and-Conditions/Terms-e-Documents.aspx>. Attention is drawn to the limitation of liability, indemnification and jurisdiction issues defined therein. Any holder of this document is advised that information contained hereon reflects the Company's findings at the time of its intervention only and within the limits of Client's instructions, if any. The Company's sole responsibility is to its Client and this document does not exonerate parties to a transaction from exercising all their rights and obligations under the transaction documents. This document cannot be reproduced except in full, without prior written approval of the Company. Any unauthorized alteration, forgery or falsification of the content or appearance of this document is unlawful and offenders may be prosecuted to the fullest extent of the law. Unless otherwise stated the results shown in this test report refer only to the sample(s) tested and such sample(s) are retained for 30 days only.

No.10, Weiye Road, Innovation Park, Kunshan, Jiangsu, China 215300  
中国·江苏·昆山市留学院创业园伟业路10号 邮编 215300

tel: (86-512)57355888    tel: (86-512)57370818    www.sgs.com.cn  
tel: (86-512)57355888    tel: (86-512)57370818    sgs.china@sgs.com

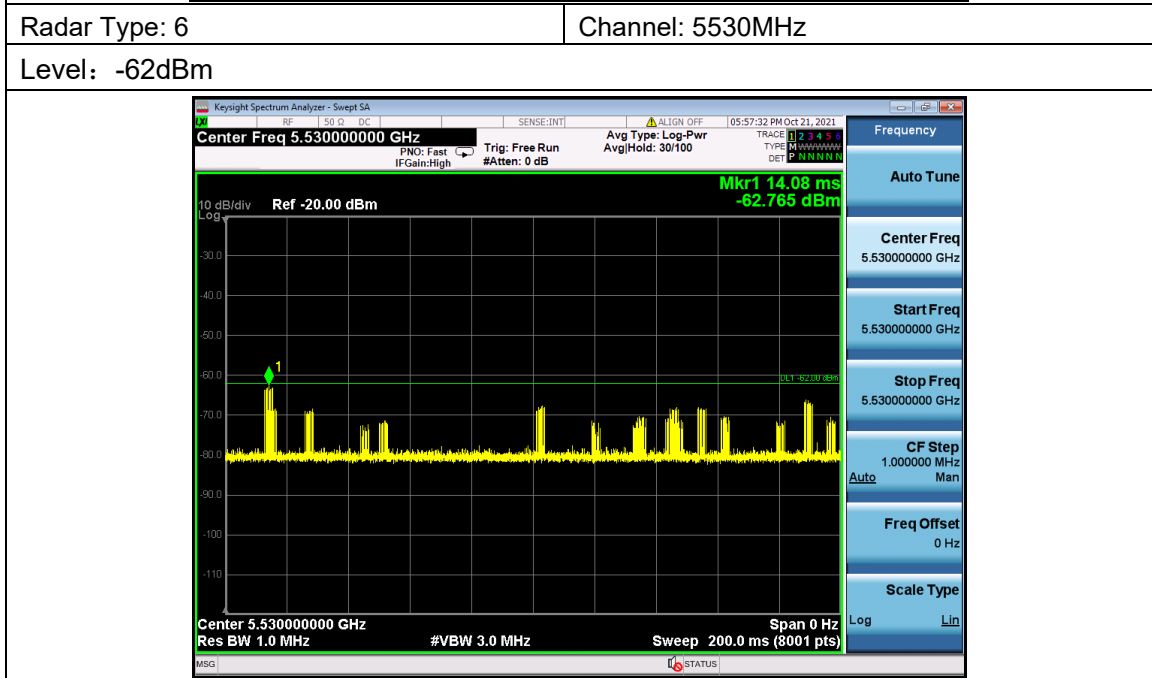
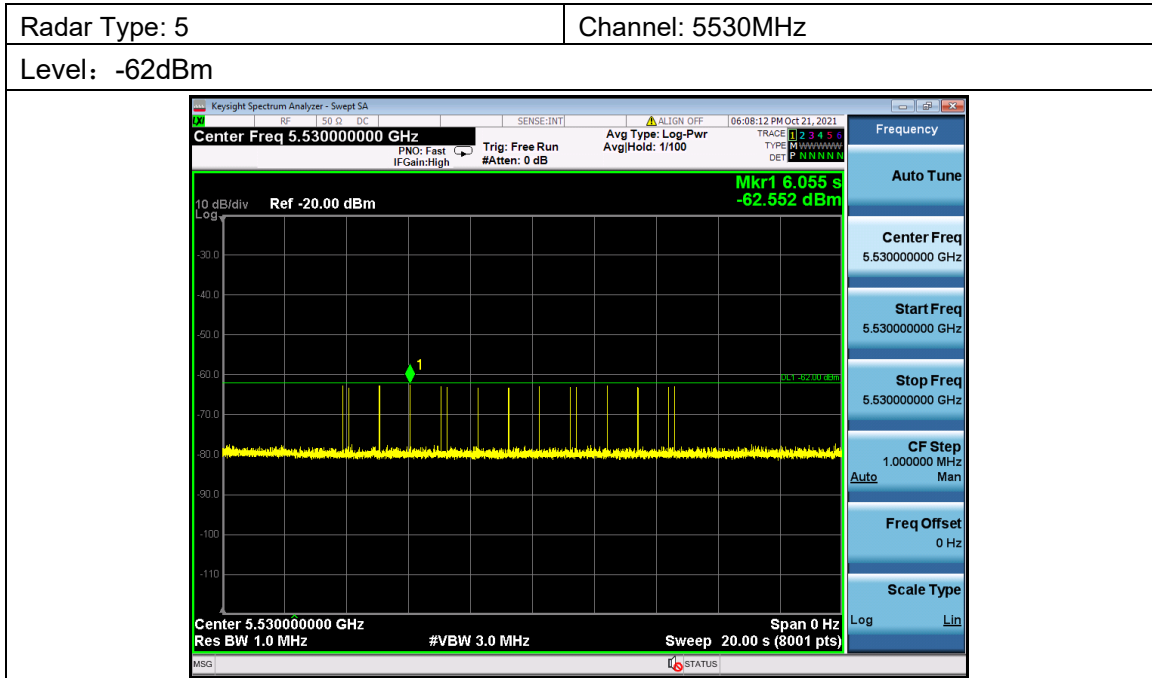

Unless otherwise agreed in writing, this document is issued by the Company subject to its General Conditions of Service printed overleaf, available on request or accessible at <http://www.sgs.com/en/Terms-and-Conditions.aspx> and, for electronic format documents, subject to Terms and Conditions for Electronic Documents at <http://www.sgs.com/en/Terms-and-Conditions/Terms-e-Documents.aspx>. Attention is drawn to the limitation of liability, indemnification and jurisdiction issues defined therein. Any holder of this document is advised that information contained hereon reflects the Company's findings at the time of its intervention only and within the limits of Client's instructions, if any. The Company's sole responsibility is to its Client and this document does not exonerate parties to a transaction from exercising all their rights and obligations under the transaction documents. This document cannot be reproduced except in full, without prior written approval of the Company. Any unauthorized alteration, forgery or falsification of the content or appearance of this document is unlawful and offenders may be prosecuted to the fullest extent of the law. Unless otherwise stated the results shown in this test report refer only to the sample(s) tested and such sample(s) are retained for 30 days only.

No.10, Weiye Road, Innovation Park, Kunshan, Jiangsu, China 215300  
中国·江苏·昆山市留学院创业园伟业路10号 邮编 215300

☎(86-512)57355888 ☎(86-512)57370818 www.sgsgroup.com.cn  
☎(86-512)57355888 ☎(86-512)57370818 sgs.china@sgs.com

6.9.2 Channel Loading

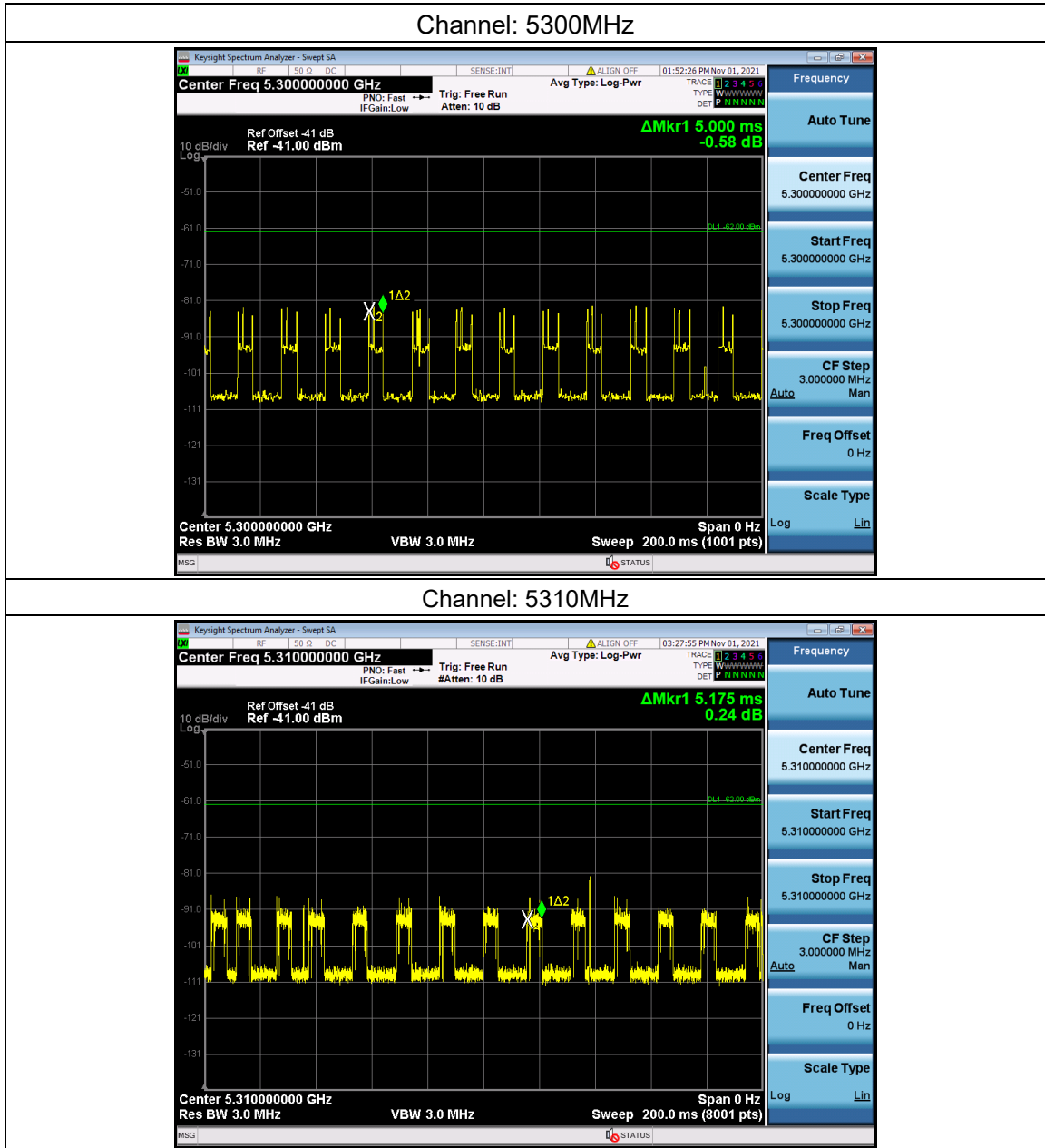

Unless otherwise agreed in writing, this document is issued by the Company subject to its General Conditions of Service printed overleaf, available on request or accessible at <http://www.sgs.com/en/Terms-and-Conditions.aspx> and, for electronic format documents, subject to Terms and Conditions for Electronic Documents at <http://www.sgs.com/en/Terms-and-Conditions/Terms-e-Documents.aspx>. Attention is drawn to the limitation of liability, indemnification and jurisdiction issues defined therein. Any holder of this document is advised that information contained hereon reflects the Company's findings at the time of its intervention only and within the limits of Client's instructions, if any. The Company's sole responsibility is to its Client and this document does not exonerate parties to a transaction from exercising all their rights and obligations under the transaction documents. This document cannot be reproduced except in full, without prior written approval of the Company. Any unauthorized alteration, forgery or falsification of the content or appearance of this document is unlawful and offenders may be prosecuted to the fullest extent of the law. Unless otherwise stated the results shown in this test report refer only to the sample(s) tested and such sample(s) are retained for 30 days only.

No.10, Weiye Road, Innovation Park, Kunshan, Jiangsu, China 215300  
中国·江苏·昆山市留学生创业园伟业路10号 邮编 215300

+(86-512)57355888 +(86-512)57370818 www.sgs.com.cn  
+(86-512)57355888 +(86-512)57370818 sgs.china@sgs.com



Channel: 5290MHz

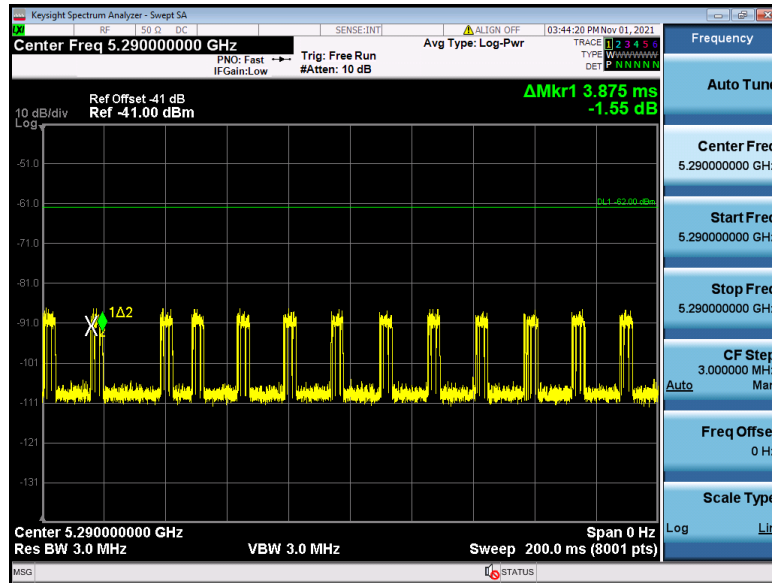

Channel: 5500MHz

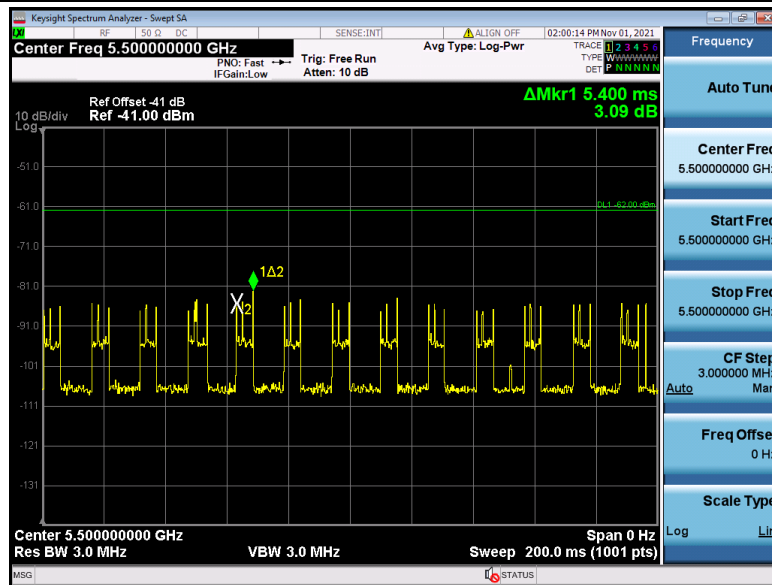

Unless otherwise agreed in writing, this document is issued by the Company subject to its General Conditions of Service printed overleaf, available on request or accessible at <http://www.sgs.com/en/Terms-and-Conditions.aspx> and, for electronic format documents, subject to Terms and Conditions for Electronic Documents at <http://www.sgs.com/en/Terms-and-Conditions/Terms-e-Documents.aspx>. Attention is drawn to the limitation of liability, indemnification and jurisdiction issues defined therein. Any holder of this document is advised that information contained hereon reflects the Company's findings at the time of its intervention only and within the limits of Client's instructions, if any. The Company's sole responsibility is to its Client and this document does not exonerate parties to a transaction from exercising all their rights and obligations under the transaction documents. This document cannot be reproduced except in full, without prior written approval of the Company. Any unauthorized alteration, forgery or falsification of the content or appearance of this document is unlawful and offenders may be prosecuted to the fullest extent of the law. Unless otherwise stated the results shown in this test report refer only to the sample(s) tested and such sample(s) are retained for 30 days only.  
Attention: To check the authenticity of testing /inspection report & certificate, please contact us at telephone: (86-755) 8307 1443, or email: [CN\\_Doccheck@sgs.com](mailto:CN_Doccheck@sgs.com)

No.10, Weiye Road, Innovation Park, Kunshan, Jiangsu, China 215300  
中国·江苏·昆山市留学生创业园伟业路10号 邮编 215300

t(86-512)57355888 f(86-512)57370818 www.sgs.com.cn  
t(86-512)57355888 f(86-512)57370818 sgs.china@sgs.com

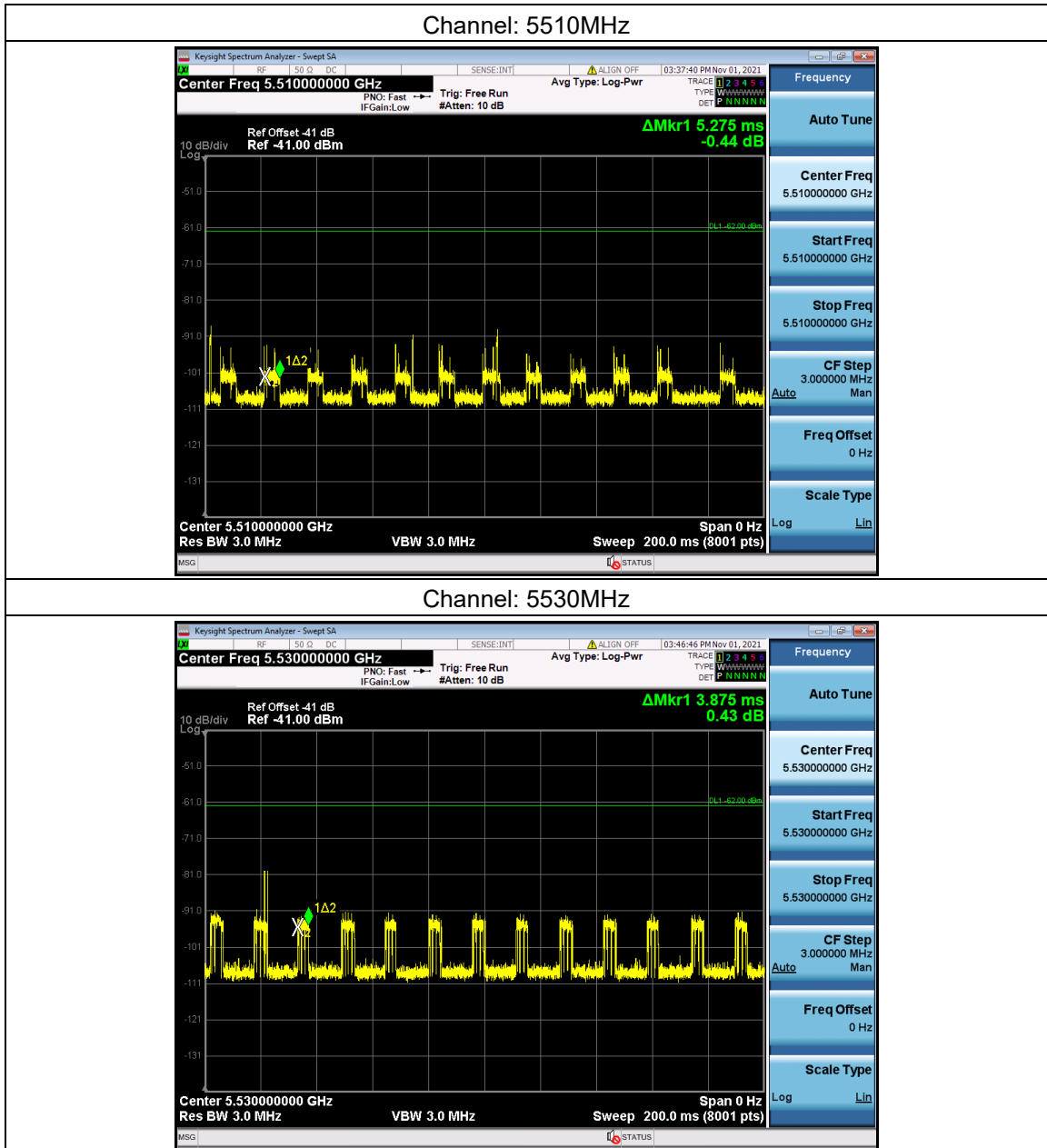

Test channel	Requirement ratio	Test Result
5290	17%	Pass
5300	17%	Pass
5310	17%	Pass
5500	17%	Pass
5510	17%	Pass
5530	17%	Pass



Unless otherwise agreed in writing, this document is issued by the Company subject to its General Conditions of Service printed overleaf, available on request or accessible at <http://www.sgs.com/en/Terms-and-Conditions.aspx> and, for electronic format documents, subject to Terms and Conditions for Electronic Documents at <http://www.sgs.com/en/Terms-and-Conditions/Terms-e-Documents.aspx>. Attention is drawn to the limitation of liability, indemnification and jurisdiction issues defined therein. Any holder of this document is advised that information contained hereon reflects the Company's findings at the time of its intervention only and within the limits of Client's instructions, if any. The Company's sole responsibility is to its Client and this document does not exonerate parties to a transaction from exercising all their rights and obligations under the transaction documents. This document cannot be reproduced except in full, without prior written approval of the Company. Any unauthorized alteration, forgery or falsification of the content or appearance of this document is unlawful and offenders may be prosecuted to the fullest extent of the law. Unless otherwise stated the results shown in this test report refer only to the sample(s) tested and such sample(s) are retained for 30 days only.

Attention: To check the authenticity of testing /inspection report & certificate, please contact us at telephone: (86-755) 8307 1443, or email: [CN\\_Doccheck@sgs.com](mailto:CN_Doccheck@sgs.com)  
 No.10, Weiye Road, Innovation Park, Kunshan, Jiangsu, China 215300      t(86-512)57355888      f(86-512)57370818      www.sgs.com.cn  
 中国·江苏·昆山市留学院创业园伟业路10号 邮编 215300      t(86-512)57355888      f(86-512)57370818      sgs.china@sgs.com

6.9.3 Detection Bandwidth

20 MHz Signal Bandwidth											
EUT Frequency = 5300MHz											
Radar Frequency (MHz)	DFS Detection Trials (1=Detection, Blank= No Detection)										Detection Rate (%)
	1	2	3	4	5	6	7	8	9	10	
5289	0	0	0	0	0	0	0	0	0	0	0%
5290 FI	1	1	1	1	1	1	1	1	1	1	100%
5291	1	1	1	1	1	1	1	1	1	1	100%
5292	1	1	1	1	1	1	1	1	1	1	100%
5293	1	1	1	1	1	1	1	1	1	1	100%
5294	1	1	1	1	1	1	1	1	1	1	100%
5295	1	1	1	1	1	1	1	1	1	1	100%
5296	1	1	1	1	1	1	1	1	1	1	100%
5297	1	1	1	1	1	1	1	1	1	1	100%
5298	1	1	1	1	1	1	1	1	1	1	100%
5299	1	1	1	1	1	1	1	1	1	1	100%
5300	1	1	1	1	1	1	1	1	1	1	100%
5301	1	1	1	1	1	1	1	1	1	1	100%
5302	1	1	1	1	1	1	1	1	1	1	100%
5303	1	1	1	1	1	1	1	1	1	1	100%
5304	1	1	1	1	1	1	1	1	1	1	100%
5305	1	1	1	1	1	1	1	1	1	1	100%
5306	1	1	1	1	1	1	1	1	1	1	100%
5307	1	1	1	1	1	1	1	1	1	1	100%
5308	1	1	1	1	1	1	1	1	1	1	100%
5309	1	1	1	1	1	1	1	1	1	1	100%
5310 Fh	1	1	1	1	1	1	1	1	1	1	100%
5311	0	0	0	0	0	0	0	0	0	0	0%
Detection Bandwidth = Fh-FI = 5310MHz - 5290MHz = 20MHz											
EUT 99% Bandwidth = 18.148MHz											
18.148MHz × 80% =14.518MHz											



Unless otherwise agreed in writing, this document is issued by the Company subject to its General Conditions of Service printed overleaf, available on request or accessible at <http://www.sgs.com/en/Terms-and-Conditions.aspx> and, for electronic format documents, subject to Terms and Conditions for Electronic Documents at <http://www.sgs.com/en/Terms-and-Conditions/Terms-e-Documents.aspx>. Attention is drawn to the limitation of liability, indemnification and jurisdiction issues defined therein. Any holder of this document is advised that information contained hereon reflects the Company's findings at the time of its intervention only and within the limits of Client's instructions, if any. The Company's sole responsibility is to its Client and this document does not exonerate parties to a transaction from exercising all their rights and obligations under the transaction documents. This document cannot be reproduced except in full, without prior written approval of the Company. Any unauthorized alteration, forgery or falsification of the content or appearance of this document is unlawful and offenders may be prosecuted to the fullest extent of the law. Unless otherwise stated the results shown in this test report refer only to the sample(s) tested and such sample(s) are retained for 30 days only.

Attention: To check the authenticity of testing /inspection report & certificate, please contact us at telephone: (86-755) 8307 1443, or email: [CN.Doccheck@sgs.com](mailto:CN.Doccheck@sgs.com)  
 No.10, Weiye Road, Innovation Park, Kunshan, Jiangsu, China 215300      t(86-512)57355888      f(86-512)57370818      www.sgsgroup.com.cn  
 中国·江苏·昆山市留学生创业园伟业路10号 邮编 215300      t(86-512)57355888      f(86-512)57370818      sgs.china@sgs.com

20 MHz Signal Bandwidth											
EUT Frequency = 5500MHz											
Radar Frequency (MHz)	DFS Detection Trials (1=Detection, Blank= No Detection)										Detection Rate (%)
	1	2	3	4	5	6	7	8	9	10	
5489	0	0	0	0	0	0	0	0	0	0	0%
5490 F1	1	1	1	1	1	1	1	1	1	1	100%
5491	1	1	1	1	1	1	1	1	1	1	100%
5492	1	1	1	1	1	1	1	1	1	1	100%
5493	1	1	1	1	1	1	1	1	1	1	100%
5494	1	1	1	1	1	1	1	1	1	1	100%
5495	1	1	1	1	1	1	1	1	1	1	100%
5496	1	1	1	1	1	1	1	1	1	1	100%
5497	1	1	1	1	1	1	1	1	1	1	100%
5498	1	1	1	1	1	1	1	1	1	1	100%
5499	1	1	1	1	1	1	1	1	1	1	100%
5500	1	1	1	1	1	1	1	1	1	1	100%
5501	1	1	1	1	1	1	1	1	1	1	100%
5502	1	1	1	1	1	1	1	1	1	1	100%
5503	1	1	1	1	1	1	1	1	1	1	100%
5504	1	1	1	1	1	1	1	1	1	1	100%
5505	1	1	1	1	1	1	1	1	1	1	100%
5506	1	1	1	1	1	1	1	1	1	1	100%
5507	1	1	1	1	1	1	1	1	1	1	100%
5508	1	1	1	1	1	1	1	1	1	1	100%
5509	1	1	1	1	1	1	1	1	1	1	100%
5510 Fh	1	1	1	1	1	1	1	1	1	1	100%
5511	0	0	0	0	0	0	0	0	0	0	0%
Detection Bandwidth = Fh-F1 = 5510MHz - 5490MHz = 20MHz											
EUT 99% Bandwidth = 18.147MHz											
18.147MHz × 80% =14.518MHz											



Unless otherwise agreed in writing, this document is issued by the Company subject to its General Conditions of Service printed overleaf, available on request or accessible at <http://www.sgs.com/en/Terms-and-Conditions.aspx> and, for electronic format documents, subject to Terms and Conditions for Electronic Documents at <http://www.sgs.com/en/Terms-and-Conditions/Terms-e-Documents.aspx>. Attention is drawn to the limitation of liability, indemnification and jurisdiction issues defined therein. Any holder of this document is advised that information contained hereon reflects the Company's findings at the time of its intervention only and within the limits of Client's instructions, if any. The Company's sole responsibility is to its Client and this document does not exonerate parties to a transaction from exercising all their rights and obligations under the transaction documents. This document cannot be reproduced except in full, without prior written approval of the Company. Any unauthorized alteration, forgery or falsification of the content or appearance of this document is unlawful and offenders may be prosecuted to the fullest extent of the law. Unless otherwise stated the results shown in this test report refer only to the sample(s) tested and such sample(s) are retained for 30 days only.  
Attention: To check the authenticity of testing /inspection report & certificate, please contact us at telephone: (86-755) 8307 1443, or email: [CN.Doccheck@sgs.com](mailto:CN.Doccheck@sgs.com)

No.10, Weiye Road, Innovation Park, Kunshan, Jiangsu, China 215300  
中国·江苏·昆山市留学院创业园伟业路10号 邮编 215300

t(86-512)57355888 f(86-512)57370818 www.sgs.com.cn  
t(86-512)57355888 f(86-512)57370818 sgs.china@sgs.com

40 MHz Signal Bandwidth											
EUT Frequency = 5310MHz											
Radar Frequency (MHz)	DFS Detection Trials (1=Detection, Blank= No Detection)										Detection Rate (%)
	1	2	3	4	5	6	7	8	9	10	
5289	0	0	0	0	0	0	0	0	0	0	0%
5290 FI	1	1	1	1	1	1	1	1	1	1	100%
5291	1	1	1	1	1	1	1	1	1	1	100%
5292	1	1	1	1	1	1	1	1	1	1	100%
5293	1	1	1	1	1	1	1	1	1	1	100%
5294	1	1	1	1	1	1	1	1	1	1	100%
5295	1	1	1	1	1	1	1	1	1	1	100%
5296	1	1	1	1	1	1	1	1	1	1	100%
5297	1	1	1	1	1	1	1	1	1	1	100%
5298	1	1	1	1	1	1	1	1	1	1	100%
5299	1	1	1	1	1	1	1	1	1	1	100%
5300	1	1	1	1	1	1	1	1	1	1	100%
5301	1	1	1	1	1	1	1	1	1	1	100%
5302	1	1	1	1	1	1	1	1	1	1	100%
5303	1	1	1	1	1	1	1	1	1	1	100%
5304	1	1	1	1	1	1	1	1	1	1	100%
5305	1	1	1	1	1	1	1	1	1	1	100%
5306	1	1	1	1	1	1	1	1	1	1	100%
5307	1	1	1	1	1	1	1	1	1	1	100%
5308	1	1	1	1	1	1	1	1	1	1	100%
5309	1	1	1	1	1	1	1	1	1	1	100%
5310	1	1	1	1	1	1	1	1	1	1	100%
5311	1	1	1	1	1	1	1	1	1	1	100%
5312	1	1	1	1	1	1	1	1	1	1	100%
5313	1	1	1	1	1	1	1	1	1	1	100%
5314	1	1	1	1	1	1	1	1	1	1	100%
5315	1	1	1	1	1	1	1	1	1	1	100%
5316	1	1	1	1	1	1	1	1	1	1	100%
5317	1	1	1	1	1	1	1	1	1	1	100%
5318	1	1	1	1	1	1	1	1	1	1	100%
5319	1	1	1	1	1	1	1	1	1	1	100%
5320	1	1	1	1	1	1	1	1	1	1	100%



Unless otherwise agreed in writing, this document is issued by the Company subject to its General Conditions of Service printed overleaf, available on request or accessible at <http://www.sgs.com/en/Terms-and-Conditions.aspx> and, for electronic format documents, subject to Terms and Conditions for Electronic Documents at <http://www.sgs.com/en/Terms-and-Conditions/Terms-e-Documents.aspx>. Attention is drawn to the limitation of liability, indemnification and jurisdiction issues defined therein. Any holder of this document is advised that information contained hereon reflects the Company's findings at the time of its intervention only and within the limits of Client's instructions, if any. The Company's sole responsibility is to its Client and this document does not exonerate parties to a transaction from exercising all their rights and obligations under the transaction documents. This document cannot be reproduced except in full, without prior written approval of the Company. Any unauthorized alteration, forgery or falsification of the content or appearance of this document is unlawful and offenders may be prosecuted to the fullest extent of the law. Unless otherwise stated the results shown in this test report refer only to the sample(s) tested and such sample(s) are retained for 30 days only.

Attention: To check the authenticity of testing /inspection report & certificate, please contact us at telephone: (86-755) 8307 1443, or email: [CN.Doccheck@sgs.com](mailto:CN.Doccheck@sgs.com)  
 No.10, Weiye Road, Innovation Park, Kunshan, Jiangsu, China 215300      t(86-512)57355888      f(86-512)57370818      www.sgs.com.cn  
 中国·江苏·昆山市留学院创业园伟业路10号 邮编 215300      t(86-512)57355888      f(86-512)57370818      sgs.china@sgs.com



5321	1	1	1	1	1	1	1	1	1	1	100%
5322	1	1	1	1	1	1	1	1	1	1	100%
5323	1	1	1	1	1	1	1	1	1	1	100%
5324	1	1	1	1	1	1	1	1	1	1	100%
5325	1	1	1	1	1	1	1	1	1	1	100%
5326	1	1	1	1	1	1	1	1	1	1	100%
5327	1	1	1	1	1	1	1	1	1	1	100%
5328	1	1	1	1	1	1	1	1	1	1	100%
5329	1	1	1	1	1	1	1	1	1	1	100%
5330 Fh	1	1	1	1	1	1	1	1	1	1	100%
5331	0	0	0	0	0	0	0	0	0	0	0%
Detection Bandwidth = Fh-FI = 5330MHz - 5290MHz = 40MHz											
EUT 99% Bandwidth = 37.042MHz											
37.042MHz × 80% =29.634MHz											



Unless otherwise agreed in writing, this document is issued by the Company subject to its General Conditions of Service printed overleaf, available on request or accessible at <http://www.sgs.com/en/Terms-and-Conditions.aspx> and, for electronic format documents, subject to Terms and Conditions for Electronic Documents at <http://www.sgs.com/en/Terms-and-Conditions/Terms-e-Documents.aspx>. Attention is drawn to the limitation of liability, indemnification and jurisdiction issues defined therein. Any holder of this document is advised that information contained hereon reflects the Company's findings at the time of its intervention only and within the limits of Client's instructions, if any. The Company's sole responsibility is to its Client and this document does not exonerate parties to a transaction from exercising all their rights and obligations under the transaction documents. This document cannot be reproduced except in full, without prior written approval of the Company. Any unauthorized alteration, forgery or falsification of the content or appearance of this document is unlawful and offenders may be prosecuted to the fullest extent of the law. Unless otherwise stated the results shown in this test report refer only to the sample(s) tested and such sample(s) are retained for 30 days only.

Attention: To check the authenticity of testing /inspection report & certificate, please contact us at telephone: (86-755) 8307 1443, or email: [CN.Doccheck@sgs.com](mailto:CN.Doccheck@sgs.com)

No.10, Weiye Road, Innovation Park, Kunshan, Jiangsu, China 215300  
 中国·江苏·昆山市留学生创业园伟业路10号 邮编 215300

t(86-512)57355888 f(86-512)57370818 www.sgsgroup.com.cn  
 t(86-512)57355888 f(86-512)57370818 sgs.china@sgs.com

40 MHz Signal Bandwidth											
EUT Frequency = 5510MHz											
Radar Frequency (MHz)	DFS Detection Trials (1=Detection, Blank= No Detection)										Detection Rate (%)
	1	2	3	4	5	6	7	8	9	10	
5489	0	0	0	0	0	0	0	0	0	0	0%
5490 FI	1	1	1	1	1	1	1	1	1	1	100%
5491	1	1	1	1	1	1	1	1	1	1	100%
5492	1	1	1	1	1	1	1	1	1	1	100%
5493	1	1	1	1	1	1	1	1	1	1	100%
5494	1	1	1	1	1	1	1	1	1	1	100%
5495	1	1	1	1	1	1	1	1	1	1	100%
5496	1	1	1	1	1	1	1	1	1	1	100%
5497	1	1	1	1	1	1	1	1	1	1	100%
5498	1	1	1	1	1	1	1	1	1	1	100%
5499	1	1	1	1	1	1	1	1	1	1	100%
5500	1	1	1	1	1	1	1	1	1	1	100%
5501	1	1	1	1	1	1	1	1	1	1	100%
5502	1	1	1	1	1	1	1	1	1	1	100%
5503	1	1	1	1	1	1	1	1	1	1	100%
5504	1	1	1	1	1	1	1	1	1	1	100%
5505	1	1	1	1	1	1	1	1	1	1	100%
5506	1	1	1	1	1	1	1	1	1	1	100%
5507	1	1	1	1	1	1	1	1	1	1	100%
5508	1	1	1	1	1	1	1	1	1	1	100%
5509	1	1	1	1	1	1	1	1	1	1	100%
5510	1	1	1	1	1	1	1	1	1	1	100%
5511	1	1	1	1	1	1	1	1	1	1	100%
5512	1	1	1	1	1	1	1	1	1	1	100%
5513	1	1	1	1	1	1	1	1	1	1	100%
5514	1	1	1	1	1	1	1	1	1	1	100%
5515	1	1	1	1	1	1	1	1	1	1	100%
5516	1	1	1	1	1	1	1	1	1	1	100%
5517	1	1	1	1	1	1	1	1	1	1	100%
5518	1	1	1	1	1	1	1	1	1	1	100%
5519	1	1	1	1	1	1	1	1	1	1	100%
5520	1	1	1	1	1	1	1	1	1	1	100%



Unless otherwise agreed in writing, this document is issued by the Company subject to its General Conditions of Service printed overleaf, available on request or accessible at <http://www.sgs.com/en/Terms-and-Conditions.aspx> and, for electronic format documents, subject to Terms and Conditions for Electronic Documents at <http://www.sgs.com/en/Terms-and-Conditions/Terms-e-Documents.aspx>. Attention is drawn to the limitation of liability, indemnification and jurisdiction issues defined therein. Any holder of this document is advised that information contained hereon reflects the Company's findings at the time of its intervention only and within the limits of Client's instructions, if any. The Company's sole responsibility is to its Client and this document does not exonerate parties to a transaction from exercising all their rights and obligations under the transaction documents. This document cannot be reproduced except in full, without prior written approval of the Company. Any unauthorized alteration, forgery or falsification of the content or appearance of this document is unlawful and offenders may be prosecuted to the fullest extent of the law. Unless otherwise stated the results shown in this test report refer only to the sample(s) tested and such sample(s) are retained for 30 days only.

Attention: To check the authenticity of testing /inspection report & certificate, please contact us at telephone: (86-755) 8307 1443, or email: [CN.Doccheck@sgs.com](mailto:CN.Doccheck@sgs.com)  
 No.10, Weiye Road, Innovation Park, Kunshan, Jiangsu, China 215300      t(86-512)57355888      f(86-512)57370818      www.sgs.com.cn  
 中国·江苏·昆山市留学院创业园伟业路10号 邮编 215300      t(86-512)57355888      f(86-512)57370818      sgs.china@sgs.com

5521	1	1	1	1	1	1	1	1	1	1	100%
5522	1	1	1	1	1	1	1	1	1	1	100%
5523	1	1	1	1	1	1	1	1	1	1	100%
5524	1	1	1	1	1	1	1	1	1	1	100%
5525	1	1	1	1	1	1	1	1	1	1	100%
5526	1	1	1	1	1	1	1	1	1	1	100%
5527	1	1	1	1	1	1	1	1	1	1	100%
5528	1	1	1	1	1	1	1	1	1	1	100%
5529	1	1	1	1	1	1	1	1	1	1	100%
5530 Fh	1	1	1	1	1	1	1	1	1	1	100%
5531	0	0	0	0	0	0	0	0	0	0	0%
Detection Bandwidth = Fh-Fl = 5530MHz - 5490MHz = 40MHz											
EUT 99% Bandwidth = 37.136MHz											
37.136MHz × 80% =29.709MHz											



Unless otherwise agreed in writing, this document is issued by the Company subject to its General Conditions of Service printed overleaf, available on request or accessible at <http://www.sgs.com/en/Terms-and-Conditions.aspx> and, for electronic format documents, subject to Terms and Conditions for Electronic Documents at <http://www.sgs.com/en/Terms-and-Conditions/Terms-e-Documents.aspx>. Attention is drawn to the limitation of liability, indemnification and jurisdiction issues defined therein. Any holder of this document is advised that information contained hereon reflects the Company's findings at the time of its intervention only and within the limits of Client's instructions, if any. The Company's sole responsibility is to its Client and this document does not exonerate parties to a transaction from exercising all their rights and obligations under the transaction documents. This document cannot be reproduced except in full, without prior written approval of the Company. Any unauthorized alteration, forgery or falsification of the content or appearance of this document is unlawful and offenders may be prosecuted to the fullest extent of the law. Unless otherwise stated the results shown in this test report refer only to the sample(s) tested and such sample(s) are retained for 30 days only.  
Attention: To check the authenticity of testing /inspection report & certificate, please contact us at telephone: (86-755) 8307 1443, or email: [CN.Doccheck@sgs.com](mailto:CN.Doccheck@sgs.com)

No.10, Weiye Road, Innovation Park, Kunshan, Jiangsu, China 215300  
中国·江苏·昆山市留学生创业园伟业路10号 邮编 215300

☎(86-512)57355888 ☎(86-512)57370818 [www.sgsgroup.com.cn](http://www.sgsgroup.com.cn)  
☎(86-512)57355888 ☎(86-512)57370818 [sgs.china@sgs.com](mailto:sgs.china@sgs.com)

80 MHz Signal Bandwidth											
EUT Frequency = 5290MHz											
Radar Frequency (MHz)	DFS Detection Trials (1=Detection, Blank= No Detection)										Detection Rate (%)
	1	2	3	4	5	6	7	8	9	10	
5249	0	0	0	0	0	0	0	0	0	0	0%
5250 FI	1	1	1	1	1	1	1	1	1	1	100%
5251	1	1	1	1	1	1	1	1	1	1	100%
5252	1	1	1	1	1	1	1	1	1	1	100%
5253	1	1	1	1	1	1	1	1	1	1	100%
5254	1	1	1	1	1	1	1	1	1	1	100%
5255	1	1	1	1	1	1	1	1	1	1	100%
5256	1	1	1	1	1	1	1	1	1	1	100%
5257	1	1	1	1	1	1	1	1	1	1	100%
5258	1	1	1	1	1	1	1	1	1	1	100%
5259	1	1	1	1	1	1	1	1	1	1	100%
5260	1	1	1	1	1	1	1	1	1	1	100%
5261	1	1	1	1	1	1	1	1	1	1	100%
5262	1	1	1	1	1	1	1	1	1	1	100%
5263	1	1	1	1	1	1	1	1	1	1	100%
5264	1	1	1	1	1	1	1	1	1	1	100%
5265	1	1	1	1	1	1	1	1	1	1	100%
5266	1	1	1	1	1	1	1	1	1	1	100%
5267	1	1	1	1	1	1	1	1	1	1	100%
5268	1	1	1	1	1	1	1	1	1	1	100%
5269	1	1	1	1	1	1	1	1	1	1	100%
5270	1	1	1	1	1	1	1	1	1	1	100%
5271	1	1	1	1	1	1	1	1	1	1	100%
5272	1	1	1	1	1	1	1	1	1	1	100%
5273	1	1	1	1	1	1	1	1	1	1	100%
5274	1	1	1	1	1	1	1	1	1	1	100%
5275	1	1	1	1	1	1	1	1	1	1	100%
5276	1	1	1	1	1	1	1	1	1	1	100%
5277	1	1	1	1	1	1	1	1	1	1	100%
5278	1	1	1	1	1	1	1	1	1	1	100%
5279	1	1	1	1	1	1	1	1	1	1	100%
5280	1	1	1	1	1	1	1	1	1	1	100%



Unless otherwise agreed in writing, this document is issued by the Company subject to its General Conditions of Service printed overleaf, available on request or accessible at <http://www.sgs.com/en/Terms-and-Conditions.aspx> and, for electronic format documents, subject to Terms and Conditions for Electronic Documents at <http://www.sgs.com/en/Terms-and-Conditions/Terms-e-Documents.aspx>. Attention is drawn to the limitation of liability, indemnification and jurisdiction issues defined therein. Any holder of this document is advised that information contained hereon reflects the Company's findings at the time of its intervention only and within the limits of Client's instructions, if any. The Company's sole responsibility is to its Client and this document does not exonerate parties to a transaction from exercising all their rights and obligations under the transaction documents. This document cannot be reproduced except in full, without prior written approval of the Company. Any unauthorized alteration, forgery or falsification of the content or appearance of this document is unlawful and offenders may be prosecuted to the fullest extent of the law. Unless otherwise stated the results shown in this test report refer only to the sample(s) tested and such sample(s) are retained for 30 days only.

Attention: To check the authenticity of testing /inspection report & certificate, please contact us at telephone: (86-755) 8307 1443, or email: [CN.Doccheck@sgs.com](mailto:CN.Doccheck@sgs.com)  
 No.10, Weiye Road, Innovation Park, Kunshan, Jiangsu, China 215300      t(86-512)57355888      f(86-512)57370818      www.sgs.com.cn  
 中国·江苏·昆山市留学院创业园伟业路10号 邮编 215300      t(86-512)57355888      f(86-512)57370818      sgs.china@sgs.com

5281	1	1	1	1	1	1	1	1	1	1	100%
5282	1	1	1	1	1	1	1	1	1	1	100%
5283	1	1	1	1	1	1	1	1	1	1	100%
5284	1	1	1	1	1	1	1	1	1	1	100%
5285	1	1	1	1	1	1	1	1	1	1	100%
5286	1	1	1	1	1	1	1	1	1	1	100%
5287	1	1	1	1	1	1	1	1	1	1	100%
5288	1	1	1	1	1	1	1	1	1	1	100%
5289	1	1	1	1	1	1	1	1	1	1	100%
5290	1	1	1	1	1	1	1	1	1	1	100%
5291	1	1	1	1	1	1	1	1	1	1	100%
5292	1	1	1	1	1	1	1	1	1	1	100%
5293	1	1	1	1	1	1	1	1	1	1	100%
5294	1	1	1	1	1	1	1	1	1	1	100%
5295	1	1	1	1	1	1	1	1	1	1	100%
5296	1	1	1	1	1	1	1	1	1	1	100%
5297	1	1	1	1	1	1	1	1	1	1	100%
5298	1	1	1	1	1	1	1	1	1	1	100%
5299	1	1	1	1	1	1	1	1	1	1	100%
5300	1	1	1	1	1	1	1	1	1	1	100%
5301	1	1	1	1	1	1	1	1	1	1	100%
5302	1	1	1	1	1	1	1	1	1	1	100%
5303	1	1	1	1	1	1	1	1	1	1	100%
5304	1	1	1	1	1	1	1	1	1	1	100%
5305	1	1	1	1	1	1	1	1	1	1	100%
5306	1	1	1	1	1	1	1	1	1	1	100%
5307	1	1	1	1	1	1	1	1	1	1	100%
5308	1	1	1	1	1	1	1	1	1	1	100%
5309	1	1	1	1	1	1	1	1	1	1	100%
5310	1	1	1	1	1	1	1	1	1	1	100%
5311	1	1	1	1	1	1	1	1	1	1	100%
5312	1	1	1	1	1	1	1	1	1	1	100%
5313	1	1	1	1	1	1	1	1	1	1	100%
5314	1	1	1	1	1	1	1	1	1	1	100%
5315	1	1	1	1	1	1	1	1	1	1	100%
5316	1	1	1	1	1	1	1	1	1	1	100%
5317	1	1	1	1	1	1	1	1	1	1	100%
5318	1	1	1	1	1	1	1	1	1	1	100%



Unless otherwise agreed in writing, this document is issued by the Company subject to its General Conditions of Service printed overleaf, available on request or accessible at <http://www.sgs.com/en/Terms-and-Conditions.aspx> and, for electronic format documents, subject to Terms and Conditions for Electronic Documents at <http://www.sgs.com/en/Terms-and-Conditions/Terms-e-Documents.aspx>. Attention is drawn to the limitation of liability, indemnification and jurisdiction issues defined therein. Any holder of this document is advised that information contained hereon reflects the Company's findings at the time of its intervention only and within the limits of Client's instructions, if any. The Company's sole responsibility is to its Client and this document does not exonerate parties to a transaction from exercising all their rights and obligations under the transaction documents. This document cannot be reproduced except in full, without prior written approval of the Company. Any unauthorized alteration, forgery or falsification of the content or appearance of this document is unlawful and offenders may be prosecuted to the fullest extent of the law. Unless otherwise stated the results shown in this test report refer only to the sample(s) tested and such sample(s) are retained for 30 days only.

Attention: To check the authenticity of testing / inspection report & certificate, please contact us at telephone: (86-755) 8307 1443, or email: [CN.Doccheck@sgs.com](mailto:CN.Doccheck@sgs.com)  
 No.10, Weiye Road, Innovation Park, Kunshan, Jiangsu, China 215300      t(86-512)57355888      f(86-512)57370818      www.sgs.com.cn  
 中国·江苏·昆山市留学院创业园伟业路10号 邮编 215300      t(86-512)57355888      f(86-512)57370818      sgs.china@sgs.com



5319	1	1	1	1	1	1	1	1	1	1	100%
5320	1	1	1	1	1	1	1	1	1	1	100%
5321	1	1	1	1	1	1	1	1	1	1	100%
5322	1	1	1	1	1	1	1	1	1	1	100%
5323	1	1	1	1	1	1	1	1	1	1	100%
5324	1	1	1	1	1	1	1	1	1	1	100%
5325	1	1	1	1	1	1	1	1	1	1	100%
5326	1	1	1	1	1	1	1	1	1	1	100%
5327	1	1	1	1	1	1	1	1	1	1	100%
5328	1	1	1	1	1	1	1	1	1	1	100%
5329	1	1	1	1	1	1	1	1	1	1	100%
5330 Fh	1	1	1	1	1	1	1	1	1	1	100%
5331	0	0	0	0	0	0	0	0	0	0	0%
Detection Bandwidth = Fh-FI = 5330MHz - 5250MHz = 80MHz											
EUT 99% Bandwidth =75.909MHz											
75.909MHz × 80% =60.727MHz											



Unless otherwise agreed in writing, this document is issued by the Company subject to its General Conditions of Service printed overleaf, available on request or accessible at <http://www.sgs.com/en/Terms-and-Conditions.aspx> and, for electronic format documents, subject to Terms and Conditions for Electronic Documents at <http://www.sgs.com/en/Terms-and-Conditions/Terms-e-Documents.aspx>. Attention is drawn to the limitation of liability, indemnification and jurisdiction issues defined therein. Any holder of this document is advised that information contained hereon reflects the Company's findings at the time of its intervention only and within the limits of Client's instructions, if any. The Company's sole responsibility is to its Client and this document does not exonerate parties to a transaction from exercising all their rights and obligations under the transaction documents. This document cannot be reproduced except in full, without prior written approval of the Company. Any unauthorized alteration, forgery or falsification of the content or appearance of this document is unlawful and offenders may be prosecuted to the fullest extent of the law. Unless otherwise stated the results shown in this test report refer only to the sample(s) tested and such sample(s) are retained for 30 days only.  
Attention: To check the authenticity of testing /inspection report & certificate, please contact us at telephone: (86-755) 8307 1443, or email: [CN.Doccheck@sgs.com](mailto:CN.Doccheck@sgs.com)

80 MHz Signal Bandwidth											
EUT Frequency = 5530MHz											
Radar Frequency (MHz)	DFS Detection Trials (1=Detection, Blank= No Detection)										Detection Rate (%)
	1	2	3	4	5	6	7	8	9	10	
5489	0	0	0	0	0	0	0	0	0	0	0%
5490 FI	1	1	1	1	1	1	1	1	1	1	100%
5491	1	1	1	1	1	1	1	1	1	1	100%
5492	1	1	1	1	1	1	1	1	1	1	100%
5493	1	1	1	1	1	1	1	1	1	1	100%
5494	1	1	1	1	1	1	1	1	1	1	100%
5495	1	1	1	1	1	1	1	1	1	1	100%
5496	1	1	1	1	1	1	1	1	1	1	100%
5497	1	1	1	1	1	1	1	1	1	1	100%
5498	1	1	1	1	1	1	1	1	1	1	100%
5499	1	1	1	1	1	1	1	1	1	1	100%
5500	1	1	1	1	1	1	1	1	1	1	100%
5501	1	1	1	1	1	1	1	1	1	1	100%
5502	1	1	1	1	1	1	1	1	1	1	100%
5503	1	1	1	1	1	1	1	1	1	1	100%
5504	1	1	1	1	1	1	1	1	1	1	100%
5505	1	1	1	1	1	1	1	1	1	1	100%
5506	1	1	1	1	1	1	1	1	1	1	100%
5507	1	1	1	1	1	1	1	1	1	1	100%
5508	1	1	1	1	1	1	1	1	1	1	100%
5509	1	1	1	1	1	1	1	1	1	1	100%
5510	1	1	1	1	1	1	1	1	1	1	100%
5511	1	1	1	1	1	1	1	1	1	1	100%
5512	1	1	1	1	1	1	1	1	1	1	100%
5513	1	1	1	1	1	1	1	1	1	1	100%
5514	1	1	1	1	1	1	1	1	1	1	100%
5515	1	1	1	1	1	1	1	1	1	1	100%
5516	1	1	1	1	1	1	1	1	1	1	100%
5517	1	1	1	1	1	1	1	1	1	1	100%
5518	1	1	1	1	1	1	1	1	1	1	100%
5519	1	1	1	1	1	1	1	1	1	1	100%
5520	1	1	1	1	1	1	1	1	1	1	100%



Unless otherwise agreed in writing, this document is issued by the Company subject to its General Conditions of Service printed overleaf, available on request or accessible at <http://www.sgs.com/en/Terms-and-Conditions.aspx> and, for electronic format documents, subject to Terms and Conditions for Electronic Documents at <http://www.sgs.com/en/Terms-and-Conditions/Terms-e-Documents.aspx>. Attention is drawn to the limitation of liability, indemnification and jurisdiction issues defined therein. Any holder of this document is advised that information contained hereon reflects the Company's findings at the time of its intervention only and within the limits of Client's instructions, if any. The Company's sole responsibility is to its Client and this document does not exonerate parties to a transaction from exercising all their rights and obligations under the transaction documents. This document cannot be reproduced except in full, without prior written approval of the Company. Any unauthorized alteration, forgery or falsification of the content or appearance of this document is unlawful and offenders may be prosecuted to the fullest extent of the law. Unless otherwise stated the results shown in this test report refer only to the sample(s) tested and such sample(s) are retained for 30 days only.

Attention: To check the authenticity of testing /inspection report & certificate, please contact us at telephone: (86-755) 8307 1443, or email: [CN.Doccheck@sgs.com](mailto:CN.Doccheck@sgs.com)  
 No.10, Weiye Road, Innovation Park, Kunshan, Jiangsu, China 215300      t(86-512)57355888      f(86-512)57370818      www.sgs.com.cn  
 中国·江苏·昆山市留学院创业园伟业路10号 邮编 215300      t(86-512)57355888      f(86-512)57370818      sgs.china@sgs.com

5521	1	1	1	1	1	1	1	1	1	1	100%
5522	1	1	1	1	1	1	1	1	1	1	100%
5523	1	1	1	1	1	1	1	1	1	1	100%
5524	1	1	1	1	1	1	1	1	1	1	100%
5525	1	1	1	1	1	1	1	1	1	1	100%
5526	1	1	1	1	1	1	1	1	1	1	100%
5527	1	1	1	1	1	1	1	1	1	1	100%
5528	1	1	1	1	1	1	1	1	1	1	100%
5529	1	1	1	1	1	1	1	1	1	1	100%
5530	1	1	1	1	1	1	1	1	1	1	100%
5531	1	1	1	1	1	1	1	1	1	1	100%
5532	1	1	1	1	1	1	1	1	1	1	100%
5533	1	1	1	1	1	1	1	1	1	1	100%
5534	1	1	1	1	1	1	1	1	1	1	100%
5535	1	1	1	1	1	1	1	1	1	1	100%
5536	1	1	1	1	1	1	1	1	1	1	100%
5537	1	1	1	1	1	1	1	1	1	1	100%
5538	1	1	1	1	1	1	1	1	1	1	100%
5539	1	1	1	1	1	1	1	1	1	1	100%
5540	1	1	1	1	1	1	1	1	1	1	100%
5541	1	1	1	1	1	1	1	1	1	1	100%
5542	1	1	1	1	1	1	1	1	1	1	100%
5543	1	1	1	1	1	1	1	1	1	1	100%
5544	1	1	1	1	1	1	1	1	1	1	100%
5545	1	1	1	1	1	1	1	1	1	1	100%
5546	1	1	1	1	1	1	1	1	1	1	100%
5547	1	1	1	1	1	1	1	1	1	1	100%
5548	1	1	1	1	1	1	1	1	1	1	100%
5549	1	1	1	1	1	1	1	1	1	1	100%
5550	1	1	1	1	1	1	1	1	1	1	100%
5551	1	1	1	1	1	1	1	1	1	1	100%
5552	1	1	1	1	1	1	1	1	1	1	100%
5553	1	1	1	1	1	1	1	1	1	1	100%
5554	1	1	1	1	1	1	1	1	1	1	100%
5555	1	1	1	1	1	1	1	1	1	1	100%
5556	1	1	1	1	1	1	1	1	1	1	100%
5557	1	1	1	1	1	1	1	1	1	1	100%
5558	1	1	1	1	1	1	1	1	1	1	100%



Unless otherwise agreed in writing, this document is issued by the Company subject to its General Conditions of Service printed overleaf, available on request or accessible at <http://www.sgs.com/en/Terms-and-Conditions.aspx> and, for electronic format documents, subject to Terms and Conditions for Electronic Documents at <http://www.sgs.com/en/Terms-and-Conditions/Terms-e-Documents.aspx>. Attention is drawn to the limitation of liability, indemnification and jurisdiction issues defined therein. Any holder of this document is advised that information contained hereon reflects the Company's findings at the time of its intervention only and within the limits of Client's instructions, if any. The Company's sole responsibility is to its Client and this document does not exonerate parties to a transaction from exercising all their rights and obligations under the transaction documents. This document cannot be reproduced except in full, without prior written approval of the Company. Any unauthorized alteration, forgery or falsification of the content or appearance of this document is unlawful and offenders may be prosecuted to the fullest extent of the law. Unless otherwise stated the results shown in this test report refer only to the sample(s) tested and such sample(s) are retained for 30 days only.

Attention: To check the authenticity of testing / inspection report & certificate, please contact us at telephone: (86-755) 8307 1443, or email: [CN.Doccheck@sgs.com](mailto:CN.Doccheck@sgs.com)  
 No.10, Weiye Road, Innovation Park, Kunshan, Jiangsu, China 215300      t(86-512)57355888      f(86-512)57370818      www.sgs.com.cn  
 中国·江苏·昆山市留学院创业园伟业路10号 邮编 215300      t(86-512)57355888      f(86-512)57370818      sgs.china@sgs.com

5559	1	1	1	1	1	1	1	1	1	1	100%
5560	1	1	1	1	1	1	1	1	1	1	100%
5561	1	1	1	1	1	1	1	1	1	1	100%
5562	1	1	1	1	1	1	1	1	1	1	100%
5563	1	1	1	1	1	1	1	1	1	1	100%
5564	1	1	1	1	1	1	1	1	1	1	100%
5565	1	1	1	1	1	1	1	1	1	1	100%
5566	1	1	1	1	1	1	1	1	1	1	100%
5567	1	1	1	1	1	1	1	1	1	1	100%
5568	1	1	1	1	1	1	1	1	1	1	100%
5569	1	1	1	1	1	1	1	1	1	1	100%
5570 Fh	1	1	1	1	1	1	1	1	1	1	100%
5571	0	0	0	0	0	0	0	0	0	0	0%
Detection Bandwidth = Fh-FI = 5570MHz - 5490MHz = 80MHz											
EUT 99% Bandwidth =75.969MHz											
75.969MHz × 80% =60.775MHz											



Unless otherwise agreed in writing, this document is issued by the Company subject to its General Conditions of Service printed overleaf, available on request or accessible at <http://www.sgs.com/en/Terms-and-Conditions.aspx> and, for electronic format documents, subject to Terms and Conditions for Electronic Documents at <http://www.sgs.com/en/Terms-and-Conditions/Terms-e-Documents.aspx>. Attention is drawn to the limitation of liability, indemnification and jurisdiction issues defined therein. Any holder of this document is advised that information contained hereon reflects the Company's findings at the time of its intervention only and within the limits of Client's instructions, if any. The Company's sole responsibility is to its Client and this document does not exonerate parties to a transaction from exercising all their rights and obligations under the transaction documents. This document cannot be reproduced except in full, without prior written approval of the Company. Any unauthorized alteration, forgery or falsification of the content or appearance of this document is unlawful and offenders may be prosecuted to the fullest extent of the law. Unless otherwise stated the results shown in this test report refer only to the sample(s) tested and such sample(s) are retained for 30 days only.  
Attention: To check the authenticity of testing /inspection report & certificate, please contact us at telephone: (86-755) 8307 1443, or email: [CN.Doccheck@sgs.com](mailto:CN.Doccheck@sgs.com)

No.10, Weiye Road, Innovation Park, Kunshan, Jiangsu, China 215300  
中国·江苏·昆山市留学生创业园伟业路10号 邮编 215300

(86-512)57355888 (86-512)57370818 [www.sgsgroup.com.cn](http://www.sgsgroup.com.cn)  
(86-512)57355888 (86-512)57370818 [sgs.china@sgs.com](mailto:sgs.china@sgs.com)

### 6.9.4 Channel Available Check

The following results reflect all 20 MHz, 40 MHz and 80MHz Channel Bandwidths operation.

Test Item : Initial Channel Availability Check Time

Radar Type : None

Test Mode : Transmit by 802.11ac(VHT20)

The EUT does not transmit any beacon or data transmission until at least 1 minute after the completion of the power-on cycle (101.4sec).

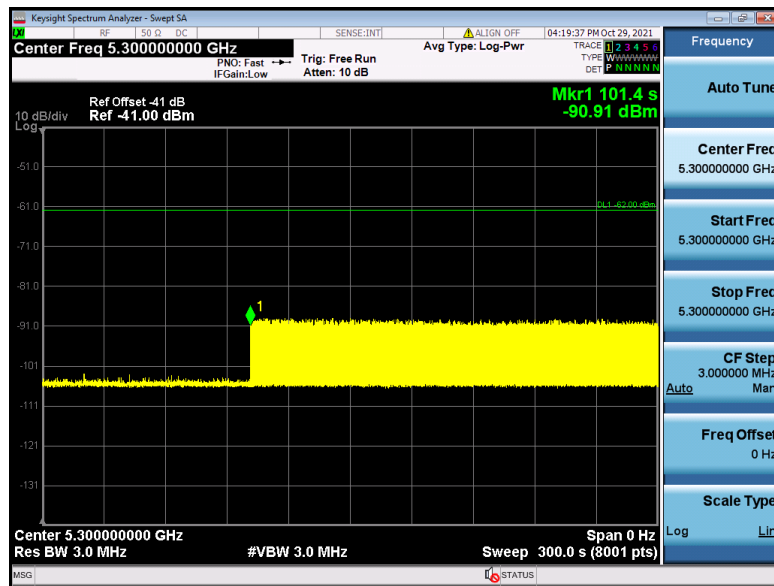

Unless otherwise agreed in writing, this document is issued by the Company subject to its General Conditions of Service printed overleaf, available on request or accessible at <http://www.sgs.com/en/Terms-and-Conditions.aspx> and, for electronic format documents, subject to Terms and Conditions for Electronic Documents at <http://www.sgs.com/en/Terms-and-Conditions/Terms-e-Documents.aspx>. Attention is drawn to the limitation of liability, indemnification and jurisdiction issues defined therein. Any holder of this document is advised that information contained hereon reflects the Company's findings at the time of its intervention only and within the limits of Client's instructions, if any. The Company's sole responsibility is to its Client and this document does not exonerate parties to a transaction from exercising all their rights and obligations under the transaction documents. This document cannot be reproduced except in full, without prior written approval of the Company. Any unauthorized alteration, forgery or falsification of the content or appearance of this document is unlawful and offenders may be prosecuted to the fullest extent of the law. Unless otherwise stated the results shown in this test report refer only to the sample(s) tested and such sample(s) are retained for 30 days only.  
Attention: To check the authenticity of testing /inspection report & certificate, please contact us at telephone: (86-755) 8307 1443, or email: [CN.Doccheck@sgs.com](mailto:CN.Doccheck@sgs.com)

No.10, Weiye Road, Innovation Park, Kunshan, Jiangsu, China 215300  
中国·江苏·昆山市留学生创业园伟业路10号 邮编 215300

t(86-512)57355888 f(86-512)57370818 www.sgs.com.cn  
t(86-512)57355888 f(86-512)57370818 sgs.china@sgs.com



Test result with a radar burst at the beginning of the Channel Availability Check Time

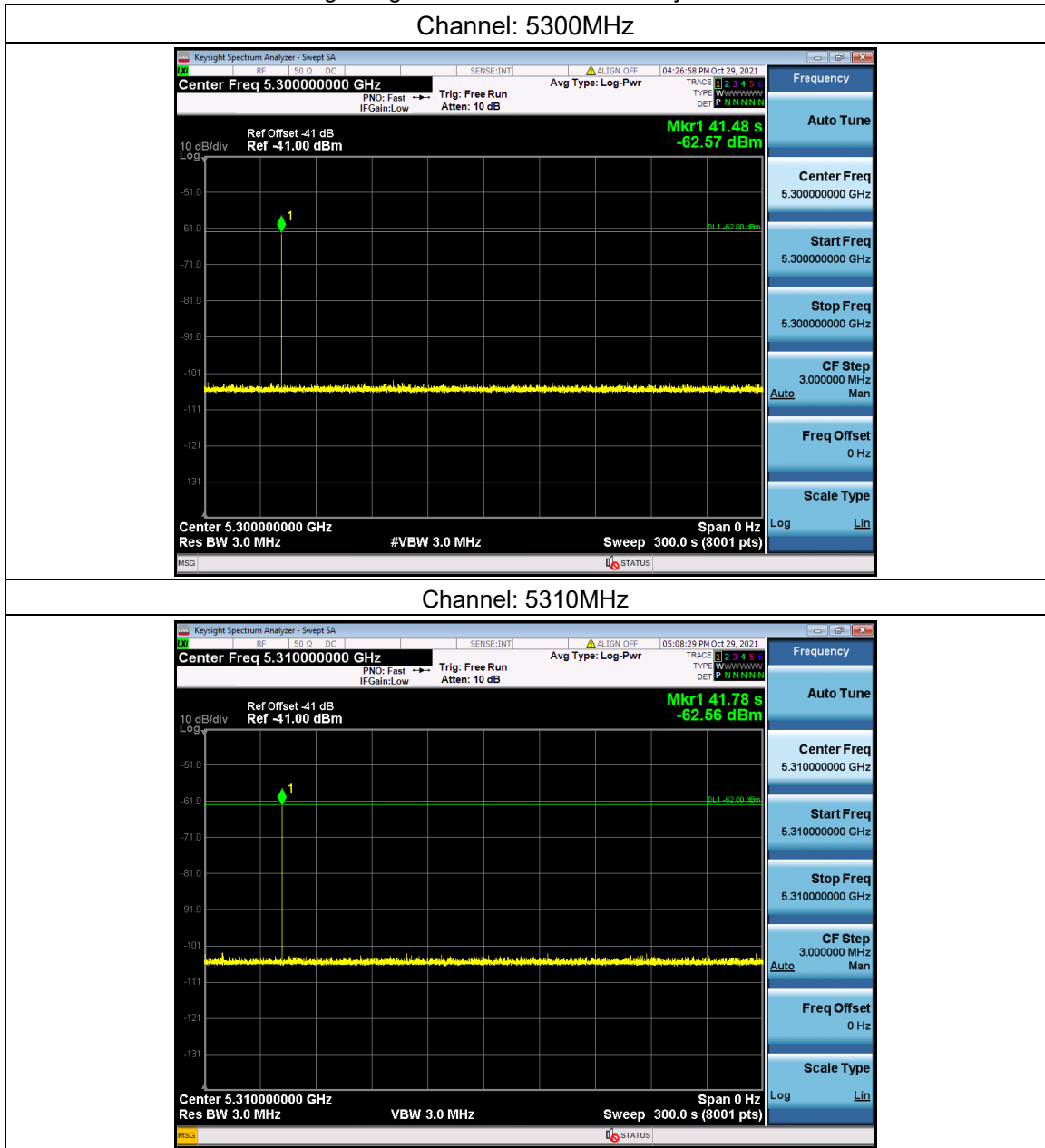

Unless otherwise agreed in writing, this document is issued by the Company subject to its General Conditions of Service printed overleaf, available on request or accessible at <http://www.sgs.com/en/Terms-and-Conditions.aspx> and, for electronic format documents, subject to Terms and Conditions for Electronic Documents at <http://www.sgs.com/en/Terms-and-Conditions/Terms-e-Documents.aspx>. Attention is drawn to the limitation of liability, indemnification and jurisdiction issues defined therein. Any holder of this document is advised that information contained hereon reflects the Company's findings at the time of its intervention only and within the limits of Client's instructions, if any. The Company's sole responsibility is to its Client and this document does not exonerate parties to a transaction from exercising all their rights and obligations under the transaction documents. This document cannot be reproduced except in full, without prior written approval of the Company. Any unauthorized alteration, forgery or falsification of the content or appearance of this document is unlawful and offenders may be prosecuted to the fullest extent of the law. Unless otherwise stated the results shown in this test report refer only to the sample(s) tested and such sample(s) are retained for 30 days only.  
Attention: To check the authenticity of testing /inspection report & certificate, please contact us at telephone: (86-755) 8307 1443, or email: [CN\\_Doccheck@sgs.com](mailto:CN_Doccheck@sgs.com)

No.10, Weiye Road, Innovation Park, Kunshan, Jiangsu, China 215300  
中国·江苏·昆山市留学院创业园伟业路10号 邮编 215300

t(86-512)57355888 f(86-512)57370818 www.sgs.com.cn  
t(86-512)57355888 f(86-512)57370818 sgs.china@sgs.com

Channel: 5290MHz

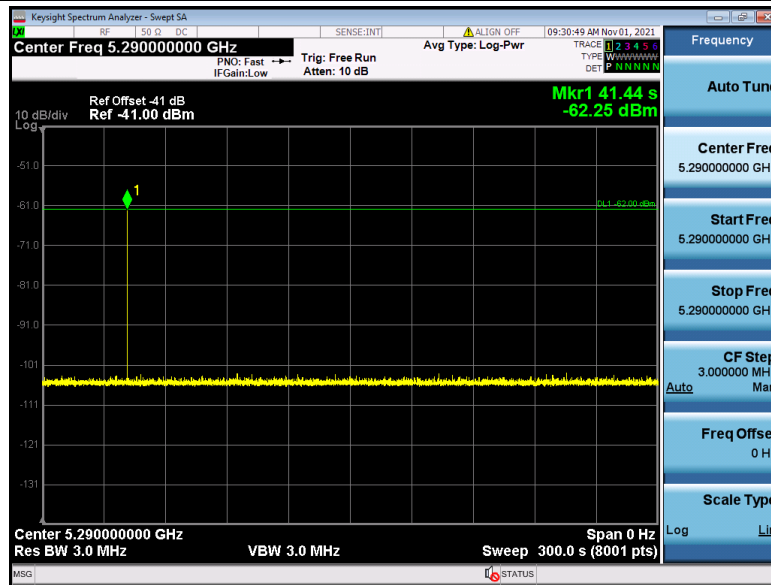

Channel: 5500MHz

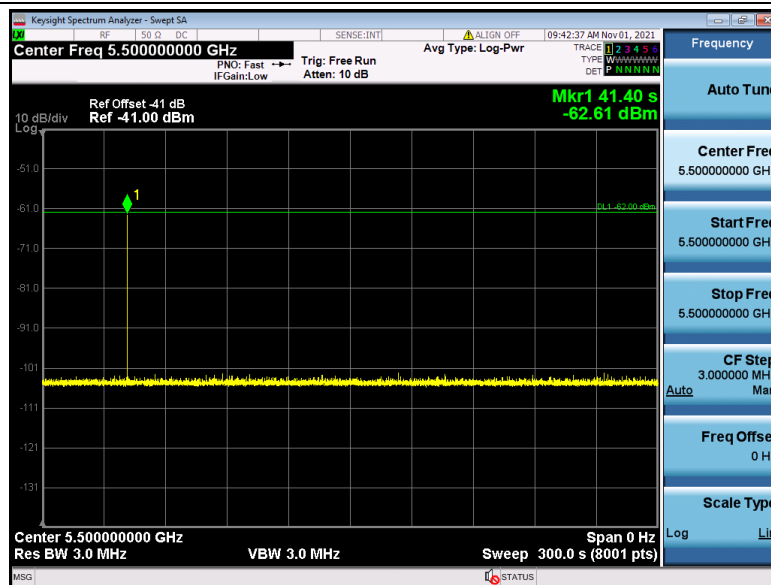

Unless otherwise agreed in writing, this document is issued by the Company subject to its General Conditions of Service printed overleaf, available on request or accessible at <http://www.sgs.com/en/Terms-and-Conditions.aspx> and, for electronic format documents, subject to Terms and Conditions for Electronic Documents at <http://www.sgs.com/en/Terms-and-Conditions/Terms-e-Documents.aspx>. Attention is drawn to the limitation of liability, indemnification and jurisdiction issues defined therein. Any holder of this document is advised that information contained hereon reflects the Company's findings at the time of its intervention only and within the limits of Client's instructions, if any. The Company's sole responsibility is to its Client and this document does not exonerate parties to a transaction from exercising all their rights and obligations under the transaction documents. This document cannot be reproduced except in full, without prior written approval of the Company. Any unauthorized alteration, forgery or falsification of the content or appearance of this document is unlawful and offenders may be prosecuted to the fullest extent of the law. Unless otherwise stated the results shown in this test report refer only to the sample(s) tested and such sample(s) are retained for 30 days only.

Attention: To check the authenticity of testing /inspection report & certificate, please contact us at telephone: (86-755) 8307 1443, or email: [CN.Doccheck@sgs.com](mailto:CN.Doccheck@sgs.com)

No.10, Weiye Road, Innovation Park, Kunshan, Jiangsu, China 215300  
中国·江苏·昆山市留学生创业园伟业路10号 邮编 215300

t(86-512)57355888 f(86-512)57370818 www.sgs.com.cn  
t(86-512)57355888 f(86-512)57370818 sgs.china@sgs.com

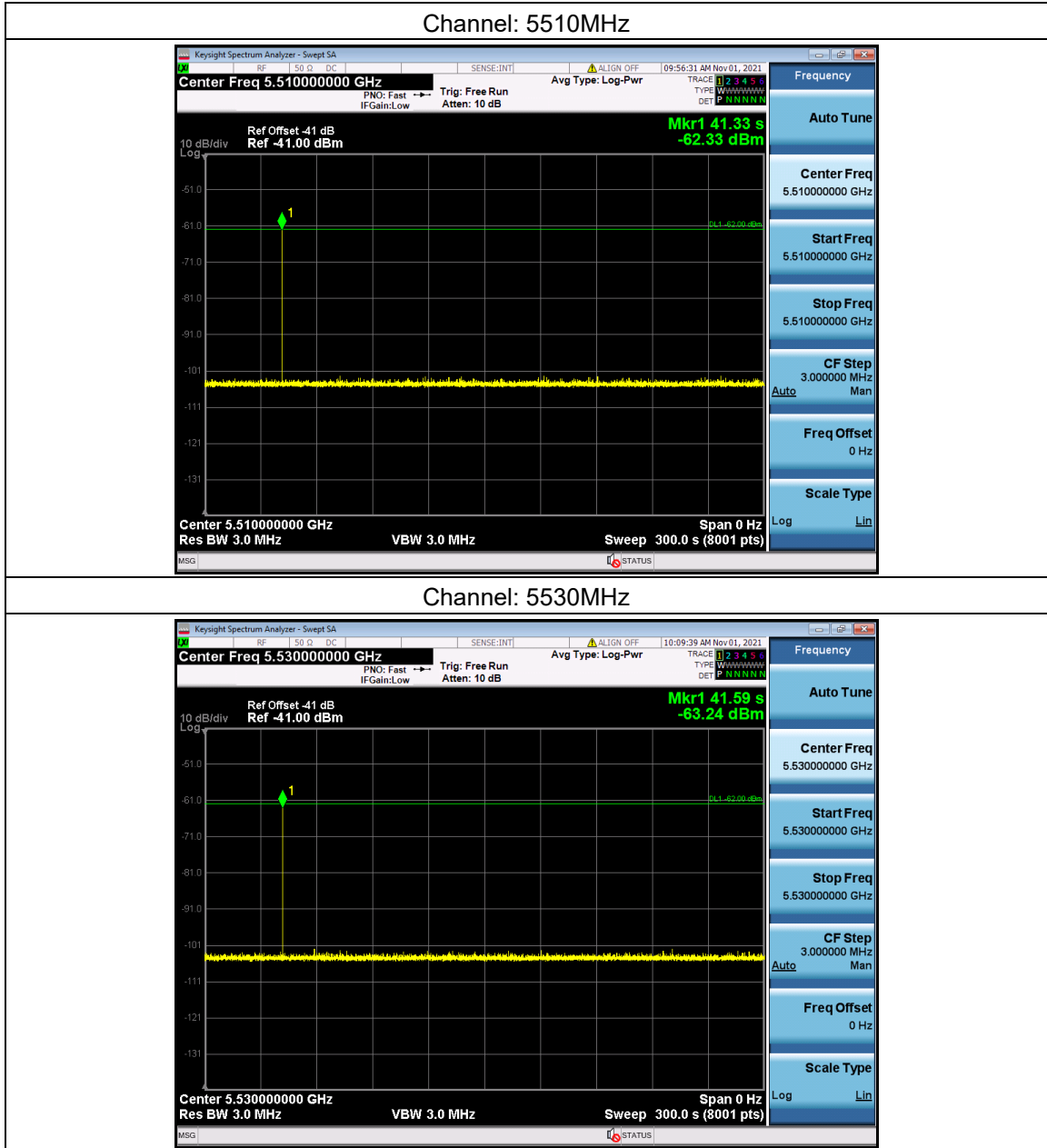

Unless otherwise agreed in writing, this document is issued by the Company subject to its General Conditions of Service printed overleaf, available on request or accessible at <http://www.sgs.com/en/Terms-and-Conditions.aspx> and, for electronic format documents, subject to Terms and Conditions for Electronic Documents at <http://www.sgs.com/en/Terms-and-Conditions/Terms-e-Documents.aspx>. Attention is drawn to the limitation of liability, indemnification and jurisdiction issues defined therein. Any holder of this document is advised that information contained hereon reflects the Company's findings at the time of its intervention only and within the limits of Client's instructions, if any. The Company's sole responsibility is to its Client and this document does not exonerate parties to a transaction from exercising all their rights and obligations under the transaction documents. This document cannot be reproduced except in full, without prior written approval of the Company. Any unauthorized alteration, forgery or falsification of the content or appearance of this document is unlawful and offenders may be prosecuted to the fullest extent of the law. Unless otherwise stated the results shown in this test report refer only to the sample(s) tested and such sample(s) are retained for 30 days only.

Attention: To check the authenticity of testing /inspection report & certificate, please contact us at telephone: (86-755) 8307 1443, or email: [CN.Doccheck@sgs.com](mailto:CN.Doccheck@sgs.com)

No.10, Weiye Road, Innovation Park, Kunshan, Jiangsu, China 215300      t(86-512)57355888      f(86-512)57370818      www.sgs.com.cn  
 中国·江苏·昆山市留学院创业园伟业路10号 邮编 215300      t(86-512)57355888      f(86-512)57370818      sgs.china@sgs.com

Test result with radar burst at the end of the Channel Availability Check Time

Channel: 5300MHz

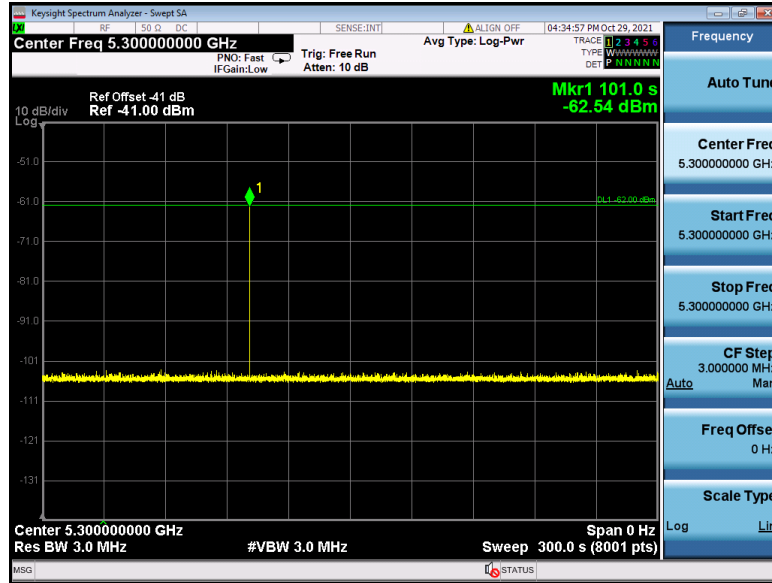

Channel: 5310MHz

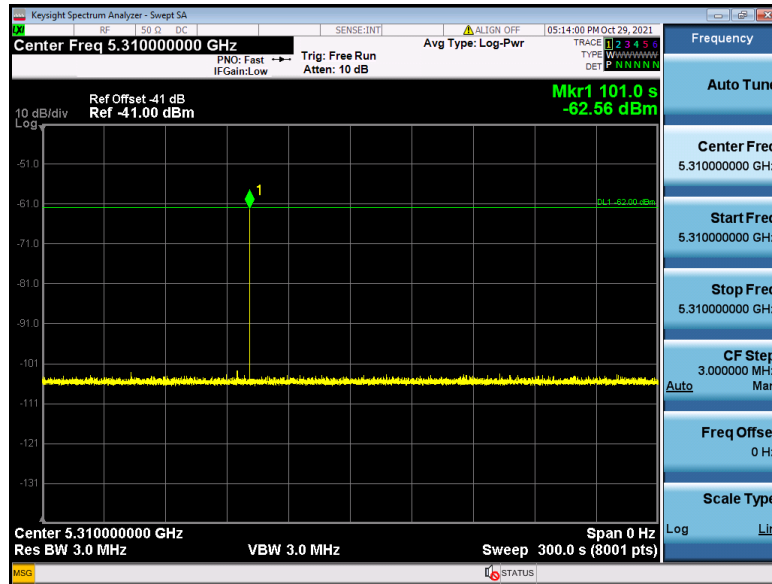

Unless otherwise agreed in writing, this document is issued by the Company subject to its General Conditions of Service printed overleaf, available on request or accessible at <http://www.sgs.com/en/Terms-and-Conditions.aspx> and, for electronic format documents, subject to Terms and Conditions for Electronic Documents at <http://www.sgs.com/en/Terms-and-Conditions/Terms-e-Documents.aspx>. Attention is drawn to the limitation of liability, indemnification and jurisdiction issues defined therein. Any holder of this document is advised that information contained hereon reflects the Company's findings at the time of its intervention only and within the limits of Client's instructions, if any. The Company's sole responsibility is to its Client and this document does not exonerate parties to a transaction from exercising all their rights and obligations under the transaction documents. This document cannot be reproduced except in full, without prior written approval of the Company. Any unauthorized alteration, forgery or falsification of the content or appearance of this document is unlawful and offenders may be prosecuted to the fullest extent of the law. Unless otherwise stated the results shown in this test report refer only to the sample(s) tested and such sample(s) are retained for 30 days only.  
Attention: To check the authenticity of testing /inspection report & certificate, please contact us at telephone: (86-755) 8307 1443, or email: [CN\\_Doccheck@sgs.com](mailto:CN_Doccheck@sgs.com)

No.10, Weiye Road, Innovation Park, Kunshan, Jiangsu, China 215300  
中国·江苏·昆山市留学院创业园伟业路10号 邮编 215300

t(86-512)57355888 f(86-512)57370818 www.sgs.com.cn  
t(86-512)57355888 f(86-512)57370818 sgs.china@sgs.com

Channel: 5290MHz

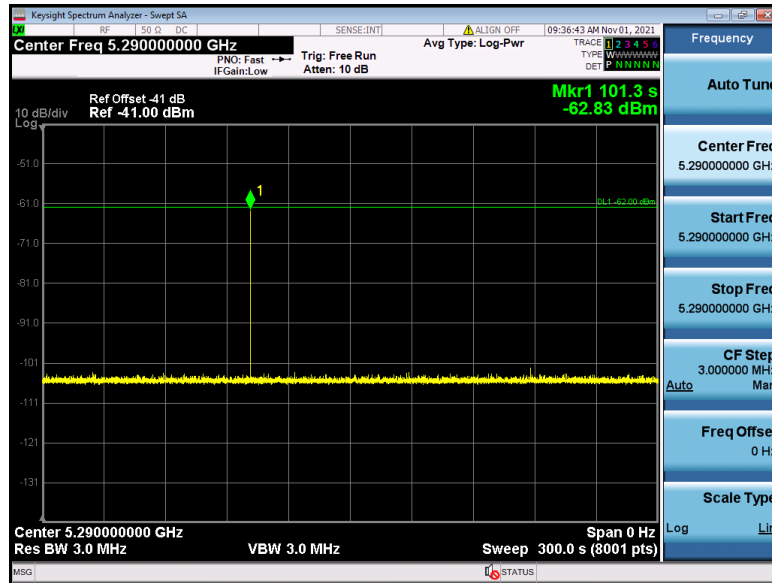

Channel: 5500MHz

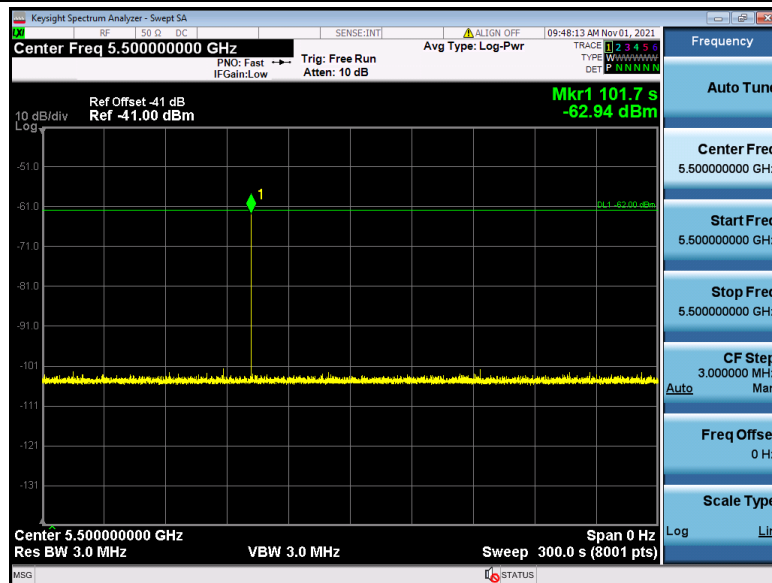

Unless otherwise agreed in writing, this document is issued by the Company subject to its General Conditions of Service printed overleaf, available on request or accessible at <http://www.sgs.com/en/Terms-and-Conditions.aspx> and, for electronic format documents, subject to Terms and Conditions for Electronic Documents at <http://www.sgs.com/en/Terms-and-Conditions/Terms-e-Documents.aspx>. Attention is drawn to the limitation of liability, indemnification and jurisdiction issues defined therein. Any holder of this document is advised that information contained hereon reflects the Company's findings at the time of its intervention only and within the limits of Client's instructions, if any. The Company's sole responsibility is to its Client and this document does not exonerate parties to a transaction from exercising all their rights and obligations under the transaction documents. This document cannot be reproduced except in full, without prior written approval of the Company. Any unauthorized alteration, forgery or falsification of the content or appearance of this document is unlawful and offenders may be prosecuted to the fullest extent of the law. Unless otherwise stated the results shown in this test report refer only to the sample(s) tested and such sample(s) are retained for 30 days only.  
Attention: To check the authenticity of testing /inspection report & certificate, please contact us at telephone: (86-755) 8307 1443, or email: [CN\\_Doccheck@sgs.com](mailto:CN_Doccheck@sgs.com)

No.10, Weiye Road, Innovation Park, Kunshan, Jiangsu, China 215300  
中国·江苏·昆山市留学生创业园伟业路10号 邮编 215300

t(86-512)57355888 f(86-512)57370818 www.sgs.com.cn  
t(86-512)57355888 f(86-512)57370818 sgs.china@sgs.com



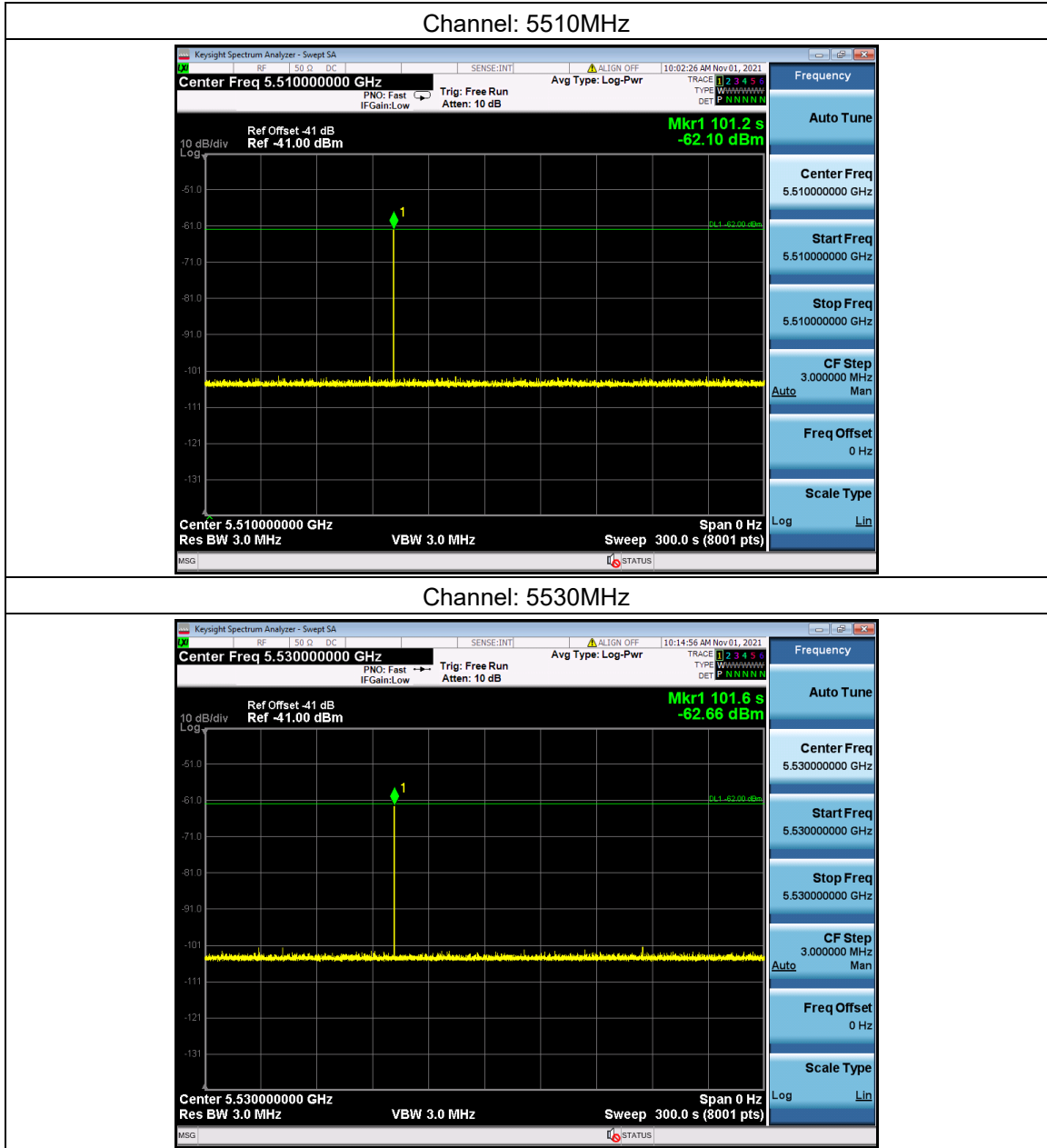

Test Item	Limit	Results
Channel Availability Check Time	60 s	Pass



Unless otherwise agreed in writing, this document is issued by the Company subject to its General Conditions of Service printed overleaf, available on request or accessible at <http://www.sgs.com/en/Terms-and-Conditions.aspx> and, for electronic format documents, subject to Terms and Conditions for Electronic Documents at <http://www.sgs.com/en/Terms-and-Conditions/Terms-e-Documents.aspx>. Attention is drawn to the limitation of liability, indemnification and jurisdiction issues defined therein. Any holder of this document is advised that information contained hereon reflects the Company's findings at the time of its intervention only and within the limits of Client's instructions, if any. The Company's sole responsibility is to its Client and this document does not exonerate parties to a transaction from exercising all their rights and obligations under the transaction documents. This document cannot be reproduced except in full, without prior written approval of the Company. Any unauthorized alteration, forgery or falsification of the content or appearance of this document is unlawful and offenders may be prosecuted to the fullest extent of the law. Unless otherwise stated the results shown in this test report refer only to the sample(s) tested and such sample(s) are retained for 30 days only.

Attention: To check the authenticity of testing /inspection report & certificate, please contact us at telephone: (86-755) 8307 1443, or email: [CN\\_Doccheck@sgs.com](mailto:CN_Doccheck@sgs.com)

No.10, Weiye Road, Innovation Park, Kunshan, Jiangsu, China 215300  
中国·江苏·昆山市留学生创业园伟业路10号 邮编 215300

t(86-512)57355888 f(86-512)57370818 www.sgs.com.cn  
t(86-512)57355888 f(86-512)57370818 sgs.china@sgs.com

**6.9.5 In-Service Monitoring for Channel Move Time and Channel Closing Transmission Time**

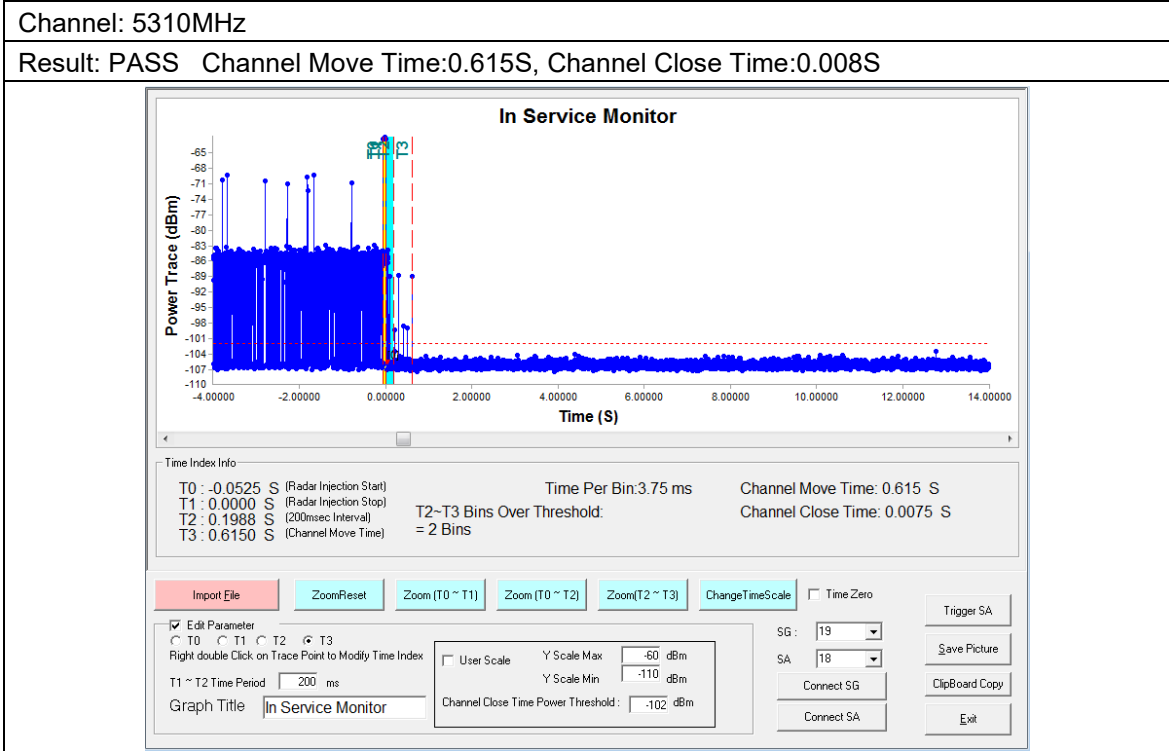
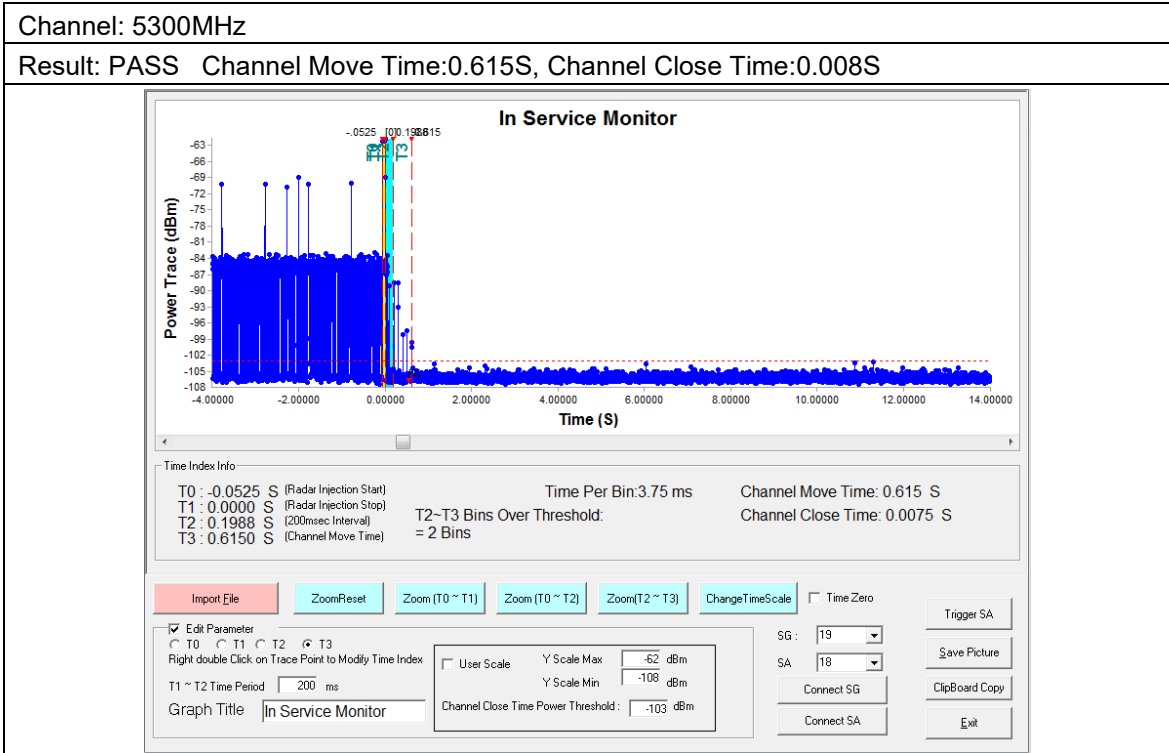

Unless otherwise agreed in writing, this document is issued by the Company subject to its General Conditions of Service printed overleaf, available on request or accessible at <http://www.sgs.com/en/Terms-and-Conditions.aspx> and, for electronic format documents, subject to Terms and Conditions for Electronic Documents at <http://www.sgs.com/en/Terms-and-Conditions/Terms-e-Documents.aspx>. Attention is drawn to the limitation of liability, indemnification and jurisdiction issues defined therein. Any holder of this document is advised that information contained hereon reflects the Company's findings at the time of its intervention only and within the limits of Client's instructions, if any. The Company's sole responsibility is to its Client and this document does not exonerate parties to a transaction from exercising all their rights and obligations under the transaction documents. This document cannot be reproduced except in full, without prior written approval of the Company. Any unauthorized alteration, forgery or falsification of the content or appearance of this document is unlawful and offenders may be prosecuted to the fullest extent of the law. Unless otherwise stated the results shown in this test report refer only to the sample(s) tested and such sample(s) are retained for 30 days only.

Attention: To check the authenticity of testing / inspection report & certificate, please contact us at telephone: (86-755) 8307 1443, or email: [CN.Doccheck@sgs.com](mailto:CN.Doccheck@sgs.com)

No.10, Weiye Road, Innovation Park, Kunshan, Jiangsu, China 215300  
中国·江苏·昆山市留学院创业园伟业路10号 邮编 215300

t(86-512)57355888 f(86-512)57370818 www.sgs.com.cn  
t(86-512)57355888 f(86-512)57370818 sgs.china@sgs.com

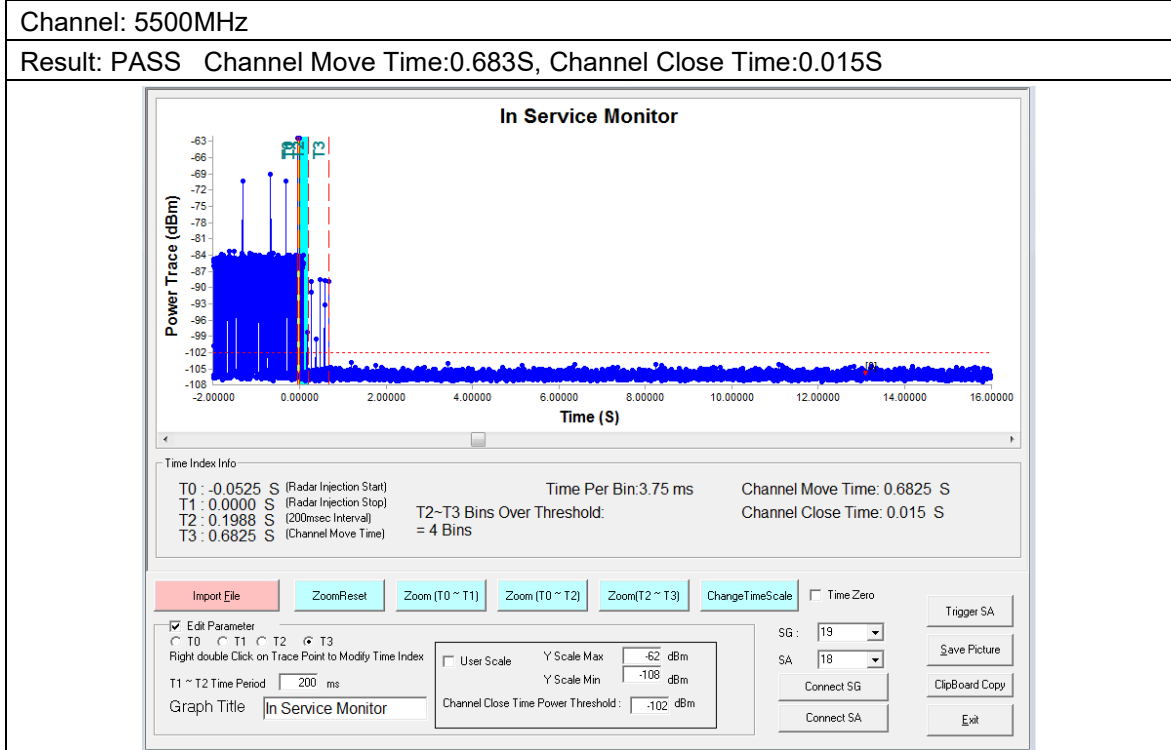
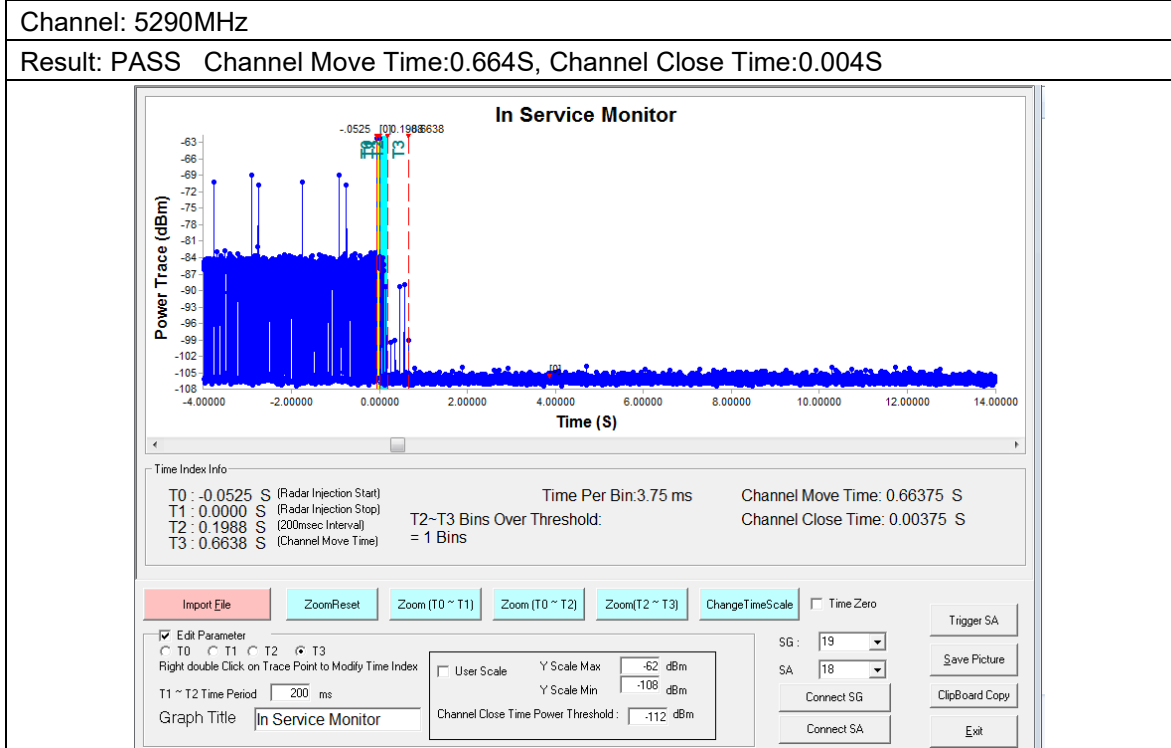

Unless otherwise agreed in writing, this document is issued by the Company subject to its General Conditions of Service printed overleaf, available on request or accessible at <http://www.sgs.com/en/Terms-and-Conditions.aspx> and, for electronic format documents, subject to Terms and Conditions for Electronic Documents at <http://www.sgs.com/en/Terms-and-Conditions/Terms-e-Documents.aspx>. Attention is drawn to the limitation of liability, indemnification and jurisdiction issues defined therein. Any holder of this document is advised that information contained hereon reflects the Company's findings at the time of its intervention only and within the limits of Client's instructions, if any. The Company's sole responsibility is to its Client and this document does not exonerate parties to a transaction from exercising all their rights and obligations under the transaction documents. This document cannot be reproduced except in full, without prior written approval of the Company. Any unauthorized alteration, forgery or falsification of the content or appearance of this document is unlawful and offenders may be prosecuted to the fullest extent of the law. Unless otherwise stated the results shown in this test report refer only to the sample(s) tested and such sample(s) are retained for 30 days only.

Attention: To check the authenticity of testing /inspection report & certificate, please contact us at telephone: (86-755) 8307 1443, or email: [CN\\_Doccheck@sgs.com](mailto:CN_Doccheck@sgs.com)

No.10, Weiye Road, Innovation Park, Kunshan, Jiangsu, China 215300  
 中国·江苏·昆山市留学院创业园伟业路10号 邮编 215300

t(86-512)57355888 f(86-512)57370818 www.sgs.com.cn  
 t(86-512)57355888 f(86-512)57370818 sgs.china@sgs.com

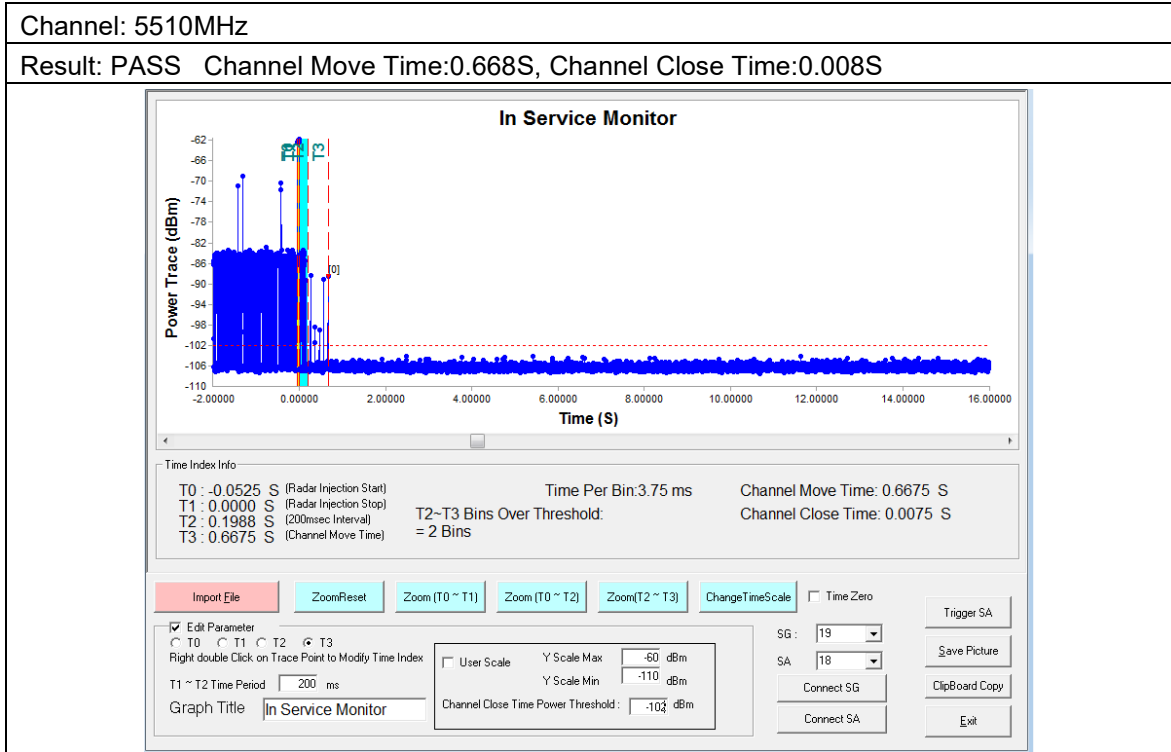

Unless otherwise agreed in writing, this document is issued by the Company subject to its General Conditions of Service printed overleaf, available on request or accessible at <http://www.sgs.com/en/Terms-and-Conditions.aspx> and, for electronic format documents, subject to Terms and Conditions for Electronic Documents at <http://www.sgs.com/en/Terms-and-Conditions/Terms-e-Documents.aspx>. Attention is drawn to the limitation of liability, indemnification and jurisdiction issues defined therein. Any holder of this document is advised that information contained herein reflects the Company's findings at the time of its intervention only and within the limits of Client's instructions, if any. The Company's sole responsibility is to its Client and this document does not exonerate parties to a transaction from exercising all their rights and obligations under the transaction documents. This document cannot be reproduced except in full, without prior written approval of the Company. Any unauthorized alteration, forgery or falsification of the content or appearance of this document is unlawful and offenders may be prosecuted to the fullest extent of the law. Unless otherwise stated the results shown in this test report refer only to the sample(s) tested and such sample(s) are retained for 30 days only.

Attention: To check the authenticity of testing /inspection report & certificate, please contact us at telephone: (86-755) 8307 1443, or email: [CN\\_Doccheck@sgs.com](mailto:CN_Doccheck@sgs.com)

No.10, Weiye Road, Innovation Park, Kunshan, Jiangsu, China 215300  
中国·江苏·昆山市留学院创业园伟业路10号 邮编 215300

t(86-512)57355888 f(86-512)57370818 www.sgs.com.cn  
t(86-512)57355888 f(86-512)57370818 sgs.china@sgs.com

6.9.6 Non-occupancy period

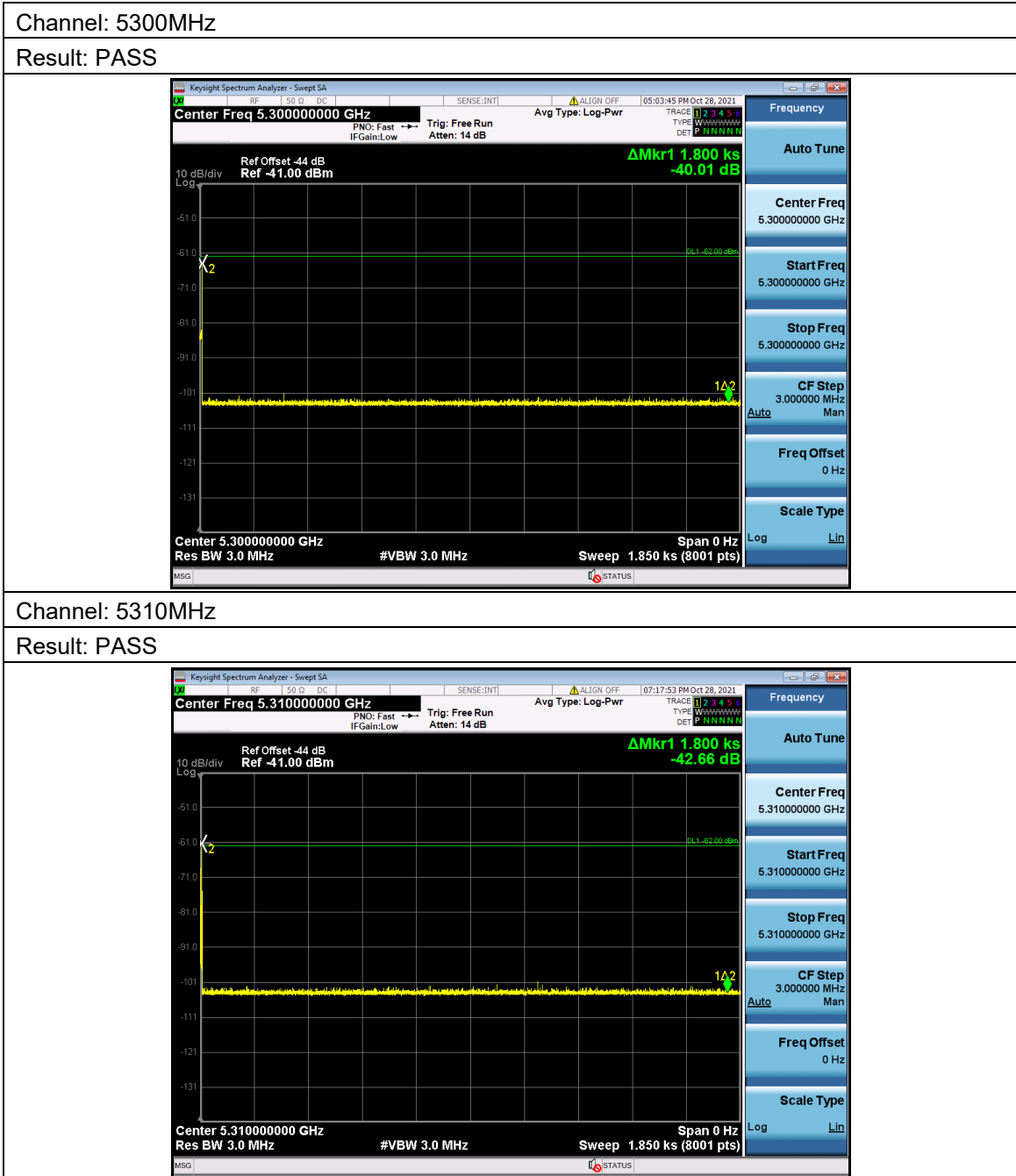

Unless otherwise agreed in writing, this document is issued by the Company subject to its General Conditions of Service printed overleaf, available on request or accessible at <http://www.sgs.com/en/Terms-and-Conditions.aspx> and, for electronic format documents, subject to Terms and Conditions for Electronic Documents at <http://www.sgs.com/en/Terms-and-Conditions/Terms-e-Documents.aspx>. Attention is drawn to the limitation of liability, indemnification and jurisdiction issues defined therein. Any holder of this document is advised that information contained hereon reflects the Company's findings at the time of its intervention only and within the limits of Client's instructions, if any. The Company's sole responsibility is to its Client and this document does not exonerate parties to a transaction from exercising all their rights and obligations under the transaction documents. This document cannot be reproduced except in full, without prior written approval of the Company. Any unauthorized alteration, forgery or falsification of the content or appearance of this document is unlawful and offenders may be prosecuted to the fullest extent of the law. Unless otherwise stated the results shown in this test report refer only to the sample(s) tested and such sample(s) are retained for 30 days only.

Attention: To check the authenticity of testing /inspection report & certificate, please contact us at telephone: (86-755) 8307 1443, or email: [CN\\_Doccheck@sgs.com](mailto:CN_Doccheck@sgs.com)

No.10, Weiye Road, Innovation Park, Kunshan, Jiangsu, China 215300      t(86-512)57355888      f(86-512)57370818      www.sgs.com.cn  
 中国·江苏·昆山市留学院创业园伟业路10号 邮编 215300      t(86-512)57355888      f(86-512)57370818      sgs.china@sgs.com



Channel: 5290MHz  
Result: PASS

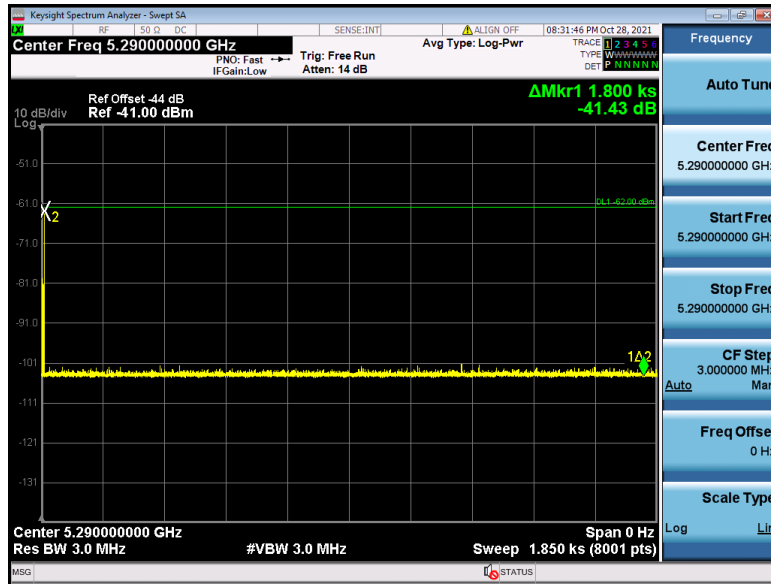

Channel: 5500MHz  
Result: PASS

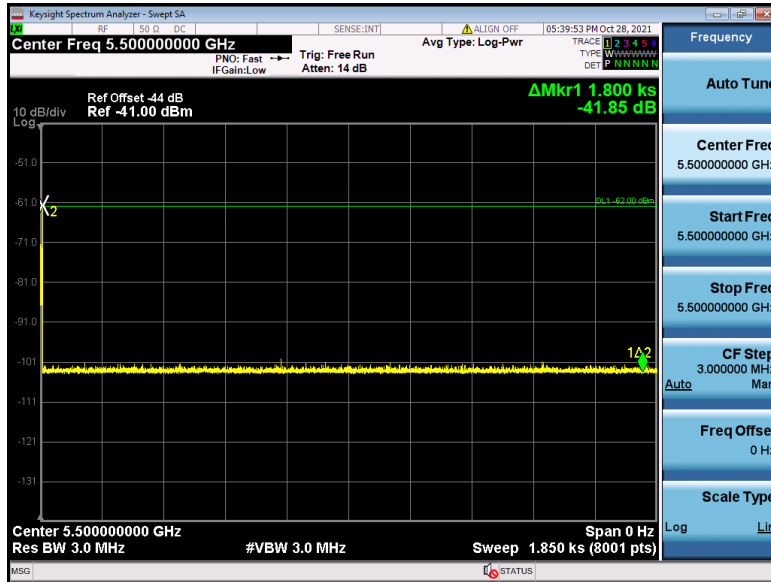

Unless otherwise agreed in writing, this document is issued by the Company subject to its General Conditions of Service printed overleaf, available on request or accessible at <http://www.sgs.com/en/Terms-and-Conditions.aspx> and, for electronic format documents, subject to Terms and Conditions for Electronic Documents at <http://www.sgs.com/en/Terms-and-Conditions/Terms-e-Documents.aspx>. Attention is drawn to the limitation of liability, indemnification and jurisdiction issues defined therein. Any holder of this document is advised that information contained hereon reflects the Company's findings at the time of its intervention only and within the limits of Client's instructions, if any. The Company's sole responsibility is to its Client and this document does not exonerate parties to a transaction from exercising all their rights and obligations under the transaction documents. This document cannot be reproduced except in full, without prior written approval of the Company. Any unauthorized alteration, forgery or falsification of the content or appearance of this document is unlawful and offenders may be prosecuted to the fullest extent of the law. Unless otherwise stated the results shown in this test report refer only to the sample(s) tested and such sample(s) are retained for 30 days only.  
Attention: To check the authenticity of testing /inspection report & certificate, please contact us at telephone: (86-755) 8307 1443, or email: [CN\\_Doccheck@sgs.com](mailto:CN_Doccheck@sgs.com)

No.10, Weiye Road, Innovation Park, Kunshan, Jiangsu, China 215300  
中国·江苏·昆山市留学生创业园伟业路10号 邮编 215300

t(86-512)57355888 f(86-512)57370818 www.sgs.com.cn  
t(86-512)57355888 f(86-512)57370818 sgs.china@sgs.com

Channel: 5510MHz  
Result: PASS

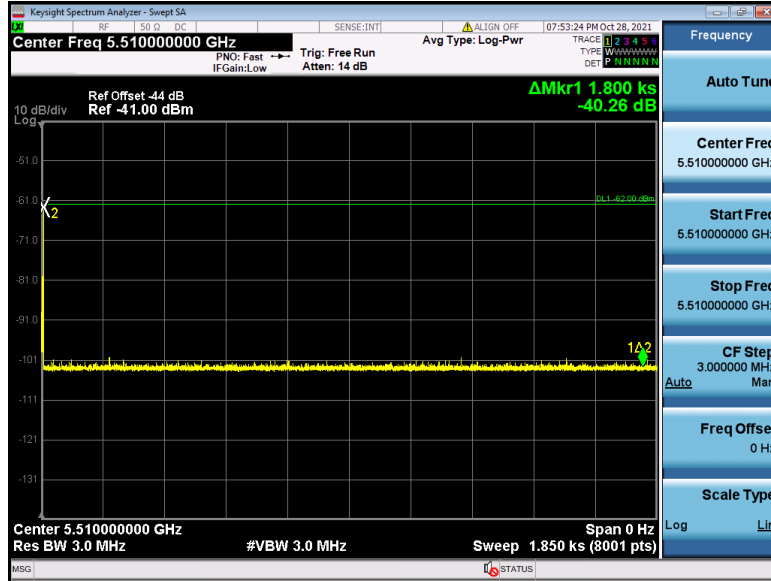

Channel: 5530MHz  
Result: PASS

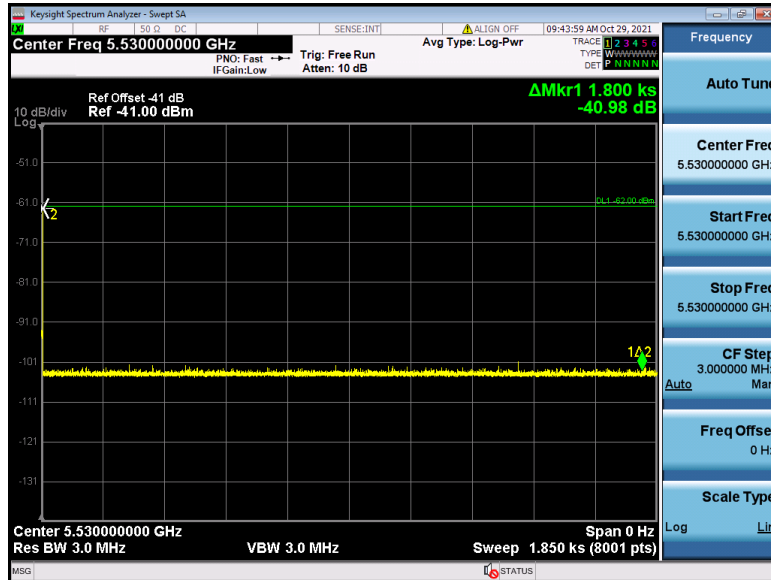

Unless otherwise agreed in writing, this document is issued by the Company subject to its General Conditions of Service printed overleaf, available on request or accessible at <http://www.sgs.com/en/Terms-and-Conditions.aspx> and, for electronic format documents, subject to Terms and Conditions for Electronic Documents at <http://www.sgs.com/en/Terms-and-Conditions/Terms-e-Documents.aspx>. Attention is drawn to the limitation of liability, indemnification and jurisdiction issues defined therein. Any holder of this document is advised that information contained hereon reflects the Company's findings at the time of its intervention only and within the limits of Client's instructions, if any. The Company's sole responsibility is to its Client and this document does not exonerate parties to a transaction from exercising all their rights and obligations under the transaction documents. This document cannot be reproduced except in full, without prior written approval of the Company. Any unauthorized alteration, forgery or falsification of the content or appearance of this document is unlawful and offenders may be prosecuted to the fullest extent of the law. Unless otherwise stated the results shown in this test report refer only to the sample(s) tested and such sample(s) are retained for 30 days only.  
Attention: To check the authenticity of testing /inspection report & certificate, please contact us at telephone: (86-755) 8307 1443, or email: [CN\\_Doccheck@sgs.com](mailto:CN_Doccheck@sgs.com)

No.10, Weiye Road, Innovation Park, Kunshan, Jiangsu, China 215300  
中国·江苏·昆山市留学生创业园伟业路10号 邮编 215300

t(86-512)57355888 f(86-512)57370818 www.sgs.com.cn  
t(86-512)57355888 f(86-512)57370818 sgs.china@sgs.com

**6.9.7 Statistical Performance Check**

A U-NII device operating as a Client Device associates with the UUT (Master) at 5300 MHz, 5310MHz, 5290MHz, 5500MHz, 5510MHz & 5510MHz. Stream the MPEG test file from the Master Device to the Client Device on the selected Channel for the entire period of the test. The device can also utilize a test mode to demonstrate when detection occurs to prevent the need to reset the device between trial runs. The Radar Waveform generator sends the individual waveform for each of radar type 1~6 with a level equal to the DFS detection threshold level + 1dB (-61dBm).

11ac(VHT20) CH60 5300MHz  
Type 1 Radar Statistical Performance

Trial Number	Freq (MHz)	Pulse Width (us)	PRI (us)	Pulses/Burst	Waveform Length(us)	1=Detection 0=No Detection
1	5300	1	938.0	57	53466.0	1
2	5301	1	698.0	76	53048.0	1
3	5302	1	618.0	86	53148.0	1
4	5303	1	538.0	99	53262.0	1
5	5304	1	878.0	61	53558.0	1
6	5305	1	3066.0	18	55188.0	1
7	5306	1	638.0	83	52954.0	1
8	5307	1	918.0	58	53244.0	0
9	5308	1	838.0	63	52794.0	1
10	5309	1	858.0	62	53196.0	0
11	5290	1	798.0	67	53466.0	0
12	5292	1	718.0	74	53132.0	1
13	5293	1	578.0	92	53176.0	0
14	5294	1	598.0	89	53222.0	1
15	5295	1	558.0	95	53010.0	1
16	5296	1	2536.0	21	53256.0	1
17	5297	1	966.0	55	53130.0	1
18	5298	1	827.0	64	52928.0	1
19	5299	1	2501.0	22	55022.0	1
20	5300	1	2595.0	21	54495.0	1
21	5301	1	1114.0	48	53472.0	1
22	5302	1	1302.0	41	53382.0	1
23	5303	1	3045.0	18	54810.0	1
24	5304	1	1624.0	33	53592.0	1
25	5305	1	2878.0	19	54682.0	1
26	5306	1	1027.0	52	53404.0	0
27	5307	1	2485.0	22	54670.0	1



Unless otherwise agreed in writing, this document is issued by the Company subject to its General Conditions of Service printed overleaf, available on request or accessible at <http://www.sgs.com/en/Terms-and-Conditions.aspx> and, for electronic format documents, subject to Terms and Conditions for Electronic Documents at <http://www.sgs.com/en/Terms-and-Conditions/Terms-e-Documents.aspx>. Attention is drawn to the limitation of liability, indemnification and jurisdiction issues defined therein. Any holder of this document is advised that information contained hereon reflects the Company's findings at the time of its intervention only and within the limits of Client's instructions, if any. The Company's sole responsibility is to its Client and this document does not exonerate parties to a transaction from exercising all their rights and obligations under the transaction documents. This document cannot be reproduced except in full, without prior written approval of the Company. Any unauthorized alteration, forgery or falsification of the content or appearance of this document is unlawful and offenders may be prosecuted to the fullest extent of the law. Unless otherwise stated the results shown in this test report refer only to the sample(s) tested and such sample(s) are retained for 30 days only.

Attention: To check the authenticity of testing / inspection report & certificate, please contact us at telephone: (86-755) 8307 1443, or email: [CN.Doccheck@sgs.com](mailto:CN.Doccheck@sgs.com)  
 No.10, Weiye Road, Innovation Park, Kunshan, Jiangsu, China 215300      t(86-512)57355888      f(86-512)57370818      www.sgs.com.cn  
 中国·江苏·昆山市留学院创业园伟业路10号 邮编 215300      t(86-512)57355888      f(86-512)57370818      sgs.china@sgs.com

28	5308	1	1600.0	33	52800.0	1
29	5309	1	1172.0	46	53912.0	0
30	5300	1	1177.0	45	52965.0	1
Detection Percentage						80% (≥60%)



Unless otherwise agreed in writing, this document is issued by the Company subject to its General Conditions of Service printed overleaf, available on request or accessible at <http://www.sgs.com/en/Terms-and-Conditions.aspx> and, for electronic format documents, subject to Terms and Conditions for Electronic Documents at <http://www.sgs.com/en/Terms-and-Conditions/Terms-e-Documents.aspx>. Attention is drawn to the limitation of liability, indemnification and jurisdiction issues defined therein. Any holder of this document is advised that information contained hereon reflects the Company's findings at the time of its intervention only and within the limits of Client's instructions, if any. The Company's sole responsibility is to its Client and this document does not exonerate parties to a transaction from exercising all their rights and obligations under the transaction documents. This document cannot be reproduced except in full, without prior written approval of the Company. Any unauthorized alteration, forgery or falsification of the content or appearance of this document is unlawful and offenders may be prosecuted to the fullest extent of the law. Unless otherwise stated the results shown in this test report refer only to the sample(s) tested and such sample(s) are retained for 30 days only.

Attention: To check the authenticity of testing /inspection report & certificate, please contact us at telephone: (86-755) 8307 1443, or email: [CN.Doccheck@sgs.com](mailto:CN.Doccheck@sgs.com)

Compliance Certification Services (Kunshan) Inc.  
EMC Laboratory

No.10, Weiye Road, Innovation Park, Kunshan, Jiangsu, China 215300  
中国·江苏·昆山市留学生创业园伟业路10号 邮编 215300

t(86-512)57355888 f(86-512)57370818 www.sgs.com.cn  
t(86-512)57355888 f(86-512)57370818 sgs.china@sgs.com

**Type 2 Radar Statistical Performance**

Trial Number	Freq (MHz)	Pulse Width (us)	PRI (us)	Pulses/Burst	Waveform Length(us)	1=Detection 0=No Detection
1	5300	3.2	179.0	26	4654.0	1
2	5301	1.1	207.0	23	4761.0	1
3	5302	2.1	230.0	24	5520.0	1
4	5303	4.8	200.0	29	5800.0	1
5	5304	3.9	214.0	28	5992.0	1
6	5305	2.9	222.0	26	5772.0	1
7	5306	3.2	204.0	26	5304.0	1
8	5307	2.5	192.0	25	4800.0	1
9	5308	3.1	164.0	26	4264.0	1
10	5309	1.2	156.0	23	3588.0	1
11	5290	3.9	210.0	27	5670.0	1
12	5292	4.6	201.0	29	5829.0	1
13	5293	3.2	162.0	26	4212.0	1
14	5294	2.2	197.0	25	4925.0	1
15	5295	4.5	163.0	29	4727.0	1
16	5296	3.0	203.0	26	5278.0	1
17	5297	5.0	168.0	29	4872.0	1
18	5298	2.4	217.0	25	5425.0	1
19	5299	2.9	191.0	26	4966.0	1
20	5300	2.3	166.0	25	4150.0	1
21	5301	3.7	150.0	27	4050.0	1
22	5302	2.2	176.0	25	4400.0	1
23	5303	4.9	195.0	29	5655.0	1
24	5304	2.9	202.0	26	5252.0	1
25	5305	2.5	178.0	25	4450.0	1
26	5306	1.1	206.0	23	4738.0	1
27	5307	3.8	155.0	27	4185.0	1
28	5308	4.7	157.0	29	4553.0	1
29	5309	2.4	224.0	25	5600.0	1
30	5300	4.2	159.0	28	4452.0	1
<b>Detection Percentage</b>						<b>100% (≥60%)</b>



Unless otherwise agreed in writing, this document is issued by the Company subject to its General Conditions of Service printed overleaf, available on request or accessible at <http://www.sgs.com/en/Terms-and-Conditions.aspx> and, for electronic format documents, subject to Terms and Conditions for Electronic Documents at <http://www.sgs.com/en/Terms-and-Conditions/Terms-e-Document.aspx>. Attention is drawn to the limitation of liability, indemnification and jurisdiction issues defined therein. Any holder of this document is advised that information contained hereon reflects the Company's findings at the time of its intervention only and within the limits of Client's instructions, if any. The Company's sole responsibility is to its Client and this document does not exonerate parties to a transaction from exercising all their rights and obligations under the transaction documents. This document cannot be reproduced except in full, without prior written approval of the Company. Any unauthorized alteration, forgery or falsification of the content or appearance of this document is unlawful and offenders may be prosecuted to the fullest extent of the law. Unless otherwise stated the results shown in this test report refer only to the sample(s) tested and such sample(s) are retained for 30 days only.

Attention: To check the authenticity of testing /inspection report & certificate, please contact us at telephone: (86-755) 8307 1443, or email: [CN.Doccheck@sgs.com](mailto:CN.Doccheck@sgs.com)  
 No.10, Weiye Road, Innovation Park, Kunshan, Jiangsu, China 215300      t(86-512)57355888    f(86-512)57370818    www.sgs.com.cn  
 中国·江苏·昆山市留学生创业园伟业路10号 邮编 215300      t(86-512)57355888    f(86-512)57370818    sgs.china@sgs.com



**Type 3 Radar Statistical Performance**

Trial Number	Freq (MHz)	Pulse Width (us)	PRI (us)	Pulses/Burst	Waveform Length(us)	1=Detection 0=No Detection
1	5300	8.2	355.0	17	6035.0	1
2	5301	6.1	487.0	16	7792.0	1
3	5302	7.1	344.0	16	5504.0	1
4	5303	9.8	288.0	18	5184.0	1
5	5304	8.9	230.0	18	4140.0	1
6	5305	7.9	432.0	17	7344.0	1
7	5306	8.2	207.0	17	3519.0	1
8	5307	7.5	443.0	17	7531.0	1
9	5308	8.1	439.0	17	7463.0	1
10	5309	6.2	223.0	16	3568.0	1
11	5290	8.9	208.0	18	3744.0	1
12	5292	9.6	463.0	18	8334.0	1
13	5293	8.2	441.0	17	7497.0	1
14	5294	7.2	323.0	16	5168.0	1
15	5295	9.5	297.0	18	5346.0	1
16	5296	8.0	412.0	17	7004.0	1
17	5297	10.0	324.0	18	5832.0	1
18	5298	7.4	271.0	17	4607.0	1
19	5299	7.9	349.0	17	5933.0	1
20	5300	7.3	409.0	16	6544.0	1
21	5301	8.7	373.0	18	6714.0	1
22	5302	7.2	254.0	16	4064.0	1
23	5303	9.9	274.0	18	4932.0	1
24	5304	7.9	278.0	17	4726.0	1
25	5305	7.5	317.0	17	5389.0	1
26	5306	6.1	260.0	16	4160.0	1
27	5307	8.8	211.0	18	3798.0	1
28	5308	9.7	272.0	18	4896.0	1
29	5309	7.4	264.0	17	4488.0	1
30	5300	9.2	284.0	18	5112.0	1
<b>Detection Percentage</b>						<b>100% (≥60%)</b>



Unless otherwise agreed in writing, this document is issued by the Company subject to its General Conditions of Service printed overleaf, available on request or accessible at <http://www.sgs.com/en/Terms-and-Conditions.aspx> and, for electronic format documents, subject to Terms and Conditions for Electronic Documents at <http://www.sgs.com/en/Terms-and-Conditions/Terms-e-Documents.aspx>. Attention is drawn to the limitation of liability, indemnification and jurisdiction issues defined therein. Any holder of this document is advised that information contained hereon reflects the Company's findings at the time of its intervention only and within the limits of Client's instructions, if any. The Company's sole responsibility is to its Client and this document does not exonerate parties to a transaction from exercising all their rights and obligations under the transaction documents. This document cannot be reproduced except in full, without prior written approval of the Company. Any unauthorized alteration, forgery or falsification of the content or appearance of this document is unlawful and offenders may be prosecuted to the fullest extent of the law. Unless otherwise stated the results shown in this test report refer only to the sample(s) tested and such sample(s) are retained for 30 days only.

Attention: To check the authenticity of testing / inspection report & certificate, please contact us at telephone: (86-755) 8307 1443, or email: [CN.Doccheck@sgs.com](mailto:CN.Doccheck@sgs.com)  
 No.10, Weiye Road, Innovation Park, Kunshan, Jiangsu, China 215300      t(86-512)57355888      f(86-512)57370818      www.sgs.com.cn  
 中国·江苏·昆山市留学生创业园伟业路10号 邮编 215300      t(86-512)57355888      f(86-512)57370818      sgs.china@sgs.com

**Type 4 Radar Statistical Performance**

Trial Number	Freq (MHz)	Pulse Width (us)	PRI (us)	Pulses/Burst	Waveform Length(us)	1=Detection 0=No Detection
1	5300	16.0	355.0	14	4970.0	1
2	5301	11.3	487.0	12	5844.0	1
3	5302	13.5	344.0	13	4472.0	1
4	5303	19.4	288.0	16	4608.0	1
5	5304	17.5	230.0	15	3450.0	1
6	5305	15.3	432.0	14	6048.0	1
7	5306	15.9	207.0	14	2898.0	1
8	5307	14.3	443.0	13	5759.0	1
9	5308	15.8	439.0	14	6146.0	1
10	5309	11.5	223.0	12	2676.0	0
11	5290	17.4	208.0	15	3120.0	1
12	5292	19.0	463.0	16	7408.0	0
13	5293	16.0	441.0	14	6174.0	1
14	5294	13.8	323.0	13	4199.0	1
15	5295	18.9	297.0	16	4752.0	1
16	5296	15.5	412.0	14	5768.0	1
17	5297	19.9	324.0	16	5184.0	1
18	5298	14.1	271.0	13	3523.0	1
19	5299	15.2	349.0	14	4886.0	1
20	5300	13.8	409.0	13	5317.0	1
21	5301	17.1	373.0	15	5595.0	1
22	5302	13.8	254.0	13	3302.0	1
23	5303	19.8	274.0	16	4384.0	1
24	5304	15.3	278.0	14	3892.0	0
25	5305	14.5	317.0	13	4121.0	1
26	5306	11.3	260.0	12	3120.0	1
27	5307	17.3	211.0	15	3165.0	1
28	5308	19.2	272.0	16	4352.0	1
29	5309	14.2	264.0	13	3432.0	1
30	5300	18.2	284.0	15	4260.0	1
<b>Detection Percentage</b>						<b>90% (≥60%)</b>
In addition an average minimum percentage of successful detection across all four Short pulse radar test waveforms is as follows: $\frac{P_d1+P_d2+P_d3+P_d4}{4} = (80\%+90\%+80\%+80\%)/4 (\geq 80\%)$						



Unless otherwise agreed in writing, this document is issued by the Company subject to its General Conditions of Service printed overleaf, available on request or accessible at <http://www.sgs.com/en/Terms-and-Conditions.aspx> and, for electronic format documents, subject to Terms and Conditions for Electronic Documents at <http://www.sgs.com/en/Terms-and-Conditions/Terms-e-Documents.aspx>. Attention is drawn to the limitation of liability, indemnification and jurisdiction issues defined therein. Any holder of this document is advised that information contained hereon reflects the Company's findings at the time of its intervention only and within the limits of Client's instructions, if any. The Company's sole responsibility is to its Client and this document does not exonerate parties to a transaction from exercising all their rights and obligations under the transaction documents. This document cannot be reproduced except in full, without prior written approval of the Company. Any unauthorized alteration, forgery or falsification of the content or appearance of this document is unlawful and offenders may be prosecuted to the fullest extent of the law. Unless otherwise stated the results shown in this test report refer only to the sample(s) tested and such sample(s) are retained for 30 days only.

Attention: To check the authenticity of testing /inspection report & certificate, please contact us at telephone: (86-755) 8307 1443, or email: [CN.Doccheck@sgs.com](mailto:CN.Doccheck@sgs.com)  
 No.10, Weiye Road, Innovation Park, Kunshan, Jiangsu, China 215300      t(86-512)57355888      f(86-512)57370818      www.sgs.com.cn  
 中国·江苏·昆山市留学院创业园伟业路10号 邮编 215300      t(86-512)57355888      f(86-512)57370818      sgs.china@sgs.com

**Type 5 Radar Statistical Performance**

Trial Number	Center Frequency (GHz)	Number of Bursts	Chirp Width (MHz)	Burst Period(s)	Waveform Length(s)	1=Detection 0=No Detection
0	5.300000000	15	13	0.8000000	12.0000000	1
1	5.300000000	8	5	1.5000000	12.0000000	1
2	5.300000000	11	9	1.0909091	12.0000000	1
3	5.300000000	20	19	0.6000000	12.0000000	1
4	5.300000000	17	16	0.7058824	12.0000000	1
5	5.300000000	14	12	0.8571429	12.0000000	1
6	5.300000000	15	13	0.8000000	12.0000000	1
7	5.300000000	12	10	1.0000000	12.0000000	1
8	5.300000000	14	13	0.8571429	12.0000000	1
9	5.300000000	8	6	1.5000000	12.0000000	1
10	5.296400000	17	16	0.7058824	12.0000000	1
11	5.297600000	19	19	0.6315789	12.0000000	1
12	5.295200000	15	13	0.8000000	12.0000000	1
13	5.294000000	12	10	1.0000000	12.0000000	0
14	5.297200000	19	18	0.6315789	12.0000000	1
15	5.294800000	14	12	0.8571429	12.0000000	1
16	5.298000000	20	20	0.6000000	12.0000000	1
17	5.294000000	12	10	1.0000000	12.0000000	1
18	5.294800000	14	12	0.8571429	12.0000000	1
19	5.294000000	12	10	1.0000000	12.0000000	1
20	5.304000000	16	15	0.7500000	12.0000000	1
21	5.306400000	12	9	1.0000000	12.0000000	1
22	5.302000000	20	20	0.6000000	12.0000000	0
23	5.305200000	14	12	0.8571429	12.0000000	1
24	5.305600000	13	11	0.9230769	12.0000000	1
25	5.308000000	8	5	1.5000000	12.0000000	1
26	5.303600000	17	16	0.7058824	12.0000000	1
27	5.302400000	19	19	0.6315789	12.0000000	0
28	5.306000000	12	10	1.0000000	12.0000000	1
29	5.303200000	18	17	0.6666667	12.0000000	1
<b>Detection Percentage</b>						<b>90% (≥80%)</b>



Unless otherwise agreed in writing, this document is issued by the Company subject to its General Conditions of Service printed overleaf, available on request or accessible at <http://www.sgs.com/en/Terms-and-Conditions.aspx> and, for electronic format documents, subject to Terms and Conditions for Electronic Documents at <http://www.sgs.com/en/Terms-and-Conditions/Terms-e-Documents.aspx>. Attention is drawn to the limitation of liability, indemnification and jurisdiction issues defined therein. Any holder of this document is advised that information contained hereon reflects the Company's findings at the time of its intervention only and within the limits of Client's instructions, if any. The Company's sole responsibility is to its Client and this document does not exonerate parties to a transaction from exercising all their rights and obligations under the transaction documents. This document cannot be reproduced except in full, without prior written approval of the Company. Any unauthorized alteration, forgery or falsification of the content or appearance of this document is unlawful and offenders may be prosecuted to the fullest extent of the law. Unless otherwise stated the results shown in this test report refer only to the sample(s) tested and such sample(s) are retained for 30 days only.

Attention: To check the authenticity of testing /inspection report & certificate, please contact us at telephone: (86-755) 8307 1443, or email: [CN.Doccheck@sgs.com](mailto:CN.Doccheck@sgs.com)  
 No.10, Weiye Road, Innovation Park, Kunshan, Jiangsu, China 215300      t(86-512)57355888      f(86-512)57370818      www.sgs.com.cn  
 中国·江苏·昆山市留学生创业园伟业路10号 邮编 215300      t(86-512)57355888      f(86-512)57370818      sgs.china@sgs.com

**Type 6 Radar Statistical Performance**

Trial Number	Pulse Width (us)	PRI (us)	Pulse per Hop	Hopping Rate (kHz)	Hopping Sequence Length (ms)	Visible Frequency Number	1=Detection 0=No Detection
0	1.0	333.3	9	0.3333	300.0000000	4	1
1	1.0	333.3	9	0.3333	300.0000000	1	1
2	1.0	333.3	9	0.3333	300.0000000	3	1
3	1.0	333.3	9	0.3333	300.0000000	5	1
4	1.0	333.3	9	0.3333	300.0000000	4	1
5	1.0	333.3	9	0.3333	300.0000000	3	1
6	1.0	333.3	9	0.3333	300.0000000	5	1
7	1.0	333.3	9	0.3333	300.0000000	5	0
8	1.0	333.3	9	0.3333	300.0000000	6	1
9	1.0	333.3	9	0.3333	300.0000000	1	1
10	1.0	333.3	9	0.3333	300.0000000	5	1
11	1.0	333.3	9	0.3333	300.0000000	6	1
12	1.0	333.3	9	0.3333	300.0000000	4	1
13	1.0	333.3	9	0.3333	300.0000000	6	1
14	1.0	333.3	9	0.3333	300.0000000	5	1
15	1.0	333.3	9	0.3333	300.0000000	5	1
16	1.0	333.3	9	0.3333	300.0000000	5	1
17	1.0	333.3	9	0.3333	300.0000000	3	0
18	1.0	333.3	9	0.3333	300.0000000	3	1
19	1.0	333.3	9	0.3333	300.0000000	3	1
20	1.0	333.3	9	0.3333	300.0000000	5	0
21	1.0	333.3	9	0.3333	300.0000000	6	1
22	1.0	333.3	9	0.3333	300.0000000	5	1
23	1.0	333.3	9	0.3333	300.0000000	4	1
24	1.0	333.3	9	0.3333	300.0000000	3	1
25	1.0	333.3	9	0.3333	300.0000000	5	1
26	1.0	333.3	9	0.3333	300.0000000	3	1
27	1.0	333.3	9	0.3333	300.0000000	5	1
28	1.0	333.3	9	0.3333	300.0000000	6	1
29	1.0	333.3	9	0.3333	300.0000000	6	1
Detection Percentage							90% (≥70%)



Unless otherwise agreed in writing, this document is issued by the Company subject to its General Conditions of Service printed overleaf, available on request or accessible at <http://www.sgs.com/en/Terms-and-Conditions.aspx> and, for electronic format documents, subject to Terms and Conditions for Electronic Documents at <http://www.sgs.com/en/Terms-and-Conditions/Terms-e-Documents.aspx>. Attention is drawn to the limitation of liability, indemnification and jurisdiction issues defined therein. Any holder of this document is advised that information contained herein reflects the Company's findings at the time of its intervention only and within the limits of Client's instructions, if any. The Company's sole responsibility is to its Client and this document does not exonerate parties to a transaction from exercising all their rights and obligations under the transaction documents. This document cannot be reproduced except in full, without prior written approval of the Company. Any unauthorized alteration, forgery or falsification of the content or appearance of this document is unlawful and offenders may be prosecuted to the fullest extent of the law. Unless otherwise stated the results shown in this test report refer only to the sample(s) tested and such sample(s) are retained for 30 days only.

Attention: To check the authenticity of testing / inspection report & certificate, please contact us at telephone: (86-755) 8307 1443, or email: [CN.Doccheck@sgs.com](mailto:CN.Doccheck@sgs.com)  
 No.10, Weiye Road, Innovation Park, Kunshan, Jiangsu, China 215300  
 中国·江苏·昆山市留学院创业园伟业路10号 邮编 215300

t(86-512)57355888 f(86-512)57370818 www.sgs.com.cn  
 t(86-512)57355888 f(86-512)57370818 sgs.china@sgs.com

11ac(VHT20) CH100 5500MHz  
Type 1 Radar Statistical Performance

Trial Number	Freq (MHz)	Pulse Width (us)	PRI (us)	Pulses/Burst	Waveform Length(us)	1=Detection 0=No Detection
1	5500	1	938.0	57	53466.0	1
2	5501	1	698.0	76	53048.0	1
3	5502	1	618.0	86	53148.0	1
4	5503	1	538.0	99	53262.0	0
5	5504	1	878.0	61	53558.0	1
6	5505	1	3066.0	18	55188.0	1
7	5506	1	638.0	83	52954.0	1
8	5507	1	918.0	58	53244.0	1
9	5508	1	838.0	63	52794.0	1
10	5509	1	858.0	62	53196.0	0
11	5490	1	798.0	67	53466.0	1
12	5492	1	718.0	74	53132.0	1
13	5493	1	578.0	92	53176.0	1
14	5494	1	598.0	89	53222.0	1
15	5495	1	558.0	95	53010.0	1
16	5496	1	2536.0	21	53256.0	1
17	5497	1	966.0	55	53130.0	1
18	5498	1	827.0	64	52928.0	1
19	5499	1	2501.0	22	55022.0	1
20	5500	1	2595.0	21	54495.0	1
21	5501	1	1114.0	48	53472.0	1
22	5502	1	1302.0	41	53382.0	1
23	5503	1	3045.0	18	54810.0	1
24	5504	1	1624.0	33	53592.0	1
25	5505	1	2878.0	19	54682.0	1
26	5506	1	1027.0	52	53404.0	1
27	5507	1	2485.0	22	54670.0	1
28	5508	1	1600.0	33	52800.0	1
29	5509	1	1172.0	46	53912.0	0
30	5500	1	1177.0	45	52965.0	1
Detection Percentage						90% (≥60%)



Unless otherwise agreed in writing, this document is issued by the Company subject to its General Conditions of Service printed overleaf, available on request or accessible at <http://www.sgs.com/en/Terms-and-Conditions.aspx> and, for electronic format documents, subject to Terms and Conditions for Electronic Documents at <http://www.sgs.com/en/Terms-and-Conditions/Terms-e-Documents.aspx>. Attention is drawn to the limitation of liability, indemnification and jurisdiction issues defined therein. Any holder of this document is advised that information contained hereon reflects the Company's findings at the time of its intervention only and within the limits of Client's instructions, if any. The Company's sole responsibility is to its Client and this document does not exonerate parties to a transaction from exercising all their rights and obligations under the transaction documents. This document cannot be reproduced except in full, without prior written approval of the Company. Any unauthorized alteration, forgery or falsification of the content or appearance of this document is unlawful and offenders may be prosecuted to the fullest extent of the law. Unless otherwise stated the results shown in this test report refer only to the sample(s) tested and such sample(s) are retained for 30 days only.

Attention: To check the authenticity of testing / inspection report & certificate, please contact us at telephone: (86-755) 8307 1443, or email: [CN.Doccheck@sgs.com](mailto:CN.Doccheck@sgs.com)  
 No.10, Weiye Road, Innovation Park, Kunshan, Jiangsu, China 215300      t(86-512)57355888      f(86-512)57370818      www.sgs.com.cn  
 中国·江苏·昆山市留学生创业园伟业路10号 邮编 215300      t(86-512)57355888      f(86-512)57370818      sgs.china@sgs.com



**Type 2 Radar Statistical Performance**

Trial Number	Freq (MHz)	Pulse Width (us)	PRI (us)	Pulses/Burst	Waveform Length(us)	1=Detection 0=No Detection
1	5500	3.2	179.0	26	4654.0	1
2	5501	1.1	207.0	23	4761.0	1
3	5502	2.1	230.0	24	5520.0	1
4	5503	4.8	200.0	29	5800.0	1
5	5504	3.9	214.0	28	5992.0	1
6	5505	2.9	222.0	26	5772.0	1
7	5506	3.2	204.0	26	5304.0	1
8	5507	2.5	192.0	25	4800.0	1
9	5508	3.1	164.0	26	4264.0	1
10	5509	1.2	156.0	23	3588.0	1
11	5490	3.9	210.0	27	5670.0	1
12	5492	4.6	201.0	29	5829.0	1
13	5493	3.2	162.0	26	4212.0	1
14	5494	2.2	197.0	25	4925.0	1
15	5495	4.5	163.0	29	4727.0	1
16	5496	3.0	203.0	26	5278.0	1
17	5497	5.0	168.0	29	4872.0	1
18	5498	2.4	217.0	25	5425.0	1
19	5499	2.9	191.0	26	4966.0	1
20	5500	2.3	166.0	25	4150.0	1
21	5501	3.7	150.0	27	4050.0	1
22	5502	2.2	176.0	25	4400.0	1
23	5503	4.9	195.0	29	5655.0	1
24	5504	2.9	202.0	26	5252.0	1
25	5505	2.5	178.0	25	4450.0	1
26	5506	1.1	206.0	23	4738.0	1
27	5507	3.8	155.0	27	4185.0	1
28	5508	4.7	157.0	29	4553.0	1
29	5509	2.4	224.0	25	5600.0	1
30	5500	4.2	159.0	28	4452.0	1
<b>Detection Percentage</b>						<b>100% (≥60%)</b>



Unless otherwise agreed in writing, this document is issued by the Company subject to its General Conditions of Service printed overleaf, available on request or accessible at <http://www.sgs.com/en/Terms-and-Conditions.aspx> and, for electronic format documents, subject to Terms and Conditions for Electronic Documents at <http://www.sgs.com/en/Terms-and-Conditions/Terms-e-Documents.aspx>. Attention is drawn to the limitation of liability, indemnification and jurisdiction issues defined therein. Any holder of this document is advised that information contained hereon reflects the Company's findings at the time of its intervention only and within the limits of Client's instructions, if any. The Company's sole responsibility is to its Client and this document does not exonerate parties to a transaction from exercising all their rights and obligations under the transaction documents. This document cannot be reproduced except in full, without prior written approval of the Company. Any unauthorized alteration, forgery or falsification of the content or appearance of this document is unlawful and offenders may be prosecuted to the fullest extent of the law. Unless otherwise stated the results shown in this test report refer only to the sample(s) tested and such sample(s) are retained for 30 days only.

Attention: To check the authenticity of testing /inspection report & certificate, please contact us at telephone: (86-755) 8307 1443, or email: [CN.Doccheck@sgs.com](mailto:CN.Doccheck@sgs.com)  
 No.10, Weiye Road, Innovation Park, Kunshan, Jiangsu, China 215300      t(86-512)57355888      f(86-512)57370818      www.sgs.com.cn  
 中国·江苏·昆山市留学生创业园伟业路10号 邮编 215300      t(86-512)57355888      f(86-512)57370818      sgs.china@sgs.com

Type 3 Radar Statistical Performance

Trial Number	Freq (MHz)	Pulse Width (us)	PRI (us)	Pulses/Burst	Waveform Length(us)	1=Detection 0=No Detection
1	5500	8.2	355.0	17	6035.0	1
2	5501	6.1	487.0	16	7792.0	1
3	5502	7.1	344.0	16	5504.0	1
4	5503	9.8	288.0	18	5184.0	1
5	5504	8.9	230.0	18	4140.0	1
6	5505	7.9	432.0	17	7344.0	0
7	5506	8.2	207.0	17	3519.0	1
8	5507	7.5	443.0	17	7531.0	1
9	5508	8.1	439.0	17	7463.0	1
10	5509	6.2	223.0	16	3568.0	1
11	5490	8.9	208.0	18	3744.0	0
12	5492	9.6	463.0	18	8334.0	1
13	5493	8.2	441.0	17	7497.0	0
14	5494	7.2	323.0	16	5168.0	1
15	5495	9.5	297.0	18	5346.0	1
16	5496	8.0	412.0	17	7004.0	1
17	5497	10.0	324.0	18	5832.0	1
18	5498	7.4	271.0	17	4607.0	1
19	5499	7.9	349.0	17	5933.0	1
20	5500	7.3	409.0	16	6544.0	1
21	5501	8.7	373.0	18	6714.0	1
22	5502	7.2	254.0	16	4064.0	1
23	5503	9.9	274.0	18	4932.0	1
24	5504	7.9	278.0	17	4726.0	1
25	5505	7.5	317.0	17	5389.0	1
26	5506	6.1	260.0	16	4160.0	0
27	5507	8.8	211.0	18	3798.0	1
28	5508	9.7	272.0	18	4896.0	1
29	5509	7.4	264.0	17	4488.0	0
30	5500	9.2	284.0	18	5112.0	0
Detection Percentage						80% (≥60%)



Unless otherwise agreed in writing, this document is issued by the Company subject to its General Conditions of Service printed overleaf, available on request or accessible at <http://www.sgs.com/en/Terms-and-Conditions.aspx> and, for electronic format documents, subject to Terms and Conditions for Electronic Documents at <http://www.sgs.com/en/Terms-and-Conditions/Terms-e-Documents.aspx>. Attention is drawn to the limitation of liability, indemnification and jurisdiction issues defined therein. Any holder of this document is advised that information contained hereon reflects the Company's findings at the time of its intervention only and within the limits of Client's instructions, if any. The Company's sole responsibility is to its Client and this document does not exonerate parties to a transaction from exercising all their rights and obligations under the transaction documents. This document cannot be reproduced except in full, without prior written approval of the Company. Any unauthorized alteration, forgery or falsification of the content or appearance of this document is unlawful and offenders may be prosecuted to the fullest extent of the law. Unless otherwise stated the results shown in this test report refer only to the sample(s) tested and such sample(s) are retained for 30 days only.  
Attention: To check the authenticity of testing /inspection report & certificate, please contact us at telephone: (86-755) 8307 1443, or email: [CN.Doccheck@sgs.com](mailto:CN.Doccheck@sgs.com)

No.10, Weiye Road, Innovation Park, Kunshan, Jiangsu, China 215300  
中国·江苏·昆山市留学生创业园伟业路10号 邮编 215300

t(86-512)57355888 f(86-512)57370818 www.sgs.com.cn  
t(86-512)57355888 f(86-512)57370818 sgs.china@sgs.com

**Type 4 Radar Statistical Performance**

Trial Number	Freq (MHz)	Pulse Width (us)	PRI (us)	Pulses/Burst	Waveform Length(us)	1=Detection 0=No Detection
1	5500	16.0	355.0	14	4970.0	1
2	5501	11.3	487.0	12	5844.0	1
3	5502	13.5	344.0	13	4472.0	1
4	5503	19.4	288.0	16	4608.0	1
5	5504	17.5	230.0	15	3450.0	1
6	5505	15.3	432.0	14	6048.0	1
7	5506	15.9	207.0	14	2898.0	1
8	5507	14.3	443.0	13	5759.0	1
9	5508	15.8	439.0	14	6146.0	1
10	5509	11.5	223.0	12	2676.0	1
11	5490	17.4	208.0	15	3120.0	1
12	5492	19.0	463.0	16	7408.0	1
13	5493	16.0	441.0	14	6174.0	1
14	5494	13.8	323.0	13	4199.0	1
15	5495	18.9	297.0	16	4752.0	1
16	5496	15.5	412.0	14	5768.0	1
17	5497	19.9	324.0	16	5184.0	1
18	5498	14.1	271.0	13	3523.0	1
19	5499	15.2	349.0	14	4886.0	1
20	5500	13.8	409.0	13	5317.0	1
21	5501	17.1	373.0	15	5595.0	1
22	5502	13.8	254.0	13	3302.0	1
23	5503	19.8	274.0	16	4384.0	1
24	5504	15.3	278.0	14	3892.0	1
25	5505	14.5	317.0	13	4121.0	1
26	5506	11.3	260.0	12	3120.0	1
27	5507	17.3	211.0	15	3165.0	1
28	5508	19.2	272.0	16	4352.0	1
29	5509	14.2	264.0	13	3432.0	1
30	5500	18.2	284.0	15	4260.0	1
Detection Percentage						100% (≥60%)
In addition an average minimum percentage of successful detection across all four Short pulse radar test waveforms is as follows: $\frac{P_d1+P_d2+P_d3+P_d4}{4} = (80\%+90\%+80\%+80\%)/4 (\geq 80\%)$						



Unless otherwise agreed in writing, this document is issued by the Company subject to its General Conditions of Service printed overleaf, available on request or accessible at <http://www.sgs.com/en/Terms-and-Conditions.aspx> and, for electronic format documents, subject to Terms and Conditions for Electronic Documents at <http://www.sgs.com/en/Terms-and-Conditions/Terms-e-Document.aspx>. Attention is drawn to the limitation of liability, indemnification and jurisdiction issues defined therein. Any holder of this document is advised that information contained hereon reflects the Company's findings at the time of its intervention only and within the limits of Client's instructions, if any. The Company's sole responsibility is to its Client and this document does not exonerate parties to a transaction from exercising all their rights and obligations under the transaction documents. This document cannot be reproduced except in full, without prior written approval of the Company. Any unauthorized alteration, forgery or falsification of the content or appearance of this document is unlawful and offenders may be prosecuted to the fullest extent of the law. Unless otherwise stated the results shown in this test report refer only to the sample(s) tested and such sample(s) are retained for 30 days only.

No.10, Weiye Road, Innovation Park, Kunshan, Jiangsu, China 215300  
 中国·江苏·昆山市留学院创业园伟业路10号 邮编 215300

Attention: To check the authenticity of testing /inspection report & certificate, please contact us at telephone: (86-755) 8307 1443, or email: [CN.Doccheck@sgs.com](mailto:CN.Doccheck@sgs.com)  
 t(86-512)57355888 f(86-512)57370818 www.sgs.com.cn  
 t(86-512)57355888 f(86-512)57370818 sgs.china@sgs.com

**Type 5 Radar Statistical Performance**

Trial Number	Center Frequency (GHz)	Number of Bursts	Chirp Width (MHz)	Burst Period(s)	Waveform Length(s)	1=Detection 0=No Detection
0	5.500000000	15	13	0.8000000	12.0000000	1
1	5.500000000	8	5	1.5000000	12.0000000	1
2	5.500000000	11	9	1.0909091	12.0000000	1
3	5.500000000	20	19	0.6000000	12.0000000	1
4	5.500000000	17	16	0.7058824	12.0000000	1
5	5.500000000	14	12	0.8571429	12.0000000	1
6	5.500000000	15	13	0.8000000	12.0000000	1
7	5.500000000	12	10	1.0000000	12.0000000	1
8	5.500000000	14	13	0.8571429	12.0000000	1
9	5.500000000	8	6	1.5000000	12.0000000	1
10	5.496400000	17	16	0.7058824	12.0000000	1
11	5.497600000	19	19	0.6315789	12.0000000	0
12	5.495200000	15	13	0.8000000	12.0000000	1
13	5.494000000	12	10	1.0000000	12.0000000	1
14	5.497200000	19	18	0.6315789	12.0000000	0
15	5.494800000	14	12	0.8571429	12.0000000	1
16	5.498000000	20	20	0.6000000	12.0000000	1
17	5.494000000	12	10	1.0000000	12.0000000	1
18	5.494800000	14	12	0.8571429	12.0000000	1
19	5.494000000	12	10	1.0000000	12.0000000	1
20	5.504000000	16	15	0.7500000	12.0000000	1
21	5.506400000	12	9	1.0000000	12.0000000	1
22	5.502000000	20	20	0.6000000	12.0000000	1
23	5.505200000	14	12	0.8571429	12.0000000	1
24	5.505600000	13	11	0.9230769	12.0000000	1
25	5.508000000	8	5	1.5000000	12.0000000	1
26	5.503600000	17	16	0.7058824	12.0000000	1
27	5.502400000	19	19	0.6315789	12.0000000	1
28	5.506000000	12	10	1.0000000	12.0000000	0
29	5.503200000	18	17	0.6666667	12.0000000	1
<b>Detection Percentage</b>						<b>90% (≥80%)</b>



Unless otherwise agreed in writing, this document is issued by the Company subject to its General Conditions of Service printed overleaf, available on request or accessible at <http://www.sgs.com/en/Terms-and-Conditions.aspx> and, for electronic format documents, subject to Terms and Conditions for Electronic Documents at <http://www.sgs.com/en/Terms-and-Conditions/Terms-e-Documents.aspx>. Attention is drawn to the limitation of liability, indemnification and jurisdiction issues defined therein. Any holder of this document is advised that information contained hereon reflects the Company's findings at the time of its intervention only and within the limits of Client's instructions, if any. The Company's sole responsibility is to its Client and this document does not exonerate parties to a transaction from exercising all their rights and obligations under the transaction documents. This document cannot be reproduced except in full, without prior written approval of the Company. Any unauthorized alteration, forgery or falsification of the content or appearance of this document is unlawful and offenders may be prosecuted to the fullest extent of the law. Unless otherwise stated the results shown in this test report refer only to the sample(s) tested and such sample(s) are retained for 30 days only.

Attention: To check the authenticity of testing / inspection report & certificate, please contact us at telephone: (86-755) 8307 1443, or email: [CN.Doccheck@sgs.com](mailto:CN.Doccheck@sgs.com)  
 No.10, Weiye Road, Innovation Park, Kunshan, Jiangsu, China 215300      t(86-512)57355888      f(86-512)57370818      www.sgs.com.cn  
 中国·江苏·昆山市留学院创业园伟业路10号 邮编 215300      t(86-512)57355888      f(86-512)57370818      sgs.china@sgs.com

**Type 6 Radar Statistical Performance**

Trial Number	Pulse Width (us)	PRI (us)	Pulse per Hop	Hopping Rate (kHz)	Hopping Sequence Length (ms)	Visible Frequency Number	1=Detection 0=No Detection
0	1.0	333.3	9	0.3333	300.0000000	4	1
1	1.0	333.3	9	0.3333	300.0000000	1	1
2	1.0	333.3	9	0.3333	300.0000000	3	1
3	1.0	333.3	9	0.3333	300.0000000	5	1
4	1.0	333.3	9	0.3333	300.0000000	4	1
5	1.0	333.3	9	0.3333	300.0000000	3	1
6	1.0	333.3	9	0.3333	300.0000000	5	1
7	1.0	333.3	9	0.3333	300.0000000	5	1
8	1.0	333.3	9	0.3333	300.0000000	6	1
9	1.0	333.3	9	0.3333	300.0000000	1	1
10	1.0	333.3	9	0.3333	300.0000000	5	1
11	1.0	333.3	9	0.3333	300.0000000	6	1
12	1.0	333.3	9	0.3333	300.0000000	4	1
13	1.0	333.3	9	0.3333	300.0000000	6	1
14	1.0	333.3	9	0.3333	300.0000000	5	1
15	1.0	333.3	9	0.3333	300.0000000	5	1
16	1.0	333.3	9	0.3333	300.0000000	5	1
17	1.0	333.3	9	0.3333	300.0000000	3	1
18	1.0	333.3	9	0.3333	300.0000000	3	1
19	1.0	333.3	9	0.3333	300.0000000	3	1
20	1.0	333.3	9	0.3333	300.0000000	5	1
21	1.0	333.3	9	0.3333	300.0000000	6	1
22	1.0	333.3	9	0.3333	300.0000000	5	1
23	1.0	333.3	9	0.3333	300.0000000	4	1
24	1.0	333.3	9	0.3333	300.0000000	3	1
25	1.0	333.3	9	0.3333	300.0000000	5	1
26	1.0	333.3	9	0.3333	300.0000000	3	1
27	1.0	333.3	9	0.3333	300.0000000	5	1
28	1.0	333.3	9	0.3333	300.0000000	6	1
29	1.0	333.3	9	0.3333	300.0000000	6	1
Detection Percentage							100% (≥70%)



Unless otherwise agreed in writing, this document is issued by the Company subject to its General Conditions of Service printed overleaf, available on request or accessible at <http://www.sgs.com/en/Terms-and-Conditions.aspx> and, for electronic format documents, subject to Terms and Conditions for Electronic Documents at <http://www.sgs.com/en/Terms-and-Conditions/Terms-e-Documents.aspx>. Attention is drawn to the limitation of liability, indemnification and jurisdiction issues defined therein. Any holder of this document is advised that information contained herein reflects the Company's findings at the time of its intervention only and within the limits of Client's instructions, if any. The Company's sole responsibility is to its Client and this document does not exonerate parties to a transaction from exercising all their rights and obligations under the transaction documents. This document cannot be reproduced except in full, without prior written approval of the Company. Any unauthorized alteration, forgery or falsification of the content or appearance of this document is unlawful and offenders may be prosecuted to the fullest extent of the law. Unless otherwise stated the results shown in this test report refer only to the sample(s) tested and such sample(s) are retained for 30 days only.

Attention: To check the authenticity of testing / inspection report & certificate, please contact us at telephone: (86-755) 8307 1443, or email: [CN.Doccheck@sgs.com](mailto:CN.Doccheck@sgs.com)  
 No.10, Weiye Road, Innovation Park, Kunshan, Jiangsu, China 215300  
 中国·江苏·昆山市留学院创业园伟业路10号 邮编 215300

t(86-512)57355888 f(86-512)57370818 www.sgs.com.cn  
 t(86-512)57355888 f(86-512)57370818 sgs.china@sgs.com



## 11ac(VHT40) CH62 5310MHz

## Type 1 Radar Statistical Performance

Trial Number	Freq (MHz)	Pulse Width (us)	PRI (us)	Pulses/Burst	Waveform Length(us)	1=Detection 0=No Detection
1	5296	1.0	938.0	57	53466.0	1
2	5297	1.0	698.0	76	53048.0	1
3	5298	1.0	618.0	86	53148.0	1
4	5299	1.0	538.0	99	53262.0	1
5	5300	1.0	878.0	61	53558.0	1
6	5301	1.0	3066.0	18	55188.0	1
7	5302	1.0	638.0	83	52954.0	0
8	5303	1.0	918.0	58	53244.0	1
9	5304	1.0	838.0	63	52794.0	1
10	5305	1.0	858.0	62	53196.0	0
11	5306	1.0	798.0	67	53466.0	0
12	5307	1.0	718.0	74	53132.0	1
13	5308	1.0	578.0	92	53176.0	1
14	5309	1.0	598.0	89	53222.0	1
15	5310	1.0	558.0	95	53010.0	1
16	5311	1.0	2536.0	21	53256.0	1
17	5312	1.0	966.0	55	53130.0	1
18	5313	1.0	827.0	64	52928.0	1
19	5314	1.0	2501.0	22	55022.0	1
20	5315	1.0	2595.0	21	54495.0	1
21	5316	1.0	1114.0	48	53472.0	1
22	5317	1.0	1302.0	41	53382.0	1
23	5318	1.0	3045.0	18	54810.0	1
24	5319	1.0	1624.0	33	53592.0	1
25	5320	1.0	2878.0	19	54682.0	1
26	5321	1.0	1027.0	52	53404.0	1
27	5322	1.0	2485.0	22	54670.0	1
28	5323	1.0	1600.0	33	52800.0	1
29	5324	1.0	1172.0	46	53912.0	1
30	5325	1.0	1177.0	45	52965.0	1
Detection Percentage						90% (≥60%)



Unless otherwise agreed in writing, this document is issued by the Company subject to its General Conditions of Service printed overleaf, available on request or accessible at <http://www.sgs.com/en/Terms-and-Conditions.aspx> and, for electronic format documents, subject to Terms and Conditions for Electronic Documents at <http://www.sgs.com/en/Terms-and-Conditions/Terms-e-Documents.aspx>. Attention is drawn to the limitation of liability, indemnification and jurisdiction issues defined therein. Any holder of this document is advised that information contained hereon reflects the Company's findings at the time of its intervention only and within the limits of Client's instructions, if any. The Company's sole responsibility is to its Client and this document does not exonerate parties to a transaction from exercising all their rights and obligations under the transaction documents. This document cannot be reproduced except in full, without prior written approval of the Company. Any unauthorized alteration, forgery or falsification of the content or appearance of this document is unlawful and offenders may be prosecuted to the fullest extent of the law. Unless otherwise stated the results shown in this test report refer only to the sample(s) tested and such sample(s) are retained for 30 days only.

Attention: To check the authenticity of testing / inspection report & certificate, please contact us at telephone: (86-755) 8307 1443, or email: [CN.Doccheck@sgs.com](mailto:CN.Doccheck@sgs.com)  
 No.10, Weiye Road, Innovation Park, Kunshan, Jiangsu, China 215300      t(86-512)57355888      f(86-512)57370818      www.sgs.com.cn  
 中国·江苏·昆山市留学院创业园伟业路10号 邮编 215300      t(86-512)57355888      f(86-512)57370818      sgs.china@sgs.com

Type 2 Radar Statistical Performance

Trial Number	Freq (MHz)	Pulse Width (us)	PRI (us)	Pulses/Burst	Waveform Length(us)	1=Detection 0=No Detection
1	5296	3.2	179.0	26	4654.0	1
2	5297	1.1	207.0	23	4761.0	1
3	5298	2.1	230.0	24	5520.0	1
4	5299	4.8	200.0	29	5800.0	1
5	5300	3.9	214.0	28	5992.0	1
6	5301	2.9	222.0	26	5772.0	1
7	5302	3.2	204.0	26	5304.0	1
8	5303	2.5	192.0	25	4800.0	1
9	5304	3.1	164.0	26	4264.0	1
10	5305	1.2	156.0	23	3588.0	0
11	5306	3.9	210.0	27	5670.0	1
12	5307	4.6	201.0	29	5829.0	1
13	5308	3.2	162.0	26	4212.0	1
14	5309	2.2	197.0	25	4925.0	1
15	5310	4.5	163.0	29	4727.0	1
16	5311	3.0	203.0	26	5278.0	1
17	5312	5.0	168.0	29	4872.0	1
18	5313	2.4	217.0	25	5425.0	0
19	5314	2.9	191.0	26	4966.0	1
20	5315	2.3	166.0	25	4150.0	1
21	5316	3.7	150.0	27	4050.0	1
22	5317	2.2	176.0	25	4400.0	1
23	5318	4.9	195.0	29	5655.0	1
24	5319	2.9	202.0	26	5252.0	1
25	5320	2.5	178.0	25	4450.0	1
26	5321	1.1	206.0	23	4738.0	0
27	5322	3.8	155.0	27	4185.0	1
28	5323	4.7	157.0	29	4553.0	1
29	5324	2.4	224.0	25	5600.0	1
30	5325	4.2	159.0	28	4452.0	1
Detection Percentage						90% (≥60%)



Unless otherwise agreed in writing, this document is issued by the Company subject to its General Conditions of Service printed overleaf, available on request or accessible at <http://www.sgs.com/en/Terms-and-Conditions.aspx> and, for electronic format documents, subject to Terms and Conditions for Electronic Documents at <http://www.sgs.com/en/Terms-and-Conditions/Terms-e-Documents.aspx>. Attention is drawn to the limitation of liability, indemnification and jurisdiction issues defined therein. Any holder of this document is advised that information contained hereon reflects the Company's findings at the time of its intervention only and within the limits of Client's instructions, if any. The Company's sole responsibility is to its Client and this document does not exonerate parties to a transaction from exercising all their rights and obligations under the transaction documents. This document cannot be reproduced except in full, without prior written approval of the Company. Any unauthorized alteration, forgery or falsification of the content or appearance of this document is unlawful and offenders may be prosecuted to the fullest extent of the law. Unless otherwise stated the results shown in this test report refer only to the sample(s) tested and such sample(s) are retained for 30 days only.  
Attention: To check the authenticity of testing /inspection report & certificate, please contact us at telephone: (86-755) 8307 1443, or email: [CN.Doccheck@sgs.com](mailto:CN.Doccheck@sgs.com)

Compliance Certification Services (Kunshan) Inc.  
EMC Laboratory

No.10, Weiye Road, Innovation Park, Kunshan, Jiangsu, China 215300  
中国·江苏·昆山市留学生创业园伟业路10号 邮编 215300

t(86-512)57355888 f(86-512)57370818 www.sgs.com.cn  
t(86-512)57355888 f(86-512)57370818 sgs.china@sgs.com

Type 3 Radar Statistical Performance

Trial Number	Freq (MHz)	Pulse Width (us)	PRI (us)	Pulses/Burst	Waveform Length(us)	1=Detection 0=No Detection
1	5296	8.2	355.0	17	6035.0	1
2	5297	6.1	487.0	16	7792.0	0
3	5298	7.1	344.0	16	5504.0	1
4	5299	9.8	288.0	18	5184.0	1
5	5300	8.9	230.0	18	4140.0	1
6	5301	7.9	432.0	17	7344.0	1
7	5302	8.2	207.0	17	3519.0	1
8	5303	7.5	443.0	17	7531.0	1
9	5304	8.1	439.0	17	7463.0	1
10	5305	6.2	223.0	16	3568.0	1
11	5306	8.9	208.0	18	3744.0	1
12	5307	9.6	463.0	18	8334.0	1
13	5308	8.2	441.0	17	7497.0	1
14	5309	7.2	323.0	16	5168.0	1
15	5310	9.5	297.0	18	5346.0	1
16	5311	8.0	412.0	17	7004.0	1
17	5312	10.0	324.0	18	5832.0	1
18	5313	7.4	271.0	17	4607.0	1
19	5314	7.9	349.0	17	5933.0	1
20	5315	7.3	409.0	16	6544.0	0
21	5316	8.7	373.0	18	6714.0	1
22	5317	7.2	254.0	16	4064.0	1
23	5318	9.9	274.0	18	4932.0	1
24	5319	7.9	278.0	17	4726.0	1
25	5320	7.5	317.0	17	5389.0	1
26	5321	6.1	260.0	16	4160.0	1
27	5322	8.8	211.0	18	3798.0	1
28	5323	9.7	272.0	18	4896.0	1
29	5324	7.4	264.0	17	4488.0	0
30	5325	9.2	284.0	18	5112.0	1
Detection Percentage						90% (≥60%)



Unless otherwise agreed in writing, this document is issued by the Company subject to its General Conditions of Service printed overleaf, available on request or accessible at <http://www.sgs.com/en/Terms-and-Conditions.aspx> and, for electronic format documents, subject to Terms and Conditions for Electronic Documents at <http://www.sgs.com/en/Terms-and-Conditions/Terms-e-Document.aspx>. Attention is drawn to the limitation of liability, indemnification and jurisdiction issues defined therein. Any holder of this document is advised that information contained hereon reflects the Company's findings at the time of its intervention only and within the limits of Client's instructions, if any. The Company's sole responsibility is to its Client and this document does not exonerate parties to a transaction from exercising all their rights and obligations under the transaction documents. This document cannot be reproduced except in full, without prior written approval of the Company. Any unauthorized alteration, forgery or falsification of the content or appearance of this document is unlawful and offenders may be prosecuted to the fullest extent of the law. Unless otherwise stated the results shown in this test report refer only to the sample(s) tested and such sample(s) are retained for 30 days only.  
Attention: To check the authenticity of testing /inspection report & certificate, please contact us at telephone: (86-755) 8307 1443, or email: [CN.Doccheck@sgs.com](mailto:CN.Doccheck@sgs.com)

Compliance Certification Services (Kunshan) Inc.  
EMC Laboratory

No.10, Weiye Road, Innovation Park, Kunshan, Jiangsu, China 215300  
中国·江苏·昆山市留学生创业园伟业路10号 邮编 215300

t(86-512)57355888 f(86-512)57370818 www.sgs.com.cn  
t(86-512)57355888 f(86-512)57370818 sgs.china@sgs.com

**Type 4 Radar Statistical Performance**

Trial Number	Freq (MHz)	Pulse Width (us)	PRI (us)	Pulses/Burst	Waveform Length(us)	1=Detection 0=No Detection
1	5296	16.0	355.0	14	4970.0	1
2	5297	11.3	487.0	12	5844.0	1
3	5298	13.5	344.0	13	4472.0	1
4	5299	19.4	288.0	16	4608.0	1
5	5300	17.5	230.0	15	3450.0	1
6	5301	15.3	432.0	14	6048.0	1
7	5302	15.9	207.0	14	2898.0	1
8	5303	14.3	443.0	13	5759.0	1
9	5304	15.8	439.0	14	6146.0	1
10	5305	11.5	223.0	12	2676.0	1
11	5306	17.4	208.0	15	3120.0	1
12	5307	19.0	463.0	16	7408.0	1
13	5308	16.0	441.0	14	6174.0	1
14	5309	13.8	323.0	13	4199.0	1
15	5310	18.9	297.0	16	4752.0	1
16	5311	15.5	412.0	14	5768.0	1
17	5312	19.9	324.0	16	5184.0	1
18	5313	14.1	271.0	13	3523.0	1
19	5314	15.2	349.0	14	4886.0	1
20	5315	13.8	409.0	13	5317.0	1
21	5316	17.1	373.0	15	5595.0	1
22	5317	13.8	254.0	13	3302.0	1
23	5318	19.8	274.0	16	4384.0	1
24	5319	15.3	278.0	14	3892.0	1
25	5320	14.5	317.0	13	4121.0	1
26	5321	11.3	260.0	12	3120.0	1
27	5322	17.3	211.0	15	3165.0	1
28	5323	19.2	272.0	16	4352.0	1
29	5324	14.2	264.0	13	3432.0	1
30	5325	18.2	284.0	15	4260.0	1
Detection Percentage						100% (≥60%)
In addition an average minimum percentage of successful detection across all four Short pulse radar test waveforms is as follows: $\frac{P_d1+P_d2+P_d3+P_d4}{4} = (80\%+90\%+90\%+90\%)/4 (\geq 80\%)$						



Unless otherwise agreed in writing, this document is issued by the Company subject to its General Conditions of Service printed overleaf, available on request or accessible at <http://www.sgs.com/en/Terms-and-Conditions.aspx> and, for electronic format documents, subject to Terms and Conditions for Electronic Documents at <http://www.sgs.com/en/Terms-and-Conditions/Terms-e-Documents.aspx>. Attention is drawn to the limitation of liability, indemnification and jurisdiction issues defined therein. Any holder of this document is advised that information contained hereon reflects the Company's findings at the time of its intervention only and within the limits of Client's instructions, if any. The Company's sole responsibility is to its Client and this document does not exonerate parties to a transaction from exercising all their rights and obligations under the transaction documents. This document cannot be reproduced except in full, without prior written approval of the Company. Any unauthorized alteration, forgery or falsification of the content or appearance of this document is unlawful and offenders may be prosecuted to the fullest extent of the law. Unless otherwise stated the results shown in this test report refer only to the sample(s) tested and such sample(s) are retained for 30 days only.

No.10, Weiye Road, Innovation Park, Kunshan, Jiangsu, China 215300  
 中国·江苏·昆山市留学院创业园伟业路10号 邮编 215300

Attention: To check the authenticity of testing /inspection report & certificate, please contact us at telephone: (86-755) 8307 1443, or email: [CN.Doccheck@sgs.com](mailto:CN.Doccheck@sgs.com)  
 t(86-512)57355888 f(86-512)57370818 www.sgs.com.cn  
 t(86-512)57355888 f(86-512)57370818 sgs.china@sgs.com

**Type 5 Radar Statistical Performance**

Trial Number	Center Frequency (GHz)	Number of Bursts	Chirp Width (MHz)	Burst Period(s)	Waveform Length(s)	1=Detection 0=No Detection
0	5.310000000	15	13	0.8000000	12.0000000	1
1	5.310000000	8	5	1.5000000	12.0000000	1
2	5.310000000	11	9	1.0909091	12.0000000	1
3	5.310000000	20	19	0.6000000	12.0000000	1
4	5.310000000	17	16	0.7058824	12.0000000	1
5	5.310000000	14	12	0.8571429	12.0000000	1
6	5.310000000	15	13	0.8000000	12.0000000	0
7	5.310000000	12	10	1.0000000	12.0000000	1
8	5.310000000	14	13	0.8571429	12.0000000	1
9	5.310000000	8	6	1.5000000	12.0000000	0
10	5.290000000	17	16	0.7058824	12.0000000	1
11	5.290000000	19	19	0.6315789	12.0000000	1
12	5.295200000	15	13	0.8000000	12.0000000	1
13	5.294000000	12	10	1.0000000	12.0000000	1
14	5.297200000	19	18	0.6315789	12.0000000	1
15	5.294800000	14	12	0.8571429	12.0000000	1
16	5.298000000	20	20	0.6000000	12.0000000	0
17	5.294000000	12	10	1.0000000	12.0000000	1
18	5.294800000	14	12	0.8571429	12.0000000	1
19	5.294000000	12	10	1.0000000	12.0000000	1
20	5.324000000	16	15	0.7500000	12.0000000	1
21	5.326400000	12	9	1.0000000	12.0000000	1
22	5.322000000	20	20	0.6000000	12.0000000	1
23	5.325200000	14	12	0.8571429	12.0000000	1
24	5.325600000	13	11	0.9230769	12.0000000	1
25	5.328000000	8	5	1.5000000	12.0000000	1
26	5.323600000	17	16	0.7058824	12.0000000	1
27	5.322400000	19	19	0.6315789	12.0000000	1
28	5.326000000	12	10	1.0000000	12.0000000	1
29	5.323200000	18	17	0.6666667	12.0000000	1
<b>Detection Percentage</b>						<b>90% (≥80%)</b>



Unless otherwise agreed in writing, this document is issued by the Company subject to its General Conditions of Service printed overleaf, available on request or accessible at <http://www.sgs.com/en/Terms-and-Conditions.aspx> and, for electronic format documents, subject to Terms and Conditions for Electronic Documents at <http://www.sgs.com/en/Terms-and-Conditions/Terms-e-Documents.aspx>. Attention is drawn to the limitation of liability, indemnification and jurisdiction issues defined therein. Any holder of this document is advised that information contained hereon reflects the Company's findings at the time of its intervention only and within the limits of Client's instructions, if any. The Company's sole responsibility is to its Client and this document does not exonerate parties to a transaction from exercising all their rights and obligations under the transaction documents. This document cannot be reproduced except in full, without prior written approval of the Company. Any unauthorized alteration, forgery or falsification of the content or appearance of this document is unlawful and offenders may be prosecuted to the fullest extent of the law. Unless otherwise stated the results shown in this test report refer only to the sample(s) tested and such sample(s) are retained for 30 days only.

Attention: To check the authenticity of testing / inspection report & certificate, please contact us at telephone: (86-755) 8307 1443, or email: [CN.Doccheck@sgs.com](mailto:CN.Doccheck@sgs.com)  
 No.10, Weiye Road, Innovation Park, Kunshan, Jiangsu, China 215300      ☎(86-512)57355888      ☎(86-512)57370818      [www.sgs.com](http://www.sgs.com)  
 中国·江苏·昆山市留学院创业园伟业路10号 邮编 215300      ☎(86-512)57355888      ☎(86-512)57370818      [sgs.china@sgs.com](mailto:sgs.china@sgs.com)



**Type 6 Radar Statistical Performance**

Trial Number	Pulse Width (us)	PRI (us)	Pulse per Hop	Hopping Rate (kHz)	Hopping Sequence Length (ms)	Visible Frequency Number	1=Detection 0=No Detection
0	1.0	333.3	9	0.3333	300.0000000	4	1
1	1.0	333.3	9	0.3333	300.0000000	1	1
2	1.0	333.3	9	0.3333	300.0000000	3	1
3	1.0	333.3	9	0.3333	300.0000000	5	1
4	1.0	333.3	9	0.3333	300.0000000	4	1
5	1.0	333.3	9	0.3333	300.0000000	3	1
6	1.0	333.3	9	0.3333	300.0000000	5	1
7	1.0	333.3	9	0.3333	300.0000000	5	1
8	1.0	333.3	9	0.3333	300.0000000	6	1
9	1.0	333.3	9	0.3333	300.0000000	1	1
10	1.0	333.3	9	0.3333	300.0000000	5	0
11	1.0	333.3	9	0.3333	300.0000000	6	0
12	1.0	333.3	9	0.3333	300.0000000	4	1
13	1.0	333.3	9	0.3333	300.0000000	6	0
14	1.0	333.3	9	0.3333	300.0000000	5	1
15	1.0	333.3	9	0.3333	300.0000000	5	1
16	1.0	333.3	9	0.3333	300.0000000	5	0
17	1.0	333.3	9	0.3333	300.0000000	3	1
18	1.0	333.3	9	0.3333	300.0000000	3	1
19	1.0	333.3	9	0.3333	300.0000000	3	1
20	1.0	333.3	9	0.3333	300.0000000	5	1
21	1.0	333.3	9	0.3333	300.0000000	6	0
22	1.0	333.3	9	0.3333	300.0000000	5	1
23	1.0	333.3	9	0.3333	300.0000000	4	1
24	1.0	333.3	9	0.3333	300.0000000	3	1
25	1.0	333.3	9	0.3333	300.0000000	5	1
26	1.0	333.3	9	0.3333	300.0000000	3	1
27	1.0	333.3	9	0.3333	300.0000000	5	0
28	1.0	333.3	9	0.3333	300.0000000	6	1
29	1.0	333.3	9	0.3333	300.0000000	6	1
<b>Detection Percentage</b>							<b>80% (≥70%)</b>



Unless otherwise agreed in writing, this document is issued by the Company subject to its General Conditions of Service printed overleaf, available on request or accessible at <http://www.sgs.com/en/Terms-and-Conditions.aspx> and, for electronic format documents, subject to Terms and Conditions for Electronic Documents at <http://www.sgs.com/en/Terms-and-Conditions/Terms-e-Documents.aspx>. Attention is drawn to the limitation of liability, indemnification and jurisdiction issues defined therein. Any holder of this document is advised that information contained herein reflects the Company's findings at the time of its intervention only and within the limits of Client's instructions, if any. The Company's sole responsibility is to its Client and this document does not exonerate parties to a transaction from exercising all their rights and obligations under the transaction documents. This document cannot be reproduced except in full, without prior written approval of the Company. Any unauthorized alteration, forgery or falsification of the content or appearance of this document is unlawful and offenders may be prosecuted to the fullest extent of the law. Unless otherwise stated the results shown in this test report refer only to the sample(s) tested and such sample(s) are retained for 30 days only.

Attention: To check the authenticity of testing / inspection report & certificate, please contact us at telephone: (86-755) 8307 1443, or email: [CN.Doccheck@sgs.com](mailto:CN.Doccheck@sgs.com)  
 No.10, Weiye Road, Innovation Park, Kunshan, Jiangsu, China 215300  
 中国·江苏·昆山市留学院创业园伟业路10号 邮编 215300

t(86-512)57355888 f(86-512)57370818 www.sgs.com.cn  
 t(86-512)57355888 f(86-512)57370818 sgs.china@sgs.com

11ac(VHT40) CH102 5510MHz  
Type 1 Radar Statistical Performance

Trial Number	Freq (MHz)	Pulse Width (us)	PRI (us)	Pulses/Burst	Waveform Length(us)	1=Detection 0=No Detection
1	5496	1.0	938.0	57	53466.0	1
2	5497	1.0	698.0	76	53048.0	1
3	5498	1.0	618.0	86	53148.0	1
4	5499	1.0	538.0	99	53262.0	1
5	5500	1.0	878.0	61	53558.0	1
6	5501	1.0	3066.0	18	55188.0	1
7	5502	1.0	638.0	83	52954.0	1
8	5503	1.0	918.0	58	53244.0	1
9	5504	1.0	838.0	63	52794.0	1
10	5505	1.0	858.0	62	53196.0	1
11	5506	1.0	798.0	67	53466.0	1
12	5507	1.0	718.0	74	53132.0	1
13	5508	1.0	578.0	92	53176.0	1
14	5509	1.0	598.0	89	53222.0	1
15	5510	1.0	558.0	95	53010.0	1
16	5511	1.0	2536.0	21	53256.0	1
17	5512	1.0	966.0	55	53130.0	1
18	5513	1.0	827.0	64	52928.0	1
19	5514	1.0	2501.0	22	55022.0	1
20	5515	1.0	2595.0	21	54495.0	1
21	5516	1.0	1114.0	48	53472.0	1
22	5517	1.0	1302.0	41	53382.0	1
23	5518	1.0	3045.0	18	54810.0	1
24	5519	1.0	1624.0	33	53592.0	1
25	5520	1.0	2878.0	19	54682.0	1
26	5521	1.0	1027.0	52	53404.0	1
27	5522	1.0	2485.0	22	54670.0	1
28	5523	1.0	1600.0	33	52800.0	1
29	5524	1.0	1172.0	46	53912.0	1
30	5525	1.0	1177.0	45	52965.0	1
Detection Percentage						100% (≥60%)



Unless otherwise agreed in writing, this document is issued by the Company subject to its General Conditions of Service printed overleaf, available on request or accessible at <http://www.sgs.com/en/Terms-and-Conditions.aspx> and, for electronic format documents, subject to Terms and Conditions for Electronic Documents at <http://www.sgs.com/en/Terms-and-Conditions/Terms-e-Documents.aspx>. Attention is drawn to the limitation of liability, indemnification and jurisdiction issues defined therein. Any holder of this document is advised that information contained hereon reflects the Company's findings at the time of its intervention only and within the limits of Client's instructions, if any. The Company's sole responsibility is to its Client and this document does not exonerate parties to a transaction from exercising all their rights and obligations under the transaction documents. This document cannot be reproduced except in full, without prior written approval of the Company. Any unauthorized alteration, forgery or falsification of the content or appearance of this document is unlawful and offenders may be prosecuted to the fullest extent of the law. Unless otherwise stated the results shown in this test report refer only to the sample(s) tested and such sample(s) are retained for 30 days only.

Attention: To check the authenticity of testing / inspection report & certificate, please contact us at telephone: (86-755) 8307 1443, or email: [CN.Doccheck@sgs.com](mailto:CN.Doccheck@sgs.com)  
 No.10, Weiye Road, Innovation Park, Kunshan, Jiangsu, China 215300      t(86-512)57355888    f(86-512)57370818    www.sgs.com.cn  
 中国·江苏·昆山市留学生创业园伟业路10号 邮编 215300      t(86-512)57355888    f(86-512)57370818    sgs.china@sgs.com

**Type 2 Radar Statistical Performance**

Trial Number	Freq (MHz)	Pulse Width (us)	PRI (us)	Pulses/Burst	Waveform Length(us)	1=Detection 0=No Detection
1	5496	3.2	179.0	26	4654.0	1
2	5497	1.1	207.0	23	4761.0	1
3	5498	2.1	230.0	24	5520.0	1
4	5499	4.8	200.0	29	5800.0	1
5	5500	3.9	214.0	28	5992.0	1
6	5501	2.9	222.0	26	5772.0	1
7	5502	3.2	204.0	26	5304.0	1
8	5503	2.5	192.0	25	4800.0	1
9	5504	3.1	164.0	26	4264.0	1
10	5505	1.2	156.0	23	3588.0	1
11	5506	3.9	210.0	27	5670.0	1
12	5507	4.6	201.0	29	5829.0	1
13	5508	3.2	162.0	26	4212.0	1
14	5509	2.2	197.0	25	4925.0	1
15	5510	4.5	163.0	29	4727.0	1
16	5511	3.0	203.0	26	5278.0	1
17	5512	5.0	168.0	29	4872.0	1
18	5513	2.4	217.0	25	5425.0	1
19	5514	2.9	191.0	26	4966.0	1
20	5515	2.3	166.0	25	4150.0	1
21	5516	3.7	150.0	27	4050.0	1
22	5517	2.2	176.0	25	4400.0	1
23	5518	4.9	195.0	29	5655.0	1
24	5519	2.9	202.0	26	5252.0	1
25	5520	2.5	178.0	25	4450.0	1
26	5521	1.1	206.0	23	4738.0	1
27	5522	3.8	155.0	27	4185.0	1
28	5523	4.7	157.0	29	4553.0	1
29	5524	2.4	224.0	25	5600.0	1
30	5525	4.2	159.0	28	4452.0	1
<b>Detection Percentage</b>						<b>100% (≥60%)</b>



Unless otherwise agreed in writing, this document is issued by the Company subject to its General Conditions of Service printed overleaf, available on request or accessible at <http://www.sgs.com/en/Terms-and-Conditions.aspx> and, for electronic format documents, subject to Terms and Conditions for Electronic Documents at <http://www.sgs.com/en/Terms-and-Conditions/Terms-e-Documents.aspx>. Attention is drawn to the limitation of liability, indemnification and jurisdiction issues defined therein. Any holder of this document is advised that information contained hereon reflects the Company's findings at the time of its intervention only and within the limits of Client's instructions, if any. The Company's sole responsibility is to its Client and this document does not exonerate parties to a transaction from exercising all their rights and obligations under the transaction documents. This document cannot be reproduced except in full, without prior written approval of the Company. Any unauthorized alteration, forgery or falsification of the content or appearance of this document is unlawful and offenders may be prosecuted to the fullest extent of the law. Unless otherwise stated the results shown in this test report refer only to the sample(s) tested and such sample(s) are retained for 30 days only.

Attention: To check the authenticity of testing/inspection report & certificate, please contact us at telephone: (86-755) 8307 1443, or email: [CN.Doccheck@sgs.com](mailto:CN.Doccheck@sgs.com)  
 No.10, Weiye Road, Innovation Park, Kunshan, Jiangsu, China 215300      t(86-512)57355888      f(86-512)57370818      www.sgs.com.cn  
 中国·江苏·昆山市留学生创业园伟业路10号 邮编 215300      t(86-512)57355888      f(86-512)57370818      sgs.china@sgs.com

**Type 3 Radar Statistical Performance**

Trial Number	Freq (MHz)	Pulse Width (us)	PRI (us)	Pulses/Burst	Waveform Length(us)	1=Detection 0=No Detection
1	5496	8.2	355.0	17	6035.0	1
2	5497	6.1	487.0	16	7792.0	1
3	5498	7.1	344.0	16	5504.0	1
4	5499	9.8	288.0	18	5184.0	1
5	5500	8.9	230.0	18	4140.0	1
6	5501	7.9	432.0	17	7344.0	1
7	5502	8.2	207.0	17	3519.0	1
8	5503	7.5	443.0	17	7531.0	1
9	5504	8.1	439.0	17	7463.0	1
10	5505	6.2	223.0	16	3568.0	1
11	5506	8.9	208.0	18	3744.0	1
12	5507	9.6	463.0	18	8334.0	1
13	5508	8.2	441.0	17	7497.0	1
14	5509	7.2	323.0	16	5168.0	0
15	5510	9.5	297.0	18	5346.0	1
16	5511	8.0	412.0	17	7004.0	1
17	5512	10.0	324.0	18	5832.0	1
18	5513	7.4	271.0	17	4607.0	1
19	5514	7.9	349.0	17	5933.0	1
20	5515	7.3	409.0	16	6544.0	1
21	5516	8.7	373.0	18	6714.0	0
22	5517	7.2	254.0	16	4064.0	1
23	5518	9.9	274.0	18	4932.0	1
24	5519	7.9	278.0	17	4726.0	1
25	5520	7.5	317.0	17	5389.0	1
26	5521	6.1	260.0	16	4160.0	1
27	5522	8.8	211.0	18	3798.0	1
28	5523	9.7	272.0	18	4896.0	1
29	5524	7.4	264.0	17	4488.0	0
30	5525	9.2	284.0	18	5112.0	1
<b>Detection Percentage</b>						<b>90% (≥60%)</b>



Unless otherwise agreed in writing, this document is issued by the Company subject to its General Conditions of Service printed overleaf, available on request or accessible at <http://www.sgs.com/en/Terms-and-Conditions.aspx> and, for electronic format documents, subject to Terms and Conditions for Electronic Documents at <http://www.sgs.com/en/Terms-and-Conditions/Terms-e-Documents.aspx>. Attention is drawn to the limitation of liability, indemnification and jurisdiction issues defined therein. Any holder of this document is advised that information contained hereon reflects the Company's findings at the time of its intervention only and within the limits of Client's instructions, if any. The Company's sole responsibility is to its Client and this document does not exonerate parties to a transaction from exercising all their rights and obligations under the transaction documents. This document cannot be reproduced except in full, without prior written approval of the Company. Any unauthorized alteration, forgery or falsification of the content or appearance of this document is unlawful and offenders may be prosecuted to the fullest extent of the law. Unless otherwise stated the results shown in this test report refer only to the sample(s) tested and such sample(s) are retained for 30 days only.

Attention: To check the authenticity of testing /inspection report & certificate, please contact us at telephone: (86-755) 8307 1443, or email: [CN.Doccheck@sgs.com](mailto:CN.Doccheck@sgs.com)  
 No.10, Weiye Road, Innovation Park, Kunshan, Jiangsu, China 215300      t(86-512)57355888      f(86-512)57370818      www.sgs.com.cn  
 中国·江苏·昆山市留学生创业园伟业路10号 邮编 215300      t(86-512)57355888      f(86-512)57370818      sgs.china@sgs.com

**Type 4 Radar Statistical Performance**

Trial Number	Freq (MHz)	Pulse Width (us)	PRI (us)	Pulses/Burst	Waveform Length(us)	1=Detection 0=No Detection
1	5496	16.0	355.0	14	4970.0	1
2	5497	11.3	487.0	12	5844.0	1
3	5498	13.5	344.0	13	4472.0	1
4	5499	19.4	288.0	16	4608.0	1
5	5500	17.5	230.0	15	3450.0	1
6	5501	15.3	432.0	14	6048.0	1
7	5502	15.9	207.0	14	2898.0	1
8	5503	14.3	443.0	13	5759.0	1
9	5504	15.8	439.0	14	6146.0	1
10	5505	11.5	223.0	12	2676.0	1
11	5506	17.4	208.0	15	3120.0	1
12	5507	19.0	463.0	16	7408.0	1
13	5508	16.0	441.0	14	6174.0	1
14	5509	13.8	323.0	13	4199.0	1
15	5510	18.9	297.0	16	4752.0	1
16	5511	15.5	412.0	14	5768.0	1
17	5512	19.9	324.0	16	5184.0	1
18	5513	14.1	271.0	13	3523.0	1
19	5514	15.2	349.0	14	4886.0	1
20	5515	13.8	409.0	13	5317.0	1
21	5516	17.1	373.0	15	5595.0	1
22	5517	13.8	254.0	13	3302.0	1
23	5518	19.8	274.0	16	4384.0	1
24	5519	15.3	278.0	14	3892.0	1
25	5520	14.5	317.0	13	4121.0	1
26	5521	11.3	260.0	12	3120.0	1
27	5522	17.3	211.0	15	3165.0	1
28	5523	19.2	272.0	16	4352.0	1
29	5524	14.2	264.0	13	3432.0	1
30	5525	18.2	284.0	15	4260.0	1
Detection Percentage						100% (≥60%)
In addition an average minimum percentage of successful detection across all four Short pulse radar test waveforms is as follows: $\frac{P_d1+P_d2+P_d3+P_d4}{4} = (80\%+90\%+90\%+90\%)/4 (\geq 80\%)$						



Unless otherwise agreed in writing, this document is issued by the Company subject to its General Conditions of Service printed overleaf, available on request or accessible at <http://www.sgs.com/en/Terms-and-Conditions.aspx> and, for electronic format documents, subject to Terms and Conditions for Electronic Documents at <http://www.sgs.com/en/Terms-and-Conditions/Terms-e-Document.aspx>. Attention is drawn to the limitation of liability, indemnification and jurisdiction issues defined therein. Any holder of this document is advised that information contained hereon reflects the Company's findings at the time of its intervention only and within the limits of Client's instructions, if any. The Company's sole responsibility is to its Client and this document does not exonerate parties to a transaction from exercising all their rights and obligations under the transaction documents. This document cannot be reproduced except in full, without prior written approval of the Company. Any unauthorized alteration, forgery or falsification of the content or appearance of this document is unlawful and offenders may be prosecuted to the fullest extent of the law. Unless otherwise stated the results shown in this test report refer only to the sample(s) tested and such sample(s) are retained for 30 days only.

No.10, Weiye Road, Innovation Park, Kunshan, Jiangsu, China 215300  
 中国·江苏·昆山市留学院创业园伟业路10号 邮编 215300

☎(86-512)57355888 ☎(86-512)57370818 www.sgs.com.cn  
 ☎(86-512)57355888 ☎(86-512)57370818 sgs.china@sgs.com



**Type 5 Radar Statistical Performance**

Trial Number	Center Frequency (GHz)	Number of Bursts	Chirp Width (MHz)	Burst Period(s)	Waveform Length(s)	1=Detection 0=No Detection
0	5.510000000	15	13	0.8000000	12.0000000	1
1	5.510000000	8	5	1.5000000	12.0000000	1
2	5.510000000	11	9	1.0909091	12.0000000	0
3	5.510000000	20	19	0.6000000	12.0000000	1
4	5.510000000	17	16	0.7058824	12.0000000	1
5	5.510000000	14	12	0.8571429	12.0000000	1
6	5.510000000	15	13	0.8000000	12.0000000	1
7	5.510000000	12	10	1.0000000	12.0000000	1
8	5.510000000	14	13	0.8571429	12.0000000	1
9	5.510000000	8	6	1.5000000	12.0000000	0
10	5.496400000	17	16	0.7058824	12.0000000	1
11	5.497600000	19	19	0.6315789	12.0000000	1
12	5.495200000	15	13	0.8000000	12.0000000	0
13	5.494000000	12	10	1.0000000	12.0000000	1
14	5.497200000	19	18	0.6315789	12.0000000	1
15	5.494800000	14	12	0.8571429	12.0000000	1
16	5.498000000	20	20	0.6000000	12.0000000	1
17	5.494000000	12	10	1.0000000	12.0000000	1
18	5.494800000	14	12	0.8571429	12.0000000	0
19	5.494000000	12	10	1.0000000	12.0000000	1
20	5.524000000	16	15	0.7500000	12.0000000	1
21	5.526400000	12	9	1.0000000	12.0000000	0
22	5.522000000	20	20	0.6000000	12.0000000	1
23	5.525200000	14	12	0.8571429	12.0000000	1
24	5.525600000	13	11	0.9230769	12.0000000	1
25	5.528000000	8	5	1.5000000	12.0000000	1
26	5.523600000	17	16	0.7058824	12.0000000	1
27	5.522400000	19	19	0.6315789	12.0000000	1
28	5.526000000	12	10	1.0000000	12.0000000	0
29	5.523200000	18	17	0.6666667	12.0000000	1
<b>Detection Percentage</b>						<b>80% (≥80%)</b>



Unless otherwise agreed in writing, this document is issued by the Company subject to its General Conditions of Service printed overleaf, available on request or accessible at <http://www.sgs.com/en/Terms-and-Conditions.aspx> and, for electronic format documents, subject to Terms and Conditions for Electronic Documents at <http://www.sgs.com/en/Terms-and-Conditions/Terms-e-Documents.aspx>. Attention is drawn to the limitation of liability, indemnification and jurisdiction issues defined therein. Any holder of this document is advised that information contained hereon reflects the Company's findings at the time of its intervention only and within the limits of Client's instructions, if any. The Company's sole responsibility is to its Client and this document does not exonerate parties to a transaction from exercising all their rights and obligations under the transaction documents. This document cannot be reproduced except in full, without prior written approval of the Company. Any unauthorized alteration, forgery or falsification of the content or appearance of this document is unlawful and offenders may be prosecuted to the fullest extent of the law. Unless otherwise stated the results shown in this test report refer only to the sample(s) tested and such sample(s) are retained for 30 days only.

Attention: To check the authenticity of testing /inspection report & certificate, please contact us at telephone: (86-755) 8307 1443, or email: [CN.Doccheck@sgs.com](mailto:CN.Doccheck@sgs.com)  
 No.10, Weiye Road, Innovation Park, Kunshan, Jiangsu, China 215300      t(86-512)57355888      f(86-512)57370818      www.sgs.com.cn  
 中国·江苏·昆山市留学生创业园伟业路10号 邮编 215300      t(86-512)57355888      f(86-512)57370818      sgs.china@sgs.com

**Type 6 Radar Statistical Performance**

Trial Number	Pulse Width (us)	PRI (us)	Pulse per Hop	Hopping Rate (kHz)	Hopping Sequence Length (ms)	Visible Frequency Number	1=Detection 0=No Detection
0	1.0	333.3	9	0.3333	300.0000000	4	1
1	1.0	333.3	9	0.3333	300.0000000	1	0
2	1.0	333.3	9	0.3333	300.0000000	3	1
3	1.0	333.3	9	0.3333	300.0000000	5	1
4	1.0	333.3	9	0.3333	300.0000000	4	1
5	1.0	333.3	9	0.3333	300.0000000	3	1
6	1.0	333.3	9	0.3333	300.0000000	5	0
7	1.0	333.3	9	0.3333	300.0000000	5	1
8	1.0	333.3	9	0.3333	300.0000000	6	1
9	1.0	333.3	9	0.3333	300.0000000	1	0
10	1.0	333.3	9	0.3333	300.0000000	5	1
11	1.0	333.3	9	0.3333	300.0000000	6	1
+12	1.0	333.3	9	0.3333	300.0000000	4	1
13	1.0	333.3	9	0.3333	300.0000000	6	1
14	1.0	333.3	9	0.3333	300.0000000	5	1
15	1.0	333.3	9	0.3333	300.0000000	5	1
16	1.0	333.3	9	0.3333	300.0000000	5	1
17	1.0	333.3	9	0.3333	300.0000000	3	0
18	1.0	333.3	9	0.3333	300.0000000	3	1
19	1.0	333.3	9	0.3333	300.0000000	3	1
20	1.0	333.3	9	0.3333	300.0000000	5	0
21	1.0	333.3	9	0.3333	300.0000000	6	1
22	1.0	333.3	9	0.3333	300.0000000	5	1
23	1.0	333.3	9	0.3333	300.0000000	4	1
24	1.0	333.3	9	0.3333	300.0000000	3	0
25	1.0	333.3	9	0.3333	300.0000000	5	1
26	1.0	333.3	9	0.3333	300.0000000	3	1
27	1.0	333.3	9	0.3333	300.0000000	5	1
28	1.0	333.3	9	0.3333	300.0000000	6	1
29	1.0	333.3	9	0.3333	300.0000000	6	1
<b>Detection Percentage</b>							<b>80% (≥70%)</b>



Unless otherwise agreed in writing, this document is issued by the Company subject to its General Conditions of Service printed overleaf, available on request or accessible at <http://www.sgs.com/en/Terms-and-Conditions.aspx> and, for electronic format documents, subject to Terms and Conditions for Electronic Documents at <http://www.sgs.com/en/Terms-and-Conditions/Terms-e-Documents.aspx>. Attention is drawn to the limitation of liability, indemnification and jurisdiction issues defined therein. Any holder of this document is advised that information contained herein reflects the Company's findings at the time of its intervention only and within the limits of Client's instructions, if any. The Company's sole responsibility is to its Client and this document does not exonerate parties to a transaction from exercising all their rights and obligations under the transaction documents. This document cannot be reproduced except in full, without prior written approval of the Company. Any unauthorized alteration, forgery or falsification of the content or appearance of this document is unlawful and offenders may be prosecuted to the fullest extent of the law. Unless otherwise stated the results shown in this test report refer only to the sample(s) tested and such sample(s) are retained for 30 days only.

Attention: To check the authenticity of testing / inspection report & certificate, please contact us at telephone: (86-755) 8307 1443, or email: [CN.Doccheck@sgs.com](mailto:CN.Doccheck@sgs.com)  
 No.10, Weiye Road, Innovation Park, Kunshan, Jiangsu, China 215300  
 中国·江苏·昆山市留学生创业园伟业路10号 邮编 215300

t(86-512)57355888 f(86-512)57370818 www.sgs.com.cn  
 t(86-512)57355888 f(86-512)57370818 sgs.china@sgs.com

## 11ac(VHT80) CH58 5290MHz

## Type 1 Radar Statistical Performance

Trial Number	Freq (MHz)	Pulse Width (us)	PRI (us)	Pulses/Burst	Waveform Length(us)	1=Detection 0=No Detection
1	5256	1.0	938.0	57	53466.0	1
2	5257	1.0	698.0	76	53048.0	1
3	5258	1.0	618.0	86	53148.0	1
4	5259	1.0	538.0	99	53262.0	1
5	5270	1.0	878.0	61	53558.0	1
6	5271	1.0	3066.0	18	55188.0	1
7	5272	1.0	638.0	83	52954.0	0
8	5273	1.0	918.0	58	53244.0	1
9	5274	1.0	838.0	63	52794.0	1
10	5275	1.0	858.0	62	53196.0	0
11	5286	1.0	798.0	67	53466.0	0
12	5287	1.0	718.0	74	53132.0	1
13	5288	1.0	578.0	92	53176.0	1
14	5289	1.0	598.0	89	53222.0	1
15	5290	1.0	558.0	95	53010.0	1
16	5291	1.0	2536.0	21	53256.0	1
17	5292	1.0	966.0	55	53130.0	1
18	5303	1.0	827.0	64	52928.0	1
19	5304	1.0	2501.0	22	55022.0	1
20	5305	1.0	2595.0	21	54495.0	1
21	5306	1.0	1114.0	48	53472.0	1
22	5317	1.0	1302.0	41	53382.0	1
23	5318	1.0	3045.0	18	54810.0	1
24	5319	1.0	1624.0	33	53592.0	1
25	5320	1.0	2878.0	19	54682.0	1
26	5321	1.0	1027.0	52	53404.0	1
27	5322	1.0	2485.0	22	54670.0	1
28	5323	1.0	1600.0	33	52800.0	1
29	5324	1.0	1172.0	46	53912.0	1
30	5325	1.0	1177.0	45	52965.0	1
Detection Percentage						90% (≥60%)



Unless otherwise agreed in writing, this document is issued by the Company subject to its General Conditions of Service printed overleaf, available on request or accessible at <http://www.sgs.com/en/Terms-and-Conditions.aspx> and, for electronic format documents, subject to Terms and Conditions for Electronic Documents at <http://www.sgs.com/en/Terms-and-Conditions/Terms-e-Documents.aspx>. Attention is drawn to the limitation of liability, indemnification and jurisdiction issues defined therein. Any holder of this document is advised that information contained hereon reflects the Company's findings at the time of its intervention only and within the limits of Client's instructions, if any. The Company's sole responsibility is to its Client and this document does not exonerate parties to a transaction from exercising all their rights and obligations under the transaction documents. This document cannot be reproduced except in full, without prior written approval of the Company. Any unauthorized alteration, forgery or falsification of the content or appearance of this document is unlawful and offenders may be prosecuted to the fullest extent of the law. Unless otherwise stated the results shown in this test report refer only to the sample(s) tested and such sample(s) are retained for 30 days only.

Attention: To check the authenticity of testing / inspection report & certificate, please contact us at telephone: (86-755) 8307 1443, or email: [CN.Doccheck@sgs.com](mailto:CN.Doccheck@sgs.com)  
 No.10, Weiye Road, Innovation Park, Kunshan, Jiangsu, China 215300      t(86-512)57355888      f(86-512)57370818      www.sgs.com.cn  
 中国·江苏·昆山市留学院创业园伟业路10号 邮编 215300      t(86-512)57355888      f(86-512)57370818      sgs.china@sgs.com

**Type 2 Radar Statistical Performance**

Trial Number	Freq (MHz)	Pulse Width (us)	PRI (us)	Pulses/Burst	Waveform Length(us)	1=Detection 0=No Detection
1	5256	3.2	179.0	26	4654.0	1
2	5257	1.1	207.0	23	4761.0	1
3	5258	2.1	230.0	24	5520.0	1
4	5259	4.8	200.0	29	5800.0	1
5	5270	3.9	214.0	28	5992.0	1
6	5271	2.9	222.0	26	5772.0	1
7	5272	3.2	204.0	26	5304.0	1
8	5273	2.5	192.0	25	4800.0	1
9	5274	3.1	164.0	26	4264.0	1
10	5275	1.2	156.0	23	3588.0	0
11	5286	3.9	210.0	27	5670.0	1
12	5287	4.6	201.0	29	5829.0	1
13	5288	3.2	162.0	26	4212.0	1
14	5289	2.2	197.0	25	4925.0	1
15	5290	4.5	163.0	29	4727.0	1
16	5291	3.0	203.0	26	5278.0	1
17	5292	5.0	168.0	29	4872.0	1
18	5303	2.4	217.0	25	5425.0	0
19	5304	2.9	191.0	26	4966.0	1
20	5305	2.3	166.0	25	4150.0	1
21	5306	3.7	150.0	27	4050.0	1
22	5317	2.2	176.0	25	4400.0	1
23	5318	4.9	195.0	29	5655.0	1
24	5319	2.9	202.0	26	5252.0	1
25	5320	2.5	178.0	25	4450.0	1
26	5321	1.1	206.0	23	4738.0	0
27	5322	3.8	155.0	27	4185.0	1
28	5323	4.7	157.0	29	4553.0	1
29	5324	2.4	224.0	25	5600.0	1
30	5325	4.2	159.0	28	4452.0	1
<b>Detection Percentage</b>						<b>90% (≥60%)</b>



Unless otherwise agreed in writing, this document is issued by the Company subject to its General Conditions of Service printed overleaf, available on request or accessible at <http://www.sgs.com/en/Terms-and-Conditions.aspx> and, for electronic format documents, subject to Terms and Conditions for Electronic Documents at <http://www.sgs.com/en/Terms-and-Conditions/Terms-e-Documents.aspx>. Attention is drawn to the limitation of liability, indemnification and jurisdiction issues defined therein. Any holder of this document is advised that information contained hereon reflects the Company's findings at the time of its intervention only and within the limits of Client's instructions, if any. The Company's sole responsibility is to its Client and this document does not exonerate parties to a transaction from exercising all their rights and obligations under the transaction documents. This document cannot be reproduced except in full, without prior written approval of the Company. Any unauthorized alteration, forgery or falsification of the content or appearance of this document is unlawful and offenders may be prosecuted to the fullest extent of the law. Unless otherwise stated the results shown in this test report refer only to the sample(s) tested and such sample(s) are retained for 30 days only.

Attention: To check the authenticity of testing /inspection report & certificate, please contact us at telephone: (86-755) 8307 1443, or email: [CN.Doccheck@sgs.com](mailto:CN.Doccheck@sgs.com)  
 No.10, Weiye Road, Innovation Park, Kunshan, Jiangsu, China 215300      t(86-512)57355888      f(86-512)57370818      www.sgs.com.cn  
 中国·江苏·昆山市留学院创业园伟业路10号 邮编 215300      t(86-512)57355888      f(86-512)57370818      sgs.china@sgs.com

**Type 3 Radar Statistical Performance**

Trial Number	Freq (MHz)	Pulse Width (us)	PRI (us)	Pulses/Burst	Waveform Length(us)	1=Detection 0=No Detection
1	5256	8.2	355.0	17	6035.0	1
2	5257	6.1	487.0	16	7792.0	0
3	5258	7.1	344.0	16	5504.0	1
4	5259	9.8	288.0	18	5184.0	1
5	5270	8.9	230.0	18	4140.0	1
6	5271	7.9	432.0	17	7344.0	1
7	5272	8.2	207.0	17	3519.0	1
8	5273	7.5	443.0	17	7531.0	1
9	5274	8.1	439.0	17	7463.0	1
10	5275	6.2	223.0	16	3568.0	1
11	5286	8.9	208.0	18	3744.0	1
12	5287	9.6	463.0	18	8334.0	1
13	5288	8.2	441.0	17	7497.0	1
14	5289	7.2	323.0	16	5168.0	1
15	5290	9.5	297.0	18	5346.0	1
16	5291	8.0	412.0	17	7004.0	1
17	5292	10.0	324.0	18	5832.0	1
18	5303	7.4	271.0	17	4607.0	1
19	5304	7.9	349.0	17	5933.0	1
20	5305	7.3	409.0	16	6544.0	0
21	5306	8.7	373.0	18	6714.0	1
22	5317	7.2	254.0	16	4064.0	1
23	5318	9.9	274.0	18	4932.0	1
24	5319	7.9	278.0	17	4726.0	1
25	5320	7.5	317.0	17	5389.0	1
26	5321	6.1	260.0	16	4160.0	1
27	5322	8.8	211.0	18	3798.0	1
28	5323	9.7	272.0	18	4896.0	1
29	5324	7.4	264.0	17	4488.0	0
30	5325	9.2	284.0	18	5112.0	1
<b>Detection Percentage</b>						<b>90% (≥60%)</b>



Unless otherwise agreed in writing, this document is issued by the Company subject to its General Conditions of Service printed overleaf, available on request or accessible at <http://www.sgs.com/en/Terms-and-Conditions.aspx> and, for electronic format documents, subject to Terms and Conditions for Electronic Documents at <http://www.sgs.com/en/Terms-and-Conditions/Terms-e-Documents.aspx>. Attention is drawn to the limitation of liability, indemnification and jurisdiction issues defined therein. Any holder of this document is advised that information contained hereon reflects the Company's findings at the time of its intervention only and within the limits of Client's instructions, if any. The Company's sole responsibility is to its Client and this document does not exonerate parties to a transaction from exercising all their rights and obligations under the transaction documents. This document cannot be reproduced except in full, without prior written approval of the Company. Any unauthorized alteration, forgery or falsification of the content or appearance of this document is unlawful and offenders may be prosecuted to the fullest extent of the law. Unless otherwise stated the results shown in this test report refer only to the sample(s) tested and such sample(s) are retained for 30 days only.

Attention: To check the authenticity of testing /inspection report & certificate, please contact us at telephone: (86-755) 8307 1443, or email: [CN.Doccheck@sgs.com](mailto:CN.Doccheck@sgs.com)  
 No.10, Weiye Road, Innovation Park, Kunshan, Jiangsu, China 215300      t(86-512)57355888    f(86-512)57370818    www.sgs.com.cn  
 中国·江苏·昆山市留学院创业园伟业路10号 邮编 215300      t(86-512)57355888    f(86-512)57370818    sgs.china@sgs.com



Type 4 Radar Statistical Performance

Trial Number	Freq (MHz)	Pulse Width (us)	PRI (us)	Pulses/Burst	Waveform Length(us)	1=Detection 0=No Detection
1	5256	16.0	355.0	14	4970.0	1
2	5257	11.3	487.0	12	5844.0	1
3	5258	13.5	344.0	13	4472.0	1
4	5259	19.4	288.0	16	4608.0	1
5	5270	17.5	230.0	15	3450.0	1
6	5271	15.3	432.0	14	6048.0	1
7	5272	15.9	207.0	14	2898.0	1
8	5273	14.3	443.0	13	5759.0	1
9	5274	15.8	439.0	14	6146.0	1
10	5275	11.5	223.0	12	2676.0	1
11	5286	17.4	208.0	15	3120.0	1
12	5287	19.0	463.0	16	7408.0	1
13	5288	16.0	441.0	14	6174.0	1
14	5289	13.8	323.0	13	4199.0	1
15	5290	18.9	297.0	16	4752.0	1
16	5291	15.5	412.0	14	5768.0	1
17	5292	19.9	324.0	16	5184.0	1
18	5303	14.1	271.0	13	3523.0	1
19	5304	15.2	349.0	14	4886.0	1
20	5305	13.8	409.0	13	5317.0	1
21	5306	17.1	373.0	15	5595.0	1
22	5317	13.8	254.0	13	3302.0	1
23	5318	19.8	274.0	16	4384.0	1
24	5319	15.3	278.0	14	3892.0	1
25	5320	14.5	317.0	13	4121.0	1
26	5321	11.3	260.0	12	3120.0	1
27	5322	17.3	211.0	15	3165.0	1
28	5323	19.2	272.0	16	4352.0	1
29	5324	14.2	264.0	13	3432.0	1
30	5325	18.2	284.0	15	4260.0	1
Detection Percentage						100% (≥60%)
<p>In addition an average minimum percentage of successful detection across all four Short pulse radar test waveforms is as follows: <math>\frac{P_d1+P_d2+P_d3+P_d4}{4} = (80\%+90\%+90\%+90\%)/4 (\geq 80\%)</math></p>						



Unless otherwise agreed in writing, this document is issued by the Company subject to its General Conditions of Service printed overleaf, available on request or accessible at <http://www.sgs.com/en/Terms-and-Conditions.aspx> and, for electronic format documents, subject to Terms and Conditions for Electronic Documents at <http://www.sgs.com/en/Terms-and-Conditions/Terms-e-Document.aspx>. Attention is drawn to the limitation of liability, indemnification and jurisdiction issues defined therein. Any holder of this document is advised that information contained hereon reflects the Company's findings at the time of its intervention only and within the limits of Client's instructions, if any. The Company's sole responsibility is to its Client and this document does not exonerate parties to a transaction from exercising all their rights and obligations under the transaction documents. This document cannot be reproduced except in full, without prior written approval of the Company. Any unauthorized alteration, forgery or falsification of the content or appearance of this document is unlawful and offenders may be prosecuted to the fullest extent of the law. Unless otherwise stated the results shown in this test report refer only to the sample(s) tested and such sample(s) are retained for 30 days only.

No.10, Weiye Road, Innovation Park, Kunshan, Jiangsu, China 215300  
 中国·江苏·昆山市留学院创业园伟业路10号 邮编 215300

Attention: To check the authenticity of testing /inspection report & certificate, please contact us at telephone: (86-755) 8307 1443, or email: [CN.Doccheck@sgs.com](mailto:CN.Doccheck@sgs.com)  
 t(86-512)57355888 f(86-512)57370818 www.sgs.com.cn  
 t(86-512)57355888 f(86-512)57370818 sgs.china@sgs.com

**Type 5 Radar Statistical Performance**

Trial Number	Center Frequency (GHz)	Number of Bursts	Chirp Width (MHz)	Burst Period(s)	Waveform Length(s)	1=Detection 0=No Detection
0	5.290000000	15	13	0.8000000	12.0000000	1
1	5.290000000	8	5	1.5000000	12.0000000	1
2	5.290000000	11	9	1.0909091	12.0000000	1
3	5.290000000	20	19	0.6000000	12.0000000	0
4	5.290000000	17	16	0.7058824	12.0000000	1
5	5.290000000	14	12	0.8571429	12.0000000	1
6	5.290000000	15	13	0.8000000	12.0000000	1
7	5.290000000	12	10	1.0000000	12.0000000	1
8	5.290000000	14	13	0.8571429	12.0000000	1
9	5.290000000	8	6	1.5000000	12.0000000	1
10	5.296400000	17	16	0.7058824	12.0000000	1
11	5.297600000	19	19	0.6315789	12.0000000	1
12	5.295200000	15	13	0.8000000	12.0000000	0
13	5.294000000	12	10	1.0000000	12.0000000	1
14	5.297200000	19	18	0.6315789	12.0000000	1
15	5.294800000	14	12	0.8571429	12.0000000	1
16	5.298000000	20	20	0.6000000	12.0000000	0
17	5.294000000	12	10	1.0000000	12.0000000	1
18	5.294800000	14	12	0.8571429	12.0000000	1
19	5.294000000	12	10	1.0000000	12.0000000	1
20	5.314000000	16	15	0.7500000	12.0000000	1
21	5.316400000	12	9	1.0000000	12.0000000	1
22	5.312000000	20	20	0.6000000	12.0000000	1
23	5.315200000	14	12	0.8571429	12.0000000	1
24	5.315600000	13	11	0.9230769	12.0000000	1
25	5.318000000	8	5	1.5000000	12.0000000	1
26	5.323600000	17	16	0.7058824	12.0000000	1
27	5.322400000	19	19	0.6315789	12.0000000	1
28	5.326000000	12	10	1.0000000	12.0000000	1
29	5.323200000	18	17	0.6666667	12.0000000	1
<b>Detection Percentage</b>						<b>90% (≥80%)</b>



Unless otherwise agreed in writing, this document is issued by the Company subject to its General Conditions of Service printed overleaf, available on request or accessible at <http://www.sgs.com/en/Terms-and-Conditions.aspx> and, for electronic format documents, subject to Terms and Conditions for Electronic Documents at <http://www.sgs.com/en/Terms-and-Conditions/Terms-e-Documents.aspx>. Attention is drawn to the limitation of liability, indemnification and jurisdiction issues defined therein. Any holder of this document is advised that information contained hereon reflects the Company's findings at the time of its intervention only and within the limits of Client's instructions, if any. The Company's sole responsibility is to its Client and this document does not exonerate parties to a transaction from exercising all their rights and obligations under the transaction documents. This document cannot be reproduced except in full, without prior written approval of the Company. Any unauthorized alteration, forgery or falsification of the content or appearance of this document is unlawful and offenders may be prosecuted to the fullest extent of the law. Unless otherwise stated the results shown in this test report refer only to the sample(s) tested and such sample(s) are retained for 30 days only.

Attention: To check the authenticity of testing/inspection report & certificate, please contact us at telephone: (86-755) 8307 1443, or email: [CN.Doccheck@sgs.com](mailto:CN.Doccheck@sgs.com)  
 No.10, Weiye Road, Innovation Park, Kunshan, Jiangsu, China 215300      t(86-512)57355888      f(86-512)57370818      www.sgs.com.cn  
 中国·江苏·昆山市留学院创业园伟业路10号 邮编 215300      t(86-512)57355888      f(86-512)57370818      sgs.china@sgs.com

**Type 6 Radar Statistical Performance**

Trial Number	Pulse Width (us)	PRI (us)	Pulse per Hop	Hopping Rate (kHz)	Hopping Sequence Length (ms)	Visible Frequency Number	1=Detection 0=No Detection
0	1.0	333.3	9	0.3333	300.0000000	4	1
1	1.0	333.3	9	0.3333	300.0000000	1	1
2	1.0	333.3	9	0.3333	300.0000000	3	1
3	1.0	333.3	9	0.3333	300.0000000	5	0
4	1.0	333.3	9	0.3333	300.0000000	4	1
5	1.0	333.3	9	0.3333	300.0000000	3	1
6	1.0	333.3	9	0.3333	300.0000000	5	1
7	1.0	333.3	9	0.3333	300.0000000	5	1
8	1.0	333.3	9	0.3333	300.0000000	6	1
9	1.0	333.3	9	0.3333	300.0000000	1	1
10	1.0	333.3	9	0.3333	300.0000000	5	1
11	1.0	333.3	9	0.3333	300.0000000	6	1
12	1.0	333.3	9	0.3333	300.0000000	4	1
13	1.0	333.3	9	0.3333	300.0000000	6	1
14	1.0	333.3	9	0.3333	300.0000000	5	1
15	1.0	333.3	9	0.3333	300.0000000	5	1
16	1.0	333.3	9	0.3333	300.0000000	5	1
17	1.0	333.3	9	0.3333	300.0000000	3	1
18	1.0	333.3	9	0.3333	300.0000000	3	1
19	1.0	333.3	9	0.3333	300.0000000	3	1
20	1.0	333.3	9	0.3333	300.0000000	5	1
21	1.0	333.3	9	0.3333	300.0000000	6	1
22	1.0	333.3	9	0.3333	300.0000000	5	1
23	1.0	333.3	9	0.3333	300.0000000	4	0
24	1.0	333.3	9	0.3333	300.0000000	3	1
25	1.0	333.3	9	0.3333	300.0000000	5	1
26	1.0	333.3	9	0.3333	300.0000000	3	1
27	1.0	333.3	9	0.3333	300.0000000	5	1
28	1.0	333.3	9	0.3333	300.0000000	6	1
29	1.0	333.3	9	0.3333	300.0000000	6	0
<b>Detection Percentage</b>							<b>90% (≥70%)</b>



Unless otherwise agreed in writing, this document is issued by the Company subject to its General Conditions of Service printed overleaf, available on request or accessible at <http://www.sgs.com/en/Terms-and-Conditions.aspx> and, for electronic format documents, subject to Terms and Conditions for Electronic Documents at <http://www.sgs.com/en/Terms-and-Conditions/Terms-e-Documents.aspx>. Attention is drawn to the limitation of liability, indemnification and jurisdiction issues defined therein. Any holder of this document is advised that information contained herein reflects the Company's findings at the time of its intervention only and within the limits of Client's instructions, if any. The Company's sole responsibility is to its Client and this document does not exonerate parties to a transaction from exercising all their rights and obligations under the transaction documents. This document cannot be reproduced except in full, without prior written approval of the Company. Any unauthorized alteration, forgery or falsification of the content or appearance of this document is unlawful and offenders may be prosecuted to the fullest extent of the law. Unless otherwise stated the results shown in this test report refer only to the sample(s) tested and such sample(s) are retained for 30 days only.

Attention: To check the authenticity of testing / inspection report & certificate, please contact us at telephone: (86-755) 8307 1443, or email: [CN.Doccheck@sgs.com](mailto:CN.Doccheck@sgs.com)  
 No.10, Weiye Road, Innovation Park, Kunshan, Jiangsu, China 215300  
 中国·江苏·昆山市留学院创业园伟业路10号 邮编 215300

t(86-512)57355888 f(86-512)57370818 www.sgs.com.cn  
 t(86-512)57355888 f(86-512)57370818 sgs.china@sgs.com

11ac(VHT80) CH106 5530MHz  
Type 1 Radar Statistical Performance

Trial Number	Freq (MHz)	Pulse Width (us)	PRI (us)	Pulses/Burst	Waveform Length(us)	1=Detection 0=No Detection
1	5506	1.0	938.0	57	53466.0	1
2	5507	1.0	698.0	76	53048.0	1
3	5508	1.0	618.0	86	53148.0	1
4	5509	1.0	538.0	99	53262.0	1
5	5510	1.0	878.0	61	53558.0	1
6	5511	1.0	3066.0	18	55188.0	1
7	5512	1.0	638.0	83	52954.0	1
8	5513	1.0	918.0	58	53244.0	1
9	5514	1.0	838.0	63	52794.0	1
10	5515	1.0	858.0	62	53196.0	1
11	5516	1.0	798.0	67	53466.0	1
12	5517	1.0	718.0	74	53132.0	1
13	5518	1.0	578.0	92	53176.0	1
14	5519	1.0	598.0	89	53222.0	1
15	5520	1.0	558.0	95	53010.0	1
16	5521	1.0	2536.0	21	53256.0	1
17	5522	1.0	966.0	55	53130.0	1
18	5523	1.0	827.0	64	52928.0	1
19	5524	1.0	2501.0	22	55022.0	1
20	5535	1.0	2595.0	21	54495.0	1
21	5536	1.0	1114.0	48	53472.0	1
22	5537	1.0	1302.0	41	53382.0	1
23	5538	1.0	3045.0	18	54810.0	1
24	5539	1.0	1624.0	33	53592.0	1
25	5540	1.0	2878.0	19	54682.0	1
26	5541	1.0	1027.0	52	53404.0	1
27	5542	1.0	2485.0	22	54670.0	1
28	5543	1.0	1600.0	33	52800.0	1
29	5544	1.0	1172.0	46	53912.0	1
30	5545	1.0	1177.0	45	52965.0	1
Detection Percentage						100% (≥60%)



Unless otherwise agreed in writing, this document is issued by the Company subject to its General Conditions of Service printed overleaf, available on request or accessible at <http://www.sgs.com/en/Terms-and-Conditions.aspx> and, for electronic format documents, subject to Terms and Conditions for Electronic Documents at <http://www.sgs.com/en/Terms-and-Conditions/Terms-e-Documents.aspx>. Attention is drawn to the limitation of liability, indemnification and jurisdiction issues defined therein. Any holder of this document is advised that information contained herein reflects the Company's findings at the time of its intervention only and within the limits of Client's instructions, if any. The Company's sole responsibility is to its Client and this document does not exonerate parties to a transaction from exercising all their rights and obligations under the transaction documents. This document cannot be reproduced except in full, without prior written approval of the Company. Any unauthorized alteration, forgery or falsification of the content or appearance of this document is unlawful and offenders may be prosecuted to the fullest extent of the law. Unless otherwise stated the results shown in this test report refer only to the sample(s) tested and such sample(s) are retained for 30 days only.

Attention: To check the authenticity of testing /inspection report & certificate, please contact us at telephone: (86-755) 8307 1443, or email: [CN.Doccheck@sgs.com](mailto:CN.Doccheck@sgs.com)  
 No.10, Weiye Road, Innovation Park, Kunshan, Jiangsu, China 215300      t(86-512)57355888    f(86-512)57370818    www.sgs.com.cn  
 中国·江苏·昆山市留学生创业园伟业路10号 邮编 215300      t(86-512)57355888    f(86-512)57370818    sgs.china@sgs.com

**Type 2 Radar Statistical Performance**

Trial Number	Freq (MHz)	Pulse Width (us)	PRI (us)	Pulses/Burst	Waveform Length(us)	1=Detection 0=No Detection
1	5506	3.2	179.0	26	4654.0	1
2	5507	1.1	207.0	23	4761.0	1
3	5508	2.1	230.0	24	5520.0	1
4	5509	4.8	200.0	29	5800.0	1
5	5510	3.9	214.0	28	5992.0	1
6	5511	2.9	222.0	26	5772.0	1
7	5512	3.2	204.0	26	5304.0	1
8	5513	2.5	192.0	25	4800.0	1
9	5514	3.1	164.0	26	4264.0	1
10	5515	1.2	156.0	23	3588.0	1
11	5516	3.9	210.0	27	5670.0	1
12	5517	4.6	201.0	29	5829.0	1
13	5518	3.2	162.0	26	4212.0	1
14	5519	2.2	197.0	25	4925.0	1
15	5520	4.5	163.0	29	4727.0	1
16	5521	3.0	203.0	26	5278.0	1
17	5522	5.0	168.0	29	4872.0	1
18	5523	2.4	217.0	25	5425.0	1
19	5524	2.9	191.0	26	4966.0	1
20	5535	2.3	166.0	25	4150.0	1
21	5536	3.7	150.0	27	4050.0	1
22	5537	2.2	176.0	25	4400.0	1
23	5538	4.9	195.0	29	5655.0	1
24	5539	2.9	202.0	26	5252.0	1
25	5540	2.5	178.0	25	4450.0	1
26	5541	1.1	206.0	23	4738.0	1
27	5542	3.8	155.0	27	4185.0	1
28	5543	4.7	157.0	29	4553.0	1
29	5544	2.4	224.0	25	5600.0	1
30	5545	4.2	159.0	28	4452.0	1
<b>Detection Percentage</b>						<b>100% (≥60%)</b>



Unless otherwise agreed in writing, this document is issued by the Company subject to its General Conditions of Service printed overleaf, available on request or accessible at <http://www.sgs.com/en/Terms-and-Conditions.aspx> and, for electronic format documents, subject to Terms and Conditions for Electronic Documents at <http://www.sgs.com/en/Terms-and-Conditions/Terms-e-Documents.aspx>. Attention is drawn to the limitation of liability, indemnification and jurisdiction issues defined therein. Any holder of this document is advised that information contained hereon reflects the Company's findings at the time of its intervention only and within the limits of Client's instructions, if any. The Company's sole responsibility is to its Client and this document does not exonerate parties to a transaction from exercising all their rights and obligations under the transaction documents. This document cannot be reproduced except in full, without prior written approval of the Company. Any unauthorized alteration, forgery or falsification of the content or appearance of this document is unlawful and offenders may be prosecuted to the fullest extent of the law. Unless otherwise stated the results shown in this test report refer only to the sample(s) tested and such sample(s) are retained for 30 days only.

Attention: To check the authenticity of testing /inspection report & certificate, please contact us at telephone: (86-755) 8307 1443, or email: [CN.Doccheck@sgs.com](mailto:CN.Doccheck@sgs.com)  
 No.10, Weiye Road, Innovation Park, Kunshan, Jiangsu, China 215300      t(86-512)57355888    f(86-512)57370818    www.sgs.com.cn  
 中国·江苏·昆山市留学生创业园伟业路10号 邮编 215300      t(86-512)57355888    f(86-512)57370818    sgs.china@sgs.com



**Type 3 Radar Statistical Performance**

Trial Number	Freq (MHz)	Pulse Width (us)	PRI (us)	Pulses/Burst	Waveform Length(us)	1=Detection 0=No Detection
1	5506	8.2	355.0	17	6035.0	1
2	5507	6.1	487.0	16	7792.0	1
3	5508	7.1	344.0	16	5504.0	1
4	5509	9.8	288.0	18	5184.0	1
5	5510	8.9	230.0	18	4140.0	1
6	5511	7.9	432.0	17	7344.0	1
7	5512	8.2	207.0	17	3519.0	1
8	5513	7.5	443.0	17	7531.0	1
9	5514	8.1	439.0	17	7463.0	1
10	5515	6.2	223.0	16	3568.0	1
11	5516	8.9	208.0	18	3744.0	1
12	5517	9.6	463.0	18	8334.0	1
13	5518	8.2	441.0	17	7497.0	1
14	5519	7.2	323.0	16	5168.0	1
15	5520	9.5	297.0	18	5346.0	1
16	5521	8.0	412.0	17	7004.0	1
17	5522	10.0	324.0	18	5832.0	1
18	5523	7.4	271.0	17	4607.0	1
19	5524	7.9	349.0	17	5933.0	1
20	5535	7.3	409.0	16	6544.0	1
21	5536	8.7	373.0	18	6714.0	1
22	5537	7.2	254.0	16	4064.0	1
23	5538	9.9	274.0	18	4932.0	1
24	5539	7.9	278.0	17	4726.0	1
25	5540	7.5	317.0	17	5389.0	1
26	5541	6.1	260.0	16	4160.0	1
27	5542	8.8	211.0	18	3798.0	1
28	5543	9.7	272.0	18	4896.0	1
29	5544	7.4	264.0	17	4488.0	1
30	5545	9.2	284.0	18	5112.0	1
<b>Detection Percentage</b>						<b>100% (≥60%)</b>



Unless otherwise agreed in writing, this document is issued by the Company subject to its General Conditions of Service printed overleaf, available on request or accessible at <http://www.sgs.com/en/Terms-and-Conditions.aspx> and, for electronic format documents, subject to Terms and Conditions for Electronic Documents at <http://www.sgs.com/en/Terms-and-Conditions/Terms-e-Document.aspx>. Attention is drawn to the limitation of liability, indemnification and jurisdiction issues defined therein. Any holder of this document is advised that information contained hereon reflects the Company's findings at the time of its intervention only and within the limits of Client's instructions, if any. The Company's sole responsibility is to its Client and this document does not exonerate parties to a transaction from exercising all their rights and obligations under the transaction documents. This document cannot be reproduced except in full, without prior written approval of the Company. Any unauthorized alteration, forgery or falsification of the content or appearance of this document is unlawful and offenders may be prosecuted to the fullest extent of the law. Unless otherwise stated the results shown in this test report refer only to the sample(s) tested and such sample(s) are retained for 30 days only.

Attention: To check the authenticity of testing /inspection report & certificate, please contact us at telephone: (86-755) 8307 1443, or email: [CN.Doccheck@sgs.com](mailto:CN.Doccheck@sgs.com)  
 No.10, Weiye Road, Innovation Park, Kunshan, Jiangsu, China 215300      t(86-512)57355888      f(86-512)57370818      www.sgs.com.cn  
 中国·江苏·昆山市留学生创业园伟业路10号 邮编 215300      t(86-512)57355888      f(86-512)57370818      sgs.china@sgs.com

**Type 4 Radar Statistical Performance**

Trial Number	Freq (MHz)	Pulse Width (us)	PRI (us)	Pulses/Burst	Waveform Length(us)	1=Detection 0=No Detection
1	5506	16.0	355.0	14	4970.0	1
2	5507	11.3	487.0	12	5844.0	1
3	5508	13.5	344.0	13	4472.0	1
4	5509	19.4	288.0	16	4608.0	1
5	5510	17.5	230.0	15	3450.0	1
6	5511	15.3	432.0	14	6048.0	1
7	5512	15.9	207.0	14	2898.0	1
8	5513	14.3	443.0	13	5759.0	1
9	5514	15.8	439.0	14	6146.0	1
10	5515	11.5	223.0	12	2676.0	1
11	5516	17.4	208.0	15	3120.0	1
12	5517	19.0	463.0	16	7408.0	1
13	5518	16.0	441.0	14	6174.0	1
14	5519	13.8	323.0	13	4199.0	1
15	5520	18.9	297.0	16	4752.0	1
16	5521	15.5	412.0	14	5768.0	1
17	5522	19.9	324.0	16	5184.0	1
18	5523	14.1	271.0	13	3523.0	1
19	5524	15.2	349.0	14	4886.0	1
20	5535	13.8	409.0	13	5317.0	1
21	5536	17.1	373.0	15	5595.0	1
22	5537	13.8	254.0	13	3302.0	1
23	5538	19.8	274.0	16	4384.0	1
24	5539	15.3	278.0	14	3892.0	1
25	5540	14.5	317.0	13	4121.0	1
26	5541	11.3	260.0	12	3120.0	1
27	5542	17.3	211.0	15	3165.0	1
28	5543	19.2	272.0	16	4352.0	1
29	5544	14.2	264.0	13	3432.0	1
30	5545	18.2	284.0	15	4260.0	1

Detection Percentage 100% (≥60%)

In addition an average minimum percentage of successful detection across all four Short pulse radar test waveforms is as follows:  $\frac{P_d1+P_d2+P_d3+P_d4}{4} = (80\%+90\%+90\%+90\%)/4 (\geq 80\%)$



Unless otherwise agreed in writing, this document is issued by the Company subject to its General Conditions of Service printed overleaf, available on request or accessible at <http://www.sgs.com/en/Terms-and-Conditions.aspx> and, for electronic format documents, subject to Terms and Conditions for Electronic Documents at <http://www.sgs.com/en/Terms-and-Conditions/Terms-e-Document.aspx>. Attention is drawn to the limitation of liability, indemnification and jurisdiction issues defined therein. Any holder of this document is advised that information contained hereon reflects the Company's findings at the time of its intervention only and within the limits of Client's instructions, if any. The Company's sole responsibility is to its Client and this document does not exonerate parties to a transaction from exercising all their rights and obligations under the transaction documents. This document cannot be reproduced except in full, without prior written approval of the Company. Any unauthorized alteration, forgery or falsification of the content or appearance of this document is unlawful and offenders may be prosecuted to the fullest extent of the law. Unless otherwise stated the results shown in this test report refer only to the sample(s) tested and such sample(s) are retained for 30 days only.

Attention: To check the authenticity of testing /inspection report & certificate, please contact us at telephone: (86-755) 8307 1443, or email: [CN.Doccheck@sgs.com](mailto:CN.Doccheck@sgs.com)  
 No.10, Weiye Road, Innovation Park, Kunshan, Jiangsu, China 215300 t(86-512)57355888 f(86-512)57370818 www.sgs.com.cn  
 中国·江苏·昆山市留学院创业园伟业路10号 邮编 215300 t(86-512)57355888 f(86-512)57370818 sgs.china@sgs.com

**Type 5 Radar Statistical Performance**

Trial Number	Center Frequency (GHz)	Number of Bursts	Chirp Width (MHz)	Burst Period(s)	Waveform Length(s)	1=Detection 0=No Detection
0	5.530000000	15	13	0.8000000	12.0000000	1
1	5.530000000	8	5	1.5000000	12.0000000	0
2	5.530000000	11	9	1.0909091	12.0000000	1
3	5.530000000	20	19	0.6000000	12.0000000	1
4	5.530000000	17	16	0.7058824	12.0000000	1
5	5.530000000	14	12	0.8571429	12.0000000	1
6	5.530000000	15	13	0.8000000	12.0000000	1
7	5.530000000	12	10	1.0000000	12.0000000	0
8	5.530000000	14	13	0.8571429	12.0000000	1
9	5.530000000	8	6	1.5000000	12.0000000	1
10	5.516400000	17	16	0.7058824	12.0000000	1
11	5.517600000	19	19	0.6315789	12.0000000	1
12	5.515200000	15	13	0.8000000	12.0000000	1
13	5.514000000	12	10	1.0000000	12.0000000	1
14	5.517200000	19	18	0.6315789	12.0000000	0
15	5.514800000	14	12	0.8571429	12.0000000	1
16	5.528000000	20	20	0.6000000	12.0000000	1
17	5.524000000	12	10	1.0000000	12.0000000	1
18	5.544800000	14	12	0.8571429	12.0000000	1
19	5.544000000	12	10	1.0000000	12.0000000	1
20	5.543000000	16	15	0.7500000	12.0000000	1
21	5.546400000	12	9	1.0000000	12.0000000	1
22	5.542000000	20	20	0.6000000	12.0000000	1
23	5.552000000	14	12	0.8571429	12.0000000	1
24	5.555600000	13	11	0.9230769	12.0000000	1
25	5.558000000	8	5	1.5000000	12.0000000	1
26	5.553600000	17	16	0.7058824	12.0000000	1
27	5.552400000	19	19	0.6315789	12.0000000	1
28	5.556000000	12	10	1.0000000	12.0000000	1
29	5.553200000	18	17	0.6666667	12.0000000	1
<b>Detection Percentage</b>						<b>90% (≥80%)</b>



Unless otherwise agreed in writing, this document is issued by the Company subject to its General Conditions of Service printed overleaf, available on request or accessible at <http://www.sgs.com/en/Terms-and-Conditions.aspx> and, for electronic format documents, subject to Terms and Conditions for Electronic Documents at <http://www.sgs.com/en/Terms-and-Conditions/Terms-e-Documents.aspx>. Attention is drawn to the limitation of liability, indemnification and jurisdiction issues defined therein. Any holder of this document is advised that information contained hereon reflects the Company's findings at the time of its intervention only and within the limits of Client's instructions, if any. The Company's sole responsibility is to its Client and this document does not exonerate parties to a transaction from exercising all their rights and obligations under the transaction documents. This document cannot be reproduced except in full, without prior written approval of the Company. Any unauthorized alteration, forgery or falsification of the content or appearance of this document is unlawful and offenders may be prosecuted to the fullest extent of the law. Unless otherwise stated the results shown in this test report refer only to the sample(s) tested and such sample(s) are retained for 30 days only.

Attention: To check the authenticity of testing /inspection report & certificate, please contact us at telephone: (86-755) 8307 1443, or email: [CN.Doccheck@sgs.com](mailto:CN.Doccheck@sgs.com)  
 No.10, Weiye Road, Innovation Park, Kunshan, Jiangsu, China 215300      t(86-512)57355888      f(86-512)57370818      www.sgs.com.cn  
 中国·江苏·昆山市留学生创业园伟业路10号 邮编 215300      t(86-512)57355888      f(86-512)57370818      sgs.china@sgs.com

**Type 6 Radar Statistical Performance**

Trial Number	Pulse Width (us)	PRI (us)	Pulse per Hop	Hopping Rate (kHz)	Hopping Sequence Length (ms)	Visible Frequency Number	1=Detection 0=No Detection
0	1.0	333.3	9	0.3333	300.0000000	4	1
1	1.0	333.3	9	0.3333	300.0000000	1	0
2	1.0	333.3	9	0.3333	300.0000000	3	0
3	1.0	333.3	9	0.3333	300.0000000	5	1
4	1.0	333.3	9	0.3333	300.0000000	4	1
5	1.0	333.3	9	0.3333	300.0000000	3	1
6	1.0	333.3	9	0.3333	300.0000000	5	1
7	1.0	333.3	9	0.3333	300.0000000	5	1
8	1.0	333.3	9	0.3333	300.0000000	6	1
9	1.0	333.3	9	0.3333	300.0000000	1	0
10	1.0	333.3	9	0.3333	300.0000000	5	1
11	1.0	333.3	9	0.3333	300.0000000	6	1
+12	1.0	333.3	9	0.3333	300.0000000	4	1
13	1.0	333.3	9	0.3333	300.0000000	6	1
14	1.0	333.3	9	0.3333	300.0000000	5	1
15	1.0	333.3	9	0.3333	300.0000000	5	0
16	1.0	333.3	9	0.3333	300.0000000	5	1
17	1.0	333.3	9	0.3333	300.0000000	3	1
18	1.0	333.3	9	0.3333	300.0000000	3	1
19	1.0	333.3	9	0.3333	300.0000000	3	1
20	1.0	333.3	9	0.3333	300.0000000	5	0
21	1.0	333.3	9	0.3333	300.0000000	6	1
22	1.0	333.3	9	0.3333	300.0000000	5	1
23	1.0	333.3	9	0.3333	300.0000000	4	1
24	1.0	333.3	9	0.3333	300.0000000	3	1
25	1.0	333.3	9	0.3333	300.0000000	5	1
26	1.0	333.3	9	0.3333	300.0000000	3	0
27	1.0	333.3	9	0.3333	300.0000000	5	1
28	1.0	333.3	9	0.3333	300.0000000	6	1
29	1.0	333.3	9	0.3333	300.0000000	6	1
Detection Percentage							80% (≥70%)



Unless otherwise agreed in writing, this document is issued by the Company subject to its General Conditions of Service printed overleaf, available on request or accessible at <http://www.sgs.com/en/Terms-and-Conditions.aspx> and, for electronic format documents, subject to Terms and Conditions for Electronic Documents at <http://www.sgs.com/en/Terms-and-Conditions/Terms-e-Documents.aspx>. Attention is drawn to the limitation of liability, indemnification and jurisdiction issues defined therein. Any holder of this document is advised that information contained herein reflects the Company's findings at the time of its intervention only and within the limits of Client's instructions, if any. The Company's sole responsibility is to its Client and this document does not exonerate parties to a transaction from exercising all their rights and obligations under the transaction documents. This document cannot be reproduced except in full, without prior written approval of the Company. Any unauthorized alteration, forgery or falsification of the content or appearance of this document is unlawful and offenders may be prosecuted to the fullest extent of the law. Unless otherwise stated the results shown in this test report refer only to the sample(s) tested and such sample(s) are retained for 30 days only.

Attention: To check the authenticity of testing / inspection report & certificate, please contact us at telephone: (86-755) 8307 1443, or email: [CN.Doccheck@sgs.com](mailto:CN.Doccheck@sgs.com)  
 No.10, Weiye Road, Innovation Park, Kunshan, Jiangsu, China 215300  
 中国·江苏·昆山市留学院创业园伟业路10号 邮编 215300

t(86-512)57355888 f(86-512)57370818 www.sgs.com.cn  
 t(86-512)57355888 f(86-512)57370818 sgs.china@sgs.com

## 7 Test Setup Photographs

Refer to the < Test Setup photos-FCC>.

## 8 EUT Constructional Details

Refer to the < External Photos > & < Internal Photos >.

- End of the Report -



Unless otherwise agreed in writing, this document is issued by the Company subject to its General Conditions of Service printed overleaf, available on request or accessible at <http://www.sgs.com/en/Terms-and-Conditions.aspx> and, for electronic format documents, subject to Terms and Conditions for Electronic Documents at <http://www.sgs.com/en/Terms-and-Conditions/Terms-e-Documents.aspx>. Attention is drawn to the limitation of liability, indemnification and jurisdiction issues defined therein. Any holder of this document is advised that information contained hereon reflects the Company's findings at the time of its intervention only and within the limits of Client's instructions, if any. The Company's sole responsibility is to its Client and this document does not exonerate parties to a transaction from exercising all their rights and obligations under the transaction documents. This document cannot be reproduced except in full, without prior written approval of the Company. Any unauthorized alteration, forgery or falsification of the content or appearance of this document is unlawful and offenders may be prosecuted to the fullest extent of the law. Unless otherwise stated the results shown in this test report refer only to the sample(s) tested and such sample(s) are retained for 30 days only.  
Attention: To check the authenticity of testing /inspection report & certificate, please contact us at telephone: (86-755) 8307 1443, or email: [CN.Doccheck@sgs.com](mailto:CN.Doccheck@sgs.com)

Compliance Certification Services (Kunshan) Inc.  
EMC Laboratory

No.10, Weiye Road, Innovation Park, Kunshan, Jiangsu, China 215300  
中国·江苏·昆山市留学生创业园伟业路10号 邮编 215300

t(86-512)57355888 f(86-512)57370818 [www.sgs.com](http://www.sgs.com).cn  
t(86-512)57355888 f(86-512)57370818 [sgs.china@sgs.com](mailto:sgs.china@sgs.com)