



FCC Part 15C Test Report

FCC ID: 2ADSOA803W

Product Name:	RC airplane
Trademark:	 
Model Name :	A803W, A803H
Prepared For :	Apex Toys (Shenzhen)Co., Ltd.
Address :	A.Floor 4,A001 Building,Zhi Ji Industrial Park, No.92 KuiChong Street,LongGang district, Shenzhen, China
Prepared By :	Shenzhen BCTC Technology Co., Ltd.
Address :	No.101,Yousong Road,Longhua New District, Shenzhen,China
Test Date:	Oct. 24- Nov. 3, 2015
Date of Report :	Nov. 4, 2015
Report No.:	BCTC-151012685



TEST RESULT CERTIFICATION

Applicant's name : Apex Toys (Shenzhen)Co., Ltd.
Address : A.Floor 4,A001 Building,Zhi Ji Industrial Park, No.92 KuiChong Street,LongGang district, Shenzhen, China
Manufacture's Name..... : Apex Toys (Shenzhen)Co., Ltd.
Address : A.Floor 4,A001 Building,Zhi Ji Industrial Park, No.92 KuiChong Street,LongGang district, Shenzhen, China

Product description

Product name : RC airplane
Model and/or type reference : A803W, A803H

Trademark: :  

Standards : FCC Part15.247

Test procedure ANSI C63.10-2013

This device described above has been tested by BCTC, and the test results show that the equipment under test (EUT) is in compliance with the FCC requirements. And it is applicable only to the tested sample identified in the report.

This report shall not be reproduced except in full, without the written approval of BCTC, this document may be altered or revised by BCTC, personal only, and shall be noted in the revision of the document.

Testing Engineer : Eric Yang
 (Eric Yang)

Technical Manager : Sophie Lee
 (Sophia Lee)

Authorized Signatory : Casey Wang 
 (Casey Wang)

**Table of Contents**

	Page
1 . SUMMARY OF TEST RESULTS	5
1.1 TEST FACILITY	6
1.2 MEASUREMENT UNCERTAINTY	6
2 . GENERAL INFORMATION	7
2.1 GENERAL DESCRIPTION OF EUT	7
2.2 DESCRIPTION OF TEST MODES	8
2.3 BLOCK DIGRAM SHOWING THE CONFIGURATION OF SYSTEM TESTED	9
2.4 DESCRIPTION OF SUPPORT UNITS(CONDUCTED MODE)	9
2.5 EQUIPMENTS LIST FOR ALL TEST ITEMS	10
3 . EMC EMISSION TEST	11
3.1 CONDUCTED EMISSION MEASUREMENT	11
3.1.1 POWER LINE CONDUCTED EMISSION LIMITS	11
3.1.2 TEST PROCEDURE	12
3.1.3 DEVIATION FROM TEST STANDARD	12
3.1.4 TEST SETUP	12
3.1.5 EUT OPERATING CONDITIONS	12
3.1.6 TEST RESULTS	13
3.2 RADIATED EMISSION MEASUREMENT	14
3.2.1 RADIATED EMISSION LIMITS	14
3.2.2 TEST PROCEDURE	15
3.2.3 DEVIATION FROM TEST STANDARD	15
3.2.4 TEST SETUP	16
3.2.5 EUT OPERATING CONDITIONS	17
3.2.6 TEST RESULTS (BETWEEN 9KHZ – 30 MHZ)	18
3.2.7 TEST RESULTS (BETWEEN 30MHZ – 1GHZ)	19
3.2.8 TEST RESULTS (ABOVE 1000 MHZ)	21
4 . POWER SPECTRAL DENSITY TEST	25
4.1 APPLIED PROCEDURES / LIMIT	25
4.1.1 TEST PROCEDURE	25
4.1.2 DEVIATION FROM STANDARD	25
4.1.3 TEST SETUP	25
4.1.4 EUT OPERATION CONDITIONS	25
4.1.5 TEST RESULTS	26



Table of Contents		Page
5 . BANDWIDTH TEST		32
5.1 APPLIED PROCEDURES / LIMIT		32
5.1.1 TEST PROCEDURE		32
5.1.2 DEVIATION FROM STANDARD		32
5.1.3 TEST SETUP		32
5.1.4 EUT OPERATION CONDITIONS		32
5.1.5 TEST RESULTS		33
6 . PEAK OUTPUT POWER TEST		39
6.1 APPLIED PROCEDURES / LIMIT		39
6.1.1 TEST PROCEDURE		39
6.1.2 DEVIATION FROM STANDARD		39
6.1.3 TEST SETUP		39
6.1.4 EUT OPERATION CONDITIONS		39
6.1.5 TEST RESULTS		40
7 . 100 KHZ BANDWIDTH OF FREQUENCY BAND EDGE		41
7.1 DEVIATION FROM STANDARD		41
7.2 TEST SETUP		42
7.3 EUT OPERATION CONDITIONS		42
7.4 TEST RESULTS		42
8 . ANTENNA REQUIREMENT		48
8.1 STANDARD REQUIREMENT		48
8.2 EUT ANTENNA		48
9 . EUT TEST PHOTO		49
10 . EUT PHOTO		50
APPENDIX-PHOTOGRAPHS OF EUT CONSTRUCTIONAL DETAILS		



1. SUMMARY OF TEST RESULTS

Test procedures according to the technical standards:

FCC Part15 (15.247) , Subpart C			
Standard Section	Test Item	Judgment	Remark
15.207	Conducted Emission	N/A	
15.247 (a)(2)	6dB Bandwidth	PASS	
15.247 (b)	Peak Output Power	PASS	
15.247 (c)	Radiated Spurious Emission	PASS	
15.247 (d)	Power Spectral Density	PASS	
15.205	Band Edge Emission	PASS	
15.203	Antenna Requirement	PASS	

NOTE:

(1) "N/A" denotes test is not applicable in this Test Report



1.1 TEST FACILITY

Shenzhen BCTC Technology Co., Ltd.

Add. : No.101, Yousong Road, Longhua New District, Shenzhen, China

FCC Registered No.: 187086

1.2 MEASUREMENT UNCERTAINTY

The reported uncertainty of measurement $y \pm U$, where expanded uncertainty U is based on a standard uncertainty multiplied by a coverage factor of $k=2$, providing a level of confidence of approximately **95 %**.

No.	Item	Uncertainty
1	Conducted Emission Test	$\pm 1.38\text{dB}$
2	RF power, conducted	$\pm 0.16\text{dB}$
3	Spurious emissions, conducted	$\pm 0.21\text{dB}$
4	All emissions, radiated (<1G)	$\pm 4.68\text{dB}$
5	All emissions, radiated (>1G)	$\pm 4.89\text{dB}$
6	Temperature	$\pm 0.5^\circ\text{C}$
7	Humidity	$\pm 2\%$



2. GENERAL INFORMATION

2.1 GENERAL DESCRIPTION OF EUT

Equipment	RC airplane	
Trade Name		
Model Name	A803W, A803H	
Model Difference	The product different for model number, trade name and outlook color.	
Product Description	The EUT is a RC airplane	
	Operation Frequency:	802.11b/g/n20MHz:2412~2462 MHz
	Modulation Type:	DSSS/OFDM
	Bit Rate of Transmitter	802.11b:11/5.5/2/1 Mbps 802.11g:54/48/36/24/18/12/9/6Mbps 802.11n Up to 150Mbps
	Number Of Channel	802.11b/g/n20MHz:11 CH
	Antenna Designation:	Please see Note 3.
	Antenna Gain (dBi)	1.5
	Based on the application, features, or specification exhibited in User's Manual, the EUT is considered as an ITE/Computing Device. More details of EUT technical specification, please refer to the User's Manual.	
Channel List	Please refer to the Note 2.	
Power Supply	DC 3.7V	
Adapter	N/A	
Connecting I/O Port(s)	Please refer to the User's Manual	

Note:

1. For a more detailed features description, please refer to the manufacturer's specifications or the User's Manual.
- 2.

Channel List for 802.11b/g/n(20)							
Channel	Frequency (MHz)	Channel	Frequency (MHz)	Channel	Frequency (MHz)	Channel	Frequency (MHz)
01	2412	04	2427	07	2442	10	2457
02	2417	05	2432	08	2447	11	2462
03	2422	06	2437	09	2452		



3.

Table for Filed Antenna

Ant	Brand	Model Name	Antenna Type	Connector	Gain (dBi)	NOTE
A	N/A	N/A	External antenna	N/A	1.5	Wifi Antenna

2.2 DESCRIPTION OF TEST MODES

To investigate the maximum EMI emission characteristics generates from EUT, the test system was pre-scanning tested base on the consideration of following EUT operation mode or test configuration mode which possible have effect on EMI emission level. Each of these EUT operation mode(s) or test configuration mode(s) mentioned above was evaluated respectively.

Pretest Mode	Description
Mode 1	802.11b CH1/ CH6/ CH11
Mode 2	802.11g CH1/ CH6/ CH11
Mode 3	802.11n(20) CH1/ CH6/ CH11
Mode 5	Link Mode

For Conducted Emission	
Final Test Mode	Description
Mode 5	Link Mode

For Radiated Emission	
Final Test Mode	Description
Mode 1	802.11b CH1/ CH6/ CH11
Mode 2	802.11g CH1/ CH6/ CH11
Mode 3	802.11n CH1/ CH6/ CH11

Note:

- (1) The measurements are performed at the highest, middle, lowest available channels.
- (2) The measurements are performed at all Bit Rate of Transmitter, the worst data was reported



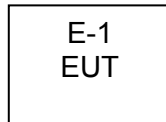

2.3 BLOCK DIGRAM SHOWING THE CONFIGURATION OF SYSTEM TESTED

Emission Test



2.4 DESCRIPTION OF SUPPORT UNITS(CONDUCTED MODE)

The EUT has been tested as an independent unit together with other necessary accessories or support units. The following support units or accessories were used to form a representative test configuration during the tests.

Item	Equipment	Mfr/Brand	Model/Type No.	Series No.	Note
E-1	RC airplane	 	A803W, A803H	N/A	EUT

Note:

- (1) The support equipment was authorized by Declaration of Confirmation.
- (2) For detachable type I/O cable should be specified the length in cm in 『Length』 column.



2.5 EQUIPMENTS LIST FOR ALL TEST ITEMS

Radiation Test equipment

Item	Kind of Equipment	Manufacturer	Type No.	Serial No.	Last calibration	Calibrated until	Calibration period
1	Spectrum Analyzer	Agilent	E4407B	MY4510957 2	2015.08.25	2016.08.24	1 year
2	Test Receiver	R&S	ESPI	101396	2015.08.25	2016.08.24	1 year
3	Bilog Antenna	SCHWARZBECK	VULB9160	VULB9160- 3369	2015.08.25	2016.08.24	1 year
4	50Ω Coaxial Switch	Anritsu	MP59B	620026441 6	2015.06.07	2016.06.06	1 year
5	Spectrum Analyzer	ADVANTEST	R3132	150900201	2015.06.07	2016.06.06	1 year
6	Horn Antenna	SCHWARZBECK	9120D	9120D-1275	2015.08.25	2016.08.24	1 year
7	Horn Ant	Schwarzbeck	BBHA 9170	9170-181	2015.06.07	2016.06.06	1 year
8	Amplifier	SCHWARZBECK	BBV9718	9718-270	2015.08.25	2016.08.24	1 year
9	Amplifier	SCHWARZBECK	BBV9743	9743-119	2015.08.25	2016.08.24	1 year
10	Loop Antenna	ARA	PLA-1030/B	1029	2015.06.08	2016.06.07	1 year
11	Power Meter	R&S	NRVS	100696	2015.06.07	2016.06.06	1 year
12	Power Sensor	R&S	URV5-Z4	0395.1619. 05	2015.06.07	2016.06.06	1 year
13	RF cables	R&S	N/A	N/A	2015.06.07	2016.06.06	1 year

Conduction Test equipment

Item	Kind of Equipment	Manufacturer	Type No.	Serial No.	Last calibration	Calibrated until	Calibration period
1	Test Receiver	R&S	ESCI	101421	2015.08.25	2016.08.24	1 year
2	LISN	SCHWARZBECK	NSLK8127	812779	2015.08.25	2016.08.24	1 year
3	LISN	EMCO	Feb-16	42990	2015.08.25	2016.08.24	1 year
4	50Ω Coaxial Switch	Anritsu	MP59B	620026441 7	2015.08.25	2016.08.24	1 year
5	Passive Voltage Probe	R&S	ESH2-Z3	100196	2015.08.25	2016.08.24	1 year



3. EMC EMISSION TEST

3.1 CONDUCTED EMISSION MEASUREMENT

3.1.1 POWER LINE CONDUCTED EMISSION Limits (Frequency Range 150KHz-30MHz)

FREQUENCY (MHz)	Class B (dBuV)		Standard
	Quasi-peak	Average	
0.15 -0.5	66 - 56 *	56 - 46 *	CISPR
0.50 -5.0	56.00	46.00	CISPR
5.0 -30.0	60.00	50.00	CISPR

0.15 -0.5	66 - 56 *	56 - 46 *	FCC
0.50 -5.0	56.00	46.00	FCC
5.0 -30.0	60.00	50.00	FCC

Note:

- (1) The tighter limit applies at the band edges.
- (2) The limit of " * " marked band means the limitation decreases linearly with the logarithm of the frequency in the range.

The following table is the setting of the receiver

Receiver Parameters	Setting
Attenuation	10 dB
Start Frequency	0.15 MHz
Stop Frequency	30 MHz
IF Bandwidth	9 kHz

3.1.2 TEST PROCEDURE

- a. The EUT was placed 0.8 meters from the horizontal ground plane with EUT being connected to the power mains through a line impedance stabilization network (LISN). All other support equipments powered from additional LISN(s). The LISN provide 50 Ohm/ 50uH of coupling impedance for the measuring instrument.
- b. Interconnecting cables that hang closer than 40 cm to the ground plane shall be folded back and forth in the center forming a bundle 30 to 40 cm long.
- c. I/O cables that are not connected to a peripheral shall be bundled in the center. The end of the cable may be terminated, if required, using the correct terminating impedance. The overall length shall not exceed 1 m.
- d. LISN at least 80 cm from nearest part of EUT chassis.
- e. For the actual test configuration, please refer to the related Item –EUT Test Photos.

3.1.3 DEVIATION FROM TEST STANDARD

No deviation

3.1.4 TEST SETUP

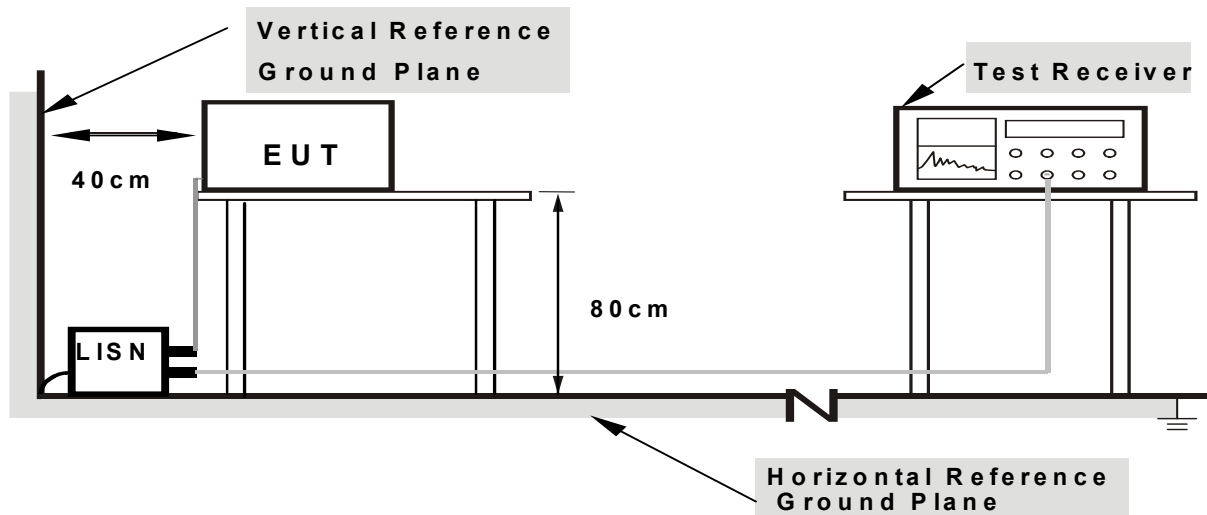

Note: 1. Support units were connected to second LISN.

2. Both of LISNs (AMN) are 80 cm from EUT and at least 80 cm from other units and other metal planes

3.1.5 EUT OPERATING CONDITIONS

The EUT was configured for testing in a typical fashion (as a customer would normally use it). The EUT has been programmed to continuously transmit during test. This operating condition was tested and used to collect the included data.

We pretest AC 120V and AC 240V, the worst voltage was AC 120V and the data recording in the report.



3.1.6 TEST RESULTS

The product's power provide by battery, is no requirment for this item.



3.2 RADIATED EMISSION MEASUREMENT

3.2.1 RADIATED EMISSION LIMITS (Frequency Range 9kHz-1000MHz)

20dBc in any 100 kHz bandwidth outside the operating frequency band. In case the emission fall within the restricted band specified on 15.205(a), then the 15.209(a) limit in the table below has to be followed.

Frequencies (MHz)	Field Strength (micorvolts/meter)	Measurement Distance (meters)
0.009~0.490	2400/F(KHz)	300
0.490~1.705	24000/F(KHz)	30
1.705~30.0	30	30
30~88	100	3
88~216	150	3
216~960	200	3
Above 960	500	3

LIMITS OF RADIATED EMISSION MEASUREMENT (Above 1000MHz)

FREQUENCY (MHz)	Class A (dBuV/m) (at 3M)		Class B (dBuV/m) (at 3M)	
	PEAK	AVERAGE	PEAK	AVERAGE
Above 1000	80	60	74	54

Notes:

- (1) The limit for radiated test was performed according to FCC PART 15C.
- (2) The tighter limit applies at the band edges.
- (3) Emission level (dBuV/m)=20log Emission level (uV/m).

Spectrum Parameter	Setting
Attenuation	Auto
Start Frequency	1000 MHz
Stop Frequency	10th carrier harmonic
RB / VB (emission in restricted band)	1 MHz / 1 MHz for Peak, 1 MHz / 10Hz for Average

Receiver Parameter	Setting
Attenuation	Auto
Start ~ Stop Frequency	9kHz~150kHz / RB 200Hz for QP
Start ~ Stop Frequency	150kHz~30MHz / RB 9kHz for QP
Start ~ Stop Frequency	30MHz~1000MHz / RB 120kHz for QP



3.2.2 TEST PROCEDURE

- a. The measuring distance of at 3 m shall be used for measurements at frequency up to 1GHz. For frequencies above 1GHz, any suitable measuring distance may be used.
- b. The EUT was placed on the top of a rotating table 0.8 meters above the ground at a 3 meter open area test site. The table was rotated 360 degrees to determine the position of the highest radiation.
- c. The height of the equipment or of the substitution antenna shall be 0.8 m; the height of the test antenna shall vary between 1 m to 4 m. Both horizontal and vertical polarizations of the antenna are set to make the measurement.
- d. The initial step in collecting conducted emission data is a spectrum analyzer peak detector mode pre-scanning the measurement frequency range. Significant peaks are then marked and then Quasi Peak detector mode re-measured.
- e. If the Peak Mode measured value compliance with and lower than Quasi Peak Mode Limit, the EUT shall be deemed to meet QP Limits and then no additional QP Mode measurement performed.
- f. For the actual test configuration, please refer to the related Item –EUT Test Photos.

Note:

Both horizontal and vertical antenna polarities were tested and performed pretest to three orthogonal axis. The worst case emissions were reported We pretest AC 120V and AC 240V, the worst voltage was AC 120V and the data recording in the report.

3.2.3 DEVIATION FROM TEST STANDARD

No deviation

3.2.4 TEST SETUP

(A) Radiated Emission Test-Up Frequency Below 30MHz

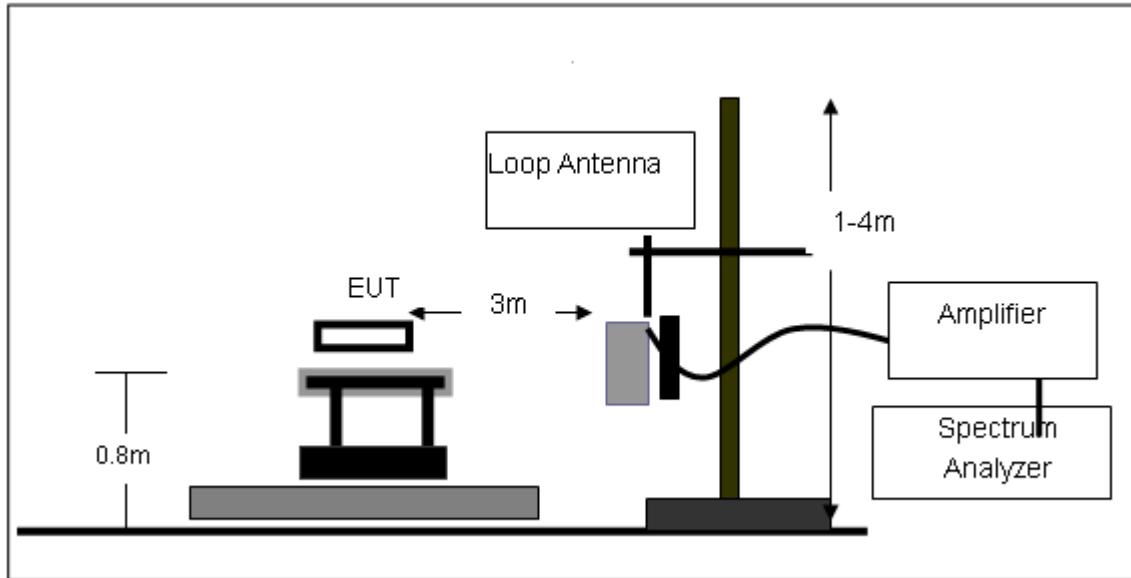

(B) Radiated Emission Test-Up Frequency 30MHz~1GHz

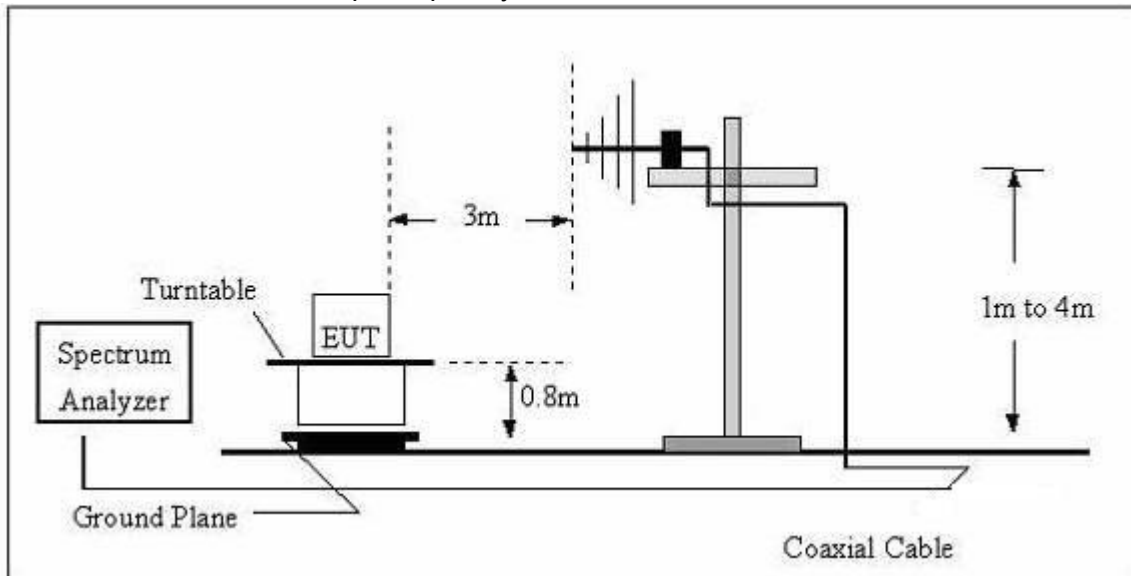

(C) Radiated Emission Test-Up Frequency Above 1GHz

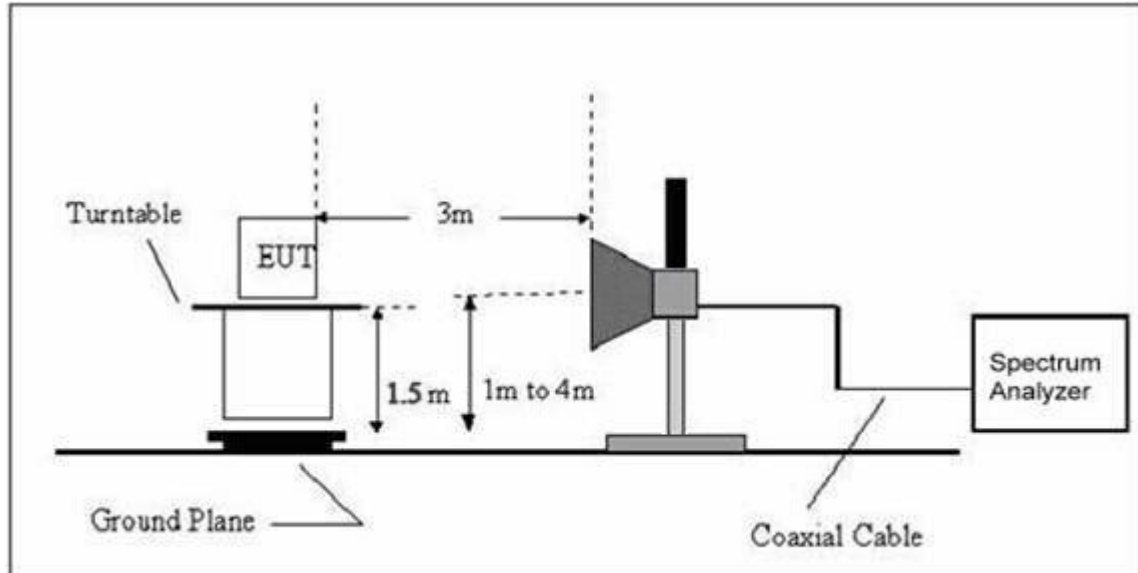

3.2.5 EUT OPERATING CONDITIONS

The EUT tested system was configured as the statements of 2.4 Unless otherwise a special operating condition is specified in the follows during the testing.

**3.2.6 TEST RESULTS (BETWEEN 9KHZ – 30 MHZ)**

EUT:	RC airplane	Model Name. :	A803W
Temperature:	20°C	Relative Humidity:	48%
Pressure:	1010 hPa	Test Voltage :	DC 3.7V
Test Mode :	TX	Polarization :	--

Freq.	Reading	Limit	Margin	State
(MHz)	(dBuV/m)	(dBuV/m)	(dB)	P/F
--	--	--	--	PASS
--	--	--	--	PASS

NOTE:

The amplitude of spurious emissions which are attenuated by more than 20dB below the permissible value has no need to be reported.

Distance extrapolation factor = $40 \log(\text{specific distance}/\text{test distance})$ (dB);

Limit line = specific limits(dBuv) + distance extrapolation factor.



3.2.7 TEST RESULTS (BETWEEN 30MHZ – 1GHZ)

EUT :	RC airplane	Model Name :	A803W
Temperature :	26°C	Relative Humidity :	54%
Pressure :	1010 hPa	Polarization :	Horizontal
Test Voltage :	DC3.7V		
Test Mode :	TX		

No.	Mk.	Freq.	Reading Level	Correct Factor	Measurement	Limit	Over	Antenna Height	Table Degree	
		MHz	dBuV	dB/m	dBuV/m	dBuV/m	dB	cm	degree	Comment
1	*	88.3421	51.01	-17.71	33.30	43.50	-10.20	QP		
2		129.4677	41.35	-14.14	27.21	43.50	-16.29	QP		
3		194.4534	46.33	-15.86	30.47	43.50	-13.03	QP		
4		259.2338	45.52	-13.94	31.58	46.00	-14.42	QP		
5		324.4561	47.20	-11.95	35.25	46.00	-10.75	QP		
6		454.3100	38.29	-8.95	29.34	46.00	-16.66	QP		

Remark:
 Factor = Antenna Factor + Cable Loss – Pre-amplifier.
 All interfaces was connected, and BT TX mode was link.

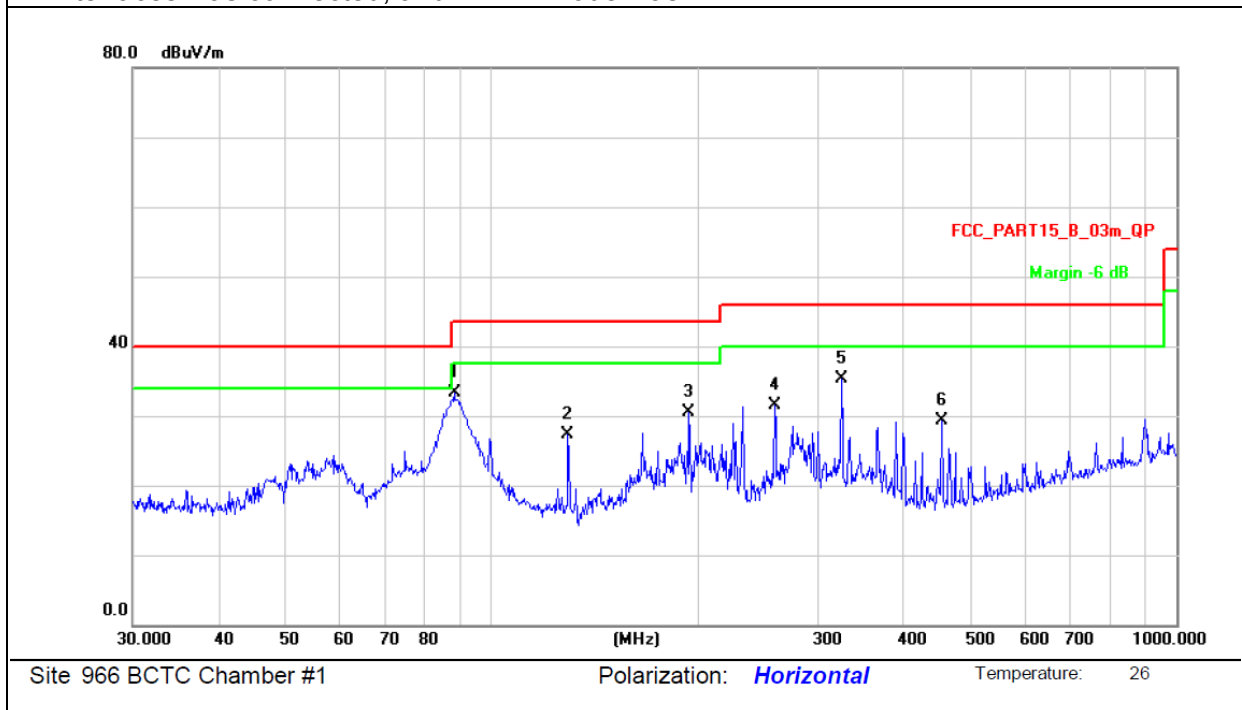

Site 966 BCTC Chamber #1

Polarization: *Horizontal*

Temperature: 26



EUT :	RC airplane	Model Name :	A803W
Temperature :	26°C	Relative Humidity :	54%
Pressure :	1010 hPa	Polarization :	Vertical
Test Voltage :	DC3.7V		
Test Mode :	TX		

No.	Mk.	Freq.	Reading Level	Correct Factor	Measurement	Limit	Over	Antenna Height	Table Degree	
		MHz	dBuV	dB/m	dBuV/m	dBuV/m	dB	cm	degree	Comment
1	*	53.8817	48.33	-10.93	37.40	40.00	-2.60	QP		
2		97.7982	50.99	-16.71	34.28	43.50	-9.22	QP		
3		133.6187	37.46	-13.85	23.61	43.50	-19.89	QP		
4		146.8876	50.44	-13.03	37.41	43.50	-6.09	QP		
5	!	272.2776	54.01	-13.42	40.59	46.00	-5.41	QP		
6	!	322.1886	52.45	-12.00	40.45	46.00	-5.55	QP		

Remark:

Factor = Antenna Factor + Cable Loss – Pre-amplifier.

All interfaces was connected, and BT TX mode was link.

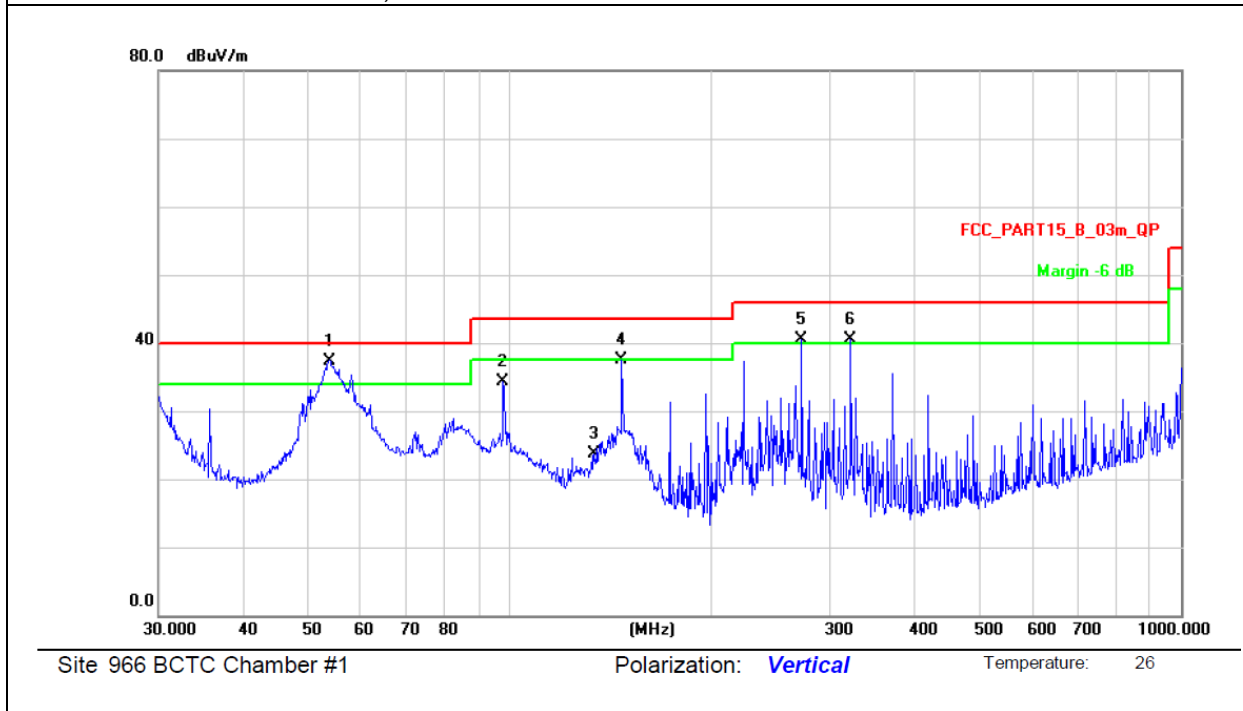

Site 966 BCTC Chamber #1

Polarization: Vertical

Temperature: 26



3.2.8 TEST RESULTS (ABOVE 1000 MHZ)

802.11b

Normal Voltage

Polar (H/V)	Frequency	Meter Reading	Factor	Emission Level	Limits	Margin	Detector Type
	(MHz)	(dBuV)	(dB)	(dBuV/m)	(dBuV/m)	(dB)	
operation frequency:2412							
V	4824.00	65.04	-3.64	61.40	74	-12.60	Pk
V	4824.00	46.77	-3.64	43.13	54	-10.87	AV
H	4824.00	64.54	-3.64	60.90	74	-13.10	Pk
H	4824.00	45.47	-3.64	41.83	54	-12.17	AV

Remark:

Absolute Level= ReadingLevel+ Factor, Margin= Limit- Absolute Level

802.11b

Normal Voltage

Polar (H/V)	Frequency	Meter Reading	Factor	Emission Level	Limits	Margin	Detector Type
	(MHz)	(dBuV)	(dB)	(dBuV/m)	(dBuV/m)	(dB)	
operation frequency:2437							
V	4874.00	63.07	-3.63	59.44	74	-14.56	Pk
V	4874.00	44.95	-3.63	41.32	54	-12.68	AV
H	4874.00	64.00	-3.64	60.36	74	-13.64	Pk
H	4874.00	44.62	-3.64	40.98	54	-13.02	AV

Remark:

Absolute Level= ReadingLevel+ Factor, Margin= Limit- Absolute Level

802.11b

Normal Voltage

Polar (H/V)	Frequency	Meter Reading	Factor	Emission Level	Limits	Margin	Detector Type
	(MHz)	(dBuV)	(dB)	(dBuV/m)	(dBuV/m)	(dB)	
operation frequency:2462							
V	4924.00	65.69	-3.64	62.05	74	-11.95	pk
H	4924.00	64.47	-3.66	60.81	54	-13.19	pk

Remark:

Absolute Level= ReadingLevel+ Factor, Margin= Limit- Absolute Level



802.11g

Normal Voltage

Polar (H/V)	Frequency	Meter Reading	Factor	Emission Level	Limits	Margin	Detector Type
	(MHz)	(dBuV)	(dB)	(dBuV/m)	(dBuV/m)	(dB)	
operation frequency:2412							
V	4824.00	68.28	-3.6	64.68	74	-9.32	Pk
V	4824.00	46.52	-3.6	42.92	54	-11.08	AV
H	4824.00	66.43	-3.6	62.83	74	-11.17	Pk
H	4824.00	46.25	-3.6	42.65	54	-11.35	AV
Remark:							
Absolute Level= ReadingLevel+ Factor, Margin= Limit- Absolute Level							

802.11g

Normal Voltage

Polar (H/V)	Frequency	Meter Reading	Factor	Emission Level	Limits	Margin	Detector Type
	(MHz)	(dBuV)	(dB)	(dBuV/m)	(dBuV/m)	(dB)	
operation frequency:2437							
V	4874.00	65.79	-3.63	62.16	74	-11.84	Pk
V	4874.00	47.01	-3.63	43.38	54	-10.62	AV
H	4874.00	66.36	-3.64	62.72	74	-11.28	Pk
H	4874.00	46.12	-3.64	42.48	54	-11.52	AV
Remark:							
Absolute Level= ReadingLevel+ Factor, Margin= Limit- Absolute Level							

802.11g

Normal Voltage

Polar (H/V)	Frequency	Meter Reading	Factor	Emission Level	Limits	Margin	Detector Type
	(MHz)	(dBuV)	(dB)	(dBuV/m)	(dBuV/m)	(dB)	
operation frequency:2462							
V	4924.00	65.47	-3.62	61.85	74	-12.15	pk
H	4924.00	64.26	-3.62	60.64	74	-13.36	pk
Remark:							
Absolute Level= ReadingLevel+ Factor, Margin= Limit- Absolute Level							



802.11n(20MHz)

Normal Voltage

Polar (H/V)	Frequency	Meter Reading	Factor	Emission Level	Limits	Margin	Detector Type
	(MHz)	(dBuV)	(dB)	(dBuV/m)	(dBuV/m)	(dB)	
operation frequency:2412							
V	4824.00	65.08	-3.58	61.50	74	-12.50	Pk
V	4824.00	46.77	-3.58	43.19	54	-10.81	AV
H	4824.00	65.25	-3.6	61.65	74	-12.35	Pk
H	4824.00	46.02	-3.6	42.42	54	-11.58	AV
Remark:							
Absolute Level= ReadingLevel+ Factor, Margin= Limit- Absolute Level							

802.11n(20MHz)

Normal Voltage

Polar (H/V)	Frequency	Meter Reading	Factor	Emission Level	Limits	Margin	Detector Type
	(MHz)	(dBuV)	(dB)	(dBuV/m)	(dBuV/m)	(dB)	
operation frequency:2437							
V	4874.00	66.89	-3.63	63.26	74	-10.74	Pk
V	4874.00	46.46	-3.63	42.83	54	-11.17	AV
H	4874.00	65.46	-3.64	61.82	74	-12.18	Pk
H	4874.00	45.69	-3.64	42.05	54	-11.95	AV
Remark:							
Absolute Level= ReadingLevel+ Factor, Margin= Limit- Absolute Level							

802.11n(20MHz)

Normal Voltage

Polar (H/V)	Frequency	Meter Reading	Factor	Emission Level	Limits	Margin	Detector Type
	(MHz)	(dBuV)	(dB)	(dBuV/m)	(dBuV/m)	(dB)	
operation frequency:2462							
V	4924.00	64.24	-3.64	60.60	74	-13.40	pk
V	4924.00	43.67	-3.64	40.03	54	-13.97	AV
H	4924.00	59.32	-3.66	55.66	74	-18.34	pk
Remark:							
Absolute Level= ReadingLevel+ Factor, Margin= Limit- Absolute Level							





4. POWER SPECTRAL DENSITY TEST

4.1 APPLIED PROCEDURES / LIMIT

FCC Part15 (15.247) , Subpart C				
Section	Test Item	Limit	Frequency Range (MHz)	Result
15.247	Power Spectral Density	8 dBm (in any 3KHz)	2400-2483.5	PASS

4.1.1 TEST PROCEDURE

1. Set analyzer center frequency to DTS channel center frequency.
2. Set the span to 1.5 times the DTS bandwidth.
3. Set the RBW to: $3 \text{ kHz} \leq \text{RBW} \leq 100 \text{ kHz}$.
4. Set the VBW $\geq 3 \times \text{RBW}$.
5. Detector = peak.
6. Sweep time = auto couple.
7. Trace mode = max hold.
8. Allow trace to fully stabilize.
9. Use the peak marker function to determine the maximum amplitude level within the RBW.
10. If measured value exceeds limit, reduce RBW (no less than 3 kHz) and repeat.

4.1.2 DEVIATION FROM STANDARD

No deviation.

4.1.3 TEST SETUP



4.1.4 EUT OPERATION CONDITIONS

The EUT tested system was configured as the statements of 2.1 Unless otherwise a special operating condition is specified in the follows during the testing.



4.1.5 TEST RESULTS

EUT :	RC airplane	Model Name :	A803W
Temperature :	24.5°C	Relative Humidity :	60%
Pressure :	1015 hPa	Test Voltage :	DC3.7V
Test Mode :	TX b Mode /CH01, CH06, CH11		

Frequency	Power Density (dBm)	Limit (dBm)	Result
2412 MHz	-7.52	8	PASS
2437 MHz	-8.36	8	PASS
2462 MHz	-8.71	8	PASS

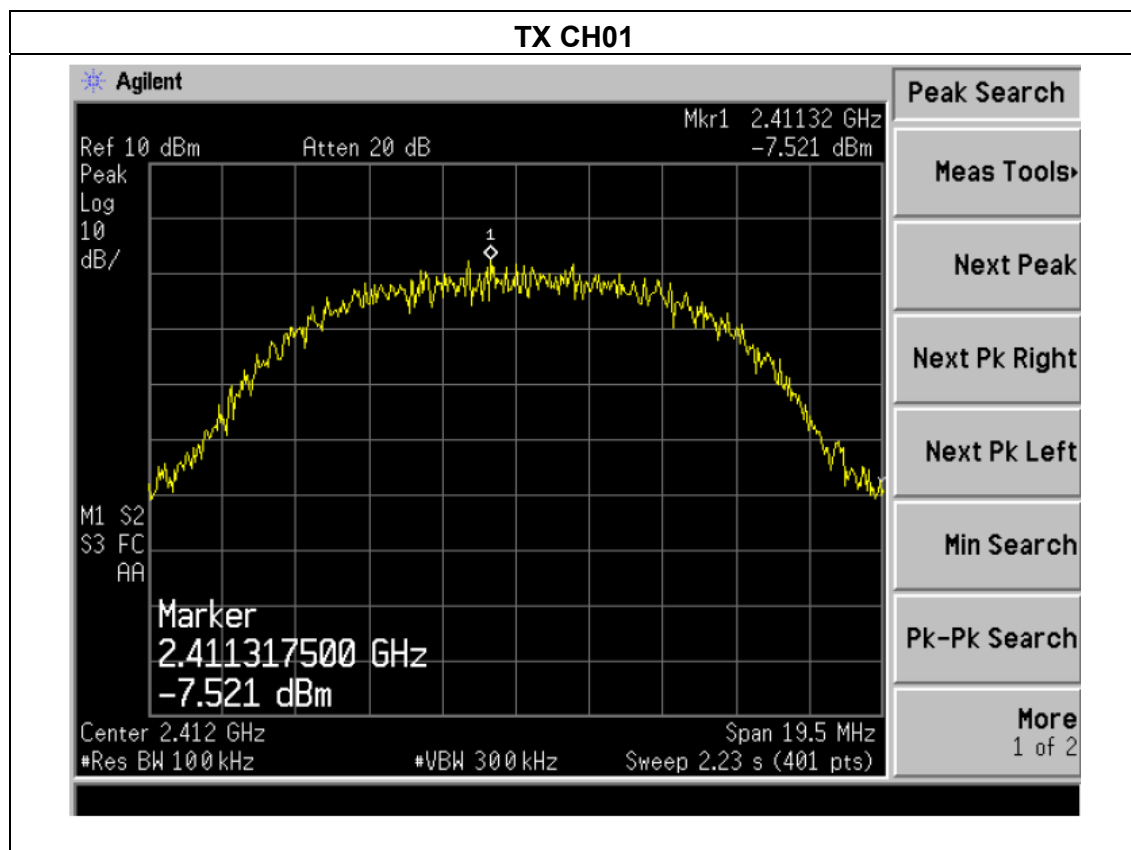

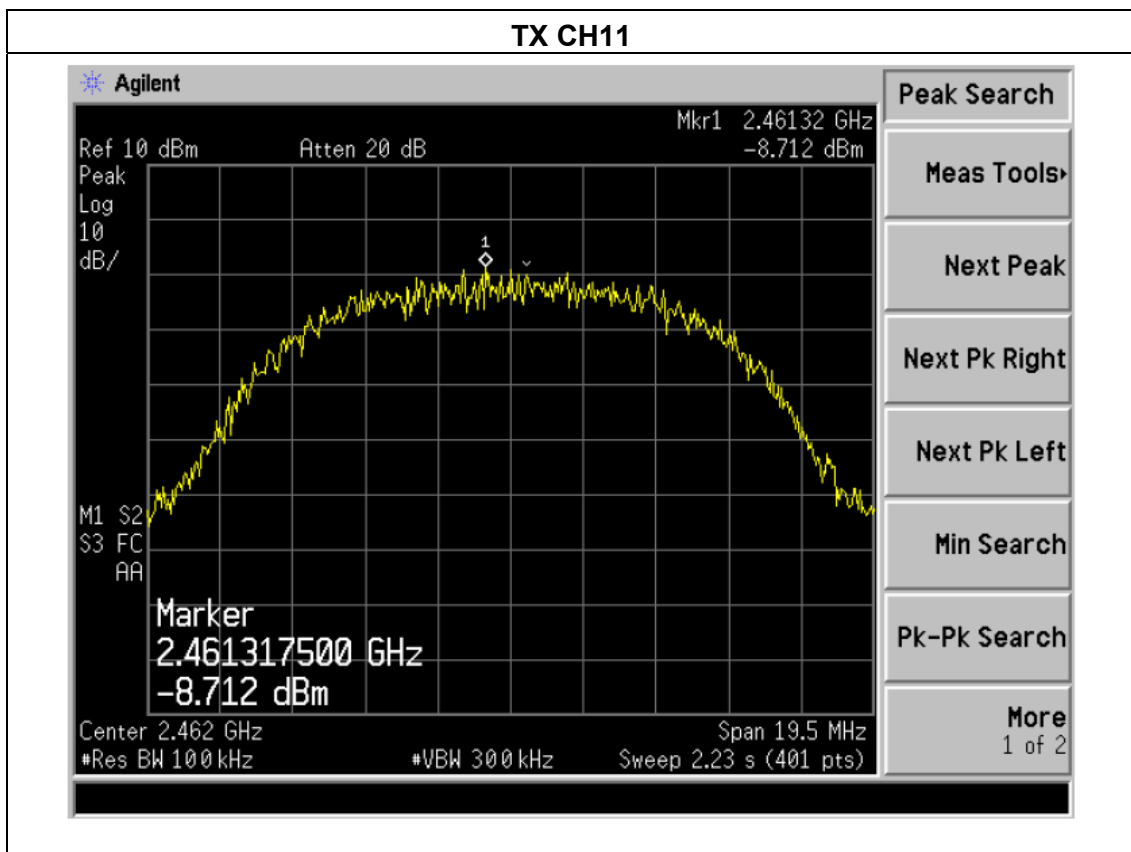
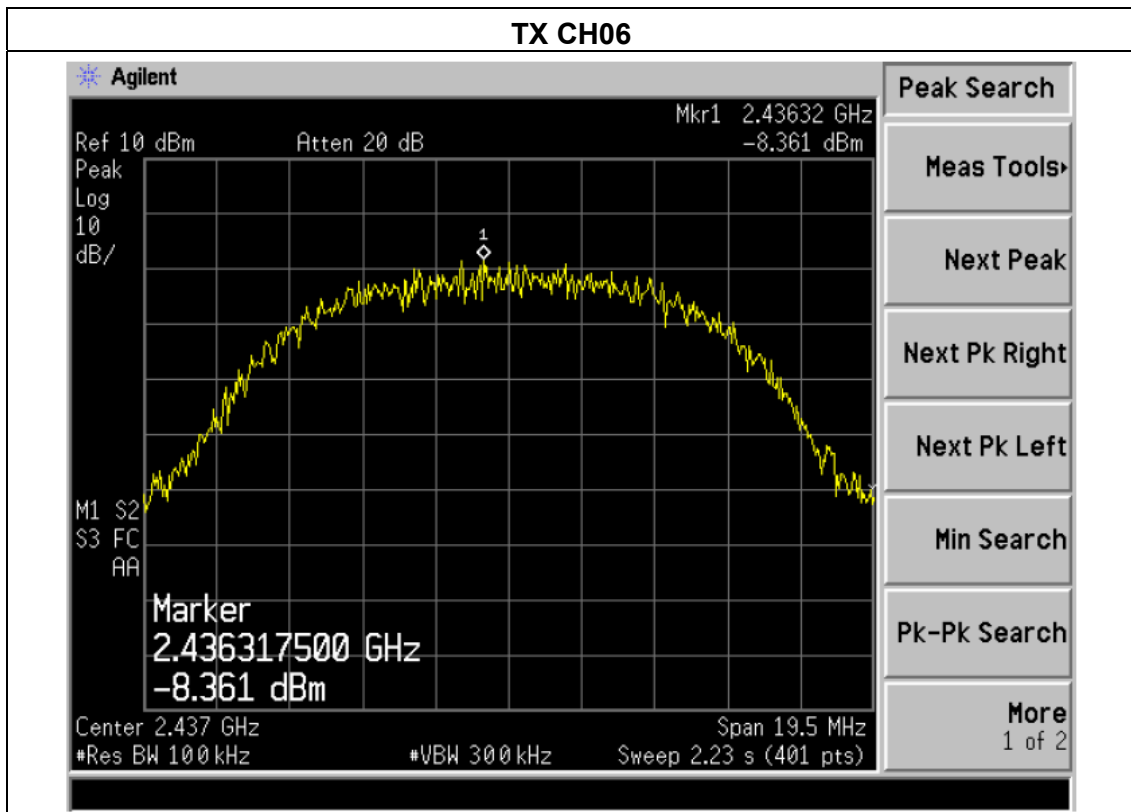



EUT :	RC airplane	Model Name :	A803W
Temperature :	24.5°C	Relative Humidity :	60%
Pressure :	1015 hPa	Test Voltage :	DC3.7V
Test Mode :	TX g Mode /CH01, CH06, CH11		

Frequency	Power Density (dBm)	Limit (dBm)	Result
2412 MHz	-11.97	8	PASS
2437 MHz	-13.66	8	PASS
2462 MHz	-13.86	8	PASS

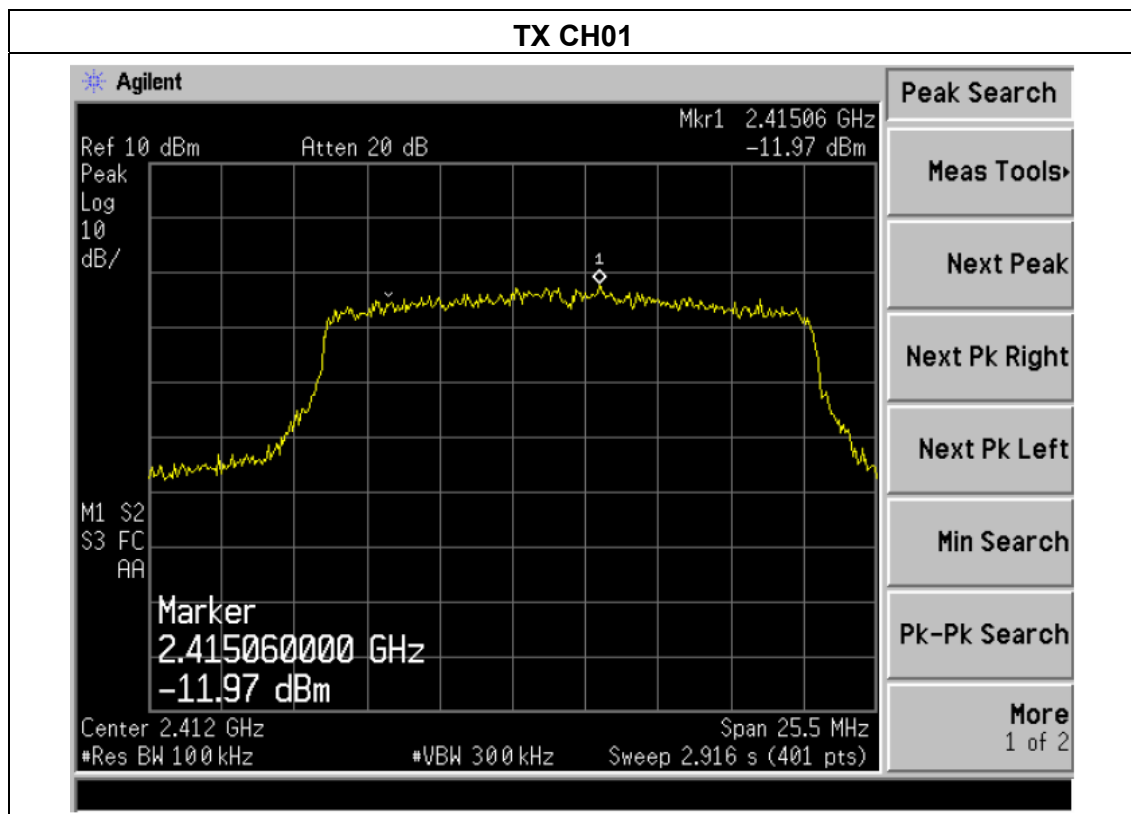

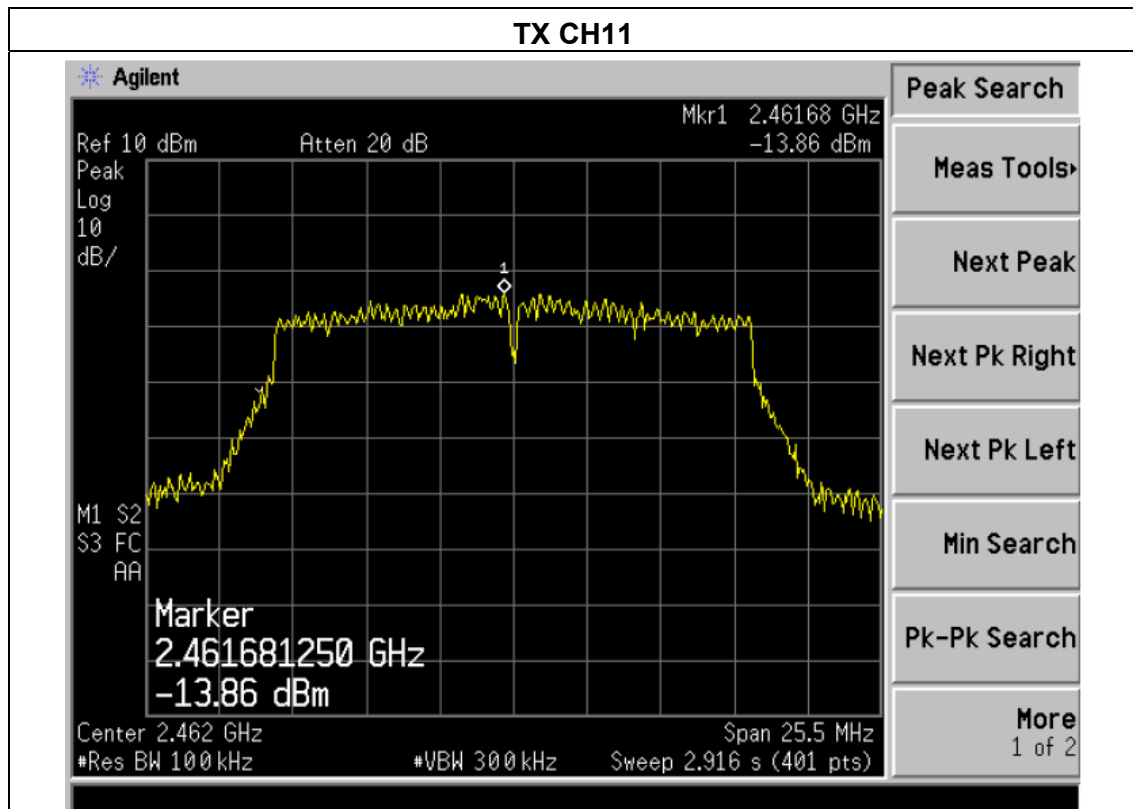
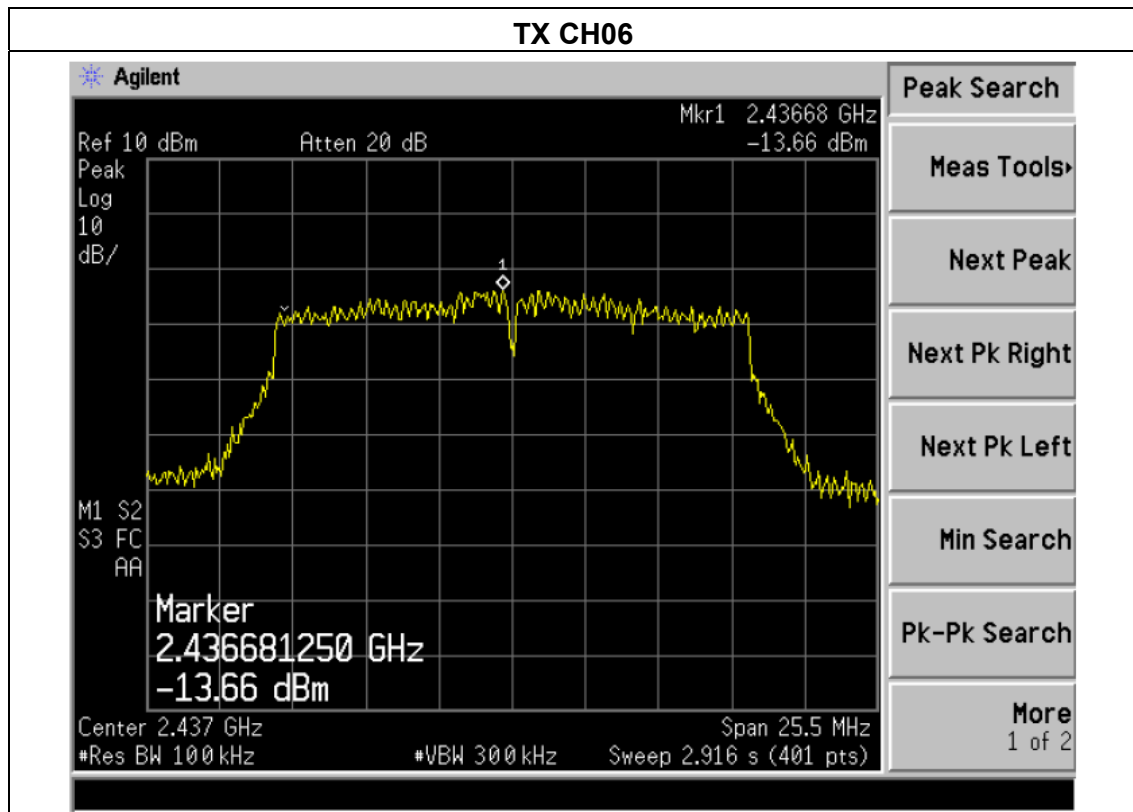



EUT :	RC airplane	Model Name :	A803W
Temperature :	24.5°C	Relative Humidity :	60%
Pressure :	1015 hPa	Test Voltage :	DC3.7V
Test Mode :	TX n Mode(20M) /CH01, CH06, CH11		

Frequency	Power Density (dBm)	Limit (dBm)	Result
2412 MHz	-13.14	8	PASS
2437 MHz	-13.23	8	PASS
2462 MHz	-13.46	8	PASS

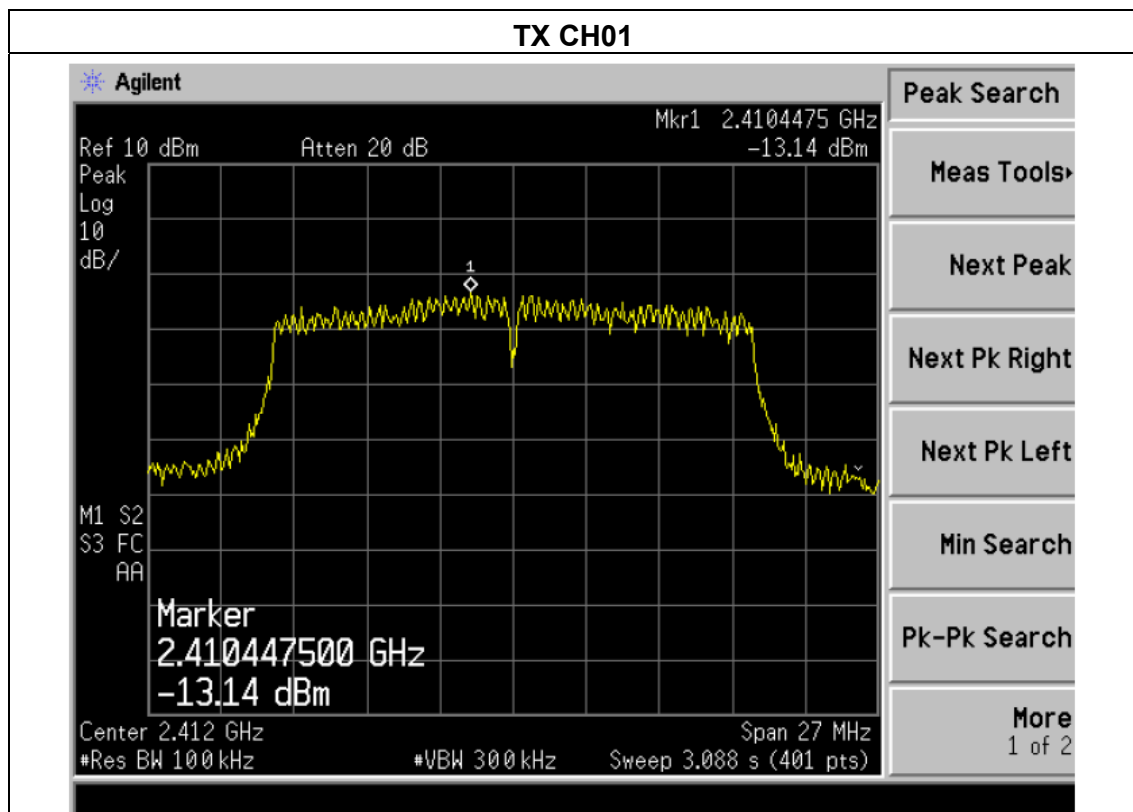

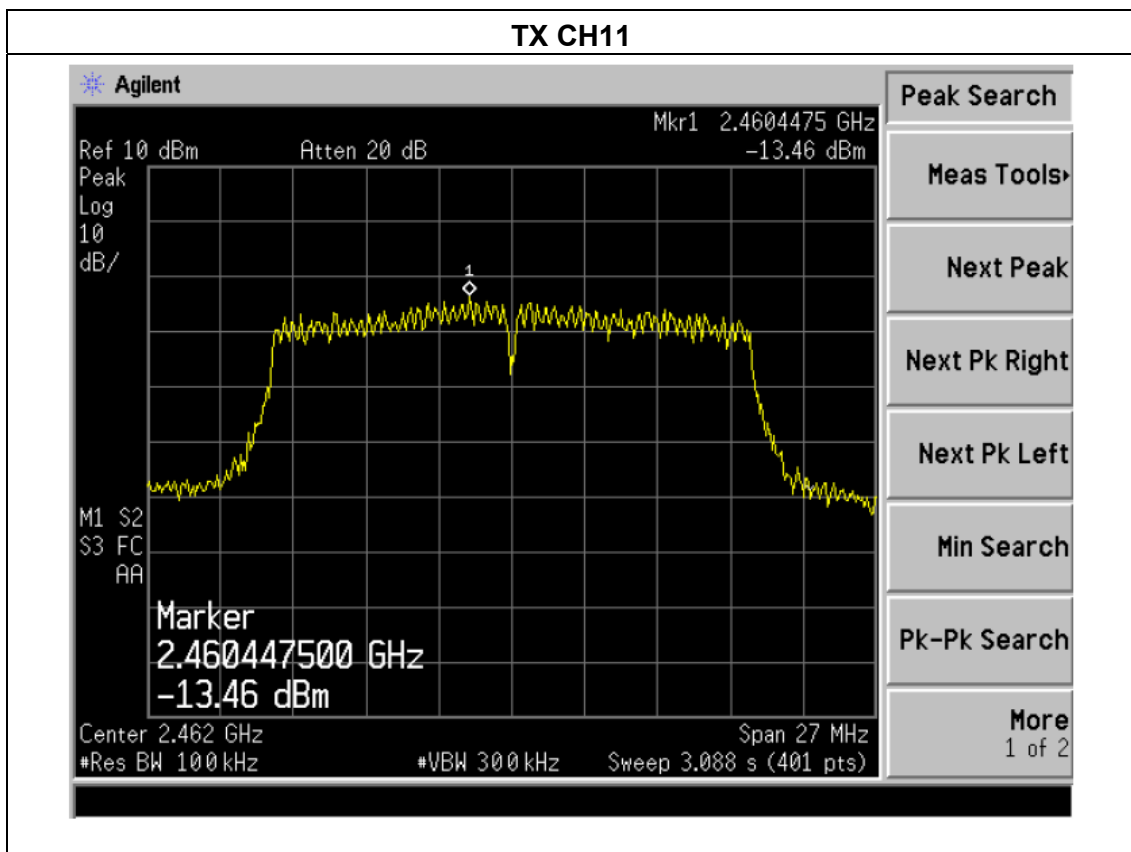
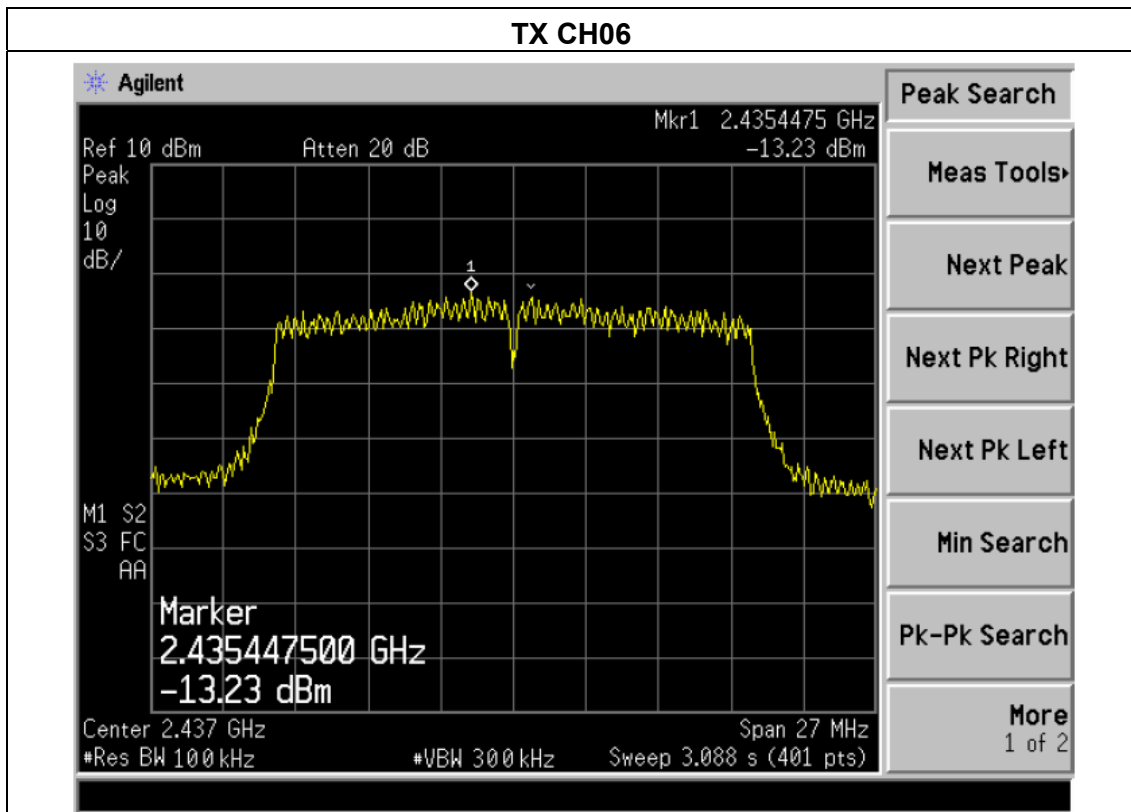



5. BANDWIDTH TEST

5.1 APPLIED PROCEDURES / LIMIT

FCC Part15 (15.247) , Subpart C				
Section	Test Item	Limit	Frequency Range (MHz)	Result
15.247(a)(2)	Bandwidth	$\geq 500\text{KHz}$ (6dB bandwidth)	2400-2483.5	PASS

5.1.1 TEST PROCEDURE

1. Set RBW = 100 kHz.
2. Set the video bandwidth (VBW) $\geq 3 \times$ RBW.
3. Detector = Peak.
4. Trace mode = max hold.
5. Sweep = auto couple.
6. Allow the trace to stabilize.
7. Measure the maximum width of the emission that is constrained by the frequencies associated with the two outermost amplitude points (upper and lower frequencies) that are attenuated by 6 dB relative to the maximum level measured in the fundamental emission.

5.1.2 DEVIATION FROM STANDARD

No deviation.

5.1.3 TEST SETUP



5.1.4 EUT OPERATION CONDITIONS

The EUT tested system was configured as the statements of 2.4 Unless otherwise a special operating condition is specified in the follows during the testing.



5.1.5 TEST RESULTS

EUT :	RC airplane	Model Name :	A803W
Temperature :	24.5°C	Relative Humidity :	60%
Pressure :	1012 hPa	Test Voltage :	DC3.7V
Test Mode :	TX b Mode /CH01, CH06, CH11		

Channel	Frequency (MHz)	6dB bandwidth (MHz)	Limit (kHz)	Result
Low	2412	9.56	500	Pass
Middle	2437	9.52	500	Pass
High	2462	9.56	500	Pass

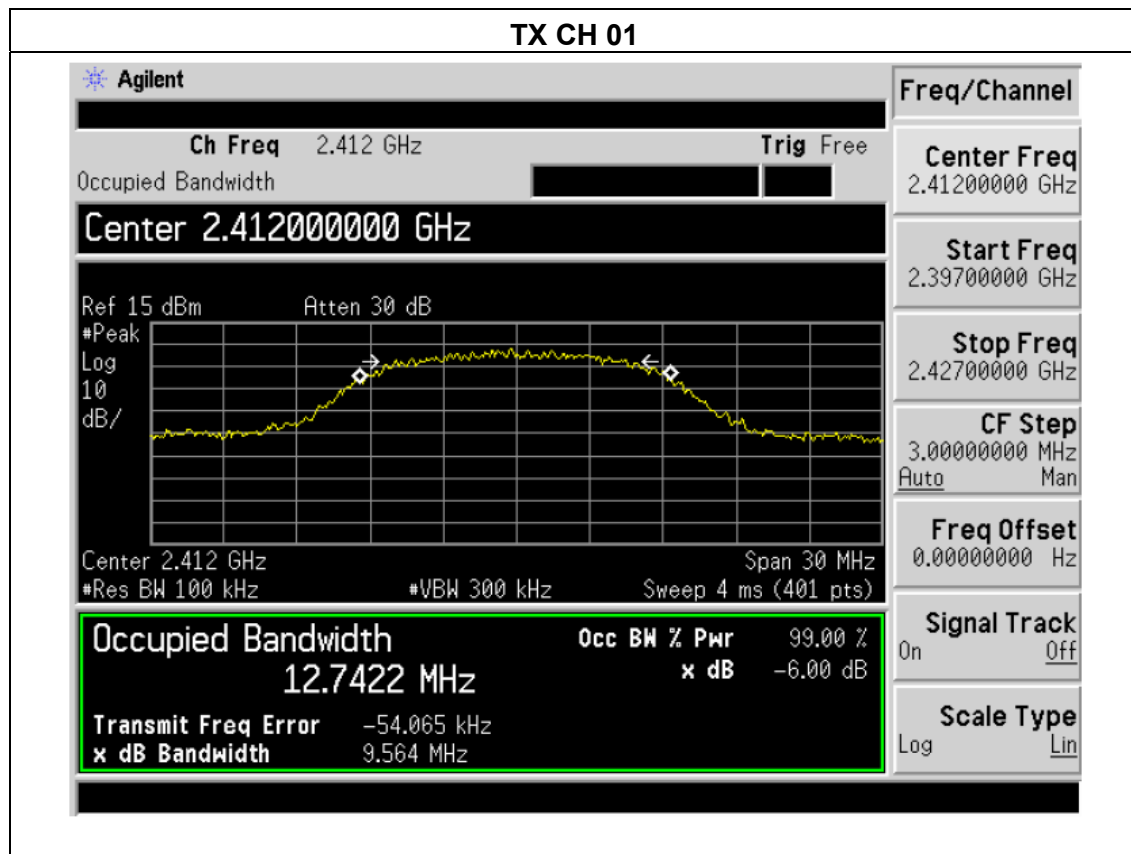

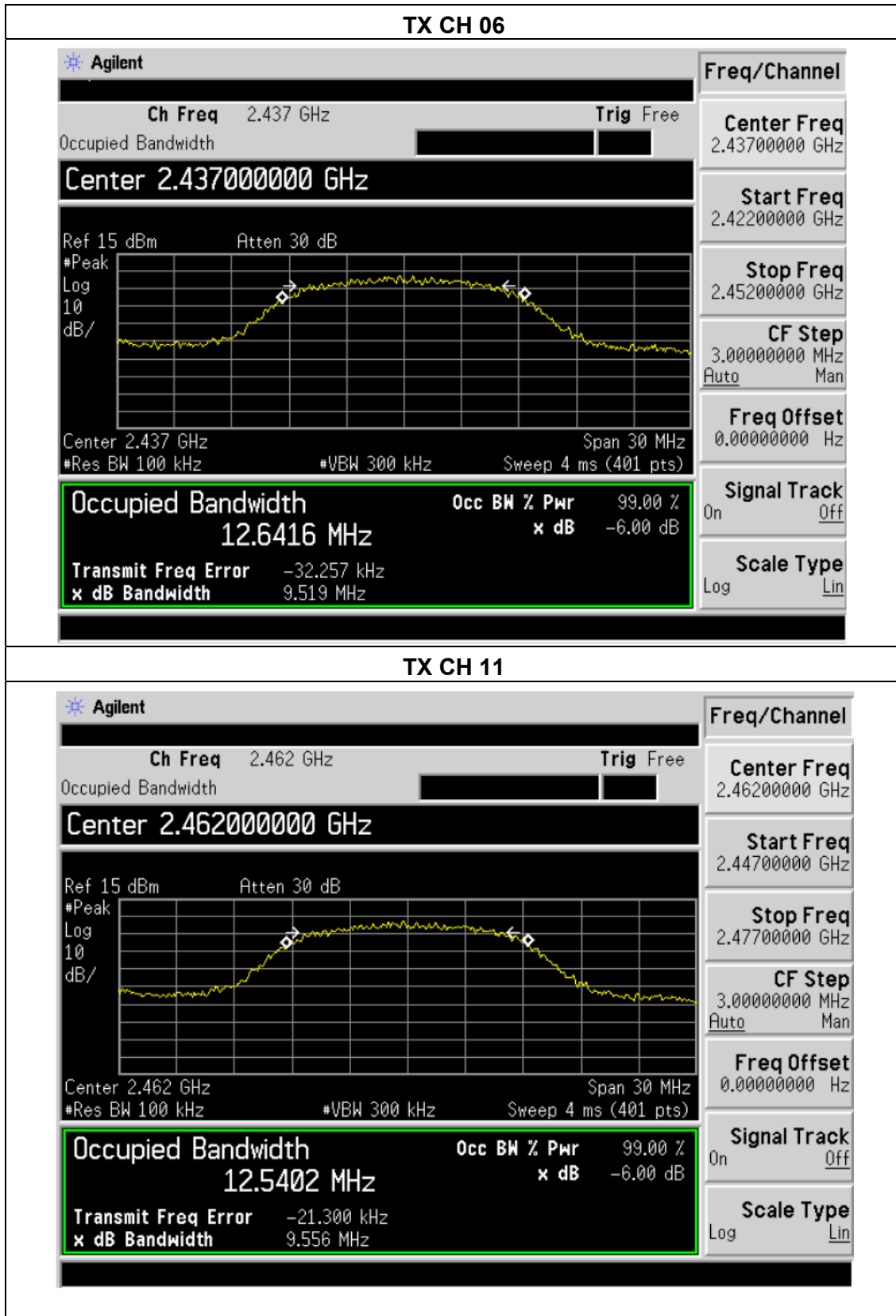



EUT :	RC airplane	Model Name :	A803W
Temperature :	24.5°C	Relative Humidity :	60%
Pressure :	1012 hPa	Test Voltage :	DC3.7V
Test Mode :	TX g Mode /CH01, CH06, CH11		

Channel	Frequency (MHz)	6dB bandwidth (MHz)	Limit (kHz)	Result
Low	2412	16.49	500	Pass
Middle	2437	16.44	500	Pass
High	2462	16.44	500	Pass

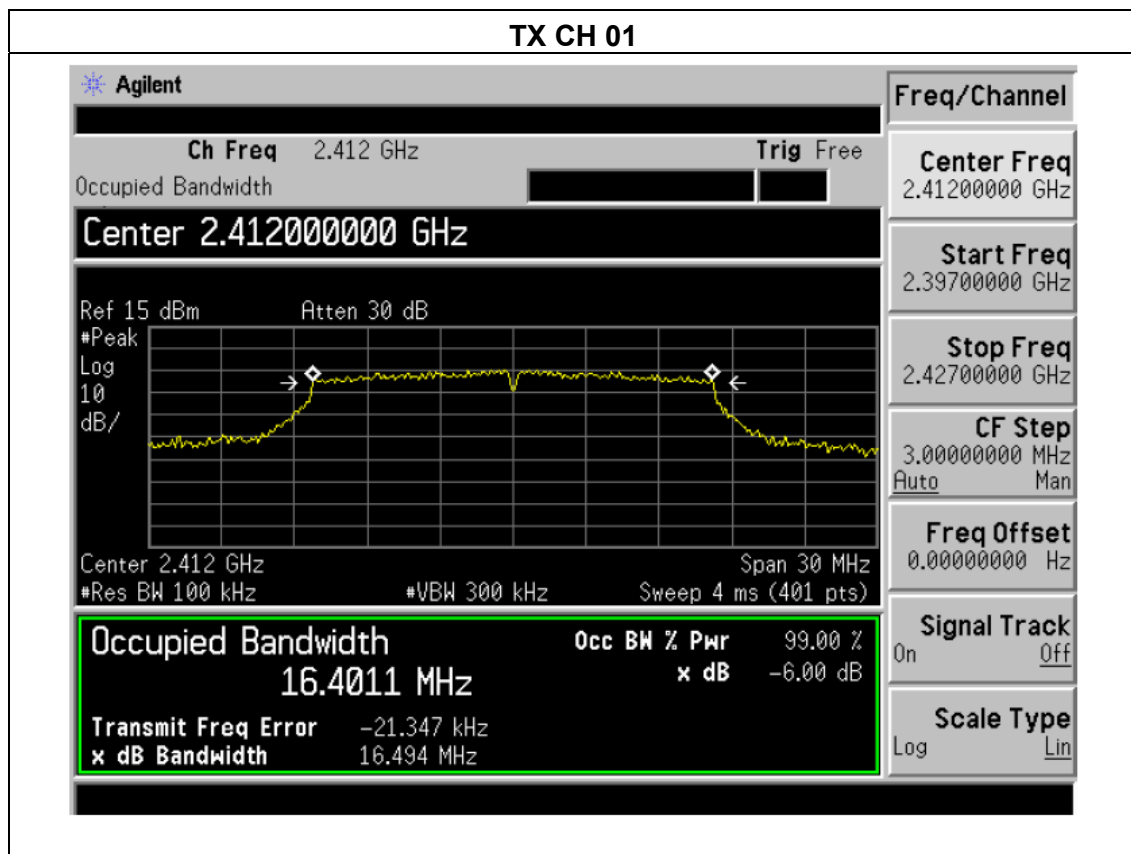

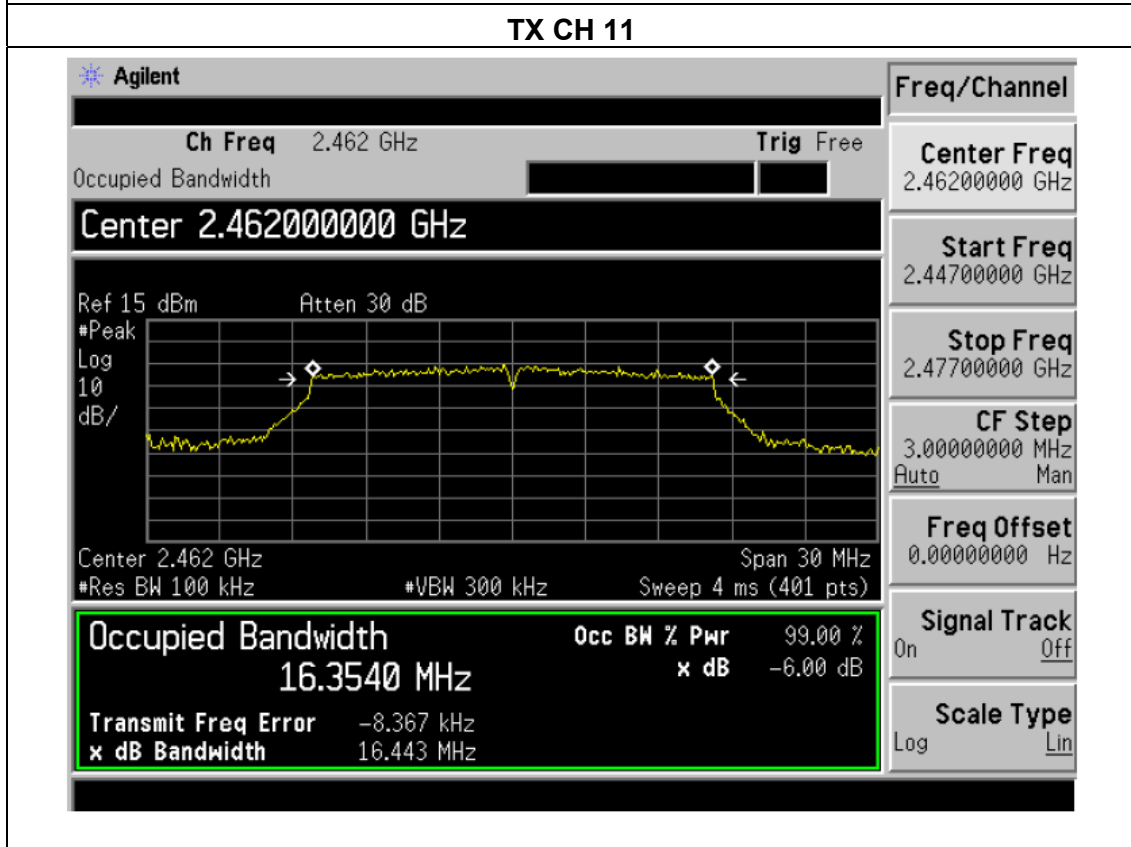
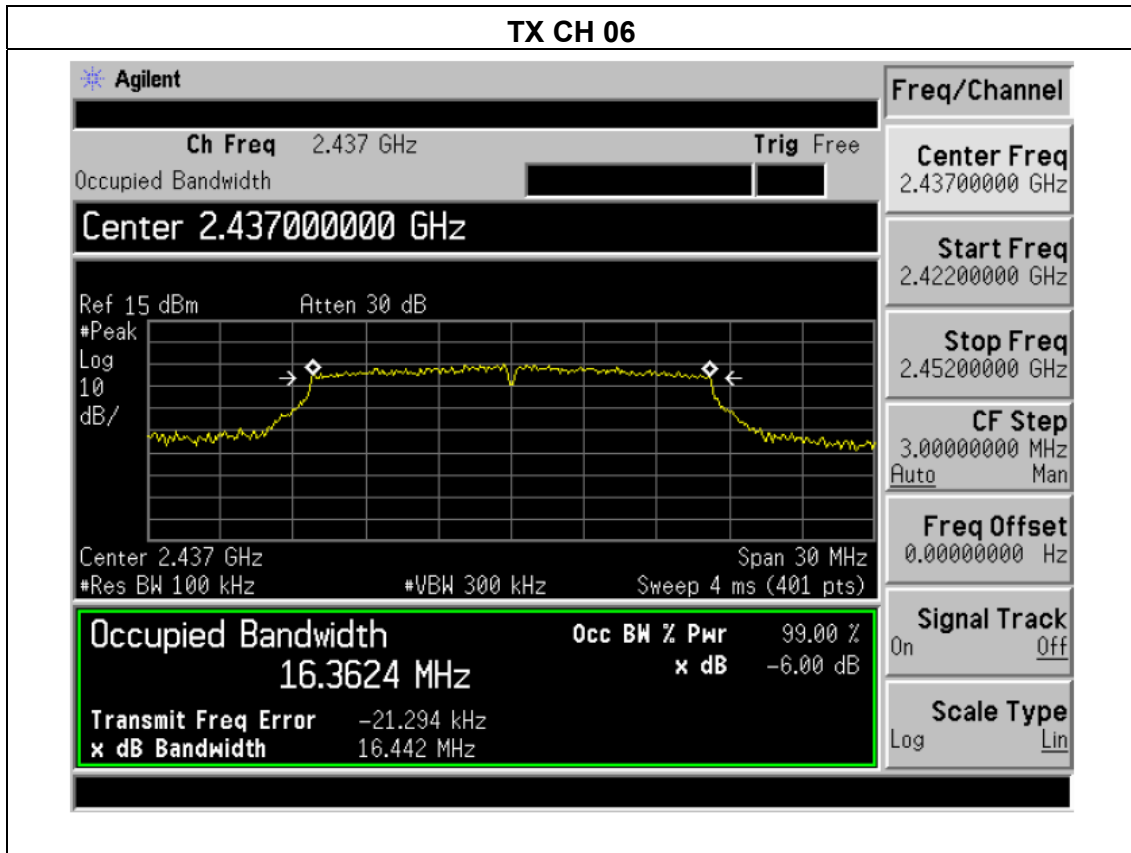



EUT :	RC airplane	Model Name :	A803W
Temperature :	24.5°C	Relative Humidity :	60%
Pressure :	1012 hPa	Test Voltage :	DC3.7V
Test Mode :	TX n Mode(20M) /CH01, CH06, CH11		

Channel	Frequency (MHz)	6dB bandwidth (MHz)	Limit (kHz)	Result
Low	2412	17.57	500	Pass
Middle	2437	17.60	500	Pass
High	2462	17.60	500	Pass

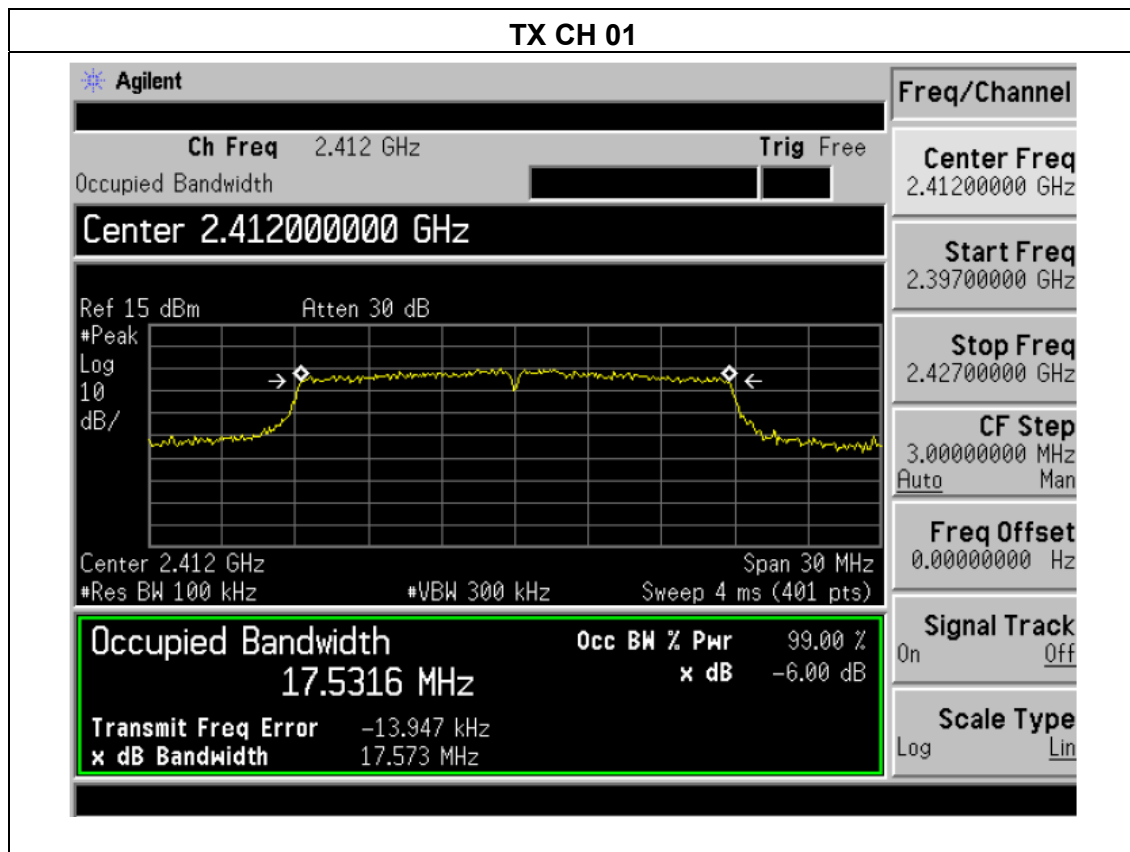

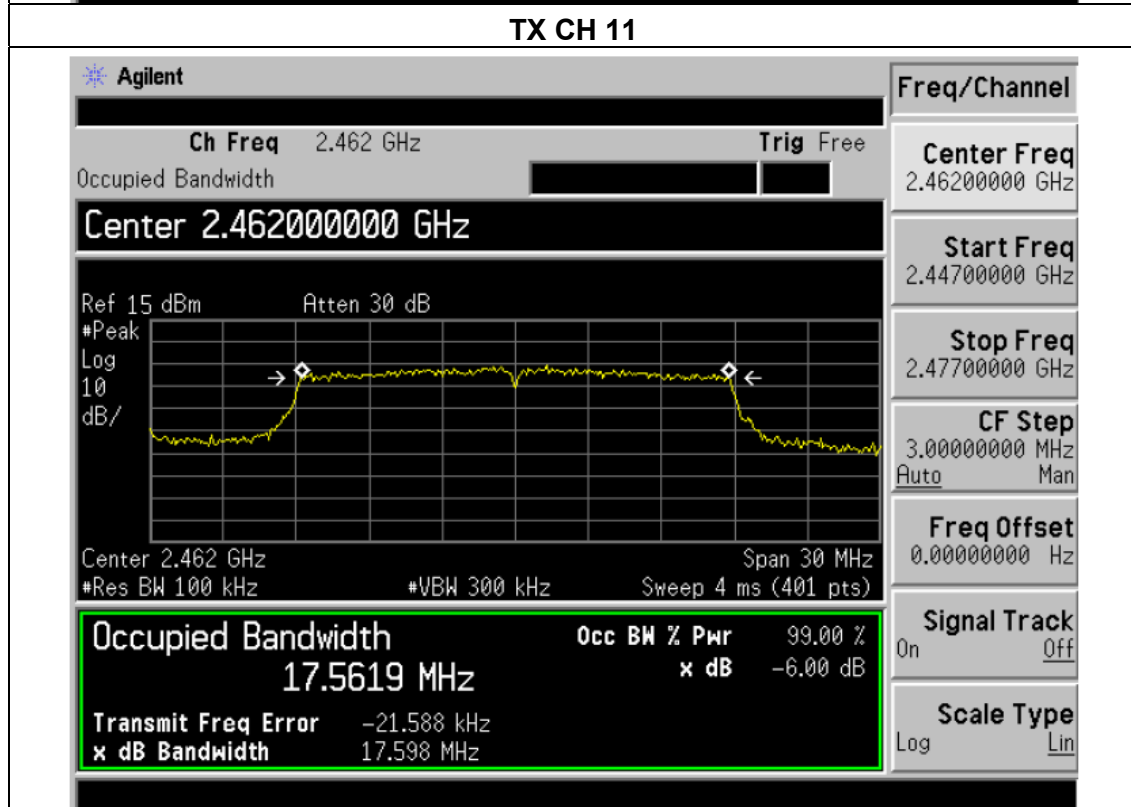
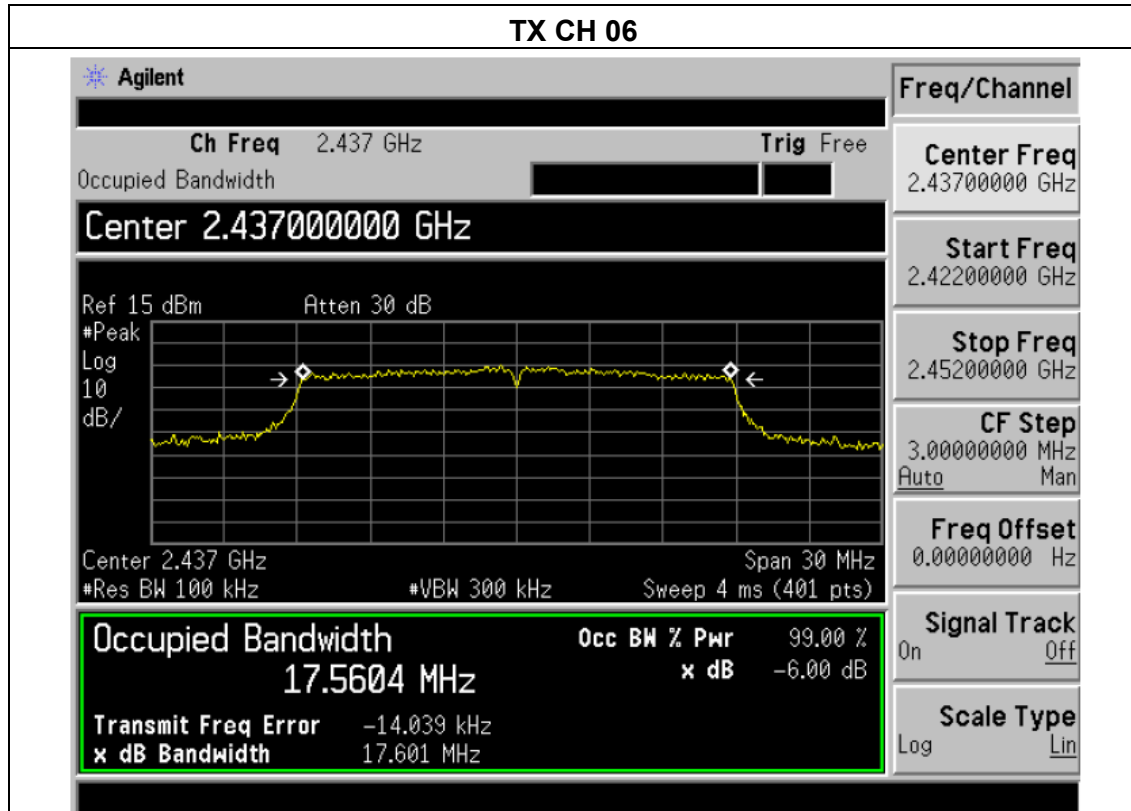



6. PEAK OUTPUT POWER TEST

6.1 APPLIED PROCEDURES / LIMIT

FCC Part15 (15.247) , Subpart C				
Section	Test Item	Limit	Frequency Range (MHz)	Result
15.247(b)(3)	Peak Output Power	1 watt or 30dBm	2400-2483.5	PASS

6.1.1 TEST PROCEDURE

- a. The EUT was directly connected to the Power meter

6.1.2 DEVIATION FROM STANDARD

No deviation.

6.1.3 TEST SETUP



6.1.4 EUT OPERATION CONDITIONS

The EUT tested system was configured as the statements of 2.4 Unless otherwise a special operating condition is specified in the follows during the testing.

**6.1.5 TEST RESULTS**

EUT :	RC airplane	Model Name :	A803W
Temperature :	24.5°C	Relative Humidity :	60%
Pressure :	1012 hPa	Test Voltage :	DC3.7V
Test Mode :	TX b/g/n		

TX 802.11b Mode			
Test Channe	Frequency	Maximum Conducted Output Power(PK)	LIMIT
	(MHz)	(dBm)	dBm
CH01	2412	15.67	30
CH06	2437	15.59	30
CH11	2462	15.63	30
TX 802.11g Mode			
CH01	2412	13.58	30
CH06	2437	13.41	30
CH11	2462	13.34	30
TX 802.11n-HT20 Mode			
CH01	2412	12.15	30
CH06	2437	12.27	30
CH11	2462	12.19	30



7. 100 KHZ BANDWIDTH OF FREQUENCY BAND EDGE

APPLICABLE STANDARD

In any 100 kHz bandwidth outside the frequency band in which the spread spectrum or digitally modulated intentional radiator is operating, the radio frequency power that is produced by the intentional radiator shall be at least 20 dB below that in the 100 kHz bandwidth within the band that contains the highest level of the desired power, based on either an RF conducted or a radiated measurement, provided the transmitter demonstrates compliance with the peak conducted power limits. If the transmitter complies with the conducted power limits based on the use of RMS averaging over a time interval, as permitted under paragraph (b)(3) of this section, the attenuation required under this paragraph shall be 30 dB instead of 20 dB. Attenuation below the general limits specified in §15.209(a) is not required. In addition, radiated emissions which fall in the restricted bands, as defined in §15.205(a), must also comply with the radiated emission limits specified in §15.209(a) (see §15.205(c)).

TEST PROCEDURE

- a) Check the calibration of the measuring instrument using either an internal calibrator or a known signal from an external generator.
- b) Position the EUT without connection to measurement instrument. Turn on the EUT and connect its antenna terminal to measurement instrument via a low loss cable. Then set it to any one measured frequency within its operating range, and make sure the instrument is operated in its linear range.
- c) Set RBW to 100 kHz and VBW of spectrum analyzer to 300 kHz with a convenient frequency span including 100 kHz bandwidth from band edge.
- d) Measure the highest amplitude appearing on spectral display and set it as a reference level. Plot the graph with marking the highest point and edge frequency.
- e) Repeat above procedures until all measured frequencies were complete.

7.1 DEVIATION FROM STANDARD

No deviation.



7.2 TEST SETUP

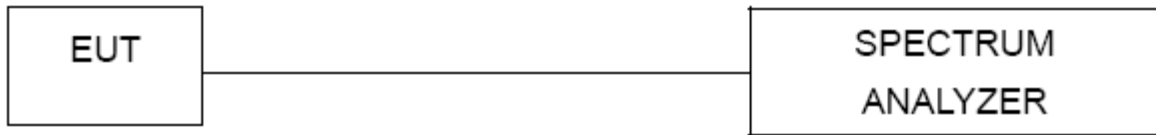

7.3 EUT OPERATION CONDITIONS

The EUT tested system was configured as the statements of 2.4 Unless otherwise a special operating condition is specified in the follows during the testing.

7.4 TEST RESULTS

EUT :	RC airplane	Model Name :	A803W, A803H
Temperature :	24.5°C	Relative Humidity :	60%
Pressure :	1012 hPa	Test Voltage :	DC3.7V

Radiated

Modulation Type:	Frequency (MHz)	Antenna polarization (H/V)	Frequency (MHz)	Emission (dBuV/m)	Band edge Limit (dBuV/m)		Result
				PK	PK	AV	
802.11b	<2400	H	2387.63	50.29	74.00	54.00	Pass
	<2400	V	2386.59	49.50	74.00	54.00	Pass
	>2483.5	H	2492.67	49.34	74.00	54.00	Pass
	>2483.5	V	2491.97	49.95	74.00	54.00	Pass
802.11g	<2400	H	2386.95	49.56	74.00	54.00	Pass
	<2400	V	2387.29	49.28	74.00	54.00	Pass
	>2483.5	H	2493.03	49.60	74.00	54.00	Pass
	>2483.5	V	2492.62	50.01	74.00	54.00	Pass
802.11n20	<2400	H	2387.62	50.06	74.00	54.00	Pass
	<2400	V	2386.98	49.55	74.00	54.00	Pass
	>2483.5	H	2493.21	49.39	74.00	54.00	Pass
	>2483.5	V	2492.48	50.07	74.00	54.00	Pass

Remark:

Factor = Antenna Factor + Cable Loss – Pre-amplifier.



Frequency Band	Delta Peak to band emission (dBc)	> Limit (dBc)	Result
802.11b mode			
Left-band	44.68	20	Pass
Right-band	52.87	20	Pass
802.11g mode			
Left-band	34.95	20	Pass
Right-band	40.66	20	Pass
802.11n-HT20 mode			
Left-band	36.25	20	Pass
Right-band	41.87	20	Pass
802.11n-HT40 mode			
Left-band	31.35	20	Pass
Right-band	37.70	20	Pass



802.11b: Band Edge, Left Side

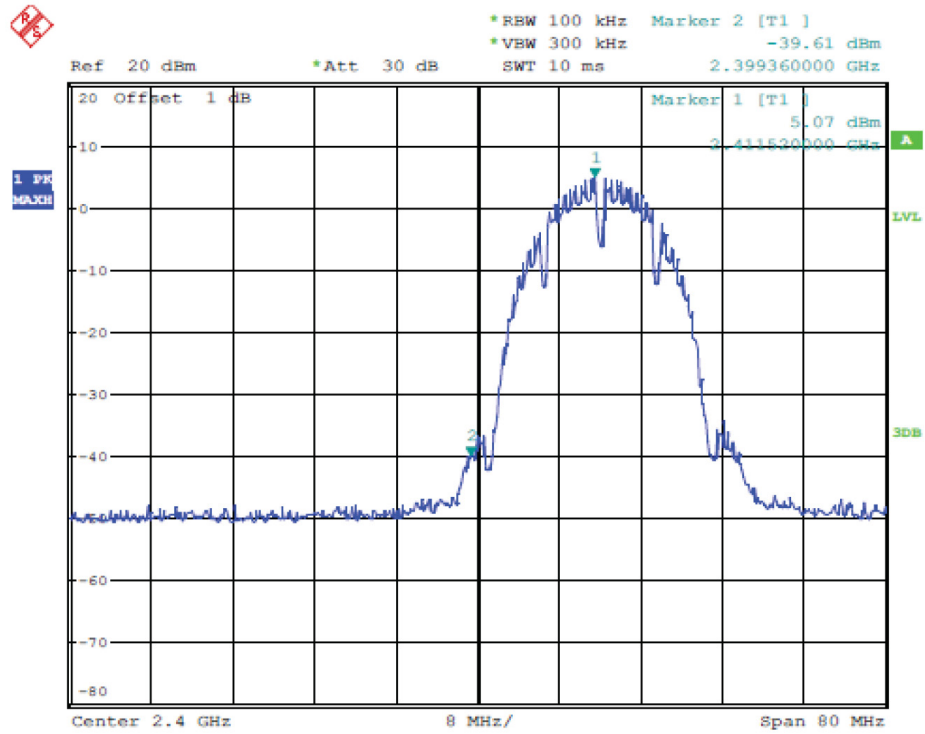

802.11b: Band Edge, Right Side

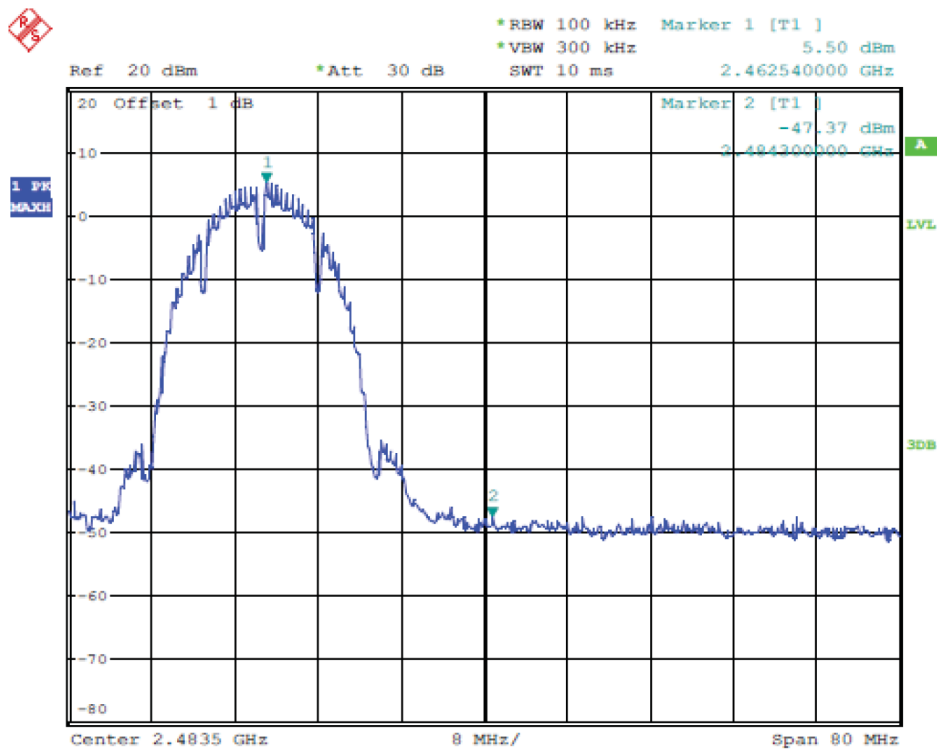



802.11g: Band Edge, Left Side

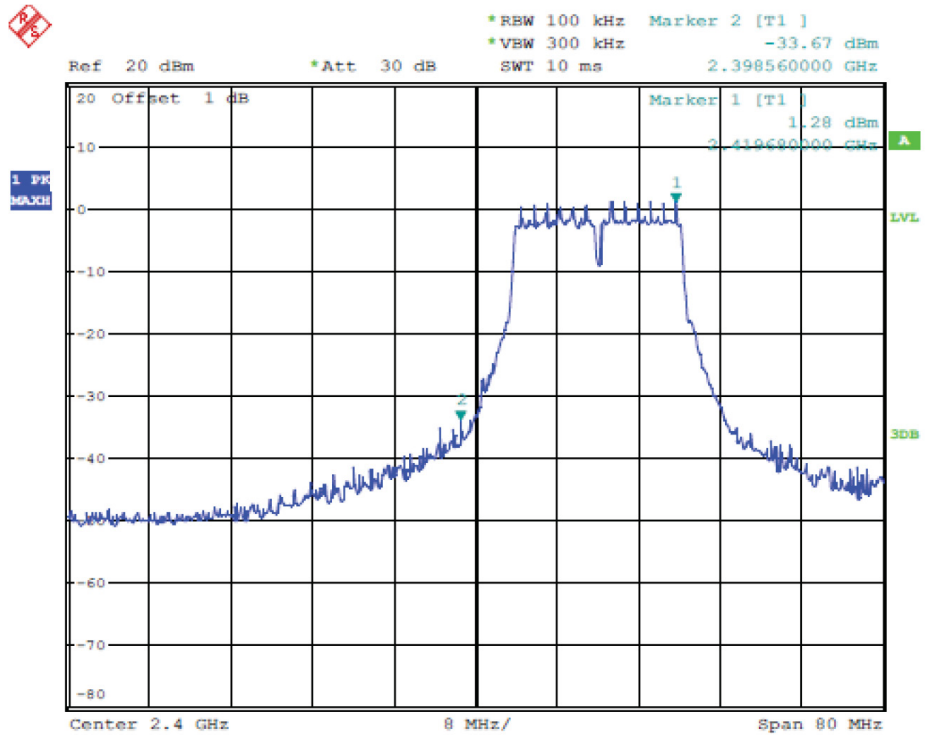

802.11g: Band Edge, Right Side

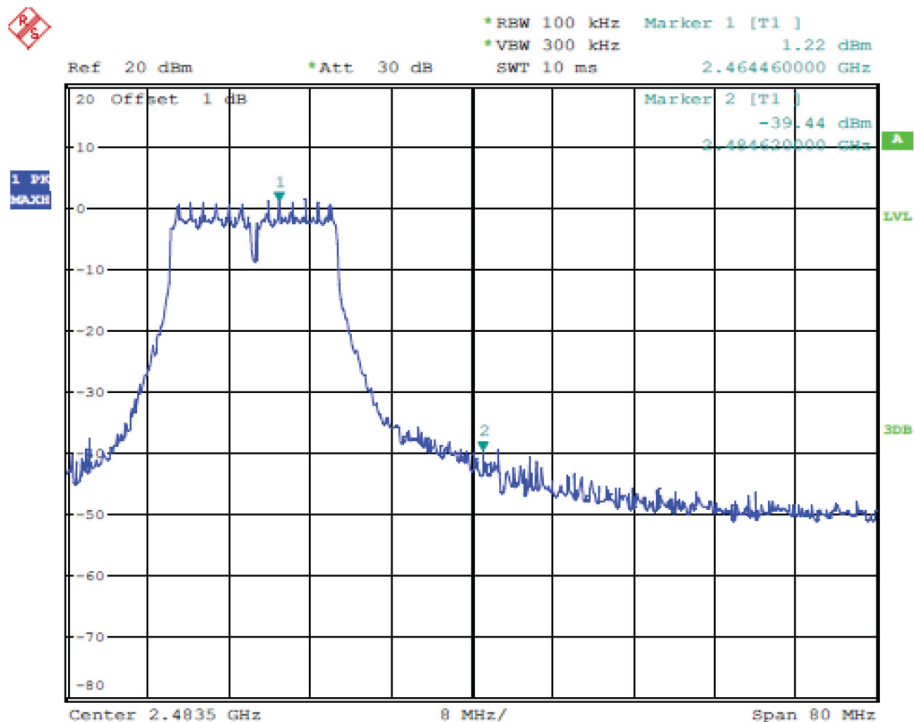



802.11n-HT20: Band Edge, Left Side

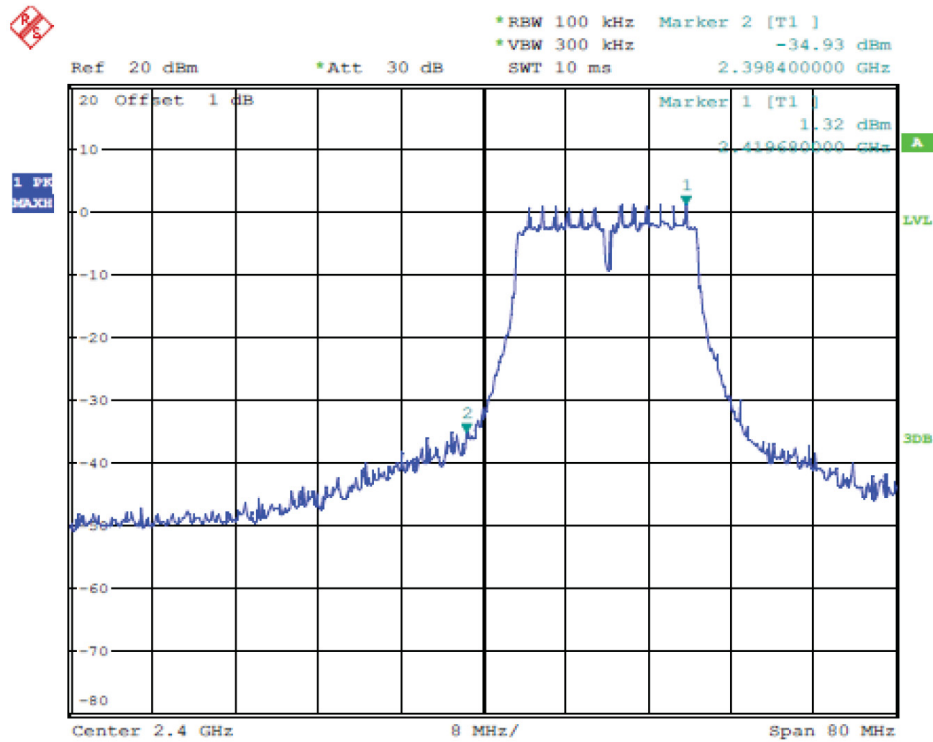

802.11n-HT20: Band Edge, Right Side

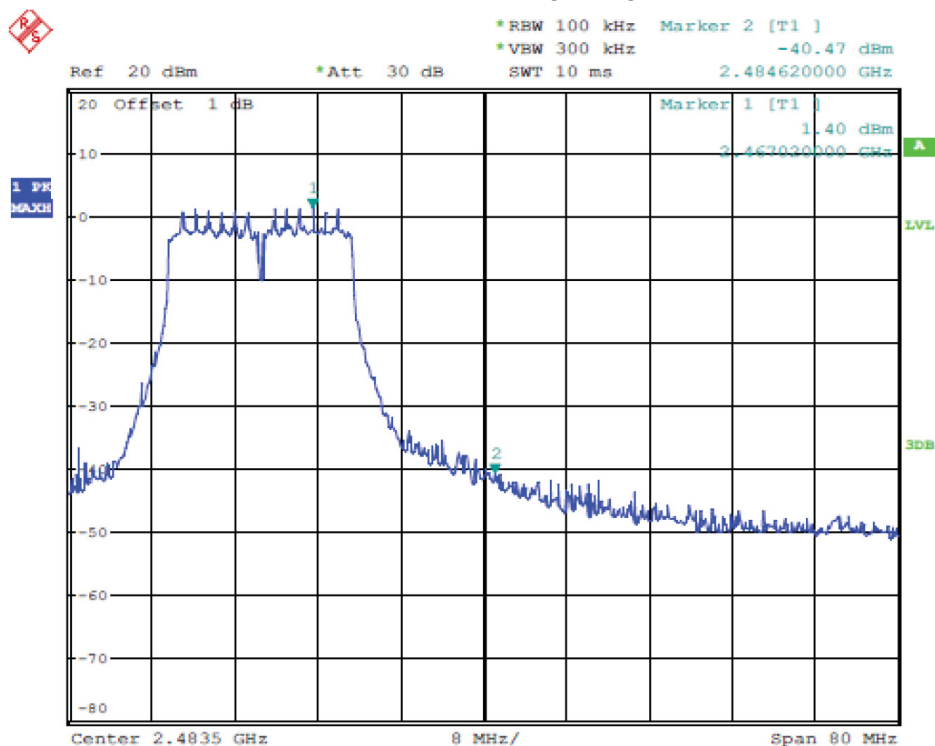



For conducted test

All modes for 802.11b/g/n have tested, and the worst result 802.11b low channel recorded as below.

802.11b 2412MHz

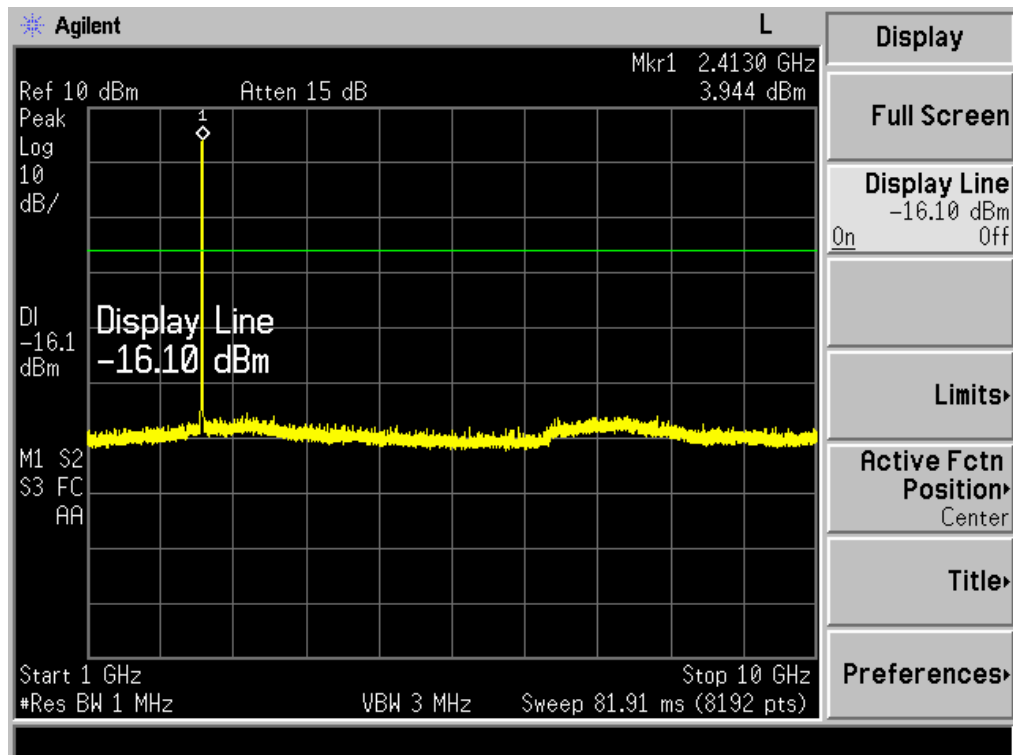
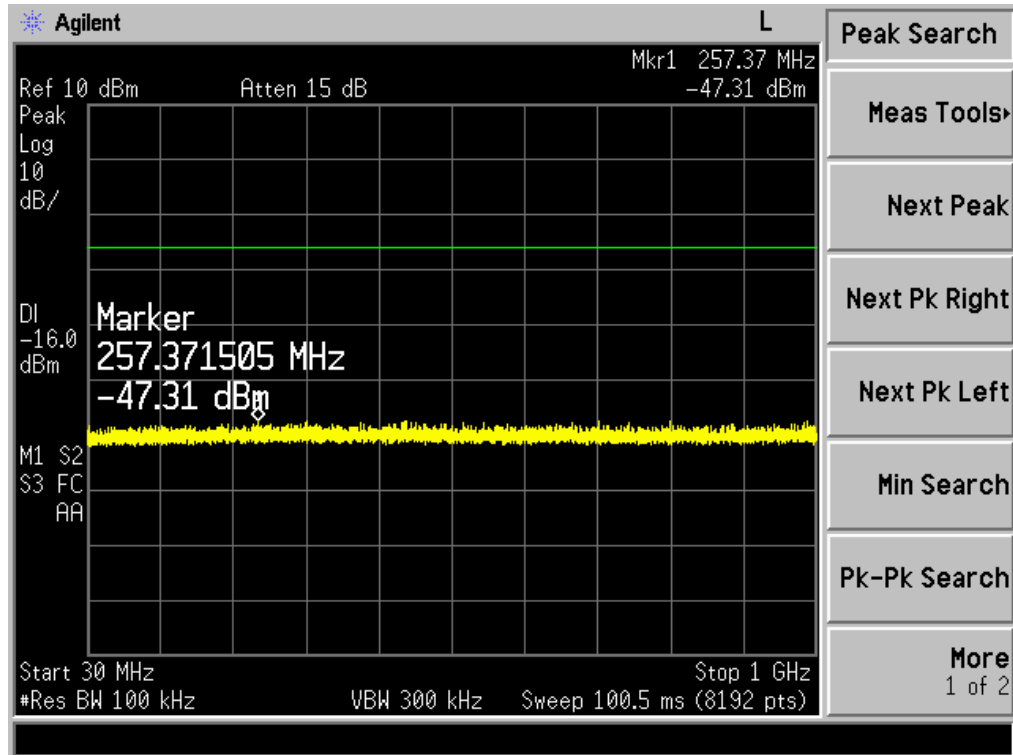

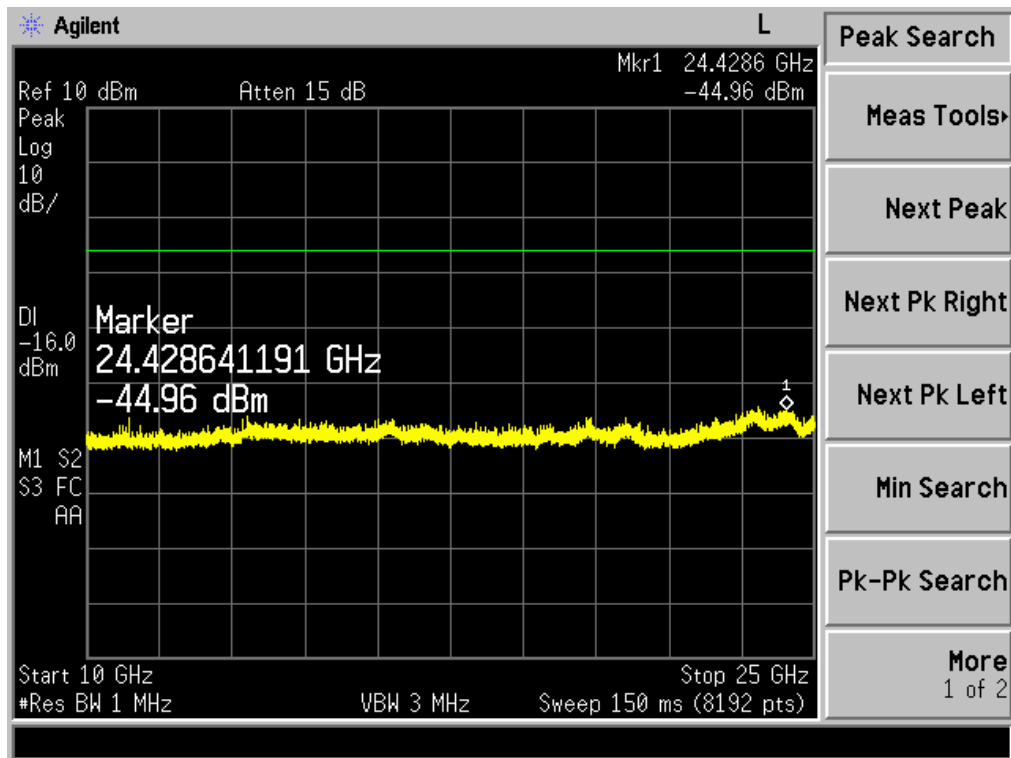

8. ANTENNA REQUIREMENT

8.1 STANDARD REQUIREMENT

15.203 requirement: For intentional device, according to 15.203: an intentional radiator shall be designed to ensure that no antenna other than that furnished by the responsible party shall be used with the device.

8.2 EUT ANTENNA

The EUT antenna is external antenna. It comply with the standard requirement.

9. EUT TEST PHOTO

Radiated Measurement Photos

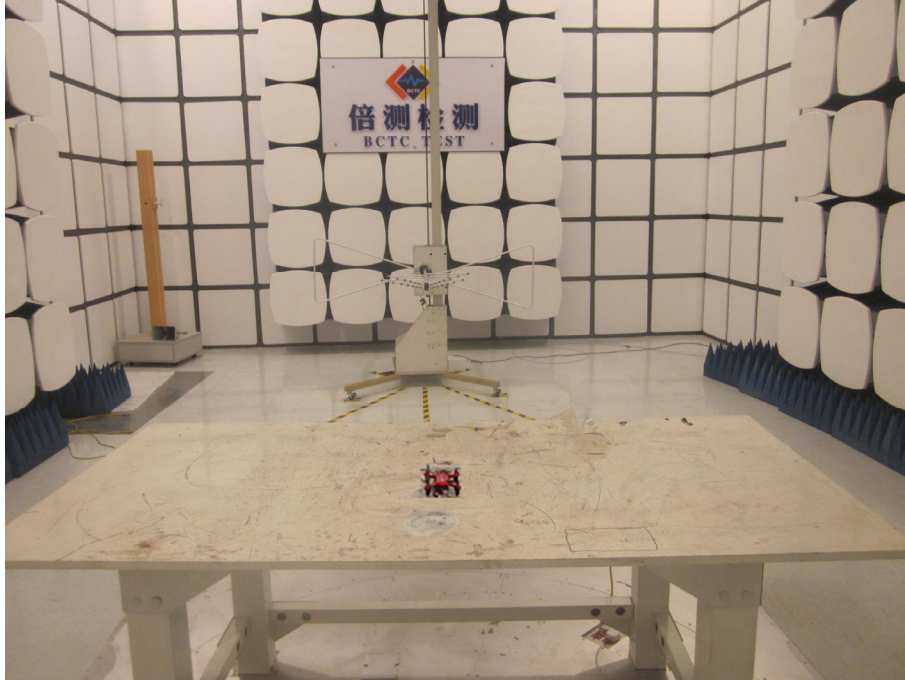

Radiated Measurement Photos

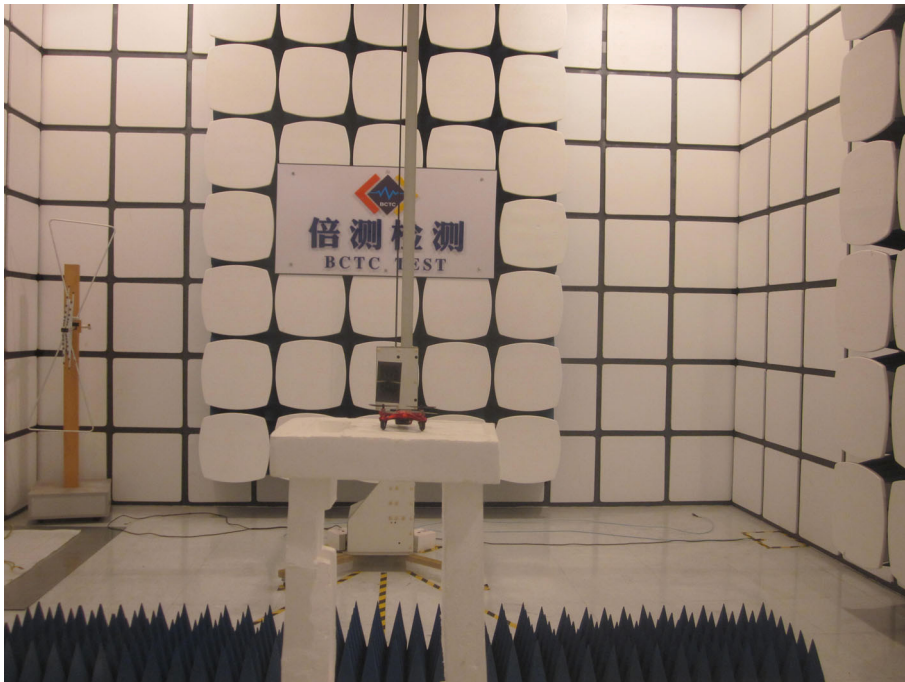

10. EUT PHOTO

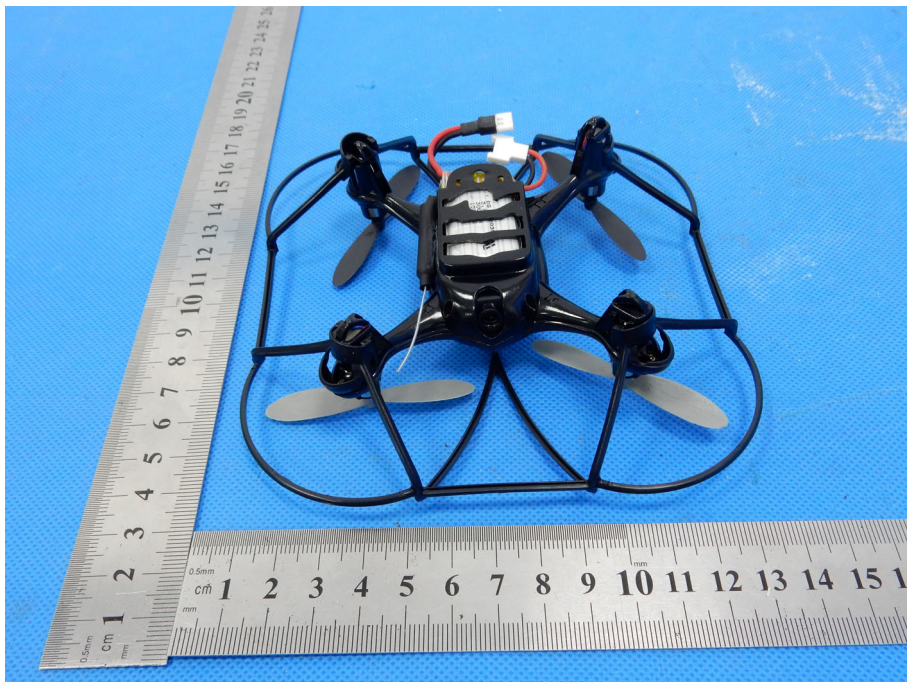

***** END OF REPORT *****