



PTT NETWORK RADIO OWNER' S MANUAL

Talkpod

is the trademark or registered trademark of Quanshun Communication Technology Co., Ltd.

2016 Quanshun Communication Technology Co., Ltd. All Rights Reserved.

Address: Quanshun Bldg, Daxiamei, Nan'an, Quanzhou, Fujian, China 362302

<http://www.talkpod.com>

Printed in China.

1. General Information

Preface

Model and Bands

Disclaimer

RF Radiation Information

RF Radiation Profile

RF Radiation Safety

FCC Regulations

Operational Instructions and Training Guidelines

EU Regulatory Conformance

2. Safety Guidelines

Avoid High Temperatures

Battery Disposal

Aircraft

Refuelling point

Charging safety

- Child Safety
- 3. Before Start**
 - Check the Box
 - Items in the Package
 - Product Overview
 - LED Indicator
- 4. Usage Guidelines**
 - Attach the Battery
 - Charge the Battery
 - Assembling the Belt Clip
 - Assembling the Antenna
 - Assembling the Accessories
 - Insert the SIM Card
- 5. Basic Operations**
 - Powering On/Off
 - Adjusting the Volume
 - Menu Interface and Feature Selecting
 - Selecting a Group
 - Selecting a Member
 - Selecting a Friend
 - GPS Information
 - SOS Button
- 6. Care and Cleanning**
 - Care
 - Cleanning
- 7. Troubleshooting**
- 8. Optional Accessories**

1. General Information

Preface

Thanks for your favor in our product. This manual is helpful for you to quickly know how to use the product.

Model

This manual is applicable to the following product:
N4X PTT Network Radio. (X may represents 0-9)

Disclaimer

Quanshun Communication Technology Co., Ltd. (the Company) endeavors to achieve the accuracy and completeness of this manual, but no warranty of accuracy or reliability is given. All the specifications and designs are subject to change without notice due to continuous technology development. No part of this manual may be copied, modified, translated, or distributed in any manner without the express written permission of us. We do not guarantee, for any particular purpose, the accuracy,

validity, timeliness, legitimacy or completeness of the Third Party products and contents involved in this manual.
If you have any suggestions or would like to learn more details, please visit our website at www.talkpod.com

2. Safety Guidelines

Avoid High Temperatures

Leaving the device in hot or cold places, such as in a closed car in summer or winter conditions, will reduce the capacity and lifetime of the battery. For the best results, try to use the device between -30°C and $+50^{\circ}\text{C}$ (-4°F and 131°F). A device with a hot or cold battery may not work temporarily, even when the battery is fully charged. Battery performance is particularly limited in temperatures well below freezing.

Battery Disposal

Do not expose the battery to high temperatures. Do not dispose off batteries in a fire as they may explode. Batteries may also explode if damaged. Dispose of batteries according to local regulations and recycle when possible. Do not dispose as household waste. Do not dismantle, open or shred cells or batteries. In the event of a battery leak, do not allow the liquid to come in contact with the skin or eyes. In the event of leak or a hazard seek medical help immediately.

Aircraft

Switch off your radio when in an aircraft. Network radios can cause interference or danger to an aircraft.

Refuelling point

Do not use the radio at a refuelling point. Observe restrictions when using radio equipment at fuel depots, chemical plants or where blasting operations are in progress.

Charging safety

Use only Talkpod approved charging equipment to charge your radio and avoid damage to your radio. A rechargeable battery powers your device. Use the battery only for its intended purpose. Never use any charger or battery that is damaged. If the battery is completely discharged, it may take a few minutes before the charging indicator appears on the desktop charger. The full performance of a new battery is achieved only after

three to four complete charge and discharge cycles. The battery can be charged and discharged hundreds of times but it will eventually wear out. Unplug the charger from the electrical plug and the device when not in use. Ensure that you do not leave the fully charged battery connected to the charger for longer time. If left unused, a fully charged battery will lose its charge over time.

Child Safety

Ensure that only qualified personnel install or repair your radio. Do not allow children to play with your radio or its accessories. Keep it out of their reach. They could hurt themselves or others, or could accidentally damage the radio or accessories. Your radio and its accessories may contain small parts, which could be detached and create a choking hazard.

3. Before Start

Check the Box

Before using this radio, we suggest you to:

- Check the package to see if there are signs of damage.
- Unpacking the package carefully, confirm if any of items of this package are missing. If you find the radio or accessories are missing or damaged please contact your dealer.

Items in the Package

(Note: All pictures in this manual are for reference only.)

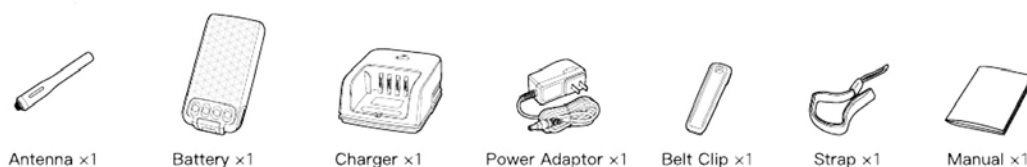

Product Overview

- 1) Feature Selector Knob
- 2) On/Off/Volume Control Knob
- 3) LED Indicator
- 4) Push-to-Talk (PTT) Button
- 5) Side Button 1 (Programmable)
- 6) Side Button 2 (Programmable)
- 7) Okay/Menu Button
- 8) Front Button P1 (Programmable)
- 9) Navigation Button
- 10) Return Button
- 11) Front Button P2 (Programmable)
- 12) Keypad
- 13) Microphone
- 14) Speaker

15) Universal Connector for Accessories

16) Antenna

Record you radio' s Programmable button functions in the blanks provided. SP represents short press, LP represents long press.

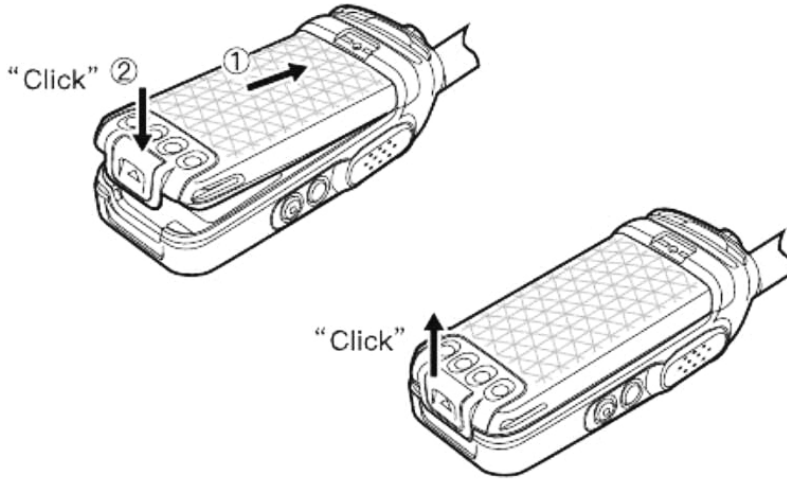

LED Indicator

LED Indication	Product Status
The LED indicator flashes green	Powering on
The LED indicator glows green	Receiving
The LED indicator glows red	Transmitting

4. Usage Guidelines



Attach the Battery

Note: Turn off the radio before removing the battery.

If not assembled with battery specified by Talkpod, the radio will give an alarm tone to remind you when powering on. Afterwards, it will operate normally.

Charge the Battery











Please use the charger specified by the company, and follows the charging

step as shown below

Charging Status

Note: Make sure the radio is powered off before charging. Read the Safety Information Booklet in advance to get necessary safety information. To achieve optimal battery performance, please charge the battery for at least 5 hours before initial use.

Assembling the Belt Clip

Charging Status	
 Blinking Red	-  + Unchargeable
 Blinking Orange	-  + Waiting to charge. (Either the battery Voltage is too low or the battery temperature is too low or too high to allow charging. When this condition is corrected, the battery will automatically begin charging.)
 Steady Red	-  + Rapid Charging
 Blinking Green	-  + Charged (90% capacity)
 Steady Green	-  + Fully Charged

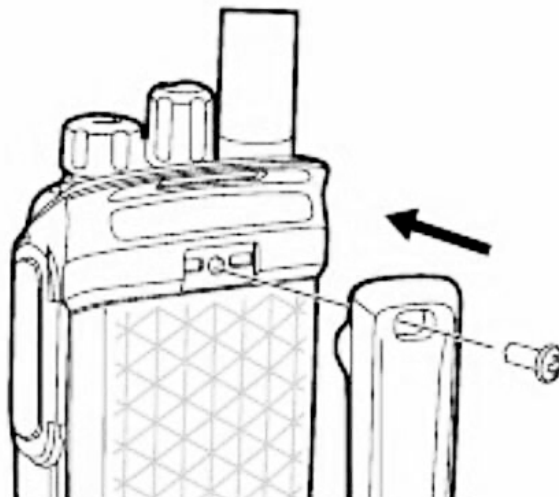

Assembling the Antenna

Note: Do not swing the radio when holding it by the antenna, so as to avoid lowering the performance and shortening the life span of the

antenna.

Assembling the Accessories

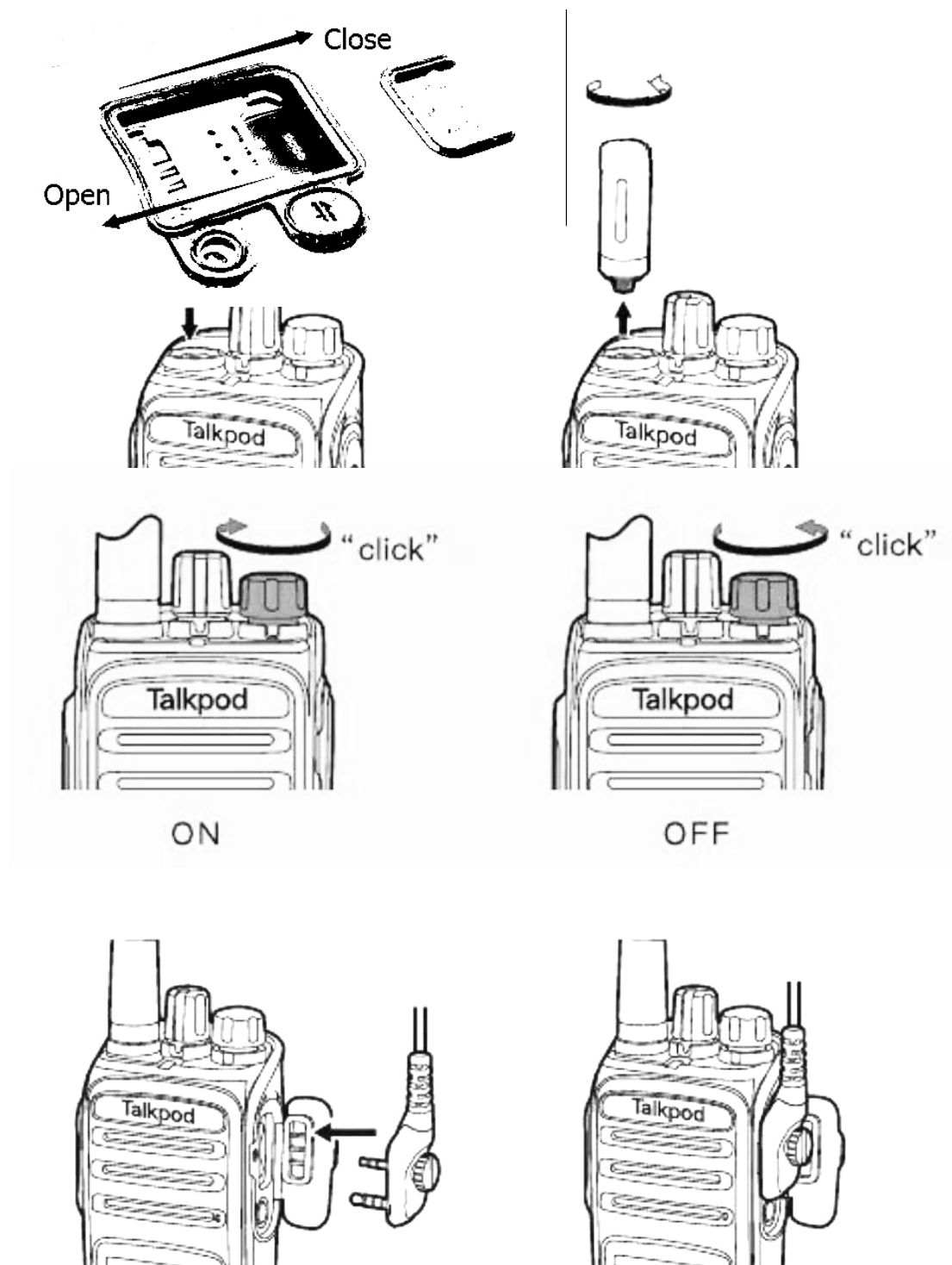

Insert the SIM Card

5. Basic Operations

Powering On/Off

Adjusting the Volume

Menu Interface and Feature Selecting

Press Okay/Menu button, use Feature Selector Knob or Navigation Button to select features.



Selecting a Group

Turn to Group Select Interface, then you can select the group directly or rotate the selector knob to select an appropriate Group. Push PTT button to talk to all the members in this group.

Group call: A call made to the group contacts.

Selecting a Member

Turn to Member Select Interface, then you can select a member on the list. Members on the list belong to the group that you chose. Push PTT button to talk to this member you selected.



Selecting a Friend

Turn to Friend Select Interface, then you can select a friend on the list. Friend list does not belong to the Group, you can have different friends from different groups.

Private call: A call made to a private contact: member call or friend

call.

GPS Information

Tick the GPS in the programming software, if the display shows a GPS mark, it means GPS has been set up.

If the GPS worked then there will be a flash icon besides the GPS mark.

SOS Button

 Program an SOS Button to the buttons on the radio. (Side Button2), press it and the radio will send an SOS signal to PC dispatcher, other radios in the same talk group and the Smart-phone APP.

6. Care and Cleanning

 To guarantee optimal performance as well as a long service life of the product, please follow the tips below

Product Care

- Do not pierce or scrape the product with any edged instruments or hard objects.
- Keep the product far away from substances that can corrode the circuit.
- Do not hold the product by its antenna or earpiece cable directly.
- Attach the accessory jack cover when the product is not in use.

Product Cleaning

Turn off the product and remove the battery before cleaning.

- Clean up the dust and fine particles on the product surface and charging piece with a clean and dry lint-free cloth or a brush regularly.
- Use neutral cleanser and a non-woven fabric to clean the keys, control knobs and front case after long-time use. Do not use chemical preparations such as stain removers, alcohol, sprays or oil preparations, so as to avoid surface case damage.
- Make sure the product is completely dry before use.

7. Troubleshooting

Phenomena	Analysis	Solution
Power-on Failure	The battery may be improperly Installed. The battery power may be used up. The battery is poorly connected due to dirtied or damaged battery contacts.	Remove the battery and reassemble it. Recharge or replace the battery. Clean the battery contacts. If the problem cannot be solved, contact your dealer or authorized service center for inspection and repair.

During receiving, the voice is weak, discontinuous or totally inactive.	Low battery voltage.	Recharge or replace the battery
	Low volume level.	Increase the volume by rotating the Volume Control knob.
	The antenna may be loosened or improperly installed.	Reassemble the antenna after turning off the radio.
	The speaker may be blocked or damaged.	Clean the surface of the speaker. If the problem cannot be solved, contact your dealer or authorized service center for inspection and repair
Unable to communicate with other members.	The network signal may not strong.	Go to some places with strong signal.
	The radio may not log in to the account.	Confirm if the account is correct and network is working to log in the account.
	The radio off line.	Go to some places with strong signal and try to log in again.
Unable to gain GPS Info	GPS may not be ticked from the programming software.	Tick GPS in the programming software and write to the radio.
	GPS may not be ticked from the platform.	Set up GPS function in the platform for the account.
	Signal is not strong indoor.	As GPS is mostly needed outdoor, it gains better signal in building roof, main road or streets.
The noise is too loud.	You may suffer from external disturbance (such as electromagnetic interference).	Stay away from equipment that may cause interference.

8. Optional Accessories

The following items are the main optional accessories for the radio. For more information of other accessories, please consult your local dealer.

Note: Use the accessories specified by Talkpod only. If not, the Company shall not be liable for any losses or damages arising out use of unauthorized accessories.

Type	SKU	Description
Antenna	TAT04	Antenna for N4 series, CDMA 800MHz
Antenna	TAT05	Antenna for N4 series, WCDMA 850/900/1800/2100
Power Adapter	TCA01	US/NA Plug, AC/DC Adapter
Power Adapter	TCA02	Euro Plug, AC/DC Adapter

Power Adapter	TCA03	UK Plug, AC/DC Adapter
Power Adapter	TCA04	Australia Plug, AC/DC Adapter
Earpiece	TEM01	2-Wire Earloop with On-MIC PTT
Earpiece	TEM02	2-Wire D-Ring Earphone with On-MIC PTT
Earpiece	TEM03	2-Wire Acoustic Tube with On-MIC PTT
Earpiece	TEM04	Earloop with In-line Microphone
Earpiece	TEM05	D-Ring Earphone with In-line Microphone
Earpiece	TEM06	Acoustic Tube with In-line Microphone
Earpiece	TEM07	3-Wire Acoustic Tube Surveillance Kit (Black)
Earpiece	TEM08	3-Wire Acoustic Tube Surveillance Kit (Beige)
Audio	TSM01	Remote Speaker Microphone
Audio	TEB01	Bluetooth Earpiece Kits for D5 Series
Carry Case	TCC01	Non-Keypad Carrying Case
Carry Case	TCC02	6-Keypad Carrying Case
Carry Case	TCC03	Full Keypad Carrying Case
Carry Case	TCC04	Multi-touch Carrying Case

RF Radiation Profile

Radio Frequency (RF) is a frequency of electromagnetic radiation in the range at which radio signals are transmitted. RF technology is widely used in communication, medicine, food processing and other fields. It may generate radiation during use.

Any Changes or modifications not expressly approved by the party responsible for compliance could void the user's authority to operate the equipment.

This device complies with part 15 of the FCC Rules. Operation is subject to the following two conditions:

- (1) This device may not cause harmful interference,
- And (2) this device must accept any interference received, including interference that may cause undesired operation.

Note: This equipment has been tested and found to comply with the limits for a Class B digital device, pursuant to part 15 of the FCC Rules. These limits are designed to provide reasonable protection against harmful interference in a residential installation. This equipment generates uses and can radiate radio frequency energy and, if not installed and used in accordance with the instructions, may cause harmful interference to radio communications. However, there is no guarantee that interference will not occur in a particular installation. If this equipment does cause harmful interference to radio or television reception, which can be determined by turning the equipment off and on, the user is encouraged to try to correct the interference by one or more of the following measures:

- Reorient or relocate the receiving antenna.
- Increase the separation between the equipment and receiver.
- Connect the equipment into an outlet on a circuit different from that to which the receiver is connected.
- Consult the dealer or an experienced radio/TV technician for help.

● RF energy will be generated only when the radio is transmitting.

The radio must be 2.5cm away from human face when transmitting. When worn on the body, always place the radio in a approved holder, holster, case, or body harness or by use of the correct clip for this product.

Use of non-approved accessories may result in exposure levels which exceed the FCC's population/uncontrolled environmental RF exposure limits.