

4.5. Modulation Characteristics

TEST APPLICABLE

According to CFR47 section 2.1047(a), for Voice Modulation Communication Equipment, the frequency response of the audio modulation circuit over a range of 100 to 5000Hz shall be measured.

TEST PROCEDURE

Modulation Limit

- 1 Configure the EUT as shown in figure 1, adjust the audio input for 60% of rated system deviation at 1 KHz using this level as a reference (0dB) and vary the input level from -20 to +20dB. Record the frequency deviation obtained as a function of the input level.
- 2 Repeat step 1 with input frequency changing to 300, 1004, 1500 and 2500Hz in sequence.

Audio Frequency Response

- 1 Configure the EUT as shown in figure 1.
- 2 Adjust the audio input for 20% of rated system deviation at 1 KHz using this level as a reference (0dB).
- 3 Vary the Audio frequency from 100 Hz to 3 KHz and record the frequency deviation.
- 4 Audio Frequency Response = 20log10 (Deviation of test frequency/Deviation of 1 KHz reference).

TEST CONFIGURATION

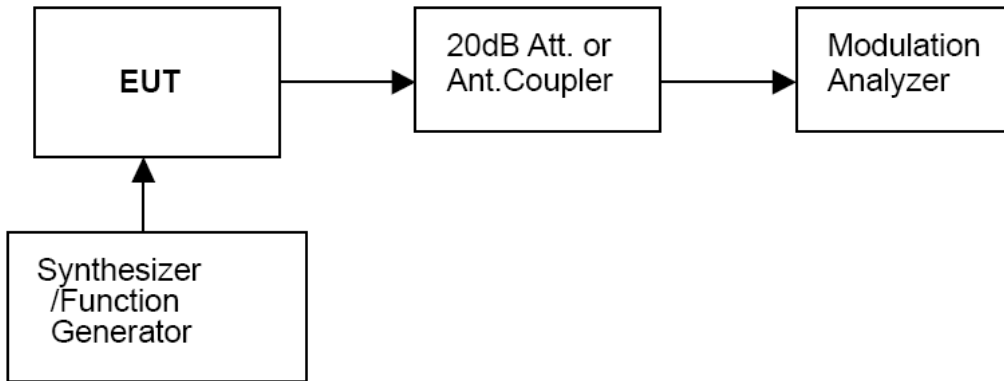

TEST RESULTS

Remark:

1. We tested Op 1 to Op 2 recorded worst case at Op 1.

Modulation Type: FM

12.5 KHz Channel Separation Op1

Modulation Level (dB)	Peak Freq. Deviation At 300 Hz (KHz)	Peak Freq. Deviation At 1004 Hz (KHz)	Peak Freq. Deviation At 1500 Hz (KHz)	Peak Freq. Deviation At 2500 Hz (KHz)
-20	0.15	0.19	0.33	0.45
-15	0.21	0.36	0.57	0.84
-10	0.29	0.55	0.79	1.47
-5	0.55	0.95	1.51	2.01
0	0.73	1.69	1.93	2.25
+5	0.94	1.97	2.02	2.25
+10	1.14	2.09	2.25	2.25
+15	1.35	2.22	2.25	2.25
+20	1.44	2.25	2.25	2.25

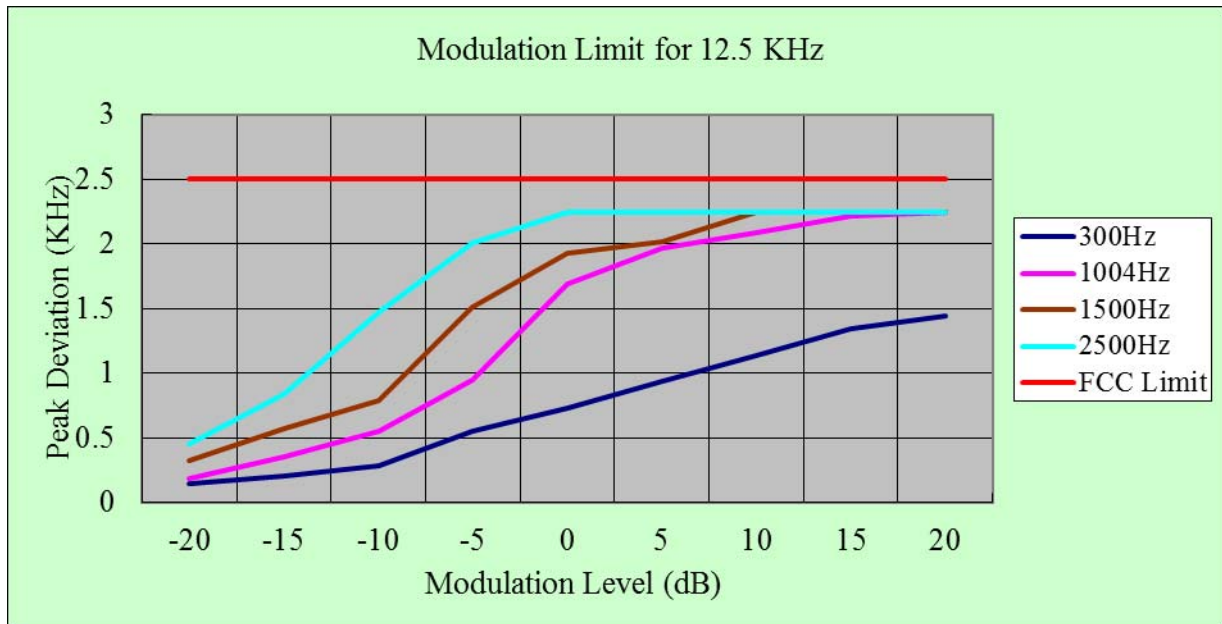

Modulation type: 4FSK

Channel bandwidth: 12.5 kHz

It is not applicable for devices which operate with the digitized voice/data modulation type.

b). Audio Frequency Response:

Rule Part No.: Part 2.1407(a) (b)

Method of Measurement:

The audio frequency response was measured in accordance with TIA/EIA Specification 603 with no exception.

A curve or equivalent data showing the frequency response of the audio modulating circuit over a range of 300-3000Hz shall be submitted and Audio Post Limiter Low Pass Filter Response from 3.0 KHz to 50KHz. However, the audio frequency response should test from 100Hz to 5.0 KHz according to FCC Part 90.

Modulation Type: FM

The audio frequency response curve is show below.

Test Audio Level (1 KHz and 20% maximum deviation) for 12.5 KHz channel separation is 2.75mV.

Note:

1. Not applicable to new standard. However, tests are conducted under FCC's recommendation.
2. The Audio Frequency Response is identical for 12.5 KHz channel separation

12.5 KHz Channel Separation Op1

Frequency (KHz)	Frequency Deviation (KHz)	1KHz Reference Deviation (KHz)	Audio Frequency Response (dB)
0.1	0.04	0.51	-22.11
0.2	0.04	0.51	-22.11
0.3	0.13	0.51	-11.87
0.4	0.18	0.51	-9.05
0.5	0.21	0.51	-7.71
0.6	0.26	0.51	-5.85
0.7	0.34	0.51	-3.52
0.8	0.42	0.51	-1.69
0.9	0.47	0.51	-0.71
1.0	0.51	0.51	0.00
1.2	0.57	0.51	0.97
1.4	0.66	0.51	2.24
1.6	0.71	0.51	2.87
1.8	0.78	0.51	3.69
2.0	0.85	0.51	4.44
2.2	1.00	0.51	5.85
2.4	1.06	0.51	6.35
2.6	1.14	0.51	6.99
2.7	1.18	0.51	7.29
2.8	1.24	0.51	7.72
3.0	1.24	0.51	7.72
3.5	1.24	0.51	7.72
4.0	0.04	0.51	-22.11
4.5	0.05	0.51	-20.17
5.0	0.05	0.51	-20.17

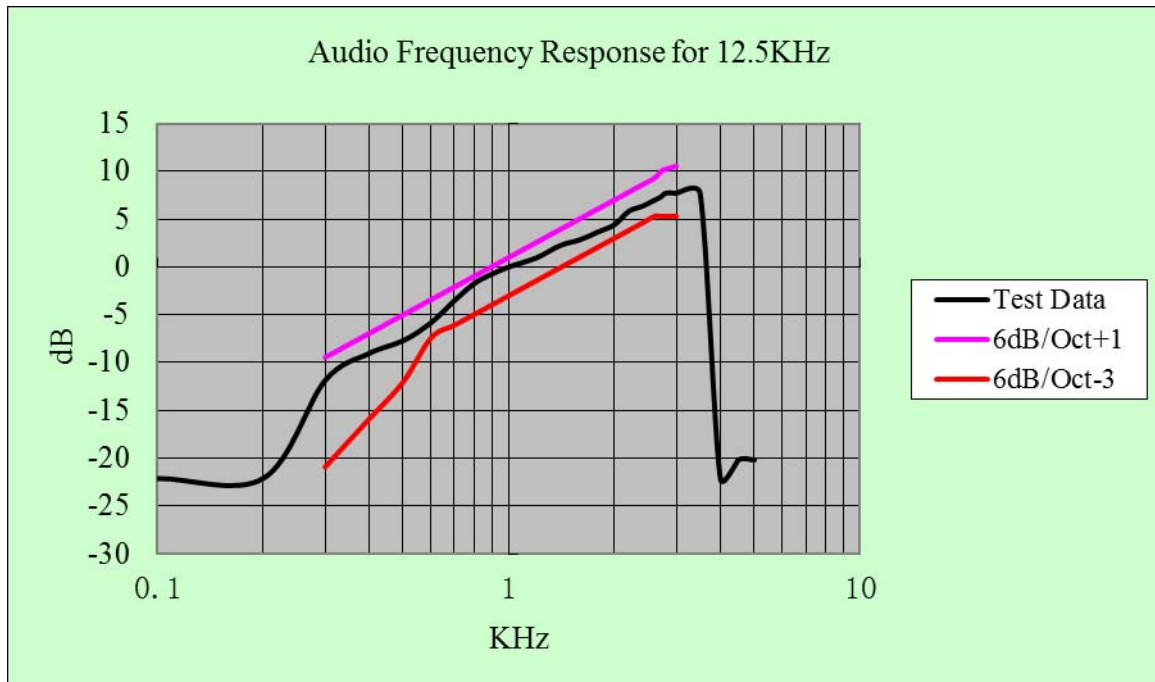

Modulation type: 4FSK

Channel bandwidth: 12.5 kHz

It is not applicable for devices which operate with the digitized voice/data modulation type.

4.6. Frequency Stability Test

TEST APPLICABLE

- 1 According to FCC Part 2 Section 2.1055 (a) (1), the frequency stability shall be measured with variation of ambient temperature from -30°C to +60°C centigrade.
- 2 According to FCC Part 2 Section 2.1055 (e) (2), for battery powered equipment, the frequency stability shall be measured with reducing primary supply voltage to the battery operating end point, which is specified by the manufacture.
- 3 Vary primary supply voltage from 85 to 115 percent of the nominal value.
- 4 According to §90.213, the frequency stability limit is 2.5 ppm for 12.5KHz channel separation

TEST PROCEDURE

The EUT was set in the climate chamber and connected to an external DC power supply. The RF output was directly connected to Spectrum Analyzer ESPI7. The coupling loss of the additional cables was recorded and taken in account for all the measurements. After temperature stabilization (approx. 20 min for each stage), the frequency for the lower, the middle and the highest frequency range was recorded. For Frequency stability Vs. Voltage the EUT was connected to a DC power supply and the voltage was adjusted in the required ranges. The result was recorded.

TEST CONFIGURATION

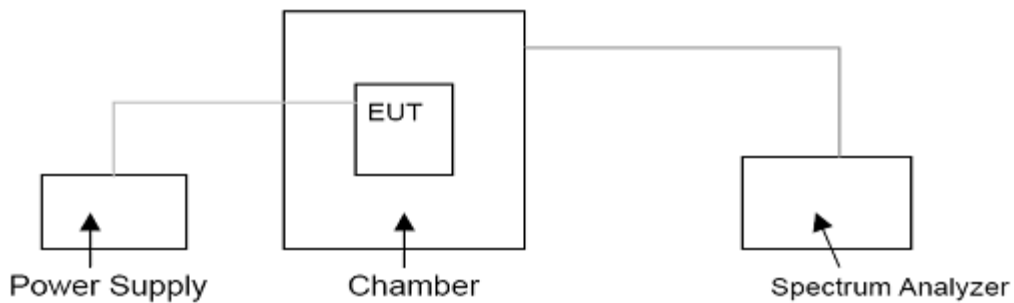

TEST LIMITS

According to 90.213, Transmitters used must have minimum frequency stability as specified in the following table.

Frequency Range (MHz)	Channel Bandwidth (KHz)	Frequency Tolerance (ppm)		
		Fixed and Base Stations	Mobile Stations	
			> 2 W	≤ 2 W
150-174 MHz	6.25	1.0	2.0	2.0
	12.5	2.5	5.0	5.0
	25	5.0	5.0	50.0*
421-512 MHz	6.25	0.5	1.0	1.0
	12.5	1.5	2.5	2.5
	25	2.5	5.0	5.0

- Stations operating in the 154.45 to 154.49 MHz or the 173.2 to 173.4 MHz bands must have a frequency stability of 5 ppm.
- Paging transmitters operating on paging-only frequencies must operate with frequency stability of 5 ppm in the 150-174 MHz band and 2.5 ppm in the 421-512 MHz band.

TEST RESULTS

Remark:

1. We tested Op 1 to Op 4, recorded worst case at Op 1 and Op 3.

Operation Mode	Channel Separation	Test conditions		Frequency error (ppm)		
		Voltage(V)	Temp(°C)	406.125	456.125	469.975
Op1	12.5KHz	7.40 V	-30	0.36	0.14	0.48
			-20	0.45	0.61	0.82
			-10	0.65	0.36	0.92
			0	0.95	0.15	0.52
			10	0.48	0.49	0.54
			20	0.84	0.21	0.61
			30	0.62	0.56	0.31
			40	0.15	0.59	0.26
			50	0.48	0.59	0.14
		6.29 (85% Rated)	20	0.59	0.89	0.92
8.51(115% Rated)	20	0.31	0.48	0.15		
Limit			2.5 ppm			
Test Results			PASS			

Operation Mode	Channel Separation	Test conditions		Frequency error (ppm)		
		Voltage(V)	Temp(°C)	406.125	456.125	469.975
Op3	12.5KHz	7.40 V	-30	0.65	0.48	0.48
			-20	0.12	0.15	0.51
			-10	0.21	0.62	0.62
			0	0.23	0.26	0.26
			10	0.33	0.26	0.26
			20	0.26	0.45	0.32
			30	0.15	0.48	0.31
			40	0.45	0.65	0.14
			50	0.69	0.51	0.17
		6.29 (85% Rated)	20	0.62	0.23	0.61
8.51(115% Rated)	20	0.15	0.35	0.15		
Limit			2.5 ppm			
Test Results			PASS			

4.7. Maximum Transmitter Power

TEST APPLICABLE

Per FCC Part 2.1046 and Part 90.205: Maximum ERP is dependent upon the station's antenna HAAT and required service area.

Per RSS-119 Section 5.4 and 5.4.1: The output power shall be within ± 1.0 dB of the manufacturer's rated power. Typical transmitter output powers are 110 watts for base and/or fixed stations (paging transmitters excepted), and 30 watts for mobile stations. Higher powers may be certified, but it should be noted that mobile stations are normally only licensed up to 30 watts. See the SRSP relevant to the operating frequency for equipment power limits.

TEST PROCEDURE

Measurements shall be made to establish the radio frequency power delivered by the transmitter the standard output termination. The power output shall be monitored and recorded and no adjustment shall be made to the transmitter after the test has begun, except as noted below:

If the power output is adjustable, measurements shall be made for the highest and lowest power levels.

The EUT connect to the Receiver through 20 dB attenuator.

Measurement with Spectrum Analyzer ESPI7 for conducted measurement, external power supply with 7.40 V stabilized supply voltage.

TEST CONFIGURATION



The EUT was directly connected to a RF Communication
Test set by a 20 dB attenuator

TEST RESULTS

Modulation Type	Channel Separation	Operation Mode	Test Channel	Test Frequency (MHz)	Test Results (dBm)
Analog/FM	12.5KHz	Op 1	Ch1	406.125	36.41
			Ch2	456.125	36.75
			Ch3	469.975	36.62
		Op 2	Ch1	406.125	30.13
			Ch2	456.125	30.39
			Ch3	469.975	29.57
Digital/4FSK	12.5KHz	Op 3	Ch4	406.125	36.66
			Ch5	456.125	36.22
			Ch6	469.975	36.48
		Op 4	Ch4	406.125	29.93
			Ch5	456.125	30.56
			Ch6	469.975	30.28
Limit	The limit is dependent upon the station's antenna HAAT and required service area.				
Test Results	PASS				

Plots of Transmitter Power Measurement

Modulation Type	Channel Separation	Operation Mode	Test Channel	Test Frequency (MHz)	Rated Power (Watt)	Measurement (dBm)	Limit	Results
FM	12.5KHz	Op 1	Ch1	406.125	4.0	36.41	Varies	PASS

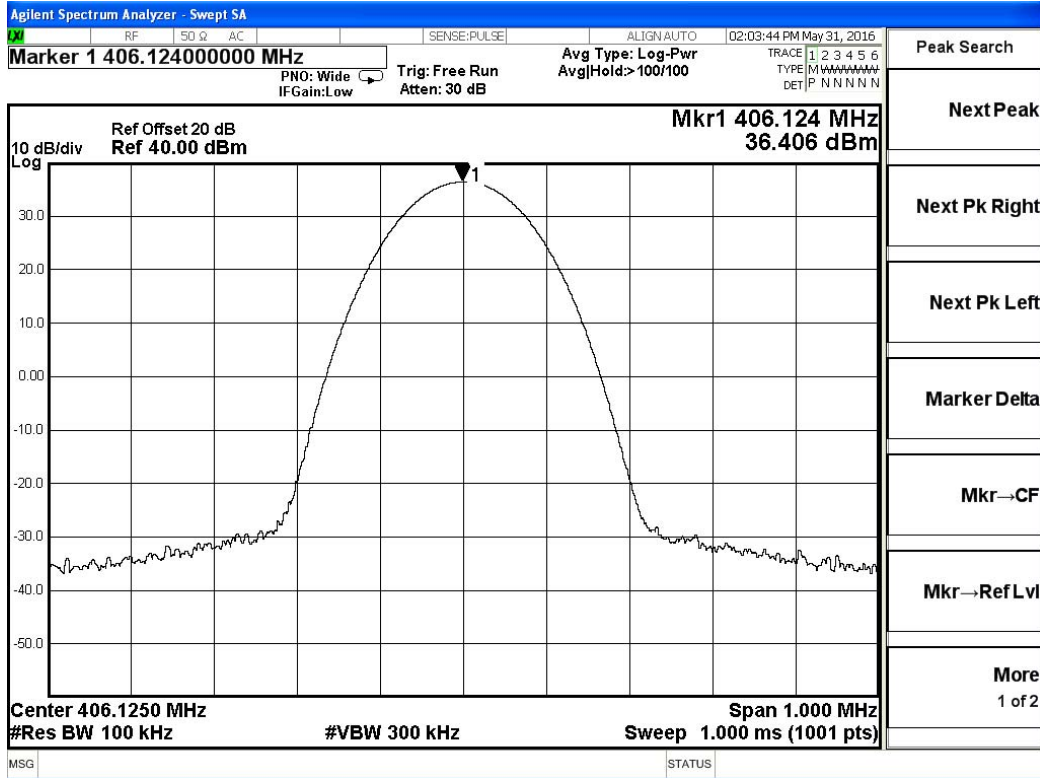

Modulation Type	Channel Separation	Operation Mode	Test Channel	Test Frequency (MHz)	Rated Power (Watt)	Measurement (dBm)	Limit	Results
FM	12.5KHz	Op 1	Ch2	456.125	4.0	36.75	Varies	PASS

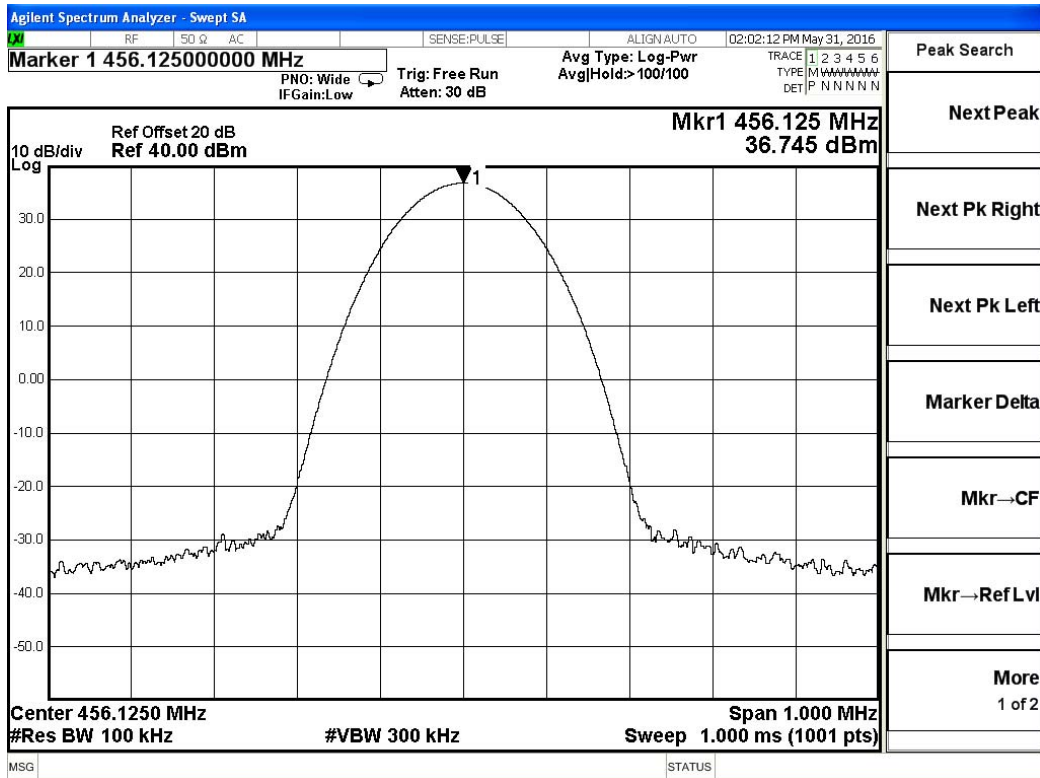

Modulation Type	Channel Separation	Operation Mode	Test Channel	Test Frequency (MHz)	Rated Power (Watt)	Measurement (dBm)	Limit	Results
FM	12.5KHz	Op 1	Ch3	469.975	4.0	36.62	Varies	PASS

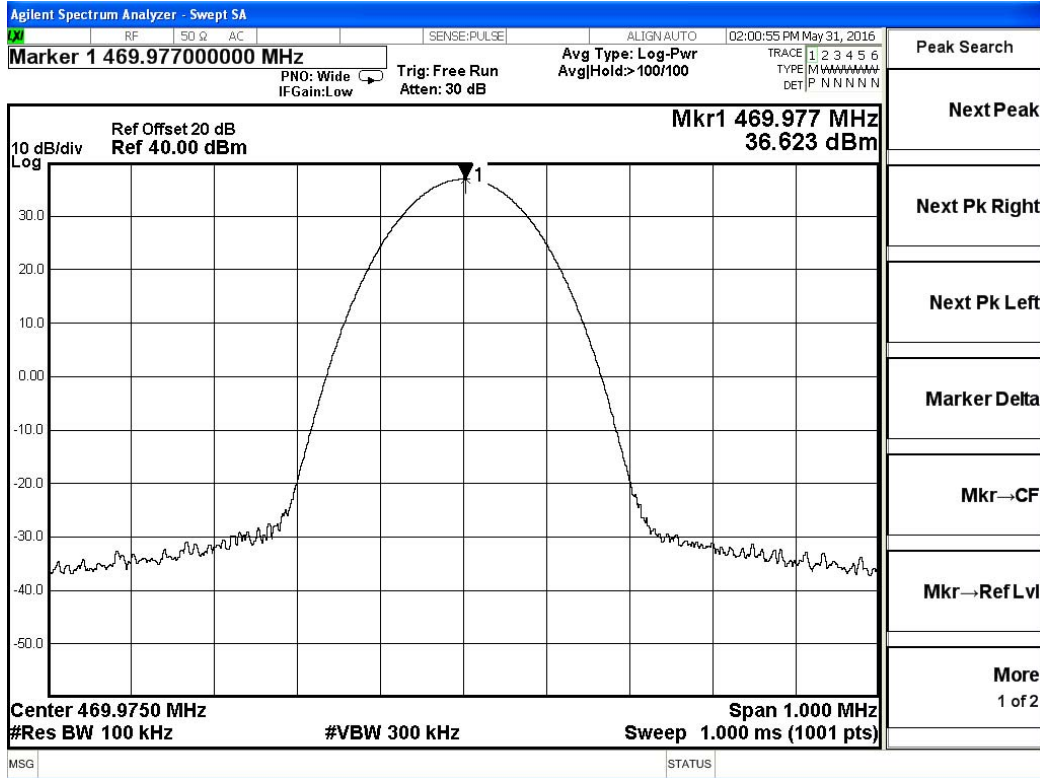

Modulation Type	Channel Separation	Operation Mode	Test Channel	Test Frequency (MHz)	Rated Power (Watt)	Measurement (dBm)	Limit	Results
FM	12.5KHz	Op 2	Ch1	406.125	1	30.13	Varies	PASS

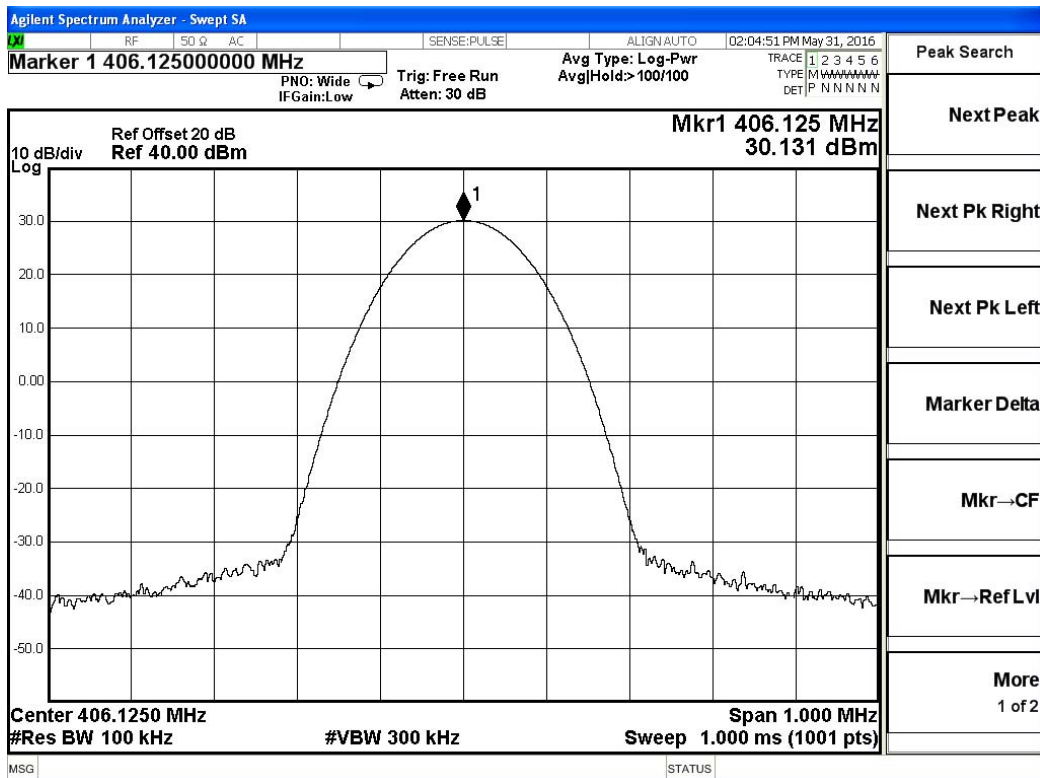

Modulation Type	Channel Separation	Operation Mode	Test Channel	Test Frequency (MHz)	Rated Power (Watt)	Measurement (dBm)	Limit	Results
FM	12.5KHz	Op 2	Ch2	456.975	1.0	30.39	Varies	PASS

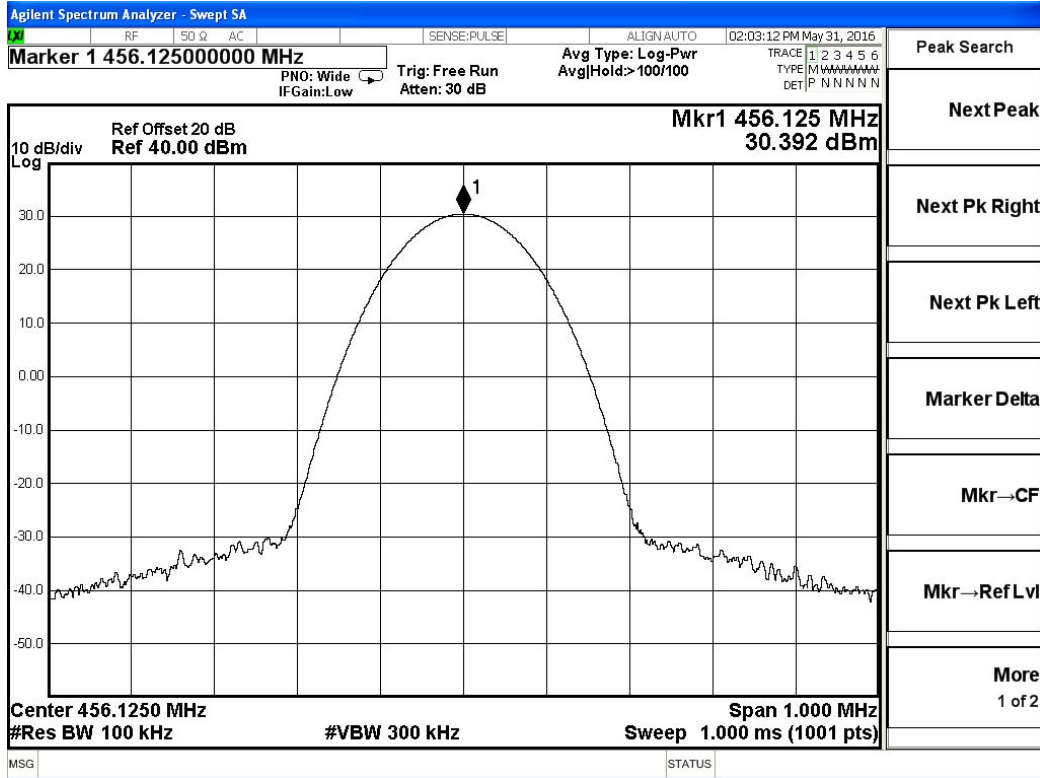

Modulation Type	Channel Separation	Operation Mode	Test Channel	Test Frequency (MHz)	Rated Power (Watt)	Measurement (dBm)	Limit	Results
FM	12.5KHz	Op 2	Ch3	469.975	1.0	29.57	Varies	PASS

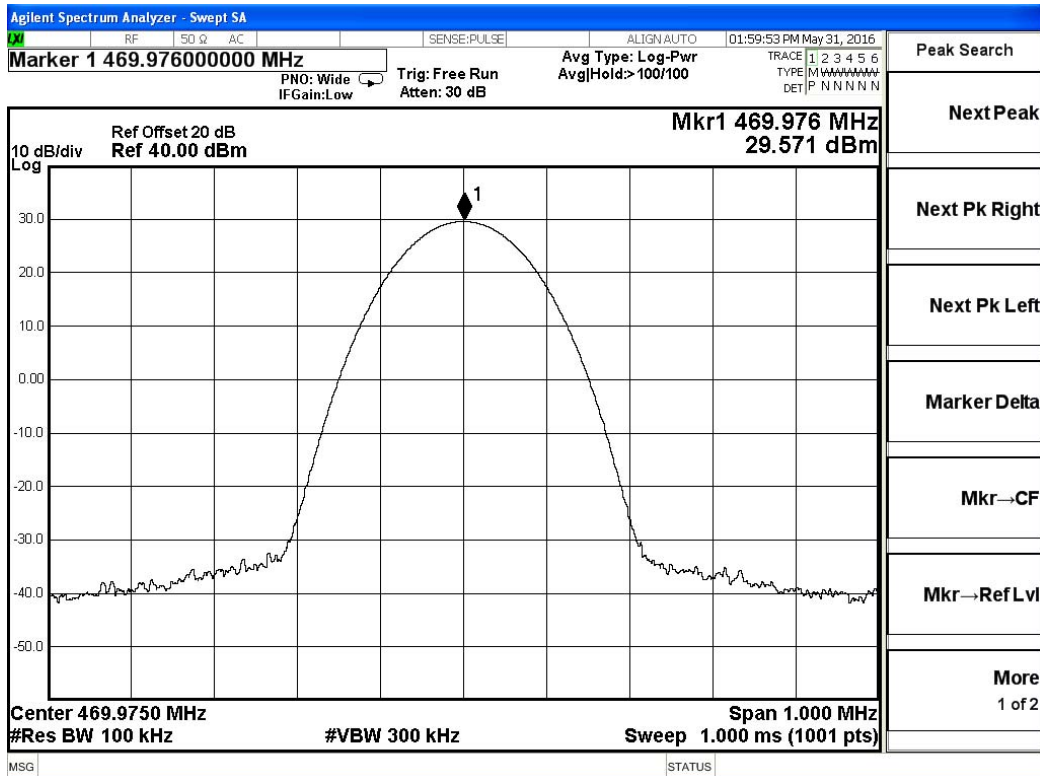

Modulation Type	Channel Separation	Operation Mode	Test Channel	Test Frequency (MHz)	Rated Power (Watt)	Measurement (dBm)	Limit	Results
4FSK	12.5KHz	Op 3	Ch4	406.125	4.0	36.66	Varies	PASS

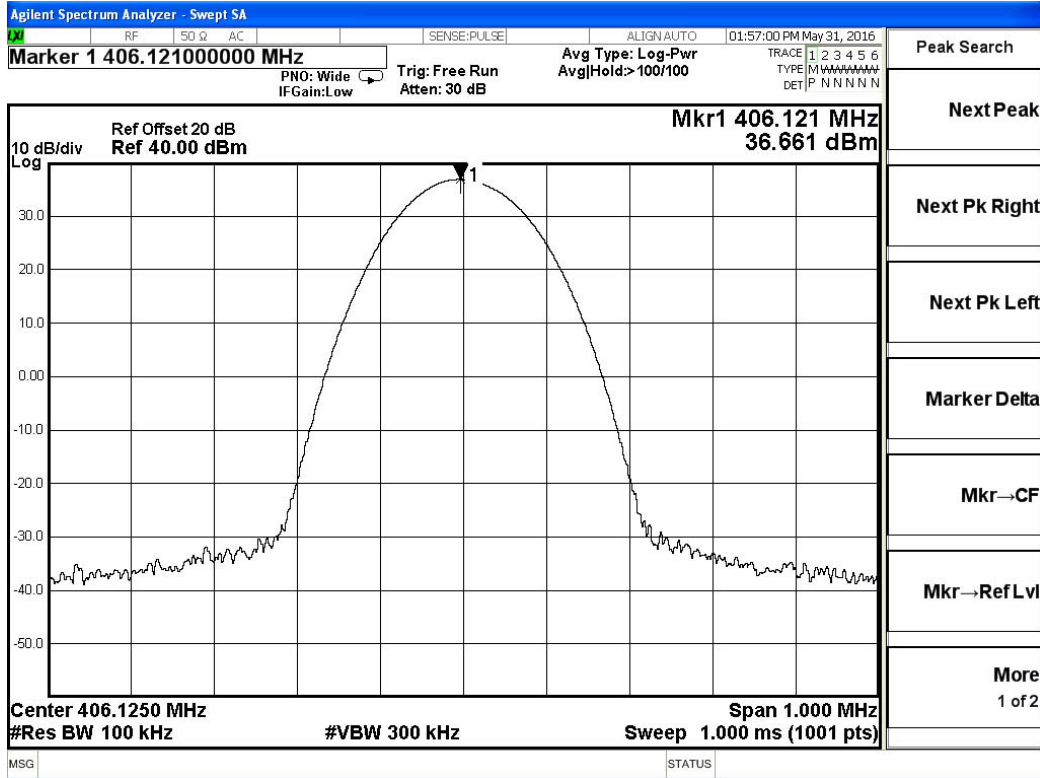

Modulation Type	Channel Separation	Operation Mode	Test Channel	Test Frequency (MHz)	Rated Power (Watt)	Measurement (dBm)	Limit	Results
4FSK	12.5KHz	Op 3	Ch5	456.125	4.0	36.22	Varies	PASS

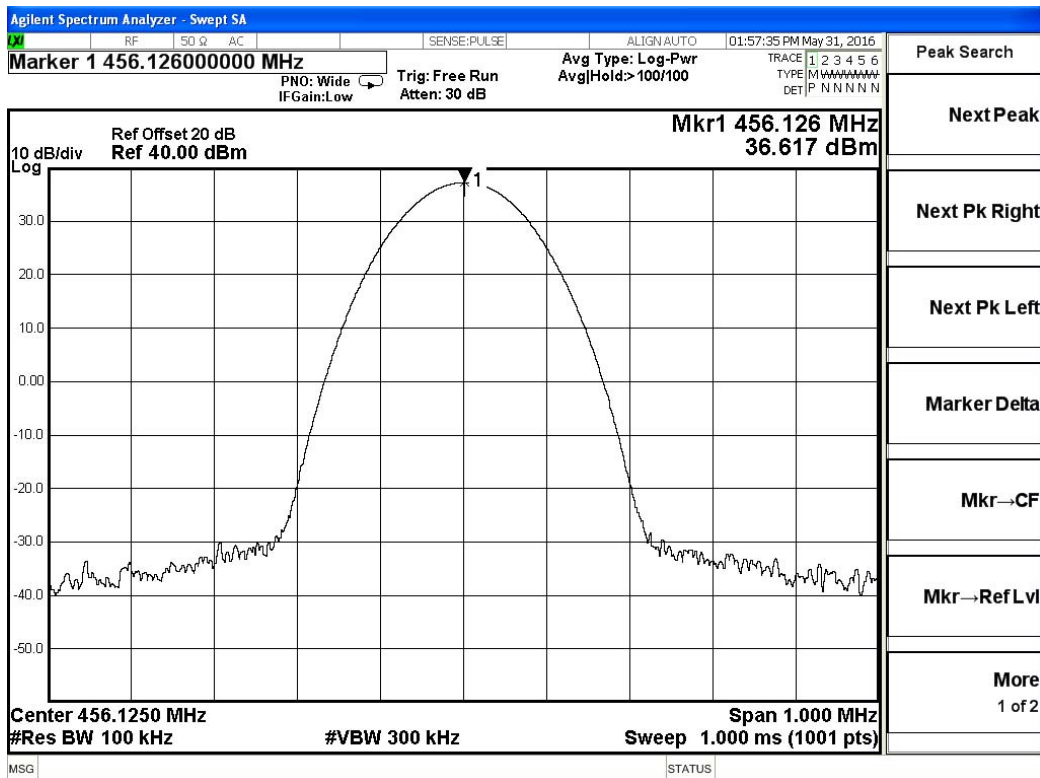

Modulation Type	Channel Separation	Operation Mode	Test Channel	Test Frequency (MHz)	Rated Power (Watt)	Measurement (dBm)	Limit	Results
4FSK	12.5KHz	Op 3	Ch6	469.975	4.0	36.48	Varies	PASS

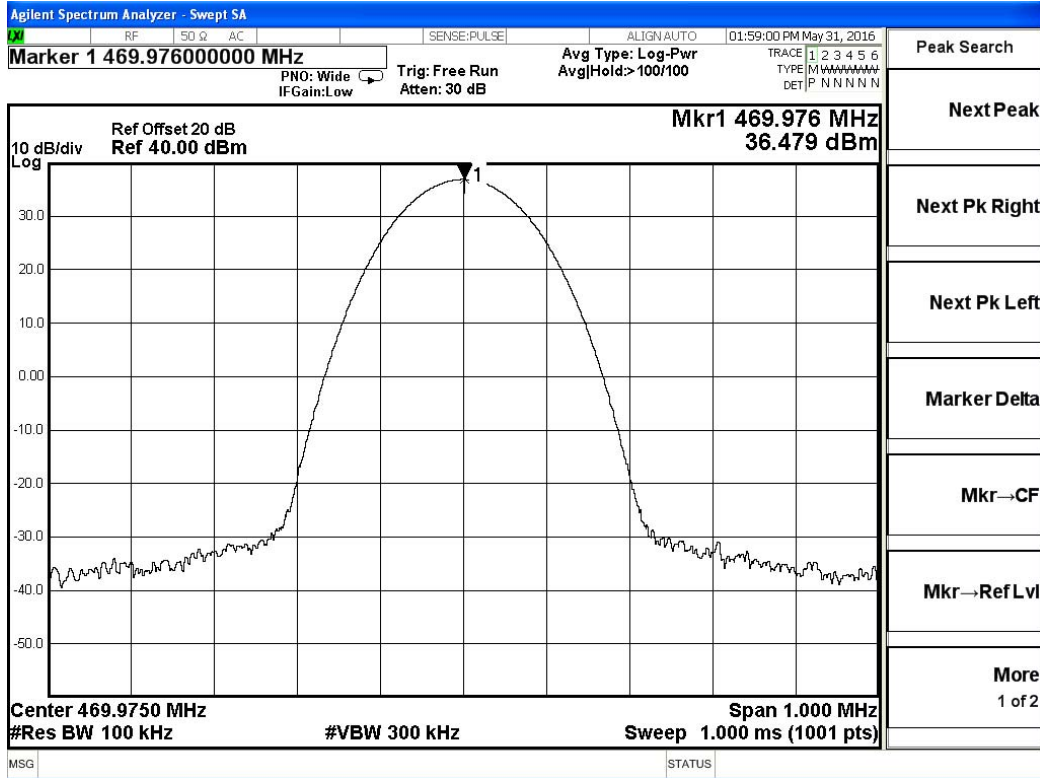

Modulation Type	Channel Separation	Operation Mode	Test Channel	Test Frequency (MHz)	Rated Power (Watt)	Measurement (dBm)	Limit	Results
4FSK	12.5KHz	Op 4	Ch4	406.125	1.0	29.93	Varies	PASS

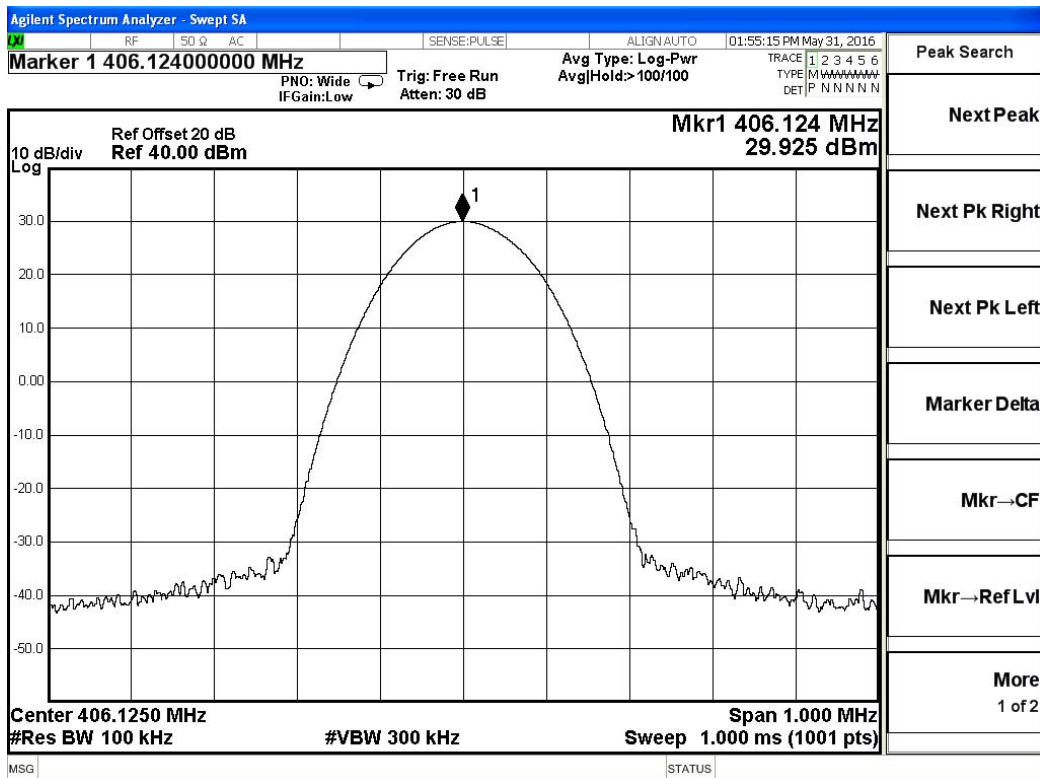

Modulation Type	Channel Separation	Operation Mode	Test Channel	Test Frequency (MHz)	Rated Power (Watt)	Measurement (dBm)	Limit	Results
4FSK	12.5KHz	Op 4	Ch5	456.125	1.0	30.56	Varies	PASS

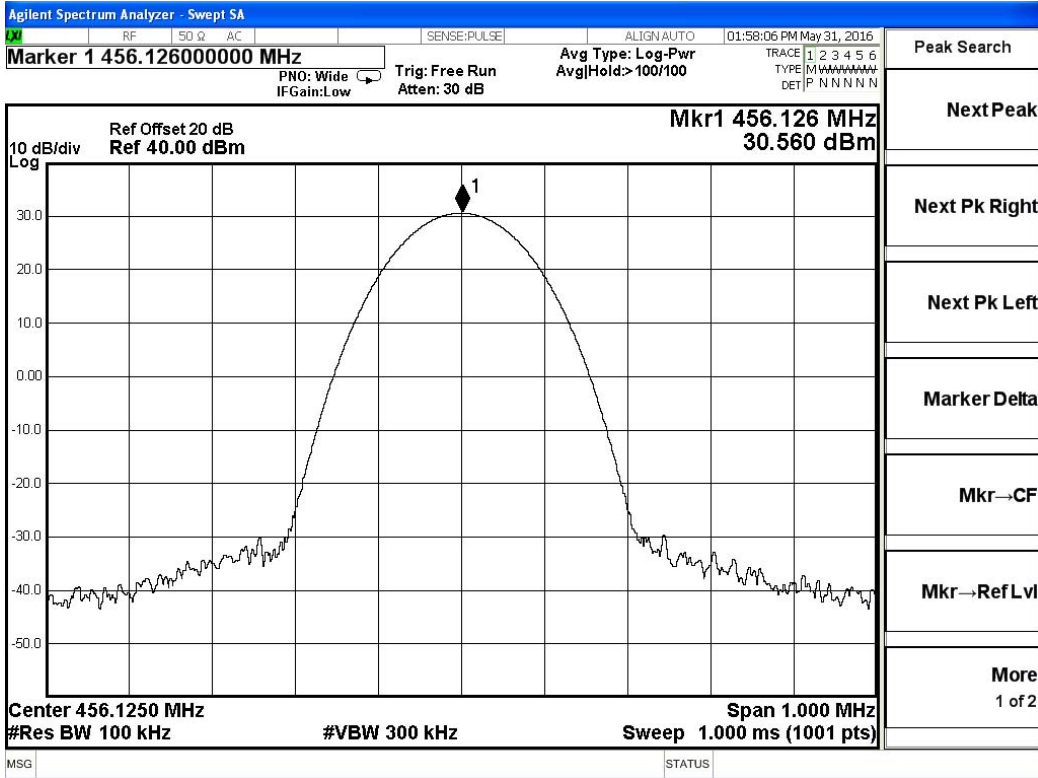

Modulation Type	Channel Separation	Operation Mode	Test Channel	Test Frequency (MHz)	Rated Power (Watt)	Measurement (dBm)	Limit	Results
4FSK	12.5KHz	Op 4	Ch6	469.975	1.0	30.28	Varies	PASS

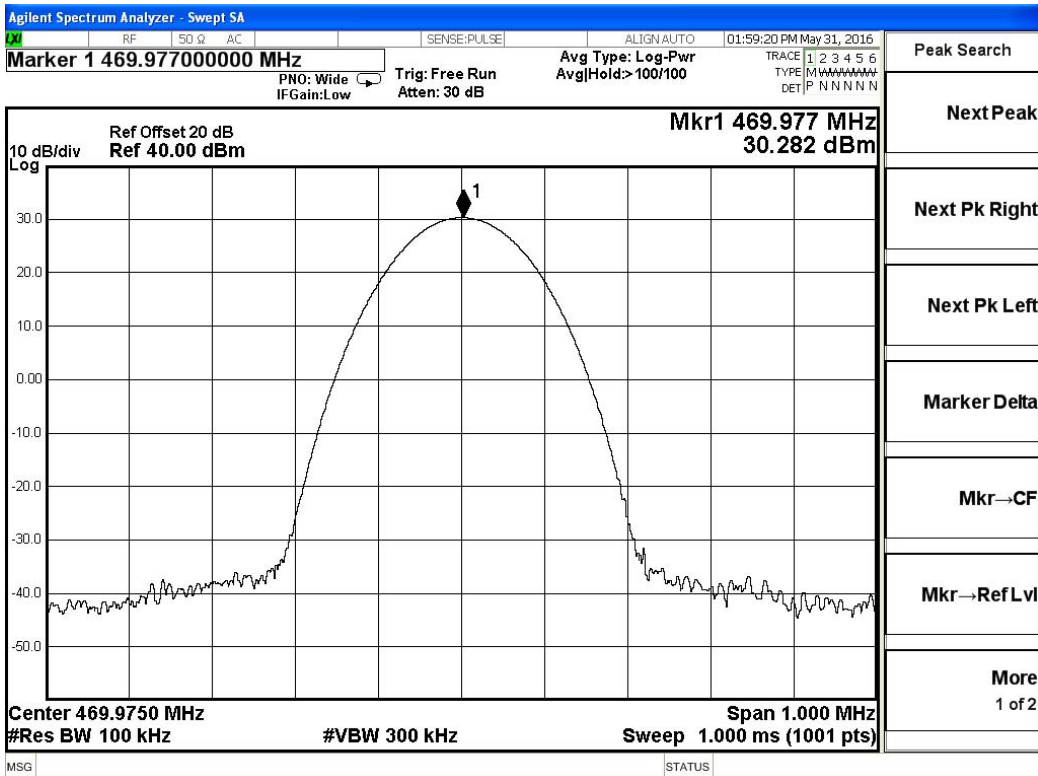

4.8. Transmitter Frequency Behavior

TEST APPLICABLE

Section 90.214

Transient frequencies must be within the maximum frequency difference limits during the time intervals indicated:

Time intervals ^{1, 2}	Maximum frequency difference ³	All equipment	
		150 to 174 MHz	421 to 512MHz
Transient Frequency Behavior for Equipment Designed to Operate on 25 KHz Channels			
t ₁ ⁴	± 25.0 KHz	5.0 ms	10.0 ms
t ₂	± 12.5 KHz	20.0 ms	25.0 ms
t ₃ ⁴	± 25.0 KHz	5.0 ms	10.0 ms
Transient Frequency Behavior for Equipment Designed to Operate on 12.5 KHz Channels			
t ₁ ⁴	± 12.5 KHz	5.0 ms	10.0 ms
t ₂	± 6.25 KHz	20.0 ms	25.0 ms
t ₃ ⁴	± 12.5 KHz	5.0 ms	10.0 ms
Transient Frequency Behavior for Equipment Designed to Operate on 6.25 KHz Channels			
t ₁ ⁴	±6.25 KHz	5.0 ms	10.0 ms
t ₂	±3.125 KHz	20.0 ms	25.0 ms
t ₃ ⁴	±6.25 KHz	5.0 ms	10.0 ms

1. t_{on} is the instant when a 1 KHz test signal is completely suppressed, including any capture time due to phasing.
t₁ is the time period immediately following t_{on}.
t₂ is the time period immediately following t₁.
t₃ is the time period from the instant when the transmitter is turned off until t_{off}.
t_{off} is the instant when the 1 KHz test signal starts to rise.
2. During the time from the end of t₂ to the beginning of t₃, the frequency difference must not exceed the limits specified in § 90.213.
3. Difference between the actual transmitter frequency and the assigned transmitter frequency.
4. If the transmitter carrier output power rating is 6 watts or less, the frequency difference during this time period may exceed the maximum frequency difference for this time period.

TEST CONFIGURATION

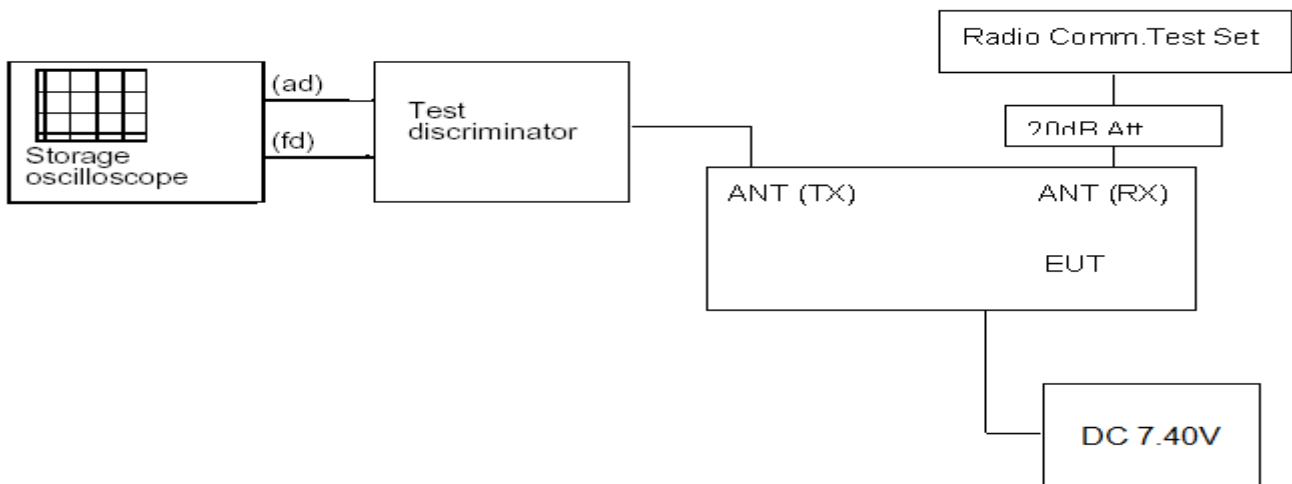

TEST PROCEDURE

According to TIA/EIA-603 2.2.19 requirement.

TEST RESULTS

Please refer to the following plots.

Modulation Type: FM

Transmitter Frequency Behavior @ 12.5 KHz Channel Separation-----Off – On

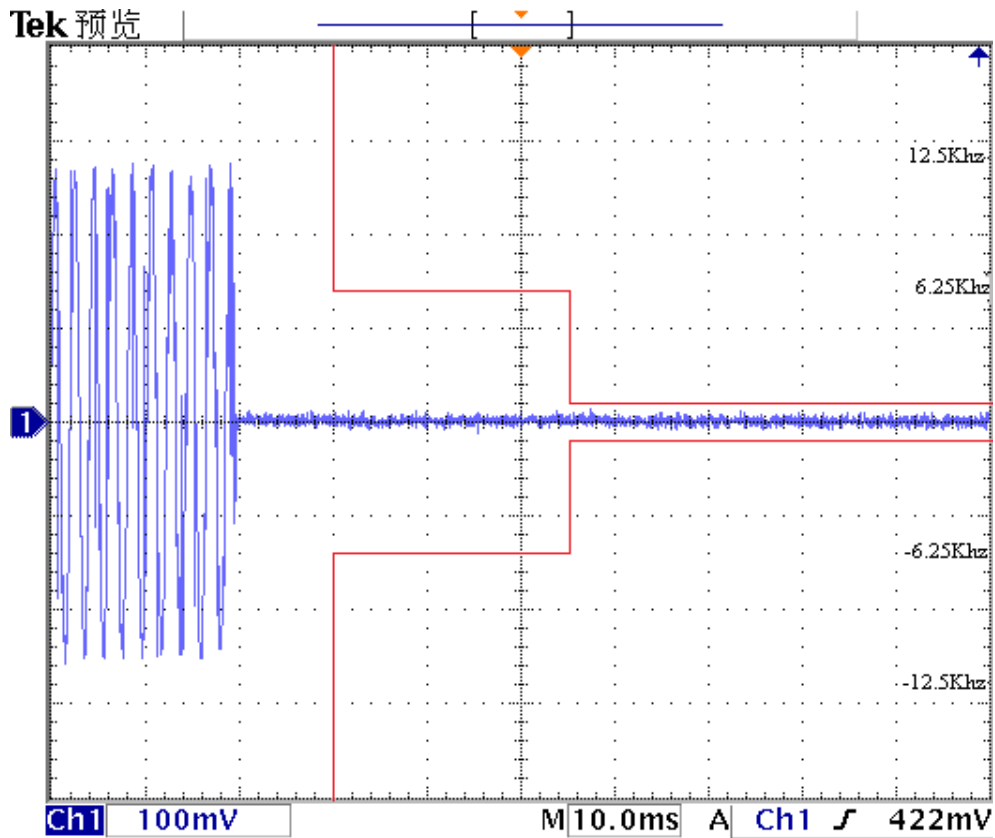

Transmitter Frequency Behavior @ 12.5 KHz Channel Separation-----On – Off

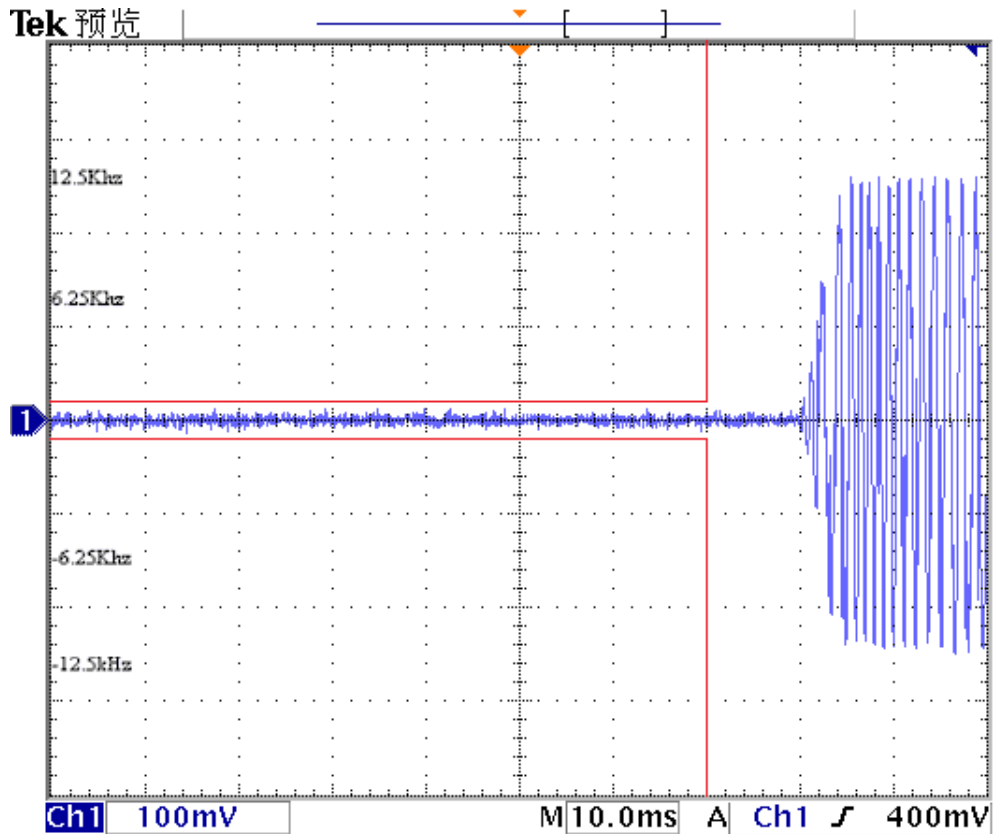

Modulation Type: 4FSK

Transmitter Frequency Behavior @ 12.5 KHz Channel Separation-----Off – On

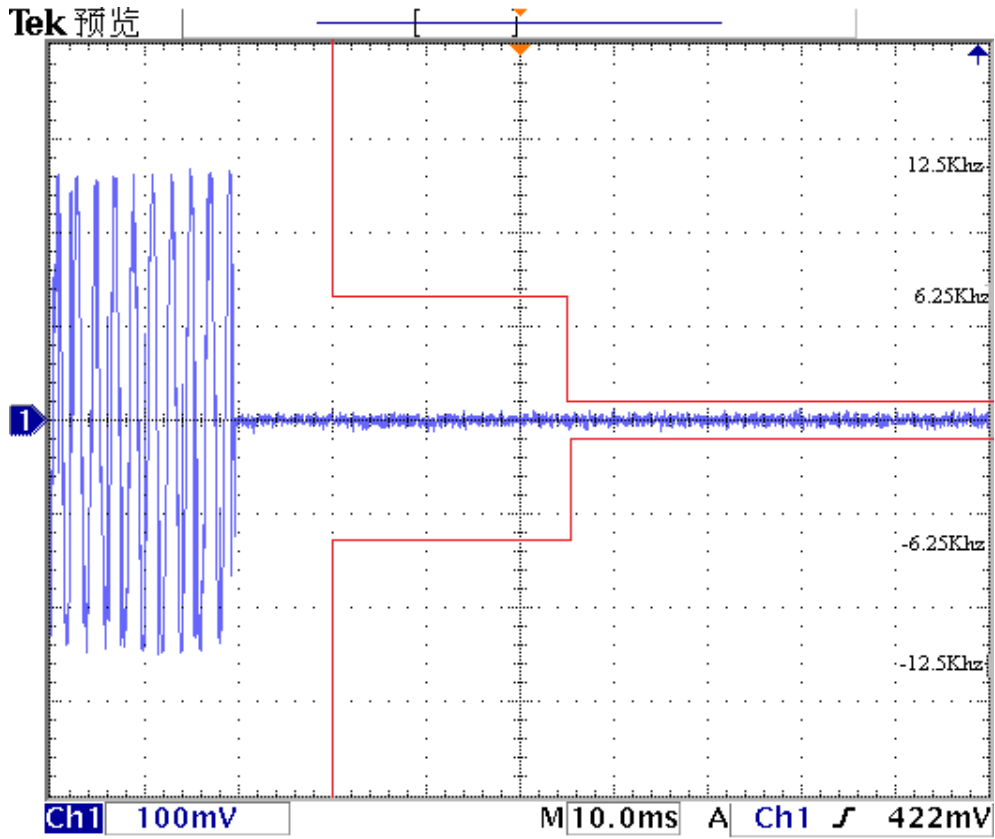

Transmitter Frequency Behavior @ 12.5 KHz Channel Separation-----On – Off

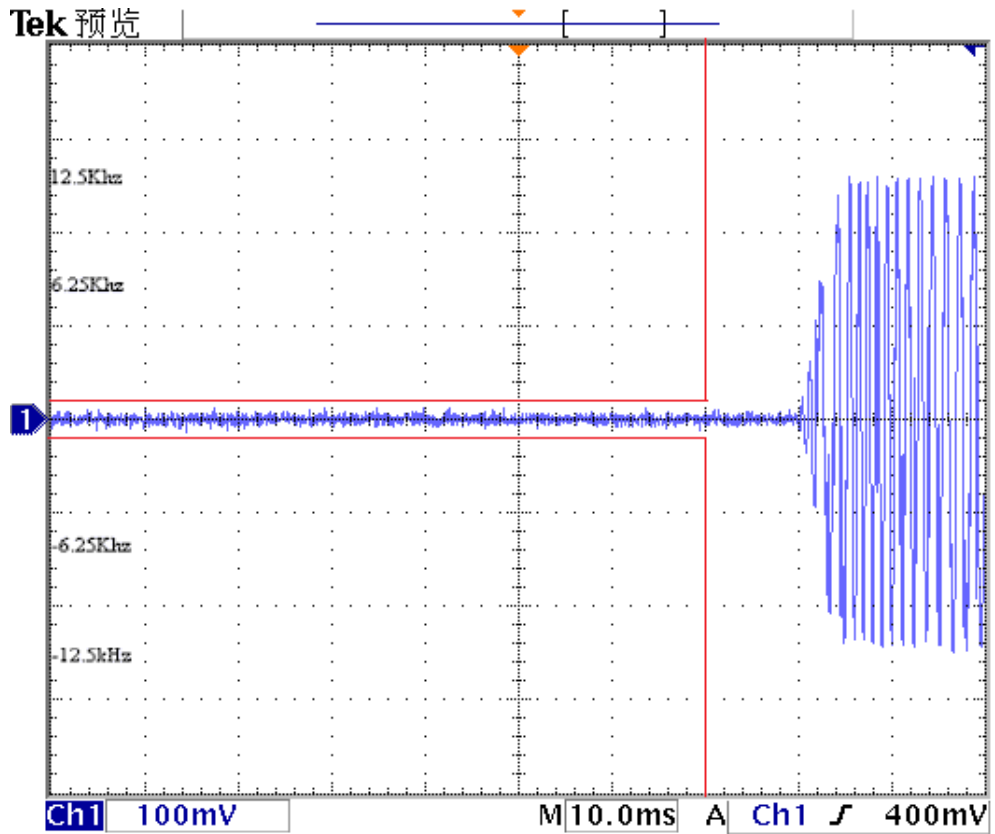

5. LIST OF MEASURING EQUIPMENT

AC Power Conducted Emission				
Name of Equipment	Manufacturer	Model	Serial Number	Cal Date
Artificial Mains	MESS Tec	NNB-2/16Z	99079	June 18,2015
EMI Test Receiver	R&S	ESCS 30	100174	June 18,2015
EMI Test Software	Audix	E3	N/A	N/A
RF COMMUNICATION TEST SET	HP	8920A	3813A10245	June 19,2015

Modulation Characteristic				
Name of Equipment	Manufacturer	Model	Serial Number	Cal Date
RF COMMUNICATION TEST SET	HP	8920A	3813A10245	June 19,2015

Frequency Stability				
Name of Equipment	Manufacturer	Model	Serial Number	Cal Date
RF COMMUNICATION TEST SET	HP	8920A	3813A10245	June 19,2015
Signal Generator	Rohde&Schwarz	SMR40	10016	July 16, 2015
Climate Chamber	Giant Force	GTH-225-20-S	MAB0103-00	June 18,2015

Maximum Transmitter Power & Spurious Emission On Antenna Port & Occupied Bandwidth & Emission Mask				
Name of Equipment	Manufacturer	Model	Serial Number	Cal Date
Receiver	Rohde&Schwarz	ESPI 7	125590	June 19,2015
RF COMMUNICATION TEST SET	HP	8920A	3813A10245	June 19,2015
High-Pass Filter	Anritsu	MP526B	6220875288	July 16, 2015
High-Pass Filter	Anritsu	MP526D	6220878442	July 16, 2015

Transient Frequency Behavior				
Name of Equipment	Manufacturer	Model	Serial Number	Cal Date
Signal Generator	Rohde&Schwarz	SMR40	10016	July 16, 2015
Storage Oscilloscope	Tektronix	TDS3054B	B033154	July 17, 2015
RF COMMUNICATION TEST SET	HP	8920A	3813A10245	June 19,2015

Transmitter Radiated Spurious Emission				
Name of Equipment	Manufacturer	Model	Serial Number	Cal Date
Receiver	Rohde&Schwarz	ESPI 7	125590	June 19,2015
EMI Test Software	Audix	E3	N/A	N/A
RF COMMUNICATION TEST SET	HP	8920A	3813A10245	June 19,2015
HORN ANTENNA	EMCO	3115	6741	June 10, 2015
HORN ANTENNA	EMCO	3115	6829	June 10, 2015
By-log Antenna	SCHWARZBECK	VULB9163	9163-470	June 10, 2015
By-log Antenna	SCHWARZBECK	VULB9163	9163-498	May 29, 2016
High-Pass Filter	Anritsu	MP526B	6220875288	July 16, 2015
High-Pass Filter	Anritsu	MP526D	6220878442	July 16, 2015

The calibration interval was one year.

.....The End of Report.....