

Technical Description and User Manual

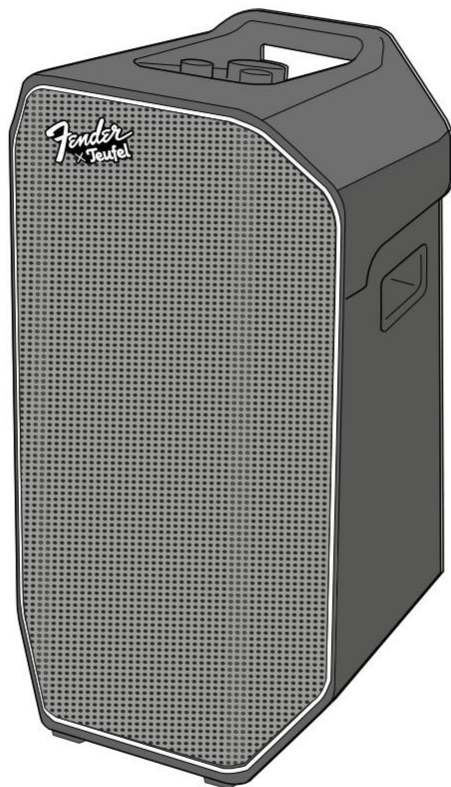

FENDER® x TEUFEL

ROCKSTER® AIR 2

Bluetooth® speaker

**Fender®
x Teufel**

Inhaltsverzeichnis

Basic notes and information.....	3	Playback sources (source)	17
For your information	3	AUX playback (analogue).....	17
Validity of the user manual	3	INSTRUMENT IN	18
FCC statement.....	4	MIC · LINE IN.....	19
Data protection and		PARTY LINK.....	20
advertising declaration.....	5	PARTY LINK over Bluetooth®.....	20
Original packaging	5	PARTY LINK via cable connection...21	
Complaint	5	Battery.....	23
Contact.....	5	Charging the battery	23
Safety.....	6	Displaying the charge level.....	24
Intended use.....	6	Remove and insert battery	24
Explanation of warnings	6	Remove battery	24
Scope of supply	7	Insert battery.....	25
Operating and display elements	8	ECO mode	26
Connections.....	10	Activate ECO mode	26
Start-up	12	Deactivate ECO mode	26
Carrying and setting up.....	12	Deactivating and	
Connection.....	12	activating signal tones.....	26
Operation.....	13	Connecting external batteries	27
Switching on and off.....	13	Using a power bank	28
Bluetooth®.....	14	Power bank functions	
Coupling devices (pairing).....	14	(during mains operation)	28
Disconnecting the Bluetooth®		Power bank functions	
connection	14	(during battery operation).....	28
Deleting the Bluetooth® list.....	14	Auto Power /	
Adjusting the volume	15	Network Standby mode	29
Mute (only in AUX mode).....	15	Activate Auto Power ON /	
Playback.....	15	Standby.....	29
Pausing and starting playback	15	Deactivate Auto Power ON.....	29
Playback next track		Standby mode.....	29
(Bluetooth®mode)	15	Cleaning and care.....	30
Adjusting the bass level	16	Storage	30
Adjusting the Treble level	16	Troubleshooting.....	31
		Perform a hardware reset.....	32
		Technical data	33

Basic notes and information

For your information

The information in this document is subject to change without notice and does not constitute any obligation on the part of Lautsprecher Teufel GmbH.

No part of these user manuals may be reproduced, transmitted in any form or by any means electronically, mechanically, by photocopying or by recording without the prior written permission of Lautsprecher Teufel GmbH.

© Lautsprecher Teufel GmbH

FENDER® x ROCKSTER® AIR 2 UM EN V0.1 PD

Validity of the user manual

The user manual applies exclusively to the **ROCKSTER® AIR 2** speaker, hereinafter also referred to as the “speaker”.

Trademark

© All trademarks are the property of their respective owners and any use by Lautsprecher Teufel is under licence.

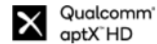
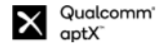

Bluetooth® is a registered trademark of the Bluetooth SIG, Inc.

Qualcomm® aptX™ and Qualcomm® aptX™ HD are products from Qualcomm Technologies International, Ltd.

Qualcomm® is a trademark of Qualcomm Incorporated, registered in the U.S. and other countries.

aptX™ is a trademark of Qualcomm Technologies International, Ltd., registered in the USA and other countries.

FCC statement

This device complies with Part 15 of the FCC Rules. Operation is subject to the following two conditions:

- (1) this device may not cause harmful interference, and
- (2) this device must accept any interference received, including interference that may cause undesired operation.

This equipment has been tested and found to comply with the limits for a Class B digital device, pursuant to Part 15 of the FCC Rules. These limits are designed to provide reasonable protection against harmful interference in a residential installation.

This equipment generates, uses and can radiate radio frequency energy and, if not installed and used in accordance with the instructions, may cause harmful interference to radio communications. However, there is no guarantee that interference will not occur in a particular installation. If this equipment does cause harmful interference to radio or television reception, which can be determined by turning the equipment off and on, the user is encouraged to try to correct the interference by one or more of the following measures:

- Reorient or relocate the receiving antenna.
- Increase the separation between the equipment and receiver.
- Connect the equipment into an outlet on a circuit different from that to which the receiver is connected.
- Consult the dealer or an experienced radio/TV technician for help.

This device complies with FCC radiation exposure limits set forth for an uncontrolled environment and it also complies with Part 15 of the FCC RF Rules. This equipment must be installed and operated in accordance with provided instructions and the antenna(s) used for this transmitter must be installed to provide a separation distance of at least 20 cm from all persons and must not be co-located or operating in conjunction with any other antenna or transmitter. End-users and installers must be provided with antenna installation instructions and consider removing the no-collocation statement.

Caution!

Any changes or modifications not expressly approved by the party responsible for compliance could void the user's authority to operate the equipment.

Data protection and advertising declaration

Lautsprecher Teufel GmbH does not store any personal data and is not involved in any promotional mailings.

Original packaging

If you wish to make use of the right of return, we must ask you to be sure to keep the packaging.

We can only take back speakers in their original packaging.

Empty cartons are not available!

Complaint

In the event of a complaint, we absolutely need the following information for processing:

1. Invoice number

- ▶ Please refer to the proof of purchase (enclosed with the speaker), or the order confirmation that you received as a PDF document.

2. Serial number

- ▶ Refer to the rear of the speaker.

Contact

If you have any questions, suggestions or critiques, please contact our Service:

Teufel Audio US, Inc.

16192 Coastal Highway
Lewes, Delaware 19958
USA

Lautsprecher Teufel GmbH

BIKINI Berlin
Budapester Straße 44
10787 Berlin (Germany)

Phone:

Germany: +49 (0) 30 217 84 217

Austria: +43 12 05 22 3

Switzerland: +41 43 50 84 08 3

International: 0800 200 300 40 (toll- free)

Online support:

us.teufelaudio.com/support

teufelaudio.com/support

teufel.de/support

Contact:

us.teufelaudio.com/contact

teufelaudio.com/contact

teufel.de/kontakt

Safety

Intended use

The speaker is used to play back and amplify audio signals from an external player via Bluetooth® or a cable connection.

- ▶ Only use the speaker as described in this user manual.

Any other use is deemed to be improper and may result in material damage or even personal injury.

The manufacturer accepts no liability for damage caused by improper use.

The speaker is intended for use in the private sphere.

Before starting up the speaker:

- ▶ Read the user manual and safety booklet carefully.
- ▶ Keep the instructions in a safe place so that they can be passed on to third parties.

Explanation of warnings

The action-related warnings warn against residual dangers and precede a dangerous action step.

The warnings are graded with regard to their danger.

The hazard levels with the corresponding signal words are explained below.

CAUTION

Possible minor injuries.

ATTENTION

Possible material damage.

NOTE

Additional information and tips.

Scope of supply

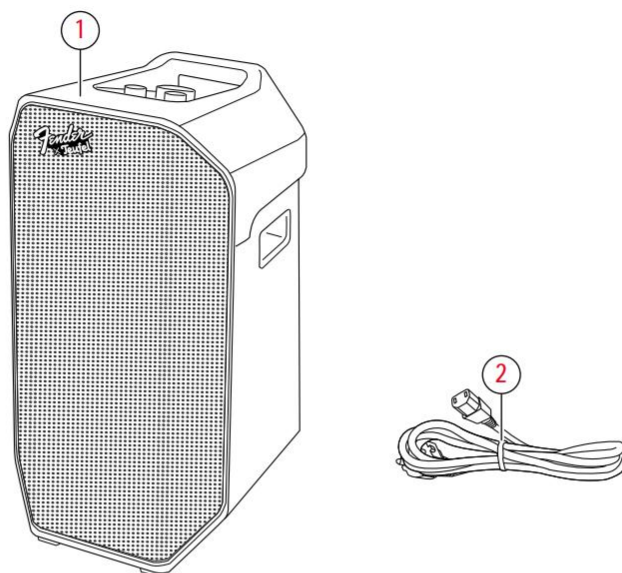

Scope of supply

(1) FENDER® x TEUFEL ROCKSTER® AIR 2

(2) Mains cable (C13 / 1.2 m)

- ▶ Check the scope of supply for completeness.
- ▶ Check the scope of supply for damage.
- ▶ Keep the original packaging during the warranty period.

Operating and display elements

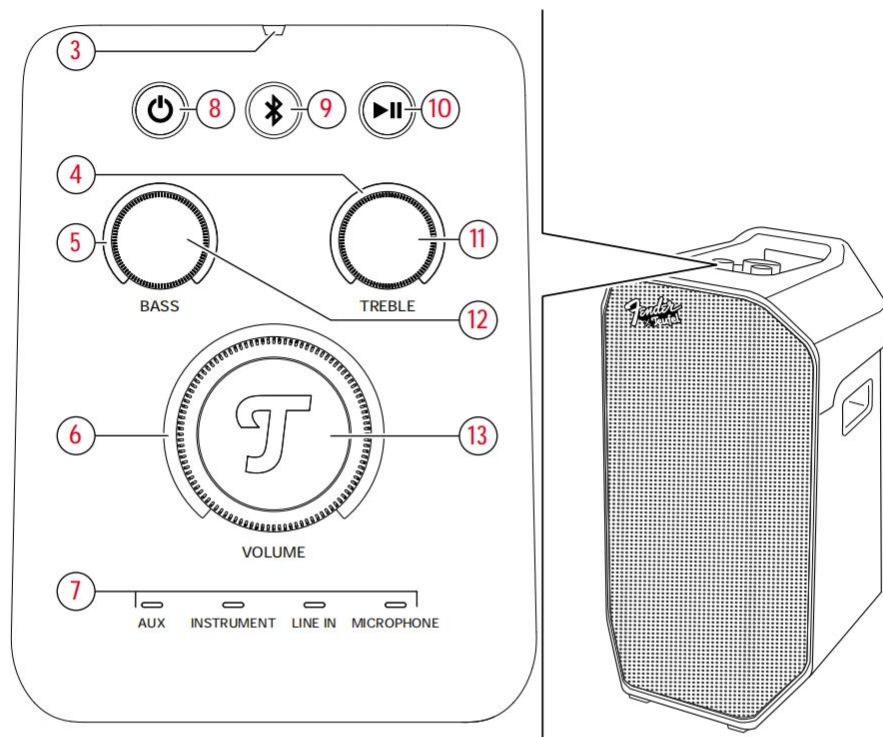



Operating and display elements

No.	LED / sensor	Function
(3)	Light sensor	Automatically controls the brightness of the LEDs.
(4)	Treble LEDs	Displays the Treble level.
(5)	Bass LEDs	Displays the Bass level.
(6)	Volume LEDs	Displays the volume.
(7)	Source LEDs	Displays an active source.
		AUX → AUX playback (analogue) – p. 17
		INSTRUMENT → INSTRUMENT IN – p. 18
		LINE IN → PARTY LINK – p. 20
		MICROPHONE → MIC . LINE IN – p. 19

Legend (actuation):

 = Press 1x















 = Press 2x

 = Press and hold (2 s)

 = Press and hold (8 s)

 = Turn anticlockwise

 = Turn clockwise

No.	Button / controller	Function	Actuation
(8)	 Power	<i>Switching on and off – p. 13</i>	
(9)	 Bluetooth®	<i>Coupling devices (pairing) – p. 14</i>	
		<i>Deleting the Bluetooth® list – p. 14</i>	
(10)	 Play / Pause	<i>Pausing and starting playback – p. 15</i> (Bluetooth®mode)	
		Playback next track (Bluetooth®mode)	
(11)	 Treble controller	<i>Adjusting the Treble level – p. 16</i>	
(12)	 Bass controller	<i>Adjusting the bass level – p. 16</i>	
(13)	 Master volume controller	<i>Adjusting the volume – p. 15</i>	

Connections

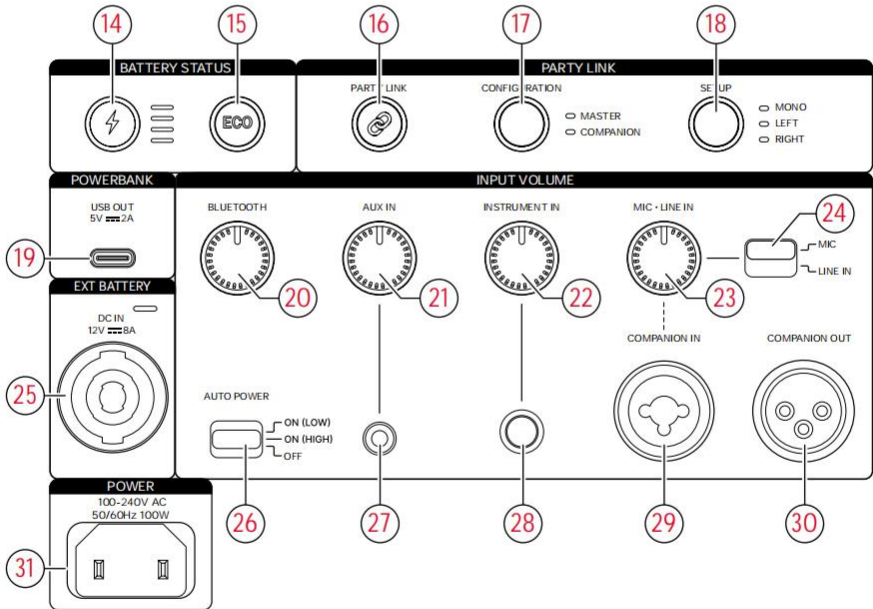
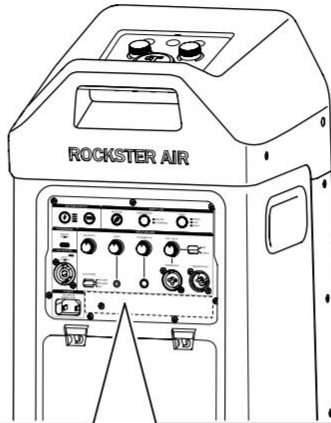



Connections on the back

Legend (actuation):







 = Press 1x

 = press and hold (2 s)

 = press and hold (5s)

 = turn counterclockwise

 = turn clockwise

No.	Button / controller	Function	Actuation
(14)	Battery status	<i>Displaying the charge level – p. 24</i>	
(15)	ECO	<i>ECO mode – p. 26</i>	
(16)	PARTY LINK	<i>PARTY LINK – p. 20</i> (Pairing two or more speakers)	
(17)	Configuration		
(18)	Setup		
(19)	USB powerbank	<i>Using a power bank – p. 28</i>	Plug in
(20)	Bluetooth volume	Volume controller Bluetooth	
(21)	AUX volume	Volume controller AUX	
(22)	Instrument volume	Volume controller instrument	
(23)	MIC volume	Volume controller microphone	
(24)	Input changeover switch		
(25)	EXT. BATTERY	<i>Connecting external batteries – p. 27</i>	Plug in
(26)	AUTO POWER	<i>Auto Power / Network Standby mode – p. 29</i>	
(27)	AUX IN	<i>AUX playback (analogue) – p. 17</i> (Connection for external devices)	Plug in
(28)	INSTRUMENT IN	<i>INSTRUMENT IN – p. 18</i>	Plug in
(29)	COMPANION IN	<i>PARTY LINK – p. 20</i>	Plug in
(30)	COMPANION OUT		Plug in
(31)	Power	<i>Connection – p. 12</i>	Plug in

Start-up

Carrying and setting up

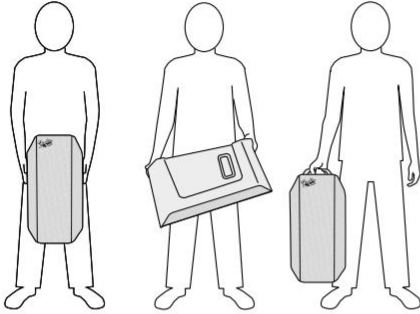

1. Hold the speaker by the handles and carry it carefully to the setup site.
 - ▶ The speaker can be carried by the side handles, by the lower and upper handles or only by the handle at the top.
 2. Place the speaker on a stable and level surface.
 - ▶ Avoid proximity to heat sources and direct sunlight.
 - ▶ Do not place any objects on the speaker.
- ✔ **The speaker is set up.**

i NOTE

The speaker has an opening at the bottom for mounting on a PA stand with 35 mm pins.

Connection

ATTENTION

Material damage due to trip hazard!

An awkwardly laid mains cable can become a trip hazard and possibly pull down and damage the speaker.

- ▶ Lay the mains cable in such a way that it does not become a trip hazard for people and animals.

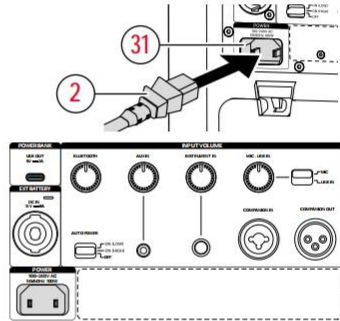

1. Connect the mains cable (2) to the speaker power socket (31).
 2. Connect the mains cable (2) to a mains socket.
- ✔ **The speaker is connected.**

Operation

Switching on and off

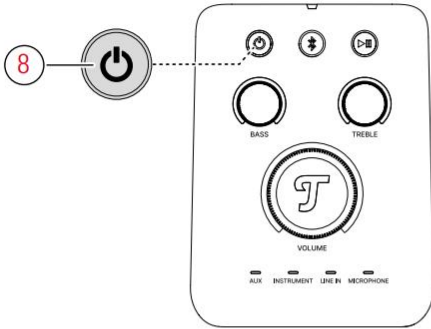

Switching on

1. Press Power button (8) and hold it for 2 seconds, until an LED animation runs and sequence of tones sounds.
 2. Wait until the speaker is fully started and the LEDs light up continuously.
- The speaker is switched on.**

Switching off

1. Press the power button (8) and keep it pressed for 2 seconds. During the switch-off process, an LED animation runs and a tone sequence sounds.
 2. Wait until the speaker is fully switched off and the LEDs are permanently extinguished.
- The speaker is switched off.**

i NOTE

All functions of the speaker are inactive in switched off state.

Bluetooth®

A compatible external player (e.g. smartphone) is connected wirelessly to the speaker via Bluetooth®.

i NOTE

Only use the Bluetooth® function in places where wireless radio transmission is permitted.

Coupling devices (pairing)

Coupling (pairing) connects the external player with the speaker.

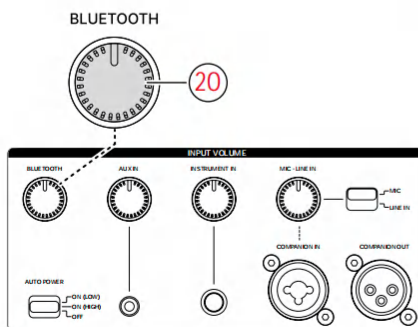
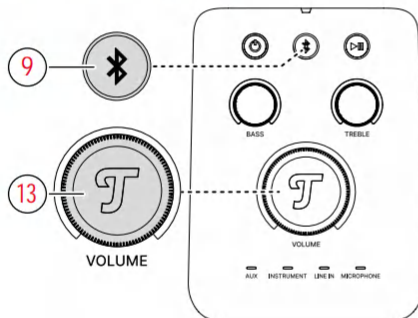

1. Activate the Bluetooth® function on the external player.
2. Press the Bluetooth® button (9) and keep it pressed for 2 seconds.
 - ✓ **Bluetooth® pairing mode is activated. A signal tone sounds and the Bluetooth® button LED flashes blue.**
3. Search for Bluetooth® devices on the external player.
 - ▶ Follow the user manual of the external player.
4. Select the "ROCKSTER AIR 2" speaker from the list of Bluetooth® devices.
 - ✓ **The pairing procedure is completed. A signal tone sounds and the Bluetooth® button LED lights up blue continuously.**
5. Set the volume via the Master volume controller (13) and via the Input volume controller (20).
 - ✓ **The volume is set.**

Disconnecting the Bluetooth® connection

- ▶ Deactivate the Bluetooth® function on the external player.
- ✓ **The Bluetooth® connection has been disconnected. A signal tone sounds and the Bluetooth® button LED lights up dimmed blue.**

Deleting the Bluetooth® list

- ▶ Press the Bluetooth® button (9) and keep it pressed for 8 seconds.
- ✓ **The Bluetooth® list is deleted and a signal tone sounds.**

Adjusting the volume

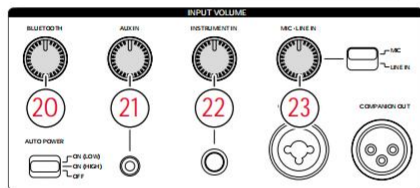
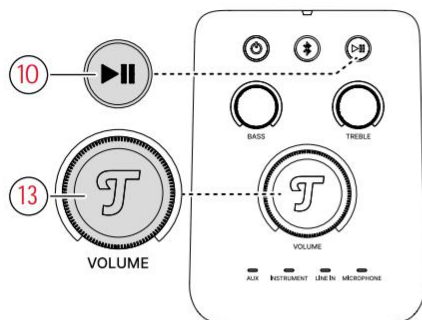

The volume is set via the Master volume controller (13) and the input volume-controller of the input sources (20-23).

- ▶ Set the volume level for the desired input source with the corresponding input volume controller (20-23).

i NOTE

Turn Input volume controller for unused input sources counterclockwise to Minimum.

- ▶ Turn the Master volume controller (13) counterclockwise.
- ✓ **The volume is reduced.**
- ▶ Turn the Master volume controller (13) counterclockwise until the first volume LED flashes.

- ✓ **The volume = 0.**

- ▶ Turn the Master volume controller (13) clockwise.

- ✓ **The volume is increased.**

i NOTE

The volume setting of the external player also affects the volume of the speaker. Set the volume of the external player as high as possible.

Mute (only in AUX mode)

- ▶ Press the Play/Pause button (10).
- ✓ **The speaker is muted.**
- ▶ Press the Play/Pause button (10) again.
- ✓ **The speaker is unmuted.**

Playback

- ▶ Start the first playback via the external player (e.g. smartphone).

Pausing and starting playback

- ▶ Press the Play/Pause button (10).
- ✓ **Playback is paused/muted (depending on the source).**
- ▶ Press the Play/Pause button (10) again.
- ✓ **Playback is started/unmuted (depending on the source).**

Playback next track (Bluetooth® mode)

- ▶ Press the Play/Pause button (10) 2x.

Adjusting the bass level

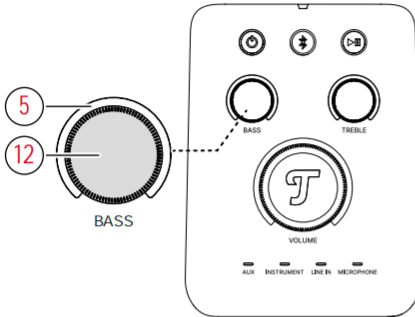

- ▶ Turn the Bass level controller (12) counterclockwise.
- ☑ The base level is gradually reduced (up to -10 dB).
- ▶ Turn the Bass level controller (12) clockwise.
- ☑ The base level is gradually increased (up to +10 dB).

i NOTE

The Bass level LEDs (5) indicate the Bass level.

Adjusting the Treble level

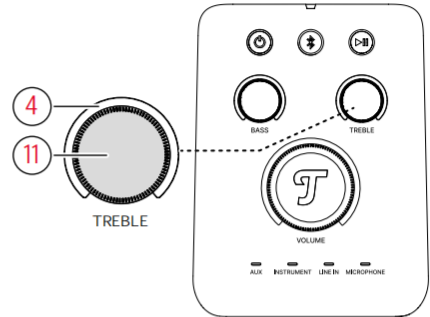

- ▶ Turn the Treble level controller (11) counterclockwise.
- ☑ The treble level is gradually reduced (up to -10 dB).
- ▶ Turn the Treble level controller (11) clockwise.
- ☑ The treble level is gradually increased (up to +10 dB).

i NOTE

The Treble level LEDs (4) indicate the treble level.

Playback sources (source)

i NOTE

This speaker is versatile and allows you to listen to multiple audio sources at the same time. For example, in karaoke mode, music can be played from an external player and a microphone can be used. Or in performance mode, for example a guitar can be connected and a microphone used at the same time.

AUX playback (analogue)

A compatible external player is in analogue connection with the speaker via AUX.

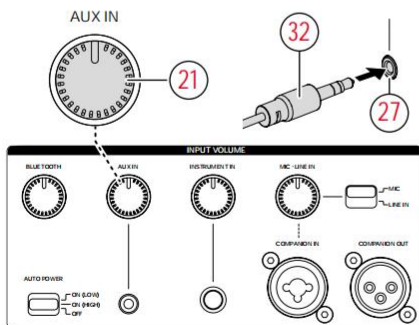
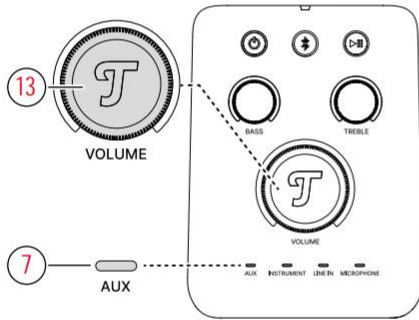

1. Connect the external player (32) to the AUX socket (27) using a stereo cable with a 3.5 mm jack plug.

✓ The Source LED (7) lights up.

2. Control the playback via the external player.

✓ The speaker plays the track from the external player.

3. Set the volume via the Master volume controller (13) and the volume level via the Input volume controller (21).

✓ The volume is set.

i NOTE

Any external player that has an AUX connection can be connected.

INSTRUMENT IN

A compatible instrument (e.g. electric guitar) is connected to the speaker via INSTRUMENT IN.

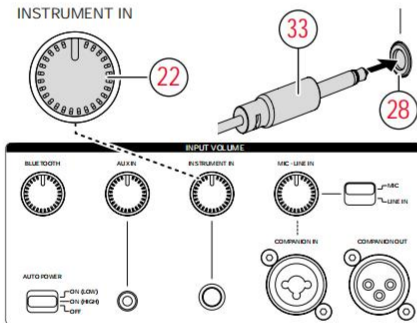
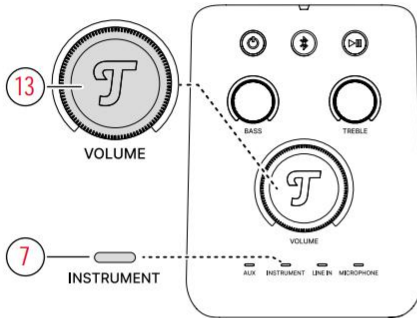

1. Connect the instrument (33) to the INSTRUMENT IN socket (28) using a mono cable with a 6.3 mm jack plug.
 - ✓ When a signal is present, the speaker automatically activates INSTRUMENT IN playback, the source LED (7) lights up.
2. Set the volume via the Master volume controller (13) and the volume level via the Input volume controller (22).
 - ✓ The volume is set and the instrument can be played back.

NOTE

Adjust the input volume with the input volume controller (22) so that the signal sounds clear and clean (not distorted) even during loud passages.

MIC · LINE IN

A microphone can be connected to the speaker at COMPANION IN.

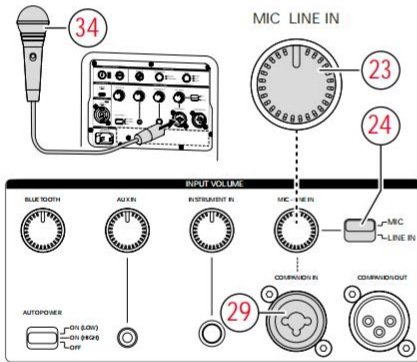
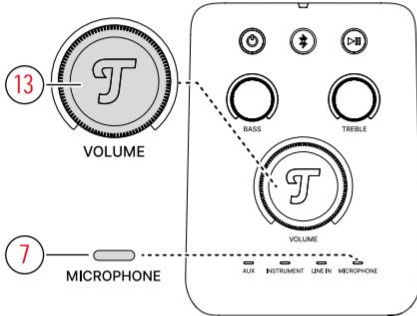

1. Connect a microphone (34) to the COMPANION IN socket (29) .
 2. Set Input sensitivity switch (24) to MIC position.
- ☑ If a signal is present the speaker automatically activates the MIC · LINE IN playback, the Source LED (7) lights up.
3. Set the volume via the Master volume controller (13) and the volume level via the Input volume controller (23) .
- ☑ The volume is set and the microphone can be used.

PARTY LINK

The PARTY LINK function allows several speakers to be linked together in master-companion mode.

The connection of 2 speakers can be made via Bluetooth® or a cable connection.

The connection of more than 2 speakers can only be made via a cable connection.

i NOTE

The MASTER speaker is the primary source that receives the signal from the external player and passes it on to the connected COMPANION speaker. With PARTY LINK via Bluetooth®, only the Bluetooth® signal from the external player can be used as a source.

PARTY LINK over Bluetooth®

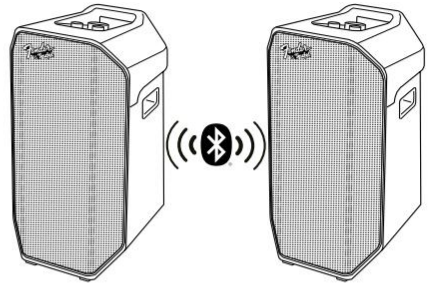

Via PARTY LINK Bluetooth®, 2 speakers can be connected to each other in master-companion mode.

One speaker is configured as MASTER and the other as COMPANION.

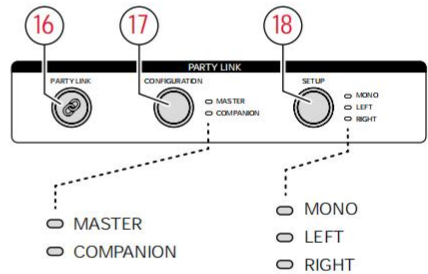

► Switch on the speakers to be connected.

Configure speakers as MASTER and COMPANION

By default, the speakers are preset as MASTER.

1. Check the settings on Speaker 1.
The MASTER LED must light up. If necessary press CONFIGURATION button (17) and set as MASTER.
- ☑ **The MASTER LED lights up.**
2. Press CONFIGURATION button (17) on Speaker 2 and set as COMPANION.
- ☑ **The COMPANION LED lights up.**
3. Press the PARTY LINK button (16) on both speakers.
A signal tone sounds and the CONFIGURATION button and SET UP button LEDs flash.
- ☑ **A signal tone sounds and the PARTY LINK LED lights up.**
PARTY LINK is set up via Bluetooth®.

SETUP

- ▶ Press SETUP button (18) on the speakers and select the desired setting (MONO, LEFT, RIGHT).
- ☑ **The LED of the selected setting lights up blue.**

PARTY LINK via cable connection

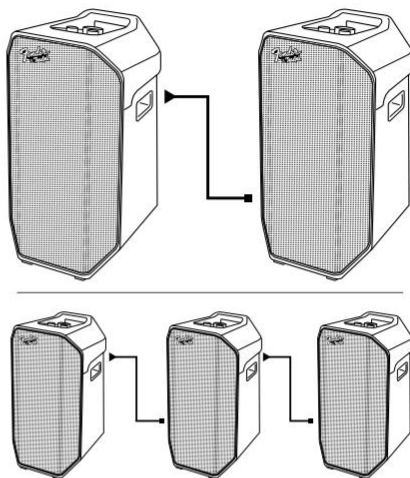

Via COMPANION IN (29) and COMPANION OUT (30) multiple speakers can be connected together in Master-Companion mode.

One speaker is configured as MASTER and the other speaker as COMPANION.

i NOTE

Suitable XLR cables for connecting the speakers are available in our web shop ("Accessories" section).

- ▶ Switch on the speakers to be connected.

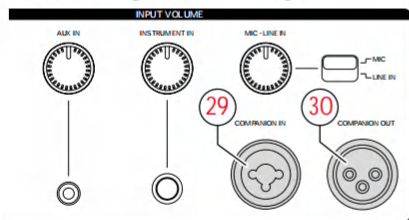
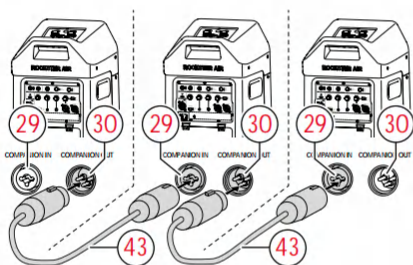
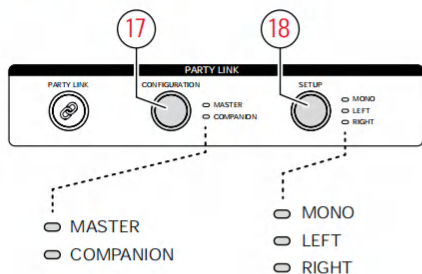

Configure Speaker 1 as MASTER

By default, the speakers are preset as MASTER.

1. Check the settings on Speaker 1 .
The MASTER LED must light up. If necessary press CONFIGURATION button (17) and set as MASTER.
- ✔ The MASTER LED lights up.

2. Connect an XLR cable (43) to the COMPANION OUT-socket (30) on Speaker 1.

Configure Speaker 2 as COMPANION

3. Press CONFIGURATION button (17) on Speaker 2 and set as COMPANION.
- ✔ The COMPANION LED lights up and the COMPANION IN socket LED flashes.
4. Connect XLR cable (43) to the COMPANION IN-socket (29) on Speaker 2.
- ✔ PARTY LINK is set up via cable connection.

i NOTE

Repeat steps 3 and 4 to connect other speakers.

SETUP

- ▶ Press SETUP button (18) on Speaker 1 (MASTER) and select the desired setting (MONO, LEFT, RIGHT).

- ✔ The LED of the selected setting lights up white.

The setting on the MASTER decides which signal is transmitted to the COMPANION:

MASTER MONO → COMPANION MONO
 MASTER LEFT → COMPANION RIGHT
 MASTER RIGHT → COMPANION LEFT

Battery

Charging the battery

⚠ CAUTION

Slight injury and material damage due to improper handling!

Batteries can catch fire or explode if handled improperly, resulting in injury and speaker failure.

- ▶ Only use original batteries for the power supply of the speaker.
- ▶ Replace batteries only with original batteries or batteries of the same or equivalent type.
- ▶ Do not heat, short-circuit or burn batteries.
- ▶ Protect batteries from direct sunlight.
- ▶ Only use the mains cable provided.

The integrated rechargeable battery starts charging as soon as the speaker is connected to a mains socket.

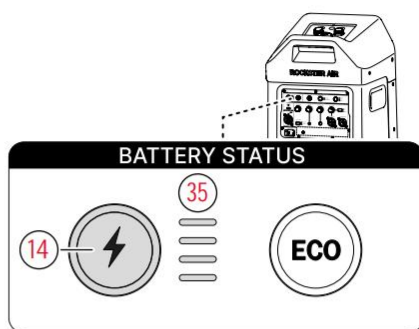

- ▶ Connect the speaker.
→ *Connection – p. 12*
- ☑ **The battery is charging. During charging, the battery status LEDs (35) light up animatedly.**

i NOTE

The fully charged battery allows an operating time of approx. 56 hours at medium volume.





Displaying the charge level

The battery status LEDs (35) can indicate the current charge status of the battery.

▶ Press the battery status button (14).

✔ **The charge level is displayed.**

The number of battery status LEDs that light up represents an approximate value of the current charge level.

Battery status LEDs	Battery %
	1-10%
	11-25%
	26-50%
	51-75%
	76-100%

i NOTE

To protect the battery, the speaker has a deep discharge protection that switches off the speaker when the threshold is reached. It is then no longer possible to switch on the speaker again without the mains cable connected and the battery charged.

Remove and insert battery

The battery installed at the rear can be removed.

Remove battery

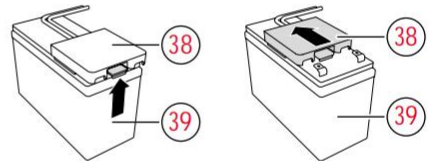
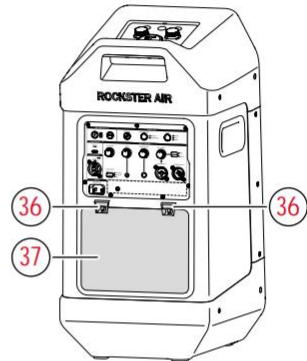

1. Press down the unlocking device (36) on the battery cover (37) and take the battery cover off backwards.
2. Unlock Teufel battery pack (38) on the top of the battery (39) and pull it off in the direction of the centre of the battery.

✔ **The battery has been removed.**

Insert battery

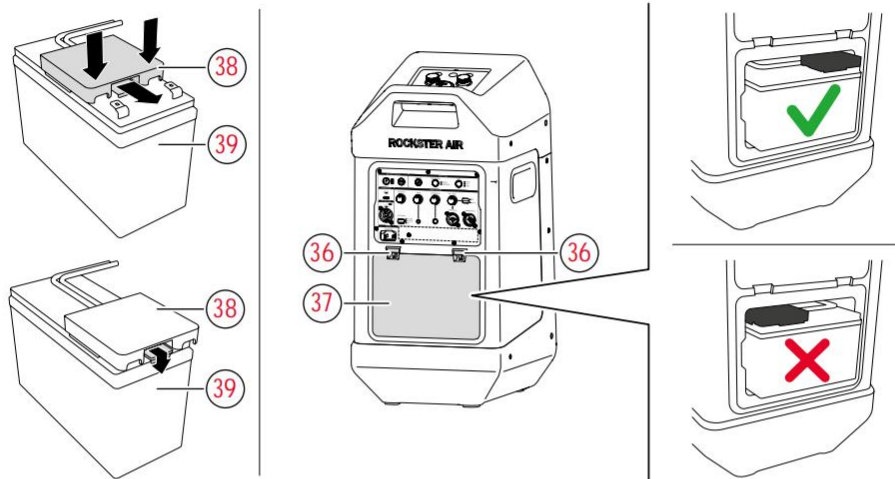

ATTENTION

Material damage from bent battery contacts on the battery!

Bent battery contacts on the battery can damage the Teufel Battery Pack and the battery when inserting the battery.

- ▶ Check and if necessary adjust battery contacts before insertion.
- ▶ If the battery contacts are too bent or broken do not use the battery!

1. Insert the Teufel Battery Pack (38) in the middle on the top of the battery (39) and push on to the connections. The Teufel battery pack locking device must engage.
 2. Insert battery (39) in the speaker.
Note installation direction!
 3. Insert the battery cover (37) into the guide at the bottom and lock it in place. Make sure that the cable is not trapped.
 - ▶ The battery cover (37) must lock noticeably and audibly.
- ☑ **The battery is correctly inserted.**

ECO mode

When ECO mode is activated, power consumption is reduced to extend the speaker's battery life.

- LEDs on the top control panel are dimmed.
- Maximum achievable volume is reduced.
- Playback of low bass is reduced.

Activate ECO mode

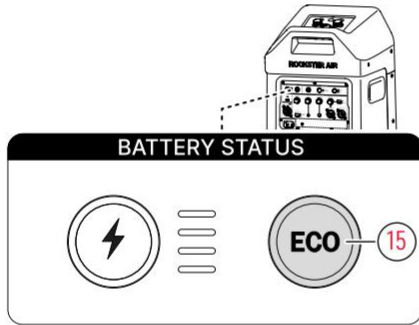

- ▶ Press ECO button (15).
- ✓ The ECO mode is activated, the LED in the ECO button lights up.

i NOTE

When ECO mode and Auto Power are activated, the time for automatic switch-off (standby mode) is reduced.

→ *Auto Power / Network Standby mode – p. 29*

Deactivate ECO mode

- ▶ Press the ECO button (15) again.
- ✓ The ECO mode is deactivated, the LED in the ECO button goes out.

Deactivating and activating signal tones

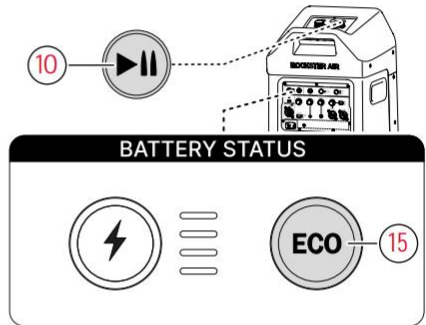

Deactivating signal tones

- ▶ Press the ECO button (15) and Play/Pause button (10) at the same time and hold for 5 seconds.
- ✓ A signal tone sounds and the signal tones are deactivated.

Activating signal tones

- ▶ Press the ECO button (15) and Play/Pause button (10) at the same time and hold for 5 seconds.
- ✓ A signal tone sounds and the signal tones are activated.

Connecting external batteries

If no mains power is available and the capacity of the internal battery is not sufficient, the speaker can be powered by an external battery.

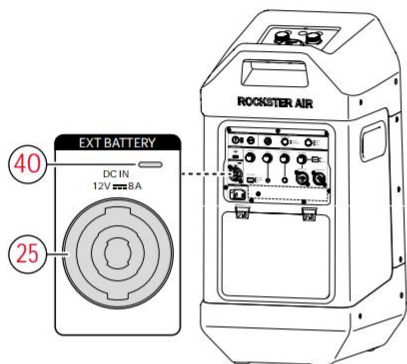

1. Switch off speaker.
 2. Connect the connection cable to the external battery. **Note polarity!**
 3. Connect connection cable to the EXT. BATTERY-socket (25) .
- The external battery is connected, the LED (40) lights up.**

i NOTE

A special connection cable is required to connect an external battery. The connection cable is not included in the delivery scope.

i NOTE

If an external battery is connected the internal battery is charged.

i NOTE

If the speaker is connected to the mains the external battery is not charged.

Using a power bank

The USB port on the back serves as a power bank connection and can charge connected external players (e.g. smartphones).

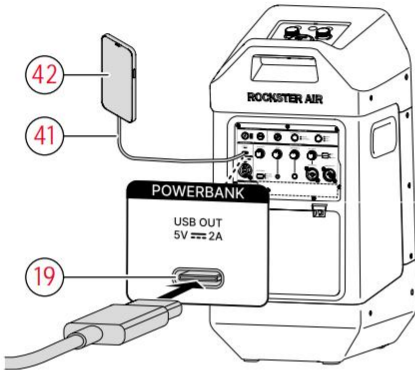

1. Connect the USB-C cable (41) to the USB-C port (19).
 2. Connect the USB-C cable (41) to an external player (42), e.g. smartphone.
- ✓ **The external player is charged.**

i NOTE

Using the power bank function shortens the operating time of the speaker when it is operated on battery power.

The power bank function continues even when the speaker is in standby mode.

The charging voltage is 5 V at a maximum of 2 amps.

Power bank functions (during mains operation)

If the speaker is connected to the mains socket, the external player is charged in any operating mode.

Power bank functions (during battery operation)

Requirements for charging the external player in battery mode:

- The speaker is switched on and the battery charge level is at least 20%,
- The speaker is in standby mode and the battery charge level is at least 20%.

The external player is not charged:

- When the battery charge level is less than 20%,
- the speaker is switched off.

Auto Power / Network Standby mode

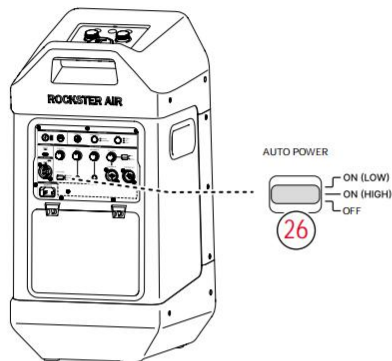

Depending on the operating mode and the selected setting, the speaker switches off after a few minutes without an input signal or switches to network standby mode.

The Auto Power ON function automatically activates the speaker from network standby mode when an audio signal is received.

i NOTE

The Auto Power ON function is not available for INSTRUMENT IN and MIC·LINE IN.

Activate Auto Power ON / Standby

- ▶ Turn the Auto Power switch (26) to one of the **ON** positions.
- ▶ **ON (Low)**: A strong signal causes the speaker to switch on.
- ▶ **ON (High)**: A weak signal causes the speaker to switch on.

Auto Power ON is activated.

Deactivate Auto Power ON

- ▶ Turn the Auto Power switch (26) to the **OFF** position.

Auto Power ON is deactivated.

Standby mode

Auto Power switch (26) in position:

- **ON (Low)**: Standby mode after 15 minutes without an input signal.
- **ON (High)**: Standby mode after 15 minutes without an input signal.
- **OFF**: Standby mode is deactivated

i NOTE

When ECO mode is activated the time for Standby mode is reduced to 5 minutes.

Cleaning and care

ATTENTION

Material damage due to improper cleaning!

The use of unsuitable cleaning agents can lead to the discolouration and destruction of the surface.

- ▶ Do not allow moisture to get inside.
 - ▶ Clean the speaker only with a dry, soft cloth.
-
1. Remove dust and light contamination with a dry leather cloth.
 2. Remove stubborn stains with a cloth slightly moistened with mild soapy water.
 3. Then rub damp surfaces dry with a dry, soft cloth without applying pressure.
- ☑ **The speaker has been cleaned.**

Storage

Storing the speaker for a longer period without mains connection (e.g. in winter):

1. Fully charge the battery
→ *Charging the battery – p. 23.*
2. Remove the battery and store it cool and dry at +10 to +20 °C
→ *Remove battery – p. 24.*
 - ▶ Protect the battery from humidity and direct sunlight.
3. Store speaker dry and at a storage temperature of +10 to +40 °C.
 - ▶ Protect speaker from humidity and direct sunlight.

i NOTE

Fully charge the battery at least once a month if stored for a long time without use.

Troubleshooting

► Follow the instructions below to eliminate possible faults:

Malfunction	Possible cause	Remedy
The speaker does not start.	The battery is discharged.	► Connect the speaker and charge the battery. → <i>Charging the battery – p. 23</i>
	Power button pressed too briefly.	► Press Power button and hold it for 2 seconds, until an LED animation runs and sequence of tones sounds. → <i>Switching on and off – p. 13</i>
No sound	The volume is too low.	► Increase volume on Master volume controller and on Input volume controller . → <i>Adjusting the volume – p. 15</i>
	The volume on the external player is too low.	► Increase the volume on the external player (e.g. smartphone).
	The speaker is not connected to the external player.	► Connect the speaker to the external player. → <i>Bluetooth® – p. 14</i> → <i>AUX playback (analogue) – p. 17</i>
	The speaker is not set as the output device on the external player.	► Set the speaker as the output device in the settings of the external player. ► Observe the manufacturer's documentation for the external player.
	The Bluetooth® connection is disturbed by another radio system	► Move the speaker to another location. → <i>Carrying and setting up – p. 12</i>
The playback of the external player is too quiet	The volume limiter on the external player is active. (Android systems only)	► Deactivate the volume limiter. ► Observe the manufacturer's documentation for the external player.
Speaker does not respond	A system error has occurred	► <i>Perform a hardware reset – p. 32</i>

Perform a hardware reset

i NOTE

Only perform a hardware reset if the speaker does not respond.

- ▶ Before a hardware reset, check whether
 - the speaker is waiting for an input,
 - the external player is paused,

- ▶ Consider alternatives, such as:
 - Disconnecting the Bluetooth® connection.
 - Disconnect power supply and restart speaker.

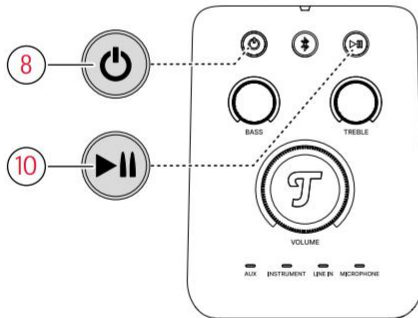

- ▶ Press the Power button (8) and the Play/Pause button (10) at the same time and hold for 5 seconds.
- ✔ A hardware reset is carried out.

Technical data

General technical data	
Dimensions (W x H x D)	323 mm x 591 mm x 345 mm
Weight	14.45 kg
Mains voltage	100-240 V AC / 50-60 Hz
External DC connection	DC 12 V / 8 A
Battery	LiFePO4 12.8 V, 7800 mAh
USB port	5 V, max. 2 A
Operating temperature	0°C to 45°C
Storage temperature	-20°C to 65°C
Protection class	IPX0 No protection against water

Radio network	Frequency bands	Transmitting power
Bluetooth®	2400 – 2483.5 MHz	<13 dBm/20 mW



Lautsprecher Teufel GmbH hereby declares that the type of radio equipment FENDER® x ROCKSTER® AIR 2 complies with Directive 2014/53/EU.

The full text of the EU declaration of conformity is available at the following internet address:

teufel.de/konformitaetserklaerungen

teufelaudio.com/declaration-of-conformity



If you have any questions, suggestions or critiques, please contact our Service:

Teufel Audio US, Inc.
16192 Coastal Highway
Lewes, Delaware 19958
USA

Lautsprecher Teufel GmbH
Budapester Str. 44
10787 Berlin
Germany

us.teufelaudio.com
teufelaudio.com
teufel.de
teufel.ch
teufelaudio.at
teufelaudio.nl
teufelaudio.be
teufelaudio.fr
teufelaudio.pl
teufelaudio.it
teufelaudio.es

Phone

International 0800 200 300 40 (toll- free)
Deutschland +49 (0)30 217 84 217
Österreich +43 12 05 22 3
Schweiz +41 43 50 84 08 3

Online support us.teufelaudio.com/support
teufel.de/support
teufelaudio.com/support

Contact us.teufelaudio.com/contact
teufelaudio.com/contact
teufel.de/kontakt

All data without guarantee.

Subject to technical changes. Typographical and other errors excepted.