

## FCC/ISED - TEST REPORT

Report Number : **64.790.22.04877.01-R1** Date of Issue: 2023-03-03

Model : **EU-SK109, EU-OSK109, US-SK109, US-OSK109**

Product Type : Smart Kit

Applicant : GD Midea Air-Conditioning Equipment Co., Ltd.

Address : Lingang Road, Beijiao, Shunde 528311 Foshan, Guangdong, China

Manufacturer : GD Midea Air-Conditioning Equipment Co., Ltd.

Address : Lingang Road, Beijiao, Shunde 528311 Foshan, Guangdong, China

Test Result :  **Positive**       **Negative**

Total pages including Appendices : **40**

*Any use for advertising purposes must be granted in writing. This technical report may only be quoted in full. This report is the result of a single examination of the object in question and is not generally applicable evaluation of the quality of other products in regular production. For further details, please see testing and certification regulation chapter A-3.4.*



# 1 Table of Contents

1	Table of Contents .....	2
2	Details about the Test Laboratory .....	3
3	Description of the Equipment under Test.....	4
4	Summary of Test Standards .....	5
5	Summary of Test Results.....	6
6	General Remarks.....	7
7	Test Setups.....	8
7.1	Radiated test setups .....	8
7.2	Conducted RF test setups .....	9
7.3	AC Power Line Conducted Emission test setups.....	9
8	Systems test configuration.....	10
9	Technical Requirement.....	11
9.1	Conducted Emission.....	11
9.2	Conducted output power.....	14
9.3	6dB bandwidth.....	17
9.4	99% bandwidth .....	19
9.5	Power spectral density.....	21
9.6	Spurious RF conducted emissions .....	23
9.7	Band edge .....	29
9.8	Spurious radiated emissions for transmitter.....	32
10	Test Equipment List .....	39
11	System Measurement Uncertainty .....	40

## 2 Details about the Test Laboratory

### Details about the Test Laboratory

#### Test Site 1

Company name: TÜV SÜD Certification and Testing (China) Co., Ltd. Shenzhen Branch  
Building 12&13, Zhiheng Wisdomland Business Park,  
Guankou Erlu, Nantou, Nanshan District,  
Shenzhen, 518052 China

FCC Designation Number: CN5009

FCC Registration No.: 514049

IC Registration Number: 10320A

Telephone: 86 755 8828 6998

Fax: 86 755 8828 5299

### 3 Description of the Equipment under Test

Product:	Smart Kit
PMN:	Smart Kit
Model no.:	EU-SK109, EU-OSK109, US-SK109, US-OSK109
HVIN:	EU-SK109, EU-OSK109, US-SK109, US-OSK109
FVIN:	N/A
FCC ID:	2ADQOMDNA23
IC:	12575A-MDNA23
Rating:	5VDC (by USB port)
RF Transmission Frequency:	2402MHz-2480MHz
No. of Operated Channel:	40
Modulation:	GFSK
Antenna Type:	PCB onboard antenna
Antenna Gain:	2.7dBi max
Description of the EUT:	The product is a smart kit with WIFI and BLE functions, which can only be used for the control function of home appliances of Midea Group. It cannot be connected to a computer for any other functions.

NOTE 1: The above EUT's information is declared by manufacturer. Please refer to the specifications or user's manual for more detailed description.

NOTE 2:

EU-SK109, EU-OSK109, US-SK109, US-OSK109 are identical except model name.

Unless otherwise specified, the model EU-SK109 was chosen as representative sample to perform fully testing, other models are deemed to fulfil relevant requirements without further testing.

## 4 Summary of Test Standards

Test Standards	
FCC Part 15 Subpart C 10-1-2021 Edition	PART 15 - RADIO FREQUENCY DEVICES Subpart C - Intentional Radiators
RSS-Gen Issue 5, April 2018 Amendment 1, March 2019 + Amendment 2, February 2021	General Requirements and Information for the Certification of Radio Apparatus
RSS-247 Issue 2 February 2017	Digital Transmission Systems (DTSS), Frequency Hopping Systems (FHSS) and License-Exempt Local Area Network (LE-LAN) Devices

All the test methods were according to KDB558074 D01 v05r02 DTS Measurement Guidance and ANSI C63.10 (2013).

## 5 Summary of Test Results

Technical Requirements			
FCC Part 15 Subpart C 10-1-2021 Edition / RSS-247 Issue 2, February 2017/ RSS-Gen Issue 5, April 2018 Amendment 1, March 2019 + Amendment 2, February 2021			
Test Condition		Test Result	Test Site
§15.207 RSS-GEN 8.8	Conducted emission AC power port	Pass	Site 1
§15.247 (b) (3) & RSS-247 5.4(d)	Conducted output power	Pass	Site 1
RSS-247 5.4(d)	Equivalent Isotropic Radiated Power	Pass	Site 1
§15.247(e) RSS-247 5.2(b)	Power spectral density	Pass	Site 1
§15.247(a)(2) RSS-247 5.2(a) & RSS-GEN 6.7	6dB bandwidth	Pass	Site 1
§15.247(a)(1) RSS-247 5.1(b)	20dB Occupied bandwidth	N/A	--
RSS-GEN 6.7	99% Occupied Bandwidth	Pass	Site 1
§15.247(a)(1) RSS-247 5.1(b)	Carrier frequency separation	N/A	--
§15.247(a)(1)(iii) RSS-247 5.1(d)	Number of hopping frequencies	N/A	--
§15.247(a)(1)(iii) RSS-247 5.1(d)	Dwell Time	N/A	--
§15.247(d) RSS-247 5.5	Spurious RF conducted emissions	Pass	Site 1
§15.247(d) RSS-247 5.5	Band edge	Pass	Site 1
§15.247(d) & §15.209 & §15.205 RSS-247 5.5 & RSS- Gen 6.13	Spurious radiated emissions for transmitter	Pass	Site 1
§15.203 RSS-Gen 6.8	Antenna requirement	Pass See note 1	--

Remark 1: N/A – Not Applicable.

Note 1: The EUT uses a PCB onboard antenna, which gain is 2.7dBi. In accordance to §15.203 and RSS-Gen 6.8, it is considered sufficiently to comply with the provisions of this section.

## 6 General Remarks

### Remarks

This submittal(s) (test report) is intended for FCC ID: 2ADQOMDNA23, complies with Section 15.207, 15.209, 15.205, 15.247 of the FCC Part 15 Subpart C 10-1-2021 Edition.

This submittal(s) (test report) is intended for IC: 12575A-MDNA23, complies with RSS-247 Issue 2, February 2017 and RSS-Gen Issue 5, Amendment 2, February 2021.

This report is only for the BLE function.

### SUMMARY:

All tests according to the regulations cited on page 6 were

- Performed

- **Not** Performed

The Equipment under Test

- **Fulfills** the general approval requirements.

- **Does not** fulfill the general approval requirements.

Sample Received Date: 2022-11-30

Testing Start Date: 2022-12-12

Testing End Date: 2023-01-10

- TÜV SÜD Certification and Testing (China) Co., Ltd. Shenzhen Branch –

Reviewed by:

Prepared by:

Tested by:

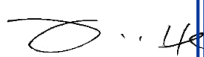

Jessie He  
Project Manager



Myron Yu  
Project Engineer

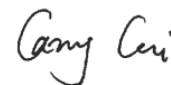

Carry Cai  
Test Engineer

## 7 Test Setups

### 7.1 Radiated test setups

9kHz - 30MHz

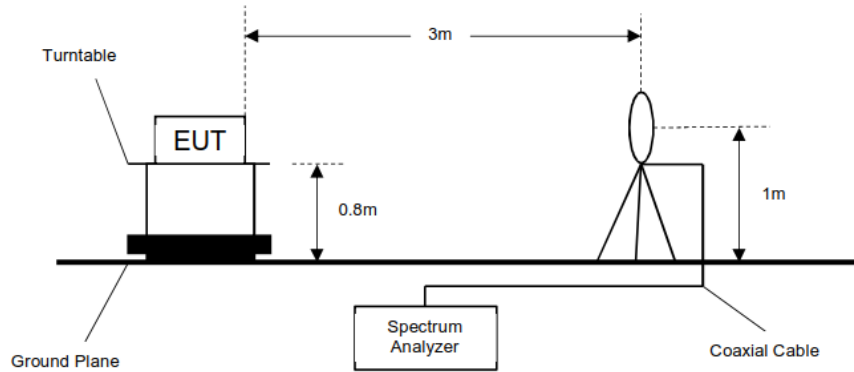

Below 1GHz

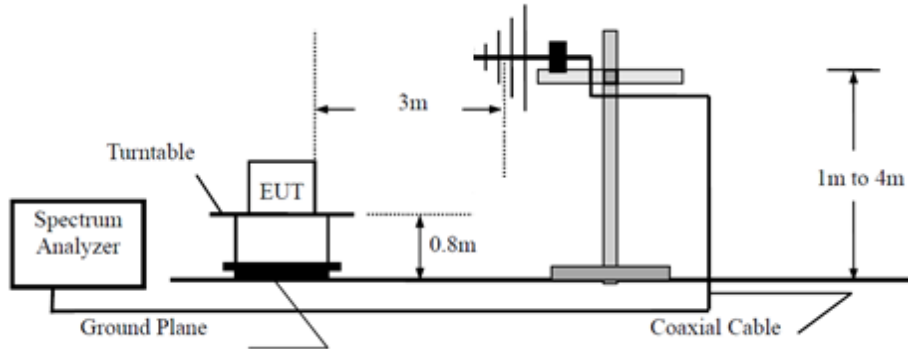

Above 1GHz

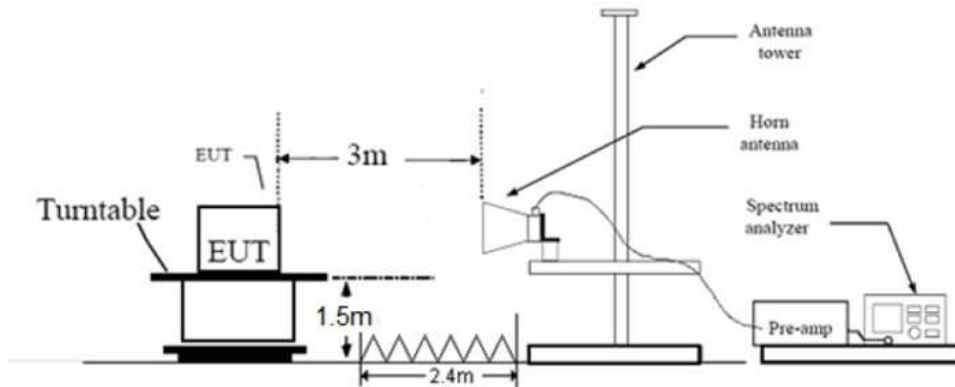



## 7.2 Conducted RF test setups

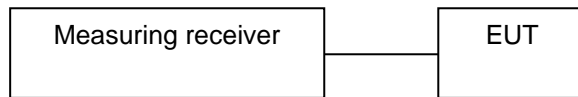

## 7.3 AC Power Line Conducted Emission test setups

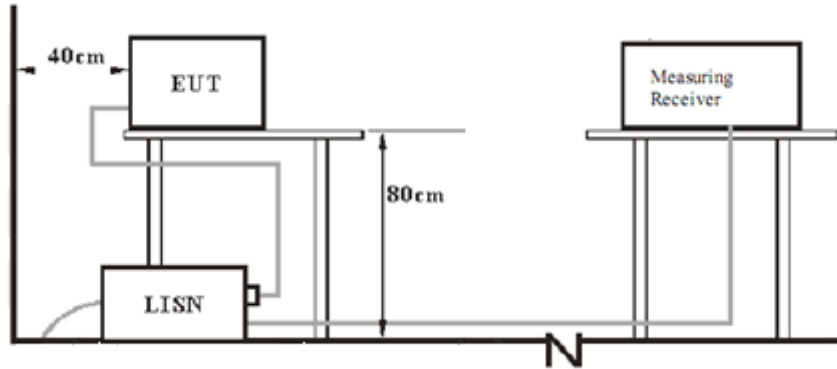

## 8 Systems test configuration

Auxiliary Equipment Used during Test:

DESCRIPTION	MANUFACTURER	MODEL NO.	S/N
MOBILE PHONE	APPLE	IPHONE 6	---
APP	MIDEA	MSMARTHOME	---
MAINBOARD	MIDEA	/	---
LAPTOP	LENOVO	X240	L34015282
SOFTWARE	REALTEK	RTLBTAPP	VERSION 5.2.2.85

The system was configured to channel 0, 19, and 39 for the test.

Test Software Information:

Test Software Version	RTLBTAPP (Version 5.2.2.85)	
Modulation	Setting TX Power	Packet Type
GFSK	Tx Gain Index 6	/

## 9 Technical Requirement

### 9.1 Conducted Emission

#### Test Method

1. The EUT was placed 0.4 meter from the conducting wall of the shielding room was kept at least 80 centimeters from any other grounded conducting surface.
2. Connect EUT to the power mains through a line impedance stabilization network (LISN).
3. All the support units are connecting to the other LISN.
4. The LISN provides 50 ohm coupling impedance for the measuring instrument.
5. Both sides of AC line were checked for maximum conducted interference.
6. The frequency range from 150 kHz to 30 MHz was searched.
7. Set the test-receiver system to Peak Detect Function and specified bandwidth (IF Bandwidth = 9kHz) with Maximum Hold Mode. Then measurement is also conducted by Average Detector and Quasi-Peak Detector Function respectively.

#### Limit

According to §15.207 & RSS-GEN 8.8, conducted emissions limit as below:

Frequency MHz	QP Limit dB $\mu$ V	AV Limit dB $\mu$ V
0.150-0.500	66-56*	56-46*
0.500-5	56	46
5-30	60	50

\*Decreasing linearly with logarithm of the frequency

## Conducted Emission

Product Type : Smart Kit  
 M/N : US-SK109  
 Operating Condition : Bluetooth transmission  
 Test Specification : Power Line, Live  
 Comment : AC 120V/60Hz (Midea-mainboard)

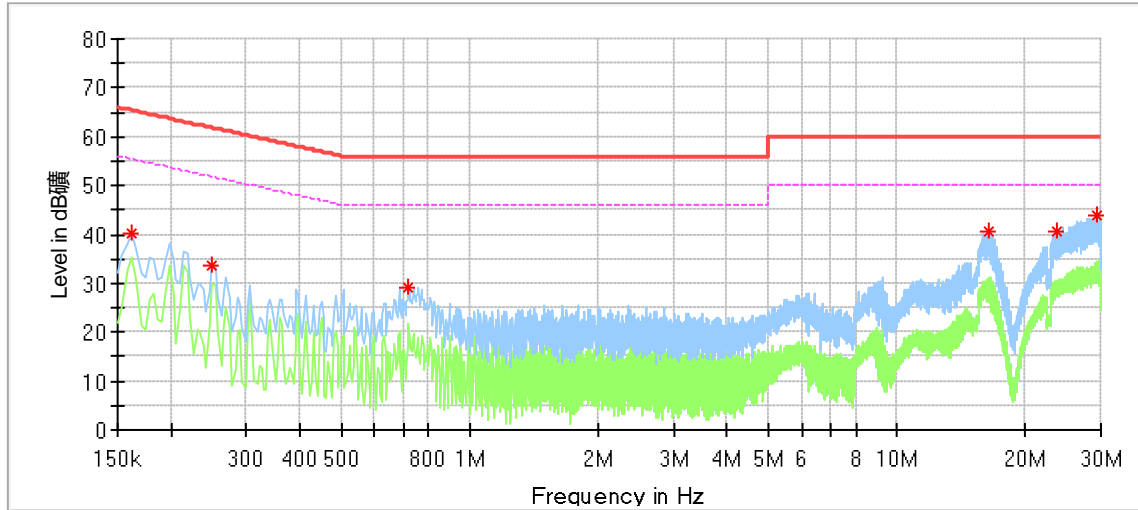

### Critical Freqs

Frequency (MHz)	MaxPeak (dBµV)	Average (dBµV)	Limit (dBµV)	Margin (dB)	Line	Corr. (dB)
0.162000	40.06	---	65.36	25.30	L1	9.58
0.250000	33.54	---	61.76	28.22	L1	9.60
0.718000	28.94	---	56.00	27.06	L1	9.64
16.470000	40.79	---	60.00	19.21	L1	9.98
23.690000	40.44	---	60.00	19.56	L1	10.08
29.518000	43.85	---	60.00	16.15	L1	10.02

Remark:

Level=Reading Level + Correction Factor

Correction Factor=Cable Loss + LISN Factor

(The Reading Level is recorded by software which is not shown in the sheet)

## Conducted Emission

Product Type : Smart Kit  
 M/N : US-SK109  
 Operating Condition : Bluetooth transmission  
 Test Specification : Power Line, Neutral  
 Comment : AC 120V/60Hz (Midea-mainboard)

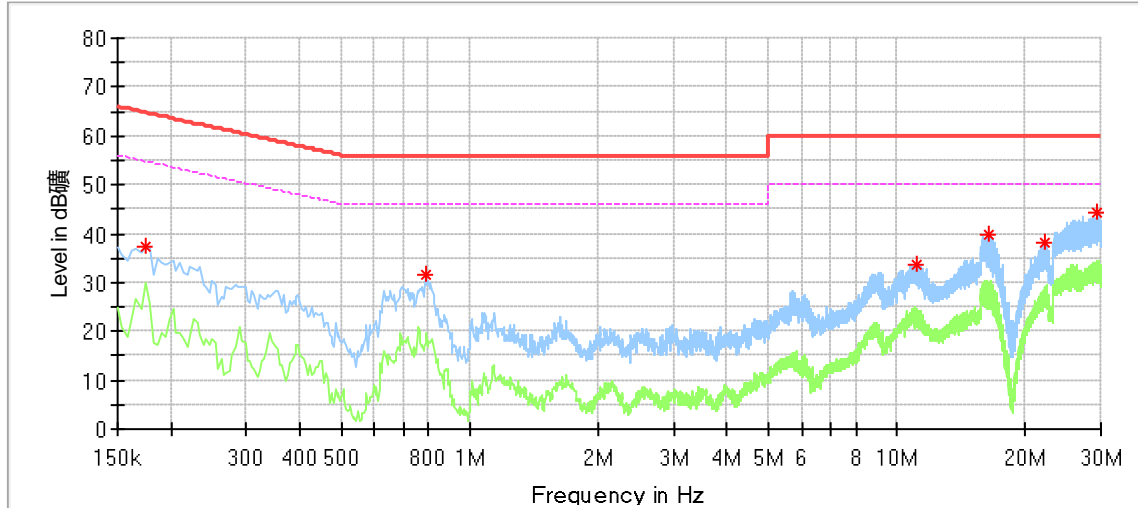

### Critical Freqs

Frequency (MHz)	MaxPeak (dBµV)	Average (dBµV)	Limit (dBµV)	Margin (dB)	Line	Corr. (dB)
0.174000	37.36	---	64.77	27.41	N	9.58
0.790000	31.42	---	56.00	24.58	N	9.64
11.090000	33.82	---	60.00	26.18	N	9.93
16.370000	39.84	---	60.00	20.16	N	9.99
22.234000	38.24	---	60.00	21.76	N	10.11
29.394000	44.27	---	60.00	15.73	N	10.06

Remark:

Level=Reading Level + Correction Factor

Correction Factor=Cable Loss + LISN Factor

(The Reading Level is recorded by software which is not shown in the sheet)

## 9.2 Conducted output power

### Test Method

1. The EUT was placed on 0.8m height table, the RF output of EUT was connected to the spectrum analyzer by RF cable. The path loss was compensated to the results for each measurement.
2. Set to the maximum power setting and enable the EUT transmit continuously
3. Use the following test receiver settings:  
Span = approximately 5 times the 20dB bandwidth, centered on a hopping channel  
RBW > the 20dB bandwidth of the emission being measured, VBW ≥ RBW,  
Sweep = auto, Detector function = peak, Trace = max hold
4. Allow the trace to stabilize. Use the marker-to-peak function to set the marker to the peak of the emission. The indicated level is the peak output power and record the results in the test report.
5. Repeat above procedures until all frequencies measured were complete.

### Limits

According to §15.247 (b) (3) & RSS-247 5.4(d), conducted output power limit as below:

Frequency Range MHz	Limit W	Limit dBm
2400-2483.5	≤1	≤30

According to & RSS-247 5.4(d), EIRP limit as below:

Frequency Range MHz	Limit W	Limit dBm
2400-2483.5	≤4	≤36.2

Test result as below table

Test Mode	Frequency (MHz)	Conducted Output Power (dBm)	Antenna Gain (dBi)	EIRP (dBm)	Result
BLE 1M	2402	5.69	2.7	8.39	Pass
	2440	6.19	2.7	8.89	Pass
	2480	6.05	2.7	8.75	Pass

### Test Graphs

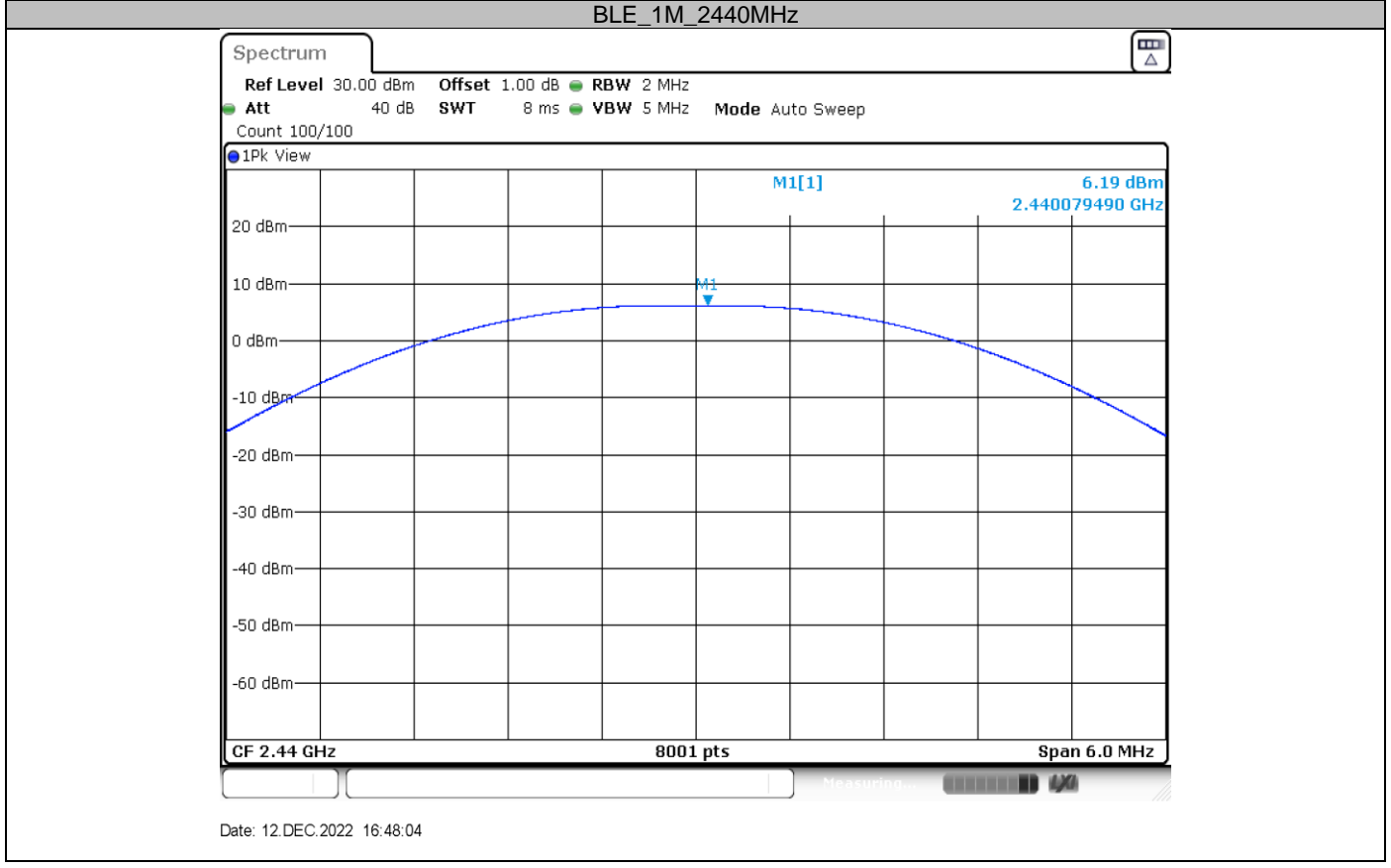
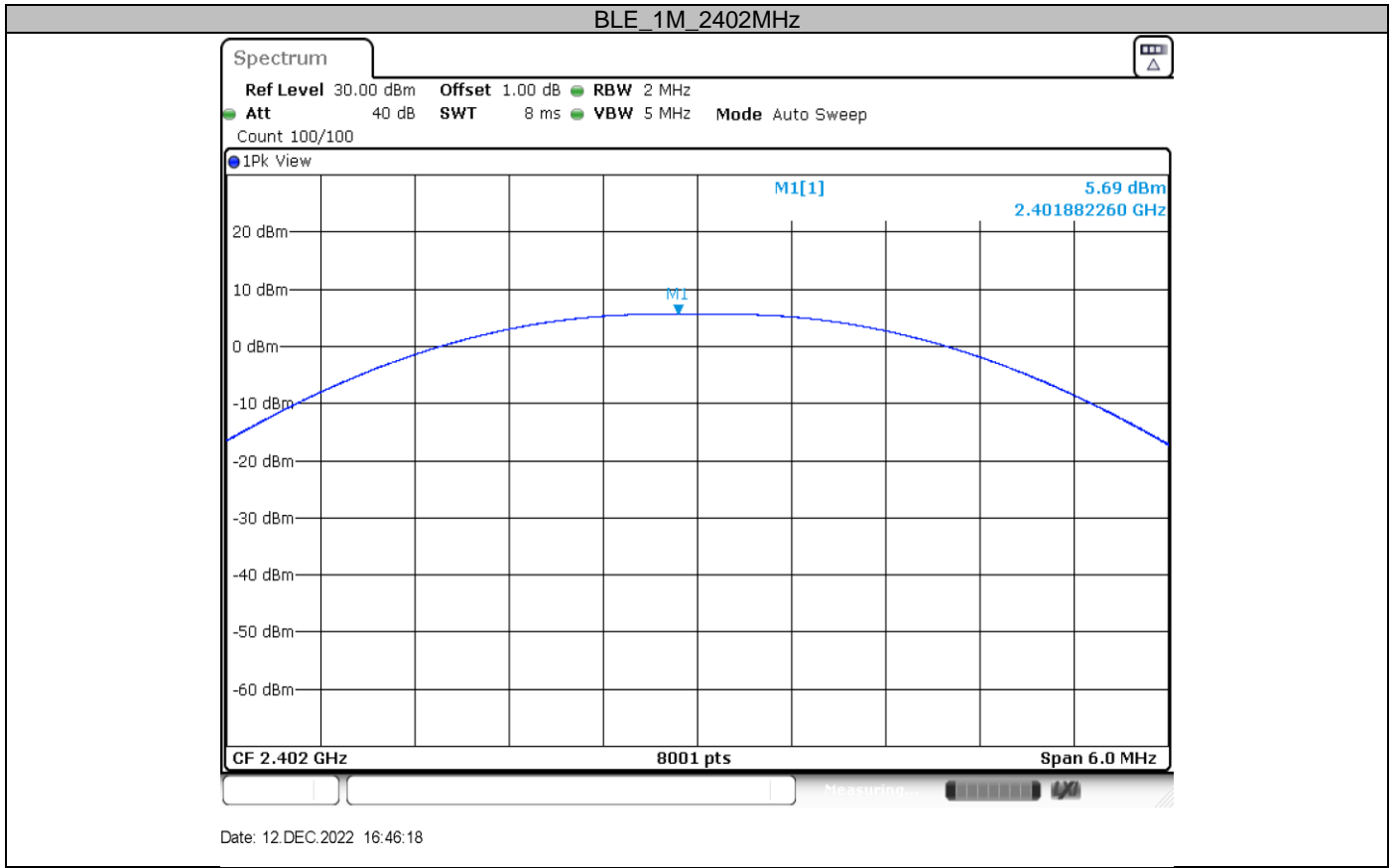

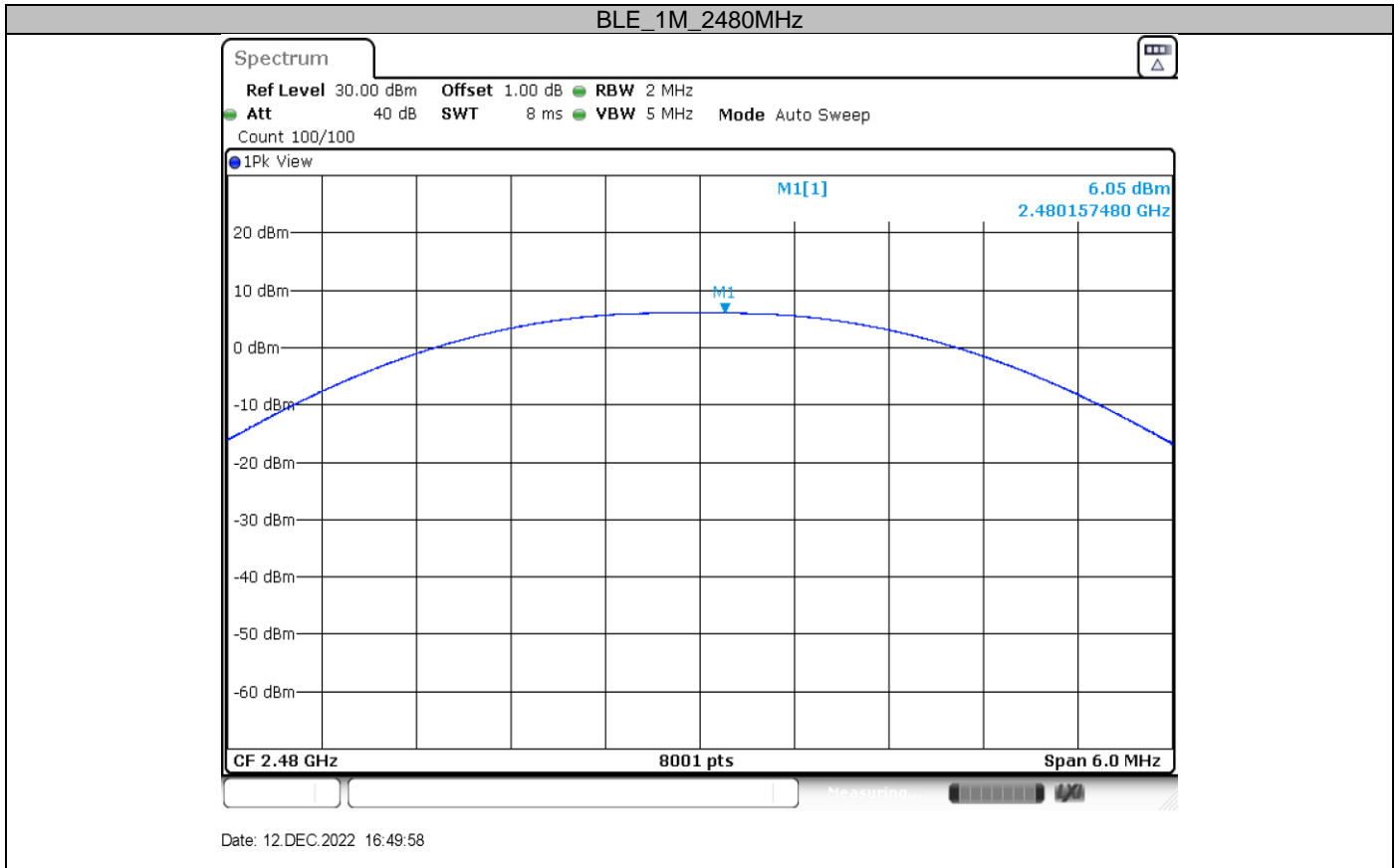



### 9.3 6dB bandwidth

#### Test Method

1. The RF output of EUT was connected to the spectrum analyzer. The path loss was compensated to the results for each measurement.
2. Set to the maximum power setting, the instrument center frequency is set to the nominal EUT channel center frequency enable the EUT transmit continuously.
3. Use the following spectrum analyzer settings:  
RBW=100KHz, VBW≥3RBW, Sweep = auto, Detector function = peak, Trace = max hold
4. Use the automatic bandwidth measurement capability of an instrument, use the X dB bandwidth mode with X set to 6 dB.
5. Allow the trace to stabilize, record the 6 dB Bandwidth value.

#### Limit

Limit [kHz]

≥500

#### Test result

Test Mode	Channel (MHz)	Result (MHz)	Limit (kHz)	Verdict
BLE 1M	2402	0.668	≥500	PASS
	2440	0.660	≥500	PASS
	2480	0.668	≥500	PASS

#### Test Graphs

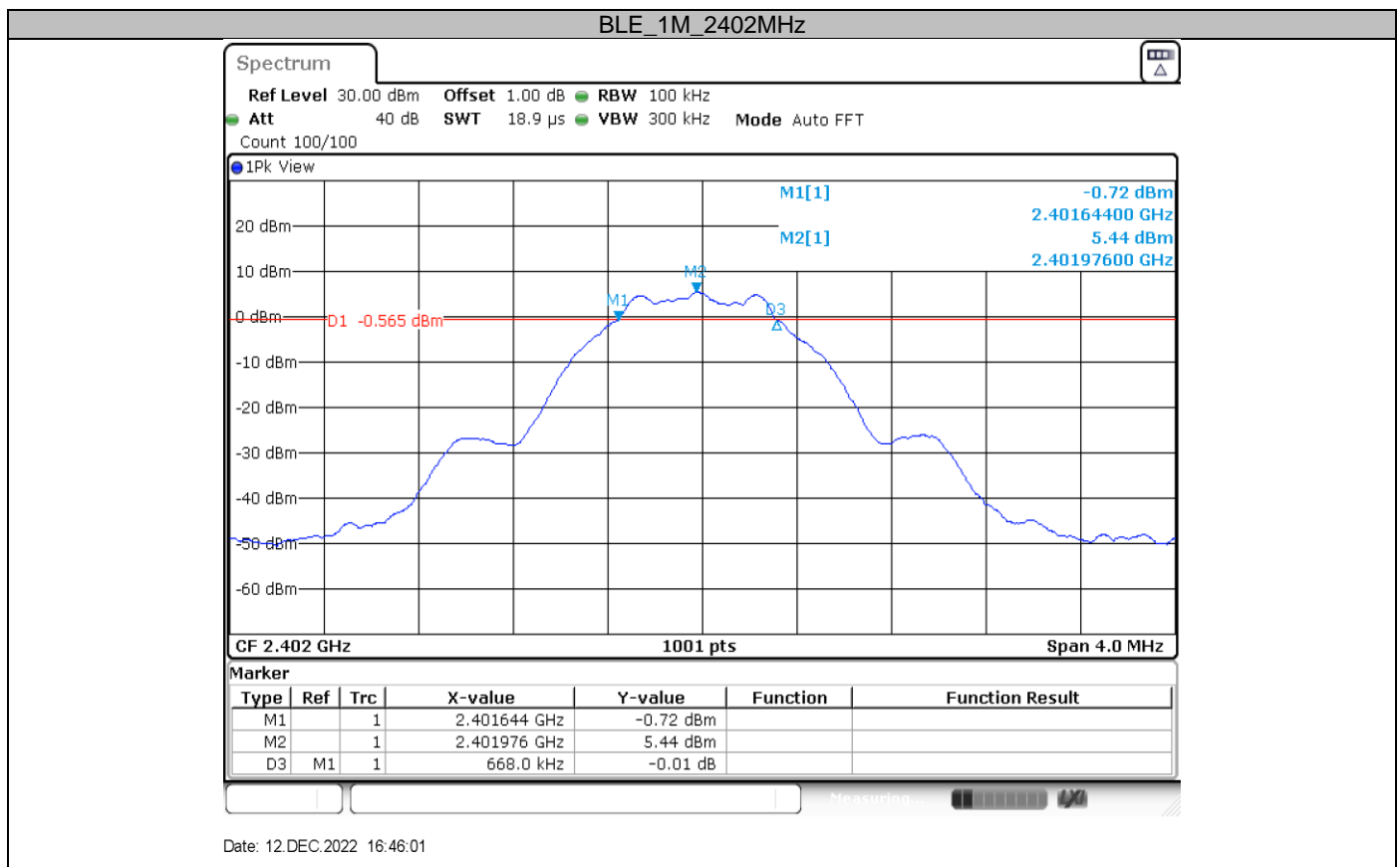

BLE\_1M\_2440MHz

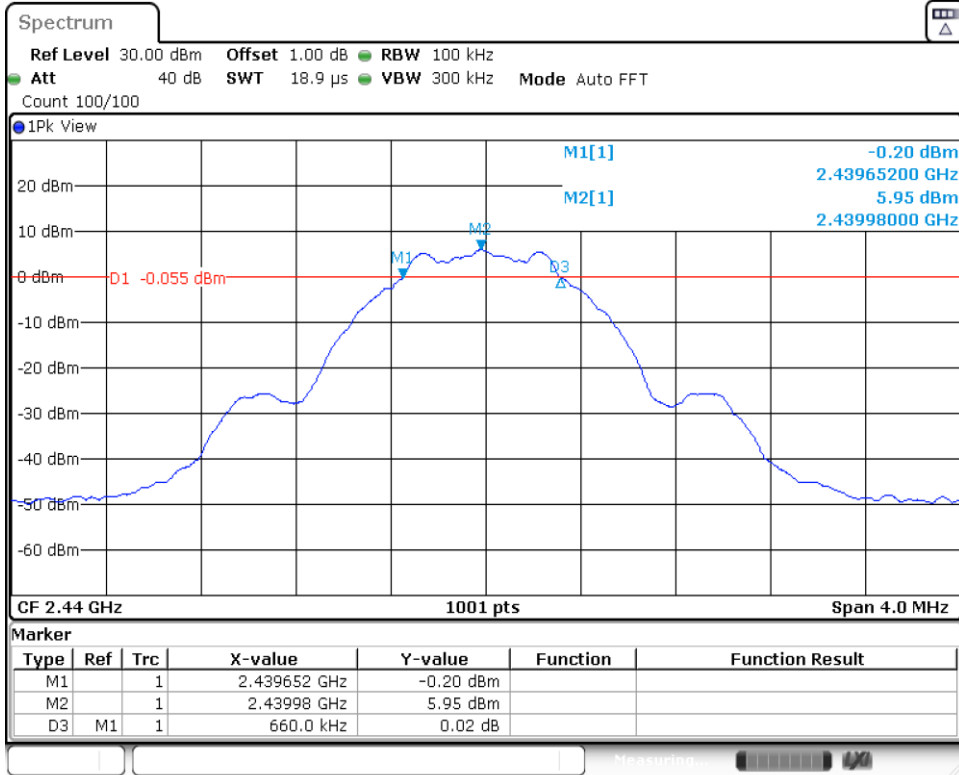

Date: 12.DEC.2022 16:47:47

BLE\_1M\_2480MHz

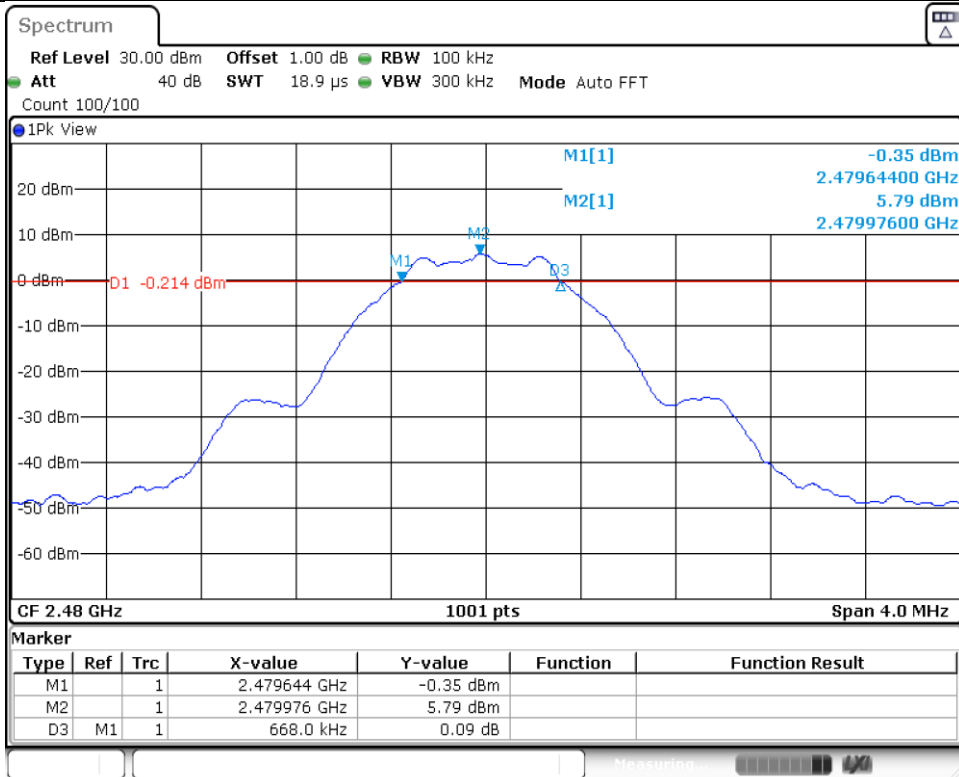

Date: 12.DEC.2022 16:49:41

## 9.4 99% bandwidth

### Test Method

1. Connect EUT test port to spectrum analyzer.
2. Use the following spectrum analyzer settings:  
 RBW=1% to 5% of the actual occupied, VBW $\geq$ 3RBW, Sweep = auto,  
 Detector function = peak, Trace = max hold
3. Use the automatic bandwidth measurement capability of an instrument, care shall be taken so that the bandwidth measurement is not influenced by any intermediate power nulls in the fundamental emission that might be  $\geq 6$  dB.
4. Allow the trace to stabilize, record the X dB Bandwidth value.

### Limit

Limit [kHz]

--

### Test result

Test Mode	Channel (MHz)	Result (MHz)	Limit	Verdict
BLE 1M	2402	1.023	---	PASS
	2440	1.027	---	PASS
	2480	1.023	---	PASS

### Test Graphs

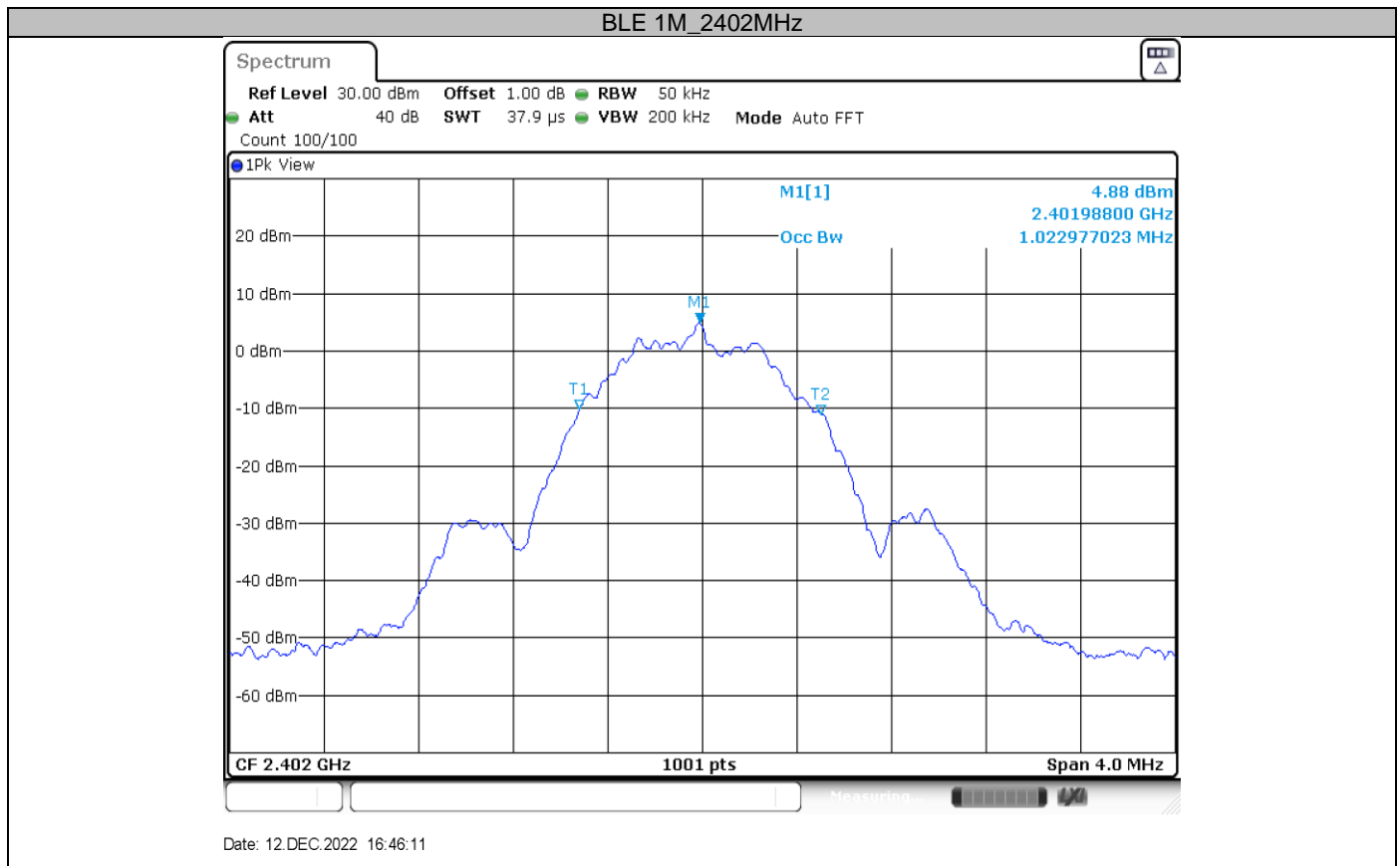

BLE 1M\_2440MHz

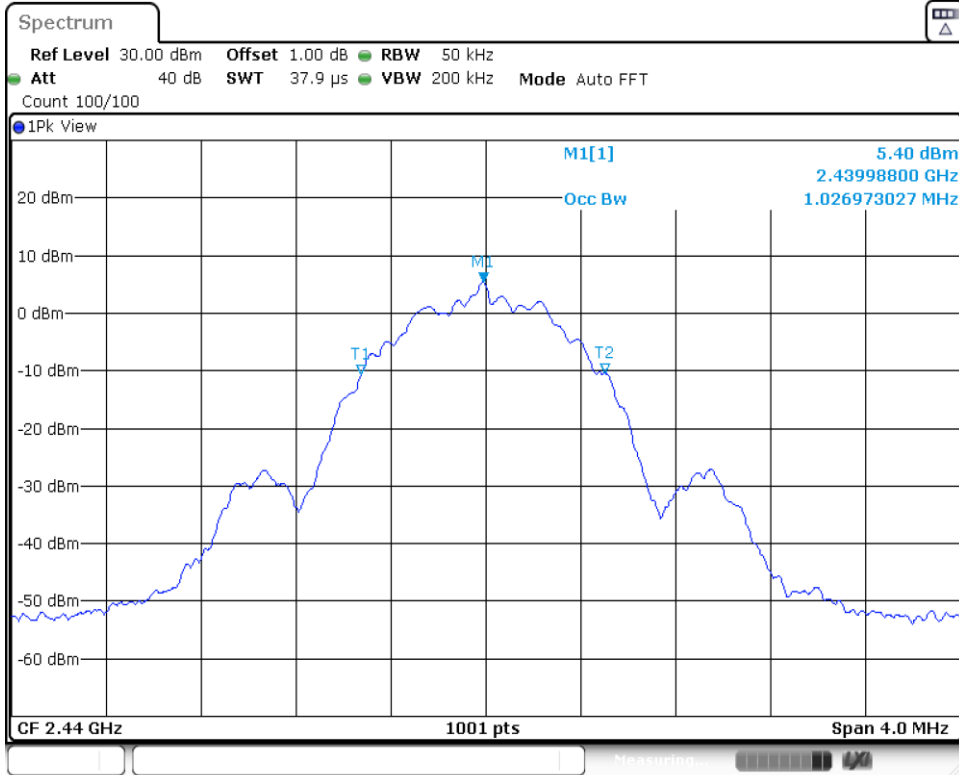

Date: 12 DEC.2022 16:47:57

BLE 1M\_2480MHz

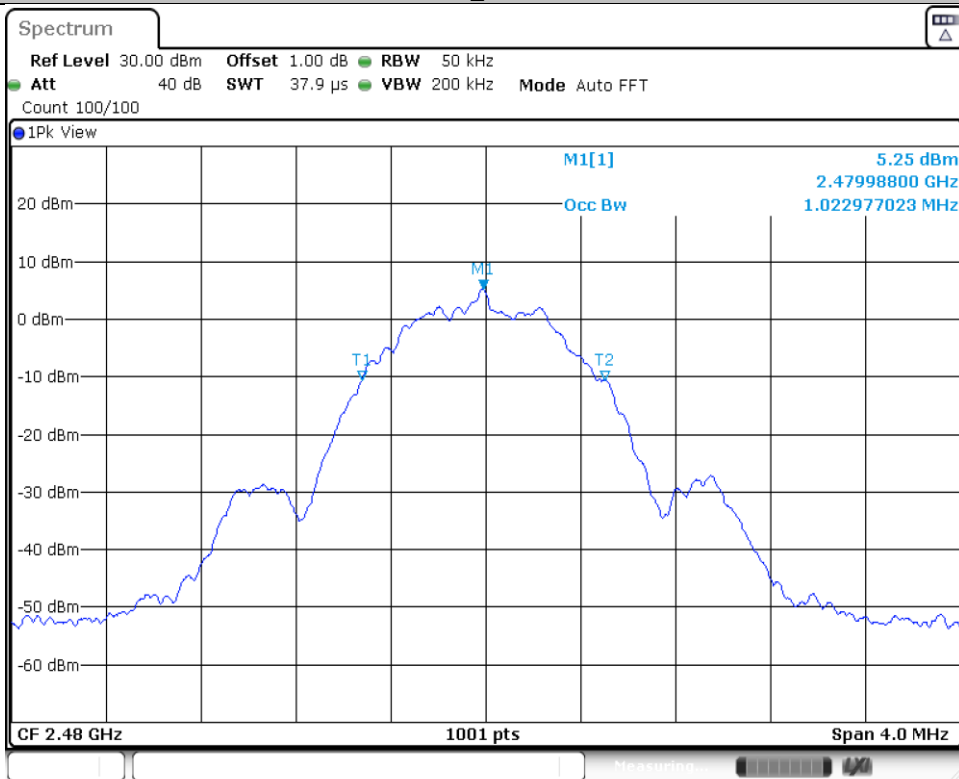

Date: 12 DEC.2022 16:49:52

## 9.5 Power spectral density

### Test Method

This procedure shall be used if maximum peak conducted output power was used to demonstrate compliance:

1. The RF output of EUT was connected to the spectrum analyzer. The path loss was compensated to the results for each measurement.
2. Set to the maximum power setting, the instrument center frequency is set to the nominal EUT channel center frequency enable the EUT transmit continuously.
3. Use the following spectrum analyzer settings:
4. Set analyzer center frequency to DTS channel center frequency. RBW=3kHz, VBW≥3RBW, Span=1.5 times DTS bandwidth, Detector=Peak, Sweep=auto, Trace= max hold.
5. Allow trace to fully stabilize, use the peak marker function to determine the maximum amplitude level within the RBW.
6. Repeat above procedures until other frequencies measured were completed.

### Limit

Limit [dBm/3kHz]

≤8

### Test result

Test Mode	Channel (MHz)	Result (dBm/3KHz)	Limit(dBm/3kHz)	Verdict
BLE 1M	2402	-9.57	8	PASS
	2440	-10.40	8	PASS
	2480	-10.12	8	PASS

### Test Graphs

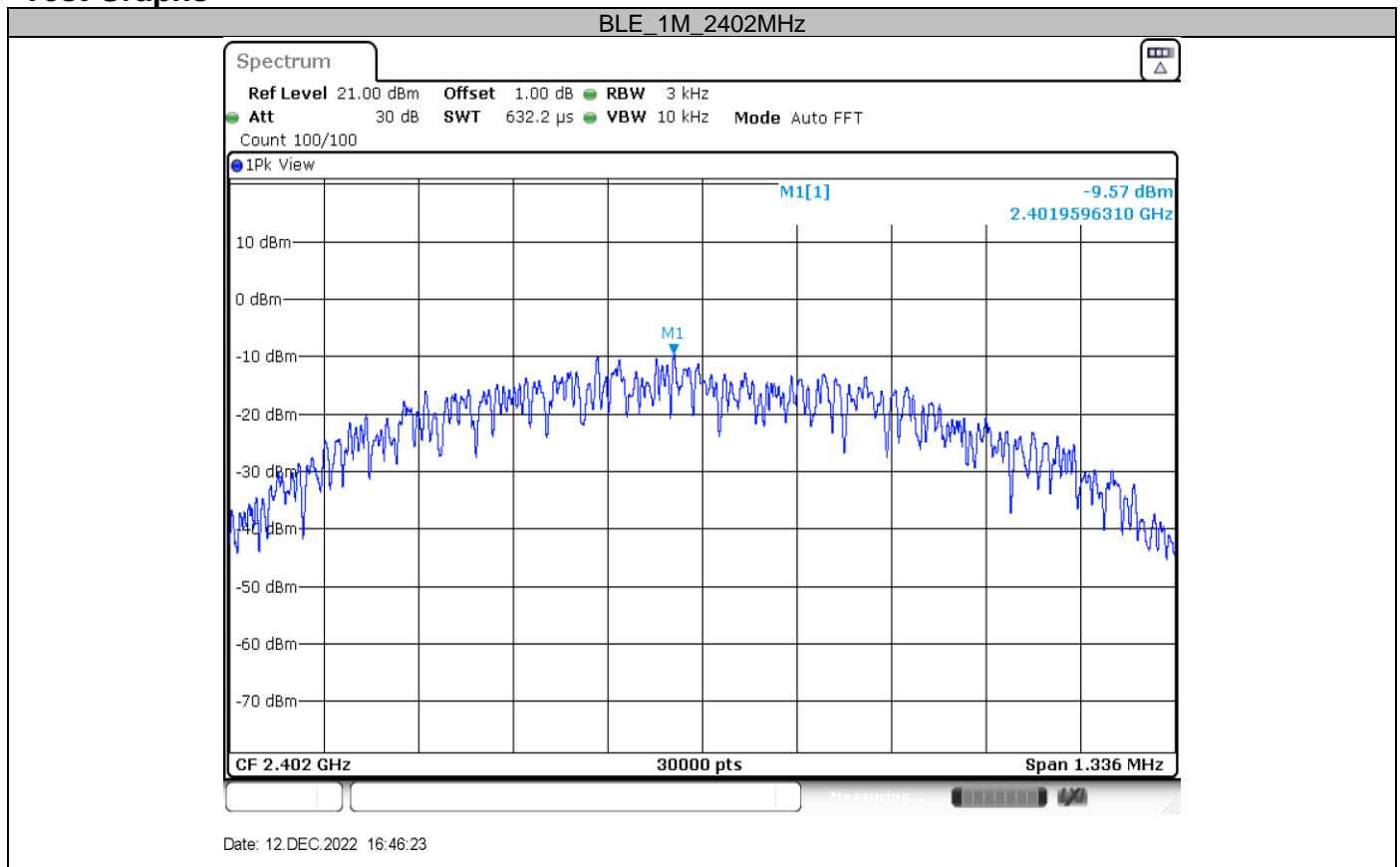

BLE\_1M\_2440MHz

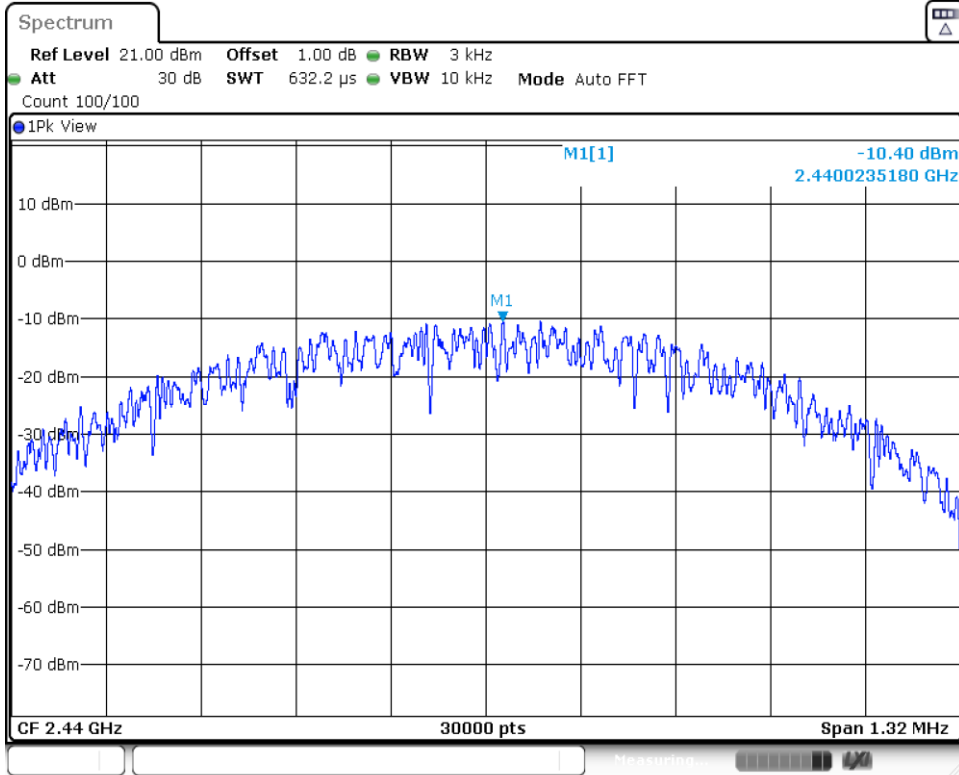

Date: 12 DEC.2022 16:48:10

BLE\_1M\_2480MHz

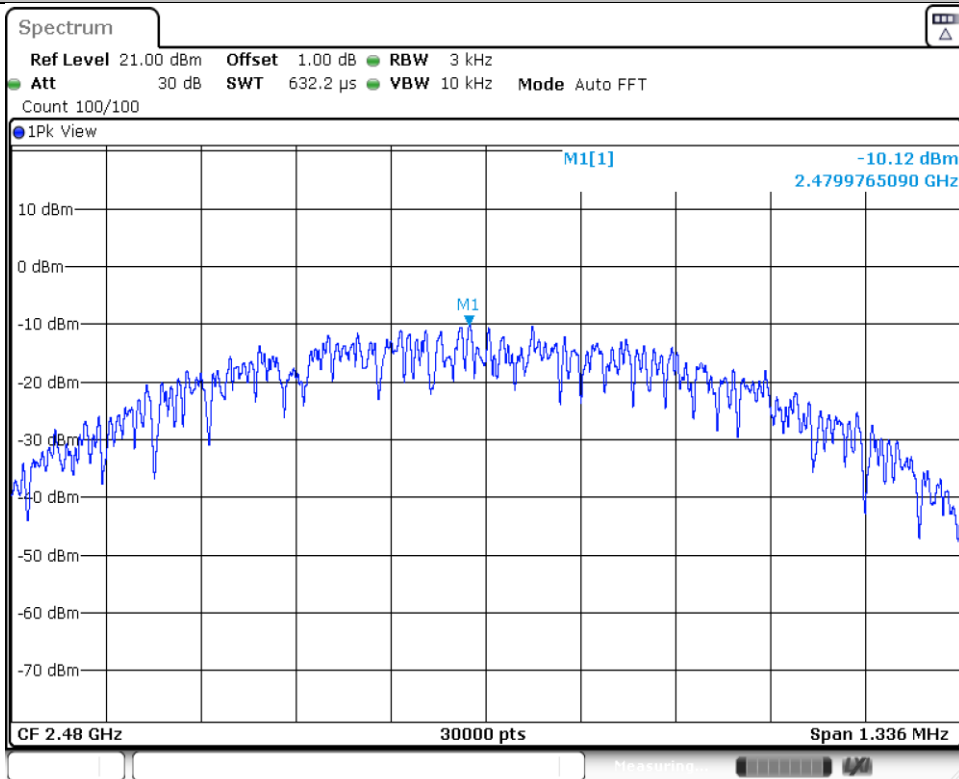

Date: 12 DEC.2022 16:50:04

## 9.6 Spurious RF conducted emissions

### Test Method

1. The RF output of EUT was connected to the spectrum analyzer by RF cable. The path loss was compensated to the results for each measurement.
2. Set to the maximum power setting, the instrument center frequency is set to the nominal EUT channel center frequency enable the EUT transmit continuously.
3. Use the following spectrum analyzer settings:  
Span = wide enough to capture the peak level of the in-band emission and all spurious emissions (e.g., harmonics) from the lowest frequency generated in the EUT up through the 10<sup>th</sup> harmonic. Typically, several plots are required to cover this entire span.  
RBW = 100 kHz, VBW $\geq$ 3RBW, Sweep = auto, Detector function = peak, Trace = max hold
4. Allow the trace to stabilize. Set the marker on the peak of any spurious emission recorded.
5. The level displayed must comply with the limit specified in this Section. Submit these plots.
6. Repeat above procedures until all frequencies measured were complete.

### Limit

In any 100 kHz bandwidth outside the frequency band in which the spread spectrum or digitally modulated device is operating, the RF power that is produced shall be at least 20 dB below that in the 100 kHz bandwidth within the band that contains the highest level of the desired power, based on either an RF conducted or a radiated measurement, provided that the transmitter demonstrates compliance with the peak conducted power limits. If the transmitter complies with the conducted power limits based on the use of RMS averaging over a time interval, as permitted under § 15.247(b)(3) and RSS 247 section 5.4(d), the attenuation required shall be 30 dB instead of 20 dB.

Frequency Range MHz	Limit (dBc)
30-25000	-20

**Test Result**

Remark: The emissions exceed limit is fundamental signal.

Test Mode	Channel (MHz)	Freq Range (MHz)	Ref Level (dBm)	Result (dBm)	Limit (dBm)	Verdict
BLE 1M	2402	Reference	5.43	5.43	---	PASS
		30~1000	---	-58.17	<=-14.57	PASS
		1000~26500	---	-49.12	<=-14.57	PASS
	2440	Reference	5.97	5.97	---	PASS
		30~1000	---	-58.26	<=-14.03	PASS
		1000~26500	---	-52.24	<=-14.03	PASS
	2480	Reference	5.75	5.75	---	PASS
		30~1000	---	-58.23	<=-14.25	PASS
		1000~26500	---	-51.93	<=-14.25	PASS

**Test Graphs**

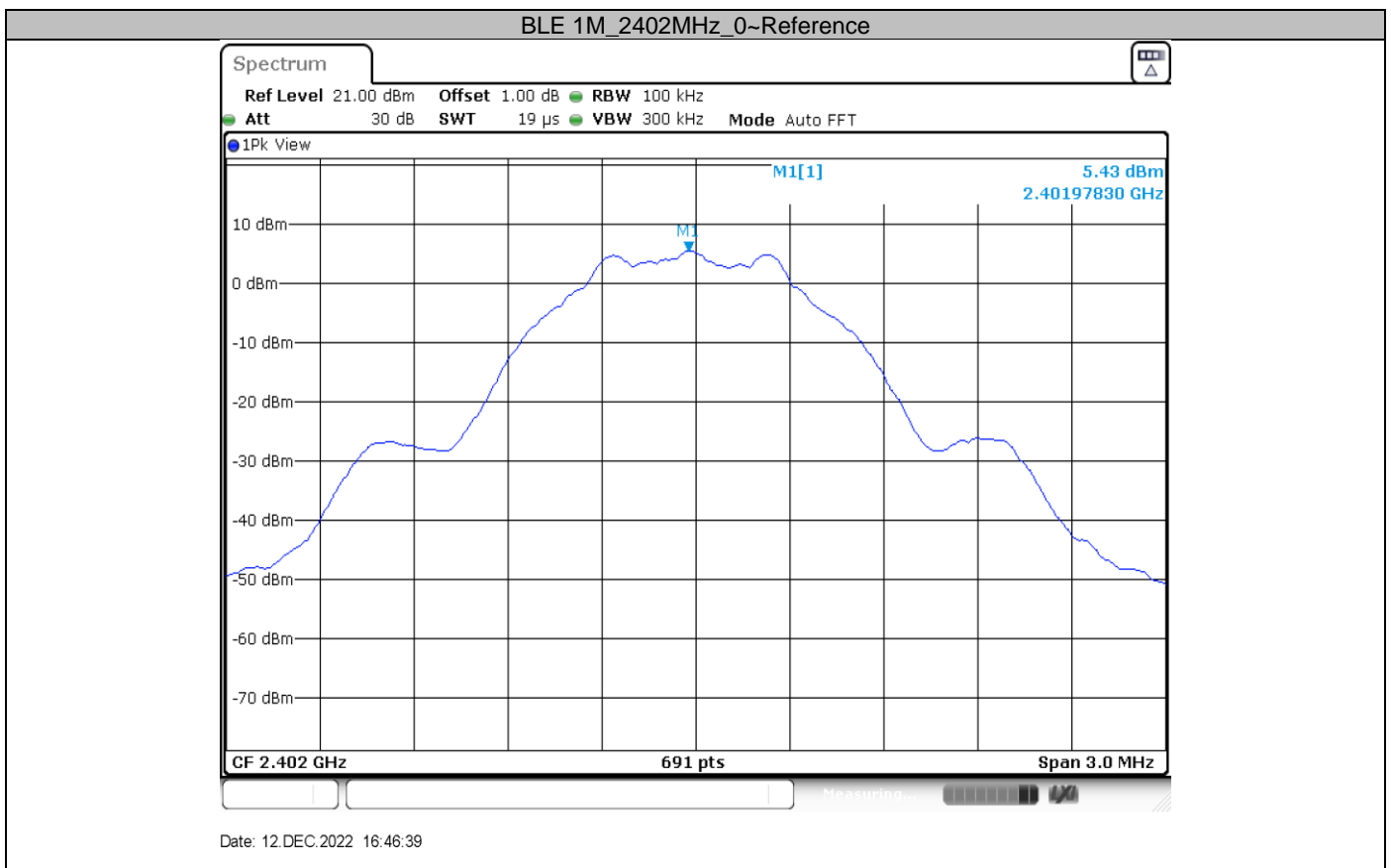

Date: 12.DEC.2022 16:46:39



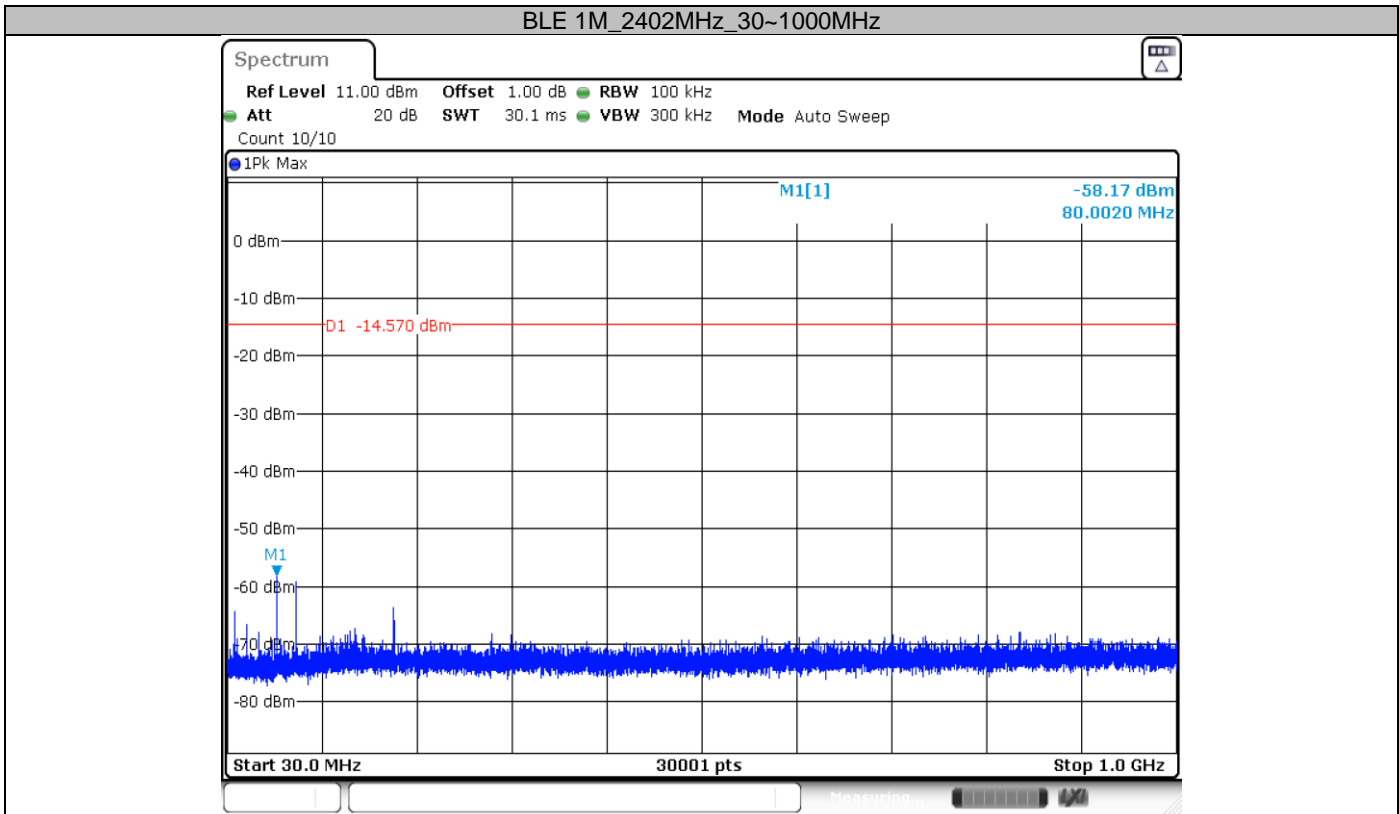

Date: 12.DEC.2022 16:46:45

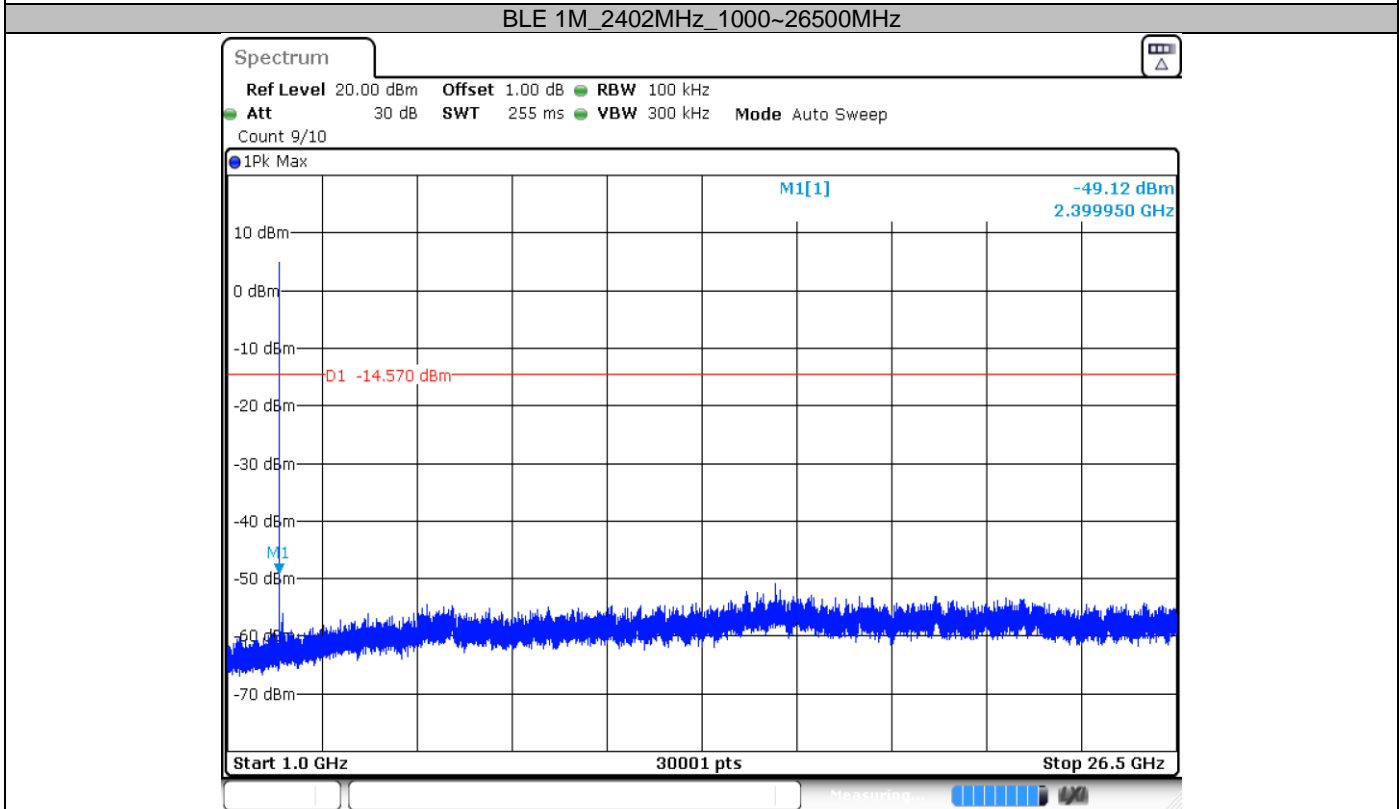

Date: 12.DEC.2022 16:46:53

BLE 1M\_2440MHz\_0~Reference

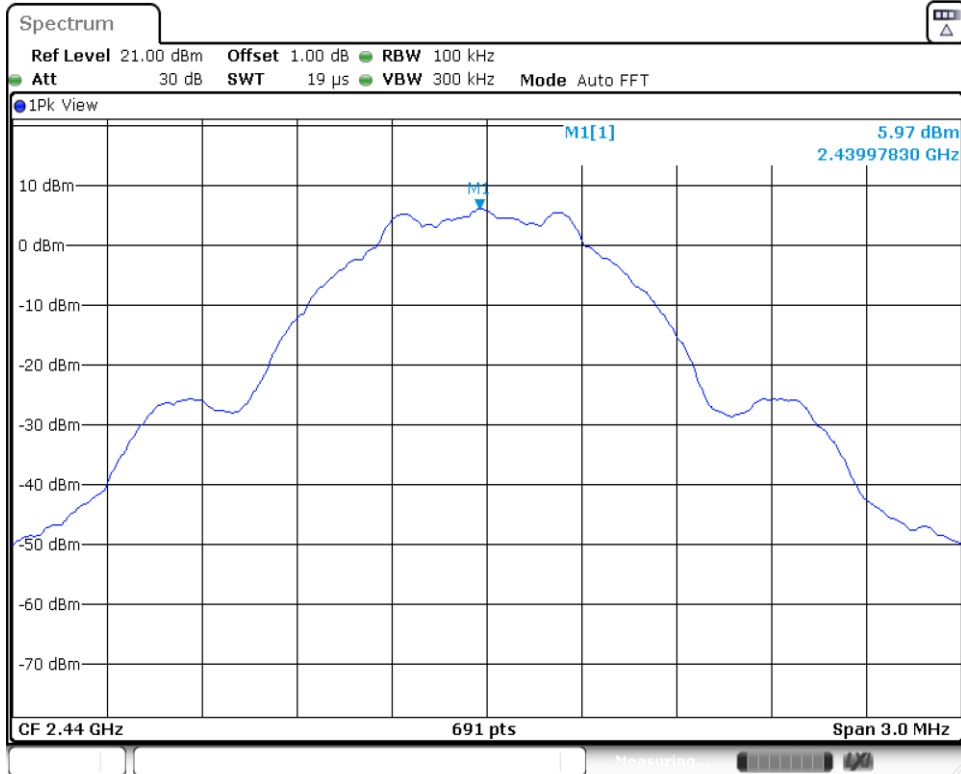

Date: 12.DEC.2022 16:48:15

BLE 1M\_2440MHz\_30~1000MHz

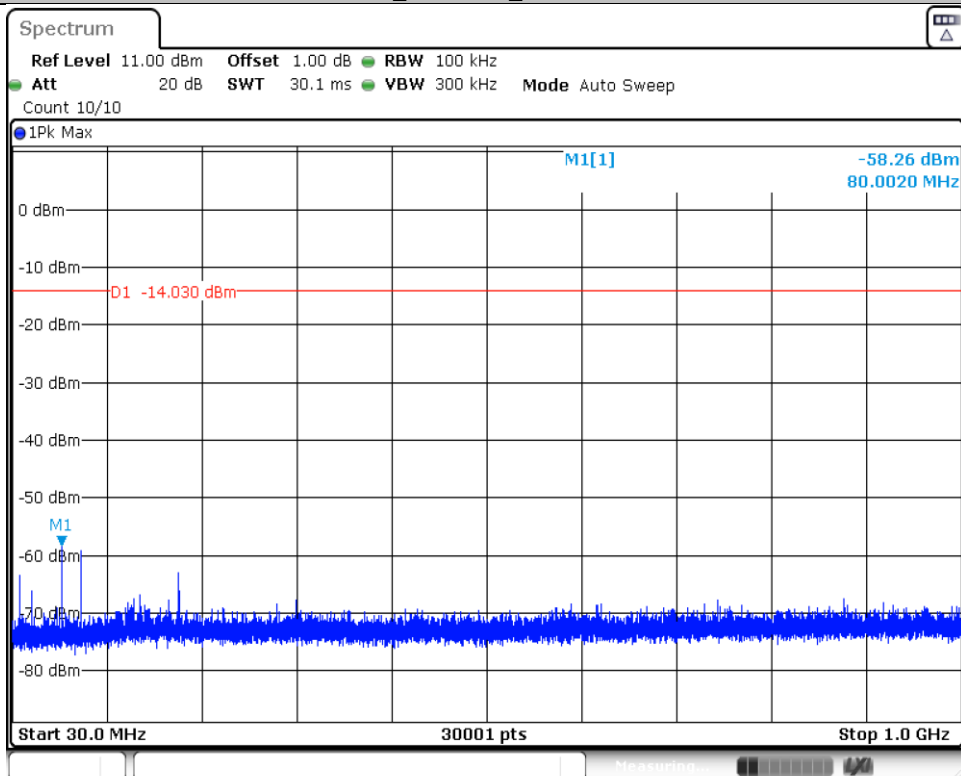

Date: 12.DEC.2022 16:48:21

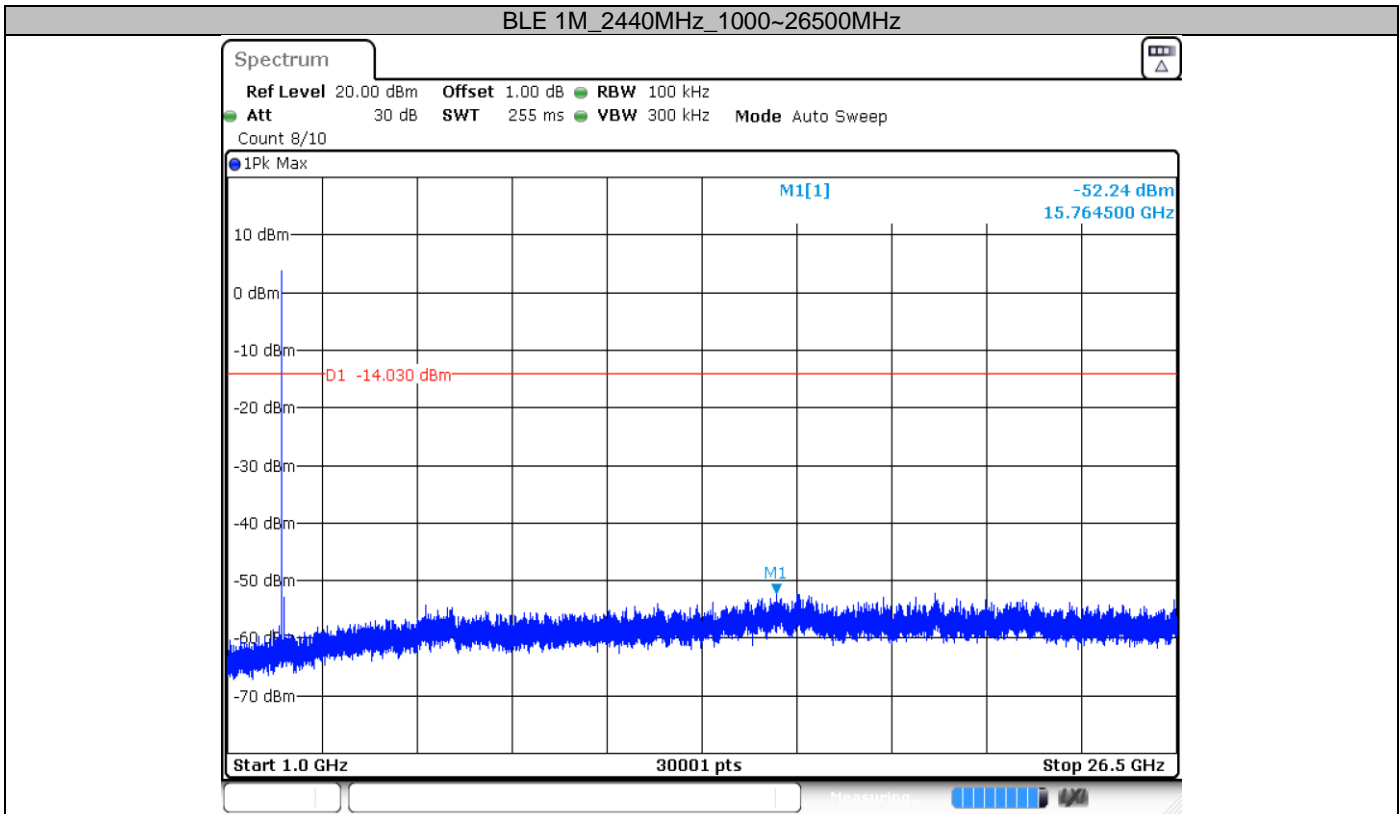

Date: 12.DEC.2022 16:48:29

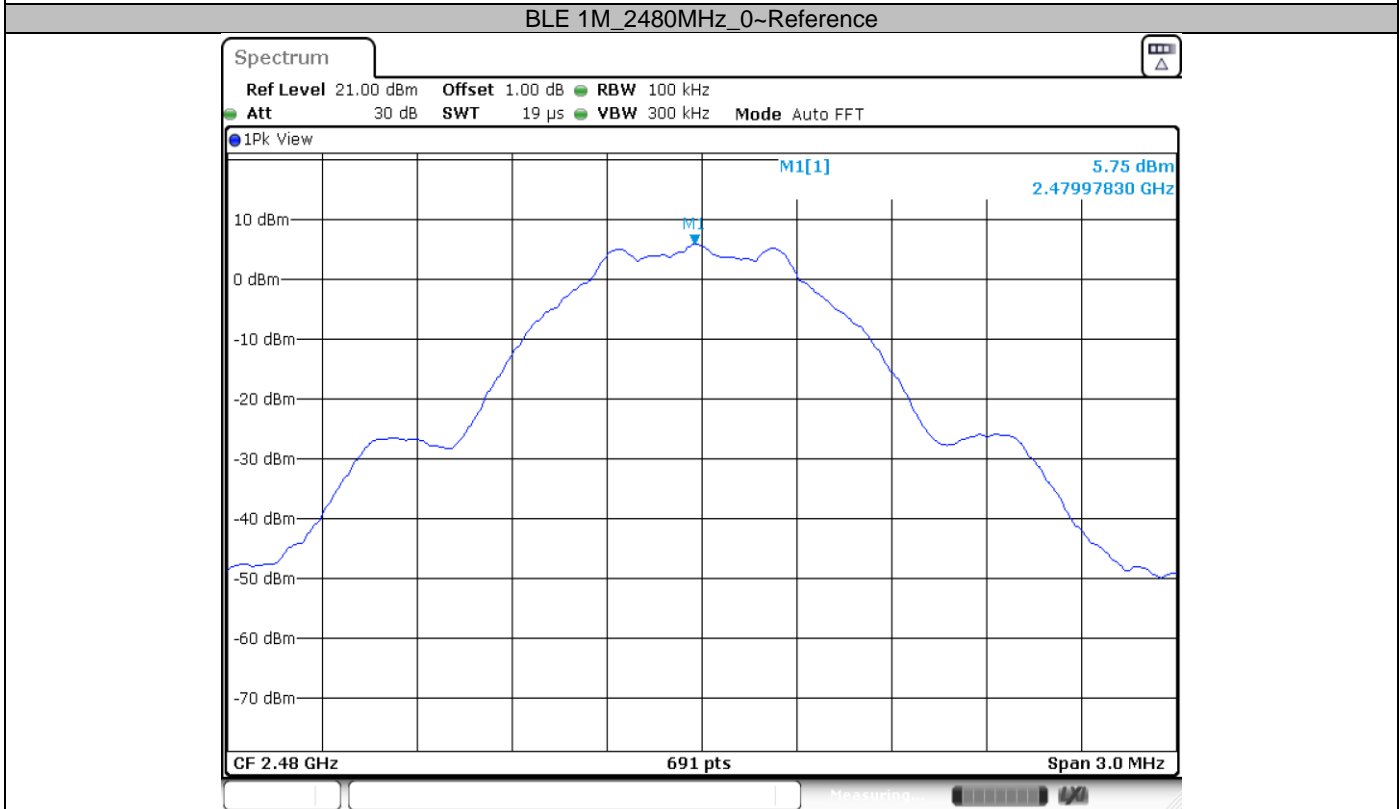

Date: 12.DEC.2022 16:50:18

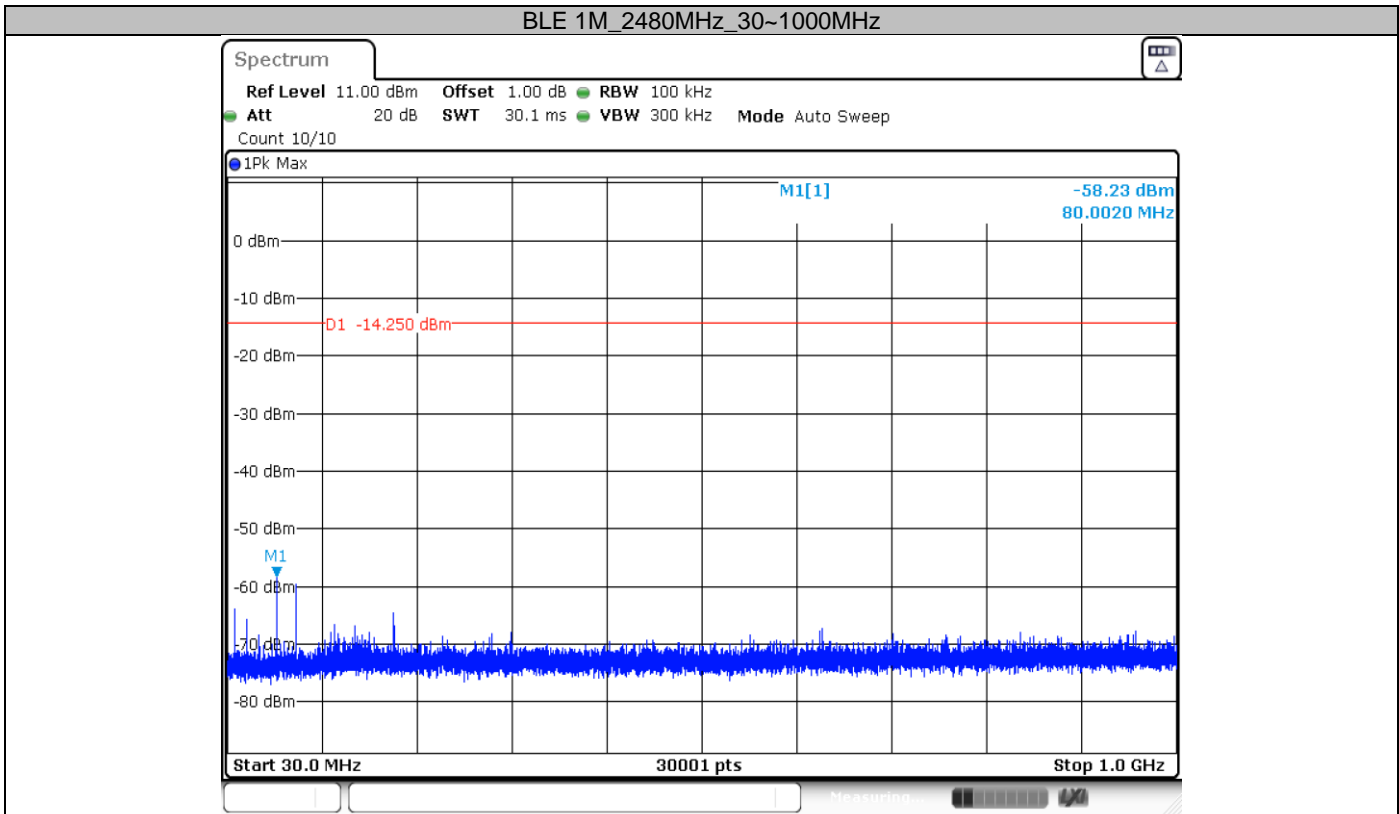

Date: 12.DEC.2022 16:50:24

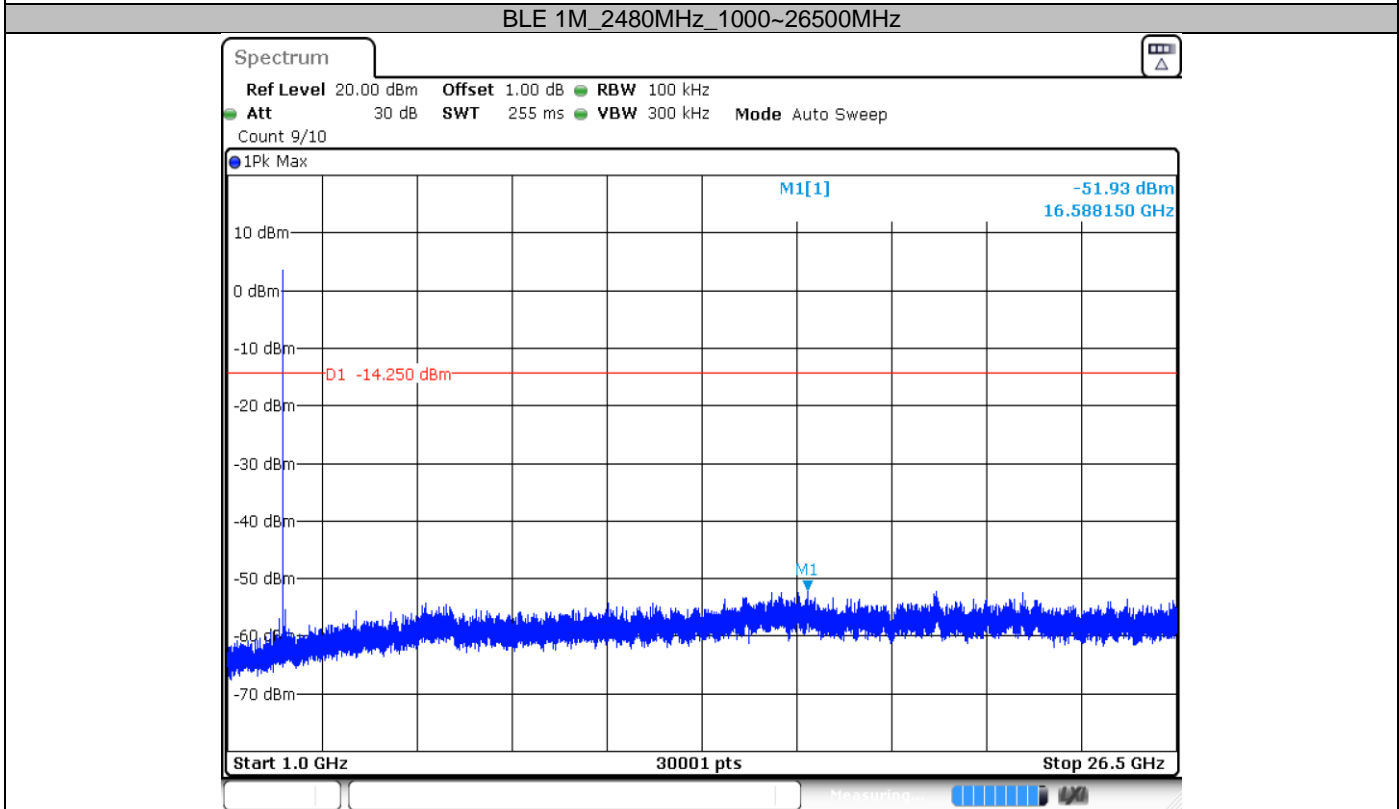

Date: 12.DEC.2022 16:50:32

## 9.7 Band edge

### Test Method

1. The RF output of EUT was connected to the spectrum analyzer by RF cable. The path loss was compensated to the results for each measurement.
2. Set to the maximum power setting, the instrument center frequency is set to the nominal EUT channel center frequency enable the EUT transmit continuously.
3. Use the following spectrum analyzer settings:  
Span = wide enough to capture the peak level of the in-band emission and all spurious  
RBW = 100 kHz, VBW $\geq$ 3RBW, Sweep = auto, Detector function = peak, Trace = max hold
4. Allow the trace to stabilize, use the peak and delta measurement to record the result.
5. The level displayed must comply with the limit specified in this Section.
6. Repeat above procedures until all frequencies measured were complete and submit all the plots.

### Limit:

In any 100 kHz bandwidth outside the frequency band in which the spread spectrum or digitally modulated device is operating, the RF power that is produced shall be at least 20 dB below that in the 100 kHz bandwidth within the band that contains the highest level of the desired power, based on either an RF conducted or a radiated measurement, provided that the transmitter demonstrates compliance with the peak conducted power limits. If the transmitter complies with the conducted power limits based on the use of RMS averaging over a time interval, as permitted under § 15.247(b)(3) and RSS-247 section 5.4(d), the attenuation required shall be 30 dB instead of 20 dB.

Frequency Range MHz	Limit (dBc)
30-25000	-20

### Test result

Test Mode	Channel (MHz)	Ref Level (dBm)	Result (dBm)	Limit (dBm)	Verdict
BLE 1M	2402	2.63	-55.75	<=-14.55	PASS
	2480	2.25	-55.92	<=-14.29	PASS

### Test Graphs

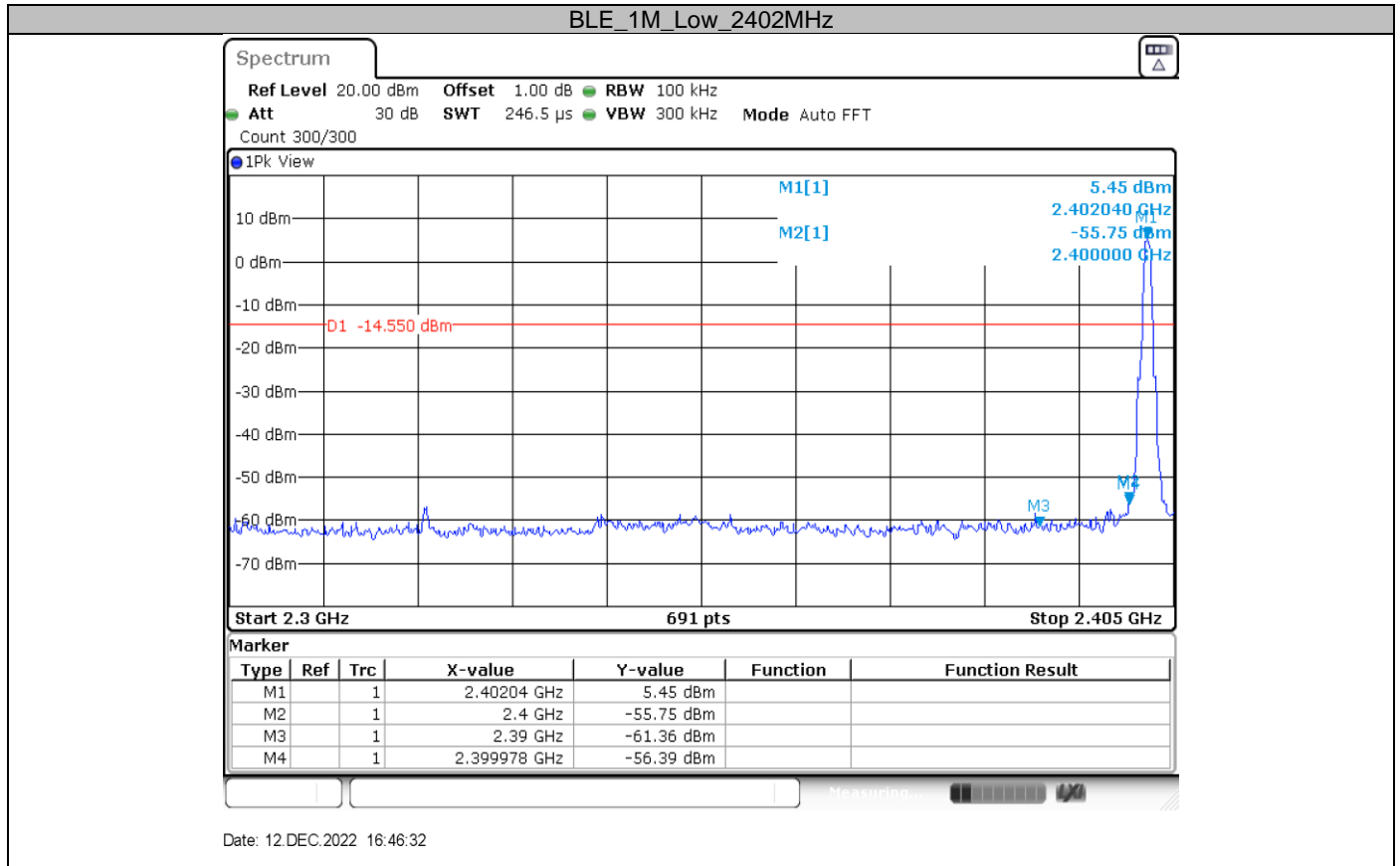

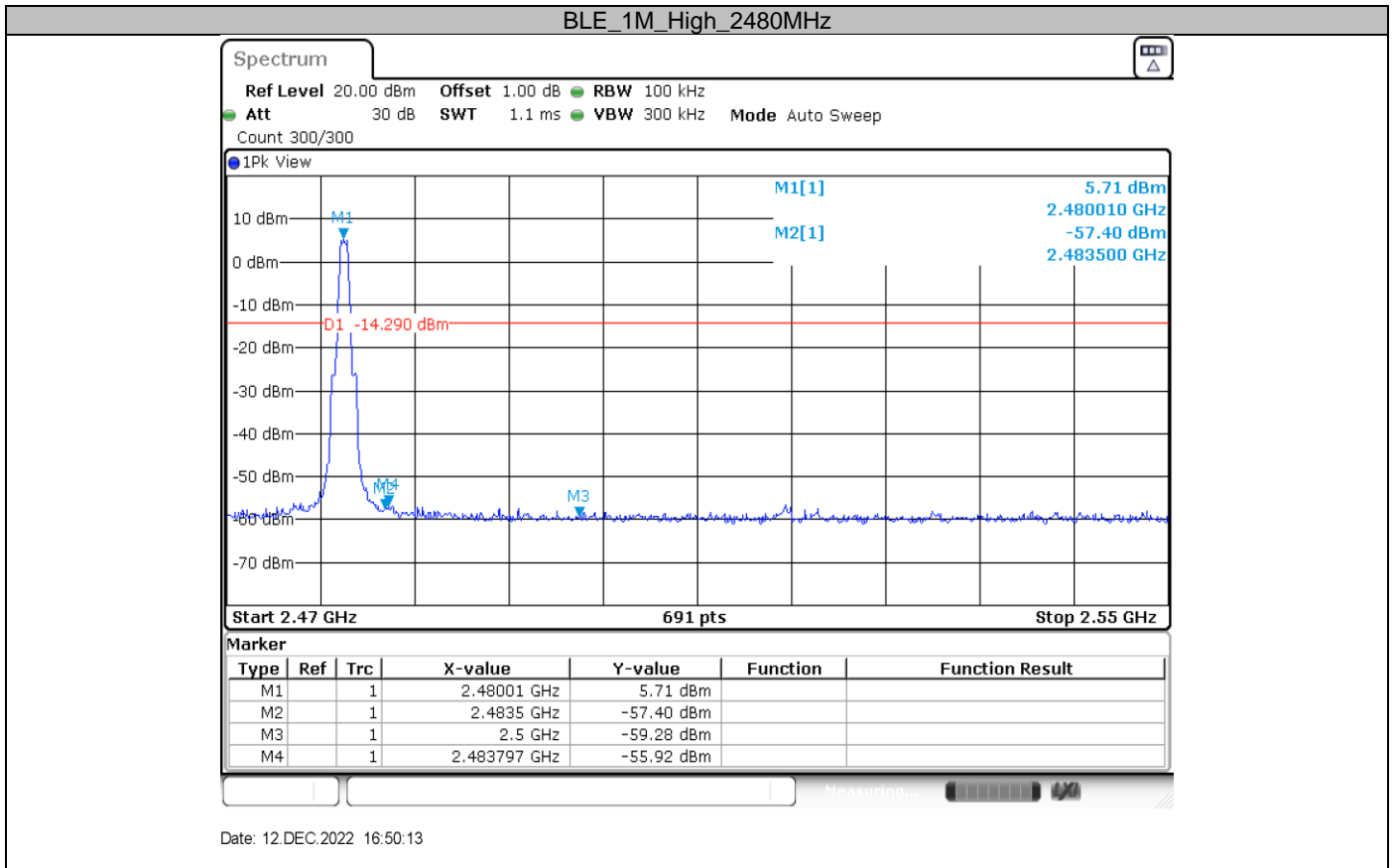

## 9.8 Spurious radiated emissions for transmitter

### Test Method

- 1: The EUT was placed on a turn table which is 1.5m above ground plane for above 1GHz and 0.8m above ground for below 1GHz at 3 meter chamber room for test. The table was rotated 360 degrees to determine the position of the highest radiation.
- 2: The EUT was set 3 meters away from the interference – receiving antenna, which was mounted on the top of a variable – height antenna tower.
- 3: The height of antenna is varied from one meter to four meters above the ground to determine the maximum value of the field strength. Both horizontal and vertical polarizations of the antenna are set to make the measurement.
- 4: For each suspected emission, the EUT was arranged to its worst case and then the antenna was tuned to heights from 1 meter to 4 meters and the rotatable table was turned from 0 degrees to 360 degrees to find the maximum reading.
- 5: Use the following spectrum analyzer settings According to C63.10:

For Below 1GHz

Use the following spectrum analyzer settings:

Span = wide enough to capture the peak level of the in-band emission and all spurious  
 RBW = 100 KHz to 120KHz, VBW $\geq$ RBW for peak measurement, Sweep = auto, Detector function = peak, Trace = max hold.

For Peak unwanted emissions Above 1GHz:

Span = wide enough to capture the peak level of the in-band emission and all spurious  
 RBW = 1MHz, VBW $\geq$ RBW for peak measurement, Sweep = auto, Detector function = peak, Trace = max hold.

Procedures for average unwanted emissions measurements above 1000 MHz

- a) RBW = 1MHz.
- b) VBW \ [3  $\times$  RBW].
- c) Detector = RMS (power averaging), if [span / (# of points in sweep)] \ RBW / 2. Satisfying this condition can require increasing the number of points in the sweep or reducing the span. If the condition is not satisfied, then the detector mode shall be set to peak.
- d) Averaging type = power (i.e., rms) (As an alternative, the detector and averaging type may be set for linear voltage averaging. Some instruments require linear display mode to use linear voltage averaging. Log or dB averaging shall not be used.)
- e) Sweep time = auto.
- f) Perform a trace average of at least 100 traces if the transmission is continuous. If the transmission is not continuous, then the number of traces shall be increased by a factor of 1 / D, where D is the duty cycle. For example, with 50% duty cycle, at least 200 traces shall be averaged. (If a specific emission is demonstrated to be continuous—i.e., 100% duty cycle—then rather than turning ON and OFF with the transmit cycle, at least 100 traces shall be averaged.)
- g) If tests are performed with the EUT transmitting at a duty cycle less than 98%, then a correction factor shall be added to the measurement results prior to comparing with the emission limit, to compute the emission level that would have been measured had the test been performed at 100% duty cycle. The correction factor is computed as follows:
  - 1) If power averaging (rms) mode was used in the preceding step e), then the correction factor is [10 log (1 / D)], where D is the duty cycle. For example, if the transmit duty cycle was 50%, then 3 dB shall be added to the measured emission levels.
  - 2) If linear voltage averaging mode was used in the preceding step e), then the correction



factor is  $[20 \log (1 / D)]$ , where D is the duty cycle. For example, if the transmit duty cycle was 50%, then 6 dB shall be added to the measured emission levels.

3) If a specific emission is demonstrated to be continuous (100% duty cycle) rather than turning ON and OFF with the transmit cycle, then no duty cycle correction is required for that emission.

### Limit

In any 100 kHz bandwidth outside the frequency band in which the spread spectrum or digitally modulated device is operating, the RF power that is produced shall be at least 20 dB below that in the 100 kHz bandwidth within the band that contains the highest level of the desired power, based on either an RF conducted or a radiated measurement, provided that the transmitter demonstrates compliance with the peak conducted power limits. If the transmitter complies with the conducted power limits based on the use of RMS averaging over a time interval, as permitted under § 15.247(b)(3) and RSS 247 section 5.4(d), the attenuation required shall be 30 dB instead of 20 dB. Attenuation below the general field strength limits specified in § 15.209(a) and RSS-Gen is not required. In addition, radiated emissions which fall in the restricted bands, as defined in § 15.205(a) and RSS-Gen section 8.9, must also comply with the radiated emission limits specified in § 15.209(a) and RSS-Gen section 8.10.

Frequency MHz	Field Strength uV/m	Field Strength dBµV/m	Detector
30-88	100	40	QP
88-216	150	43.5	QP
216-960	200	46	QP
960-1000	500	54	QP
Above 1000	500	54	AV
Above 1000	5000	74	PK

### Spurious radiated emissions for transmitter

According to C63.10, if the peak (or quasi-peak) measured value complies with the average limit, it is unnecessary to perform an average measurement, so AV emission value did not show in below table if the peak value complies with average limit.

### Transmitting spurious emission test result as below:

Below 1G:

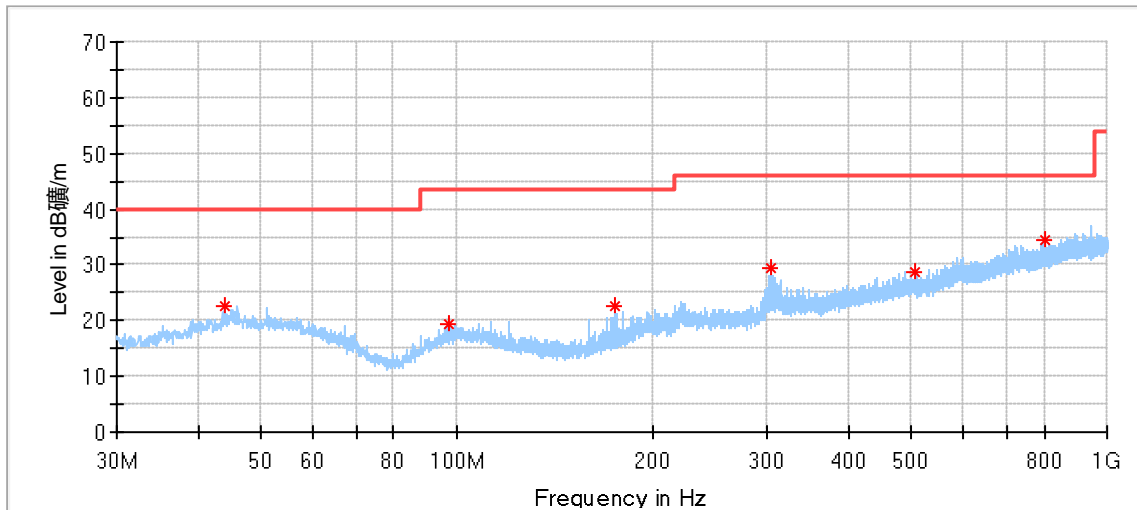

Frequency (MHz)	MaxPeak (dBµV/m)	Limit (dBµV/m)	Margin (dB)	Height (cm)	Pol	Azimuth (deg)	Corr. (dB/m)
43.903333	22.57	40.00	17.43	100.0	H	260.0	20.43
97.361111	19.44	43.50	24.06	200.0	H	107.0	18.07
175.500000	22.75	43.50	20.75	100.0	H	313.0	16.26
303.647778	29.28	46.00	16.72	100.0	H	146.0	20.98
508.210000	28.83	46.00	17.17	200.0	H	56.0	25.54
800.018333	34.58	46.00	11.42	100.0	H	230.0	30.12

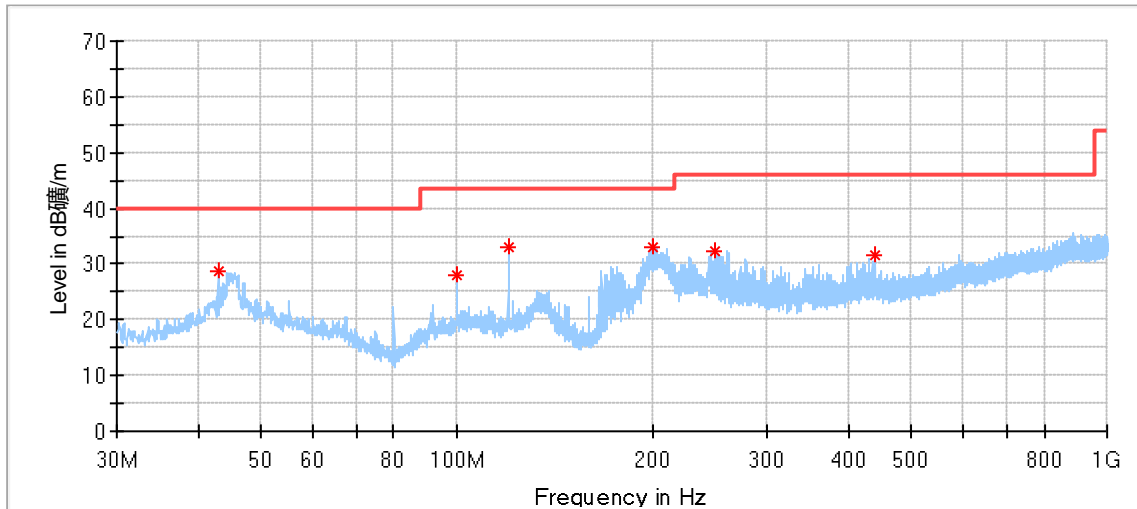

Frequency (MHz)	MaxPeak (dBµV/m)	Limit (dBµV/m)	Margin (dB)	Height (cm)	Pol	Azimuth (deg)	Corr. (dB/m)
42.987222	28.88	40.00	11.12	100.0	V	10.0	20.16
99.947778	27.99	43.50	15.51	100.0	V	268.0	18.30
119.994444	33.08	43.50	10.42	100.0	V	18.0	16.51
200.720000	32.93	43.50	10.57	100.0	V	59.0	18.39
250.082222	32.42	46.00	13.58	100.0	V	110.0	20.05
439.124444	31.72	46.00	14.28	100.0	V	38.0	24.20

Low channel 2402MHz

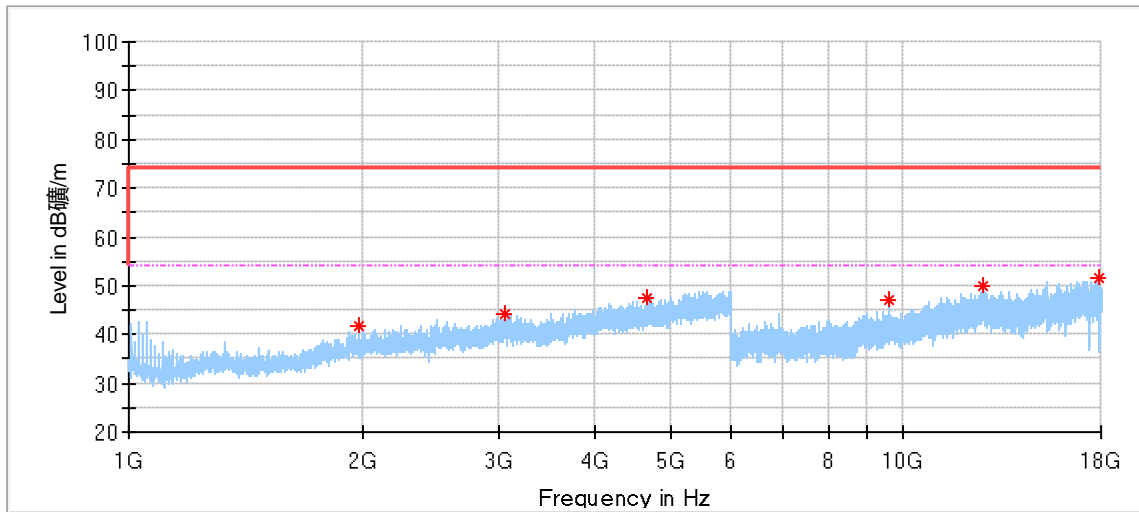

Frequency (MHz)	MaxPeak (dBµV/m)	Limit (dBµV/m)	Margin (dB)	Height (cm)	Pol	Azimuth (deg)	Corr. (dB/m)
1977.000000	41.79	74.00	32.21	150.0	H	121.0	-4.47
3058.000000	44.06	74.00	29.94	150.0	H	0.0	-0.45
4676.500000	47.55	74.00	26.45	150.0	H	130.0	3.57
9608.000000	46.88	74.00	27.12	150.0	H	331.0	13.15
12642.500000	49.81	74.00	24.19	150.0	H	0.0	18.64
17920.000000	51.58	74.00	22.42	150.0	H	162.0	23.58

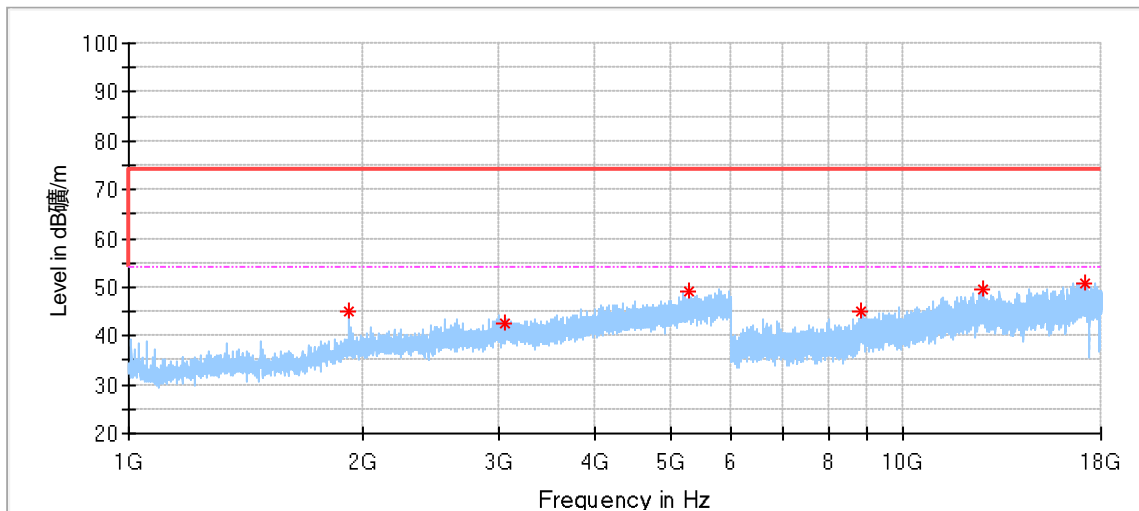

Frequency (MHz)	MaxPeak (dBµV/m)	Limit (dBµV/m)	Margin (dB)	Height (cm)	Pol	Azimuth (deg)	Corr. (dB/m)
1921.500000	44.85	74.00	29.15	150.0	V	4.0	-4.89
3061.000000	42.72	74.00	31.28	150.0	V	326.0	-0.48
5292.500000	49.26	74.00	24.74	150.0	V	335.0	5.27
8834.000000	45.22	74.00	28.78	150.0	V	330.0	13.15
12680.000000	49.39	74.00	24.61	150.0	V	244.0	18.21
17160.500000	50.90	74.00	23.11	150.0	V	244.0	24.21

Middle channel 2440MHz

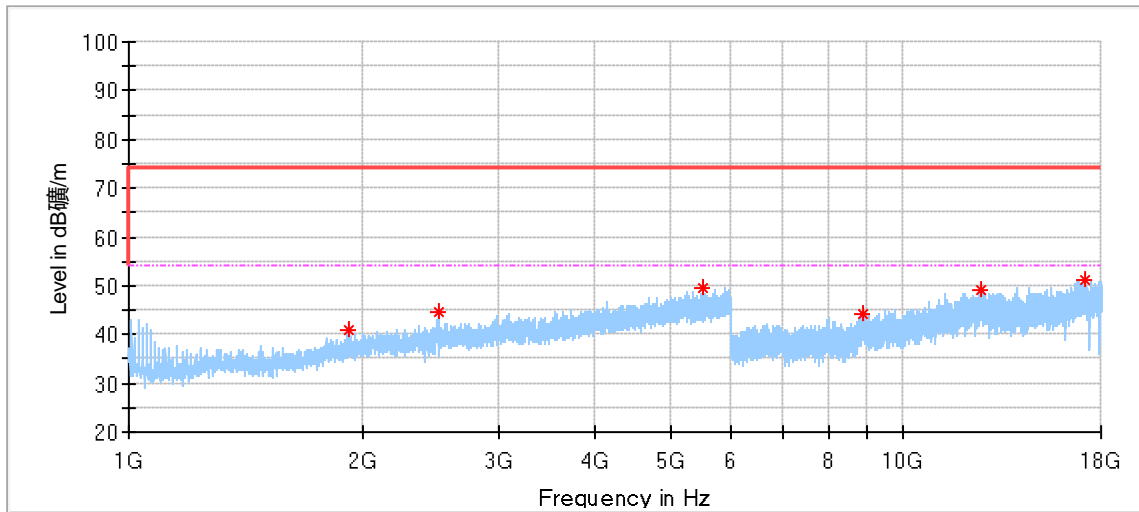

Frequency (MHz)	MaxPeak (dBµV/m)	Limit (dBµV/m)	Margin (dB)	Height (cm)	Pol	Azimuth (deg)	Corr. (dB/m)
1923.500000	40.86	74.00	33.14	150.0	H	94.0	-4.84
2520.000000	44.48	74.00	29.52	150.0	H	355.0	-2.20
5522.500000	49.36	74.00	24.64	150.0	H	41.0	5.67
8858.000000	44.39	74.00	29.61	150.0	H	80.0	13.20
12628.500000	49.14	74.00	24.86	150.0	H	80.0	18.49
17186.500000	51.33	74.00	22.67	150.0	H	54.0	24.24

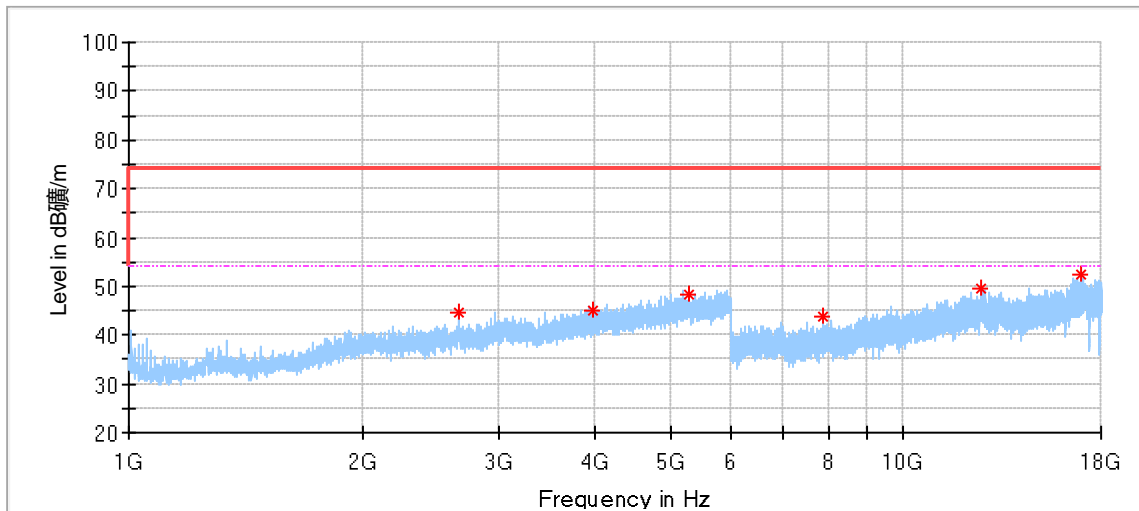

Frequency (MHz)	MaxPeak (dBµV/m)	Limit (dBµV/m)	Margin (dB)	Height (cm)	Pol	Azimuth (deg)	Corr. (dB/m)
2663.000000	44.48	74.00	29.52	150.0	V	0.0	-2.06
3968.000000	45.08	74.00	28.92	150.0	V	157.0	1.25
5282.500000	48.25	74.00	25.75	150.0	V	201.0	5.27
7882.500000	43.70	74.00	30.30	150.0	V	218.0	10.17
12624.000000	49.45	74.00	24.55	150.0	V	82.0	18.45
17001.500000	52.34	74.00	21.66	150.0	V	162.0	24.24

High channel 2480MHz

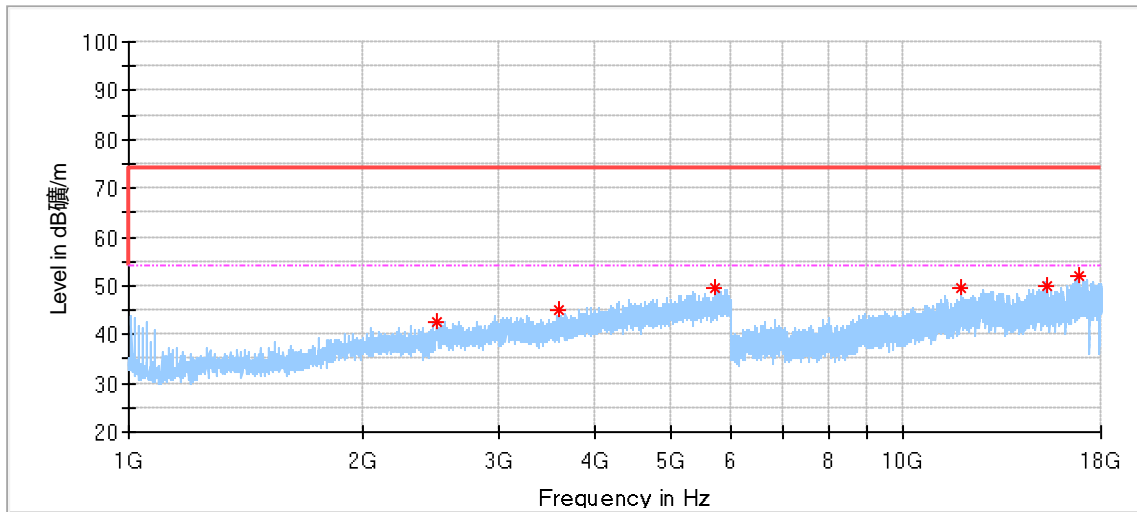

Frequency (MHz)	MaxPeak (dBµV/m)	Limit (dBµV/m)	Margin (dB)	Height (cm)	Pol	Azimuth (deg)	Corr. (dB/m)
2504.000000	42.72	74.00	31.28	150.0	H	358.0	-2.19
3587.500000	45.06	74.00	28.94	150.0	H	246.0	0.31
5711.000000	49.34	74.00	24.66	150.0	H	76.0	5.74
11867.000000	49.46	74.00	24.54	150.0	H	300.0	16.77
15301.000000	50.08	74.00	23.92	150.0	H	330.0	20.39
16816.000000	52.17	74.00	21.83	150.0	H	272.0	23.85

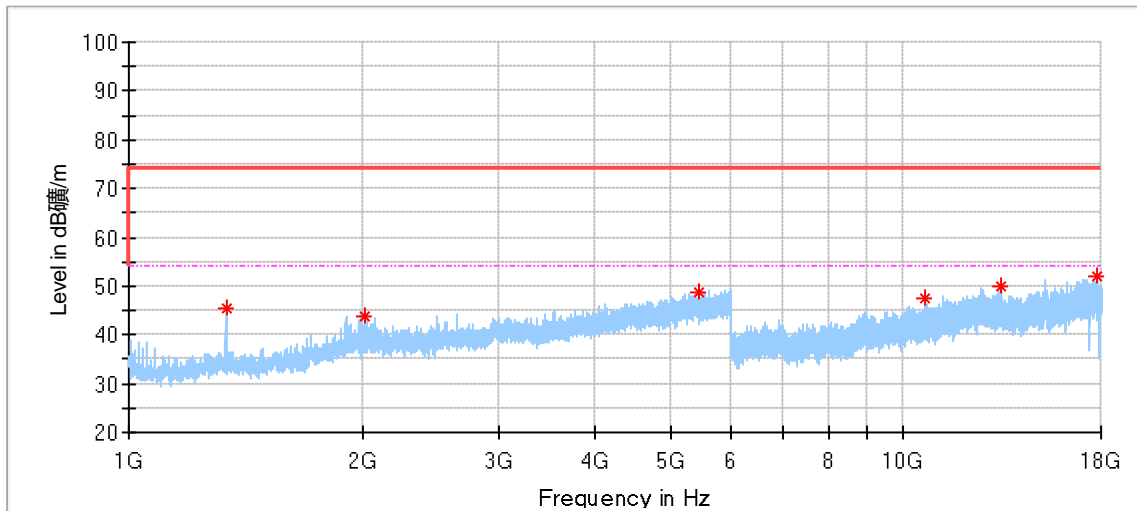

Frequency (MHz)	MaxPeak (dBµV/m)	Limit (dBµV/m)	Margin (dB)	Height (cm)	Pol	Azimuth (deg)	Corr. (dB/m)
1335.000000	45.27	74.00	28.73	150.0	V	320.0	-8.43
2013.500000	43.65	74.00	30.35	150.0	V	352.0	-4.14
5459.000000	48.64	74.00	25.36	150.0	V	320.0	5.59
10686.000000	47.48	74.00	26.52	150.0	V	246.0	14.16
13381.500000	49.82	74.00	24.18	150.0	V	302.0	17.48
17787.000000	52.04	74.00	21.96	150.0	V	134.0	23.82

Remark:

- (1) Data of measurement within frequency ranges 9kHz-30MHz and 18-26GHz are the noise floor or attenuated more than 20dB below the permissible limits or the field strength is too small to be measured, so test data does not present in this report,
- (2) Level= Reading Level + Correction Factor
- (3) Above 1GHz: Corrector factor = Antenna Factor + Cable Loss- Amplifier Gain  
Below 1GHz: Corrector factor = Antenna Factor + Cable Loss  
(The Reading Level is recorded by software which is not shown in the sheet)

## 10 Test Equipment List

### Conducted Emission Test

Description	Manufacturer	Model no.	Equipment ID	Serial no.	Cal interval (year)	Cal. due date
EMI Test Receiver	Rohde & Schwarz	ESR 3	68-4-74-19-002	102590	1	2023-5-27
LISN	Rohde & Schwarz	ENV216	68-4-87-19-001	102472	1	2023-5-27
Attenuator	Shanghai Huaxiang	TS2-26-3	68-4-81-16-003	080928189	1	2023-5-27
Test software	Rohde & Schwarz	EMC32	68-4-90-19-005-A01	Version 10.35.02	N/A	N/A
Shielding Room	TDK	CSR #2	68-4-90-19-005	----	3	2025-10-15

### Radiated Emission Test, SAC-3 #2

Description	Manufacturer	Model no.	Equipment ID	Serial no.	Cal interval (year)	Cal. due date
EMI Test Receiver	Rohde & Schwarz	ESR 26	68-4-74-14-002	101269	1	2023-5-28
Trilog Super Broadband Test Antenna	Schwarzbeck	VULB 9162	68-4-80-19-003	284	1	2024-3-5
Horn Antenna	Rohde & Schwarz	HF907	68-4-80-14-005	102294	1	2023-6-19
Loop Antenna	Rohde & Schwarz	HFH2-Z2	68-4-80-14-006	100398	1	2023-8-17
Pre-amplifier	Rohde & Schwarz	SCU 18F	68-4-29-19-001	100745	1	2023-5-28
Pre-amplifier	Rohde & Schwarz	SCU 18F	68-4-29-19-002	100746	1	2023-5-28
Sideband Horn Antenna	Q-PAR	QWH-SL-18-40-K-SG	68-4-80-14-008	12827	1	2023-7-12
Pre-amplifier	Rohde & Schwarz	SCU 40A	68-4-29-14-002	100432	1	2023-7-27
Attenuator	Mini-circuits	UNAT-6+	68-4-81-21-002	15542	1	2023-5-27
3m Semi-anechoic chamber	TDK	SAC-3 #2	68-4-90-19-006	----	2	2023-5-28
Test software	Rohde & Schwarz	EMC32	68-4-90-19-006-A01	Version 10.35.02	N/A	N/A

### RF Conducted Test

Description	Manufacturer	Model no.	Equipment ID	Serial no.	Cal interval (year)	Cal. due date
Signal Analyzer	Rohde & Schwarz	FSV40	68-4-74-14-004	101030	1	2023-5-27

## 11 System Measurement Uncertainty

For a 95% confidence level, the measurement expanded uncertainties for defined systems, in accordance with the recommendations of ISO 17025 were:

System Measurement Uncertainty	
Test Items	Extended Uncertainty
Uncertainty for Conducted Emission in new shielding room (68-4-90-19-005) 150kHz-30MHz (for test using AMN ENV216)	3.33dB
Uncertainty for Radiated Emission in 3m chamber (68-4-90-14-001) 9kHz-30MHz	4.70dB
Uncertainty for Radiated Emission in new 3m chamber (68-4-90-19-006) 30MHz-1000MHz	Horizontal: 4.59dB; Vertical: 4.75dB;
Uncertainty for Radiated Emission in new 3m chamber (68-4-90-19-006) 1000MHz-18000MHz	Horizontal: 5.08dB; Vertical: 5.09dB;
Uncertainty for Radiated Emission in new 3m chamber (68-4-90-19-006) above 18000MHz	Horizontal: 3.14dB; Vertical: 3.12dB
Uncertainty for Conducted RF test with TS 8997	RF Power Conducted: 1.31dB Frequency test involved: 0.6×10 <sup>-8</sup> or 1%

### Measurement Uncertainty Decision Rule:

Determination of conformity with the specification limits is based on the decision rule according to IEC Guide 115: 2021, clause 4.4.3 and 4.5.1.

---THE END OF REPORT---