

FCC TEST REPORT

for
DotW, LLC

Groupie Stick
Model No.: C0001, C0002, C0003, C0004

Prepared for : DotW, LLC
Address : 8721 Santa Monica Blvd, Suite 1505 Los Angeles, CA, 90069,
United States

Prepared By : Shenzhen Anbotek Compliance Laboratory Limited
Address : 1/F., Building 1, SEC Industrial Park, No.0409 Qianhai Road,
Nanshan District, Shenzhen, Guangdong, China
Tel: (86) 755-26066544
Fax: (86) 755-26014772

Report Number : R011411242E
Date of Test : Nov. 14~ 28, 2014
Date of Report : Dec. 05, 2014

TABLE OF CONTENTS

Description	Page
Test Report	
1. GENERAL INFORMATION	5
1.1 Description of Device (EUT)	5
1.2 Auxiliary Equipment Used during Test	6
1.3 Description of Test Facility	6
1.4 Measurement Uncertainty	6
2. TEST PROCEDURE	7
3. CONDUCTED EMISSION TEST	8
3.1 Block Diagram of Test Setup	8
3.2 Power Line Conducted Emission Measurement Limits (15.207)	8
3.3 Configuration of EUT on Measurement	8
3.4 Operating Condition of EUT	8
3.5 Test Procedure	9
3.6 Test equipment	9
3.7 Power Line Conducted Emission Measurement Results	9
4. RADIATION INTERFERENCE	12
4.1 Requirements (15.247, 15.209)	12
4.2 Test Procedure	12
4.3 Test Configuration	13
4.4 Test Results	14
5. CHANNEL SEPARATION TEST	23
5.1 Measurement Procedure	23
5.2 Test SET-UP	23
5.3 Test Equipment	23
5.4 Test Results	24
6. 20DB BANDWIDTH TEST	28
6.1 Measurement Procedure	28
6.2 Test SET-UP	28
6.3 Test Equipment	28
6.4 Test Results	28
7. QUANTITY OF HOPPING CHANNEL TEST	32
7.1 Measurement Procedure	32
7.2 Test SET-UP	32
7.3 Test Equipment	32
7.4 Test Results	32
8. DWELL TIME TEST	34
8.1 Measurement Procedure	34
8.2 Test SET-UP	34
8.3 Test Equipment	34

8.4 Test Results	34
9. MAXIMUM PEAK OUTPUT POWER TEST	37
9.1 Measurement Procedure	37
9.2 Test SET-UP	37
9.3 Test Equipment	37
9.4 Test Results	38
10. BAND EDGE TEST	42
10.1 Measurement Procedure	42
10.2 Test SET-UP	42
10.3 Test Equipment	42
10.4 Test Results	42
11. ANTENNA APPLICATION	48
11.1 Antenna requirement	48
11.2 Result	48
12. PHOTOGRAPH	49
12.1 Photo of Conducted Emission Test	49
12.2 Photo of Radiation Emission Test	49
APPENDIX I (EXTERNAL PHOTOS)	51
APPENDIX II (INTERNAL PHOTOS)	54

TEST REPORT

Applicant : DotW, LLC
Manufacturer : Shenzhen North Technology Co., Ltd.
EUT : Groupie Stick
Model No. : C0001, C0002, C0003, C0004
Serial No. : N.A.
Trade Mark : Groupie Stick
Rating : DC 5V, 100mAh

Measurement Procedure Used:

FCC Part15 Subpart C, Paragraph 15.207, 15.247 & 15.209

The device described above is tested by Shenzhen Anbotek Compliance Laboratory Limited to determine the maximum emission levels emanating from the device and the severe levels of the device can endure and its performance criterion. The measurement results are contained in this test report and Shenzhen Anbotek Compliance Laboratory Limited is assumed full of responsibility for the accuracy and completeness of these measurements. Also, this report shows that the EUT (Equipment Under Test) is technically compliant with the FCC Part 15 Subpart C requirements.

This report applies to above tested sample only and shall not be reproduced in part without written approval of Shenzhen Anbotek Compliance Laboratory Limited.

Date of Test : Nov. 14~ 28, 2014

Prepared by :

Kebo Zhang

(Tested Engineer / Kebo Zhang)

Amy Ding

Reviewer :

(Project Manager / Amy Ding)

Tom Chen

Approved & Authorized Signer :

(Manager / Tom Chen)

1. GENERAL INFORMATION

1.1 Description of Device (EUT)

EUT	: Groupie Stick
Model Number	: C0001, C0002, C0003, C0004 (Note: All samples are the same except the model number and colour, so we prepare "C0001" for test only.)
Test Power Supply	: DC 5V(With DC 3.7V Battery inside)
Frequency	: 2402~2480MHz
Antenna Specification	: PCB Antenna: 2.3dBi
Modulation	: GFSK, $\pi/4$ DQPSK, 8DPSK
Applicant Address	: DotW, LLC : 8721 Santa Monica Blvd, Suite 1505 Los Angeles, CA, 90069, United States
Manufacturer Address	: Shenzhen North Technology Co., Ltd. : Floor 3, 8th Building, Lianchuang Technical Zone, Bulan Road, Longgang District, Shenzhen, 518114, China
Factory Address	: Shenzhen North Technology Co., Ltd. : Floor 3, 8th Building, Lianchuang Technical Zone, Bulan Road, Longgang District, Shenzhen, 518114, China
Date of receipt	: Nov. 14, 2014
Date of Test	: Nov. 14~ 28, 2014

1.2 Auxiliary Equipment Used during Test

Mobile Phone	: Manufacturer: SAMSUNG M/N: GT-I9268 CE , FCC, DOC
Adapter	: Model: THX-050250KD Input: AC 100-240V, 50/60Hz, 0.65A Max. Output: DC 5V

1.3 Description of Test Facility

The test facility is recognized, certified, or accredited by the following organizations:

CNAS - LAB Code: L3503

Shenzhen Anbotek Compliance Laboratory Limited., Laboratory has been assessed and in compliance with CNAS/CL01: 2006 accreditation criteria for testing laboratories (identical to ISO/IEC 17025:2005 General Requirements) for the Competence of Testing Laboratories.

FCC-Registration No.: 752021

Shenzhen Anbotek Compliance Laboratory Limited, EMC Laboratory has been registered and fully described in a report filed with the (FCC) Federal Communications Commission. The acceptance letter from the FCC is maintained in our files. Registration 752021, July 10, 2013.

IC-Registration No.: 8058A-1

Shenzhen Anbotek Compliance Laboratory Limited., EMC Laboratory has been registered and fully described in a report filed with the (IC) Industry Canada. The acceptance letter from the IC is maintained in our files. Registration 8058A, February 22, 2013.

Test Location

All Emissions tests were performed at
Shenzhen Anbotek Compliance Laboratory Limited. at 1/F., Building 1, SEC
Industrial Park, No.0409 Qianhai Road, Nanshan District, Shenzhen, Guangdong,
China

1.4 Measurement Uncertainty

Radiation Uncertainty	:	Ur = 4.3dB
Conduction Uncertainty	:	Uc = 3.4dB

2. Test Procedure

GENERAL: This report shall NOT be reproduced except in full without the written approval of Shenzhen Anbotek Compliance Laboratory Limited. The EUT was transmitting a test signal during the testing.

RADIATION INTERFERENCE: The test procedure used was ANSI STANDARD C63.4-2009 using a spectrum analyzer with a pre-selector. The analyzer was calibrated in dB above a microvolt at the output of the antenna. The resolution bandwidth was 100KHz and the video bandwidth was 300KHz up to 1.0GHz and 1.0MHz with a video BW of 3.0MHz above 1.0GHz. The ambient temperature of the EUT was 74.3oF with a humidity of 69%.

FORMULA OF CONVERSION FACTORS: The Field Strength at 3m was established by adding the meter reading of the spectrum analyzer (which is set to read in units of dBuV) to the antenna correction factor supplied by the antenna manufacturer. The antenna correction factors are stated in terms of dB. The gain of the Preselector was accounted for in the Spectrum Analyzer Meter Reading.

Example:

Freq (MHz) METER READING + ACF = FS
20 dBuV + 10.36 dB = 30.36 dBuV/m @ 3m

ANSI STANDARD C63.4-2009 10.1.7 MEASUREMENT PROCEDURES: The EUT was placed on a table 80 cm high and with dimensions of 1m by 1.5m. The EUT was placed in the center of the table (1.5m side). The table used for radiated measurements is capable of continuous rotation.

When an emission was found, the table was rotated to produce the maximum signal strength. At this point, the antenna was raised and lowered from 1m to 4m. The antenna was placed in both the horizontal and vertical planes.

3. Conducted Emission Test

3.1 Block Diagram of Test Setup

3.1.1. Block diagram of connection between the EUT and simulators

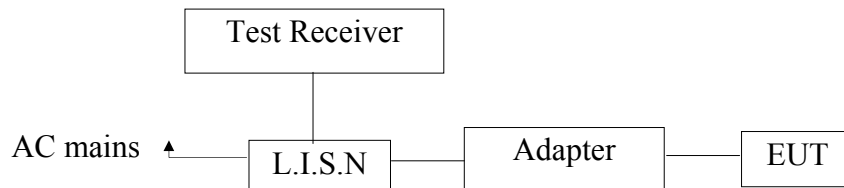

3.2 Power Line Conducted Emission Measurement Limits (15.207)

Frequency MHz	Limits dB(μV)	
	Quasi-peak Level	Average Level
0.15 ~ 0.50	66 ~ 56*	56 ~ 46*
0.50 ~ 5.00	56	46
5.00 ~ 30.00	60	50

Notes: 1. *Decreasing linearly with logarithm of frequency.
2. The lower limit shall apply at the transition frequencies.

3.3 Configuration of EUT on Measurement

The following equipments are installed on Power Line Conducted Emission Measurement to meet the commission requirement and operating regulations in a manner which tends to maximize its emission characteristics in a normal application.

3.4 Operating Condition of EUT

- 3.4.1. Setup the EUT and simulator as shown as Section 3.1.
- 3.4.2. Turn on the power of all equipment.
- 3.4.3. Let the EUT work in test mode (Charging) and measure it.

3.5 Test Procedure

The EUT system is connected to the power mains through a line impedance stabilization network (L.I.S.N.). This provides a 50ohm coupling impedance for the EUT system. Please refer the block diagram of the test setup and photographs. Both sides of AC line are checked to find out the maximum conducted emission. In order to find the maximum emission levels, the relative positions of equipment and all of the interface cables shall be changed according to FCC ANSI C63.4-2003 on Conducted Emission Measurement.

The bandwidth of test receiver (ESCI) set at 9KHz.

The frequency range from 150KHz to 30MHz is checked.

The test results are reported on Section 3.6.

3.6 Test equipment

Item	Equipment	Manufacturer	Model No.	Serial No.	Last Cal.	Cal. Interval
1.	Two-Line V-network	Rohde & Schwarz	ENV216	100055	Apr. 22, 2014	1 Year
2.	EMI Test Receiver	Rohde & Schwarz	ESCI	100627	Apr. 22, 2014	1 Year
3.	RF Switching Unit	Compliance Direction	RSU-M2	38303	Apr. 22, 2014	1 Year

3.7 Power Line Conducted Emission Measurement Results

PASS.

The frequency range from 150KHz to 30 MHz is investigated.

Please refer the following pages.

CONDUCTED EMISSION TEST DATA

Test Site: 1# Shielded Room
 Operating Condition: Charging
 Test Specification: DC 5V via USB Port
 Comment: Live Line
 Tem:25°C Hum:50%

SCAN TABLE: "Voltage (150K~30M) FIN"

Short Description: 150K-30M Disturbance Voltages

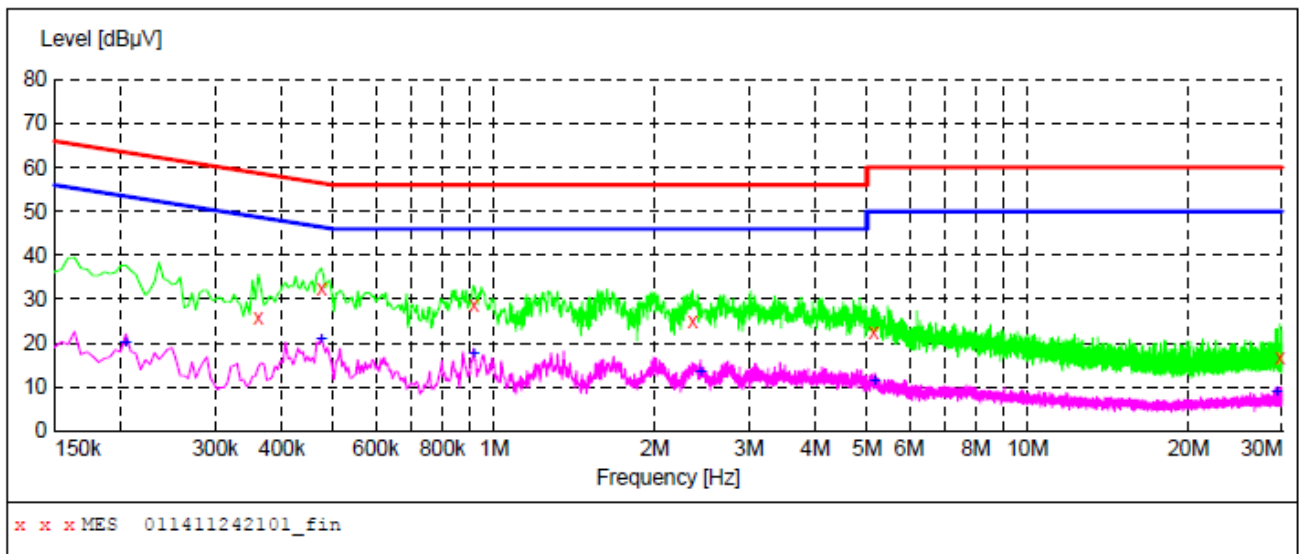

MEASUREMENT RESULT: "011411242101_fin"

11/19/2014 9:37AM

Frequency MHz	Level dBµV	Transd dB	Limit dBµV	Margin dB	Detector	Line	PE
0.361500	25.90	20.1	59	32.8	QP	L1	GND
0.474000	32.40	20.1	56	24.0	QP	L1	GND
0.915000	28.90	20.1	56	27.1	QP	L1	GND
2.354500	25.20	20.3	56	30.8	QP	L1	GND
5.144500	22.50	20.5	60	37.5	QP	L1	GND
29.719000	16.70	20.9	60	43.3	QP	L1	GND

MEASUREMENT RESULT: "011411242101_fin2"

11/19/2014 9:37AM

Frequency MHz	Level dBµV	Transd dB	Limit dBµV	Margin dB	Detector	Line	PE
0.204000	20.20	20.1	53	33.2	AV	L1	GND
0.474000	20.80	20.1	46	25.6	AV	L1	GND
0.915000	17.60	20.1	46	28.4	AV	L1	GND
2.440000	13.50	20.3	46	32.5	AV	L1	GND
5.171500	11.20	20.5	50	38.8	AV	L1	GND
29.359000	8.70	20.9	50	41.3	AV	L1	GND

CONDUCTED EMISSION TEST DATA

Test Site: 1# Shielded Room
 Operating Condition: Charging
 Test Specification: DC 5V via USB Port
 Comment: Neutral Line
 Tem:25°C Hum:50%

SCAN TABLE: "Voltage (150K~30M) FIN"
 Short Description: 150K-30M Disturbance Voltages

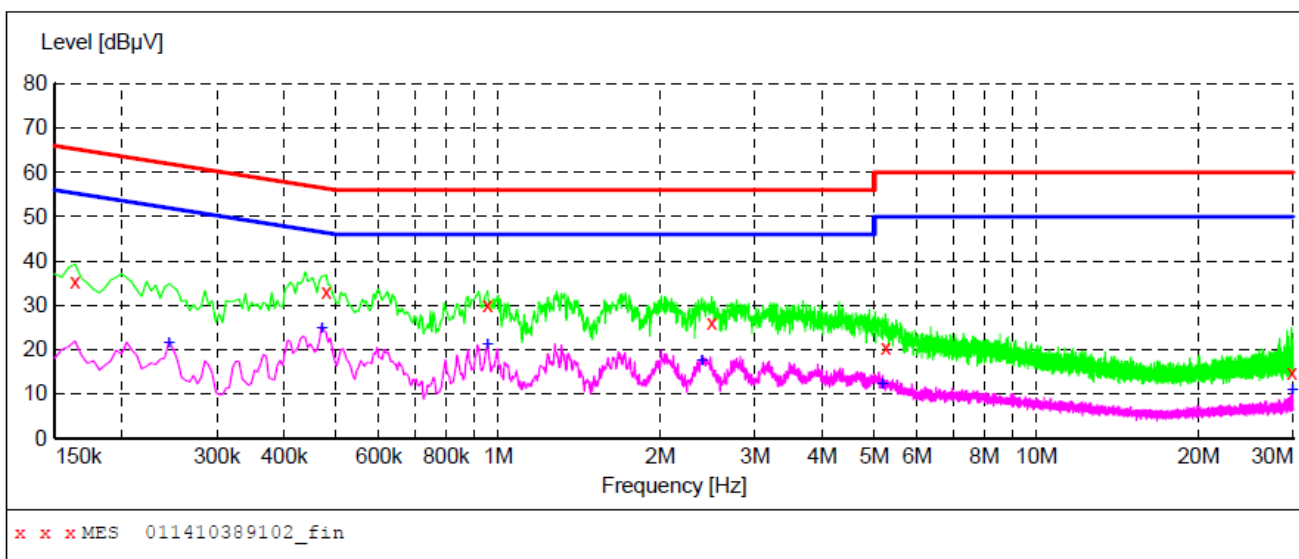

MEASUREMENT RESULT: "011411242102_fin"

11/19/2014 9:40AM

Frequency MHz	Level dBµV	Transd dB	Limit dBµV	Margin dB	Detector	Line	PE
0.163500	35.40	20.1	65	29.9	QP	N	GND
0.478500	33.10	20.1	56	23.3	QP	N	GND
0.955500	29.90	20.2	56	26.1	QP	N	GND
2.494000	26.10	20.3	56	29.9	QP	N	GND
5.243500	20.50	20.5	60	39.5	QP	N	GND
29.845000	14.70	20.9	60	45.3	QP	N	GND

MEASUREMENT RESULT: "011411242102_fin2"

11/19/2014 9:40AM

Frequency MHz	Level dBµV	Transd dB	Limit dBµV	Margin dB	Detector	Line	PE
0.244500	21.50	20.1	52	30.4	AV	N	GND
0.469500	24.80	20.1	47	21.7	AV	N	GND
0.955500	21.10	20.2	46	24.9	AV	N	GND
2.390500	17.30	20.3	46	28.7	AV	N	GND
5.180500	12.30	20.5	50	37.7	AV	N	GND
29.899000	10.90	20.9	50	39.1	AV	N	GND

4. Radiation Interference

4.1 Requirements (15.247, 15.209):

4.1.1. Test Limits (< 30 MHz)

Frequency (MHz)	Field Strength (microvolts/meter)	Measurement Distance (meter)
0.009-0.490	2400/F(kHz)	300
0.490-1.705	24000/F(kHz)	30
1.705-30.0	30	30

4.1.2. Test Limits (≥ 30 MHz)

FIELD STRENGTH of Fundamental: @3M	FIELD STRENGTH of Harmonics	S15.209	
902-928 MHz		30 - 88 MHz	40 dBuV/m
2.4-2.4835 GHz		88 - 216 MHz	43.5
94 dBμV/m @3m	54 dBμV/m @3m	216 - 960 MHz	46
		ABOVE 960 MHz	54dBuV/m

For range 9KHz~30MHz, The measured value is really too low to be recorded.

Emissions radiated outside of the specified frequency bands, except for harmonics, shall be attenuated by at least 50 dB below the level of the fundamental or to the general radiated emission limits in 15.209, whichever is the lesser attenuation.

4.2 Test Procedure

The EUT is placed on a turn table which is 0.8 meter high above the ground. The turn table can rotate 360 degrees to determine the position of the maximum emission level. The EUT is set 3 meters away from the receiving antenna which is mounted on a antenna tower. The antenna can be moved up and down from 1 to 4 meters to find out the maximum emission level. Rotated the EUT through three orthogonal axes to determine the maximum emissions, both horizontal and vertical polarization of the antenna are set on test. The EUT is tested in 9*6*6 Chamber.

For 30MHz to 1000MHz:

Set the spectrum analyzer as:
 RBW = 120kHz, VBW =120kHz,
 Detector= Quasi-Peak
 Trace mode= Max hold.
 Sweep- auto couple.

For Above 1GHz (Peak Measurement):

Set the spectrum analyzer as:
 RBW = 1MHz, VBW =3MHz,
 Detector= Peak
 Trace mode= Max hold.
 Sweep- auto couple.

For Above 1GHz (Average Measurement):

Set the spectrum analyzer as:

RBW =1MHz, VBW =10Hz

Detector=Peak

Trace mode= Max hold.

Sweep- auto couple.

Test Equipment

Item	Equipment	Manufacturer	Model No.	Serial No.	Last Cal.	Cal. Interval
1.	Spectrum Analysis	Agilent	E4407B	US39390582	Aug. 08, 2014	1 Year
2.	Preamplifier	Instruments corporation	EMC011830	980100	Aug. 08, 2014	1 Year
3.	EMI Test Receiver	Rohde & Schwarz	ESPI	101604	Apr. 22, 2014	1 Year
4.	Double Ridged Horn Antenna	Instruments corporation	GTH-0118	351600	Apr. 04, 2014	1 Year
5.	Bilog Broadband Antenna	Schwarzbeck	VULB9163	VULB 9163-289	Apr. 24, 2014	1 Year
6.	Pre-amplifier	SONOMA	310N	186860	Aug. 08, 2014	1 Year
7.	EMI Test Software EZ-EMC	SHURPLE	N/A	N/A	N/A	N/A

4.3 Test Configuration

4.3.1. 9k to 30MHz emissions:

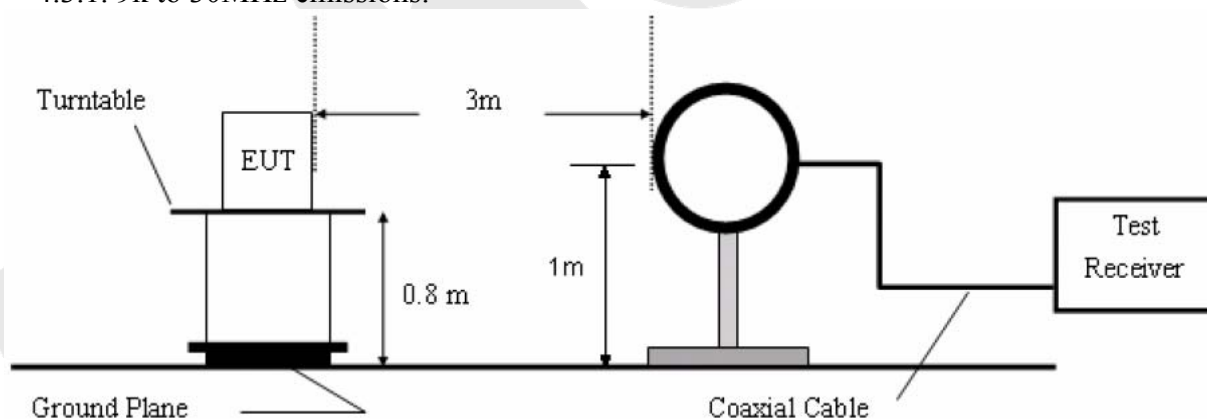

4.3.2. 30M to 1G emissions:

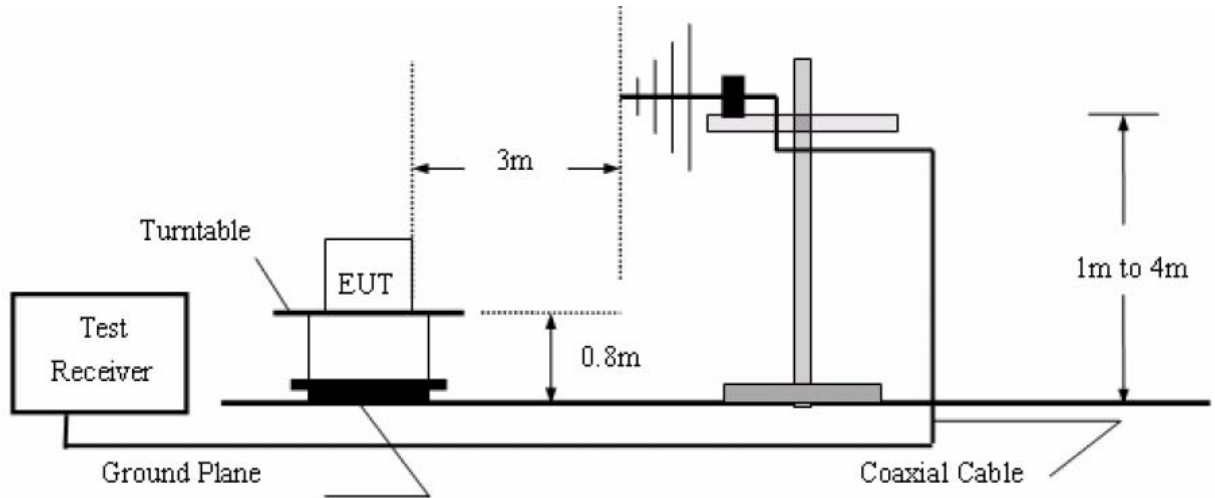

4.3.3. 1G to 40G emissions:

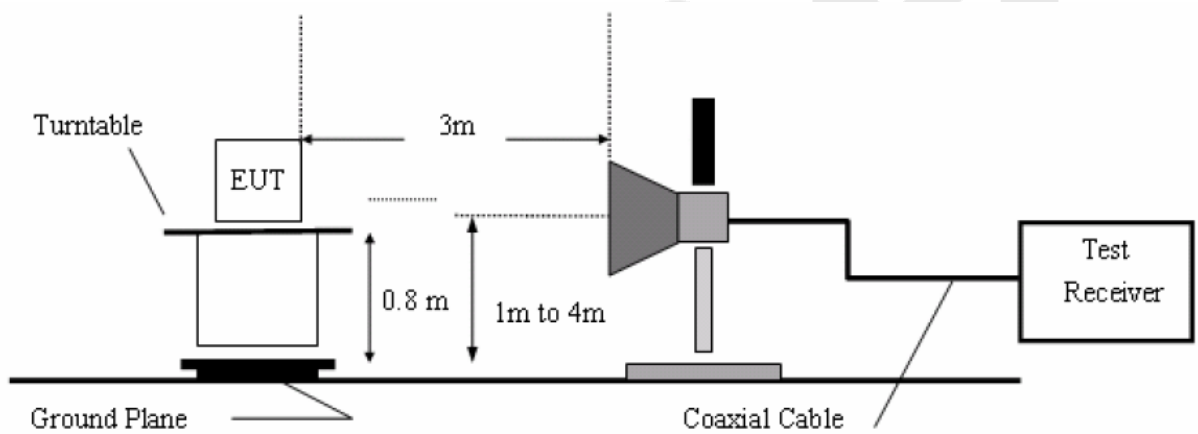

4.4 Test Results

PASS.

Please refer the following pages.

Job No.:	011411242E	Polarization:	Horizontal
Standard:	(RE)FCC PART 15C _3m	Power Source:	DC 3.7V
Test item:	Radiation Test (30~1000MHz)	Temp.(C)/Hum.(%RH):	24.3(C)/55%RH
Test Mode:	On	Distance:	3m

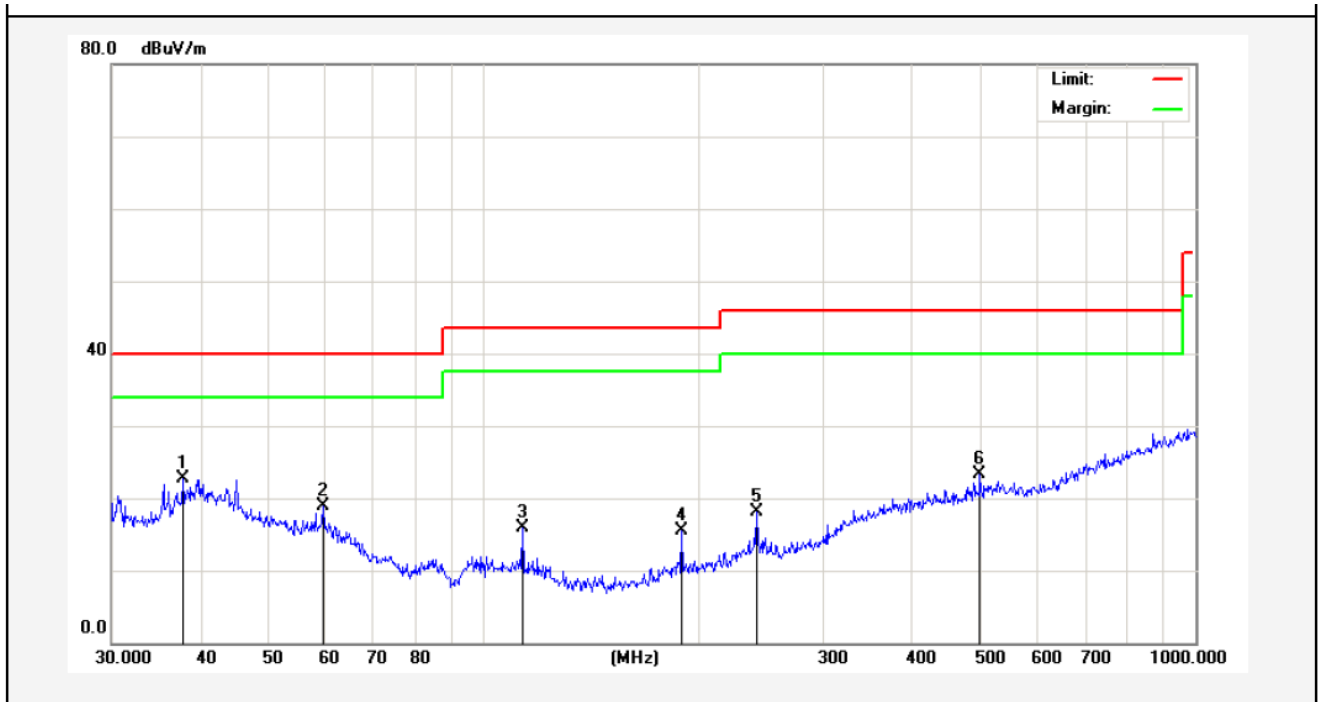

No.	Freq. (MHz)	Reading (dBuV/m)	Factor (dB/m)	Result (dBuV/m)	Limit (dBuV/)	Over Limit (dB)	Detector	Height (cm)	degree (deg)	Remark
1	37.8121	34.70	-12.09	22.61	40.00	-17.39	peak			
2	59.4405	34.30	-15.34	18.96	40.00	-21.04	peak			
3	113.3163	36.71	-20.86	15.85	43.50	-27.65	peak			
4	189.7385	36.54	-20.95	15.59	43.50	-27.91	peak			
5	241.6763	36.28	-18.17	18.11	46.00	-27.89	peak			
6	497.6765	34.42	-11.02	23.40	46.00	-22.60	peak			

Job No.:	011411242E	Polarization:	Vertical
Standard:	(RE)FCC PART 15C_3m	Power Source:	DC 3.7V
Test item:	Radiation Test (30~1000MHz)	Temp.(C)/Hum.(%RH):	24.3(C)/55%RH
Test Mode:	On	Distance:	3m

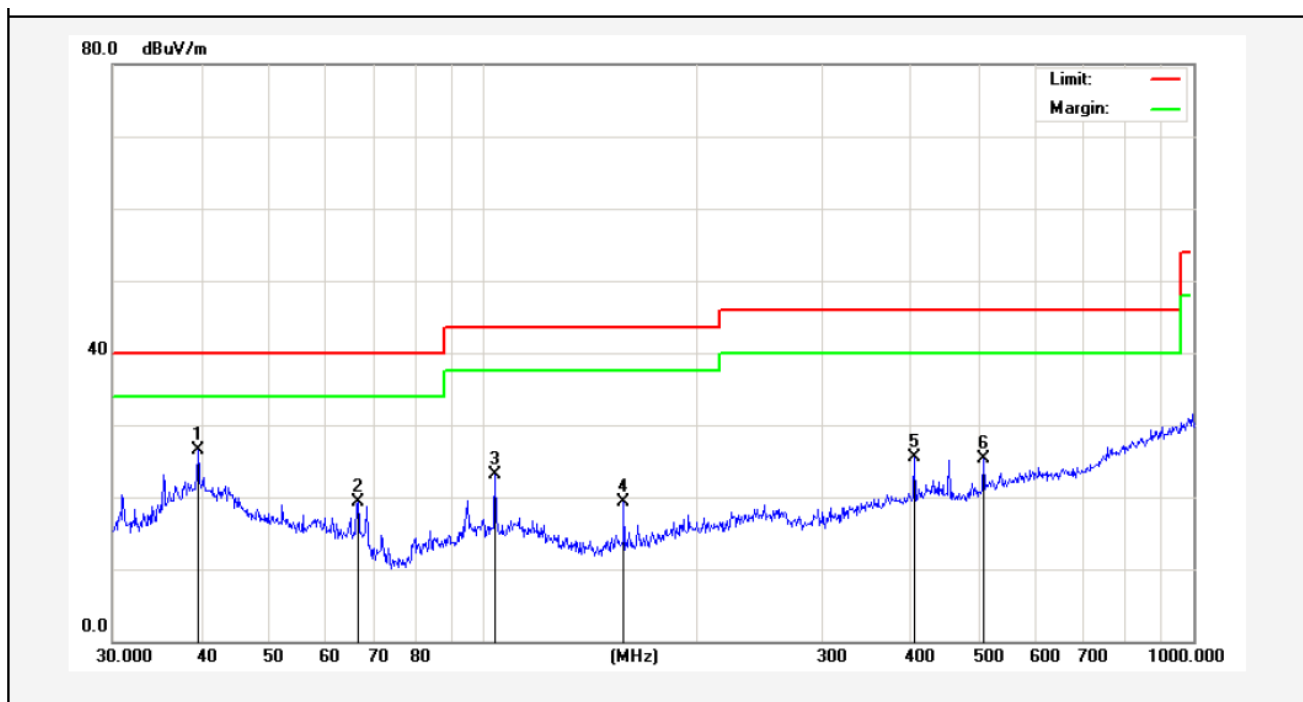

No.	Freq. (MHz)	Reading (dBuV/m)	Factor (dB/m)	Result (dBuV/m)	Limit (dBuV/)	Over Limit (dB)	Detector	Height (cm)	degree (deg)	Remark
1	39.5757	37.17	-10.70	26.47	40.00	-13.53	peak			
2	66.4989	37.35	-18.12	19.23	40.00	-20.77	peak			
3	103.8055	38.79	-15.71	23.08	43.50	-20.42	peak			
4	157.5588	37.25	-17.98	19.27	43.50	-24.23	peak			
5	404.6665	37.17	-11.74	25.43	46.00	-20.57	peak			
6	506.4791	36.18	-10.84	25.34	46.00	-20.66	peak			

Job No.:	011411242E	Polarization:	Horizontal
Standard:	(RE)FCC PART 15C_Class B_3m	Power Source:	DC 3.7V
Test item:	Radiation Test (Above 1GHz)	Temp.(C)/Hum.(%RH):	24.3(C)/55%RH
Test Mode:	TX(2402 MHz)	Distance:	3m

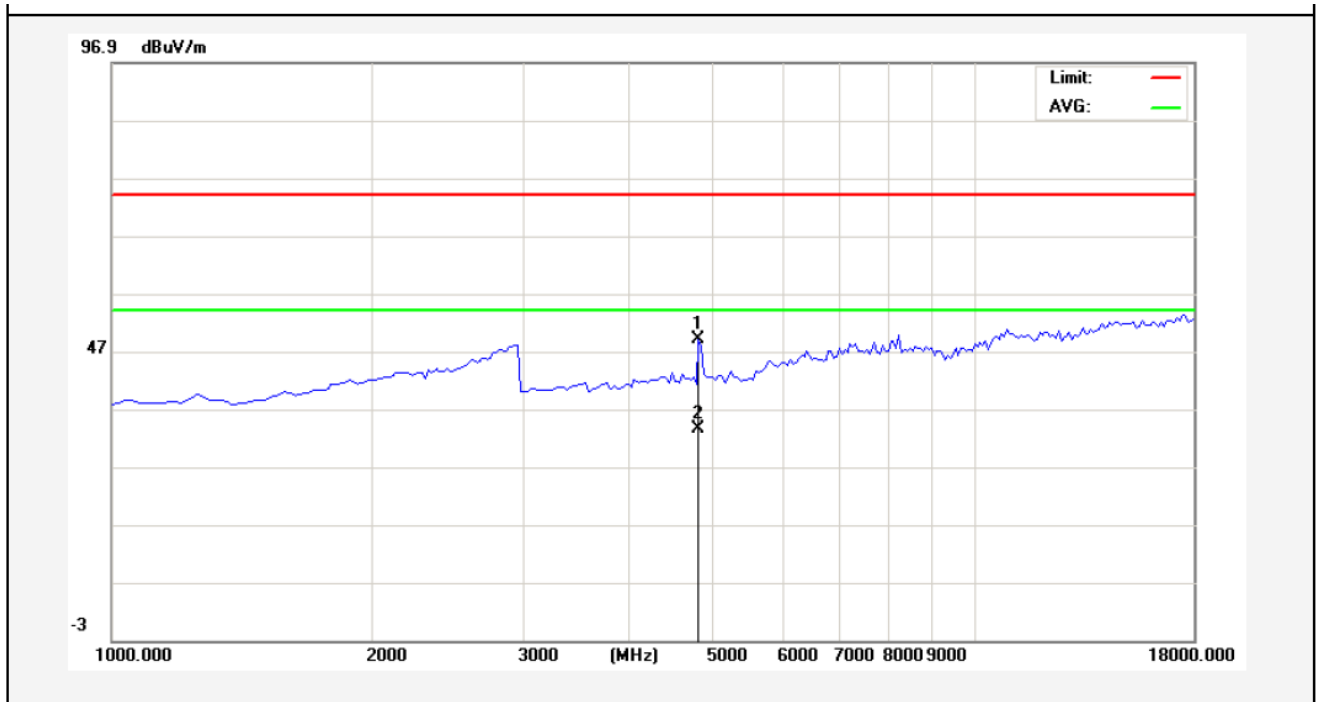

No.	Freq. (MHz)	Reading (dBuV/m)	Factor (dB/m)	Result (dBuV/m)	Limit (dBuV/)	Over Limit (dB)	Detector	Height (cm)	degree (deg)	Remark
1	4825.000	45.64	3.34	48.98	74.00	-25.02	peak			
2	4825.000	30.22	3.34	33.56	54.00	-20.44	AVG			

Job No.:	011411242E	Polarization:	Vertical
Standard:	(RE)FCC PART 15C_Class B_3m	Power Source:	DC 3.7V
Test item:	Radiation Test (Above 1GHz)	Temp.(C)/Hum.(%RH):	24.3(C)/55%RH
Test Mode:	TX(2402 MHz)	Distance:	3m

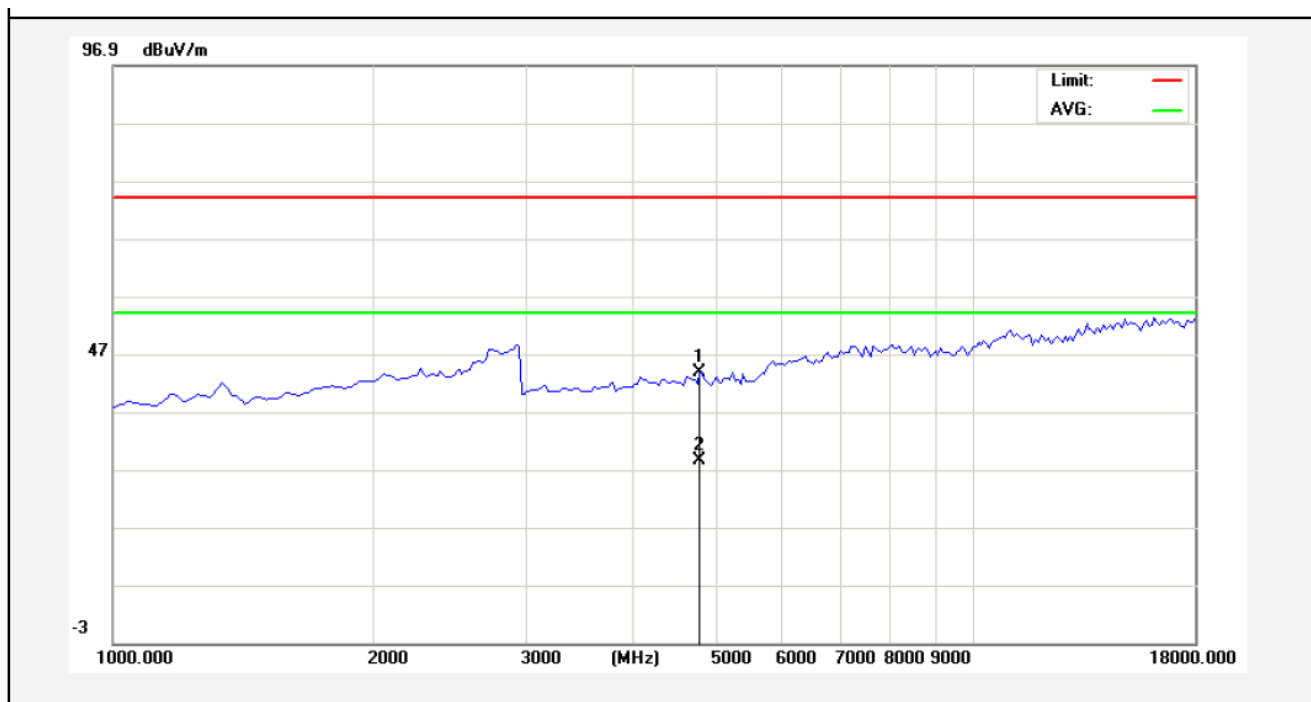

No.	Freq. (MHz)	Reading (dBuV/m)	Factor (dB/m)	Result (dBuV/m)	Limit (dBuV/)	Over Limit (dB)	Detector	Height (cm)	degree (deg)	Remark
1	4825.000	40.50	3.34	43.84	74.00	-30.16	peak			
2	4825.000	25.11	3.34	28.45	54.00	-25.55	AVG			

AEM

Job No.:	011411242E	Polarization:	Horizontal
Standard:	(RE)FCC PART 15C_Class B_3m	Power Source:	DC 3.7V
Test item:	Radiation Test (Above 1GHz)	Temp.(C)/Hum.(%RH):	24.3(C)/55%RH
Test Mode:	TX(2441 MHz)	Distance:	3m

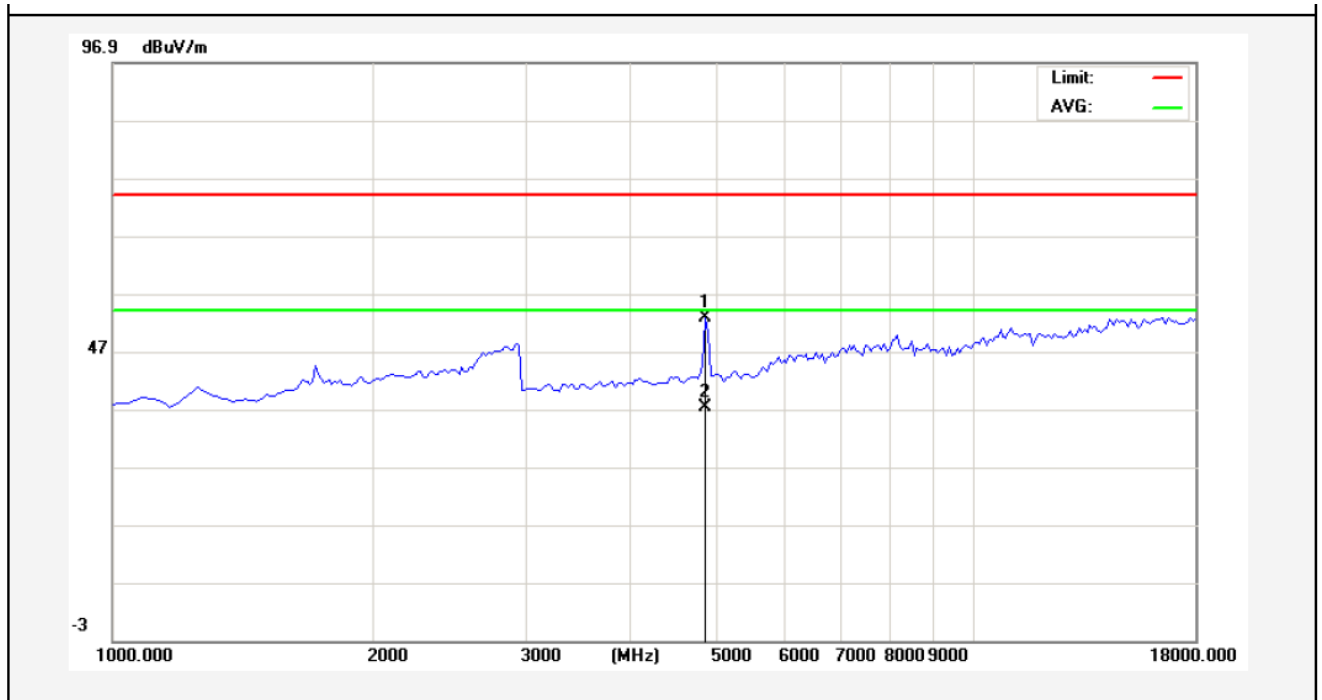

No.	Freq. (MHz)	Reading (dBuV/m)	Factor (dB/m)	Result (dBuV/m)	Limit (dBuV/)	Over Limit (dB)	Detector	Height (cm)	degree (deg)	Remark
1	4867.500	49.41	3.41	52.82	74.00	-21.18	peak			
2	4867.500	33.83	3.41	37.24	54.00	-16.76	AVG			

Job No.:	011411242E	Polarization:	Vertical
Standard:	(RE)FCC PART 15C_Class B_3m	Power Source:	DC 3.7V
Test item:	Radiation Test (Above 1GHz)	Temp.(C)/Hum.(%RH):	24.3(C)/55%RH
Test Mode:	TX(2441 MHz)	Distance:	3m

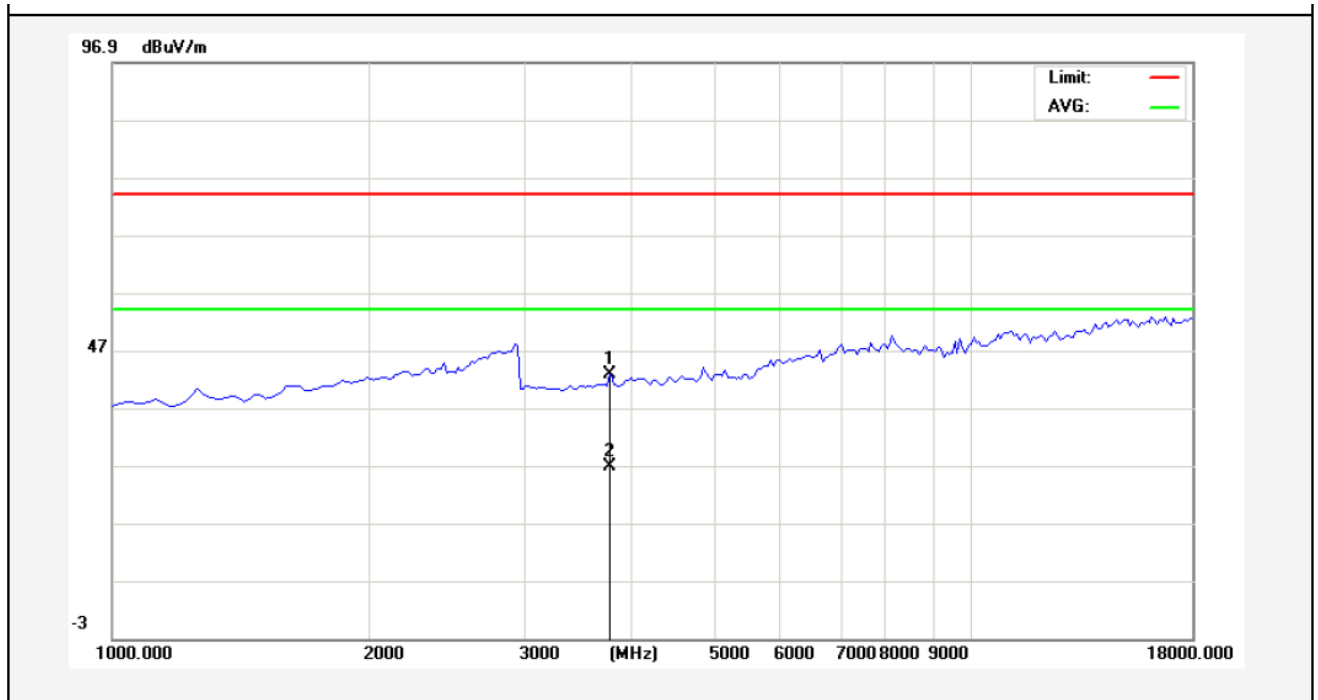

No.	Freq. (MHz)	Reading (dBuV/m)	Factor (dB/m)	Result (dBuV/m)	Limit (dBuV/)	Over Limit (dB)	Detector	Height (cm)	degree (deg)	Remark
1	3805.000	41.14	1.59	42.73	74.00	-31.27	peak			
2	3805.000	25.24	1.59	26.83	54.00	-27.17	AVG			

Job No.:	011411242E	Polarization:	Horizontal
Standard:	(RE)FCC PART 15C_Class B_3m	Power Source:	DC 3.7V
Test item:	Radiation Test (Above 1GHz)	Temp.(C)/Hum.(%RH):	24.3(C)/55%RH
Test Mode:	TX(2480 MHz)	Distance:	3m

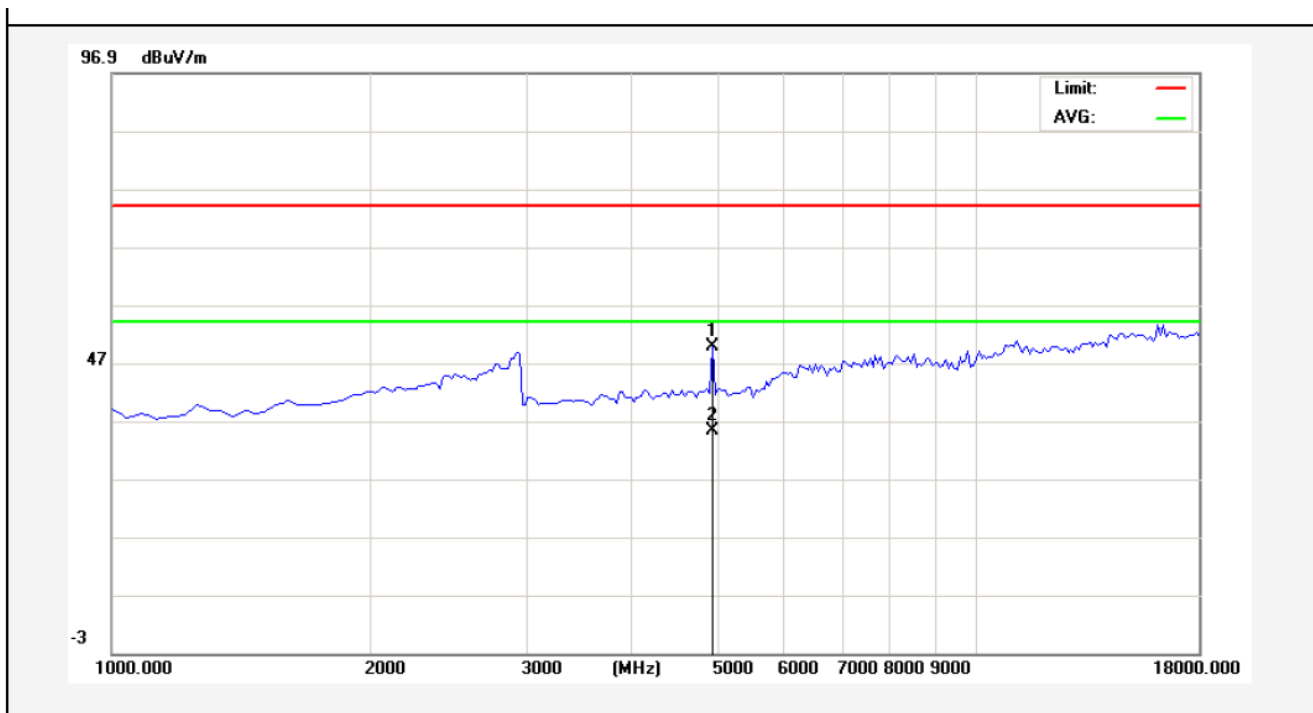

No.	Freq. (MHz)	Reading (dBuV/m)	Factor (dB/m)	Result (dBuV/m)	Limit (dBuV/)	Over Limit (dB)	Detector	Height (cm)	degree (deg)	Remark
1	4952.500	46.23	3.57	49.80	74.00	-24.20	peak			
2	4952.500	31.66	3.57	35.23	54.00	-18.77	AVG			

AEM

Job No.:	011411242E	Polarization:	Vertical
Standard:	(RE)FCC PART 15C_Class B_3m	Power Source:	DC 3.7V
Test item:	Radiation Test (Above 1GHz)	Temp.(C)/Hum.(%RH):	24.3(C)/55%RH
Test Mode:	TX(2480 MHz)	Distance:	3m

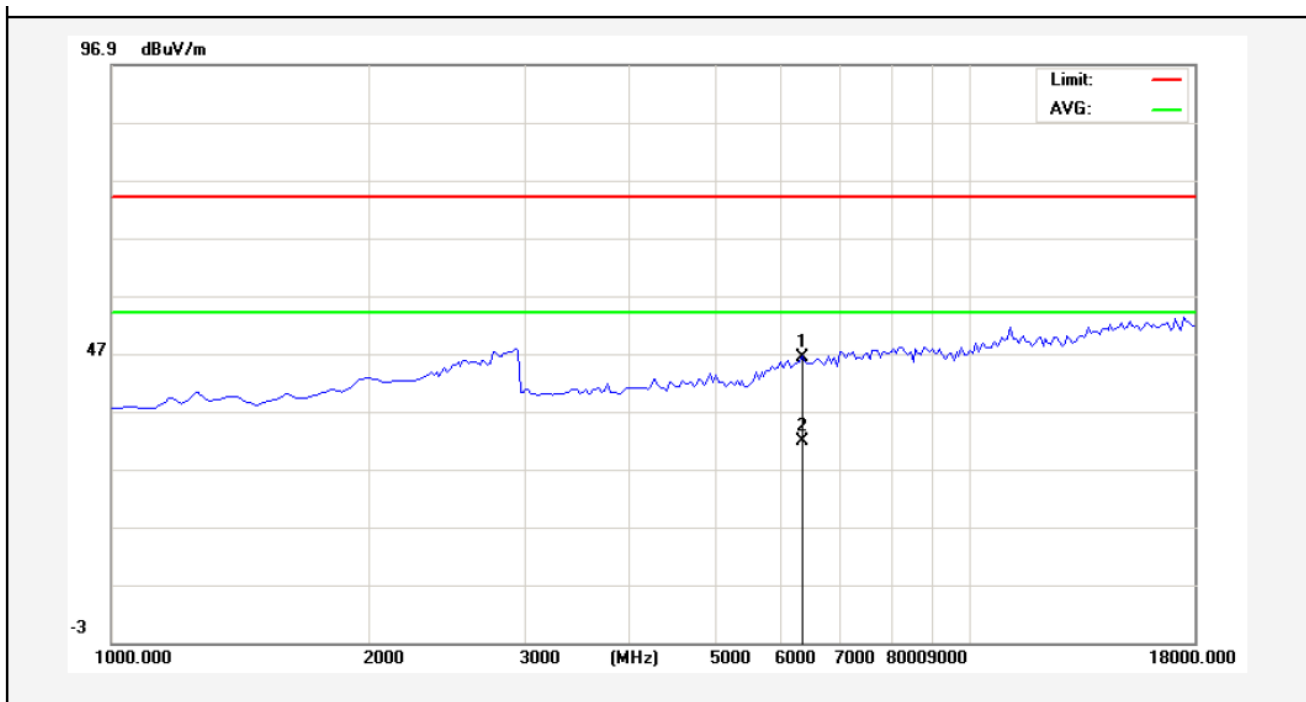

No.	Freq. (MHz)	Reading (dBuV/m)	Factor (dB/m)	Result (dBuV/m)	Limit (dBuV/)	Over Limit (dB)	Detector	Height (cm)	degree (deg)	Remark
1	6355.000	38.94	7.46	46.40	74.00	-27.60	peak			
2	6355.000	24.39	7.46	31.85	54.00	-22.15	AVG			

5. CHANNEL SEPARATION TEST

5.1 Measurement Procedure

The EUT must have its hopping function enabled. Using the following spectrum analyzer settings:

1. Span= Wide enough to capture the peaks of two adjacent channels
2. Set the RBW = 30 kHz.
3. Set the VBW = 100 kHz.
4. Sweep time = auto couple.
5. Detector function = peak.
6. Trace mode = max hold.
7. Allow trace to fully stabilize.

5.2 Test SET-UP



5.3 Test Equipment

Item	Equipment	Manufacturer	Model No.	Serial No.	Last Cal.	Cal. Interval
1.	Spectrum Analysis	Agilent	E4407B	US39390582	Aug. 08, 2014	1 Year
2.	Preamplifier	Instruments corporation	EMC011830	980100	Aug. 08, 2014	1 Year
3.	EMI Test Receiver	Rohde & Schwarz	ESPI	101604	Apr. 22, 2014	1 Year
4.	Double Ridged Horn Antenna	Instruments corporation	GTH-0118	351600	Apr. 04, 2014	1 Year
5.	Bilog Broadband Antenna	Schwarzbeck	VULB9163	VULB 9163-289	Apr. 24, 2014	1 Year
6.	Pre-amplifier	SONOMA	310N	186860	Aug. 08, 2014	1 Year
7.	EMI Test Software EZ-EMC	SHURPLE	N/A	N/A	N/A	N/A

5.4 Test Results

Test Item : Frequency Separation Test Mode : CH Low ~ CH High
 Test Voltage : DC 3.7V Temperature : 24°C
 Test Result : PASS Humidity : 55%RH

Channel	Frequency (MHz)	Separation Read Value (kHz)	Limit (kHz)	Mode
Low	2401	1002	850	BDR
Mid	2441	1002	860	BDR
High	2480	1002	840	BDR
Low	2401	1002	806	EDR
Mid	2441	1002	806	EDR
High	2480	1002	806	EDR

Remark:

- The limit of mode (EDR) is 2/3 of 20dB BW;

Mode: BDR

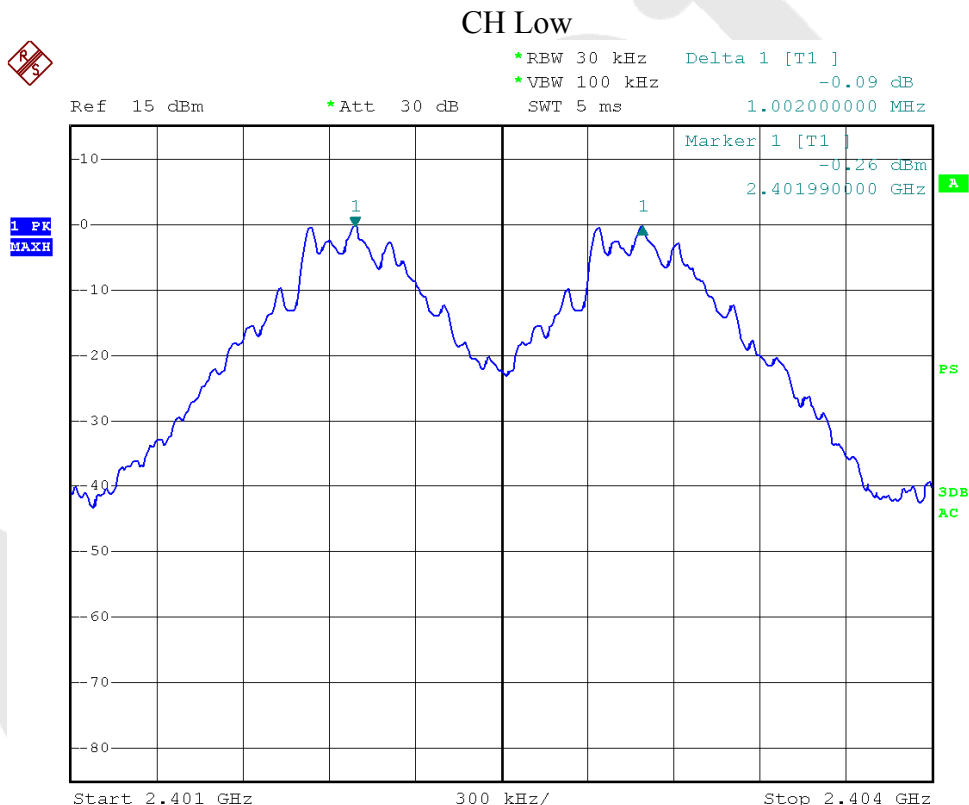

CH Mid

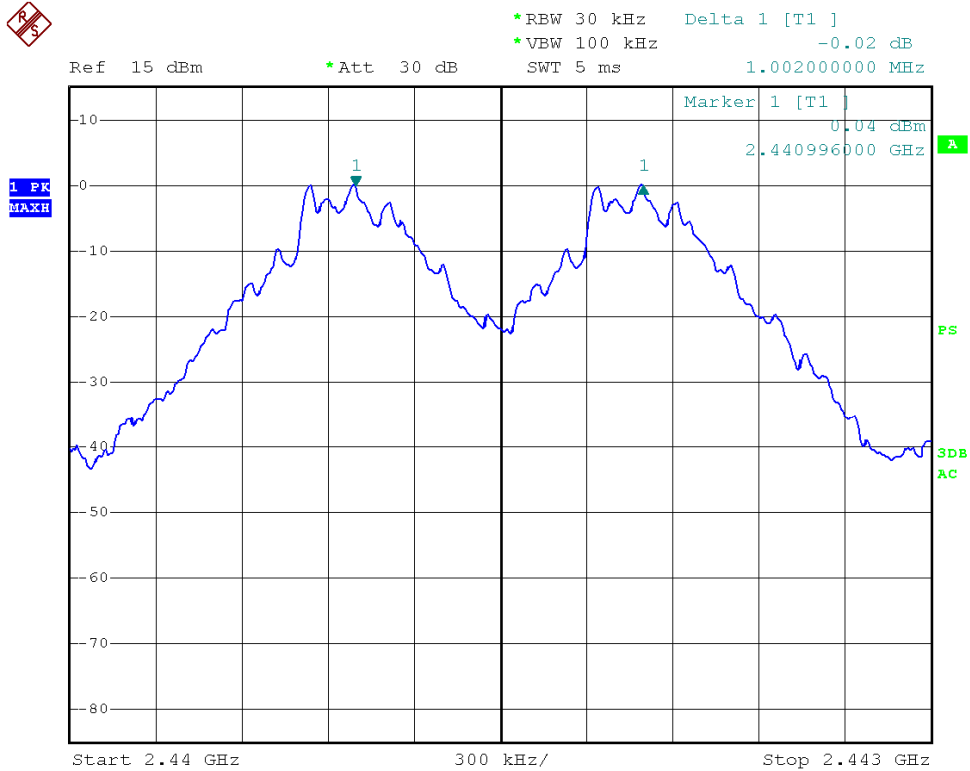

CH High

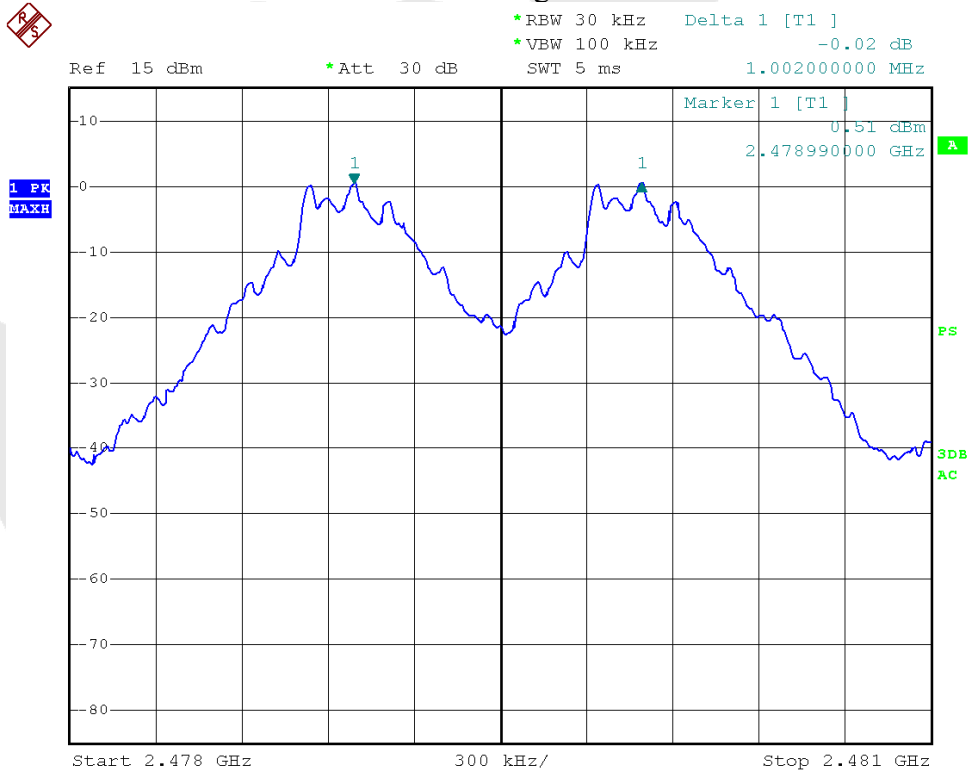

Mode: EDR

CH Low

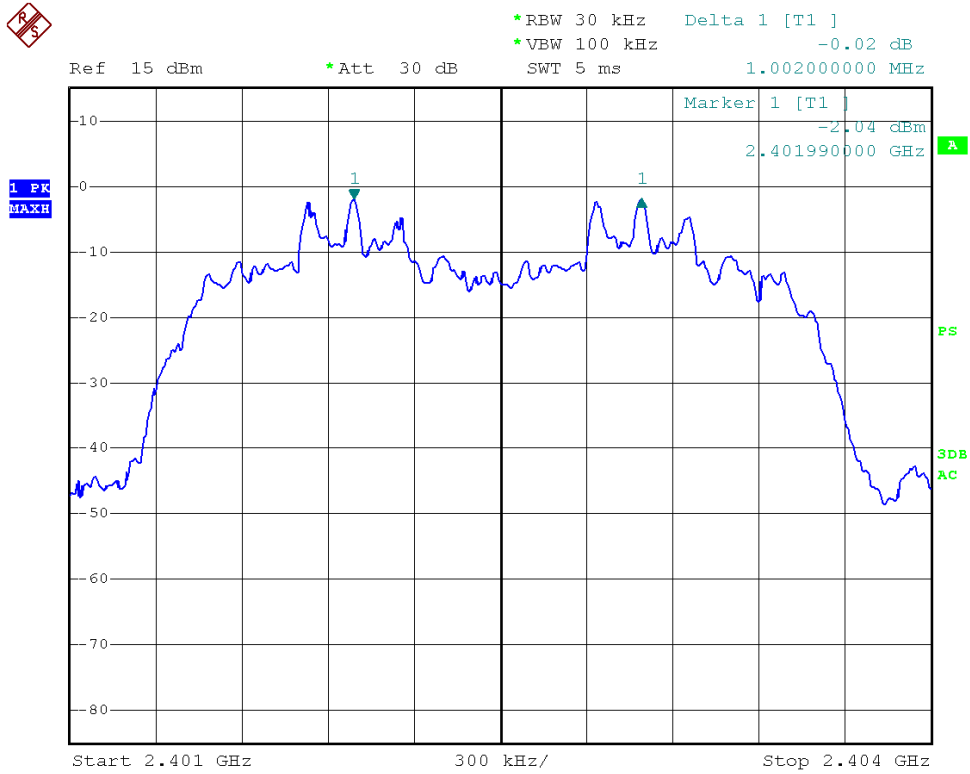

CH Mid

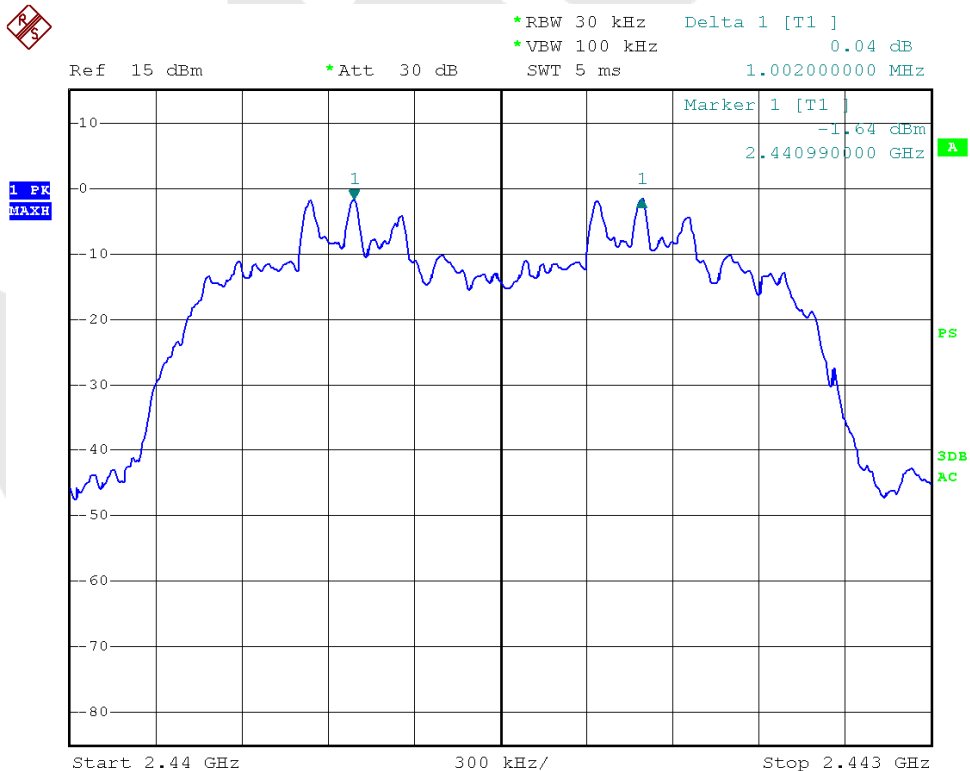

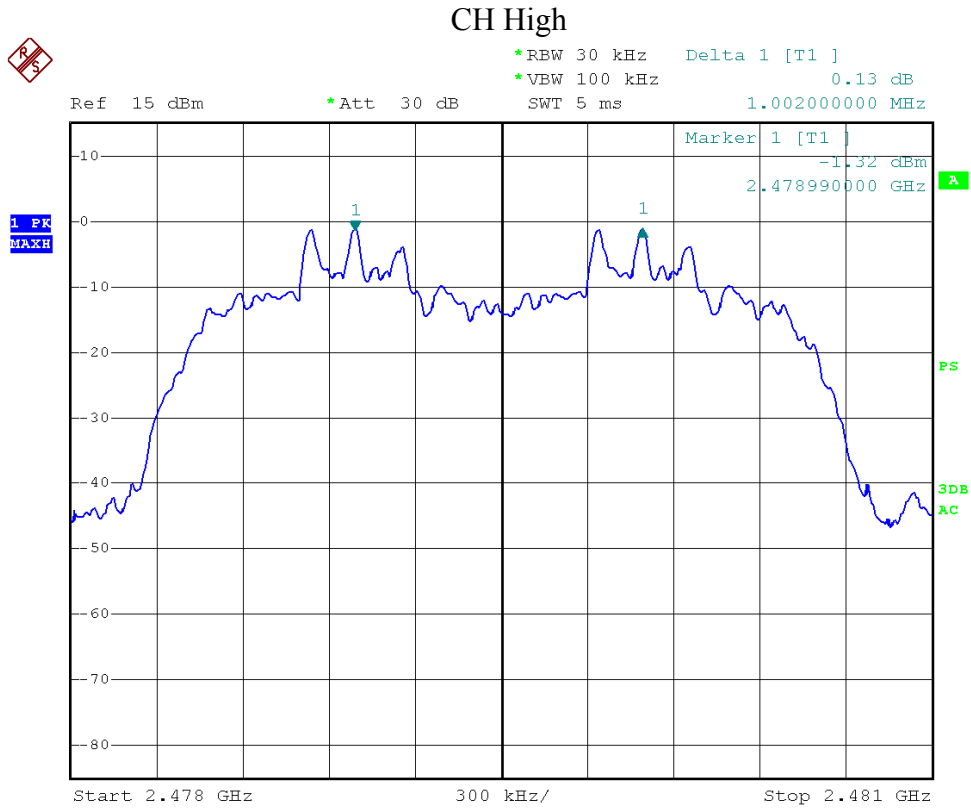

Anbotek

6. 20DB BANDWIDTH TEST

6.1 Measurement Procedure

Using the following spectrum analyzer settings:

1. Span= approximately 2 to 3 times the 20dB bandwidth, centered on a hopping channel.
2. Set the RBW = 30 kHz.
3. Set the VBW = 100 kHz.
4. Sweep time = auto couple.
5. Detector function = peak.
6. Trace mode = max hold.
7. Allow trace to fully stabilize.

6.2 Test SET-UP

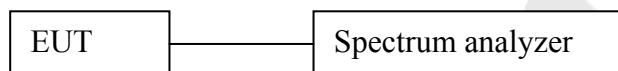

6.3 Test Equipment

Same as the equipment listed in 5.3.

6.4 Test Results

Test Item	: 20dB BW	Test Mode	: CH Low ~ CH High
Test Voltage	: DC 3.7V	Temperature	: 24°C
Test Result	: PASS	Humidity	: 55%RH

Channel	Frequency (MHz)	20dB Down BW(kHz)	Mode
Low	2401	850	BDR
Mid	2441	860	BDR
High	2480	840	BDR
Low	2401	1210	EDR
Mid	2441	1210	EDR
High	2480	1210	EDR

Mode: BDR

CH Low

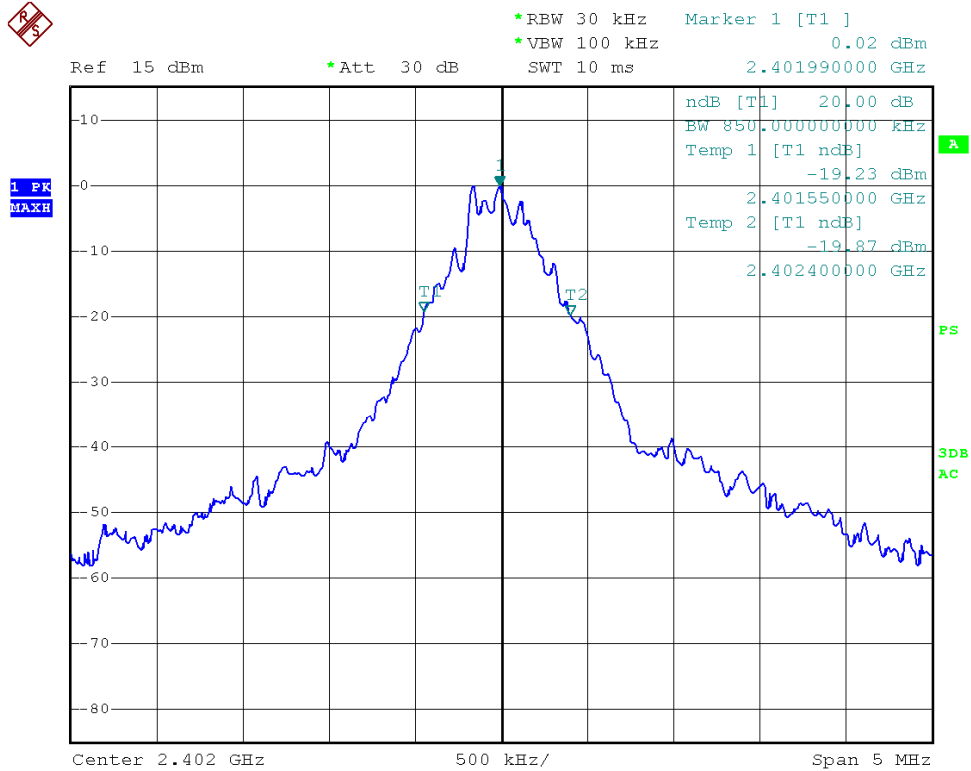

CH Middle

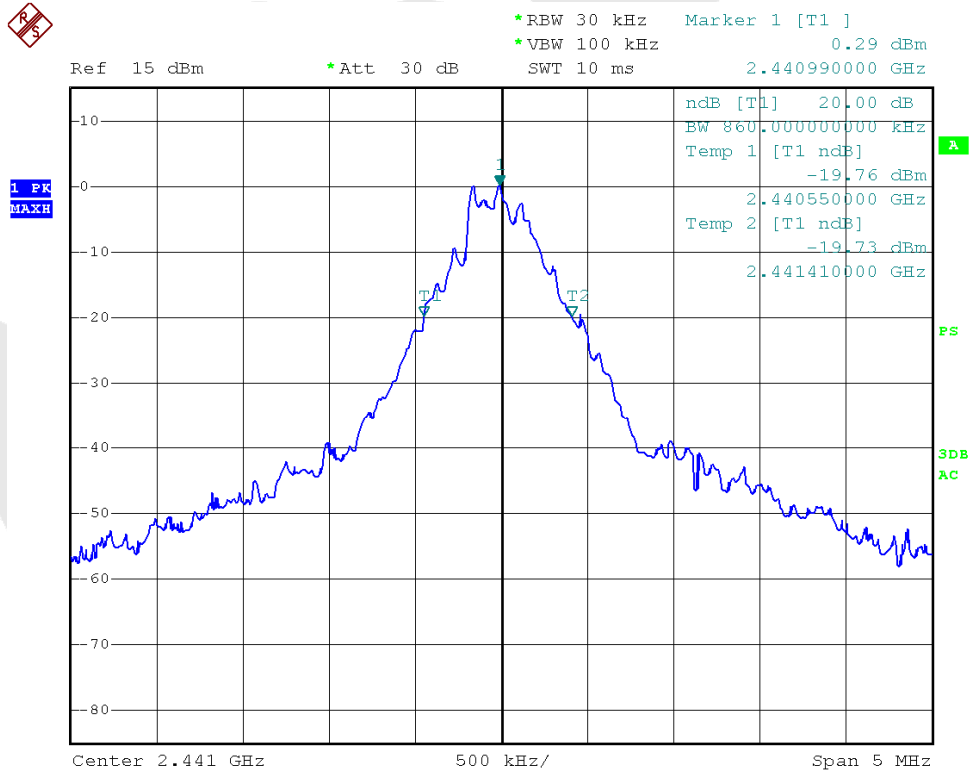

CH High

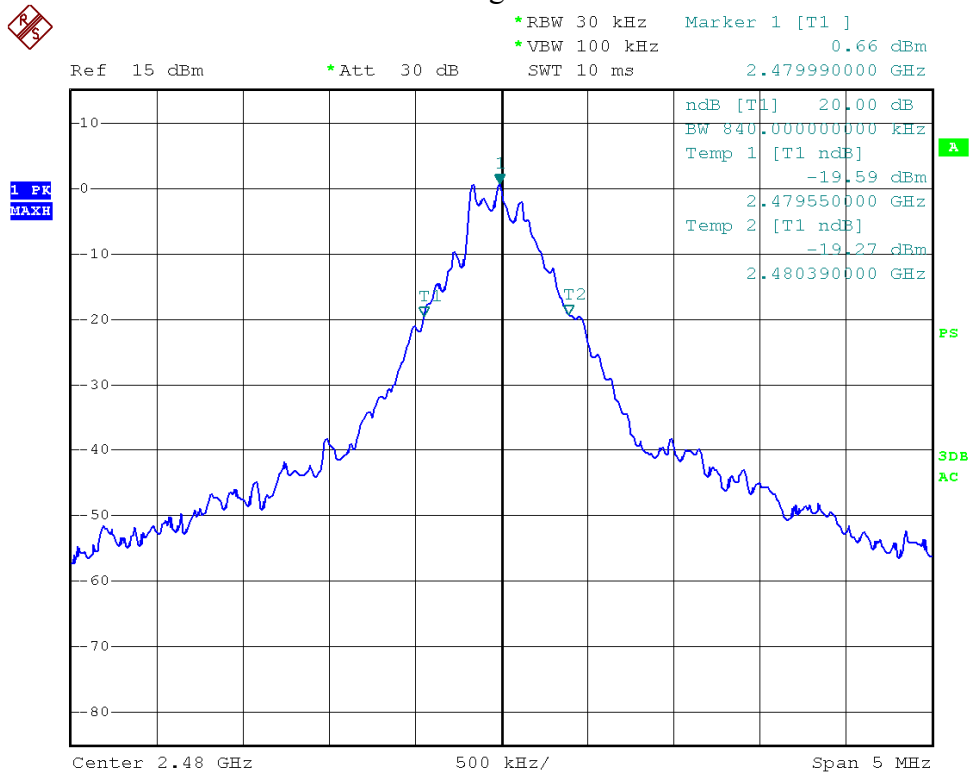

Modulation Mode: EDR

CH Low

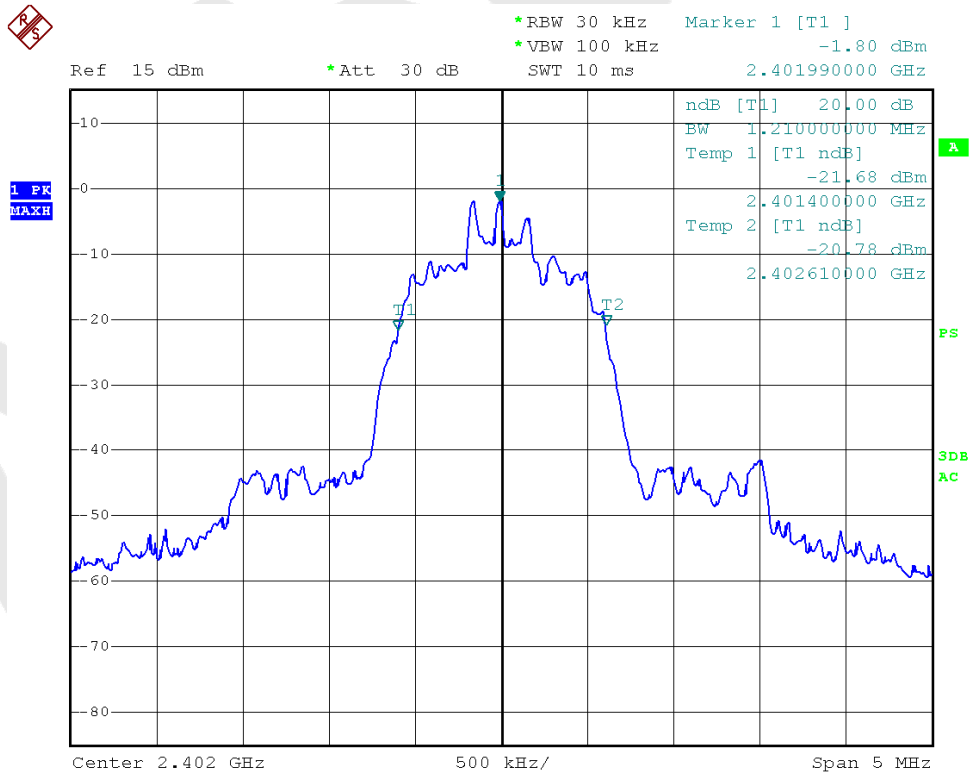

CH Middle

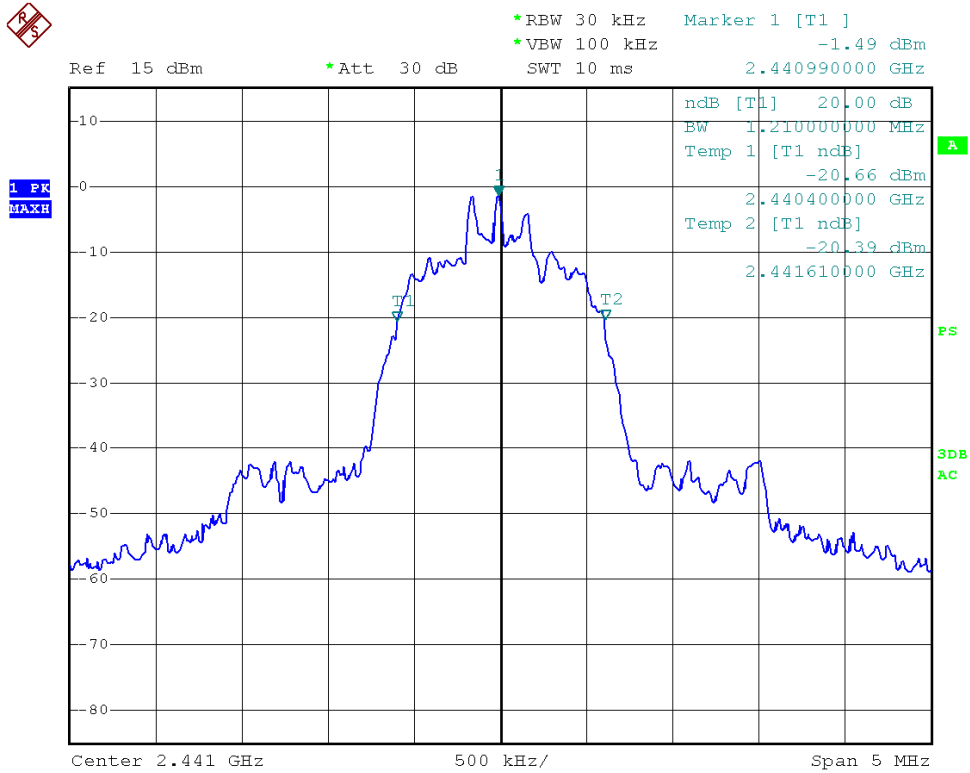

CH High

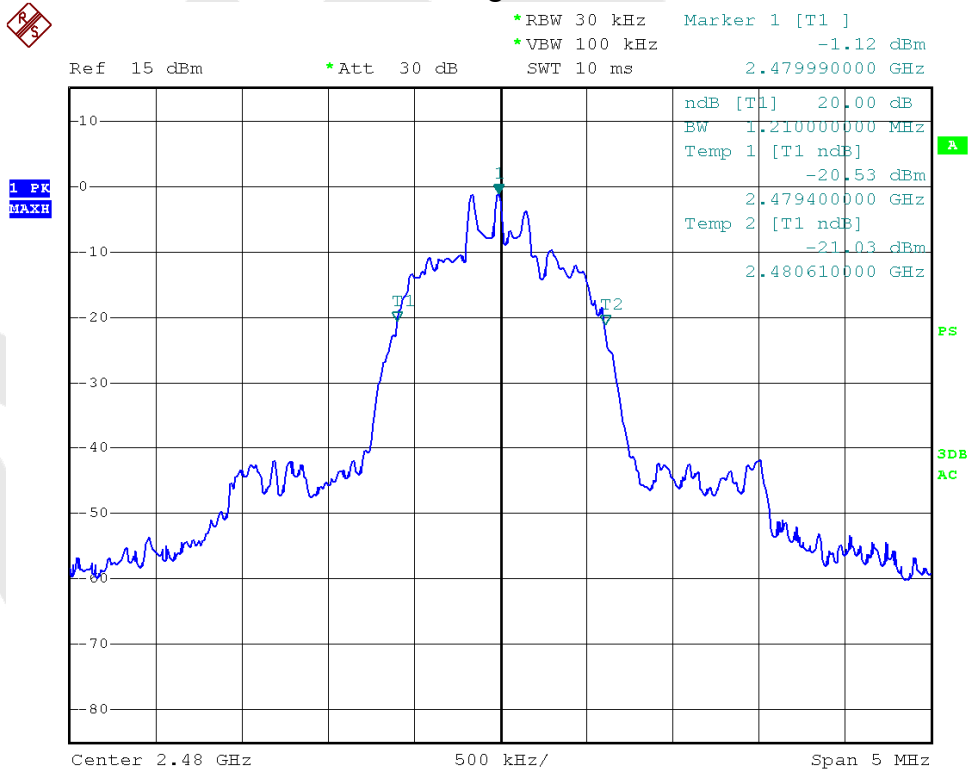

7. QUANTITY OF HOPPING CHANNEL TEST

7.1 Measurement Procedure

The EUT must have its hopping function enabled. Using the following spectrum analyzer setting:

1. Span= the frequency band of operation
2. Set the RBW = 1 MHz.
3. Set the VBW = 1 MHz.
4. Sweep time = auto couple.
5. Detector function = peak.
6. Trace mode = max hold.
7. Allow trace to fully stabilize.

7.2 Test SET-UP

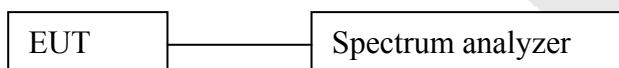

7.3 Test Equipment

Same as the equipment listed in 5.3.

7.4 Test Results

Test Item	: Number of Hopping Frequency	Test Mode	: CH Low ~ CH High
Test Voltage	: DC 3.7V	Temperature	: 24°C
Test Result	: PASS	Humidity	: 55%RH

Hopping Channel Frequency Range	Quantity of Hopping Channel	Quantity of Hopping Channel
2402-2480	79	> 15

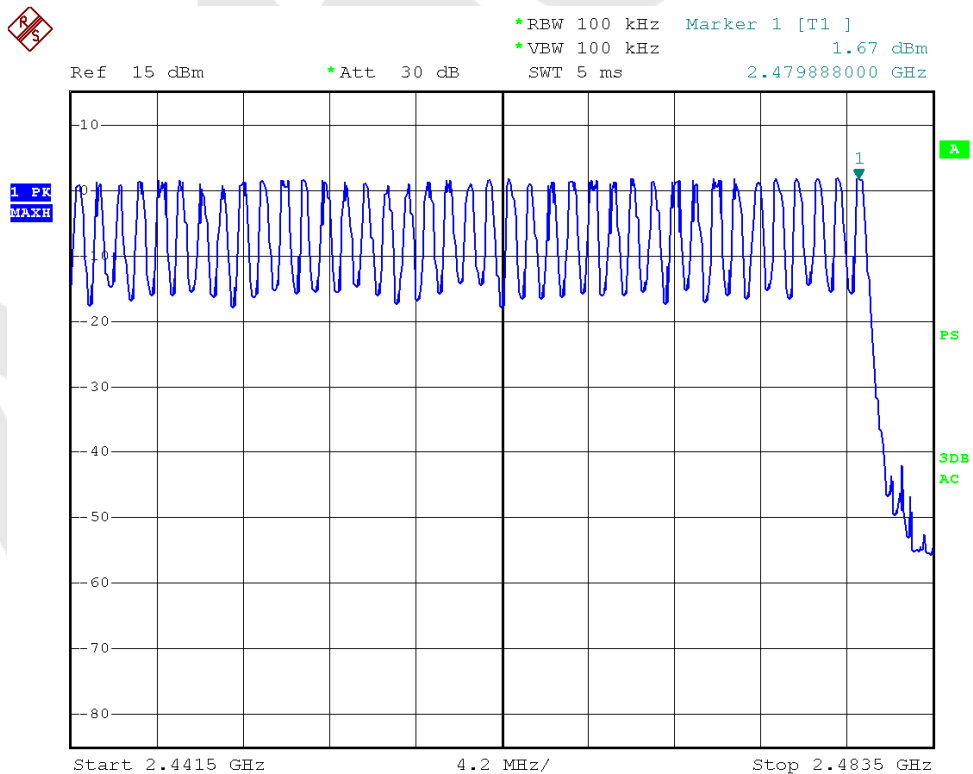
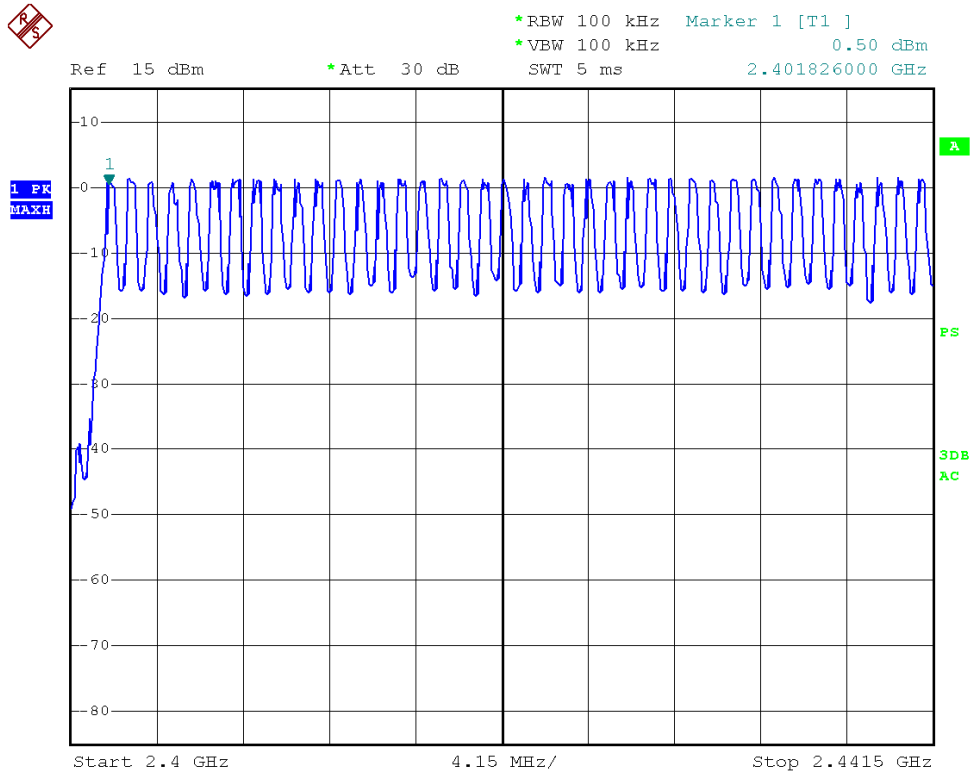

8. DWELL TIME TEST

8.1 Measurement Procedure

The EUT must have its hopping function enabled. Use the following spectrum analyzer settings:

1. Span= zero span, centered on a hopping channel
2. Set the RBW = 1 MHz.
3. Set the VBW = 1 MHz.
4. Sweep time = as necessary to capture the entire dwell time per hopping channel.
5. Detector function = peak.
6. Trace mode = max hold.
7. Allow trace to fully stabilize.

8.2 Test SET-UP

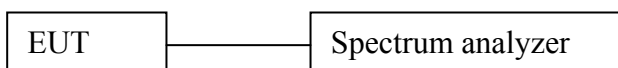

8.3 Test Equipment

Same as the equipment listed in 5.3.

8.4 Test Results

Test Item	: Time of Occupancy	Test Mode	: CH Low ~ CH High
Test Voltage	: DC 3.7V	Temperature	: 24°C
Test Result	: PASS	Humidity	: 55%RH

Package Type	Pulse width (ms)	Time slot length(ms)	Dwell time (ms)	Limit (s)
DH1	0.430	time slot length *1600/2 /79 * 31.6	137.60	0.4
DH3	1.730	time slot length *1600/4 /79 * 31.6	276.80	0.4
DH5	2.970	time slot length *1600/6 /79 * 31.6	316.80	0.4

DH1

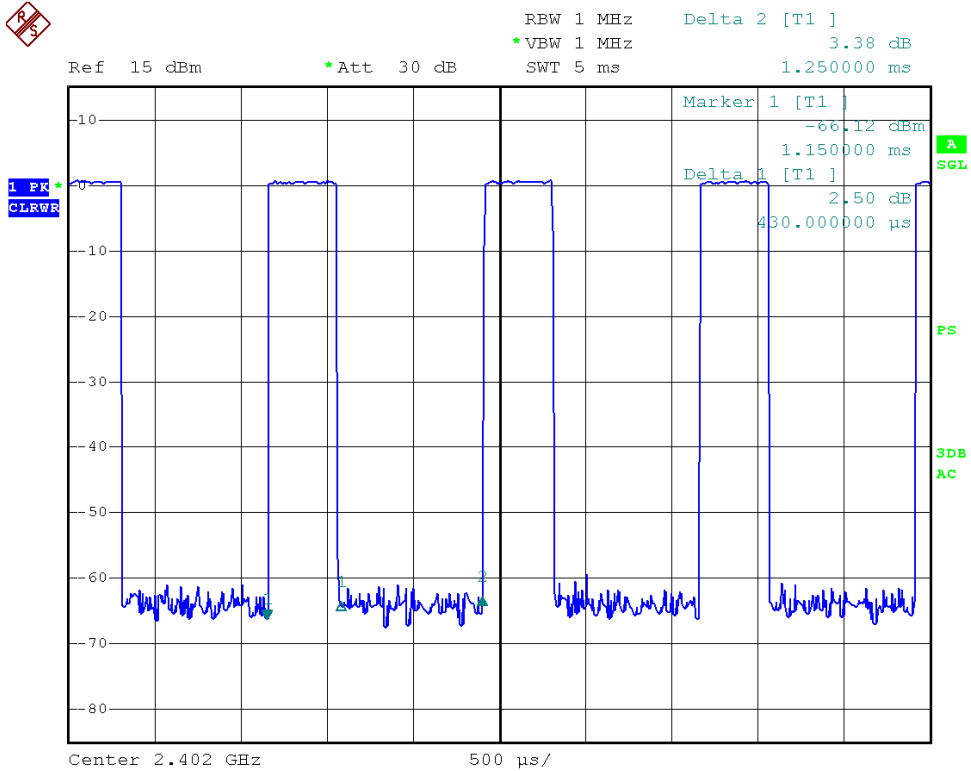

DH3

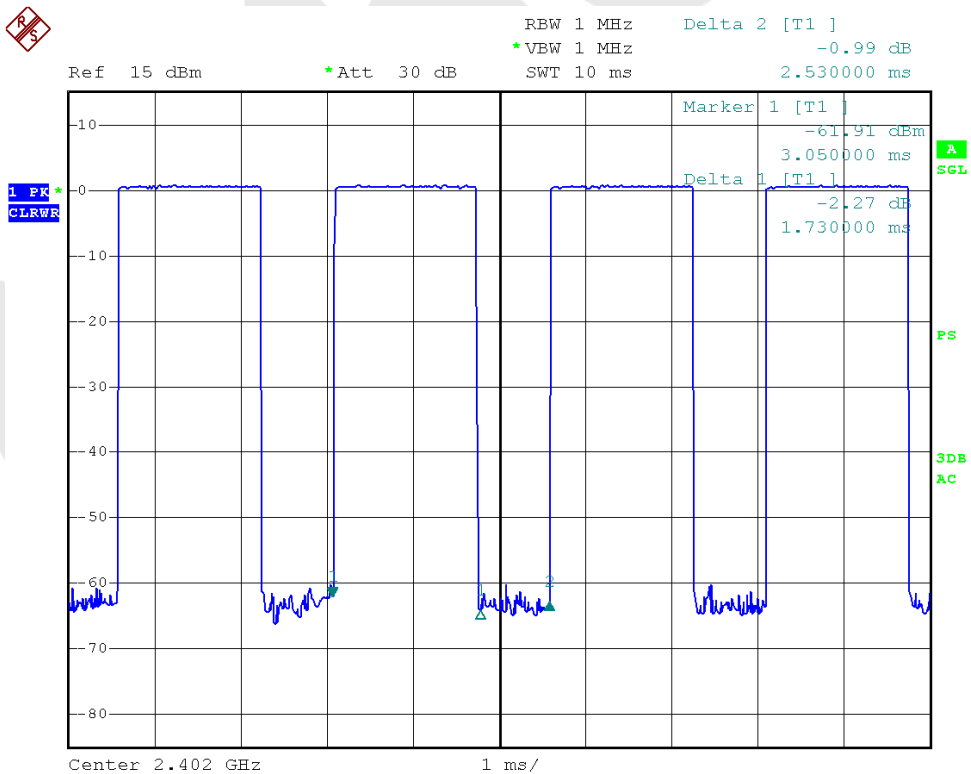

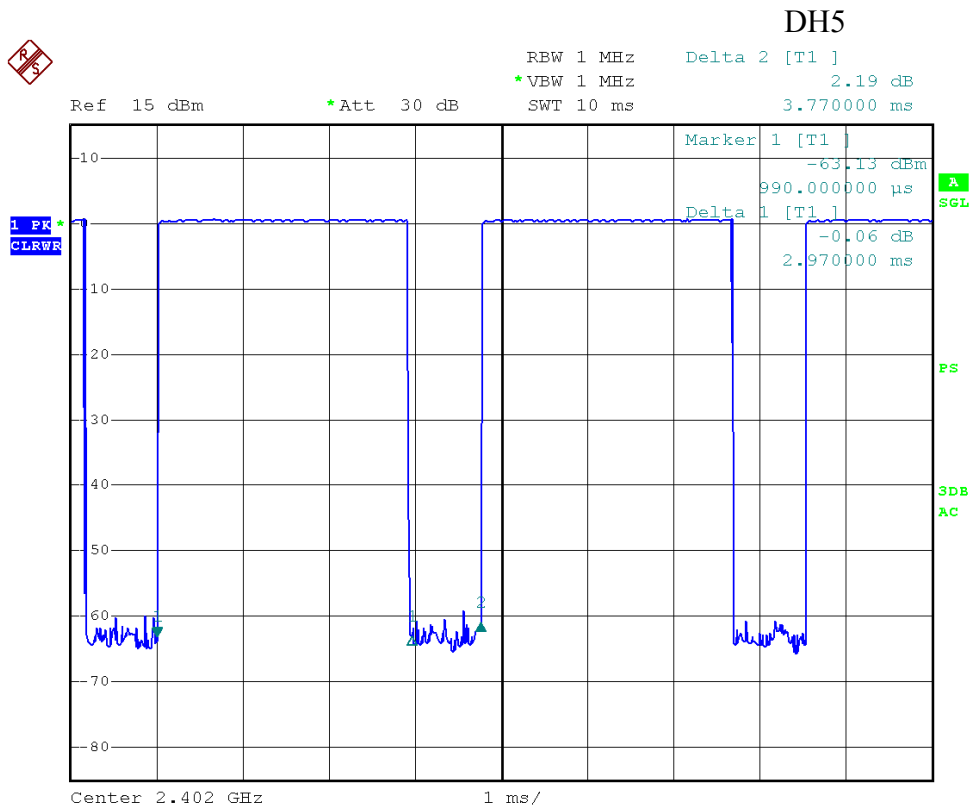

Anbotek

9. MAXIMUM PEAK OUTPUT POWER TEST

9.1 Measurement Procedure

- a. Check the calibration of the measuring instrument(SA) using either an internal calibrator or a known signal from an external generator.
- b. Turn on the EUT and connect it to measurement instrument. Then set it to any one convenient frequency within its operating range. Set a reference level on the measuring instrument equal to the highest peak value.
- c. The center frequency of the spectrum analyzer is set to the fundamental frequency and using proper RBW and VBW setting.
- d. Measure the captured power within the band and recording the plot.
- e. Repeat above procedures until all frequencies required were complete.

Using the following spectrum analyzer settings:

1. Span= approximately 5 times the 20dB bandwidth, centered on a hopping channel
2. Set the RBW = 3 MHz.
3. Set the VBW = 3 MHz.
4. Sweep time = auto couple.
5. Detector function = peak.
6. Trace mode = max hold.
7. Allow trace to fully stabilize.

9.2 Test SET-UP



9.3 Test Equipment

Same as the equipment listed in 5.3.

9.4 Test Results

Test Item : Max. peak output power Test Mode : CH Low ~ CH High
 Test Voltage : DC 3.7V Temperature : 24°C
 Test Result : PASS Humidity : 55%RH

Channel Frequency (MHz)	Peak Power output(mW)	Peak Power output(dBm)	Peak Power Limit(mW)	Results	Mode
2402	1.25	0.98	1000	PASS	BDR
2441	1.34	1.27	1000	PASS	BDR
2480	1.45	1.62	1000	PASS	BDR
2402	0.86	-0.63	125	PASS	EDR
2441	0.93	-0.30	125	PASS	EDR
2480	1.02	0.07	125	PASS	EDR

Mode: BDR

CH Low

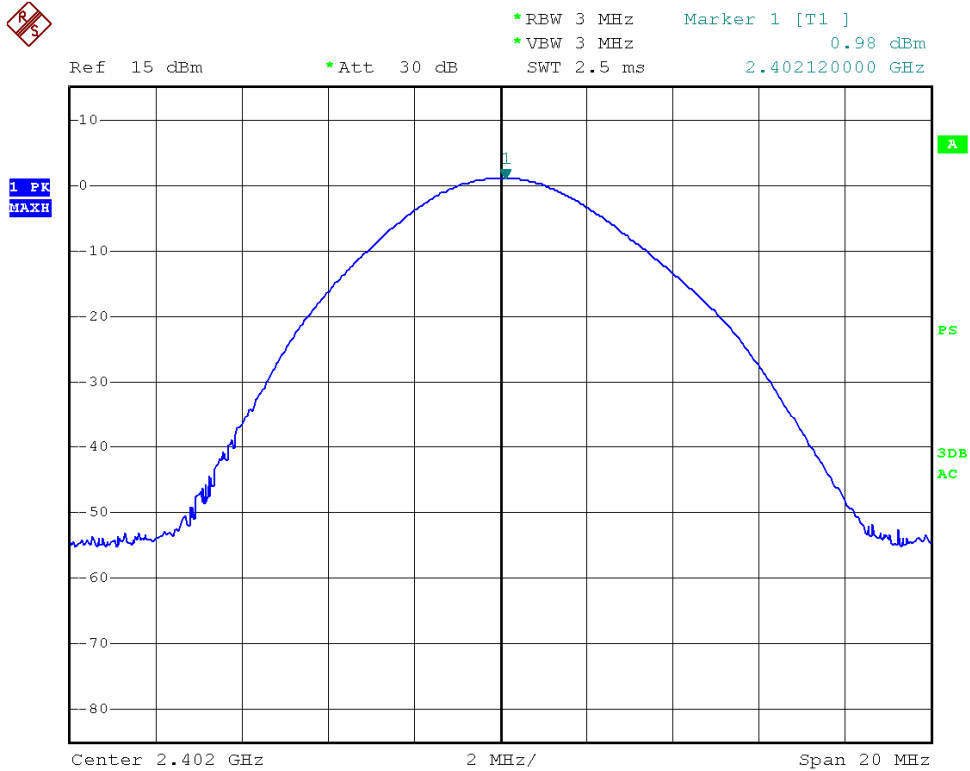

CH Mid

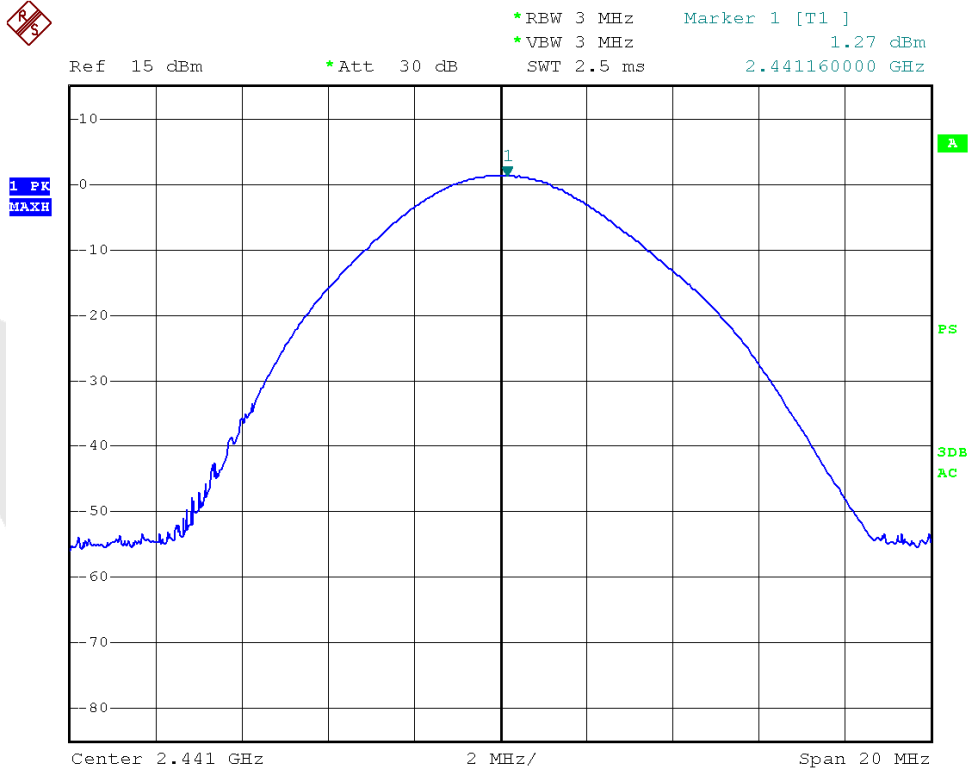

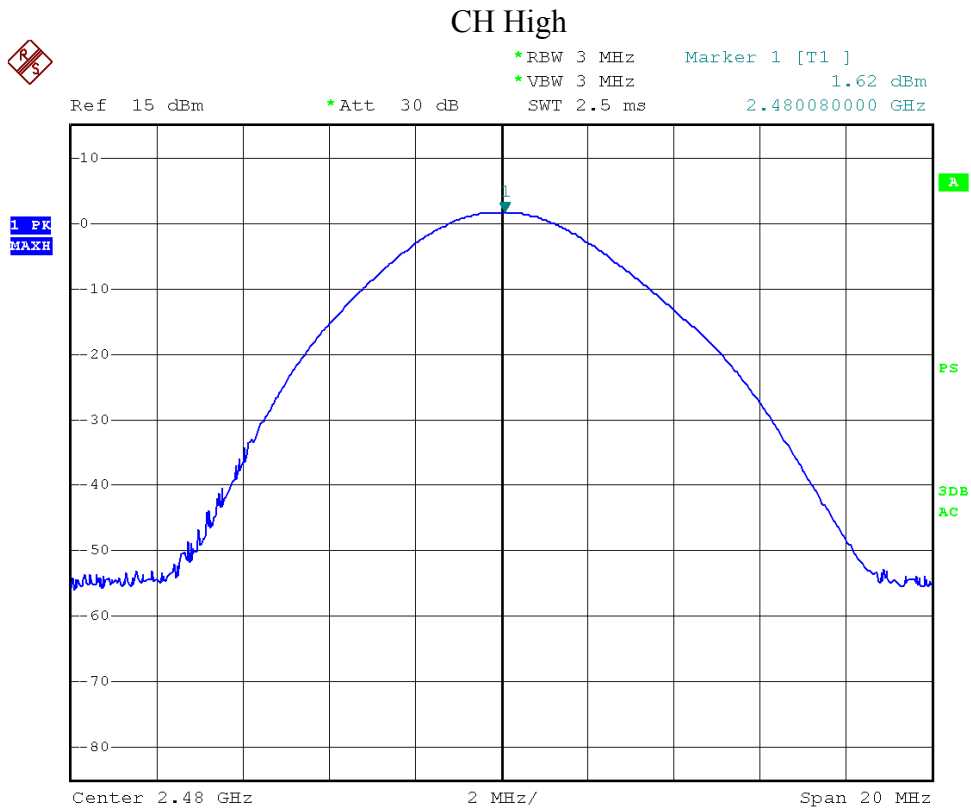

Mode: EDR

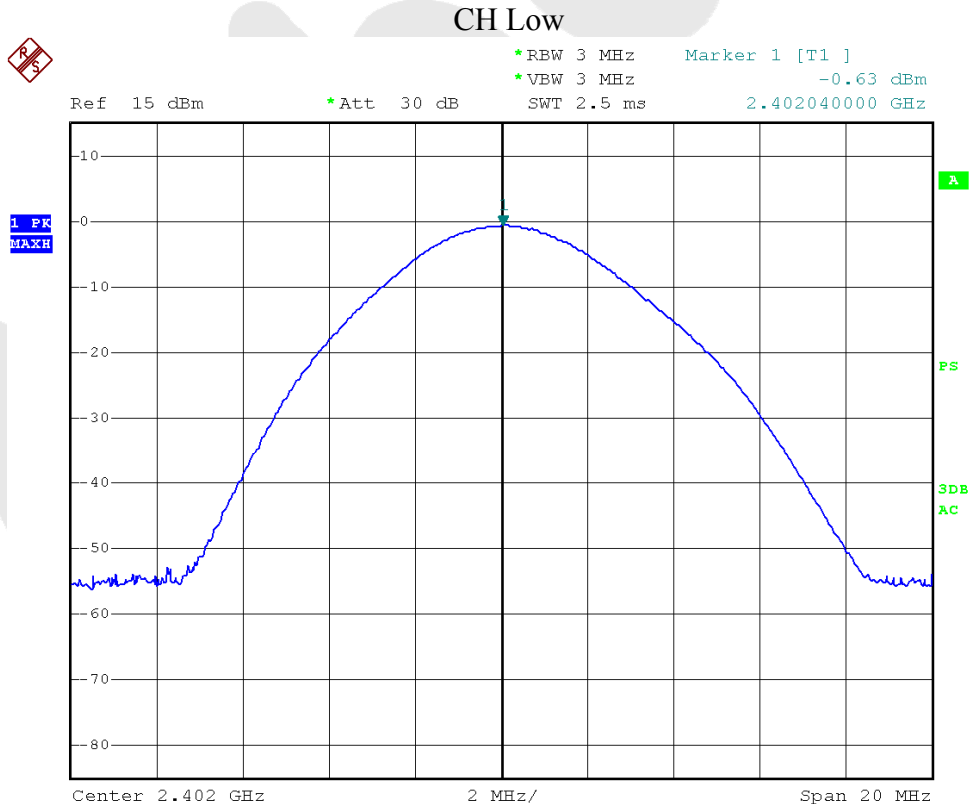

CH Mid

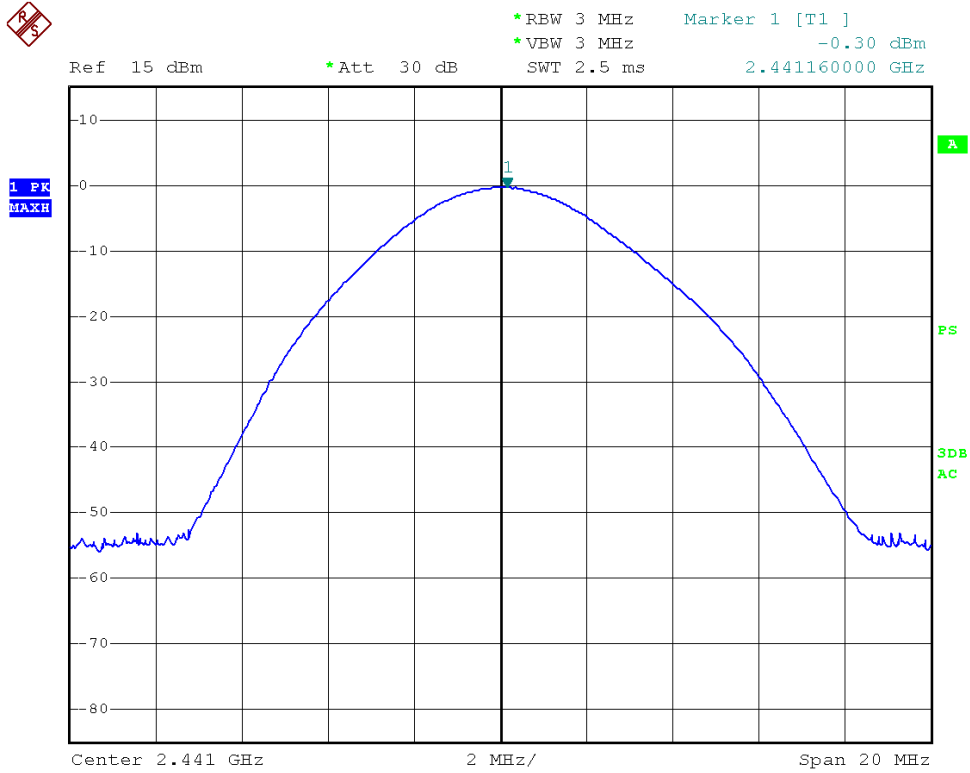

CH High

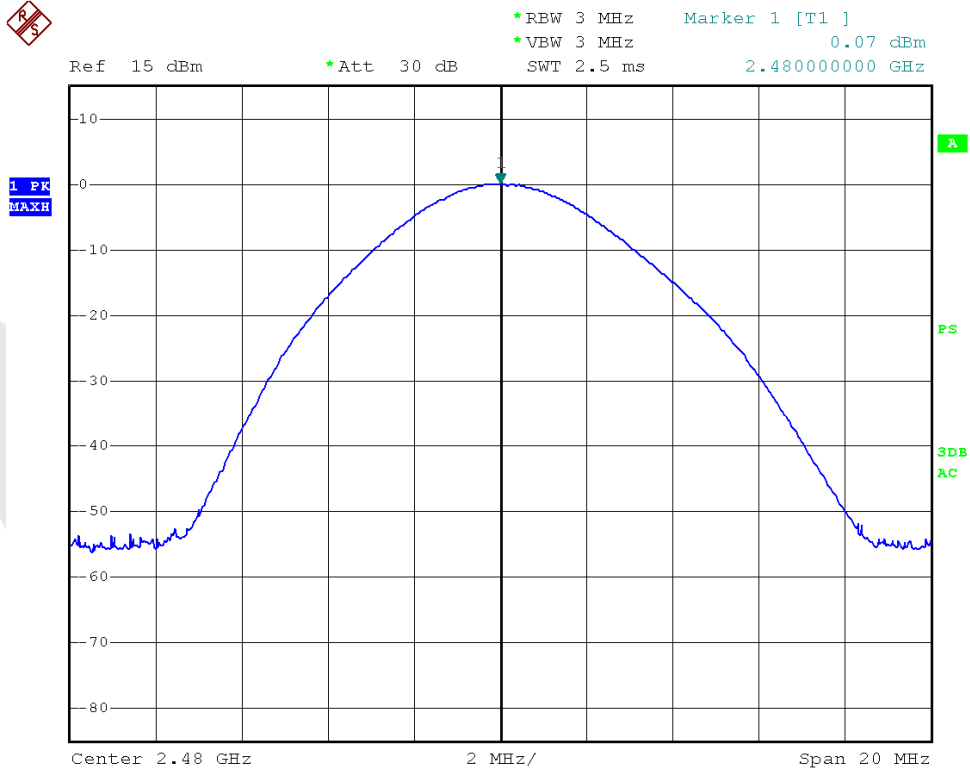

10. BAND EDGE TEST

10.1 Measurement Procedure

1. Check the calibration of the measuring instrument using either an internal calibrator or a known signal from an external generator.
2. Position the EUT without connection to measurement instrument. Put it on the Rotated table and turn on the EUT and make it operate in transmitting mode. Then set it to low Channel and High Channel within its operating range, and make sure the instrument is operated in its linear range.
3. Set both RBW and VBW of spectrum analyzer to 100kHz with a convenient frequency span including 100kHz bandwidth from band edge, for Radiated emissions restricted band RBW= 1 MHz, VBW= 3 MHz.
4. Measurement the highest amplitude appearing on spectral display and set it as a reference level. Plot the graph with marking the highest point and edge frequency.
5. Report above procedures until all measured frequencies were complete.

10.2 Test SET-UP

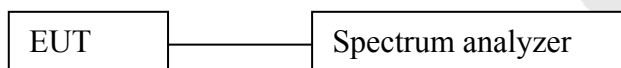

10.3 Test Equipment

Same as the equipment listed in 5.3.

10.4 Test Results

Pass.

Please refer the following data.

Test Item	: Band eadge	Test Mode	: CH Low ~ CH High
Test Voltage	: DC 3.7V	Temperature	: 24°C
Test Result	: PASS	Humidity	: 55%RH

For Hopping Mode:

Mode: BDR

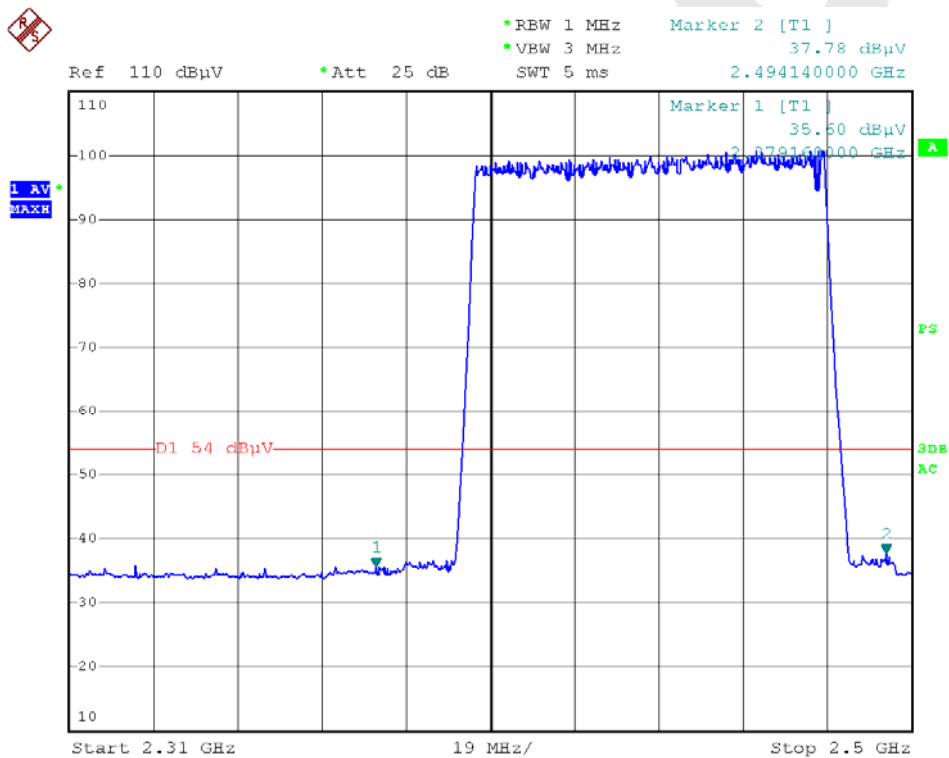
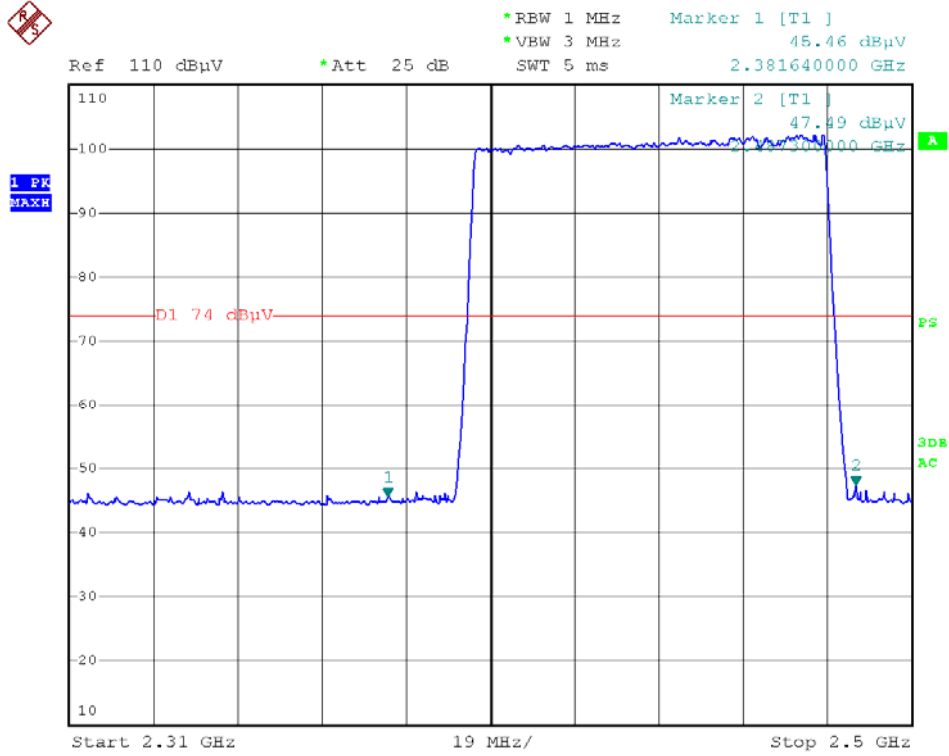

Mode: EDR

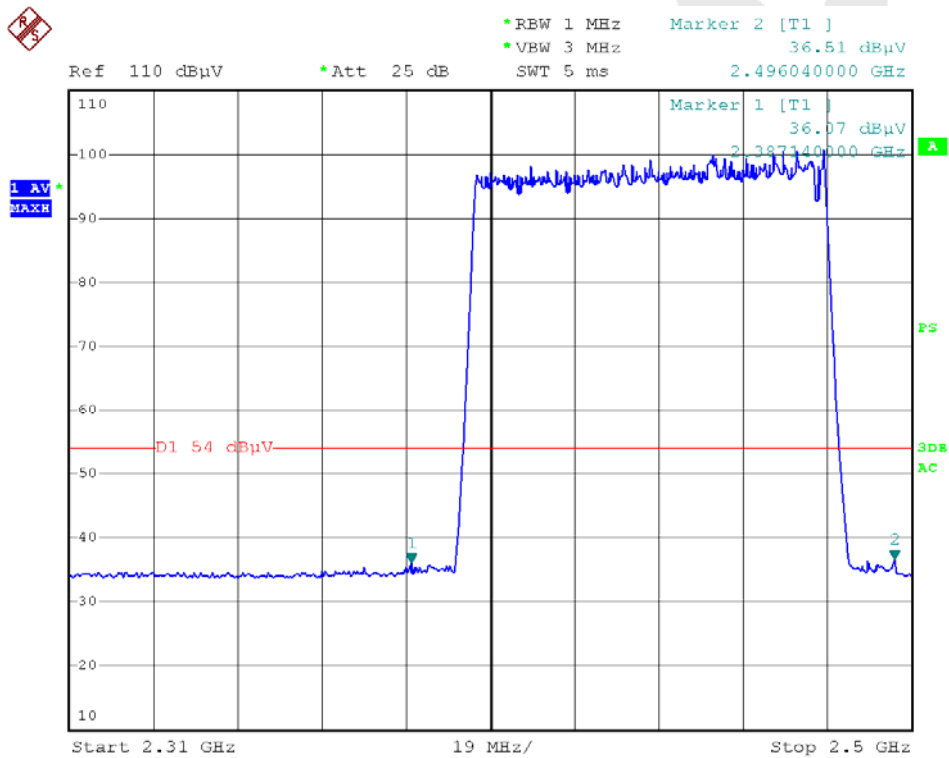
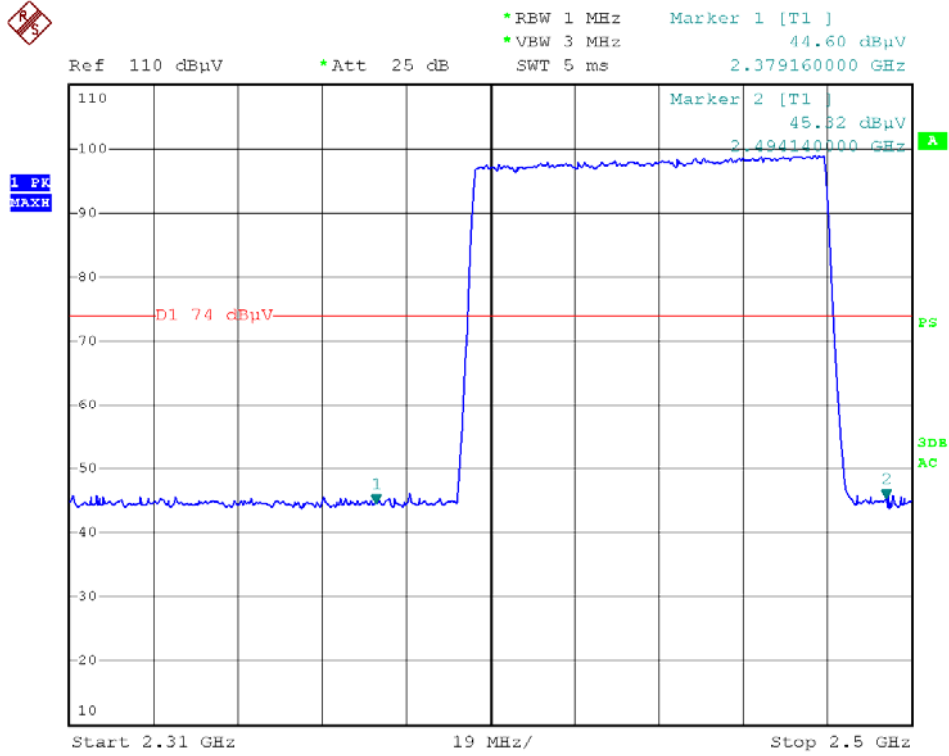

Test Item	: Band edge	Test Mode	: CH Low ~ CH High
Test Voltage	: DC 3.7V	Temperature	: 24°C
Test Result	: PASS	Humidity	: 55%RH

For Non-Hopping Mode:

1. Conducted Test

Frequency (MHz)	Peak Power Output(dBm)	Emission read Value(dBm)	Result of Band edge(dBc)	Band edge Limit(dBc)	Mode
<2400	1.05	-53.06	54.11	>20dBc	BDR
	-0.72	-53.36	52.64	>20dBc	EDR
>2483.5	1.61	-53.98	55.59	>20dBc	BDR
	-0.11	-53.51	53.40	>20dBc	EDR

2. Radiated emission Test

Frequency (MHz)	Antenna polarization (H/V)	Emission (dBuV/m)		Band edge Limit (dBuV/m)		Mode
		PK	AV	PK	AV	
<2400	V	57.13	37.02	74.00	54.00	BDR
	V	53.09	38.21	74.00	54.00	EDR
>2483.5	V	54.45	37.84	74.00	54.00	BDR
	V	52.19	36.95	74.00	54.00	EDR

Mode: BDR



*RBW 100 kHz Marker 3 [T1]
*VBW 100 kHz -53.06 dBm
SWT 10 ms 2.373920000 GHz

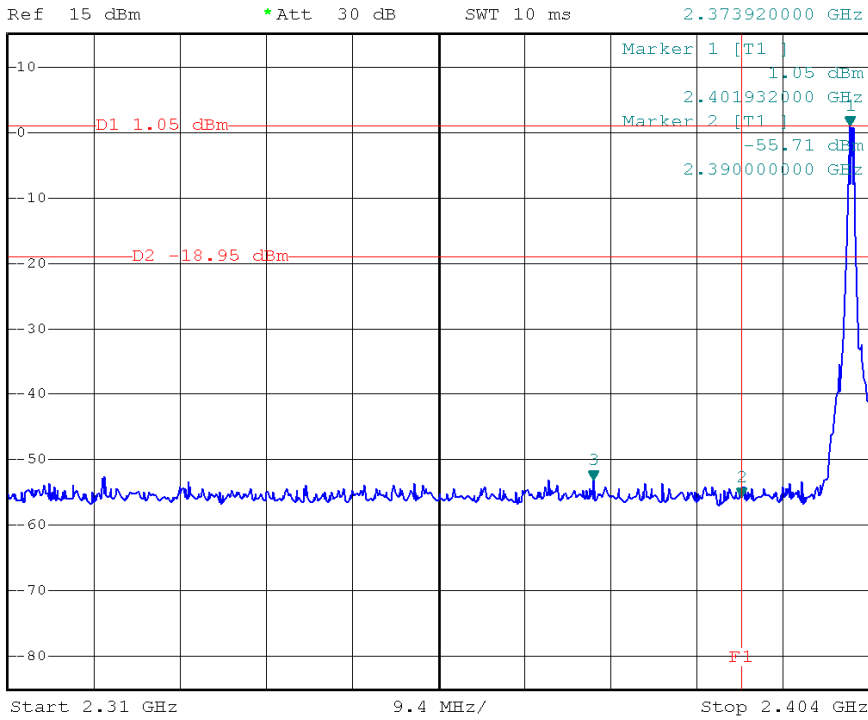

*RBW 100 kHz Marker 3 [T1]
*VBW 100 kHz -53.98 dBm
SWT 5 ms 2.485720000 GHz

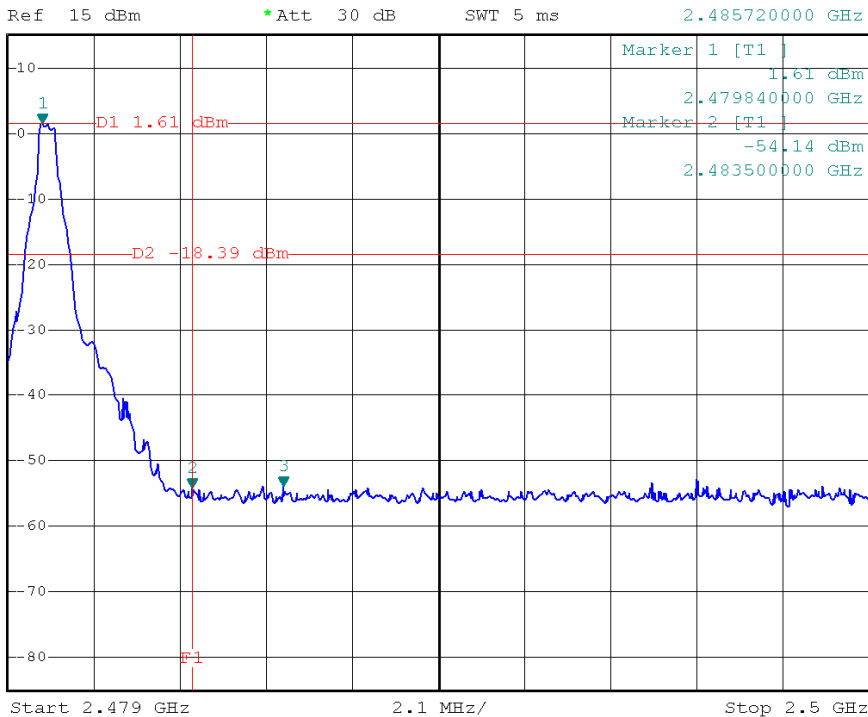

Mode: EDR



*RBW 100 kHz Marker 3 [T1]
*VBW 100 kHz -53.59 dBm
SWT 10 ms 2.361324000 GHz

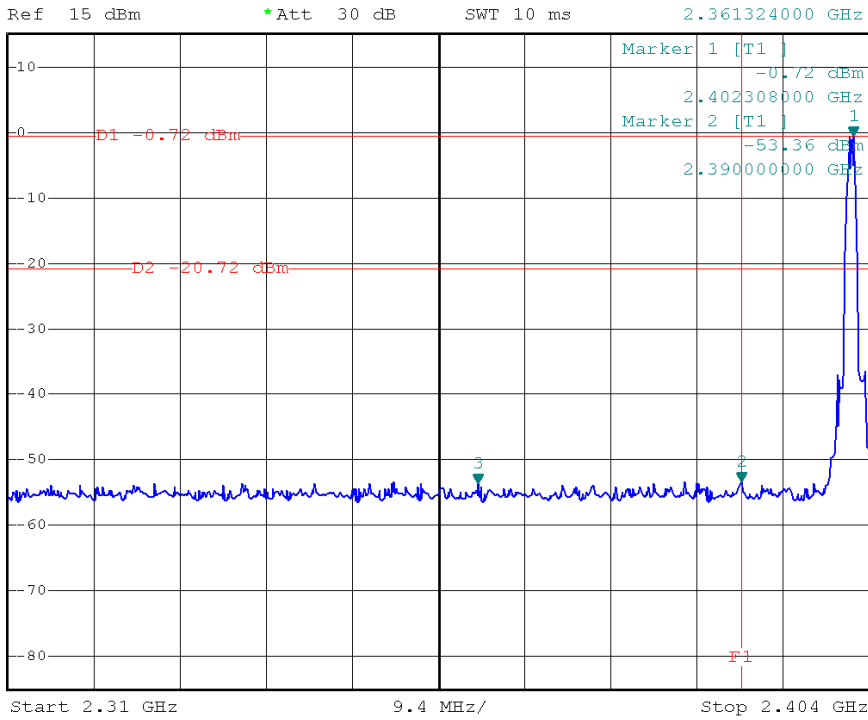

*RBW 100 kHz Marker 3 [T1]
*VBW 100 kHz -53.51 dBm
SWT 5 ms 2.484082000 GHz

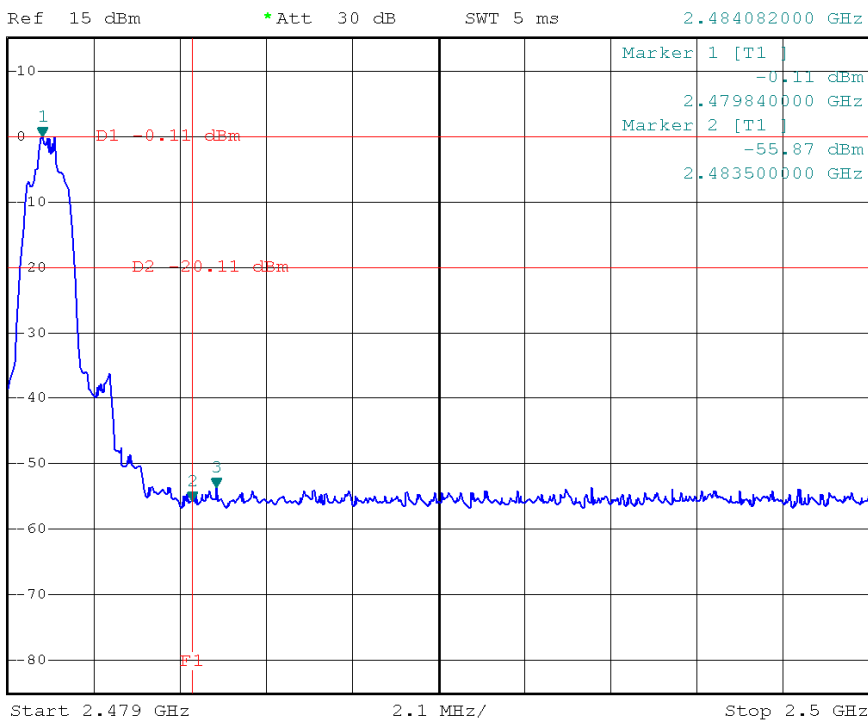

11. ANTENNA APPLICATION

11.1 Antenna requirement

The EUT'S antenna is met the requirement of FCC part 15C section 15.203 and 15.247.

FCC part 15C section 15.247 requirements:

Systems operating in the 2402-2480MHz band that are used exclusively for fixed, point-to-point operations may employ transmitting antennas with directional gain greater than 6dBi provided the maximum peak output power of the intentional radiator is reduced by 1dB for every 3dB that the directional gain of the antenna exceeds 6dBi.

11.2 Result

The EUT's antenna used a chip antenna and integrated on PCB, the antenna's gain is 2.3dBi and meets the requirement.

12. PHOTOGRAPH

12.1 Photo of Conducted Emission Test



12.2 Photo of Radiation Emission Test

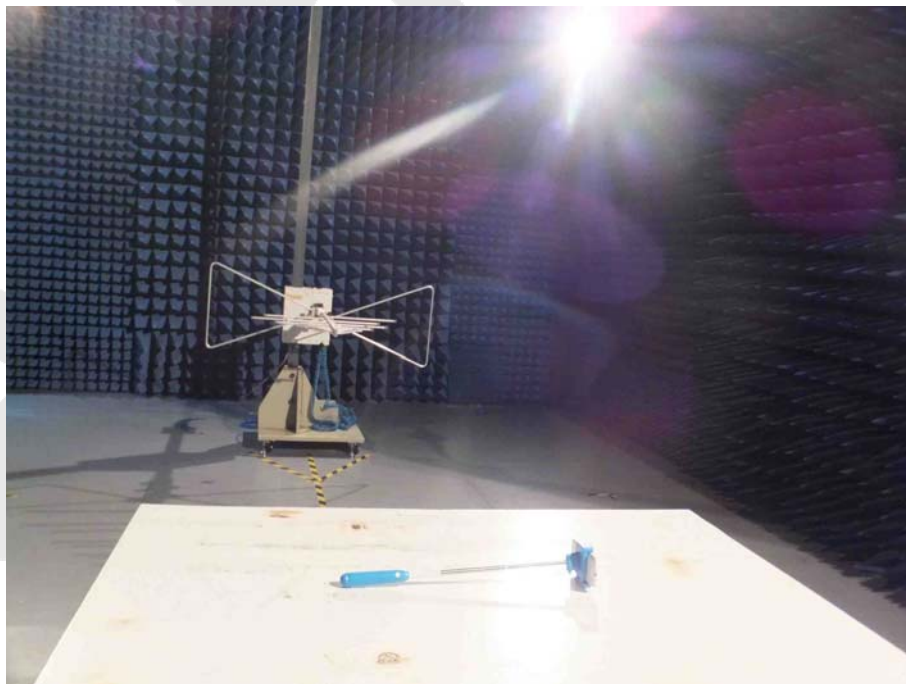

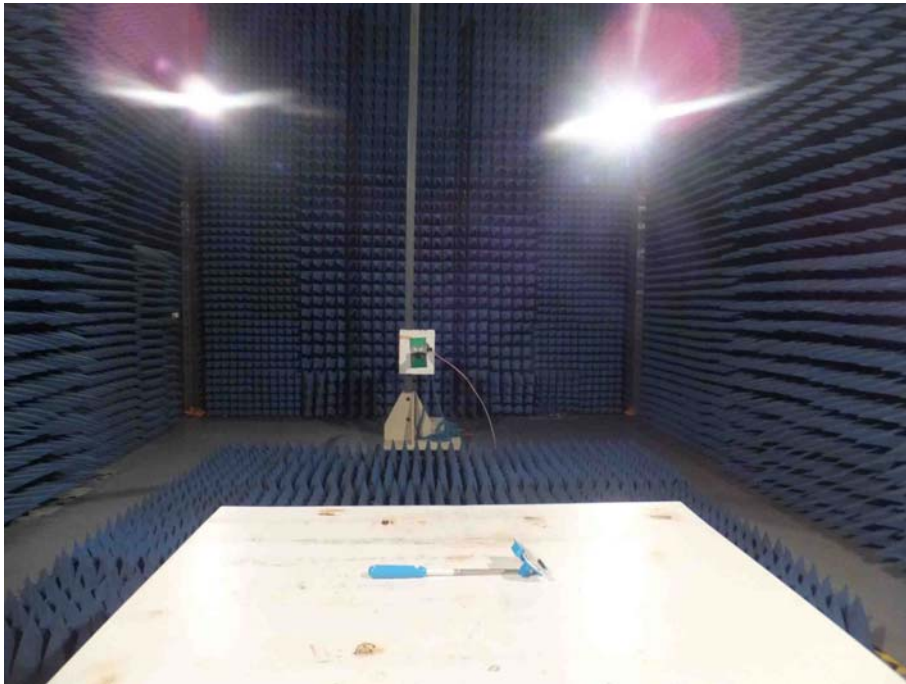

Anbotek

APPENDIX I (EXTERNAL PHOTOS)

Figure 1
The EUT-Top View

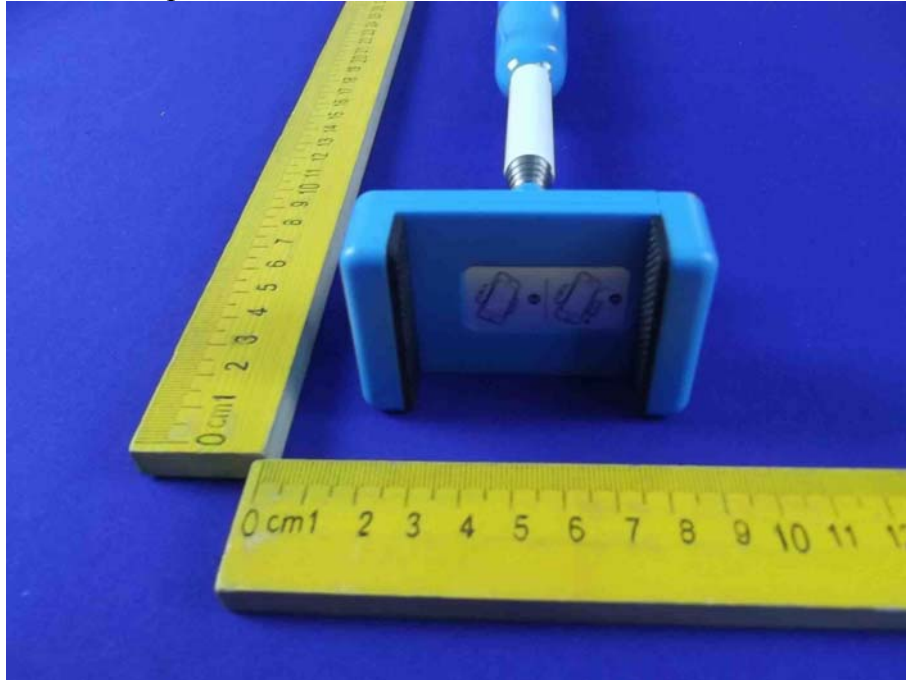

Figure 2
The EUT-Bottom View

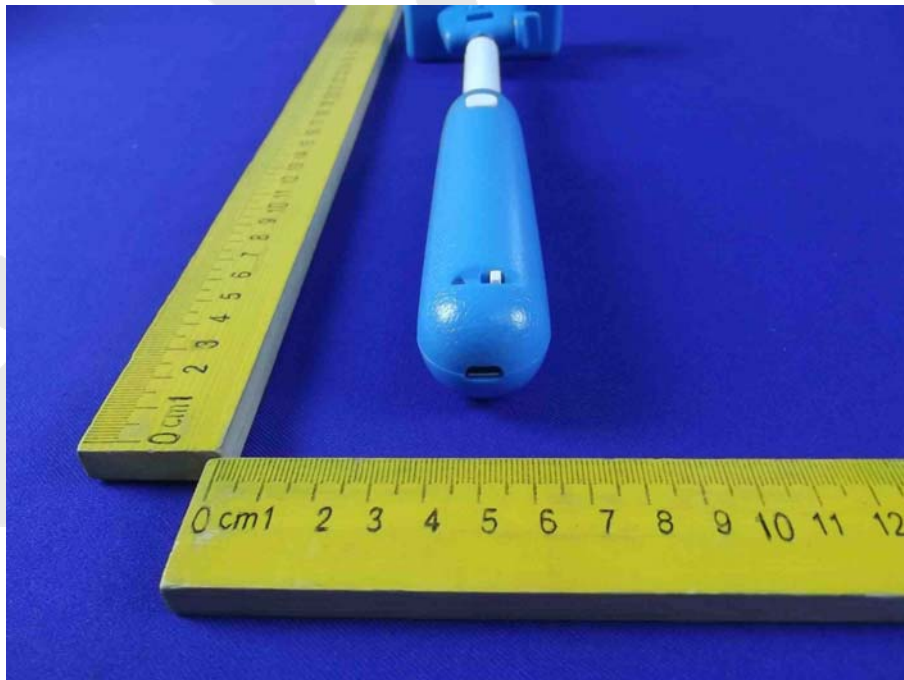

Figure 3
The EUT-Front View

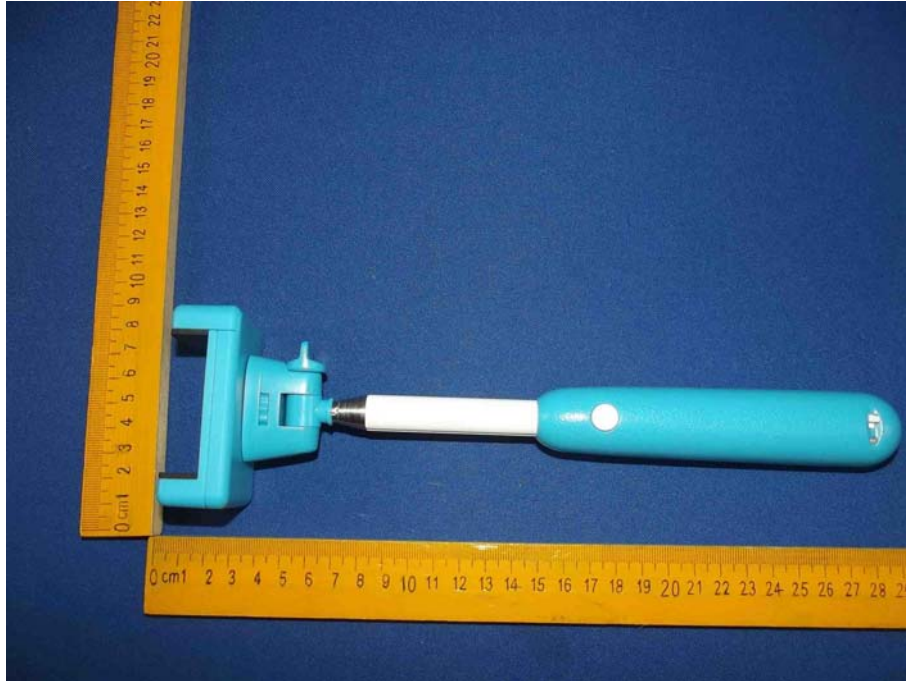

Figure 4
The EUT-Back View

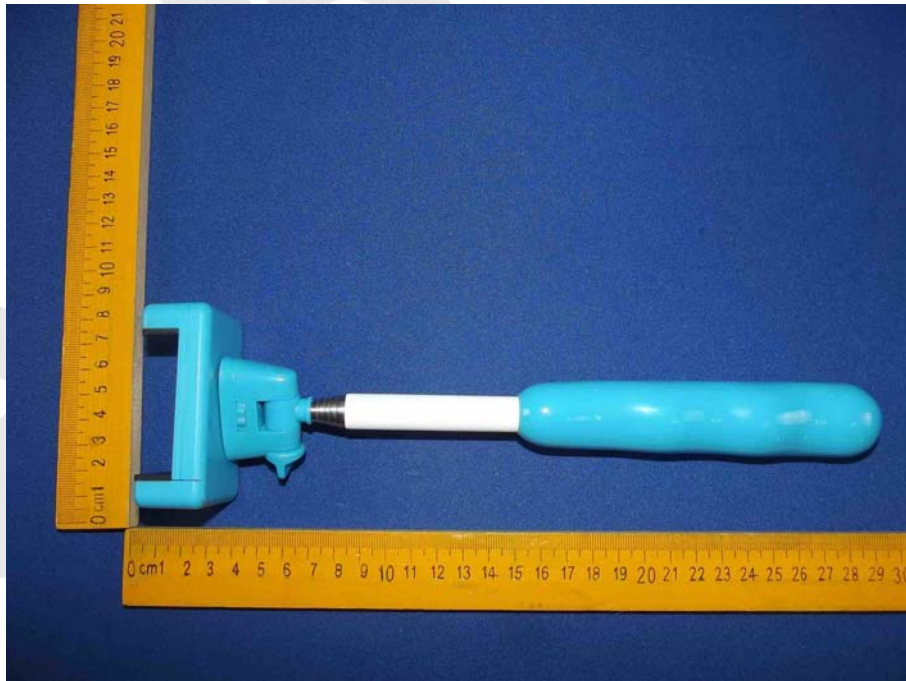

Figure 5
The EUT-Right View

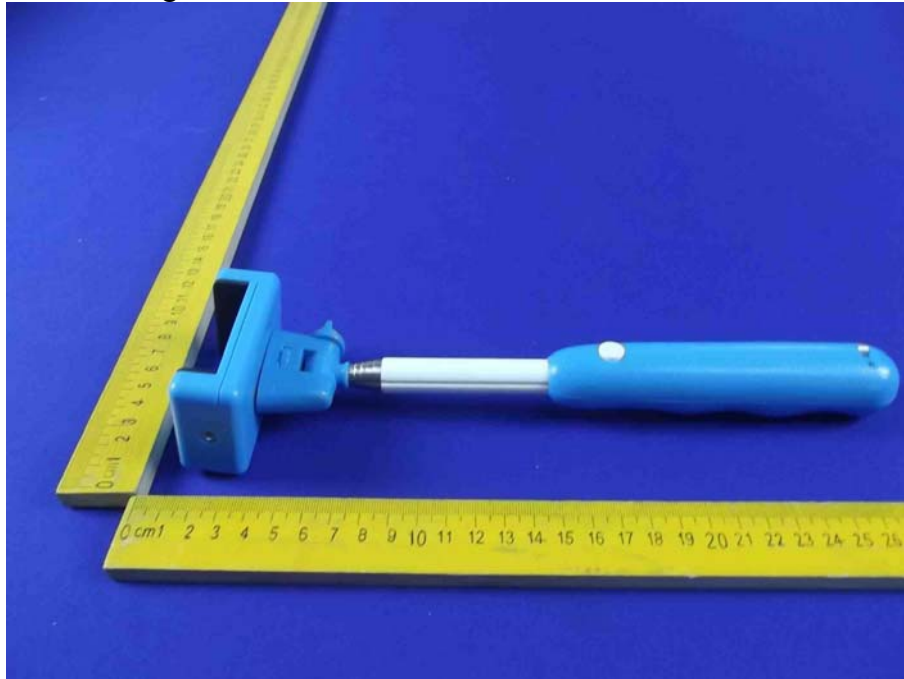
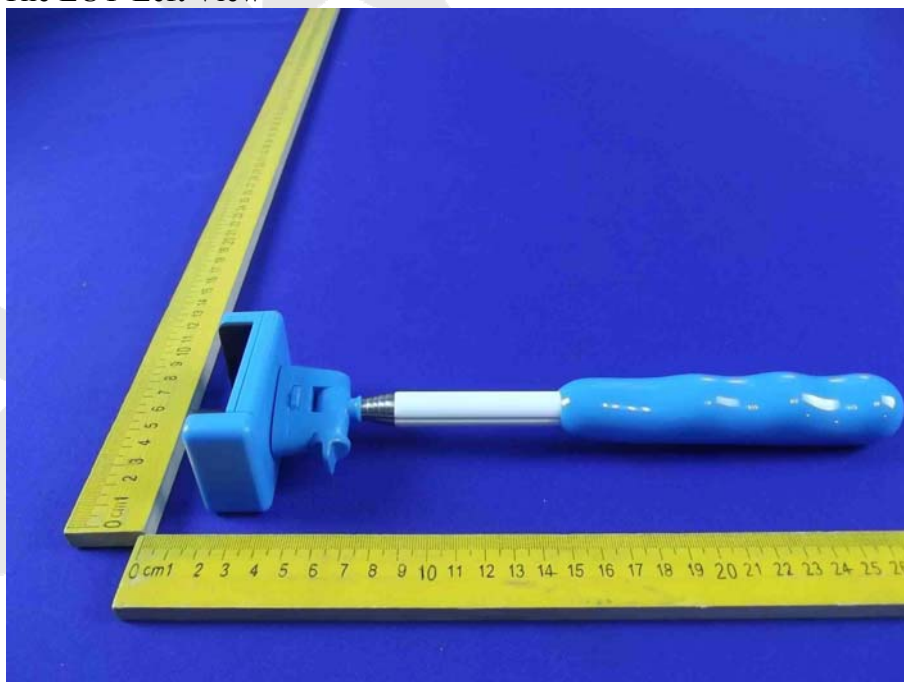

Figure 6
The EUT-Left View



APPENDIX II (INTERNAL PHOTOS)

Figure 7
The EUT-Inside View



Figure 8
PCB of the EUT-Front View

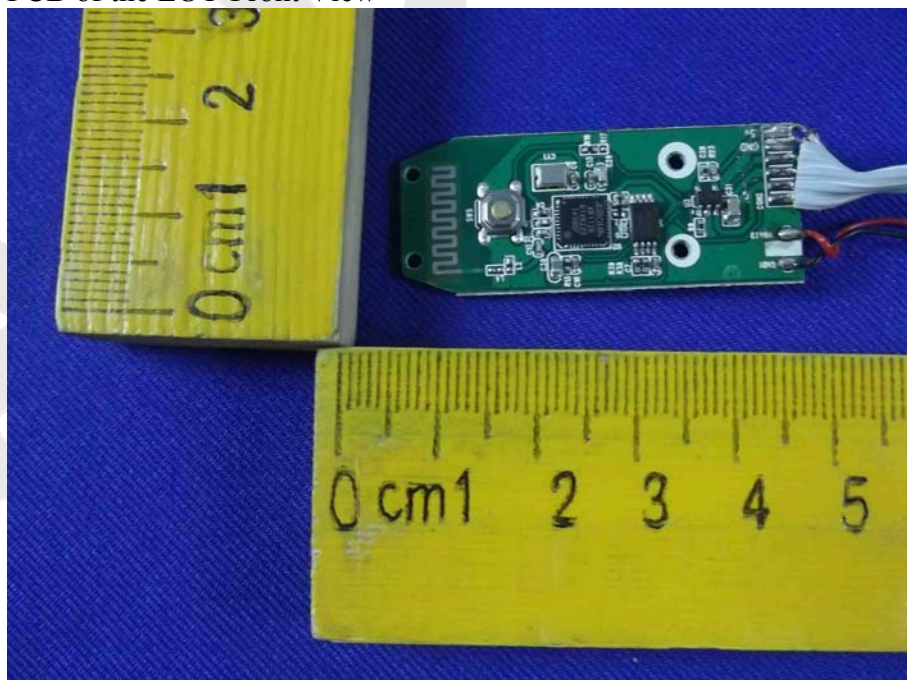

Figure 9
PCB of the EUT-Back View

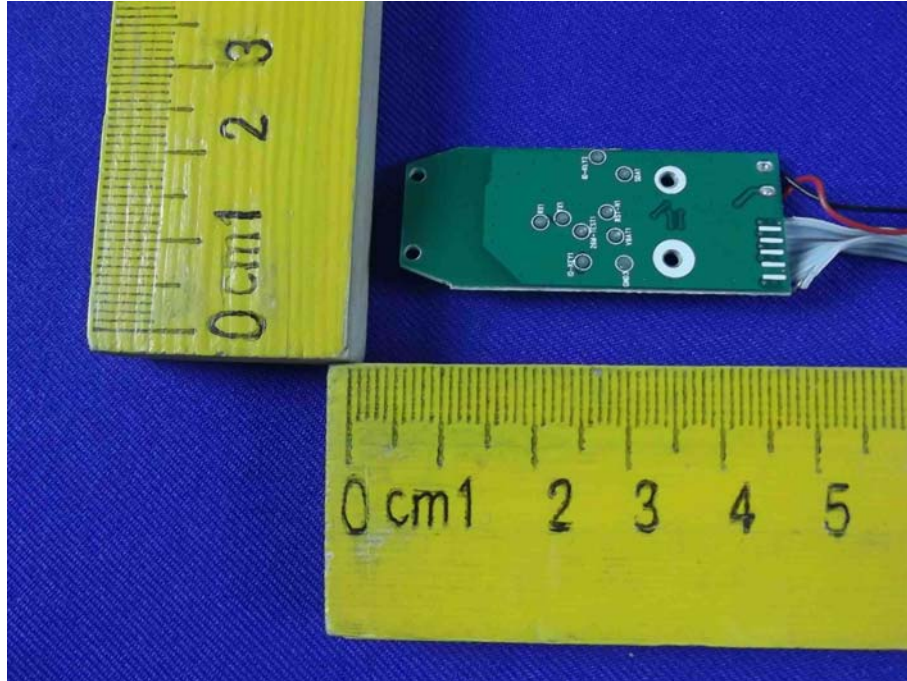

Figure 10
PCB of the EUT-Front View

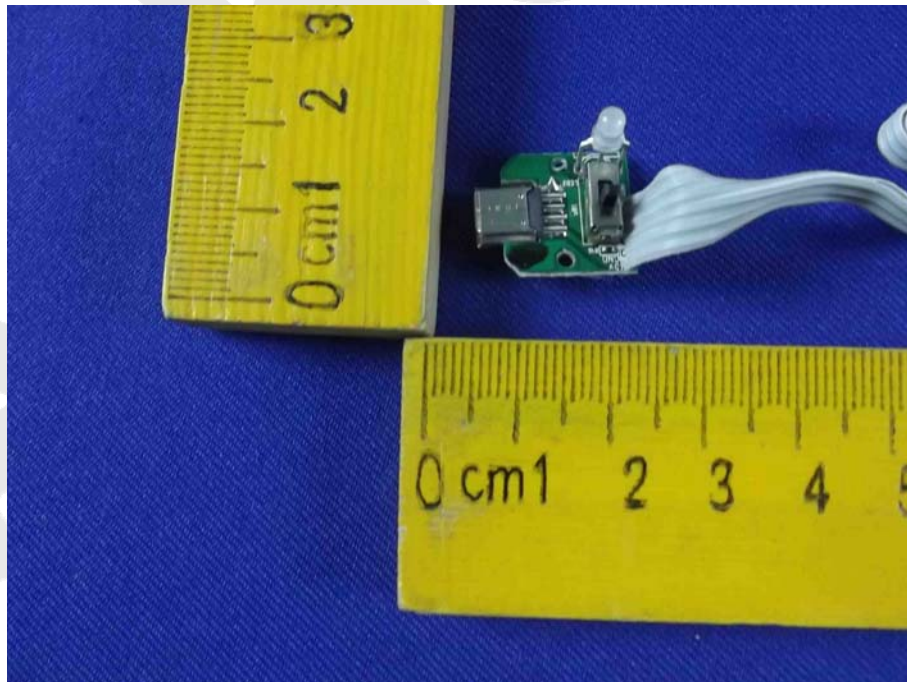

Figure 11
PCB of the EUT-Back View

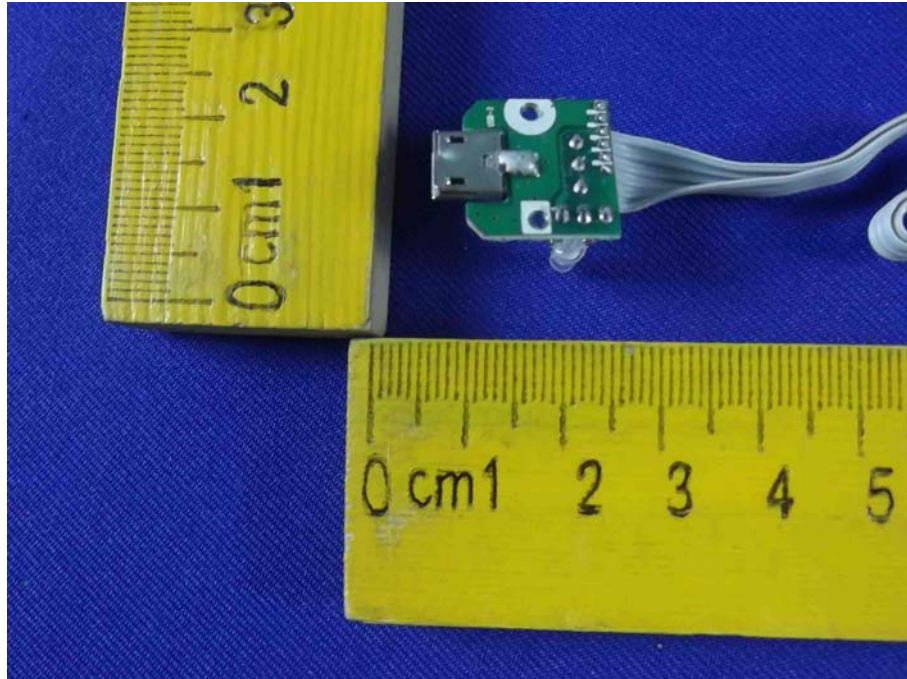

Figure 12
PCB of the EUT-Module View

