



# SGS North America, Inc. Test Report

Report No.: 208863  
SGS BOSS No.: 1412466

Date: June 12, 2024

Page 1 of 14

Manufacturer's Name: Otodata Wireless Network, Inc.

The following sample(s) was/were submitted and identified by/on-behalf of the client as a mobile terminal device.

Product Name	TM5040 Tank Monitor
Model Name	MT4ADS (Hardware C024 2R1)
Description	The TM5040 Tank Monitor is a battery-operated Wireless Remote Tank Level Monitor
Board S/N	Engineering Sample
Testing Start Date	06/05/2024
Testing End Date	06/05/2024
Test(s) Requested	Passive Antenna Performance

Signed for and on behalf of SGS North America, Inc.

Sergio Garcia  
Senior Engineer

Fred Jeong  
OTA Lab Manager

This document is issued by the Company subject to its General Conditions of Service printed overleaf, available on request or accessible at <http://www.sgs.com/en/Terms-and-Conditions/General-Conditions-of-Services-NorthAm.aspx> and, for electronic format documents, subject to Terms and Conditions for Electronic Documents at <http://www.sgs.com/en/Terms-and-Conditions/terms-e-document.aspx>. Attention is drawn to the limitation of liability, indemnification and jurisdiction issues defined therein. Any holder of this document is advised that information contained hereon reflects the Company's findings at the time of its intervention only and within the limits of Client's instructions, if any. The Company's sole responsibility is to its Client and this document does not exonerate parties to a transaction from exercising all their rights and obligations under the transaction documents. This document cannot be reproduced except in full, without prior written approval of the Company. Any unauthorized alteration, forgery or falsification of the content or appearance of this document is unlawful and offenders may be prosecuted to the fullest extent of the law. Unless otherwise stated, the results shown in this test report refer only to the sample(s) tested and such sample(s) are retained until the customer requests them to be shipped back or SGS contacts the customer for approval to return them.

# General Conditions of Service for North America

## 1. General

(a) Unless otherwise agreed in writing or except where they are at variance with (i) the regulations governing services performed on behalf of governments, government bodies or any other public entity or (ii) the mandatory provisions of local law, all offers or services and all resulting contractual relationship(s) between any of the affiliated companies of SGS North America Inc. or any of their agents (each a "Company") and Client (the "Contractual Relationship(s)") shall be governed by these general conditions of service (hereinafter the "General Conditions").

(b) The Company may perform services for persons or entities (private, public or governmental) issuing instructions (hereinafter, the "Client").

© Unless the Company receives prior written instructions to the contrary from Client, no other party is entitled to give instructions, particularly on the scope of the services or the delivery of reports or certificates resulting therefrom (the "Reports of Findings"). Client hereby irrevocably authorizes the Company to deliver Reports of Findings to a third party where so instructed by Client or, at its discretion, where it implicitly follows from circumstances, trade custom, usage or practice.

## 2. Provision of Services

(a) The Company will provide services using reasonable care and skill and in accordance with Client's specific instructions as confirmed by the Company or, in the absence of such instructions:

(1) the terms of any standard order form or standard specification sheet of the Company; and/or

(2) any relevant trade custom, usage or practice; and/or

(3) such methods as the Company shall consider appropriate on technical, operational and/or financial grounds.

(b) Information stated in Reports of Findings is derived from the results of inspection or testing procedures carried out in accordance with the instructions of Client, and/or our assessment of such results on the basis of any technical standards, trade custom or practice, or other circumstances which should in our professional opinion be taken into account.

© Reports of Findings issued further to the testing of samples contain the Company's opinion on those samples only and do not express any opinion upon the lot from which the samples were drawn.

(d) Should Client request that the Company witness any third party intervention, Client agrees that the Company's sole responsibility is to be present at the time of the third party's intervention and to forward the results, or confirm the occurrence, of the intervention. Client agrees that the Company is not responsible for the condition or calibration of apparatus, instruments and measuring devices used, the analysis methods applied, the qualifications, actions or omissions of third party personnel or the analysis results.

© Reports of Findings issued by the Company will reflect the facts as recorded by it at the time of its intervention only and within the limits of the instructions received or, in the absence of such instructions, within the limits of the alternative parameters applied as provided for in clause 2(a). The Company is under no obligation to refer to, or report upon, any facts or circumstances which are outside the specific instructions received or alternative parameters applied.

(f) The Company may delegate the performance of all or part of the services to an agent or subcontractor and Client authorizes the Company to disclose all information necessary for such performance to the agent or subcontractor.

(g) Should Company receive documents reflecting engagements contracted between Client and third parties or third party documents, such as copies of sale contracts, letters of credit, bills of lading, etc., they are considered to be for information only, and do not extend or restrict the scope of the services or the obligations accepted by the Company.

(h) Client acknowledges that the Company, by providing the services, neither takes the place of Client or any third party, nor releases them from any of their obligations, nor otherwise assumes, abridges, abrogates or undertakes to discharge any duty of Client to any third party or that of any third party to Client.

(i) All samples shall be retained for a maximum of 3 months or such other shorter time period as the nature of the sample permits and then returned to Client or otherwise disposed of at the Company's discretion after which time Company shall cease to have any responsibility for such samples. Storage of samples for more than 3 months shall incur a storage charge payable by Client. Client will be billed a handling and freight fee if samples are returned. Special disposal charges will be billed to Client if incurred.

## 3. Obligations of Client

The Client will:

(a) ensure that sufficient information, instructions and documents are given in due time (and, in any event not later than 48 hours prior to the desired intervention) to enable the required services to be performed;

(b) procure all necessary access for the Company's representatives to the premises where the services are to be performed and take all necessary steps to eliminate or remedy any obstacles to, or interruptions in, the performance of the services;

© supply, if required, any special equipment and personnel necessary for the performance of the services;

(d) ensure that all necessary measures are taken for safety and security of working conditions, sites and installations during the performance of services and will not rely, in this respect, on the Company's advice whether required or not;

© inform Company in advance of any known hazards or dangers, actual or potential, associated with any order or samples or testing including, for example, presence or risk of radiation, toxic or noxious or explosive elements or materials, environmental pollution or poisons;

(f) fully exercise all its rights and discharge all its liabilities under any relevant sales or other contract with a third party and at law.

## 4. Fees and Payment

(a) Fees not established between the Company and Client at the time the order is placed or a contract is negotiated shall be at the Company's standard rates (which are subject to change) and all applicable taxes shall be payable by Client.

(b) Unless a shorter period is established in the invoice, Client will promptly pay not later than 30 days from the relevant invoice date or within such other period as may be established by the Company in the invoice (the "Due Date") all fees due to the Company

failing which interest will become due at a rate of 1.5% per month (or such other rate as may be established in the invoice) from the Due Date up to and including the date payment is actually received.

© Client shall not be entitled to retain or defer payment of any sums due to the Company on account of any dispute, counter claim or set off which it may allege against the Company.

(d) Company may elect to bring action for the collection of unpaid fees in any court having competent jurisdiction.

© Client shall pay all of the Company's collection costs, including attorney's fees and related costs.

(f) In the event any unforeseen problems or expenses arise in the course of carrying out the services the Company shall authorize to inform Client and shall be entitled to charge additional fees to cover extra time and cost necessarily incurred to complete the services.

(g) If the Company is unable to perform all or part of the services for any cause whatsoever outside the Company's control including failure by Client to comply with any of its obligations provided for in clause 3 above the Company shall nevertheless be entitled to payment of:

(1) the amount of all non-refundable expenses incurred by the Company; and

(2) a proportion of the agreed fee equal to the proportion of the services actually carried out.

## 5. Suspension or Termination of Services

The Company shall be entitled to immediately and without liability either suspend or terminate provision of the services in the event of:

(a) failure by the Client to comply with any of its obligations hereunder and such failure is not remedied within 10 days that notice of such failure has been notified to Client; or

(b) any suspension of payment, arrangement with creditors, bankruptcy, insolvency, receivership or cessation of business by Client.

## 6. Liability and Indemnification

(a) Limitation of Liability:

(1) The Company is neither an insurer nor a guarantor and disclaims all liability in such capacity. Clients seeking a guarantee against loss or damage should obtain appropriate insurance.

(2) Reports of Findings are issued on the basis of information, documents and/or samples provided by, or on behalf of, Client and solely for the benefit of Client who is responsible for acting as it sees fit on the basis of such Reports of Findings. Neither the Company nor any of its officers, employees, agents or subcontractors shall be liable to Client nor any third party for any actions taken or not taken on the basis of such Reports of Findings nor for any incorrect results arising from unclear, erroneous, incomplete, misleading or false information provided to the Company.

(3) The Company shall not be liable for any delayed, partial or total non-performance of the services arising directly or indirectly from any event outside the Company's control including failure by Client to comply with any of its obligations hereunder.

(4) The liability of the Company in respect of any claim for loss, damage or expense of any nature and howsoever arising shall in no circumstances exceed a total aggregate sum equal to 10 times the amount of the fee paid in respect of the specific service which gives rise to such claim or US\$20,000 (or its equivalent in local currency), whichever is the lesser.

(5) The Company shall have no liability for any indirect or consequential loss including without limitation loss of profits, loss of business, loss of opportunity, loss of goodwill and cost of product recall. It shall further have no liability for any loss, damage or expense arising from the claims of any third party (including, without limitation, product liability claims) that may be incurred by the Client.

(6) In the event of any claim, Client must give written notice to the Company within 30 days of discovery of the facts alleged to justify such claim and, in any case, the Company shall be discharged from all liability for all claims for loss, damage or expense unless suit is brought within one year from:

(i) the date of performance by the Company of the service which gives rise to the claim; or

(ii) the date when the service should have been completed in the event of any alleged non-performance.

(b) Indemnification: Client shall guarantee, hold harmless and indemnify the Company and its officers, employees, agents or subcontractors against all claims (actual or threatened) by any third party for loss, damage or expense of whatsoever nature including all legal expenses and related costs and howsoever arising relating to the performance, purported performance or non-performance, of any services.

## 7. Miscellaneous

(a) If any one or more provisions of these General Conditions are found to be illegal or unenforceable in any respect, the validity, legality and enforceability of the remaining provisions shall not in any way be affected or impaired thereby.

(b) During the course of providing the services and for a period of one year thereafter Client shall not directly or indirectly entice, encourage or make any offer to Company's employees to leave their employment with the Company.

© Use of the Company's corporate name or registered marks for advertising purposes is not permitted without the Company's prior written authorization.

## 8. Governing Law, Jurisdiction and Dispute Resolution

Unless specifically agreed otherwise, all disputes arising out or in connection with Contractual Relationship(s) hereunder shall be governed by the substantive laws of the State of New Jersey exclusive of any rules with respect to conflicts of laws and be finally settled under the Rules of Arbitration of the International Chamber of Commerce by one or more arbitrators appointed in accordance with the said rules. The arbitration shall take place in Hackensack, New Jersey and be conducted in the English language.



# Antenna Performance Test Report

Document Control Number: 208863

Revision: 1.0

Date: 06/12/2024

Page | 4



## Antenna Performance Test Report

**Otodata Wireless Network, Inc.  
MT4ADS (Hardware C024 2R1)**

**S/N : N/A**

**2400 MHz ~ 2483.5 MHz**

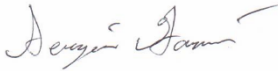
**SGS North America, Inc.  
12310 World Trade Drive, Suite 106/107,  
San Diego, 92128  
(858) 683-8034  
[www.sgs.com](http://www.sgs.com)**

	Name	Date
Prepared by:	Sergio Garcia SGS North America, Inc. Test Engineer	06/12/2024
Signature:		
Approved by:	Fred Jeong SGS North America, Inc. Lab Manager	06/12/2024
Signature:		

Report No.	Revision	Date	Description
208863	1.0	06/12/2024	Initial Release

	<b>Antenna Performance Test Report</b>		
<b>Document Control Number: 208863</b>	Revision: 1.0	Date: 06/12/2024	Page   5

## Table of Contents

- 1) Measurement System Information .....6
  - 1.1 General Information.....6
    - 1.1.1 Testing Condition .....6
    - 1.1.2 Measurement Facility .....6
  - 1.2 List of Equipment .....7
- 2) Report Affirmation .....7
- 3) Summation Test Report.....8
- 4) Summation Test Report 3D Plot Matrix.....10
  - 4.1 2400 MHz.....10
  - 4.2 2450 MHz.....11
  - 4.3 2483.5 MHz.....12
- 5) Device Setup Configuration .....13
  - 5.1 Measurement Setup .....13
  - 5.2 Coordinate System.....13

This document is issued by the Company subject to its General Conditions of Service printed overleaf, available on request or accessible at <http://www.sgs.com/en/Terms-and-Conditions/General-Conditions-of-Services-NorthAm.aspx> and, for electronic format documents, subject to Terms and Conditions for Electronic Documents at <http://www.sgs.com/en/Terms-and-Conditions/terms-e-document.aspx>. Attention is drawn to the limitation of liability, indemnification and jurisdiction issues defined therein. Any holder of this document is advised that information contained hereon reflects the Company’s findings at the time of its intervention only and within the limits of Client’s instructions, if any. The Company’s sole responsibility is to its Client and this document does not exonerate parties to a transaction from exercising all their rights and obligations under the transaction documents. This document cannot be reproduced except in full, without prior written approval of the Company. Any unauthorized alteration, forgery or falsification of the content or appearance of this document is unlawful and offenders may be prosecuted to the fullest extent of the law. Unless otherwise stated, the results shown in this test report refer only to the sample(s) tested and such sample(s) are retained until the customer requests them to be shipped back or SGS contacts the customer for approval to return them.

## 1) Measurement System Information

### 1.1 General Information

Rohde & Schwarz (R&S) TS8991 Antenna Measurement System includes two measurement probe broadband Horn Antennas. These measurement antennas are designed with characteristics of dual linear polarization. Together, these antennas support testing between 600 MHz and 6 GHz.

An integrated laser alignment system assists with DUT positioning. With a switch control unit integrated on the system, the test system provides fast switching between each polarization of antennas for high speed testing. Its centralized system configuration supports easy maintenance and superior reliability.

#### 1.1.1 Testing Condition

- Temperature :  $(23 \pm 5) ^\circ\text{C}$
- Relative humidity :  $< 60\% \text{ R.H.}$

#### 1.1.2 Measurement Facility

Measurement Chamber : R&S 3D fully anechoic chamber and its measuring system (TS8991)

Base Station Simulator : R&S CMW500

Dual Sensor Power Meter : R&S NRP2

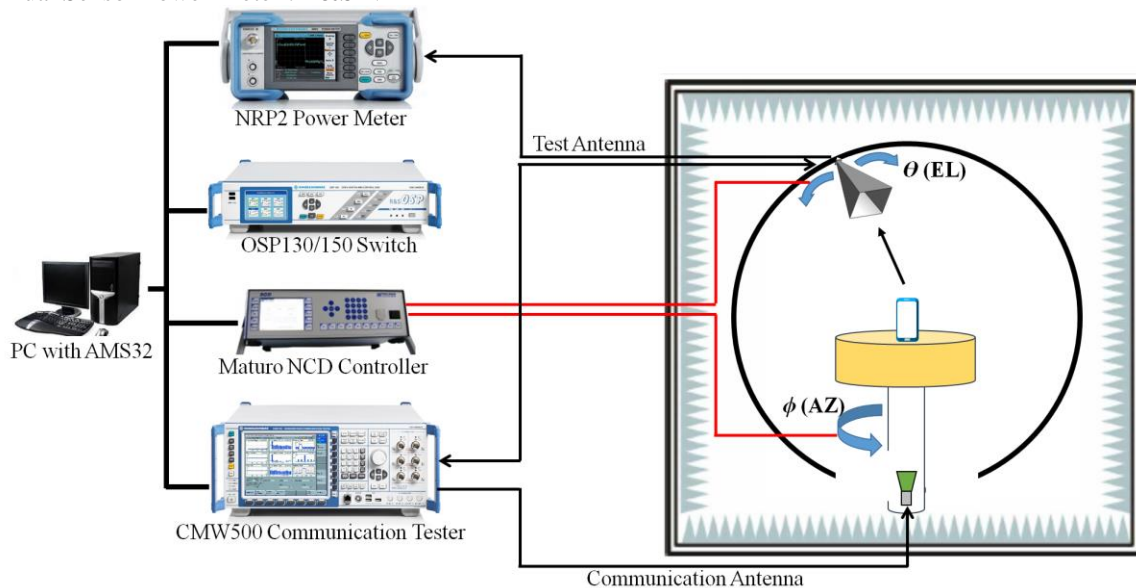

Measurements are performed in a R&S TS8991 3D fully anechoic test system.

The test system includes a high-performance RF-shielded, rectangular anechoic chamber, Multi-axis Positioning Controller (NCD), and AMS32 data acquisition and analysis software. The geometry of the setup is specified below for reference.

This document is issued by the Company subject to its General Conditions of Service printed overleaf, available on request or accessible at <http://www.sgs.com/en/Terms-and-Conditions/General-Conditions-of-Services-NorthAm.aspx> and, for electronic format documents, subject to Terms and Conditions for Electronic Documents at <http://www.sgs.com/en/Terms-and-Conditions/terms-e-document.aspx>. Attention is drawn to the limitation of liability, indemnification and jurisdiction issues defined therein. Any holder of this document is advised that information contained hereon reflects the Company's findings at the time of its intervention only and within the limits of Client's instructions, if any. The Company's sole responsibility is to its Client and this document does not exonerate parties to a transaction from exercising all their rights and obligations under the transaction documents. This document cannot be reproduced except in full, without prior written approval of the Company. Any unauthorized alteration, forgery or falsification of the content or appearance of this document is unlawful and offenders may be prosecuted to the fullest extent of the law. Unless otherwise stated, the results shown in this test report refer only to the sample(s) tested and such sample(s) are retained until the customer requests them to be shipped back or SGS contacts the customer for approval to return them.



## Antenna Performance Test Report

Document Control Number: 208863

Revision: 1.0

Date: 06/12/2024

Page | 7

### 1.2 List of Equipment

Equipment Description	Manufacturer / Model	Serial no.	Calibration due date
Network Analyzer	Rohde & Schwarz ZNB 8	MY46418102	2026.02.16
New Control Device Controller	Maturo Controller NCD/135	14510714	N/A
Humidity Recorder	Practical Design THUM	T-6704-1444-A	2024.12.21
AMS-32	Rohde & Schwarz	11-40-00A101447	N/A

### 2) Report Affirmation

The results in this report relate only to the items tested and referenced by SGS North America, Inc.

This document is issued by the Company subject to its General Conditions of Service printed overleaf, available on request or accessible at <http://www.sgs.com/en/Terms-and-Conditions/General-Conditions-of-Services-NorthAm.aspx> and, for electronic format documents, subject to Terms and Conditions for Electronic Documents at <http://www.sgs.com/en/Terms-and-Conditions/terms-e-document.aspx>. Attention is drawn to the limitation of liability, indemnification and jurisdiction issues defined therein. Any holder of this document is advised that information contained hereon reflects the Company's findings at the time of its intervention only and within the limits of Client's instructions, if any. The Company's sole responsibility is to its Client and this document does not exonerate parties to a transaction from exercising all their rights and obligations under the transaction documents. This document cannot be reproduced except in full, without prior written approval of the Company. Any unauthorized alteration, forgery or falsification of the content or appearance of this document is unlawful and offenders may be prosecuted to the fullest extent of the law. Unless otherwise stated, the results shown in this test report refer only to the sample(s) tested and such sample(s) are retained until the customer requests them to be shipped back or SGS contacts the customer for approval to return them.



## Antenna Performance Test Report

Document Control Number: 208863

Revision: 1.0

Date: 06/12/2024

Page | 8

### 3) Summation Test Report

Frequency (MHz)	Peak EIRP (dBm)	Efficiency (dB)	Efficiency (%)	Peak Gain (dB)	Peak Gain Pos.
2400	2.73	-2.68	53.92	2.73	Azi=60; Elev=150
2402	2.93	-2.64	54.44	2.93	Azi=60; Elev=150
2404	2.85	-2.57	55.33	2.85	Azi=60; Elev=150
2406	2.95	-2.52	55.92	2.95	Azi=60; Elev=150
2408	3.16	-2.51	56.12	3.16	Azi=60; Elev=150
2410	2.90	-2.55	55.65	2.90	Azi=60; Elev=150
2412	2.92	-2.53	55.82	2.92	Azi=45; Elev=150
2414	2.84	-2.61	54.86	2.84	Azi=60; Elev=150
2416	2.74	-2.57	55.35	2.74	Azi=60; Elev=150
2418	2.87	-2.60	55.00	2.87	Azi=60; Elev=150
2420	2.65	-2.61	54.84	2.65	Azi=60; Elev=150
2422	2.78	-2.62	54.71	2.78	Azi=60; Elev=150
2424	2.68	-2.62	54.67	2.68	Azi=45; Elev=150
2426	2.76	-2.61	54.85	2.76	Azi=60; Elev=150
2428	2.97	-2.60	55.00	2.97	Azi=60; Elev=150
2430	2.60	-2.62	54.65	2.60	Azi=60; Elev=150
2432	2.77	-2.63	54.59	2.77	Azi=60; Elev=150
2434	2.76	-2.60	54.98	2.76	Azi=60; Elev=150
2436	3.01	-2.59	55.13	3.01	Azi=60; Elev=150
2438	2.72	-2.57	55.30	2.72	Azi=60; Elev=150
2440	2.83	-2.56	55.41	2.83	Azi=60; Elev=150
2442	3.04	-2.60	55.01	3.04	Azi=60; Elev=150
2444	3.03	-2.61	54.87	3.03	Azi=60; Elev=150
2446	2.88	-2.62	54.75	2.88	Azi=60; Elev=150
2448	2.92	-2.63	54.54	2.92	Azi=60; Elev=150

This document is issued by the Company subject to its General Conditions of Service printed overleaf, available on request or accessible at <http://www.sgs.com/en/Terms-and-Conditions/General-Conditions-of-Services-NorthAm.aspx> and, for electronic format documents, subject to Terms and Conditions for Electronic Documents at <http://www.sgs.com/en/Terms-and-Conditions/terms-e-document.aspx>. Attention is drawn to the limitation of liability, indemnification and jurisdiction issues defined therein. Any holder of this document is advised that information contained hereon reflects the Company's findings at the time of its intervention only and within the limits of Client's instructions, if any. The Company's sole responsibility is to its Client and this document does not exonerate parties to a transaction from exercising all their rights and obligations under the transaction documents. This document cannot be reproduced except in full, without prior written approval of the Company. Any unauthorized alteration, forgery or falsification of the content or appearance of this document is unlawful and offenders may be prosecuted to the fullest extent of the law. Unless otherwise stated, the results shown in this test report refer only to the sample(s) tested and such sample(s) are retained until the customer requests them to be shipped back or SGS contacts the customer for approval to return them.





## Antenna Performance Test Report

Document Control Number: 208863

Revision: 1.0

Date: 06/12/2024

Page | 9

Frequency (MHz)	Peak EIRP (dBm)	Efficiency (dB)	Efficiency (%)	Peak Gain (dB)	Peak Gain Pos.
2450	3.05	-2.55	55.58	3.05	Azi=60; Elev=150
2452	3.02	-2.55	55.59	3.02	Azi=60; Elev=150
2454	2.91	-2.45	56.87	2.91	Azi=60; Elev=150
2456	2.88	-2.48	56.52	2.88	Azi=60; Elev=150
2458	2.85	-2.47	56.64	2.85	Azi=60; Elev=150
2460	2.73	-2.44	56.99	2.73	Azi=60; Elev=150
2462	2.84	-2.51	56.06	2.84	Azi=60; Elev=150
2464	2.83	-2.52	55.94	2.83	Azi=60; Elev=150
2466	2.91	-2.54	55.77	2.91	Azi=60; Elev=150
2468	2.61	-2.50	56.28	2.61	Azi=60; Elev=150
2470	2.66	-2.48	56.46	2.66	Azi=60; Elev=150
2472	2.73	-2.42	57.25	2.73	Azi=60; Elev=150
2474	2.81	-2.42	57.33	2.81	Azi=60; Elev=150
2476	2.80	-2.40	57.50	2.80	Azi=60; Elev=150
2478	2.62	-2.41	57.43	2.62	Azi=60; Elev=150
2480	2.61	-2.42	57.34	2.61	Azi=60; Elev=150
2482	2.72	-2.41	57.36	2.72	Azi=60; Elev=150
2483.5	2.66	-2.41	57.36	2.66	Azi=60; Elev=150

This document is issued by the Company subject to its General Conditions of Service printed overleaf, available on request or accessible at <http://www.sgs.com/en/Terms-and-Conditions/General-Conditions-of-Services-NorthAm.aspx> and, for electronic format documents, subject to Terms and Conditions for Electronic Documents at <http://www.sgs.com/en/Terms-and-Conditions/terms-e-document.aspx>. Attention is drawn to the limitation of liability, indemnification and jurisdiction issues defined therein. Any holder of this document is advised that information contained hereon reflects the Company's findings at the time of its intervention only and within the limits of Client's instructions, if any. The Company's sole responsibility is to its Client and this document does not exonerate parties to a transaction from exercising all their rights and obligations under the transaction documents. This document cannot be reproduced except in full, without prior written approval of the Company. Any unauthorized alteration, forgery or falsification of the content or appearance of this document is unlawful and offenders may be prosecuted to the fullest extent of the law. Unless otherwise stated, the results shown in this test report refer only to the sample(s) tested and such sample(s) are retained until the customer requests them to be shipped back or SGS contacts the customer for approval to return them.

## 4) Summation Test Report 3D Plot Matrix

### 4.1 2400 MHz

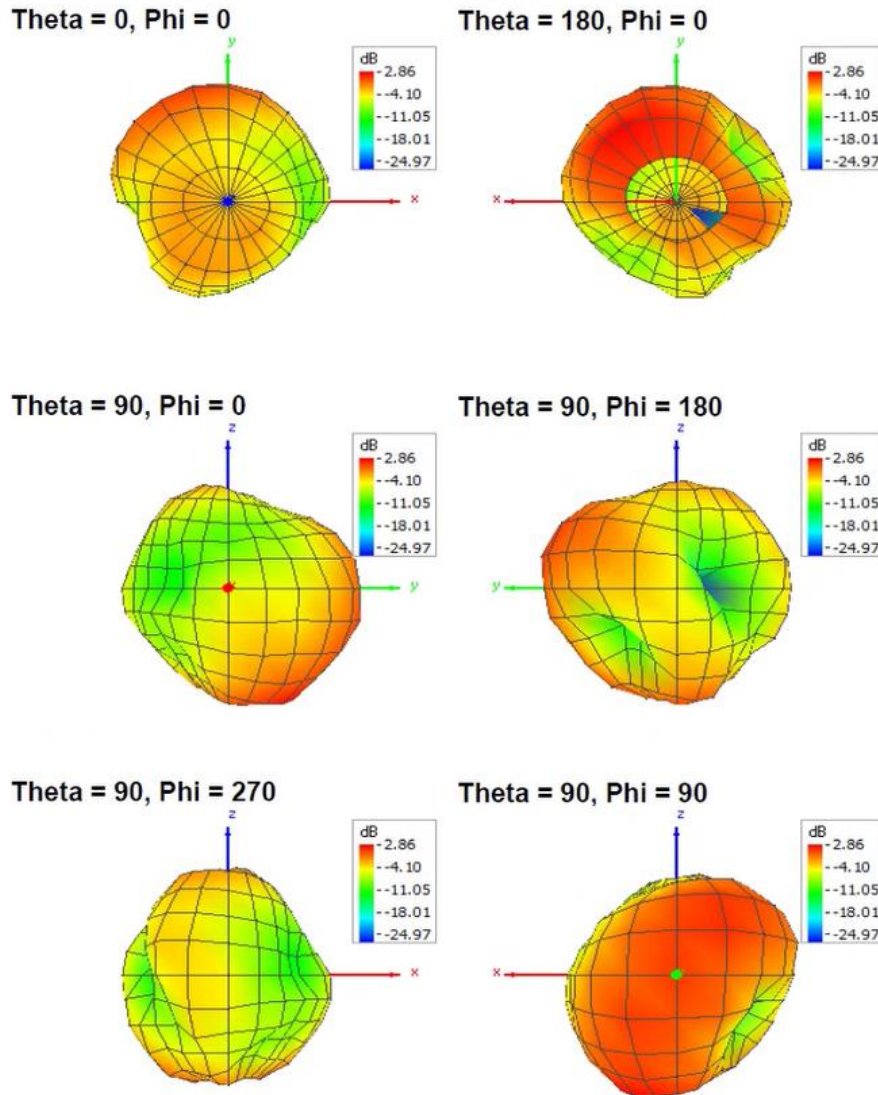

This document is issued by the Company subject to its General Conditions of Service printed overleaf, available on request or accessible at <http://www.sgs.com/en/Terms-and-Conditions/General-Conditions-of-Services-NorthAm.aspx> and, for electronic format documents, subject to Terms and Conditions for Electronic Documents at <http://www.sgs.com/en/Terms-and-Conditions/terms-e-document.aspx>. Attention is drawn to the limitation of liability, indemnification and jurisdiction issues defined therein. Any holder of this document is advised that information contained hereon reflects the Company's findings at the time of its intervention only and within the limits of Client's instructions, if any. The Company's sole responsibility is to its Client and this document does not exonerate parties to a transaction from exercising all their rights and obligations under the transaction documents. This document cannot be reproduced except in full, without prior written approval of the Company. Any unauthorized alteration, forgery or falsification of the content or appearance of this document is unlawful and offenders may be prosecuted to the fullest extent of the law. Unless otherwise stated, the results shown in this test report refer only to the sample(s) tested and such sample(s) are retained until the customer requests them to be shipped back or SGS contacts the customer for approval to return them.

## 4.2 2450 MHz

Theta = 0, Phi = 0

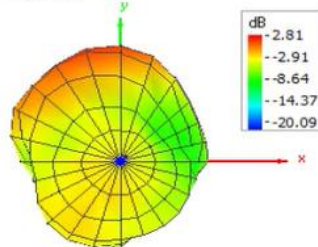

Theta = 180, Phi = 0

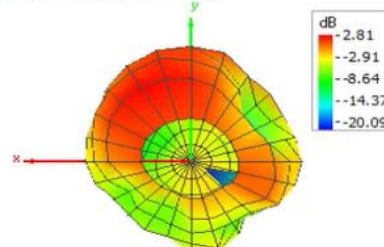

Theta = 90, Phi = 0

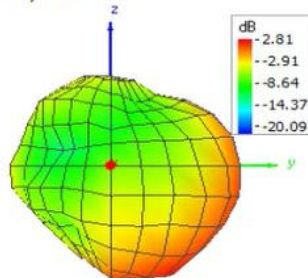

Theta = 90, Phi = 180

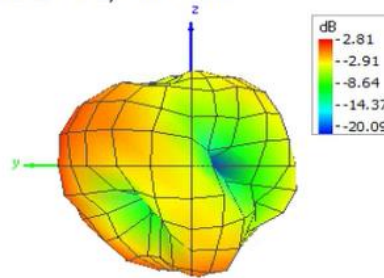

Theta = 90, Phi = 270

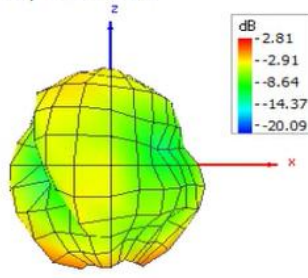

Theta = 90, Phi = 90

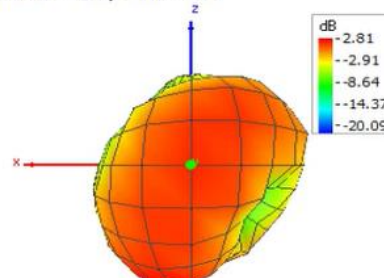

This document is issued by the Company subject to its General Conditions of Service printed overleaf, available on request or accessible at <http://www.sgs.com/en/Terms-and-Conditions/General-Conditions-of-Services-NorthAm.aspx> and, for electronic format documents, subject to Terms and Conditions for Electronic Documents at <http://www.sgs.com/en/Terms-and-Conditions/terms-e-document.aspx>. Attention is drawn to the limitation of liability, indemnification and jurisdiction issues defined therein. Any holder of this document is advised that information contained hereon reflects the Company's findings at the time of its intervention only and within the limits of Client's instructions, if any. The Company's sole responsibility is to its Client and this document does not exonerate parties to a transaction from exercising all their rights and obligations under the transaction documents. This document cannot be reproduced except in full, without prior written approval of the Company. Any unauthorized alteration, forgery or falsification of the content or appearance of this document is unlawful and offenders may be prosecuted to the fullest extent of the law. Unless otherwise stated, the results shown in this test report refer only to the sample(s) tested and such sample(s) are retained until the customer requests them to be shipped back or SGS contacts the customer for approval to return them.

## 4.3 2483.5 MHz

Theta = 0, Phi = 0

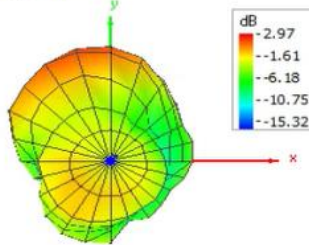

Theta = 180, Phi = 0

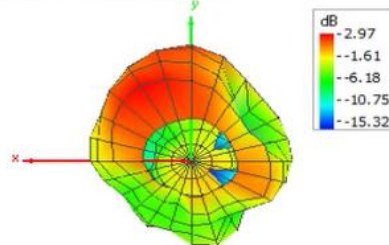

Theta = 90, Phi = 0

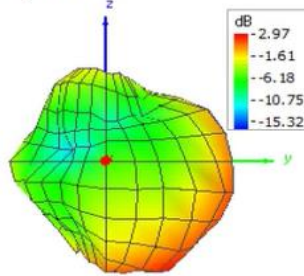

Theta = 90, Phi = 180

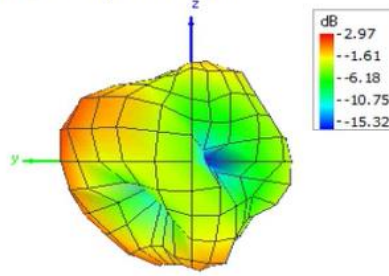

Theta = 90, Phi = 270

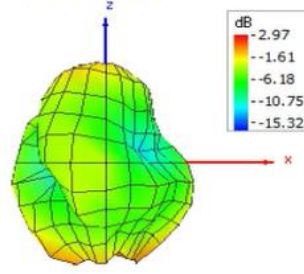

Theta = 90, Phi = 90

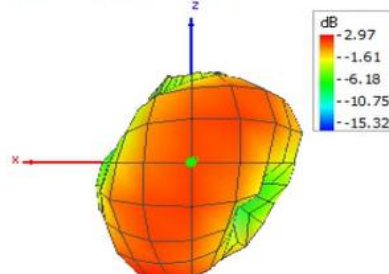

This document is issued by the Company subject to its General Conditions of Service printed overleaf, available on request or accessible at <http://www.sgs.com/en/Terms-and-Conditions/General-Conditions-of-Services-NorthAm.aspx> and, for electronic format documents, subject to Terms and Conditions for Electronic Documents at <http://www.sgs.com/en/Terms-and-Conditions/terms-e-document.aspx>. Attention is drawn to the limitation of liability, indemnification and jurisdiction issues defined therein. Any holder of this document is advised that information contained hereon reflects the Company's findings at the time of its intervention only and within the limits of Client's instructions, if any. The Company's sole responsibility is to its Client and this document does not exonerate parties to a transaction from exercising all their rights and obligations under the transaction documents. This document cannot be reproduced except in full, without prior written approval of the Company. Any unauthorized alteration, forgery or falsification of the content or appearance of this document is unlawful and offenders may be prosecuted to the fullest extent of the law. Unless otherwise stated, the results shown in this test report refer only to the sample(s) tested and such sample(s) are retained until the customer requests them to be shipped back or SGS contacts the customer for approval to return them.

## 5) Device Setup Configuration

### 5.1 Measurement Setup

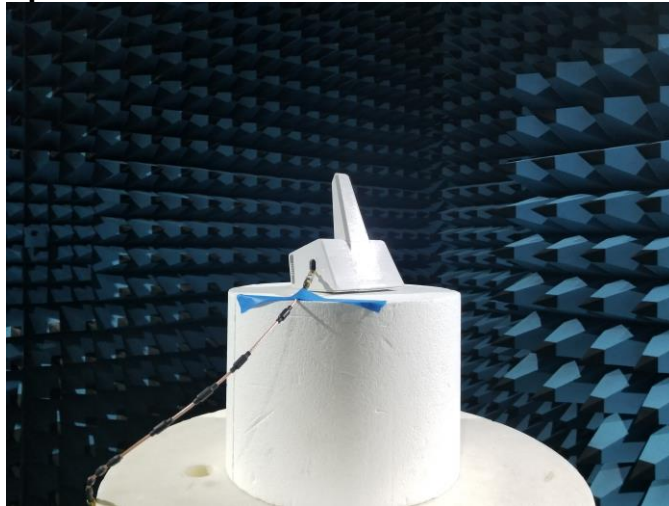

The EUT was placed on top of the Styrofoam mast in a holding fixture at the 0° position.

### 5.2 Coordinate System

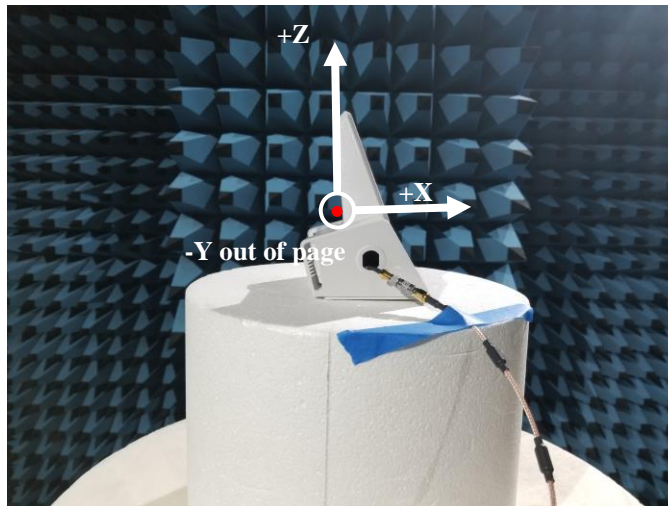

The coordinate system is centered on the DUT, with the +X-axis pointing front side of the DUT, the +Y-axis pointing right side of the DUT, and the +Z-axis pointing top side of the DUT.

This document is issued by the Company subject to its General Conditions of Service printed overleaf, available on request or accessible at <http://www.sgs.com/en/Terms-and-Conditions/General-Conditions-of-Services-NorthAm.aspx> and, for electronic format documents, subject to Terms and Conditions for Electronic Documents at <http://www.sgs.com/en/Terms-and-Conditions/terms-e-document.aspx>. Attention is drawn to the limitation of liability, indemnification and jurisdiction issues defined therein. Any holder of this document is advised that information contained hereon reflects the Company's findings at the time of its intervention only and within the limits of Client's instructions, if any. The Company's sole responsibility is to its Client and this document does not exonerate parties to a transaction from exercising all their rights and obligations under the transaction documents. This document cannot be reproduced except in full, without prior written approval of the Company. Any unauthorized alteration, forgery or falsification of the content or appearance of this document is unlawful and offenders may be prosecuted to the fullest extent of the law. Unless otherwise stated, the results shown in this test report refer only to the sample(s) tested and such sample(s) are retained until the customer requests them to be shipped back or SGS contacts the customer for approval to return them.





## Antenna Performance Test Report

Document Control Number: 208863

Revision: 1.0

Date: 06/12/2024

Page | 14

# End of Document

This document is issued by the Company subject to its General Conditions of Service printed overleaf, available on request or accessible at <http://www.sgs.com/en/Terms-and-Conditions/General-Conditions-of-Services-NorthAm.aspx> and, for electronic format documents, subject to Terms and Conditions for Electronic Documents at <http://www.sgs.com/en/Terms-and-Conditions/terms-e-document.aspx>. Attention is drawn to the limitation of liability, indemnification and jurisdiction issues defined therein. Any holder of this document is advised that information contained hereon reflects the Company's findings at the time of its intervention only and within the limits of Client's instructions, if any. The Company's sole responsibility is to its Client and this document does not exonerate parties to a transaction from exercising all their rights and obligations under the transaction documents. This document cannot be reproduced except in full, without prior written approval of the Company. Any unauthorized alteration, forgery or falsification of the content or appearance of this document is unlawful and offenders may be prosecuted to the fullest extent of the law. Unless otherwise stated, the results shown in this test report refer only to the sample(s) tested and such sample(s) are retained until the customer requests them to be shipped back or SGS contacts the customer for approval to return them.