



### FCC PART 15 SUBPART C TEST REPORT

#### Part 15.247

Report Reference No.....: **CTL1410302624-WF**

Compiled by

( position+printed name+signature) .: File administrators Jacky Chen

Name of the organization performing the tests

Test Engineer Tracy Qi

( position+printed name+signature) .:

Approved by

( position+printed name+signature) .: Manager Tracy Qi

Date of issue.....: Nov. 24, 2014

Test Laboratory Name .....: **Shenzhen CTL Testing Technology Co., Ltd.**

Address .....: Floor 1-A, Baisha Technology Park, No.3011, Shaheji Road, Nanshan District, Shenzhen, China 518055

Applicant's name.....: **Hamedata Technology Co., Limited**

Address .....: 1<sup>st</sup> Zone, 3F, Plant#1, Huahan Industrial Park, No.16, Jinniu West Rd., Pingshan New District, Shenzhen518118, China

#### Test specification:

Standard .....: FCC Part 15.247: Operation within the bands 902–928 MHz, 2400–2483.5 MHz, and 5725–5850 MHz.

TRF Originator.....: Shenzhen CTL Testing Technology Co., Ltd.

Master TRF.....: Dated 2011-01

#### Shenzhen CTL Testing Technology Co., Ltd. All rights reserved.

This publication may be reproduced in whole or in part for non-commercial purposes as long as the Shenzhen CTL Testing Technology Co., Ltd. is acknowledged as copyright owner and source of the material. Shenzhen CTL Testing Technology Co., Ltd. takes no responsibility for and will not assume liability for damages resulting from the reader's interpretation of the reproduced material due to its placement and context.

Test item description .....: **WIFI-Speaker**

FCC ID.....: **2ADOW-WM3**

Trade Mark .....



Model/Type reference .....: WM3, WM1, WM2, WM1S, WM2S, WM3S, WM4, W5, WM6, WM7, WM8, WM9, WM4S, WM5S, WM6S, WM7S, WM8S, WM9S, WU01X, WU02X, WU03X, WU04X, WU05X

Modulation .....: 802.11b DSSS, 802.11g/n: OFDM

Work Frequency Range .....: 802.11b/g/n(20MHz): 2412~2462MHz  
802.11n(40MHz): 2422~2452

Antenna Type .....: Undetachable

Antenna Gain.....: 1.0dBi

Result .....: **Positivec**

## TEST REPORT

<b>Test Report No. :</b> CTL1410302624-WF	Nov. 24, 2014 Date of issue
---	--------------------------------

Equipment under Test : WIFI-Speaker

Model /Type : WM3

Listed Modes : WM1, WM2, WM1S, WM2S, WM3S, WM4, W5, WM6, WM7, WM8, WM9, WM4S, WM5S, WM6S, WM7S, WM8S, WM9S, WU01X, WU02X, WU03X, WU04X, WU05X

Difference Description : Only the color and model's name is different

**Applicant** : **Hamedata Technology Co., Limited**

Address : 1<sup>st</sup> Zone, 3F, Plant#1, Huahan Industrial Park, No.16, Jinniu West Rd., Pingshan New District, Shenzhen518118, China

**Manufacturer** : **Hamedata Technology Co., Limited**

Address : 1<sup>st</sup> Zone, 3F, Plant#1, Huahan Industrial Park, No.16, Jinniu West Rd., Pingshan New District, Shenzhen518118, China

<b>Test Result</b> according to the standards on page 4:	<b>Positive</b>
--	-----------------

The test report merely corresponds to the test sample.  
It is not permitted to copy extracts of these test result without the written permission of the test laboratory.

## Contents

<b>1.</b>	<b><u>TEST STANDARDS.....</u></b>	<b>4</b>
<b>2.</b>	<b><u>SUMMARY .....</u></b>	<b>5</b>
2.1.	General Remarks	5
2.2.	Equipment Under Test	5
2.3.	Short description of the Equipment under Test (EUT)	5
2.4.	EUT operation mode	6
2.5.	EUT configuration	6
2.6.	NOTE	6
2.7.	Related Submittal(s) / Grant (s)	7
2.8.	Modifications	7
<b>3.</b>	<b><u>TEST ENVIRONMENT .....</u></b>	<b>8</b>
3.1.	Address of the test laboratory	8
3.2.	Test Facility	8
3.3.	Environmental conditions	8
3.4.	Configuration of Tested System	8
3.5.	Duty Cycle	9
3.6.	Statement of the measurement uncertainty	9
3.7.	Equipments Used during the Test	10
3.8.	Summary of Test Result	11
<b>4.</b>	<b><u>TEST CONDITIONS AND RESULTS.....</u></b>	<b>12</b>
4.1.	Conducted Emissions Test	12
4.2.	Radiated Emission Test	15
4.3.	6dB Bandwidth Measurement	23
4.4.	Maximum Peak Output Power	32
4.5.	Band Edge Measurement	33
4.6.	Power Spectral Density Measurement	66
4.7.	Spurious RF Conducted Emission	75
4.8.	Antenna Requirement	99
<b>5.</b>	<b><u>TEST SETUP PHOTOS OF THE EUT .....</u></b>	<b>100</b>
<b>6.</b>	<b><u>EXTERNAL AND INTERNAL PHOTOS OF THE EUT .....</u></b>	<b>102</b>

## 1. TEST STANDARDS

The tests were performed according to following standards:

[FCC Part 15.247](#): Frequency Hopping, Direct Spread Spectrum and Hybrid Systems that are in operation within the bands of 902-928 MHz, 2400-2483.5 MHz, and 5725-5850 MHz.

[ANSI C63.10-2009](#): American National Standard for Testing Unlicensed Wireless Devices.

[ANSI C63.4-2009](#)

[KDB Publication No. 558074 D01 v03r02 Guidance on Measurements for Digital Transmission Systems](#)



## 2. SUMMARY

### 2.1. General Remarks

Date of receipt of test sample	:	Nov. 03, 2014
Testing commenced on	:	Nov. 03, 2014
Testing concluded on	:	Nov. 24, 2014

### 2.2. Equipment Under Test

#### Power supply system utilised

Power supply voltage	:	<input checked="" type="radio"/> 120V / 60 Hz	<input type="radio"/> 115V / 60Hz
		<input type="radio"/> 12 V DC	<input type="radio"/> 24 V DC
		<input type="radio"/> Other (specified in blank below)	

#### Description of the test mode

IEEE 802.11b/g/n(HT20): Thirteen channels are provided to the EUT, but only eleventh channels used for USA and Canada.

Channel	Frequency(MHz)	Channel	Frequency(MHz)
1	2412	8	2447
2	2417	9	2452
3	2422	10	2457
4	2427	11	2462
5	2432		
6	2437		
7	2442		

IEEE 802.11n (HT40)

Channel	Frequency(MHz)	Channel	Frequency(MHz)
3	2422	8	2447
4	2427	9	2452
5	2432		
6	2437		
7	2442		

### 2.3. Short description of the Equipment under Test (EUT)

**WIFI-Speaker**, support 802.11b/g/n.

For more details, refer to the user's manual of the EUT.

Serial number: Prototype

### 2.4. EUT operation mode

Test Mode:

1. The EUT has been tested under normal operating condition.
2. Test program used to control the EUT for staying in continuous transmitting and receiving mode is programmed. Channel low (2412MHz), mid (2437MHz) and high (2462MHz) for 802.11b/g/n(HT20) and Channel low (2422MHz), mid (2437MHz) and high (2452MHz) for 802.11 n HT40 with highest data rate are chosen for full testing.
3. Test Mode:

Test Mode(TM)	Description	Remark
1	Transmitting	802.11 b 2412MHz, 2437MHz, 2462MHz
2	Transmitting	802.11 g 2412MHz, 2437MHz, 2462MHz
3	Transmitting	802.11 n HT20 2412MHz, 2437MHz, 2462MHz
4	Transmitting	802.11 n HT40 2422MHz, 2437MHz, 2452MHz

### 2.5. EUT configuration

The following peripheral devices and interface cables were connected during the measurement:

- supplied by the manufacturer
- supplied by the lab
- AC adapter
- Notebook PC

Manufacturer : Hamedata  
Model No. : SK03G-1800200W3  
Manufacturer : DELL  
Model No. : PP18L

### 2.6. NOTE

1. The EUT is a **WIFI-Speaker**,The functions of the EUT listed as below:

	Test Standards	Reference Report
WLAN 802.11b/g, 802.11n	FCC Part 15 Subpart C (Section15.247)	CTL1410302624-WF
	FCC Per 47 CFR 2.1091(b)	CTL1410302624-WM

2. The frequency bands used in this EUT are listed as follows:

Frequency Band(MHz)	2400-2483.5	5150-5350	5470-5725	5725-5850
802.11b	√	—	—	—
802.11g	√	—	—	—
802.11n(20MHz)	√	—	—	—
802.11n(40MHz)	√	—	—	—

3. The EUT incorporates a MIMO function,Physically,the EUT provides two completed transmitter and two completed receivers.

Modulation Mode	TX Function
802.11b	1TX
802.11g	1TX
802.11n (20MHz)	2TX
802.11n (40MHz)	2TX

## 2.7. Related Submittal(s) / Grant (s)

This submittal(s) (test report) is intended for FCCID: 2ADOW-WM3 filing to comply with of the FCC part15.247 Rules.

## 2.8. Modifications

No modifications were implemented to meet testing criteria.



### 3. TEST ENVIRONMENT

#### 3.1. Address of the test laboratory

Shenzhen CTL Testing Technology Co., Ltd.  
 Floor 1-A, Baisha Technology Park, No.3011, Shahexi Road, Nanshan District, Shenzhen, China 518055

The sites are constructed in conformance with the requirements of ANSI C6230, ANSI C63.4 (2009) and CISPR Publication 22.

#### 3.2. Test Facility

The test facility is recognized, certified, or accredited by the following organizations:

##### IC Registration No.: 9618B

The 3m alternate test site of Shenzhen CTL Testing Technology Co., Ltd. EMC Laboratory has been registered by Certification and Engineer Bureau of Industry Canada for the performance of with Registration No.: 9618B on November 13, 2013.

##### FCC-Registration No.: 970318

Shenzhen CTL Testing Technology Co., Ltd. EMC Laboratory has been registered and fully described in a report filed with the (FCC) Federal Communications Commission. The acceptance letter from the FCC is maintained in our files. Registration 970318, December 19, 2013.

#### 3.3. Environmental conditions

During the measurement the environmental conditions were within the listed ranges:

Temperature:	<u>15-35 ° C</u>
Humidity:	<u>30-60 %</u>
Atmospheric pressure:	<u>950-1050mbar</u>

#### 3.4. Configuration of Tested System

Fig. 2-1 Configuration of Tested System

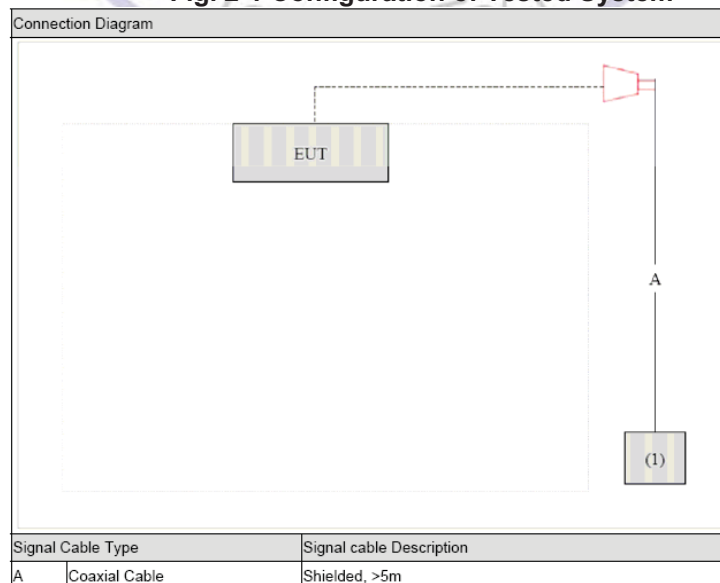



### 3.5. Duty Cycle

Operated Mode for Worst Duty Cycle		
<input type="checkbox"/>	Operated normally mode for worst duty cycle	
<input checked="" type="checkbox"/>	Operated test mode for worst duty cycle	
Mode	Duty Cycle (%)	Duty Factor (dB)
11b	100	0
11g	100	0
11n HT20	100	0
11n HT40	100	0

### 3.6. Statement of the measurement uncertainty

The data and results referenced in this document are true and accurate. The reader is cautioned that there may be errors within the calibration limits of the equipment and facilities. The measurement uncertainty was calculated for all measurements listed in this test report acc. to CISPR 16 - 4 „Specification for radio disturbance and immunity measuring apparatus and methods – Part 4: Uncertainty in EMC Measurements“ and is documented in the Shenzhen CTL Testing Technology Co., Ltd. quality system acc. to DIN EN ISO/IEC 17025. Furthermore, component and process variability of devices similar to that tested may result in additional deviation. The manufacturer has the sole responsibility of continued compliance of the device.

Hereafter the best measurement capability for CTL laboratory is reported:

Test	Range	Measurement Uncertainty	Notes
Radiated Emission	30~1000MHz	4.10dB	(1)
Radiated Emission	1~12.75GHz	4.32dB	(1)
Radiated Emission	12.75GHz-25 GHz	4.68dB	(1)
Conducted Disturbance	0.15~30MHz	3.20dB	(1)

- (1) This uncertainty represents an expanded uncertainty expressed at approximately the 95% confidence level using a coverage factor of k=2.

### 3.7. Equipments Used during the Test

Test Equipment	Manufacturer	Model No.	Serial No.	Calibration Date	Calibration Due Date
Bilog Antenna	Sunol Sciences Corp.	JB1	A061713	2014/07/12	2015/07/11
EMI Test Receiver	R&S	ESCI	103710	2014/07/10	2015/07/09
Spectrum Analyzer	Agilent	E4407B	MY45108355	2014/07/06	2015/07/05
Controller	EM Electronics	Controller EM 1000	N/A	2014/07/06	2015/07/05
Horn Antenna	Sunol Sciences Corp.	DRH-118	A062013	2014/07/12	2015/07/11
Horn Antenna	SCHWARZBECK	BBHA9170	1562	2014/07/12	2015/07/11
Active Loop Antenna	SCHWARZBECK	FMZB1519	1519-037	2014/07/12	2015/07/11
LISN	R&S	ENV216	101316	2014/07/10	2015/07/09
LISN	SCHWARZBECK	NSLK8127	8127687	2014/07/10	2015/07/09
Microwave Preamplifier	HP	8349B	3155A00882	2014/07/10	2015/07/09
Amplifier	HP	8447D	3113A07663	2014/07/10	2015/07/09
Transient Limiter	Com-Power	LIT-153	532226	2014/07/10	2015/07/09
Radio Communication Tester	R&S	CMU200	3655A03522	2014/07/06	2015/07/05
Temperature/Humidity Meter	zhicheng	ZC1-2	22522	2014/07/10	2015/07/09
SIGNAL GENERATOR	HP	8647A	3200A00852	2014/07/10	2015/07/09
Wideband Peak Power Meter	Anritsu	ML2495A	220.23.35	2014/07/06	2015/07/05
Climate Chamber	ESPEC	EL-10KA	A20120523	2014/07/06	2015/07/05
High-Pass Filter	K&L	9SH10-2700/X12750-O/O	/	2014/07/06	2015/07/05
High-Pass Filter	K&L	41H10-1375/U12750-O/O	/	2014/07/06	2015/07/05
RF Cable	HUBER+SUHNER	RG214	/	2014/07/09	2015/07/08

### 3.8. Summary of Test Result

FCC PART 15		
FCC Part 15.207	AC Power Conducted Emission	PASS
FCC Part 15.247(a)(2)	6dB Bandwidth	PASS
FCC Part 15.247(d)	Spurious RF Conducted Emission	PASS
FCC Part 15.247(b)	Maximum Peak Output Power	PASS
FCC Part 15.247(e)	Power Spectral Density	PASS
FCC Part 15.109/ 15.205/ 15.209	Radiated Emissions	PASS
FCC Part 15.247(d)	Band Edge Compliance of RF Emission	PASS
FCC Part 15.203/15.247 (b)	Antenna Requirement	PASS

Remark: The measurement uncertainty is not included in the test result.

Preliminary tests were performed in different data rate to find the worst radiated emission. The data rate shown in the table below is the worst-case rate with respect to the specific test item. Investigation has been done on all the possible configurations for searching the worst cases. The following table is a list of the test modes shown in this test report.

Test Items	Mode	Data Rate	Channel
AC Power Conducted Emission	Normal Link	11 Mbps	1
Maximum Peak Conducted Output Power Power Spectral Density 6dB Bandwidth Spurious RF conducted emission	11b/DSSS	11 Mbps	1/6/11
	11g/OFDM	54 Mbps	1/6/11
	11n(20MHz)/OFDM	65Mbps	1/6/11
	11n(40MHz)/OFDM	150Mbps	3/6/9
Radiated Emission 30MHz~1GHz	11b/DSSS	11 Mbps	1/6/11
	11g/OFDM	54 Mbps	1/6/11
	11n(20MHz)/OFDM	65Mbps	1/6/11
	11n(40MHz)/OFDM	150Mbps	3/6/9
Radiated Emission 1GHz~10th Harmonic	11b/DSSS	11 Mbps	1/6/11
	11g/OFDM	54 Mbps	1/6/11
	11n(20MHz)/OFDM	65Mbps	1/6/11
	11n(40MHz)/OFDM	150Mbps	3/6/9
Band Edge Compliance of RF Emission	11b/DSSS	11 Mbps	1/11
	11g/OFDM	54 Mbps	1/11
	11n(20MHz)/OFDM	65Mbps	1/11
	11n(40MHz)/OFDM	150Mbps	3/9

Note1: According exploratory test, EUT will have maximum output power in those data rate, so those data rate were used for all test.

Note2: This device use MIMO 2X2 antennas, for 802.11b/g mode, based exploratory test, when transmit with Antenna 1 have worse emissions, so the final radiated spurious emissions were tested with Antenna 1. For 802.11n mode, all the radiated spurious emissions and band edge test were performed with two antennas transmit synchronous.

## 4. TEST CONDITIONS AND RESULTS

### 4.1. Conducted Emissions Test

#### TEST CONFIGURATION

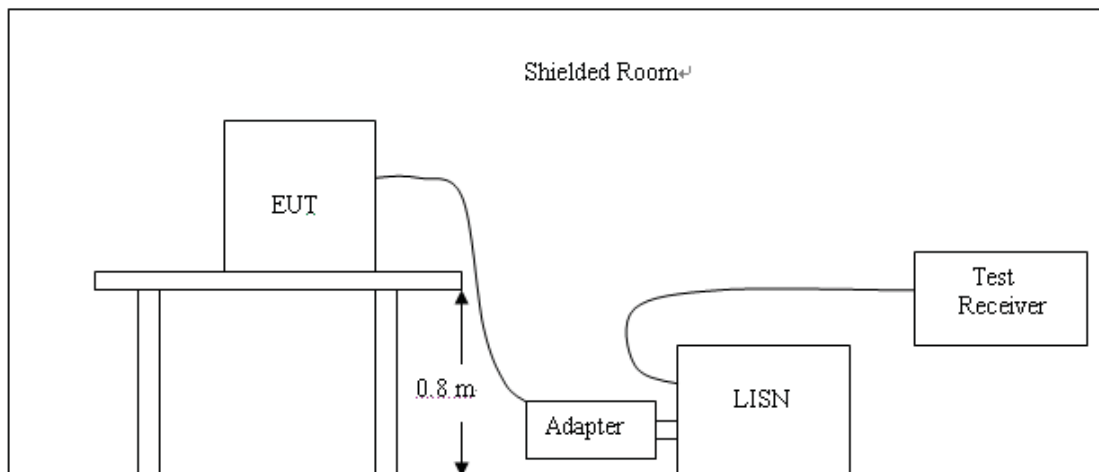

#### TEST PROCEDURE

For unintentional device, according to § 15.107(a) Line Conducted Emission Limits is as following:

Frequency (MHz)	Maximum RF Line Voltage (dB $\mu$ v)			
	CLASS A		CLASS B	
	Q.P.	Ave.	Q.P.	Ave.
0.15 - 0.50	79	66	66-56*	56-46*
0.50 - 5.00	73	60	56	46
5.00 - 30.0	73	60	60	50

\* Decreasing linearly with the logarithm of the frequency

For intentional device, according to §15.207(a) Line Conducted Emission Limit is same as above table.

1. Please follow the guidelines in ANSI C63.4-2009.
2. The EUT was placed 0.4 meter from the conducting wall of the shielding room was kept at least 80 centimeters from any other grounded conducting surface.
3. Connect EUT to the power mains through a line impedance stabilization network (LISN).
4. All the support units are connecting to the other LISN.
5. The LISN provides 50 ohm coupling impedance for the measuring instrument.
6. The FCC states that a 50 ohm, 50 microhenry LISN should be used.
7. Both sides of AC line were checked for maximum conducted interference.
8. The frequency range from 150 kHz to 30 MHz was searched.
9. Set the test-receiver system to Peak Detect Function and specified bandwidth with Maximum Hold Mode.

**The RBW/VBW for 150KHz to 30MHz: 9KHz**

**TEST RESULTS**

**SCAN TABLE: "Voltage (9K-30M) FIN"**

Short Description: 150K-30M Voltage

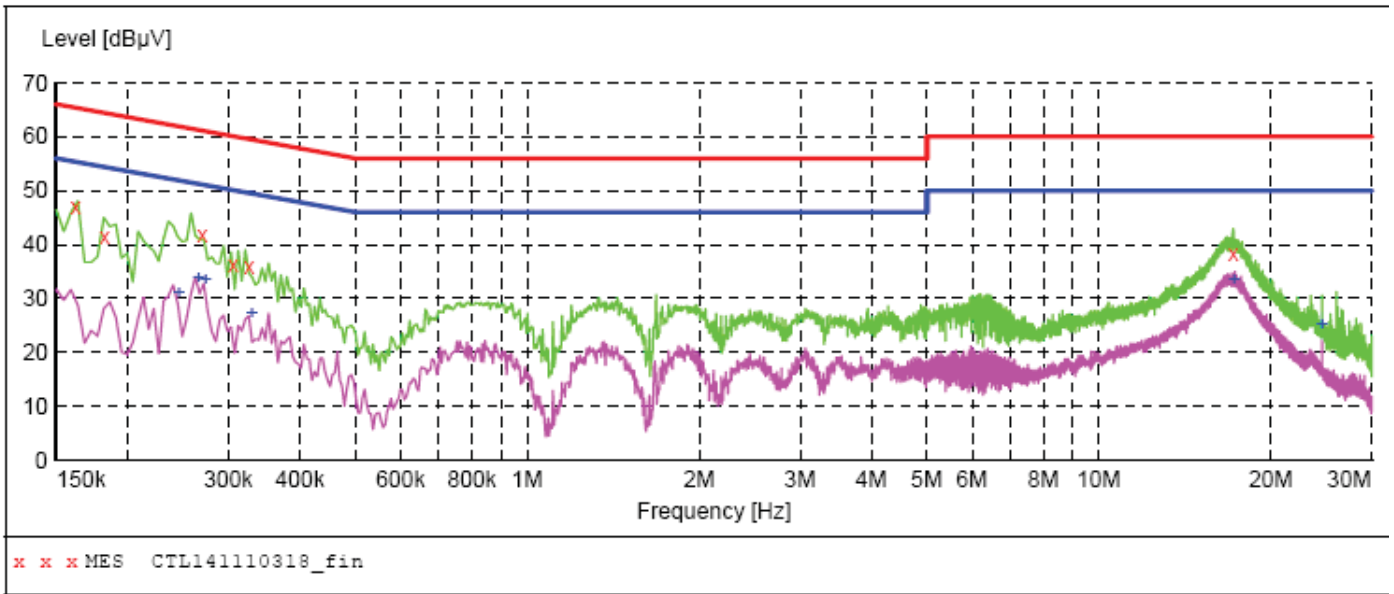

**MEASUREMENT RESULT: "CTL141110318\_fin"**

11/10/2014 10:15AM

Frequency MHz	Level dBµV	Transd dB	Limit dBµV	Margin dB	Detector	Line	PE
0.162000	47.10	10.2	65	18.3	QP	N	GND
0.182000	41.50	10.2	64	22.9	QP	N	GND
0.270000	41.90	10.2	61	19.2	QP	N	GND
0.306000	36.30	10.2	60	23.8	QP	N	GND
0.326000	35.80	10.2	60	23.8	QP	N	GND
17.150000	38.20	10.8	60	21.8	QP	N	GND

**MEASUREMENT RESULT: "CTL141110318\_fin2"**

11/10/2014 10:15AM

Frequency MHz	Level dBµV	Transd dB	Limit dBµV	Margin dB	Detector	Line	PE
0.246000	31.00	10.2	52	20.9	AV	N	GND
0.266000	33.70	10.2	51	17.5	AV	N	GND
0.274000	33.60	10.2	51	17.4	AV	N	GND
0.330000	27.10	10.2	50	22.4	AV	N	GND
17.264000	33.40	10.8	50	16.6	AV	N	GND
24.578000	25.30	11.1	50	24.7	AV	N	GND

**SCAN TABLE: "Voltage (9K-30M)FIN"**

Short Description: 150K-30M Voltage

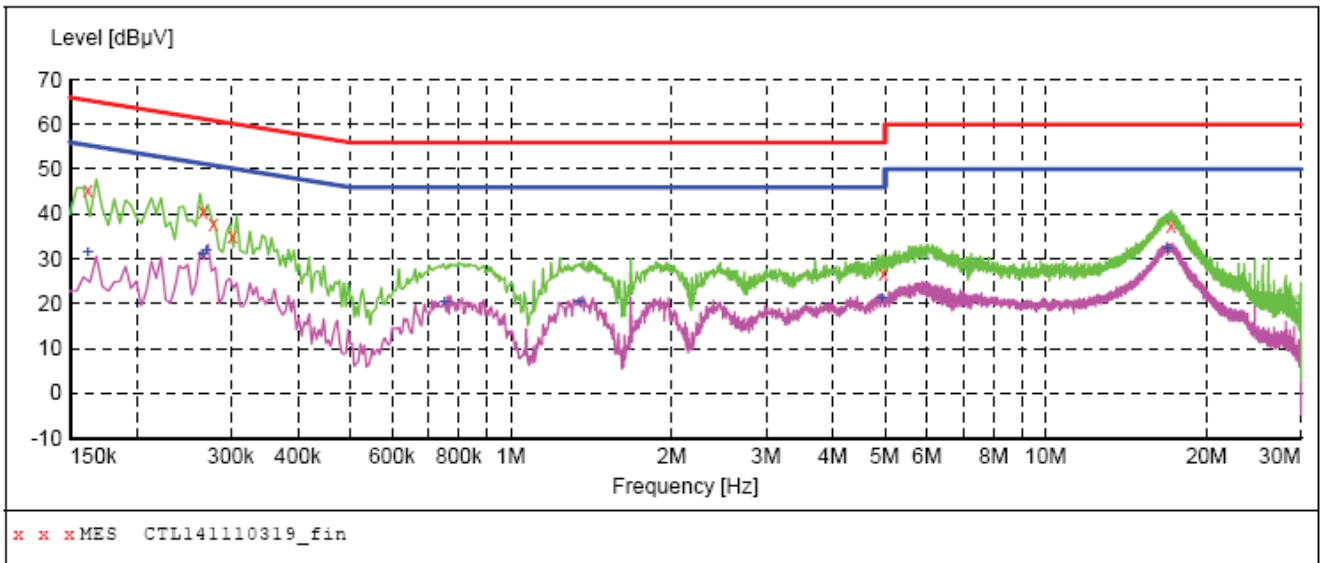

**MEASUREMENT RESULT: "CTL141110319\_fin"**

11/10/2014 10:19AM

Frequency MHz	Level dBµV	Transd dB	Limit dBµV	Margin dB	Detector	Line	PE
0.162000	45.20	10.2	65	20.2	QP	L1	GND
0.266000	40.60	10.2	61	20.6	QP	L1	GND
0.278000	37.70	10.2	61	23.2	QP	L1	GND
0.302000	35.20	10.2	60	25.0	QP	L1	GND
4.976000	26.80	10.4	56	29.2	QP	L1	GND
17.150000	37.20	10.8	60	22.8	QP	L1	GND

**MEASUREMENT RESULT: "CTL141110319\_fin2"**

11/10/2014 10:19AM

Frequency MHz	Level dBµV	Transd dB	Limit dBµV	Margin dB	Detector	Line	PE
0.162000	31.50	10.2	55	23.9	AV	L1	GND
0.266000	31.20	10.2	51	20.0	AV	L1	GND
0.270000	31.70	10.2	51	19.4	AV	L1	GND
0.752000	20.30	10.2	46	25.7	AV	L1	GND
1.346000	20.20	10.3	46	25.8	AV	L1	GND
4.946000	21.30	10.4	46	24.7	AV	L1	GND

### 4.2. Radiated Emission Test

#### TEST CONFIGURATION

(A) Radiated Emission Test Set-Up, Frequency Below 30MHz

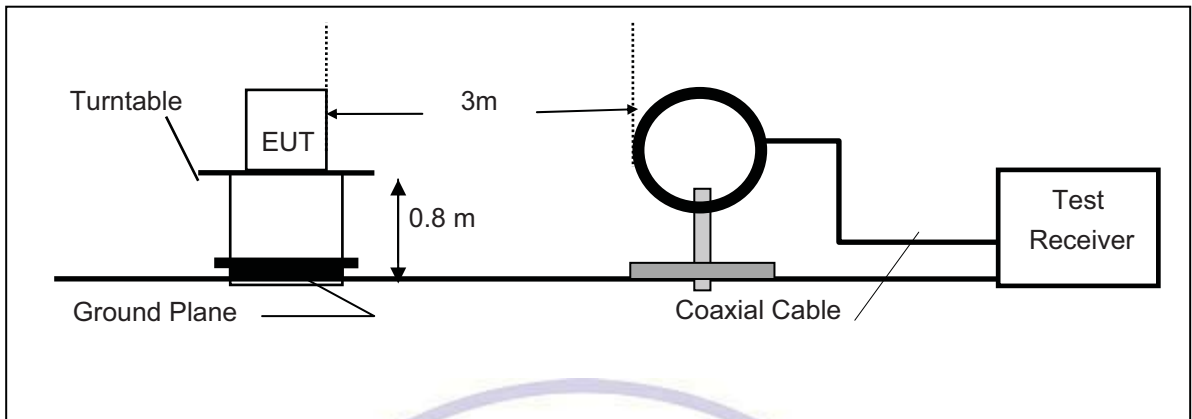

(B) Radiated Emission Test Set-Up, Frequency Below 1000MHz

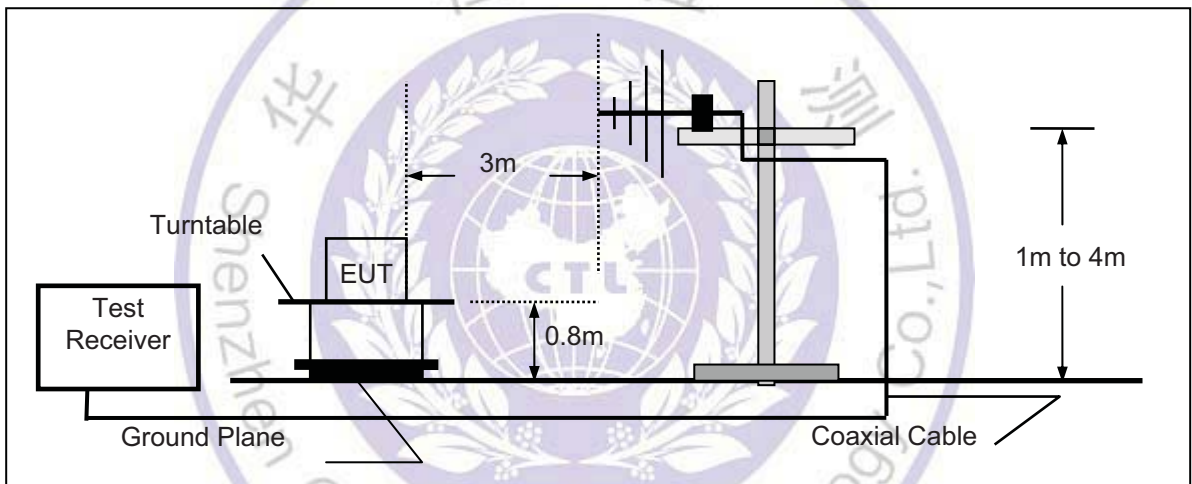

(C) Radiated Emission Test Set-Up, Frequency above 1000MHz

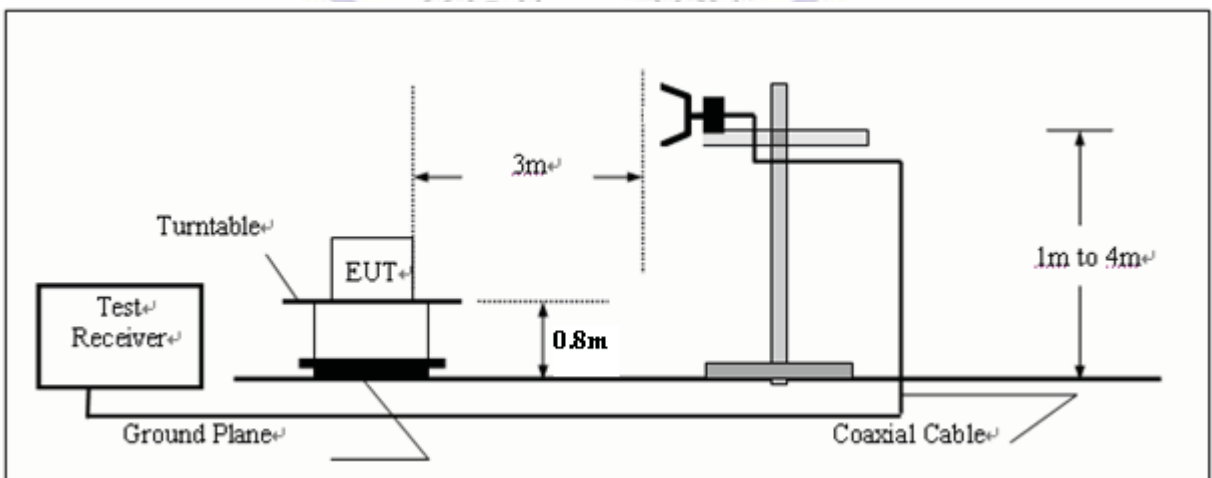

**FIELD STRENGTH CALCULATION**

The field strength is calculated by adding the Antenna Factor and Cable Factor and subtracting the Amplifier Gain and Duty Cycle Correction Factor(if any) from the measured reading. The basic equation with a sample calculation is as follows:

$$FS = RA + AF + CL - AG$$

Where FS = Field Strength	CL = Cable Attenuation Factor (Cable Loss)
RA = Reading Amplitude	AG = Amplifier Gain
AF = Antenna Factor	

**TEST PROCEDURE**

1. The testing follows FCC KDB Publication No. 558074 D01 v03r02 (Measurement Guidelines of DTS).
2. The EUT was placed on a turn table which is 0.8m above ground plane.
3. Maximum procedure was performed by raising the receiving antenna from 1m to 4m and rotating the turn table from 0° to 360° to acquire the highest emissions from EUT
4. And also, each emission was to be maximized by changing the polarization of receiving antenna both horizontal and vertical.
5. Span = wide enough to fully capture the emission being measured; RBW = 1 MHz for f > 1 GHz, 100 kHz for f < 1 GHz; VBW ≥ RBW; Sweep = auto; Detector function = peak; Trace = max hold.
6. Repeat above procedures until all frequency measurements have been completed.

**Note:**

When doing emission measurement above 1GHz, the horn antenna will be bended down a little (as horn antenna has the narrow beamwidth) in order to keeping the antenna in the “cone of radiation” of EUT. The 3dB beamwidth is 60 degrees for H-plane and 90 degrees for E-plane.

Remark : For above 1GHz, RBW 1MHz, VBW 3MHz, Peak detector for PK value, RMS detector for AV value.

**LIMIT**

For unintentional device, according to § 15.109(a), except for Class A digital devices, the field strength of radiated emissions from unintentional radiators at a distance of 3 meters shall not exceed the following values:

Frequency (MHz)	Distance (Meters)	Radiated (dBμV/m)	Radiated (μV/m)
30-88	3	40.0	100
88-216	3	43.5	150
216-960	3	46.0	200
Above 960	3	54.0	500

For intentional device, according to § 15.209(a), the general requirement of field strength of radiated emissions from intentional radiators at a distance of 3 meters shall not exceed the above table. According to § 15.247(d), in any 100kHz bandwidth outside the frequency band in which the EUT is operating, the radio frequency power that is produced by the intentional radiator shall be at least 20dB below that in the 100kHz bandwidth within the band that contains the highest level of desired power.



**TEST RESULTS**

9KHz-30MHz:

Freq. (MHz)	Level (dBuV)	Over Limit (dB)	Limit Line (dBuV)	Remark
-	-	-	-	See Note

Note: The amplitude of spurious emissions that are attenuated by more than 20dB below the permissible value has no need to be reported.

Distance extrapolation factor= 40 log (specific distance/ test distance) (dB);  
 Limit line= specific limits (dBuV) + distance extrapolation factor.

Below 1GHz:

The radiated measurement are performed the each test mode (b/g/n) and channel (low/mid/high), the datum recorded below (802.11b mode, the middle channel) is the worst case for all the test mode and channel.

**SWEEP TABLE: "test (30M-1G)"**

Short Description:		Field Strength			
Start	Stop	Detector	Meas. Time	IF Bandw.	Transducer
30.0 MHz	1.0 GHz	MaxPeak	300.0 ms	120 kHz	JB1

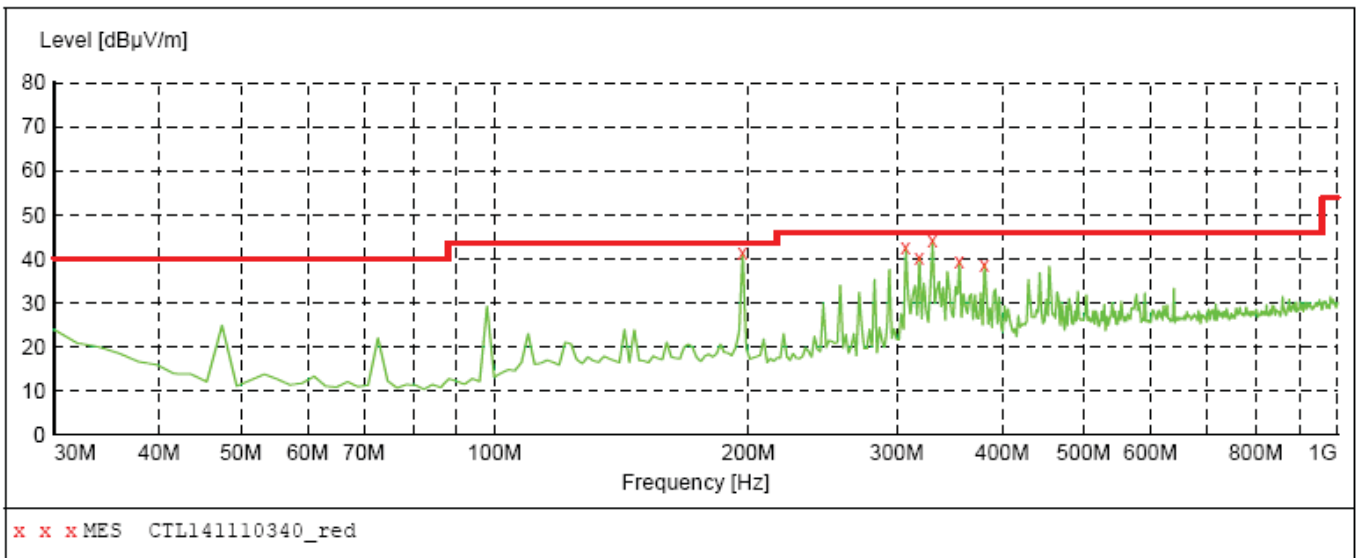

**MEASUREMENT RESULT: "CTL141110340\_red"**

11/10/2014 4:47PM

Frequency MHz	Level dBuV/m	Transd dB	Limit dBuV/m	Margin dB	Det.	Height cm	Azimuth deg	Polarization
196.840000	41.30	13.8	43.5	2.2	---	0.0	0.00	HORIZONTAL
307.420000	42.60	15.6	46.0	3.4	---	0.0	0.00	HORIZONTAL
319.060000	40.40	15.9	46.0	5.6	---	0.0	0.00	HORIZONTAL
330.700000	44.30	16.3	46.0	1.7	---	0.0	0.00	HORIZONTAL
355.920000	39.30	17.2	46.0	6.7	---	0.0	0.00	HORIZONTAL
381.140000	38.70	17.8	46.0	7.3	---	0.0	0.00	HORIZONTAL

**SWEEP TABLE: "test (30M-1G)"**

Short Description:		Field Strength			
Start	Stop	Detector	Meas. Time	IF Bandw.	Transducer
30.0 MHz	1.0 GHz	MaxPeak	300.0 ms	120 kHz	JB1

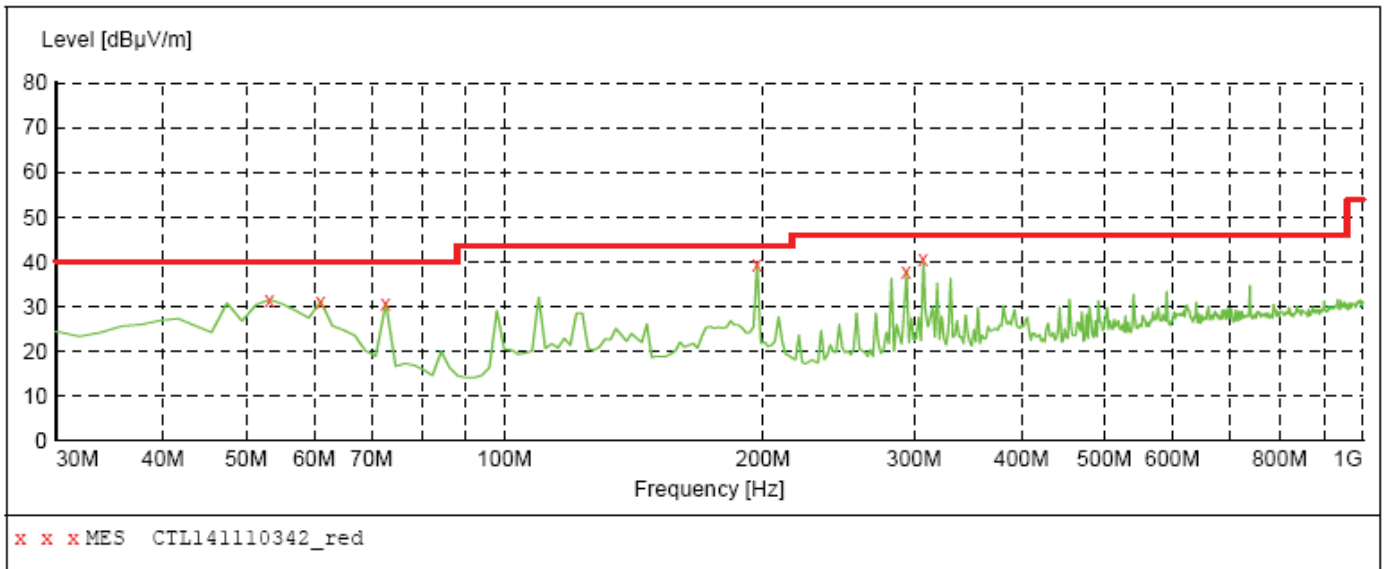

**MEASUREMENT RESULT: "CTL141110342\_red"**

11/10/2014 4:50PM

Frequency MHz	Level dBuV/m	Transd dB	Limit dBuV/m	Margin dB	Det.	Height cm	Azimuth deg	Polarization
53.280000	31.50	8.3	40.0	8.5	---	0.0	0.00	VERTICAL
61.040000	31.10	8.4	40.0	8.9	---	0.0	0.00	VERTICAL
72.680000	30.70	8.5	40.0	9.3	---	0.0	0.00	VERTICAL
196.840000	39.60	13.8	43.5	3.9	---	0.0	0.00	VERTICAL
293.840000	37.80	15.4	46.0	8.2	---	0.0	0.00	VERTICAL
307.420000	40.50	15.6	46.0	5.5	---	0.0	0.00	VERTICAL



## Above 1GHz:

## 802.11b

CH	Antenna	Frequency (MHz)	Reading Level (dBuV/m)	Factor (dB)	Measure Level (dBuV/m)	Limit (dBuV/m)	Margin (dB)	Detector
1	V	2412.0	71.7	30.8	102.5	Fundamental	/	PK
	V	287.6	13.6	14.8	28.4	46	17.6	QP
	V	324.5	17.2	19.7	36.9	46	9.1	QP
	V	3200.0	49.2	-0.6	48.6	54(note3)	5.4	PK
	V	4825.0	47.5	2.6	50.1	54(note3)	3.9	PK
	V	7239.0	50.1	8.1	58.2	74	15.8	PK
	V	7236.0	40.8	8.9	49.7	54	4.3	AV
	H	24000.0	62.3	-8.9	53.4	54(note3)	0.6	PK
6	V	2437.0	70.6	31.2	101.8	Fundamental	/	PK
	V	368.2	15.2	15.2	30.4	46	15.6	QP
	V	608.7	16.8	21.2	38.0	46	8.0	QP
	V	3200.0	45.9	-0.6	45.3	54(note3)	8.7	PK
	V	4876.0	45.9	2.8	48.7	54(note3)	5.3	PK
	V	7315.5	47.5	8.8	56.3	74	17.7	PK
	V	7311.0	43.9	8.1	52.0	54	2.0	AV
	H	24000.0	59.1	-8.9	50.2	54(note3)	3.8	PK
11	V	2462.0	70.5	30.9	101.4	Fundamental	/	PK
	V	458.1	12.6	14.9	27.5	46	18.5	QP
	H	596.7	12.9	21.2	34.1	46	11.9	QP
	V	3200.0	44.1	-0.6	43.5	54(note3)	10.5	PK
	V	4927.0	45.1	3.0	48.1	54(note3)	5.9	PK
	V	7383.5	50.1	8.9	59.0	74	15.0	PK
	V	7386.0	43.9	8.9	52.8	54	1.2	AV
	H	24000.0	59.2	-8.9	50.3	54(note3)	3.7	PK

Note: 1. Measure Level = Reading Level + Factor.

2. The test results which are attenuated more than 20 dB below the permissible value limit (the test frequency range: 9kHz~30MHz, 18GHz~25GHz), therefore no data appear in the report.

3. This limit applies for using average detector, if the test result on peak is lower than average limit, then average measurement needn't be performed.

## 802.11g

CH	Antenna	Frequency (MHz)	Reading Level (dBuV/m)	Factor (dB)	Measure Level (dBuV/m)	Limit (dBuV/m)	Margin (dB)	Detector
1	V	2411.9	71.0	31.9	102.9	Fundamental	/	PK
	H	271.4	10.8	15.7	26.5	46	19.5	QP
	H	359.1	10.1	21.3	31.4	46	14.6	QP
	V	3200.0	43.2	-0.6	42.6	54(note3)	11.4	PK
	V	4824.0	44.3	2.6	46.9	54(note3)	7.1	PK
	V	7236.0	46.2	8.9	55.1	74	18.9	PK
	V	7239.0	41.4	8.9	50.3	54	3.7	AV
	H	24000.0	60.0	-8.9	51.1	54(note3)	2.9	PK
6	V	2437.0	71.4	31.2	102.6	Fundamental	/	PK
	V	715.2	14.8	14.8	29.6	46	16.4	QP
	V	246.5	13.1	21.2	34.3	46	11.7	QP
	V	3200.0	43.4	-0.6	42.8	54(note3)	11.2	PK
	V	4876.0	45.2	2.8	48.0	54(note3)	6.0	PK
	V	7298.5	47.8	8.8	56.6	74	17.4	PK
	H	7298.9	44.1	8.8	52.9	54	1.1	AV
	H	24000.0	60.1	-8.9	51.2	54(note3)	2.8	PK
11	V	2462.3	71.2	30.9	102.1	Fundamental	/	PK
	H	842.5	7.2	21.2	28.4	46	17.6	QP
	V	103.4	20.9	14.7	35.6	46	10.4	QP
	V	3200.0	47.1	-0.6	46.5	54(note3)	7.5	PK
	V	4927.0	44.3	3.0	47.3	54(note3)	6.7	PK
	V	7386.0	48.2	8.9	57.1	74	16.9	PK
	V	7392.0	42.1	8.9	51.0	54	3.0	AV
	H	24000.0	60.4	-8.9	51.5	54(note3)	2.5	PK

Note: 1. Measure Level = Reading Level + Factor.

2. The test results which are attenuated more than 20 dB below the permissible value limit (the test frequency range: 9kHz~30MHz, 18GHz~25GHz), therefore no data appear in the report.

3. This limit applies for using average detector, if the test result on peak is lower than average limit, then average measurement needn't be performed.

## 802.11n(20MHz), KEEPING MIMO TX MODE

CH	Antenna	Frequency (MHz)	Reading Level (dBuV/m)	Factor (dB)	Measure Level (dBuV/m)	Limit (dBuV/m)	Margin (dB)	Detector
1	V	2412.1	70.8	30.7	101.5	Fundamental	/	PK
	H	542.9	10.9	21.2	32.1	46	13.9	QP
	H	362.8	12.4	15.1	27.5	46	18.5	QP
	V	3200.0	45.4	-0.6	44.8	54(note3)	9.2	PK
	V	4824.0	45.5	2.6	48.1	54(note3)	5.9	PK
	V	7236.0	46.7	8.9	55.6	74	18.4	PK
	V	7239.0	42.0	8.9	50.9	54	3.1	AV
	H	24000.0	60.3	-8.9	51.4	54(note3)	2.6	PK
6	V	2437.0	70.8	31.2	102.0	Fundamental	/	PK
	H	597.6	5.9	21.2	27.1	46	18.9	QP
	H	320.3	20.8	16.0	36.8	46	9.2	QP
	V	3200.0	44.1	-0.6	43.5	54(note3)	10.5	PK
	V	4876.0	46.7	2.8	49.5	54(note3)	4.5	PK
	V	7307.0	46.4	8.8	55.2	74	18.8	PK
	V	7310.6	42.5	8.8	51.3	54	2.7	AV
	H	24000.0	60.3	-8.9	51.4	54(note3)	2.6	PK
11	V	2462.0	70.8	30.9	101.7	Fundamental	/	PK
	H	364.3	14.9	14.7	29.6	46	16.4	QP
	H	541.9	10.2	21.2	31.4	46	14.6	QP
	V	3200.0	48.2	-0.6	47.6	54(note3)	6.4	PK
	V	4924.0	45.1	3.0	48.1	54(note3)	5.9	PK
	V	7375.0	48.6	9.0	57.6	74	16.4	PK
	V	7378.3	43.2	9.0	52.2	54	1.8	AV
	H	24000.0	60.3	-8.9	51.4	54(note3)	2.6	PK

Note: 1. Measure Level = Reading Level + Factor.

2. The test results which are attenuated more than 20 dB below the permissible value limit (the test frequency range: 9kHz~30MHz, 18GHz~25GHz), therefore no data appear in the report.

3. This limit applies for using average detector, if the test result on peak is lower than average limit, then average measurement needn't be performed.

## 802.11n(40MHz), KEEPING MIMO TX MODE

CH	Antenna	Frequency (MHz)	Reading Level (dBuV/m)	Factor (dB)	Measure Level (dBuV/m)	Limit (dBuV/m)	Margin (dB)	Detector
3	V	2423.6	69.4	31.8	101.2	Fundamental	/	PK
	H	341.9	13.2	16.0	29.2	46	16.8	QP
	H	564.0	4.6	21.2	25.8	46	20.2	QP
	V	3200.0	46.2	-0.6	45.6	54(note3)	8.4	PK
	V	4844.0	45.0	2.6	47.6	54(note3)	6.4	PK
	V	7290.0	47.3	8.8	56.1	74	17.9	PK
	H	7290.7	43.3	8.8	52.1	54	1.9	AV
	H	24000.0	60.2	-8.9	51.3	54(note3)	2.7	PK
6	V	2437.0	70.5	31.2	101.7	Fundamental	/	PK
	H	291.9	15.8	14.8	30.6	46	15.4	QP
	H	553.3	13.0	21.2	34.2	46	11.8	QP
	V	3200.0	46.3	-0.6	45.7	54(note3)	8.3	PK
	V	4874.0	46.1	2.8	48.9	54(note3)	5.1	PK
	V	7349.2	48.6	9.0	57.6	74	16.4	PK
	V	7358.0	42.8	9.0	51.8	54	2.2	AV
	H	24000.0	60.0	-8.9	51.1	54(note3)	2.9	PK
9	V	2453.6	71.1	30.9	102.0	Fundamental	/	PK
	H	586.3	10.2	21.2	31.4	46	14.6	QP
	H	294.3	14.1	14.8	28.9	46	17.1	QP
	V	3200.0	47.8	-0.6	47.2	54(note3)	6.8	PK
	V	4904.0	44.4	2.9	47.3	54(note3)	6.7	PK
	V	7349.4	47.2	9.0	56.2	74	17.8	PK
	V	7349.5	41.8	9.0	50.8	54	3.2	AV
	H	24000.0	60.3	-8.9	51.4	54(note3)	2.6	PK

Note: 1. Measure Level = Reading Level + Factor.

2. The test results which are attenuated more than 20 dB below the permissible value limit (the test frequency range: 9kHz~30MHz, 18GHz~25GHz), therefore no data appear in the report.

3. This limit applies for using average detector, if the test result on peak is lower than average limit, then average measurement needn't be performed.

### 4.3. 6dB Bandwidth Measurement

#### TEST CONFIGURATION

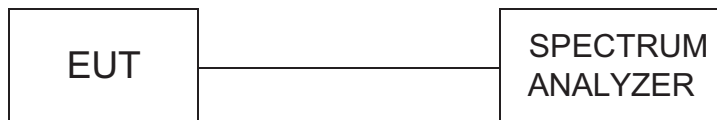

#### TEST PROCEDURE

1. The testing follows FCC KDB Publication No. 558074 D01 v03r02 (Measurement Guidelines of DTS).
2. The RF output of EUT was connected to the spectrum analyzer by a low loss cable.
3. Make the measurement with the spectrum analyzer's resolution bandwidth (RBW) = 100 kHz. In order to make an accurate measurement, set the span greater than RBW. The 6 dB bandwidth must be greater than 500 kHz.
4. The marker-delta reading at this point is the 6 dB bandwidth of the emission.

#### LIMIT

For digital modulation systems, the minimum 6 dB bandwidth shall be at least 500 kHz.

#### TEST RESULTS

Mode	CHANNEL	6dB BANDWIDTH (MHz)		MINIMUM LIMIT (MHz)	PASS/FAIL
		Ant 1 6dB	Ant 2 6dB		
802.11b	1	9.698	10.064	0.5	PASS
	6	9.188	10.020	0.5	PASS
	11	9.611	9.699	0.5	PASS
802.11g	1	16.465	16.440	0.5	PASS
	6	16.479	16.624	0.5	PASS
	11	16.463	16.463	0.5	PASS
802.11n HT20	1	17.765	17.675	0.5	PASS
	6	17.612	17.570	0.5	PASS
	11	17.642	16.680	0.5	PASS
802.11n HT40	3	35.559	35.661	0.5	PASS
	6	35.613	35.569	0.5	PASS
	9	35.522	35.726	0.5	PASS

For 802.11b:

CH1 @ANT 1

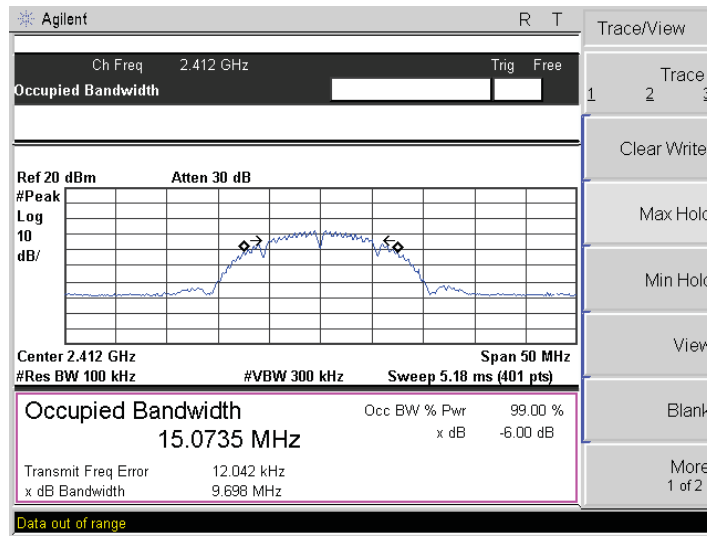

CH1 @ANT 2

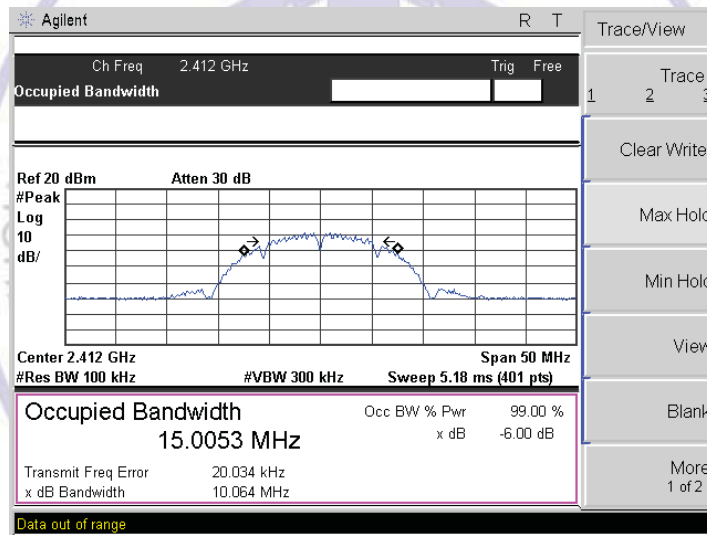

CH6 @ANT 1

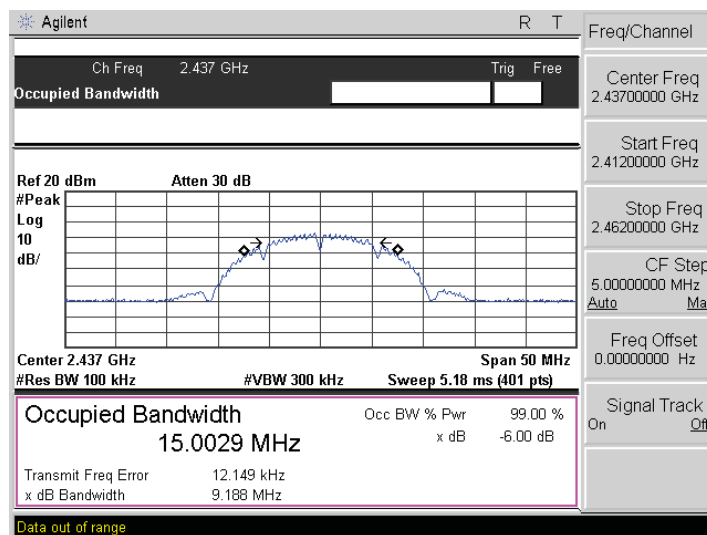



CH6 @ANT 2

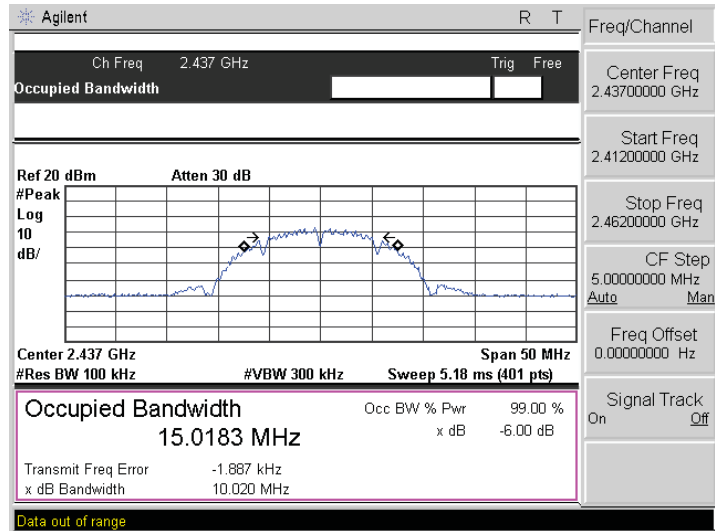

CH11 @ANT 1

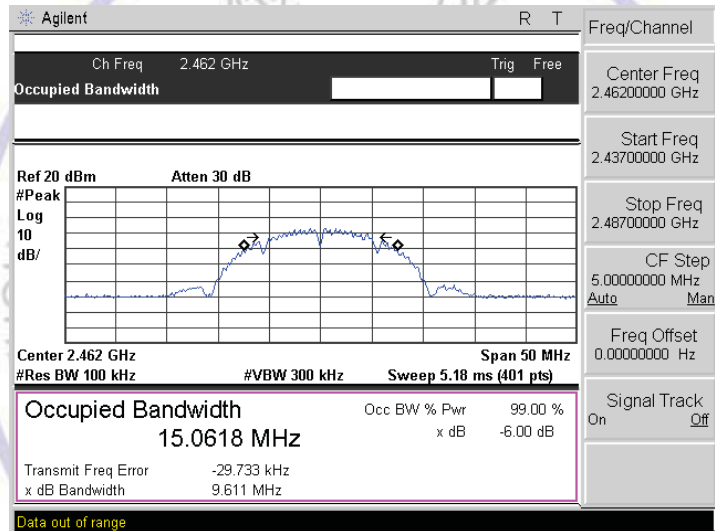

CH11 @ANT 2

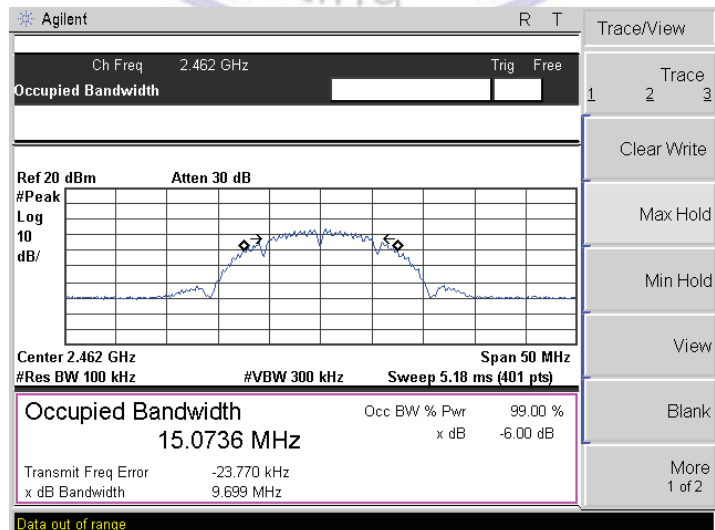

For 802.11g:

CH1 @ANT 1

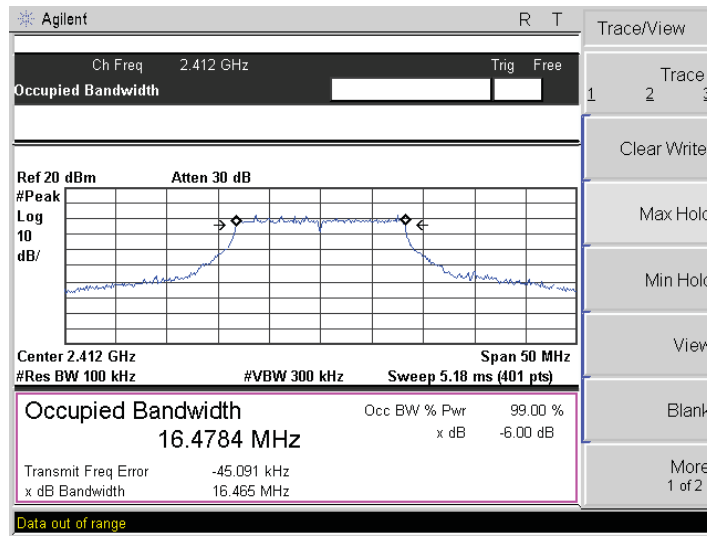

CH1 @ANT 2

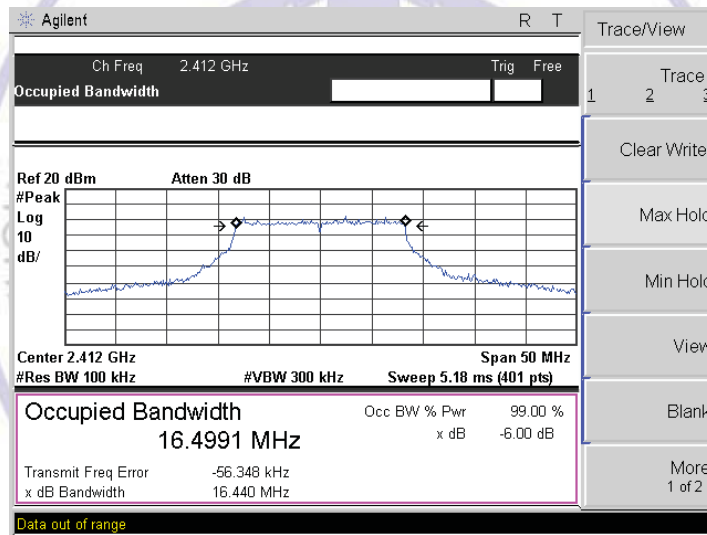

CH6 @ ANT 1

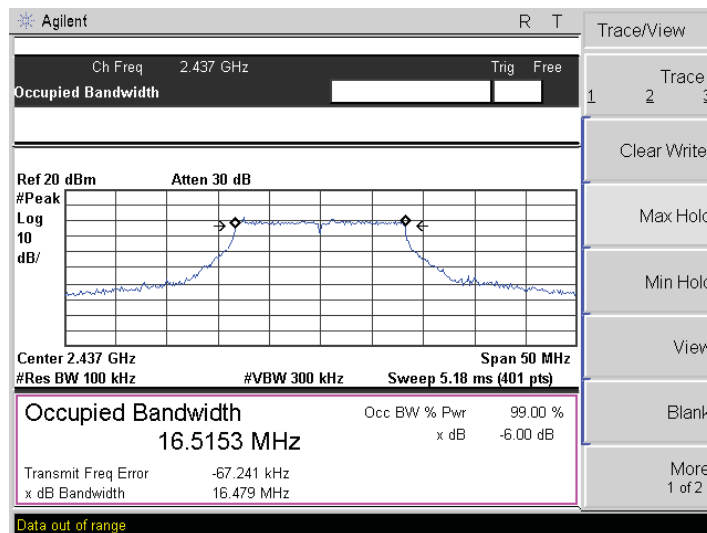

CH6 @ANT 2

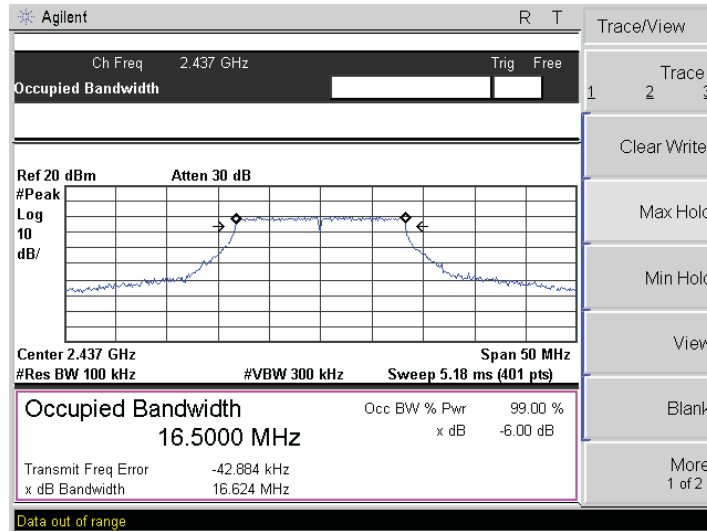

CH11 @ANT 1

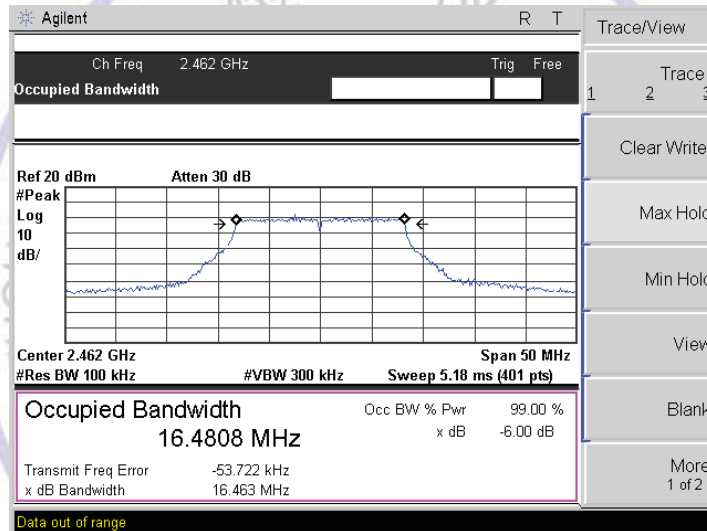

CH11 @ANT 2

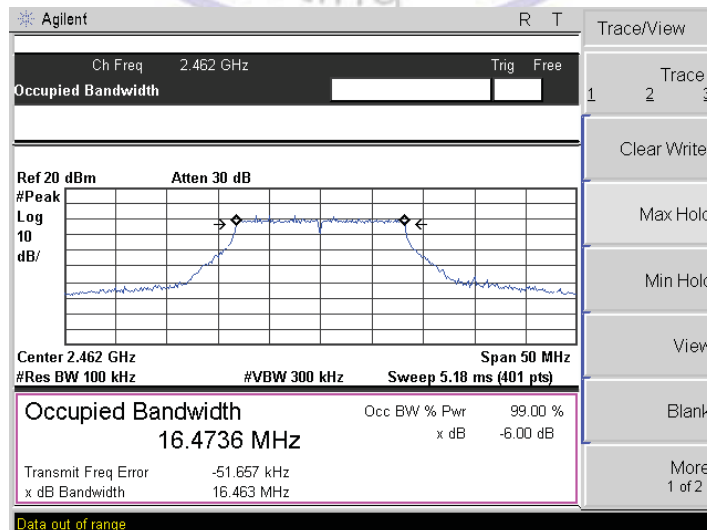

For 802.11n (20MHz) Mode:

CH1 @ANT 1

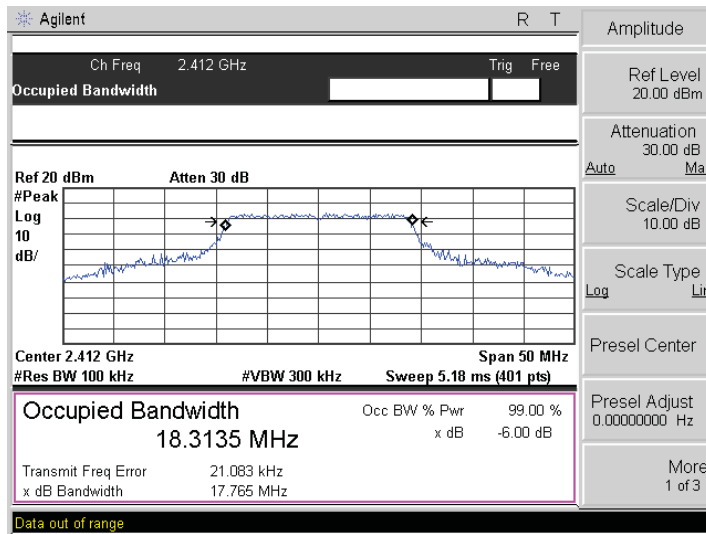

CH1 @ANT 2

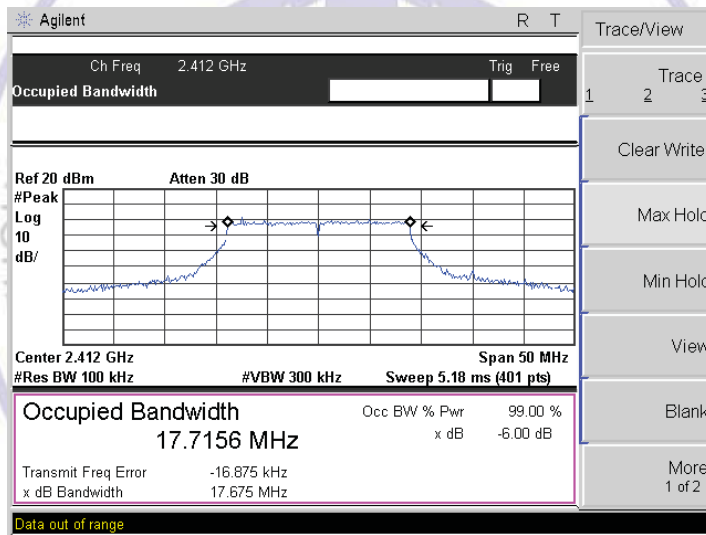

CH6 @ANT 1

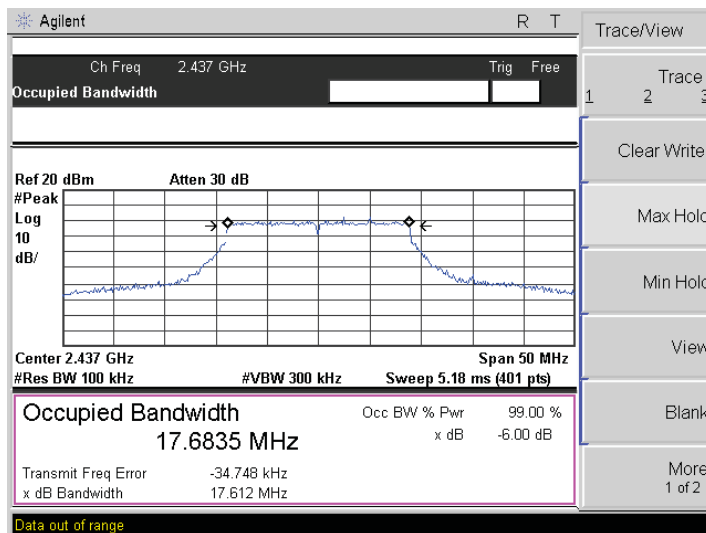

CH6 @ANT 2

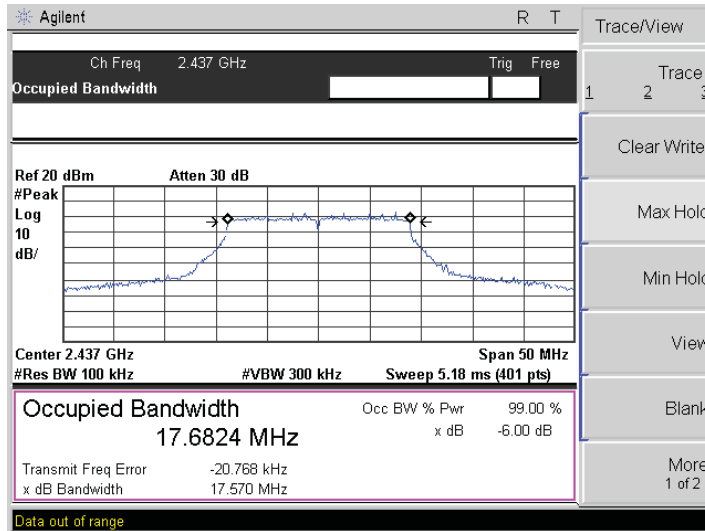

CH11 @ANT 1

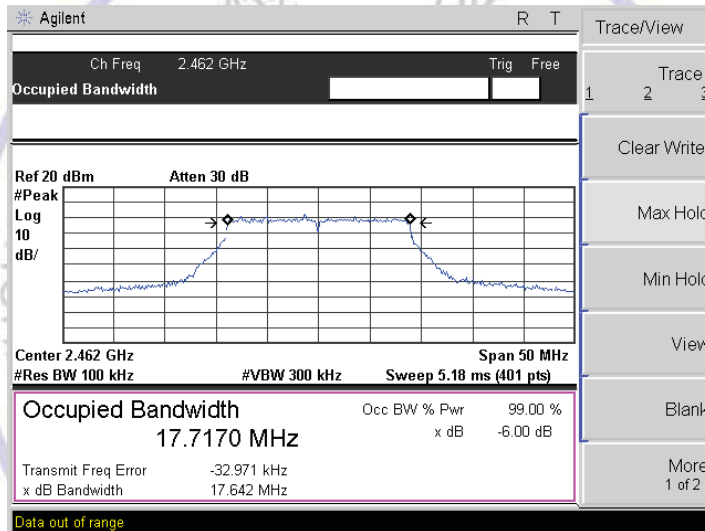

CH11 @ANT 2

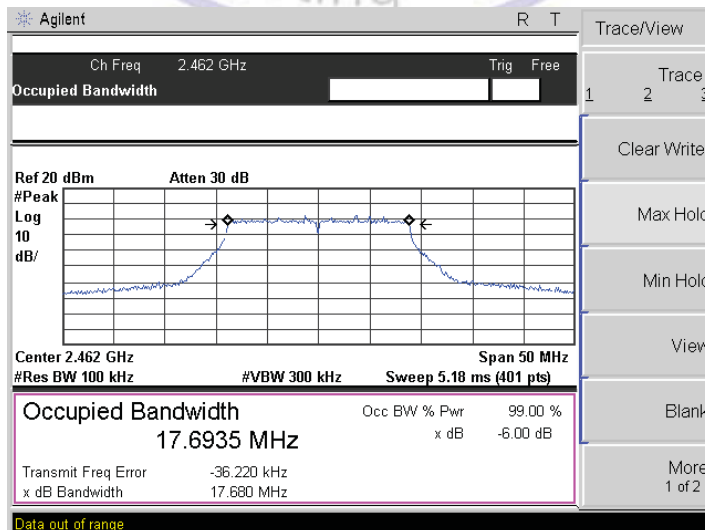

For 802.11n (40MHz) Mode:

CH3 @ANT 1

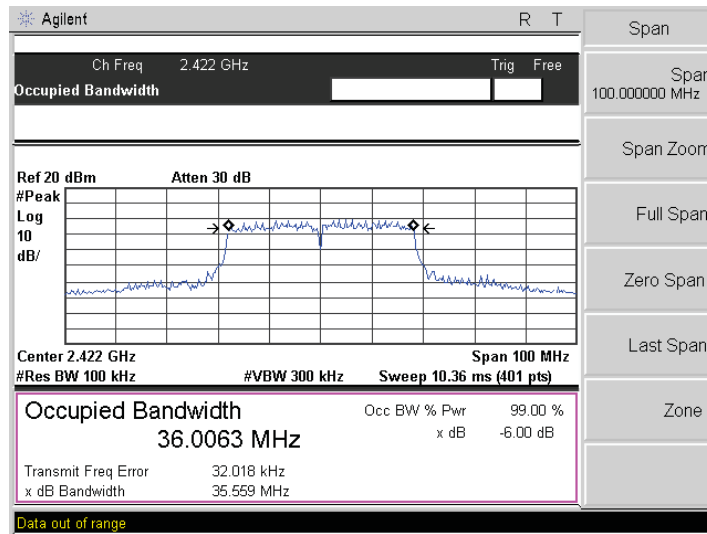

CH3 @ANT 2

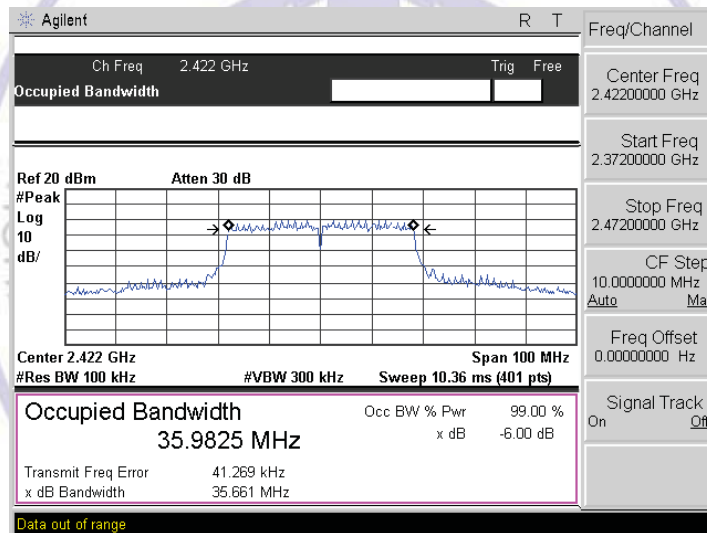

CH6 @ANT 1

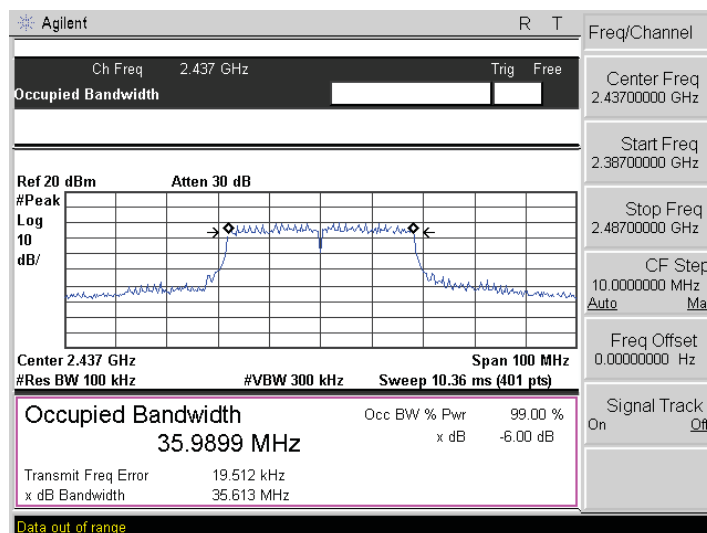

CH6 @ANT 2

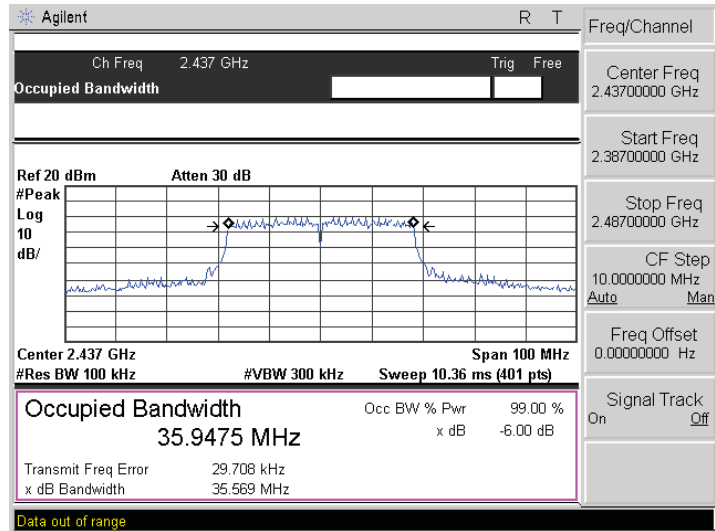

CH9 @ANT 1

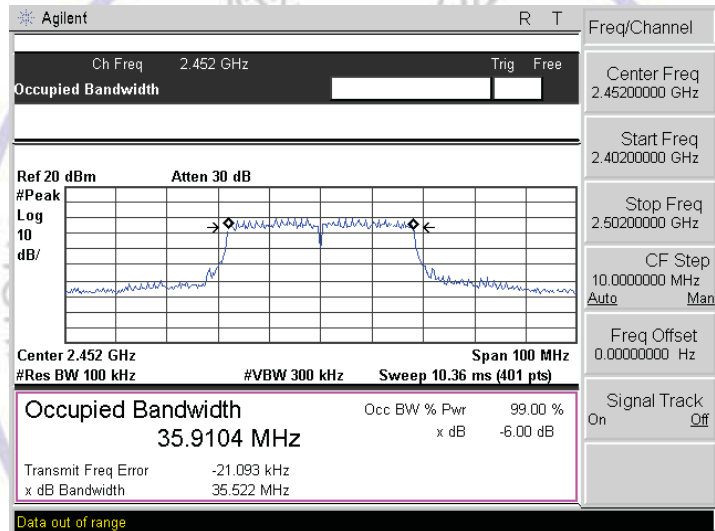

CH9 @ANT 2

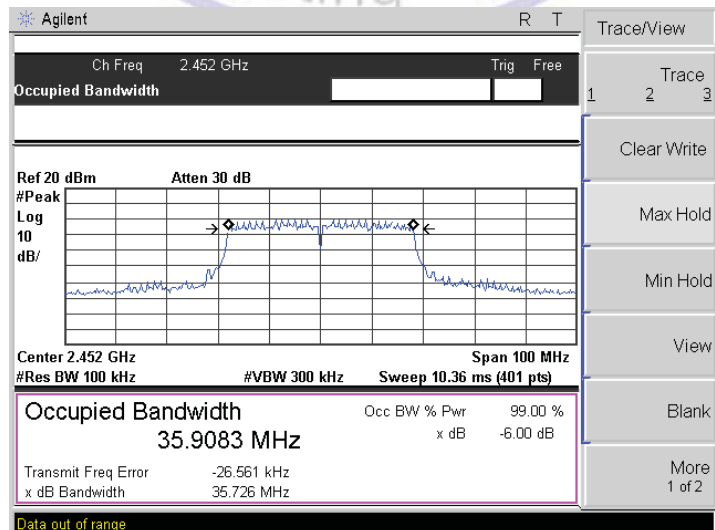

#### 4.4. Maximum Peak Output Power

##### TEST CONFIGURATION

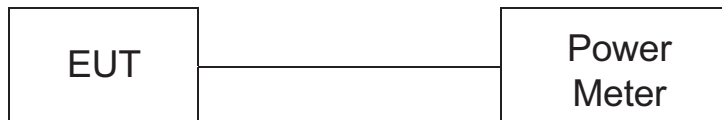

##### TEST PROCEDURE

According to C63.10 -2009 and KDB558074 D01 v03r02, The EUT was directly connected to the power meter / spectrum analyzer and antenna output port as show in the block diagram as TEST CONFIGURATION shows.

Use the wideband power meter to test peak power and record the result.

##### LIMIT

The Peak Output Power Measurement limits are 30dBm.

##### TEST RESULTS

Mode	Channel	Peak Power Output (dBm)			Peak Power Limit (dBm)	PASS / FAIL
		Ant1	Ant 2	Total		
802.11b	1	8.85	8.78	N/A	30	PASS
	6	8.91	8.83	N/A	30	PASS
	11	8.84	8.92	N/A	30	PASS
802.11g	1	8.61	8.68	N/A	30	PASS
	6	8.50	8.72	N/A	30	PASS
	11	8.48	8.53	N/A	30	PASS
802.11n HT20	1	6.58	6.43	9.52	30	PASS
	6	6.47	6.56	9.53	30	PASS
	11	6.37	6.51	9.45	30	PASS
802.11n HT40	3	6.21	6.15	9.19	30	PASS
	6	6.33	6.08	9.22	30	PASS
	9	6.14	6.19	9.18	30	PASS

Note: The test results including the cable lose.



## 4.5. Band Edge Measurement

### TEST CONFIGURATION

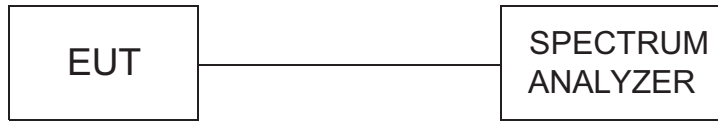

### TEST PROCEDURE

The band edge compliance of RF radiated emission should be measured by following the guidance in ANSI C63.10 and FCC KDB Publication No. 558074 D01 v03r02 (Measurement Guidelines of DTS) with respect to maximizing the emission by rotating the EUT, measuring the emission while the EUT is situated in three orthogonal planes (if appropriate), adjusting the measurement antenna height and polarization etc.

For above 1GHz, RBW 1MHz, VBW 3MHz, Peak detector for PK value, RMS detector for AV value.

Place a marker at the end of the restricted band closest to the transmit frequency to show compliance. Also measure any emissions in the restricted bands. Save the spectrum analyzer plot. Repeat for each power and modulation for lowest and highest channel.

### LIMIT

1. Below -20dB of the highest emission level in operating band.
2. Fall in the restricted bands listed in section 15.205. The maximum permitted average field strength is listed in section 15.209(see Section 15.205(c)).

Frequency (MHz)	Limit Average (dBuV/m)	Limit Peak (dBuV/m)
Below 2390 or Above 2483.5	54	74

**TEST RESULTS**

Transmitting mode: 802.11b

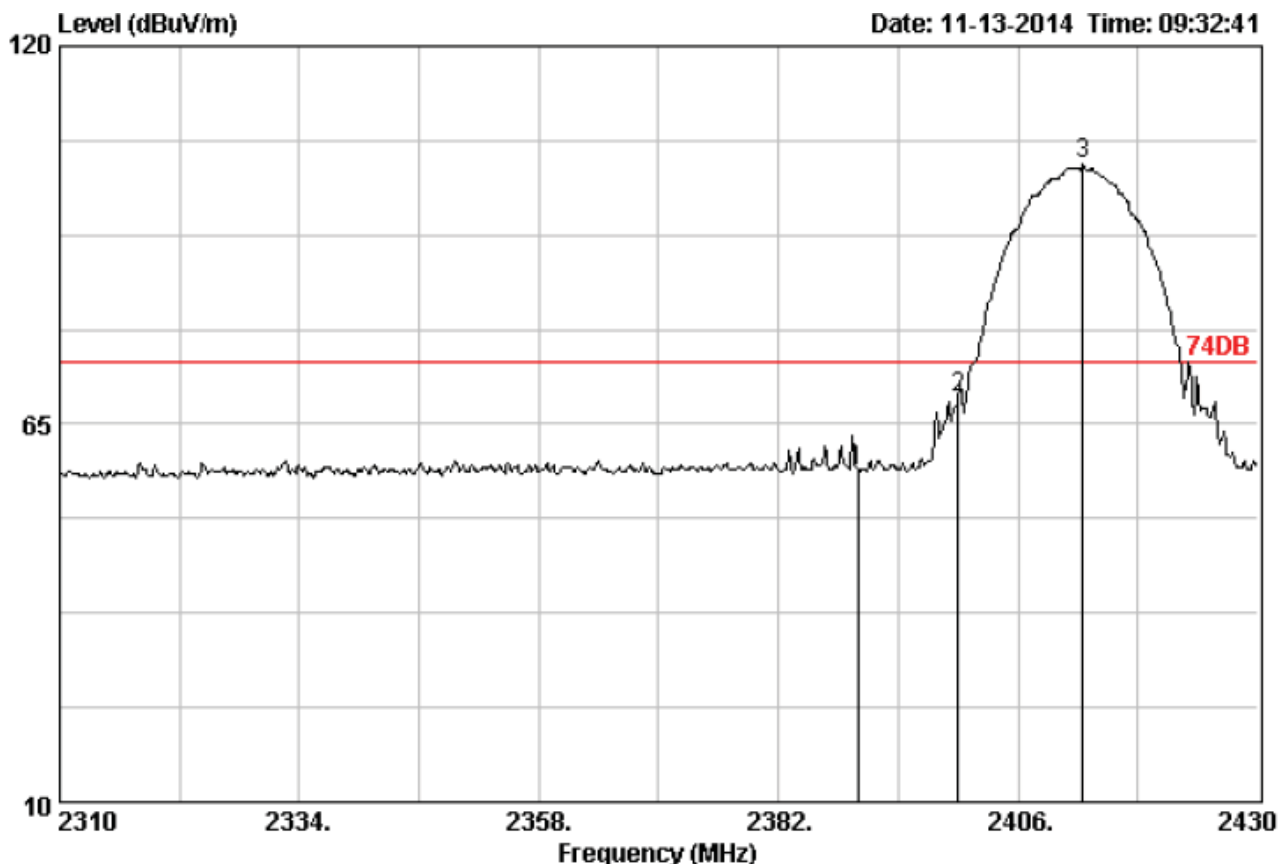

Site no. : 3m Chamber Data no. : 834  
 Dis. / Ant. : 3m DRH-118 Ant. pol. : HORIZONTAL  
 Limit : 74DB  
 Env. / Ins. : 23\*C/54%  
 Engineer :  
 EUT :  
 Power :  
 M/N :  
 Test Mode :

	Freq. (MHz)	Ant. Factor (dB)	Cable Loss (dB)	Reading (dBuV)	Emission Level (dBuV/m)	Limits (dBuV/m)	Margin (dB)	Remark
1	2390.00	28.78	4.61	60.00	58.03	74.00	15.97	Peak
2	2400.00	28.78	4.61	70.71	68.74	74.00	5.26	Peak
3	2412.48	28.81	4.63	104.68	102.76	74.00	-28.76	Peak

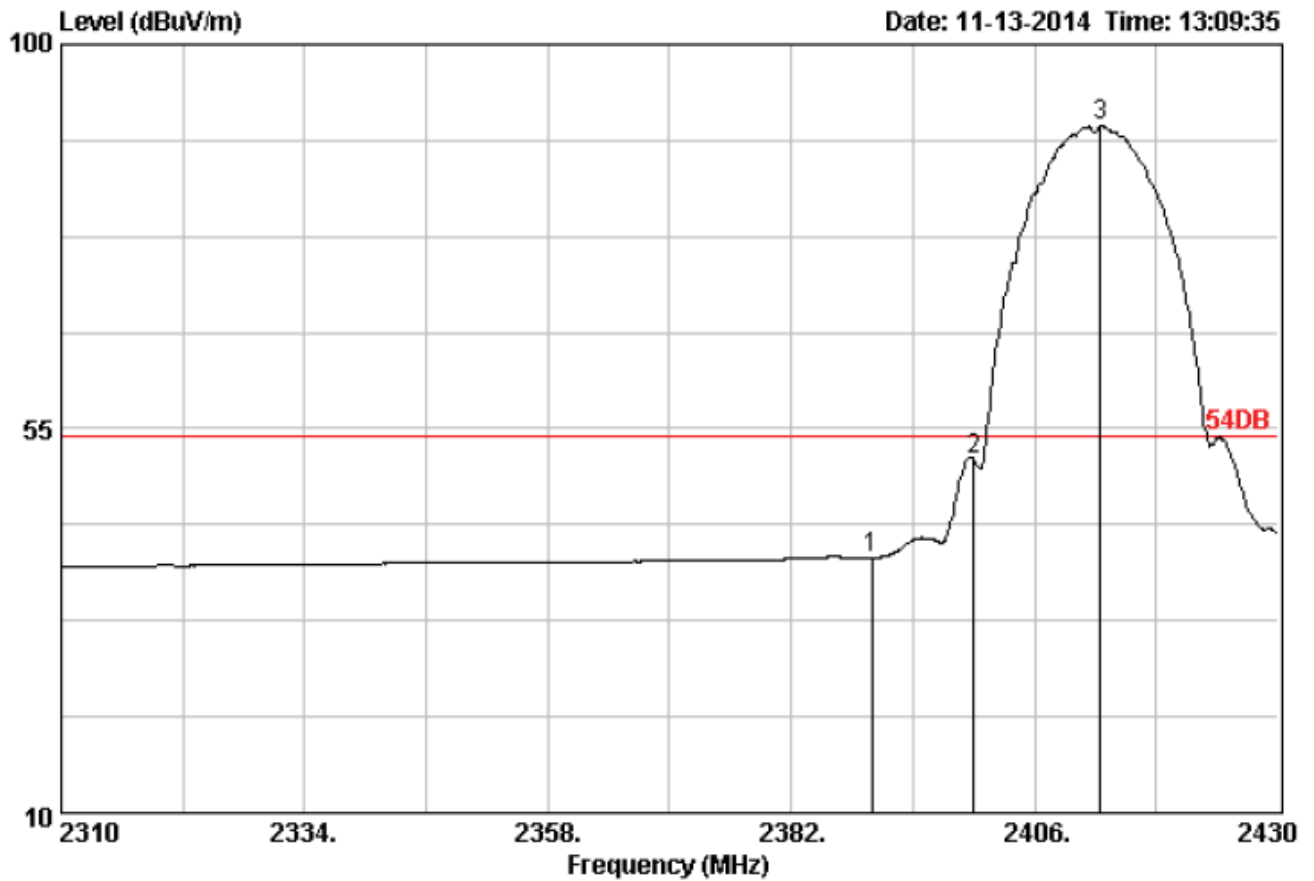

Site no. : 3m Chamber  
 Dis. / Ant. : 3m DRH-118  
 Limit : 54DB  
 Env. / Ins. : 23°C/54%  
 Engineer :  
 EUT :  
 Power :  
 M/N :  
 Test Mode :

Data no. : 862  
 Ant. pol. : HORIZONTAL

	Freq. (MHz)	Ant. Factor (dB)	Cable Loss (dB)	Reading (dBuV)	Emission			Remark
					Level (dBuV/m)	Limits (dBuV/m)	Margin (dB)	
1	2390.00	28.78	4.61	41.86	39.89	54.00	14.11	Average
2	2400.00	28.78	4.61	53.38	51.41	54.00	2.59	Average
3	2412.48	28.81	4.63	92.45	90.53	54.00	-36.53	Average

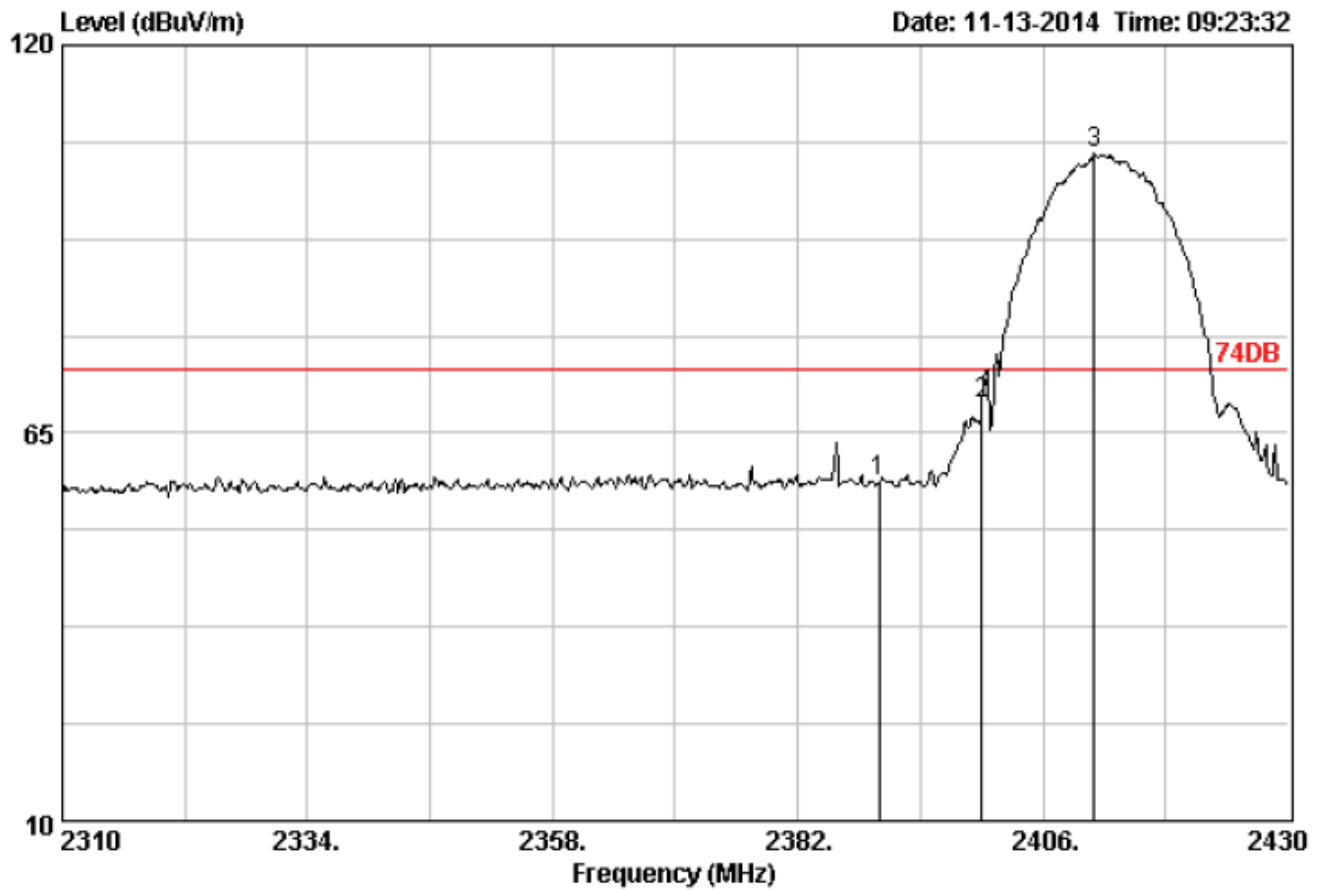

Site no. : 3m Chamber Data no. : 832  
 Dis. / Ant. : 3m DRH-118 Ant. pol. : VERTICAL  
 Limit : 74DB  
 Env. / Ins. : 23\*C/54%  
 Engineer :  
 EUT :  
 Power :  
 M/N :  
 Test Mode :

	Freq. (MHz)	Ant. Factor (dB)	Cable Loss (dB)	Reading (dBuV)	Emission Level (dBuV/m)	Limits (dBuV/m)	Margin (dB)	Remark
1	2390.00	28.78	4.61	59.95	57.98	74.00	16.02	Peak
2	2400.00	28.78	4.61	70.99	69.02	74.00	4.98	Peak
3	2411.04	28.81	4.63	106.47	104.55	74.00	-30.55	Peak

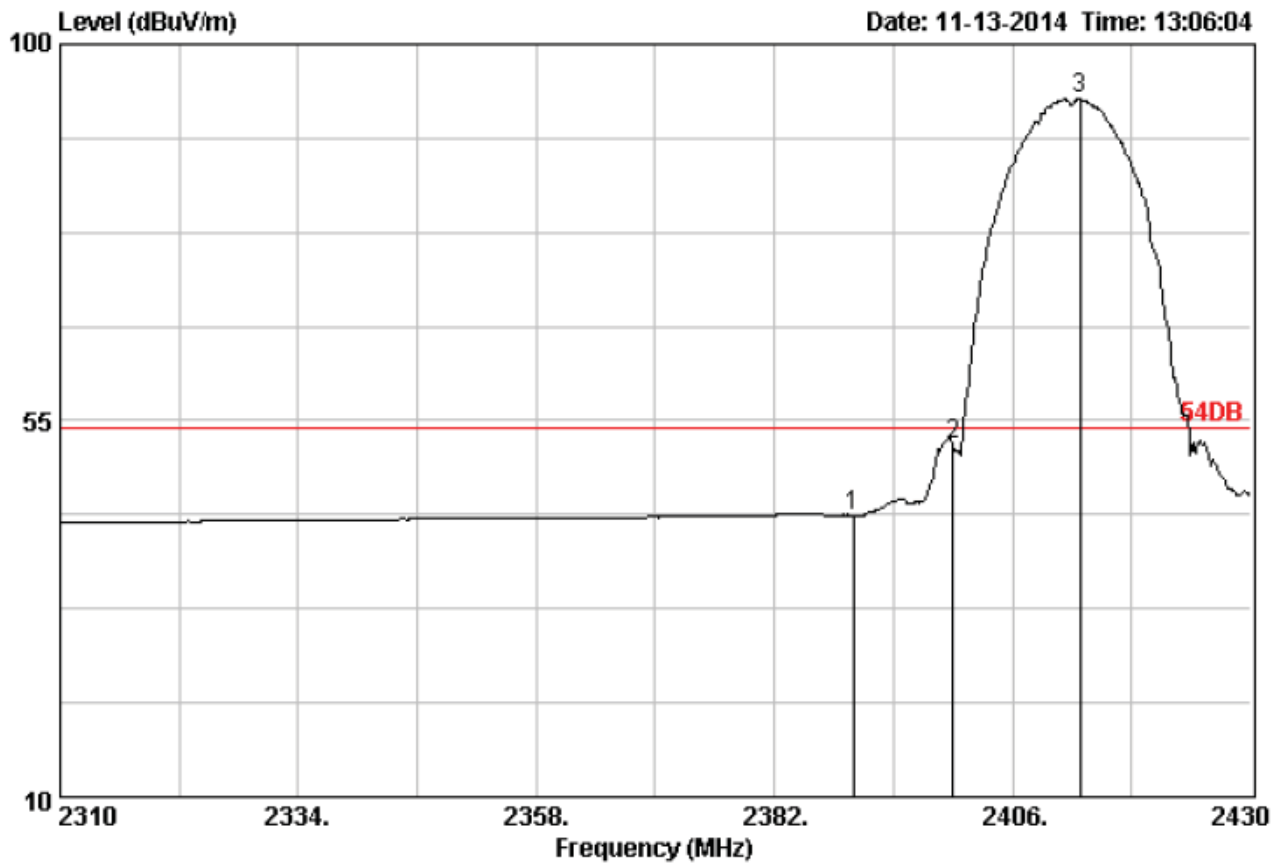

Site no. : 3m Chamber Data no. : 861  
 Dis. / Ant. : 3m DRH-118 Ant. pol. : VERTICAL  
 Limit : 54DB  
 Env. / Ins. : 23\*C/54%  
 Engineer :  
 EUT :  
 Power :  
 M/N :  
 Test Mode :

	Freq. (MHz)	Ant. Factor (dB)	Cable Loss (dB)	Emission Reading (dBuV)	Emission Level (dBuV/m)	Limits (dBuV/m)	Margin (dB)	Remark
1	2390.00	28.78	4.61	45.65	43.68	54.00	10.32	Average
2	2400.00	28.78	4.61	53.97	52.00	54.00	2.00	Average
3	2412.84	28.81	4.63	95.47	93.55	54.00	-39.55	Average

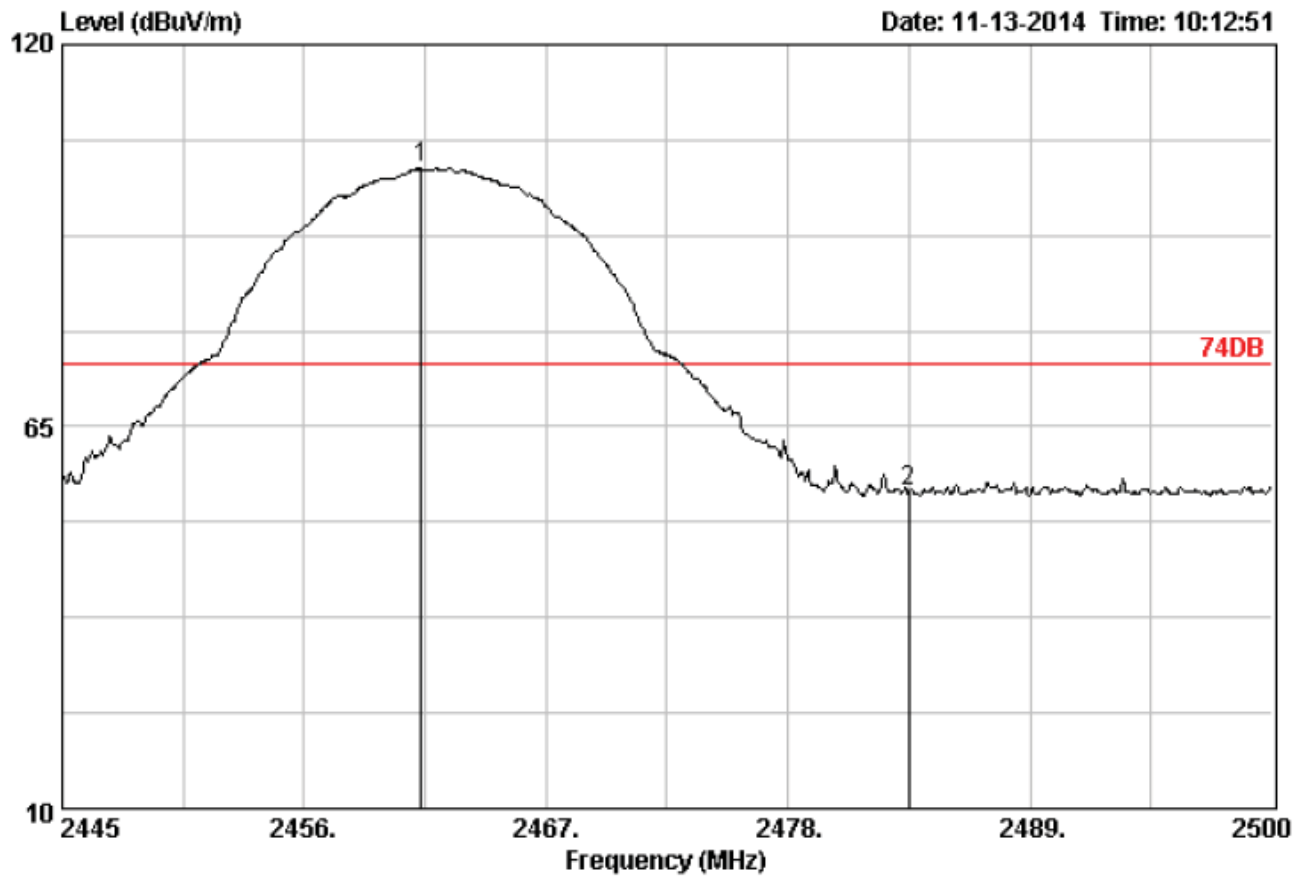

Site no. : 3m Chamber Data no. : 840  
 Dis. / Ant. : 3m DRH-118 Ant. pol. : HORIZONTAL  
 Limit : 74DB  
 Env. / Ins. : 23\*C/54%  
 Engineer :  
 EUT :  
 Power :  
 M/N :  
 Test Mode :

	Freq. (MHz)	Ant. Factor (dB)	Cable Loss (dB)	Reading (dBuV)	Emission Level (dBuV/m)	Limits (dBuV/m)	Margin (dB)	Remark
1	2461.34	28.90	4.68	104.02	102.23	74.00	-28.23	Peak
2	2483.50	28.93	4.70	57.36	55.61	74.00	18.39	Peak

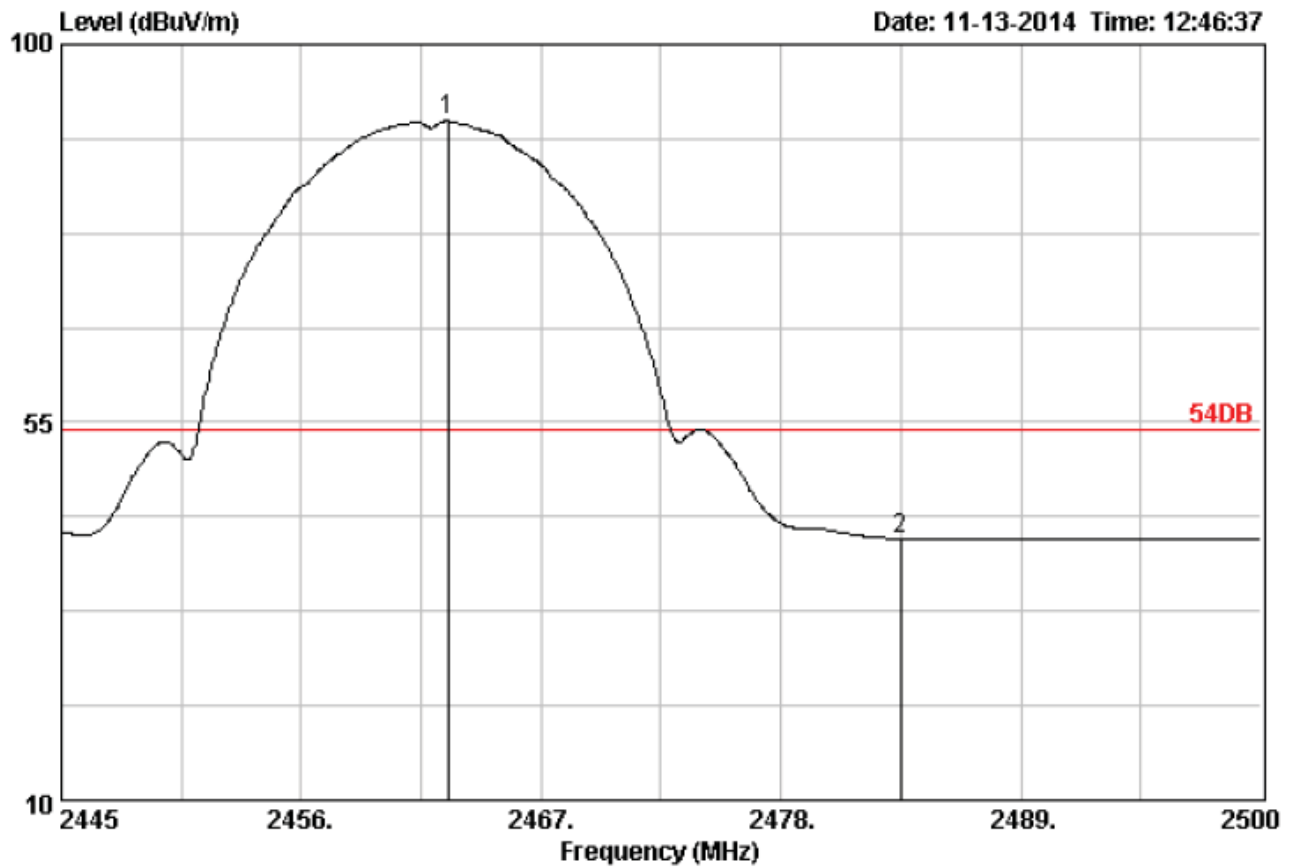

Site no. : 3m Chamber Data no. : 859  
 Dis. / Ant. : 3m DRH-118 Ant. pol. : HORIZONTAL  
 Limit : 54DB  
 Env. / Ins. : 23\*C/54%  
 Engineer :  
 EUT :  
 Power :  
 M/N :  
 Test Mode :

	Freq. (MHz)	Ant. Factor (dB)	Cable Loss (dB)	Reading (dBuV)	Emission			Remark
					Level (dBuV/m)	Limits (dBuV/m)	Margin (dB)	
1	2462.71	28.90	4.68	92.66	90.87	54.00	-36.87	Average
2	2483.50	28.93	4.70	42.87	41.12	54.00	12.88	Average

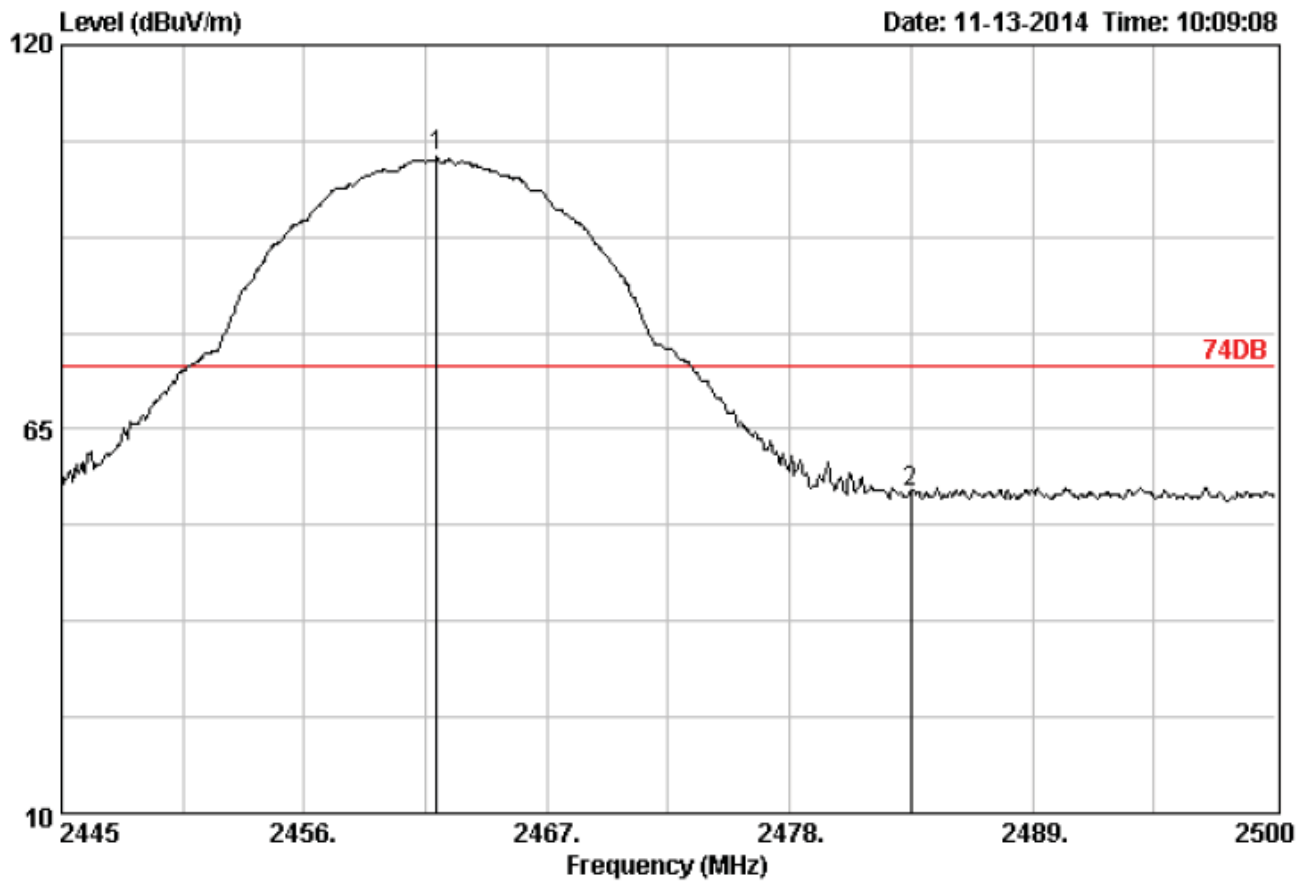

Site no. : 3m Chamber Data no. : 839  
 Dis. / Ant. : 3m DRH-118 Ant. pol. : VERTICAL  
 Limit : 74DB  
 Env. / Ins. : 23°C/54%  
 Engineer :  
 EUT :  
 Power :  
 M/N :  
 Test Mode :

	Freq. (MHz)	Ant. Factor (dB)	Cable Loss (dB)	Reading (dBuV)	Emission Level (dBuV/m)	Limits (dBuV/m)	Margin (dB)	Remark
1	2462.00	28.90	4.68	105.71	103.92	74.00	-29.92	Peak
2	2483.50	28.93	4.70	57.80	56.05	74.00	17.95	Peak



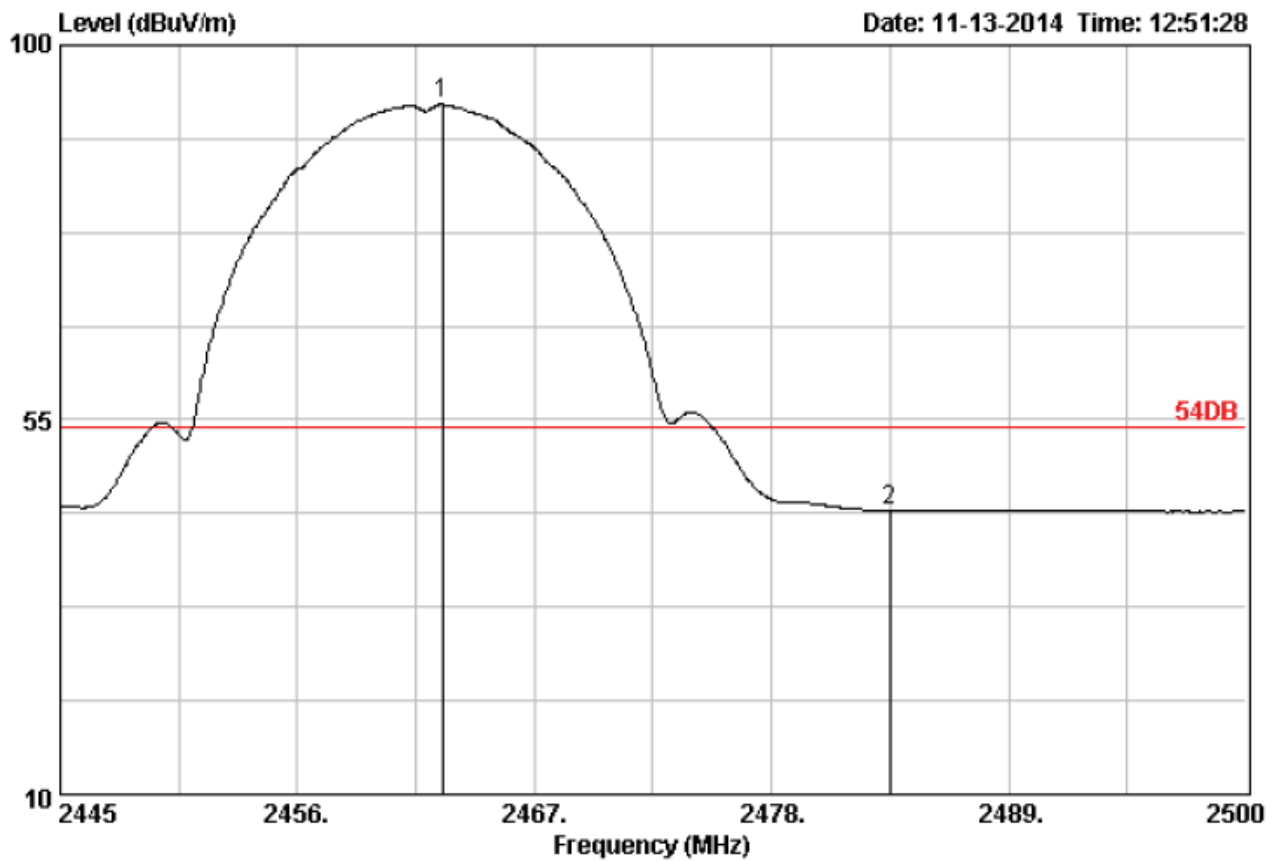

Site no. : 3m Chamber Data no. : 860  
 Dis. / Ant. : 3m DRH-118 Ant. pol. : VERTICAL  
 Limit : 54DB  
 Env. / Ins. : 23°C/54%  
 Engineer :  
 EUT :  
 Power :  
 M/N :  
 Test Mode :

	Freq. (MHz)	Ant.		Cable		Emission		Remark
		Factor (dB)	Loss (dB)	Reading (dBuV)	Level (dBuV/m)	Limits (dBuV/m)	Margin (dB)	
1	2462.71	28.90	4.68	94.70	92.91	54.00	-38.91	Average
2	2483.50	28.93	4.70	45.81	44.06	54.00	9.94	Average

Note : For 802.11g Mode:

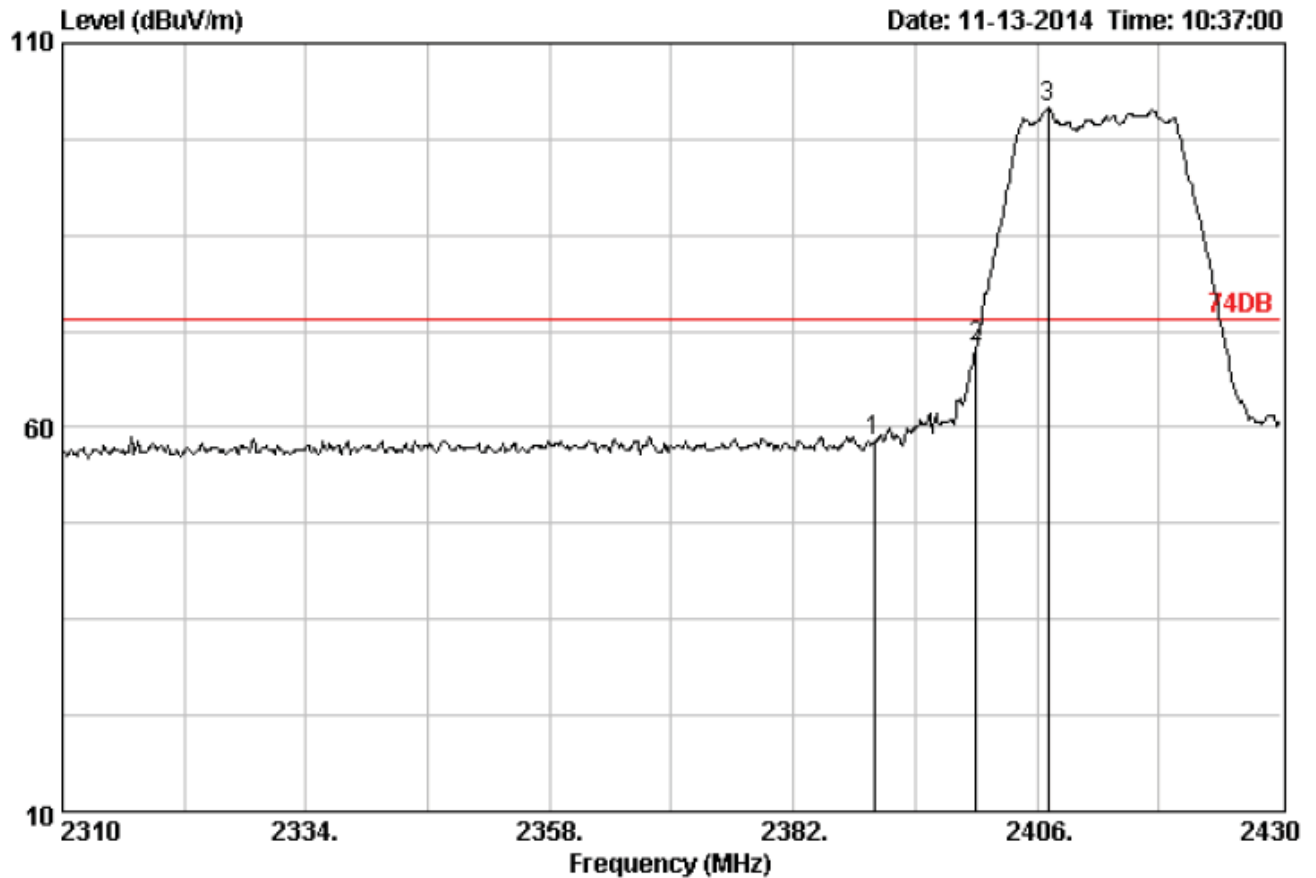

```

Site no.       : 3m Chamber                Data no. : 847
Dis. / Ant.   : 3m DRH-118              Ant. pol. : HORIZONTAL
Limit         : 74DB
Env. / Ins.   : 23*C/54%
Engineer      :
EUT           :
Power         :
M/N          :
Test Mode     :
    
```

	Freq. (MHz)	Ant. Factor (dB)	Cable Loss (dB)	Reading (dBUV)	Emission		Margin (dB)	Remark
					Level (dBUV/m)	Limits (dBUV/m)		
1	2390.00	28.78	4.61	60.23	58.26	74.00	15.74	Peak
2	2400.00	28.78	4.61	72.38	70.41	74.00	3.59	Peak
3	2407.08	28.81	4.63	103.45	101.53	74.00	-27.53	Peak

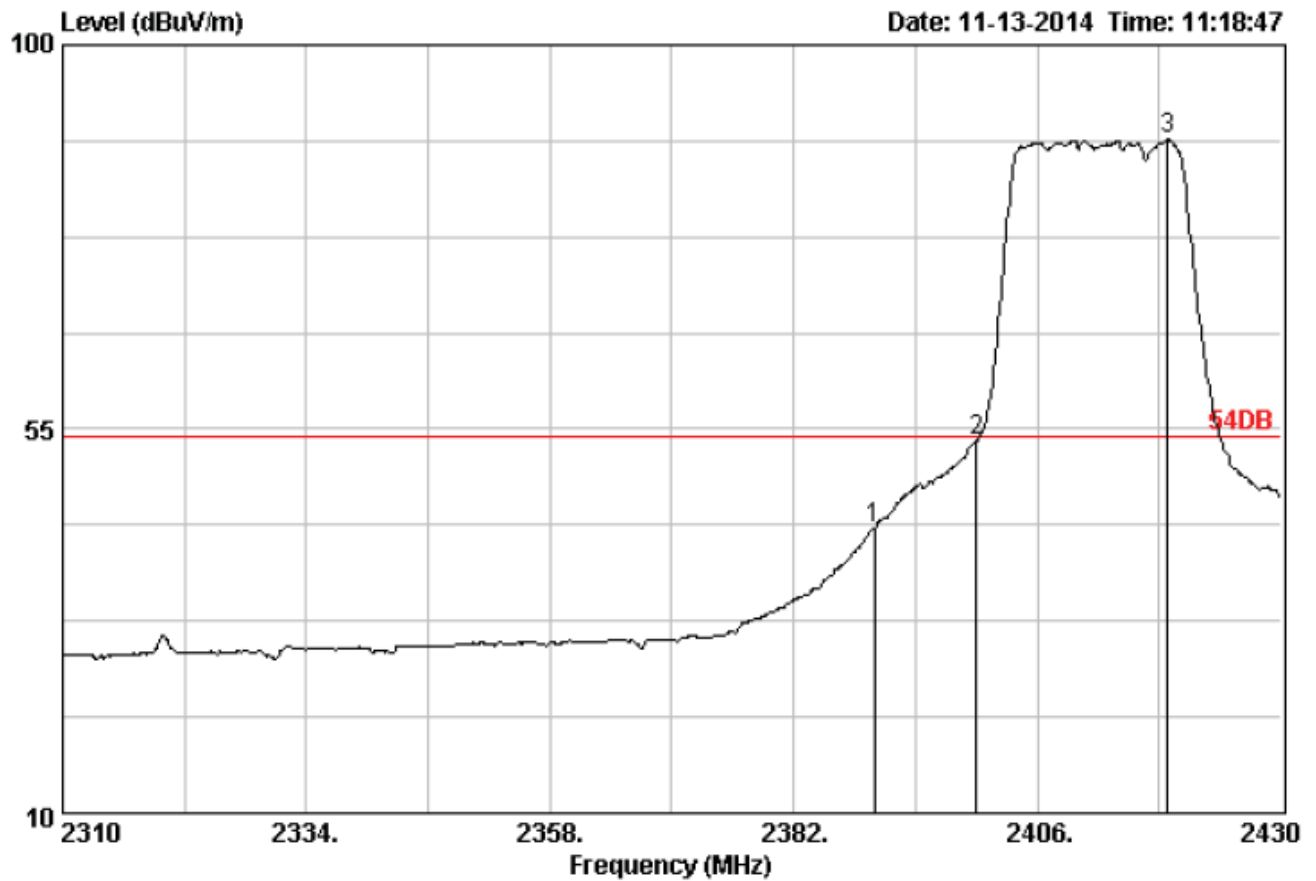

Site no. : 3m Chamber  
 Dis. / Ant. : 3m DRH-118  
 Limit : 54DB  
 Env. / Ins. : 23°C/54%  
 Engineer :  
 EUT :  
 Power :  
 M/N :  
 Test Mode :

Data no. : 852  
 Ant. pol. : HORIZONTAL

	Freq. (MHz)	Ant. Factor (dB)	Cable Loss (dB)	Reading (dBuV)	Emission			Remark
					Level (dBuV/m)	Limits (dBuV/m)	Margin (dB)	
1	2390.00	28.78	4.61	45.42	43.45	54.00	10.55	Average
2	2400.00	28.78	4.61	55.53	53.56	54.00	0.44	Average
3	2418.84	28.81	4.63	90.94	89.02	54.00	-35.02	Average

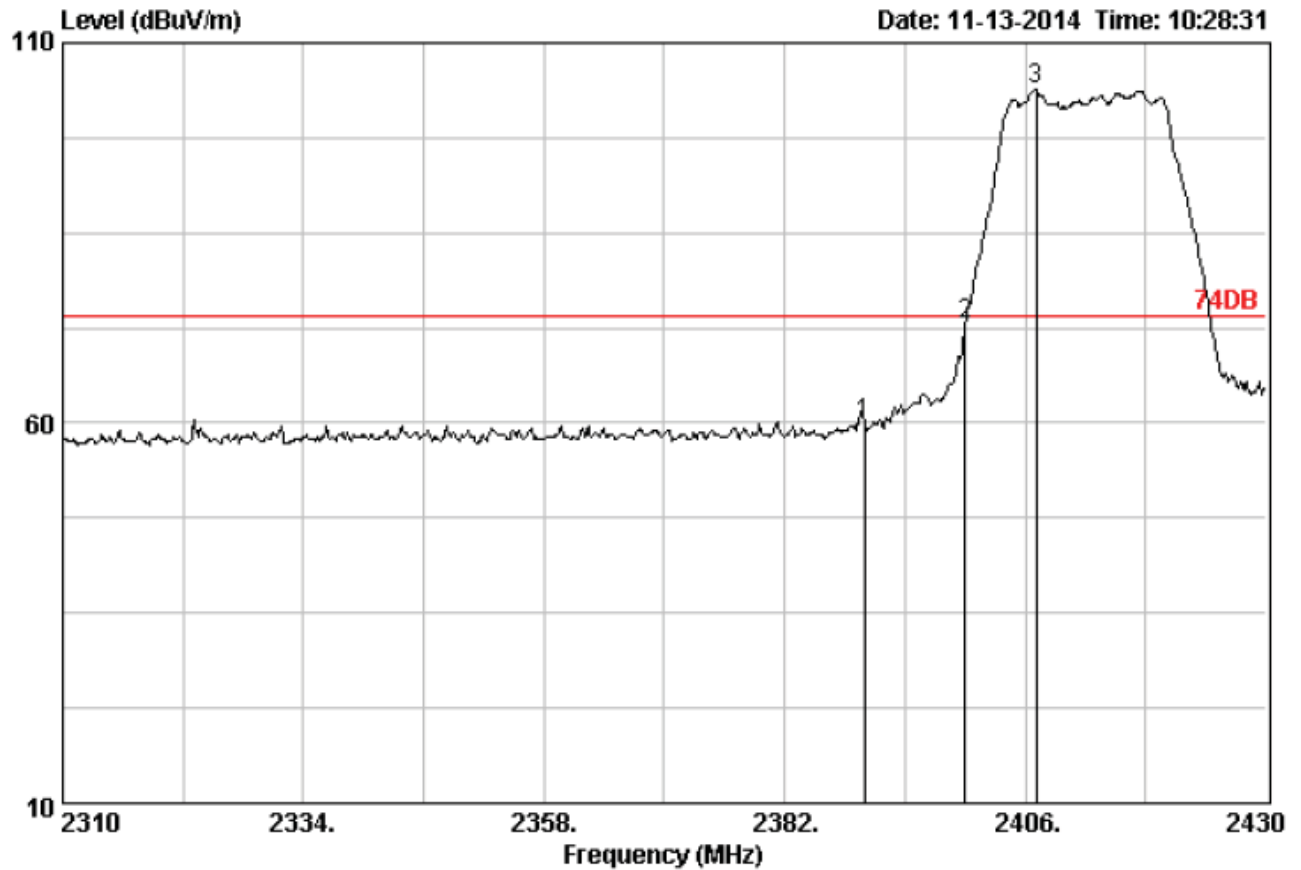

Site no. : 3m Chamber Data no. : 846  
 Dis. / Ant. : 3m DRH-118 Ant. pol. : VERTICAL  
 Limit : 74DB  
 Env. / Ins. : 23°C/54%  
 Engineer :  
 EUT :  
 Power :  
 M/N :  
 Test Mode :

	Freq. (MHz)	Ant. Factor (dB)	Cable Loss (dB)	Reading (dBuV)	Emission Level (dBuV/m)	Limits (dBuV/m)	Margin (dB)	Remark
1	2390.00	28.78	4.61	61.78	59.81	74.00	14.19	Peak
2	2400.00	28.78	4.61	74.91	72.94	74.00	1.06	Peak
3	2407.08	28.81	4.63	105.81	103.89	74.00	-29.89	Peak

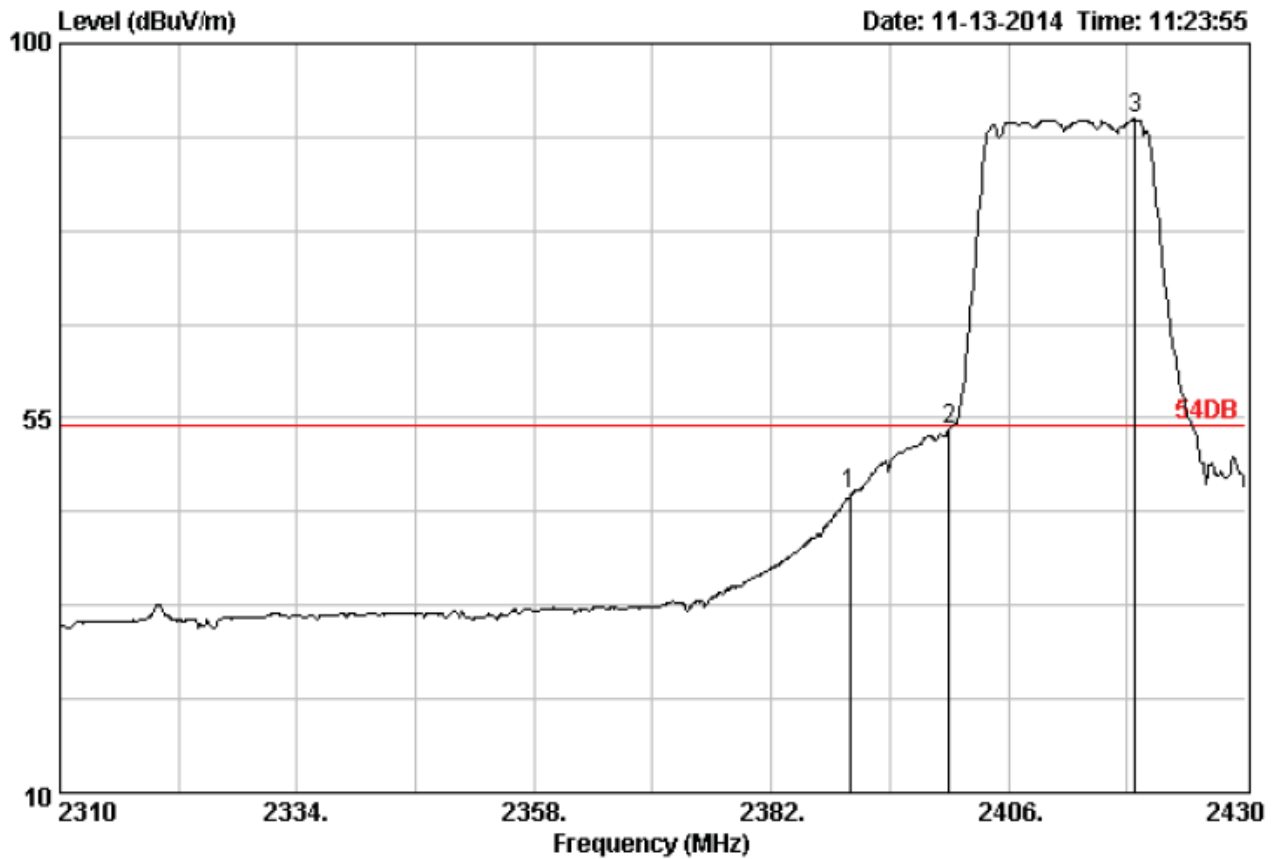

```

Site no.      : 3m Chamber           Data no. : 853
Dis. / Ant.  : 3m DRH-118          Ant. pol. : VERTICAL
Limit        : 54DB
Env. / Ins.  : 23*C/54%
Engineer     :
EUT          :
Power        :
M/N         :
Test Mode    :
    
```

	Freq. (MHz)	Ant. Factor (dB)	Cable Loss (dB)	Reading (dBuV)	Emission			Remark
					Level (dBuV/m)	Limits (dBuV/m)	Margin (dB)	
1	2390.00	28.78	4.61	47.72	45.75	54.00	8.25	Average
2	2400.00	28.78	4.61	55.66	53.69	54.00	0.31	Average
3	2418.84	28.81	4.63	92.96	91.04	54.00	-37.04	Average

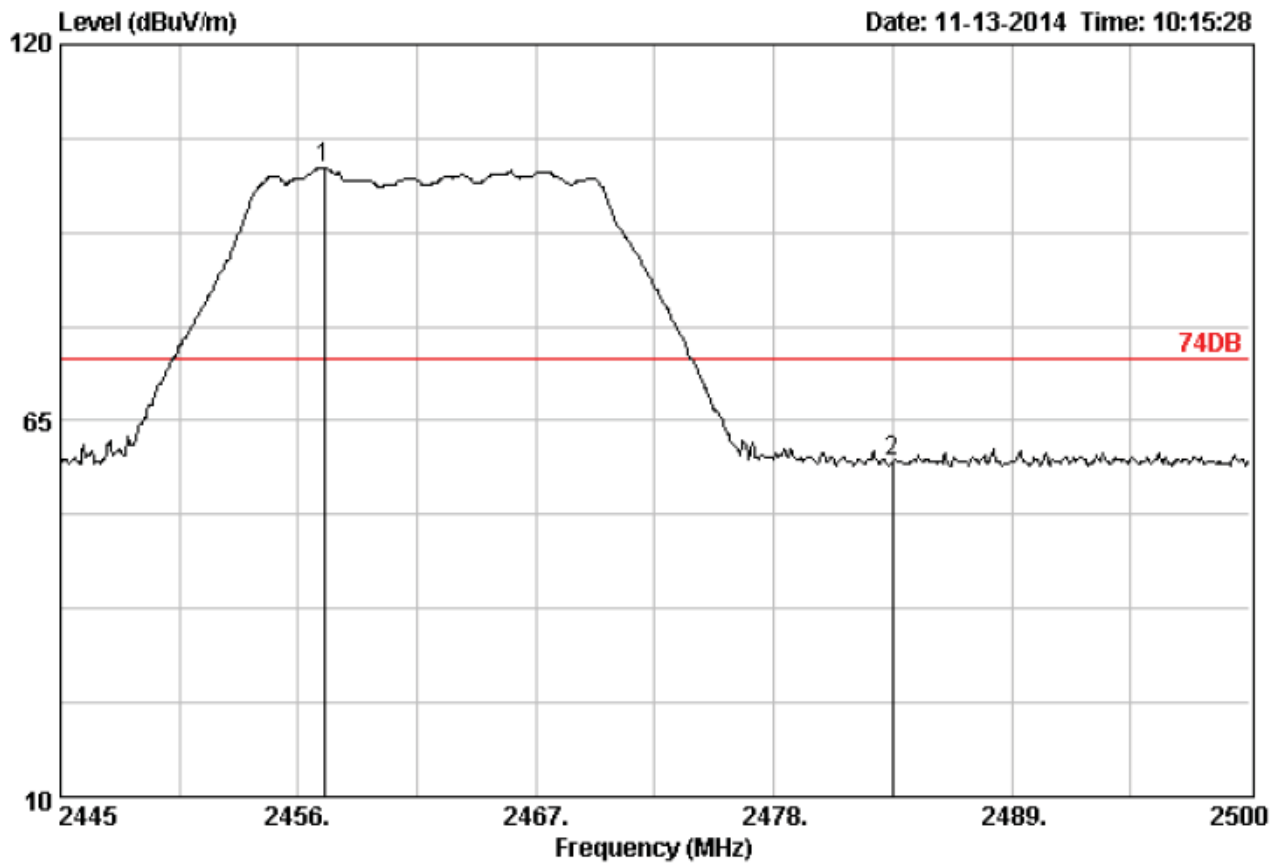

Site no. : 3m Chamber Data no. : 841  
 Dis. / Ant. : 3m DRH-118 Ant. pol. : HORIZONTAL  
 Limit : 74DB  
 Env. / Ins. : 23\*C/54%  
 Engineer :  
 EUT :  
 Power :  
 M/N :  
 Test Mode :

	Freq. (MHz)	Ant. Factor (dB)	Cable Loss (dB)	Reading (dBuV)	Emission Level (dBuV/m)	Limits (dBuV/m)	Margin (dB)	Remark
1	2457.21	28.90	4.68	103.73	101.94	74.00	-27.94	Peak
2	2483.50	28.93	4.70	60.74	58.99	74.00	15.01	Peak

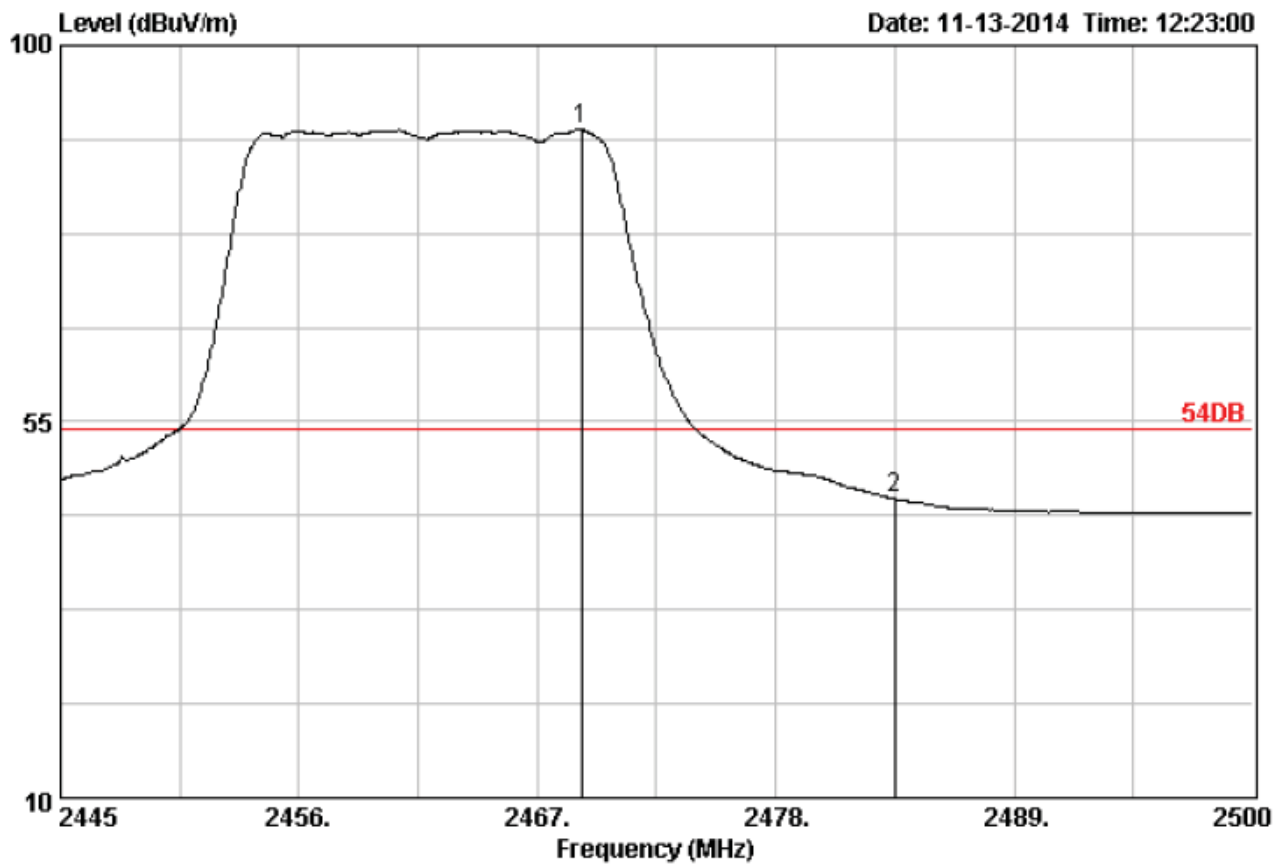

Site no. : 3m Chamber Data no. : 858  
 Dis. / Ant. : 3m DRH-118 Ant. pol. : HORIZONTAL  
 Limit : 54DB  
 Env. / Ins. : 23°C/54%  
 Engineer :  
 EUT :  
 Power :  
 M/N :  
 Test Mode :

	Freq. (MHz)	Ant. Factor (dB)	Cable Loss (dB)	Reading (dBuV)	Emission Level (dBuV/m)	Limits (dBuV/m)	Margin (dB)	Remark
1	2469.04	28.90	4.68	91.77	89.98	54.00	-35.98	Average
2	2483.50	28.93	4.70	47.52	45.77	54.00	8.23	Average

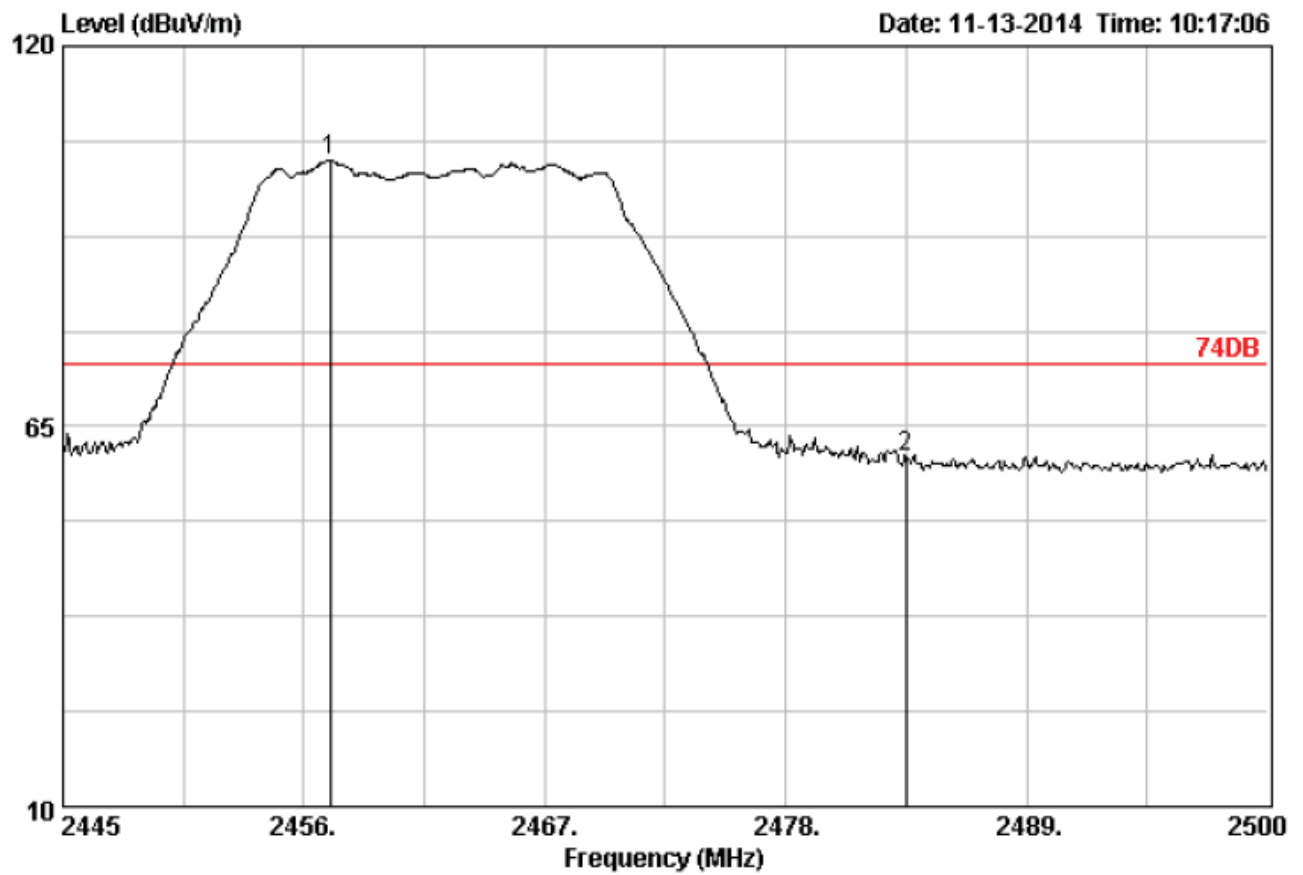

Site no. : 3m Chamber Data no. : 842  
 Dis. / Ant. : 3m DRH-118 Ant. pol. : VERTICAL  
 Limit : 74DB  
 Env. / Ins. : 23°C/54%  
 Engineer :  
 EUT :  
 Power :  
 M/N :  
 Test Mode :

	Freq. (MHz)	Ant. Factor (dB)	Cable Loss (dB)	Reading (dBuV)	Emission Level (dBuV/m)	Limits (dBuV/m)	Margin (dB)	Remark
1	2457.21	28.90	4.68	105.17	103.38	74.00	-29.38	Peak
2	2483.50	28.93	4.70	62.36	60.61	74.00	13.39	Peak



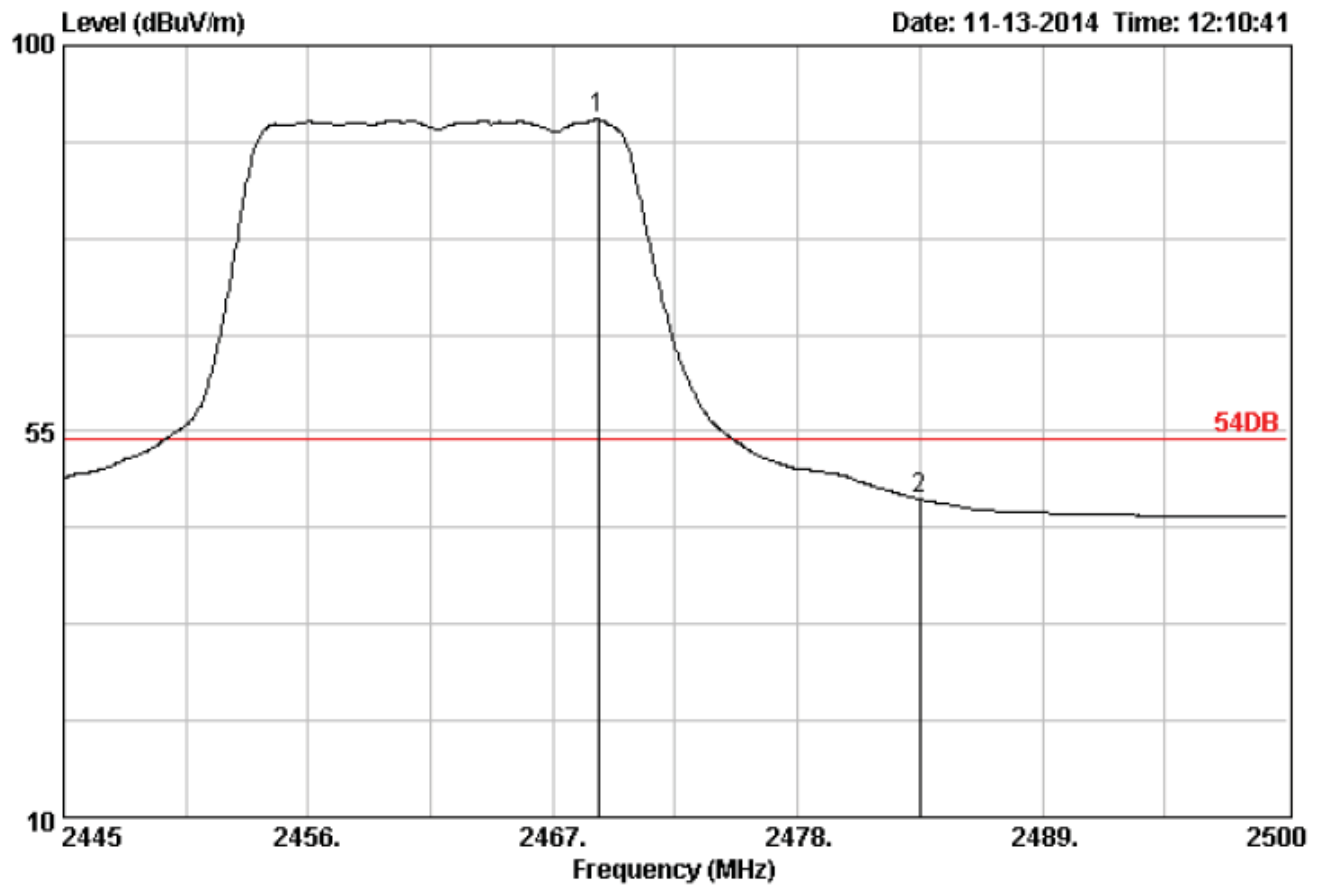

Site no. : 3m Chamber  
 Dis. / Ant. : 3m DRH-118  
 Limit : 54DB  
 Env. / Ins. : 23\*C/54%  
 Engineer :  
 EUT :  
 Power :  
 M/N :  
 Test Mode :  
 Data no. : 856  
 Ant. pol. : VERTICAL

	Freq. (MHz)	Ant. Factor (dB)	Cable Loss (dB)	Reading (dBuV)	Emission Level (dBuV/m)	Limits (dBuV/m)	Margin (dB)	Remark
1	2469.04	28.90	4.68	93.21	91.42	54.00	-37.42	Average
2	2483.50	28.93	4.70	48.82	47.07	54.00	6.93	Average

Note : For 802.11n (20MHz, KEEPING MIMO TX MODE) Mode:

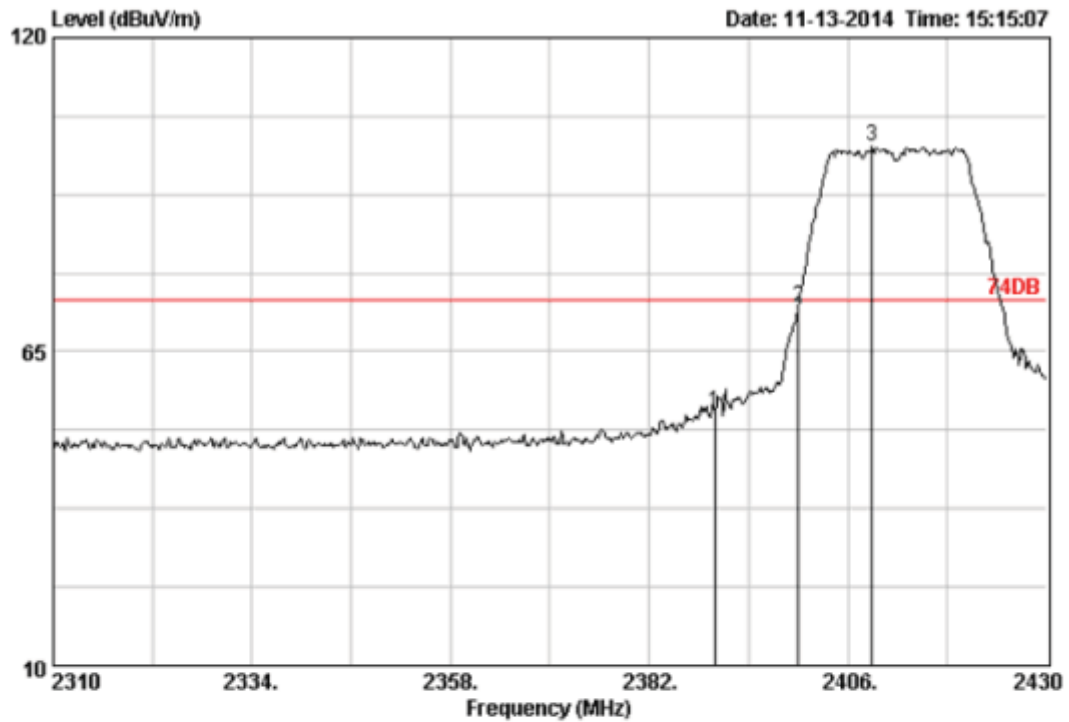

Date: 11-13-2014 Time: 15:15:07

Site no.	: 3m Chamber	Data no.	: 873
Dis. / Ant.	: 3m DRH-118	Ant. pol.	: HORIZONTAL
Limit	: 74DB		
Env. / Ins.	: 23°C/54%		
Engineer	:		
EUT	:		
Power	:		
M/N	:		
Test Mode	:		

	Freq. (MHz)	Ant. Factor (dB)	Cable Loss (dB)	Reading (dBUV)	Emission Level (dBUV/m)	Limits (dBUV/m)	Margin (dB)	Remark
1	2390.00	28.78	4.61	56.25	54.28	74.00	19.72	Peak
2	2400.00	28.78	4.61	74.88	72.91	74.00	1.09	Peak
3	2408.88	28.81	4.63	102.78	100.86	74.00	-26.86	Peak

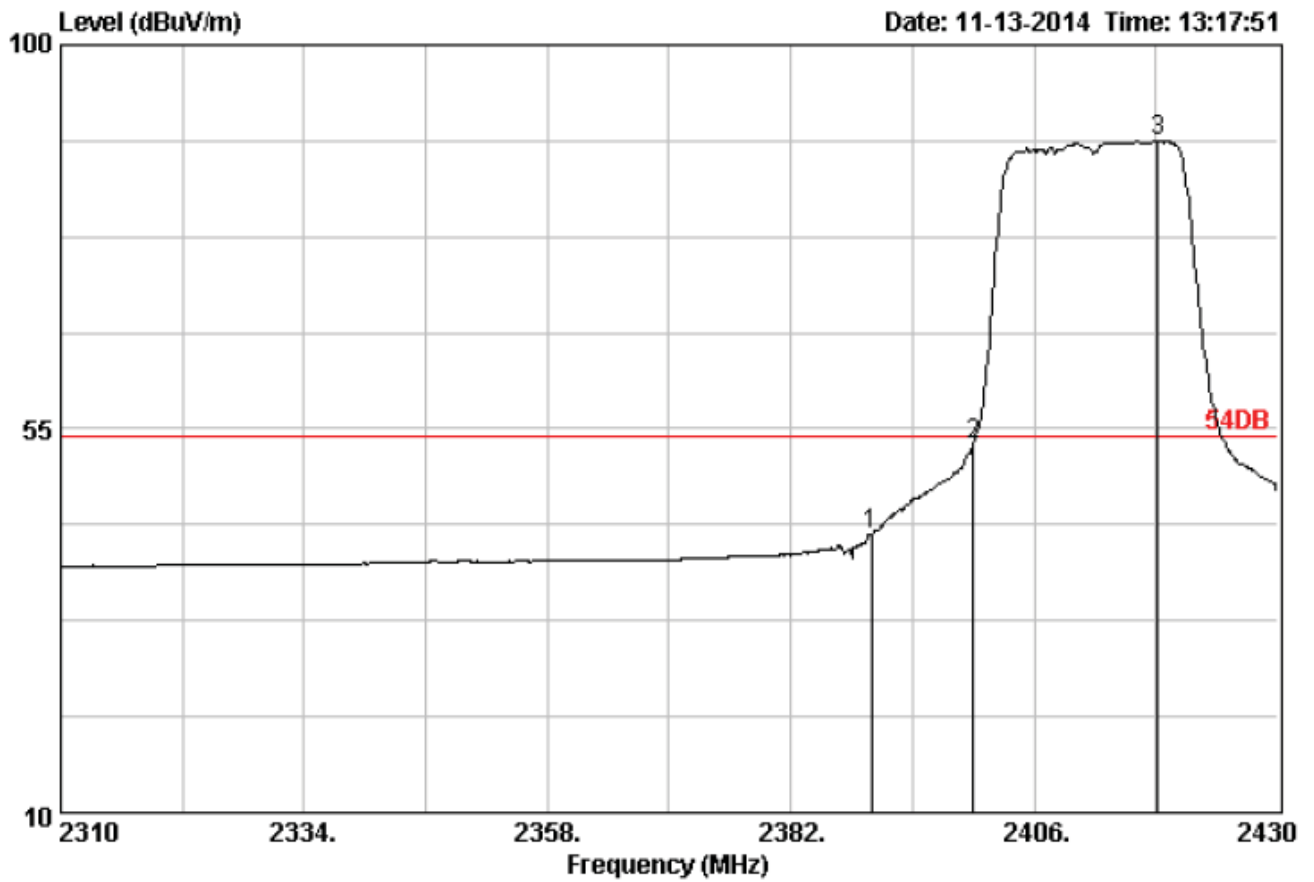

Site no. : 3m Chamber  
 Dis. / Ant. : 3m DRH-118  
 Limit : 54DB  
 Env. / Ins. : 23°C/54%  
 Engineer :  
 EUT :  
 Power :  
 M/N :  
 Test Mode :  
 Data no. : 864  
 Ant. pol. : HORIZONTAL

	Freq. (MHz)	Ant.		Cable		Emission		Remark
		Factor (dB)	Loss (dB)	Reading (dBuV)	Level (dBuV/m)	Limits (dBuV/m)	Margin (dB)	
1	2390.00	28.78	4.61	44.60	42.63	54.00	11.37	Average
2	2400.00	28.78	4.61	55.21	53.24	54.00	0.76	Average
3	2418.24	28.81	4.63	90.68	88.76	54.00	-34.76	Average

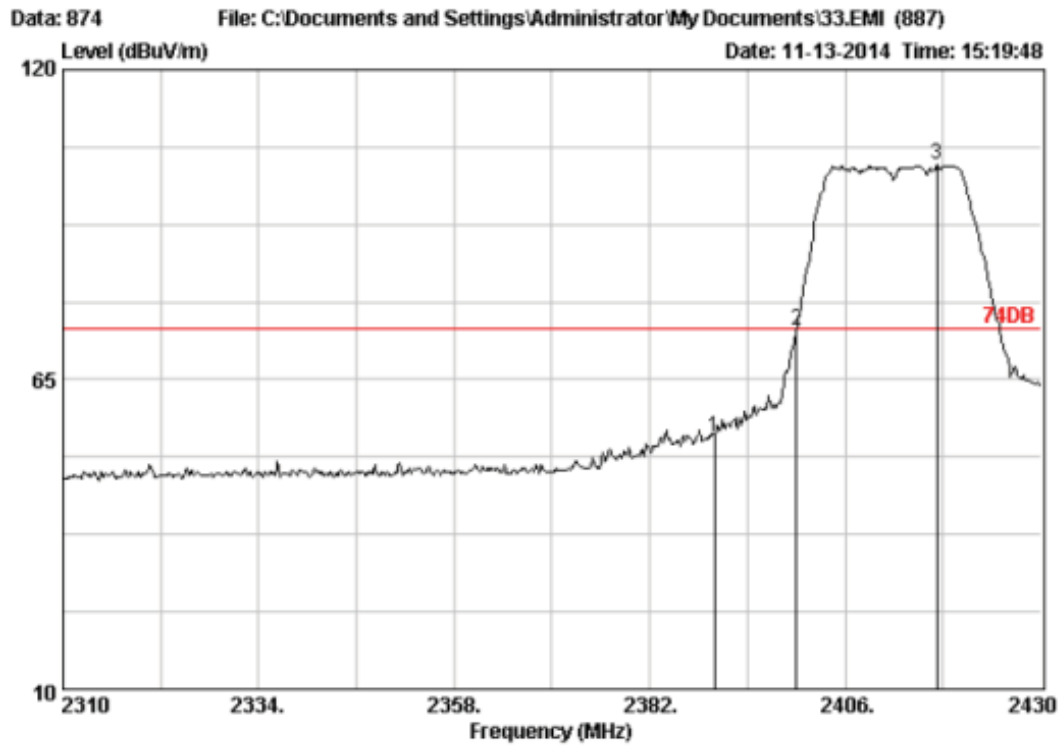

```

Site no.      : 3m Chamber           Data no. : 874
Dis. / Ant.  : 3m DRH-118          Ant. pol. : VERTICAL
Limit        : 74DB
Env. / Ins.  : 23°C/54%
Engineer     :
EUT          :
Power        :
M/N         :
Test Mode    :
    
```

	Freq. (MHz)	Ant. Factor (dB)	Cable Loss (dB)	Reading (dBuV)	Emission Level (dBuV/m)	Limits (dBuV/m)	Margin (dB)	Remark
1	2390.00	28.78	4.61	56.79	54.82	74.00	19.18	Peak
2	2400.00	28.78	4.61	75.73	73.76	74.00	0.24	Peak
3	2417.28	28.81	4.63	104.92	103.00	74.00	-29.00	Peak

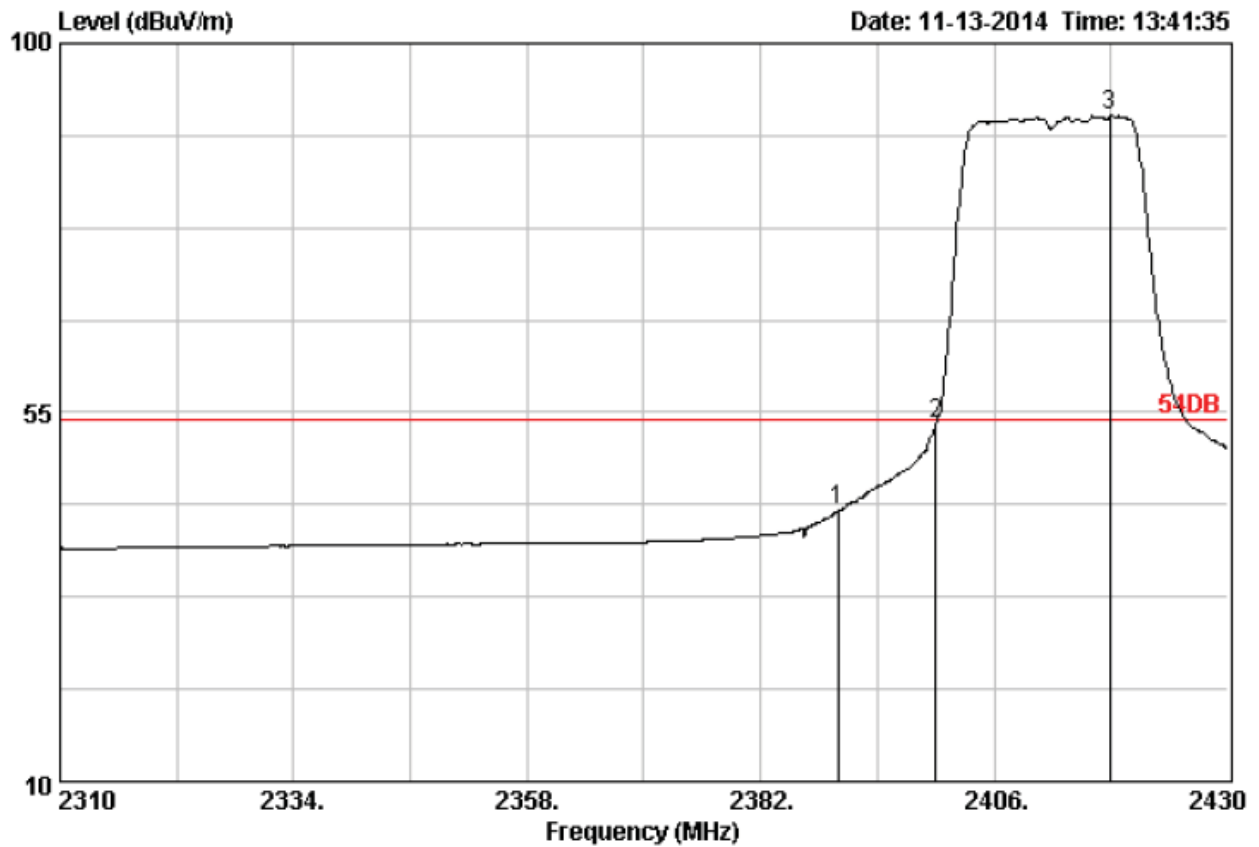

Site no. : 3m Chamber  
 Dis. / Ant. : 3m DRH-118  
 Limit : 54DB  
 Env. / Ins. : 23\*C/54%  
 Engineer :  
 EUT :  
 Power :  
 M/N :  
 Test Mode :

Data no. : 867  
 Ant. pol. : VERTICAL

	Freq. (MHz)	Ant. Factor (dB)	Cable Loss (dB)	Reading (dBuV)	Emission			Remark
					Level (dBuV/m)	Limits (dBuV/m)	Margin (dB)	
1	2390.00	28.78	4.61	45.02	43.05	54.00	10.95	Average
2	2400.00	28.78	4.61	55.53	53.56	54.00	0.44	Average
3	2417.88	28.81	4.63	93.09	91.17	54.00	-37.17	Average

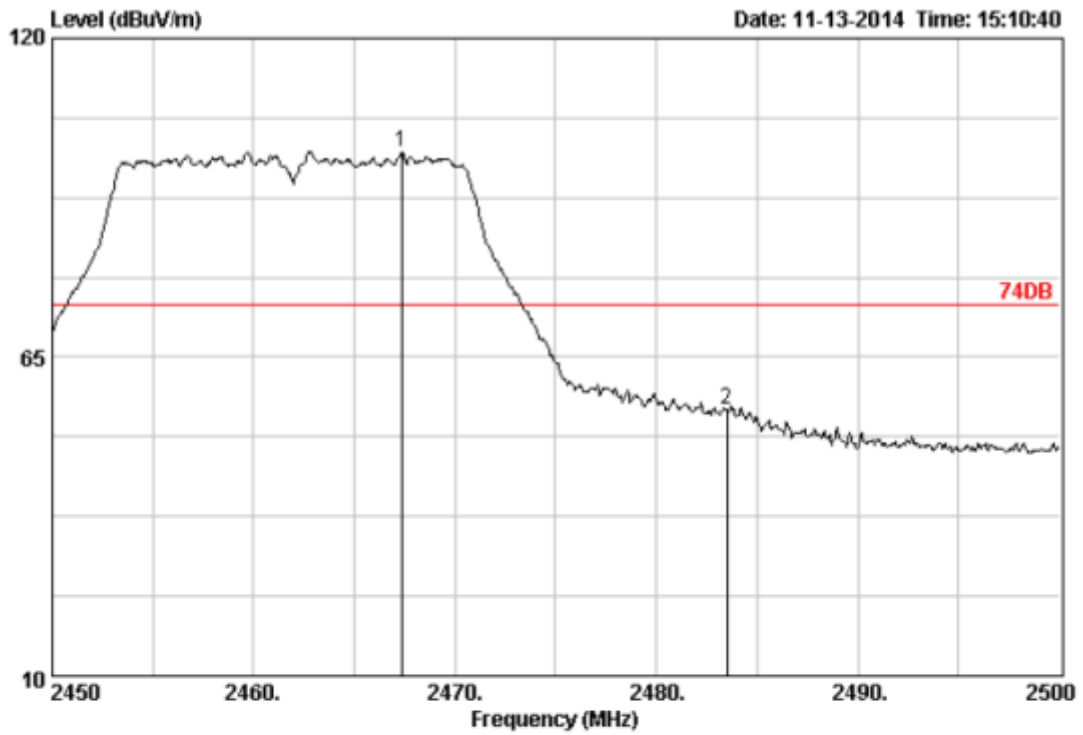

Site no. : 3m Chamber  
 Dis. / Ant. : 3m DRH-118  
 Limit : 74DB  
 Env. / Ins. : 23°C/54%  
 Engineer :  
 EUT :  
 Power :  
 M/N :  
 Test Mode :

Data no. : 871  
 Ant. pol. : HORIZONTAL

	Freq. (MHz)	Ant. Factor (dB)	Cable Loss (dB)	Reading (dBuV)	Emission Level (dBuV/m)	Limits (dBuV/m)	Margin (dB)	Remark
1	2467.35	28.90	4.68	102.25	100.46	74.00	-26.46	Peak
2	2483.50	28.93	4.70	57.56	55.81	74.00	18.19	Peak



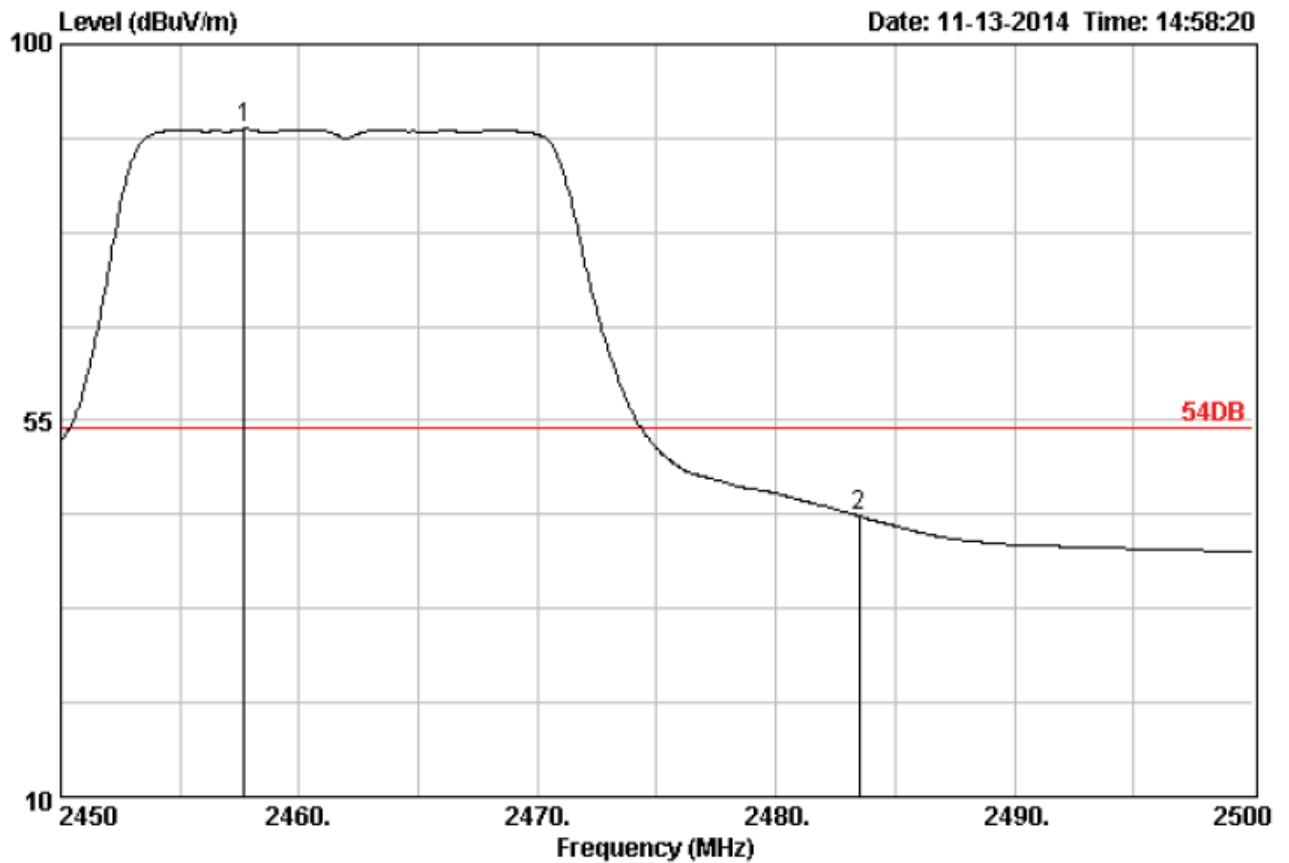

Site no. : 3m Chamber Data no. : 868  
 Dis. / Ant. : 3m DRH-118 Ant. pol. : HORIZONTAL  
 Limit : 54DB  
 Env. / Ins. : 23°C/54%  
 Engineer :  
 EUT :  
 Power :  
 M/N :  
 Test Mode :

	Ant.		Cable		Emission			Remark
	Freq. (MHz)	Factor (dB)	Loss (dB)	Reading (dBuV)	Level (dBuV/m)	Limits (dBuV/m)	Margin (dB)	
1	2457.70	28.90	4.68	91.71	89.92	54.00	-35.92	Average
2	2483.50	28.93	4.70	45.30	43.55	54.00	10.45	Average

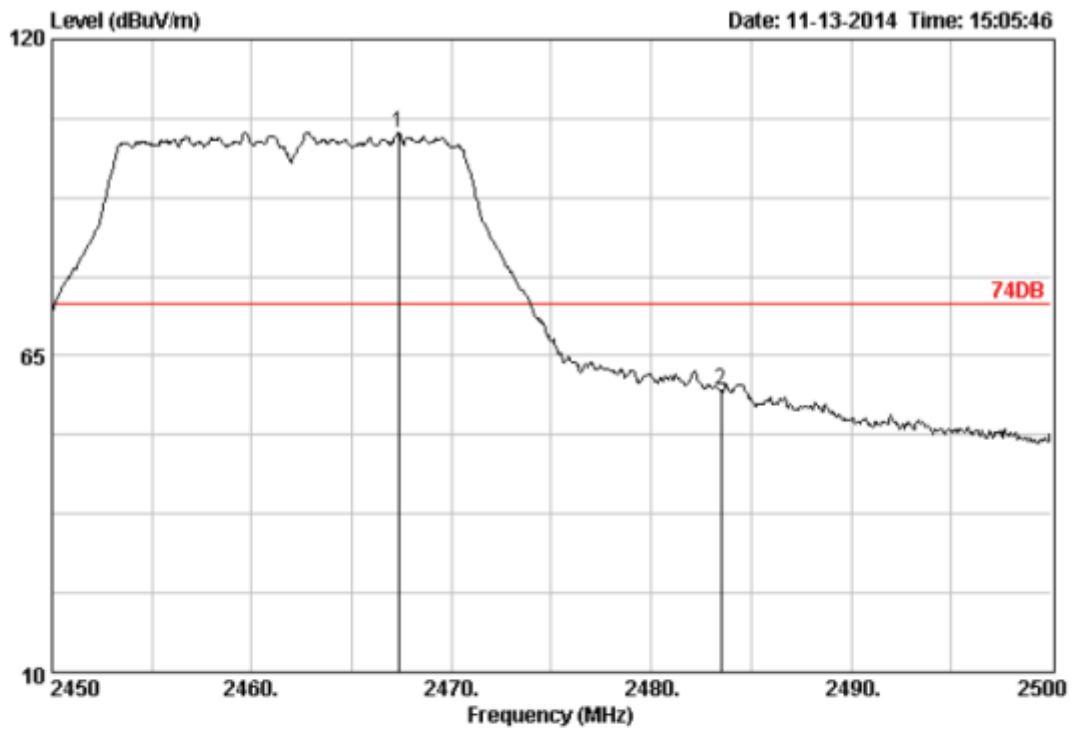

Site no. : 3m Chamber  
 Dis. / Ant. : 3m DRH-118  
 Limit : 74DB  
 Env. / Ins. : 23°C/54%  
 Engineer :  
 EUT :  
 Power :  
 M/N :  
 Test Mode :  
 Data no. : 870  
 Ant. pol. : VERTICAL

	Freq. (MHz)	Ant. Factor (dB)	Cable Loss (dB)	Reading (dBuV)	Emission Level (dBuV/m)	Limits (dBuV/m)	Margin (dB)	Remark
1	2467.35	28.90	4.68	105.68	103.89	74.00	-29.89	Peak
2	2483.50	28.93	4.70	60.65	58.90	74.00	15.10	Peak





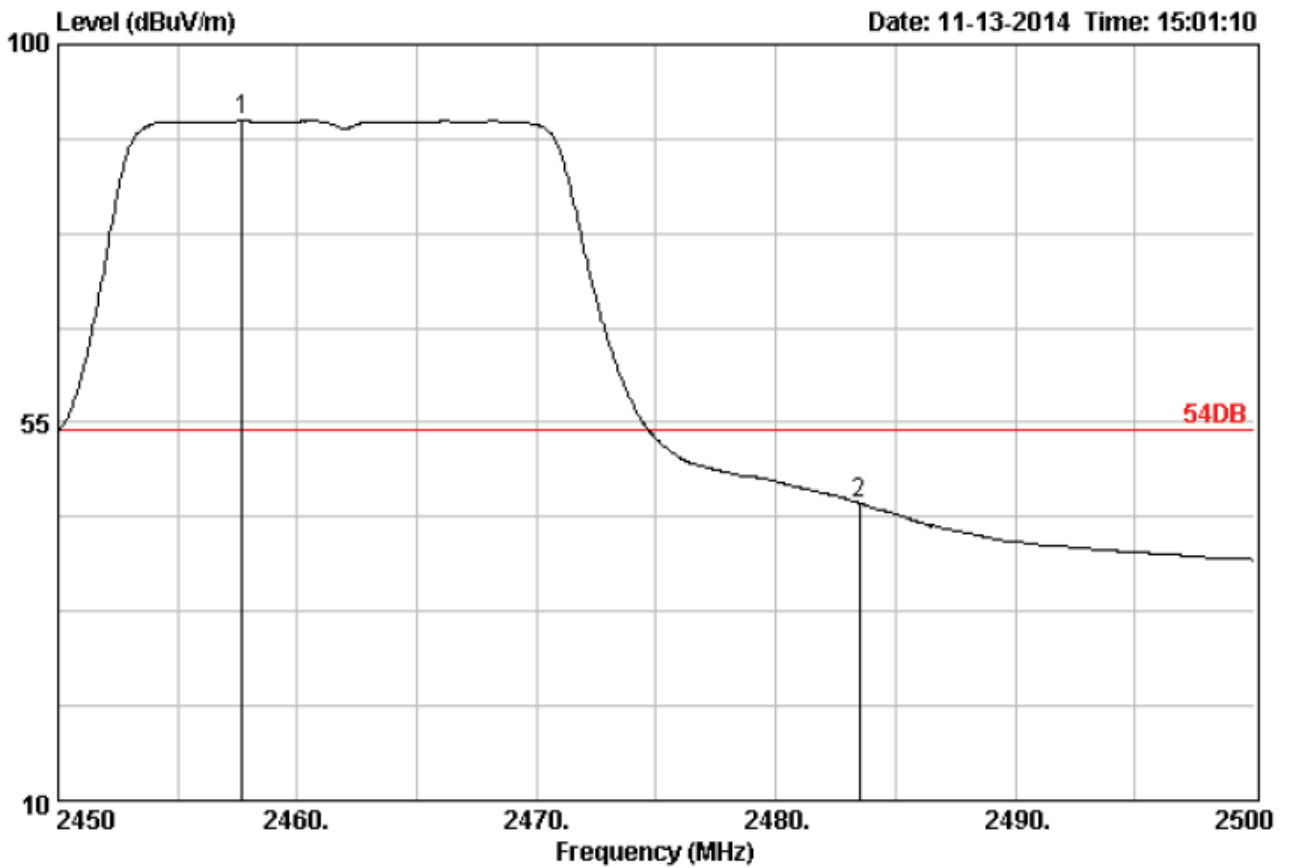

Site no. : 3m Chamber Data no. : 869  
 Dis. / Ant. : 3m DRH-118 Ant. pol. : VERTICAL  
 Limit : 54DB  
 Env. / Ins. : 23\*C/54%  
 Engineer :  
 EUT :  
 Power :  
 M/N :  
 Test Mode :

	Freq. (MHz)	Ant. Factor (dB)	Cable Loss (dB)	Emission Reading (dBuV)	Emission Level (dBuV/m)	Limits (dBuV/m)	Margin (dB)	Remark
1	2457.70	28.90	4.68	92.84	91.05	54.00	-37.05	Average
2	2483.50	28.93	4.70	47.14	45.39	54.00	8.61	Average

Note : For 802.11n (40MHz, KEEPING MIMO TX MODE) Mode:

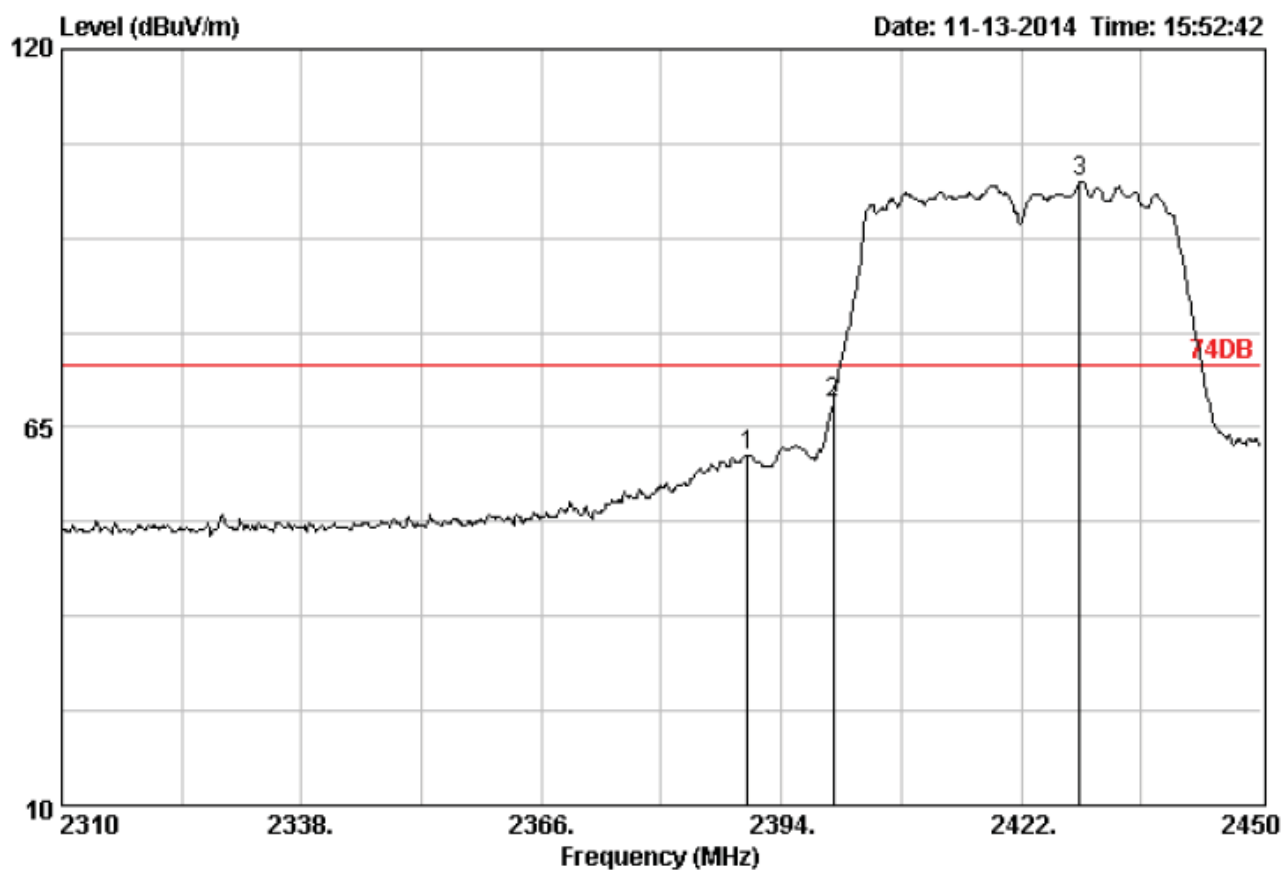

```
Site no.       : 3m Chamber           Data no.  : 877
Dis. / Ant.   : 3m DRH-118          Ant. pol. : HORIZONTAL
Limit        : 74DB
Env. / Ins.   : 23*C/54%
Engineer     :
EUT          :
Power        :
M/N         :
Test Mode    :
```

	Freq.	Ant.	Cable	Emission		Margin	Remark	
	(MHz)	Factor	Loss	Reading	Level	Limits		
		(dB)	(dB)	(dBuV)	(dBuV/m)	(dBuV/m)	(dB)	
1	2390.00	28.78	4.61	62.69	60.72	74.00	13.28	Peak
2	2400.00	28.78	4.61	70.55	68.58	74.00	5.42	Peak
3	2428.86	28.84	4.64	102.46	100.58	74.00	-26.58	Peak

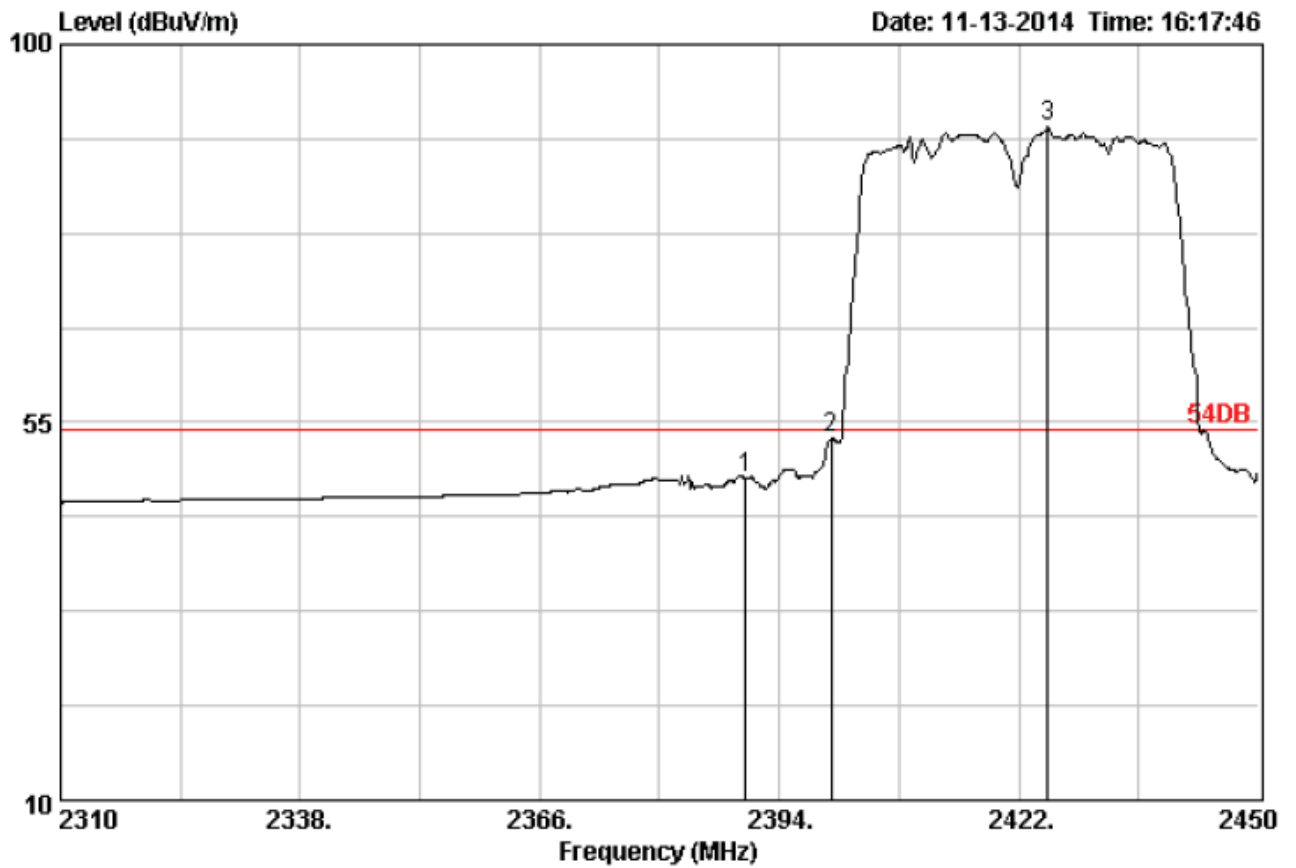

Site no. : 3m Chamber Data no. : 882  
 Dis. / Ant. : 3m DRH-118 Ant. pol. : HORIZONTAL  
 Limit : 54DB  
 Env. / Ins. : 23°C/54%  
 Engineer :  
 EUT :  
 Power :  
 M/N :  
 Test Mode :

	Freq. (MHz)	Ant. Factor (dB)	Cable Loss (dB)	Emission Reading (dBuV)	Emission Level (dBuV/m)	Limits (dBuV/m)	Margin (dB)	Remark
1	2390.00	28.78	4.61	50.34	48.37	54.00	5.63	Average
2	2400.00	28.78	4.61	55.01	53.04	54.00	0.96	Average
3	2425.36	28.84	4.64	92.07	90.19	54.00	-36.19	Average

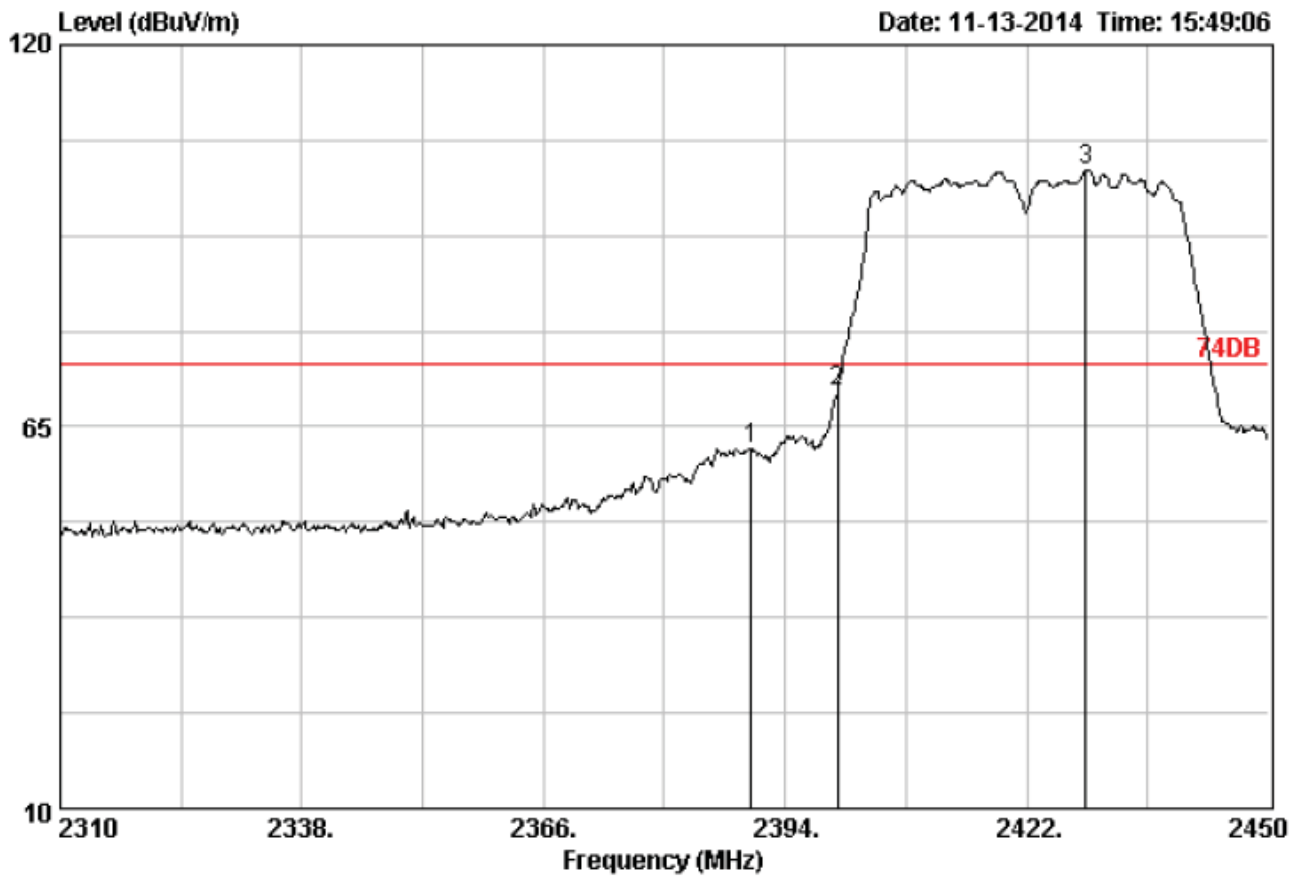

Site no. : 3m Chamber Data no. : 876  
 Dis. / Ant. : 3m DRH-118 Ant. pol. : VERTICAL  
 Limit : 74DB  
 Env. / Ins. : 23\*C/54%  
 Engineer :  
 EUT :  
 Power :  
 M/N :  
 Test Mode :

	Freq. (MHz)	Ant. Factor (dB)	Cable Loss (dB)	Reading (dBuV)	Emission			Remark
					Level (dBuV/m)	Limits (dBuV/m)	Margin (dB)	
1	2390.00	28.78	4.61	63.74	61.77	74.00	12.23	Peak
2	2400.00	28.78	4.61	72.17	70.20	74.00	3.80	Peak
3	2428.86	28.84	4.64	103.89	102.01	74.00	-28.01	Peak

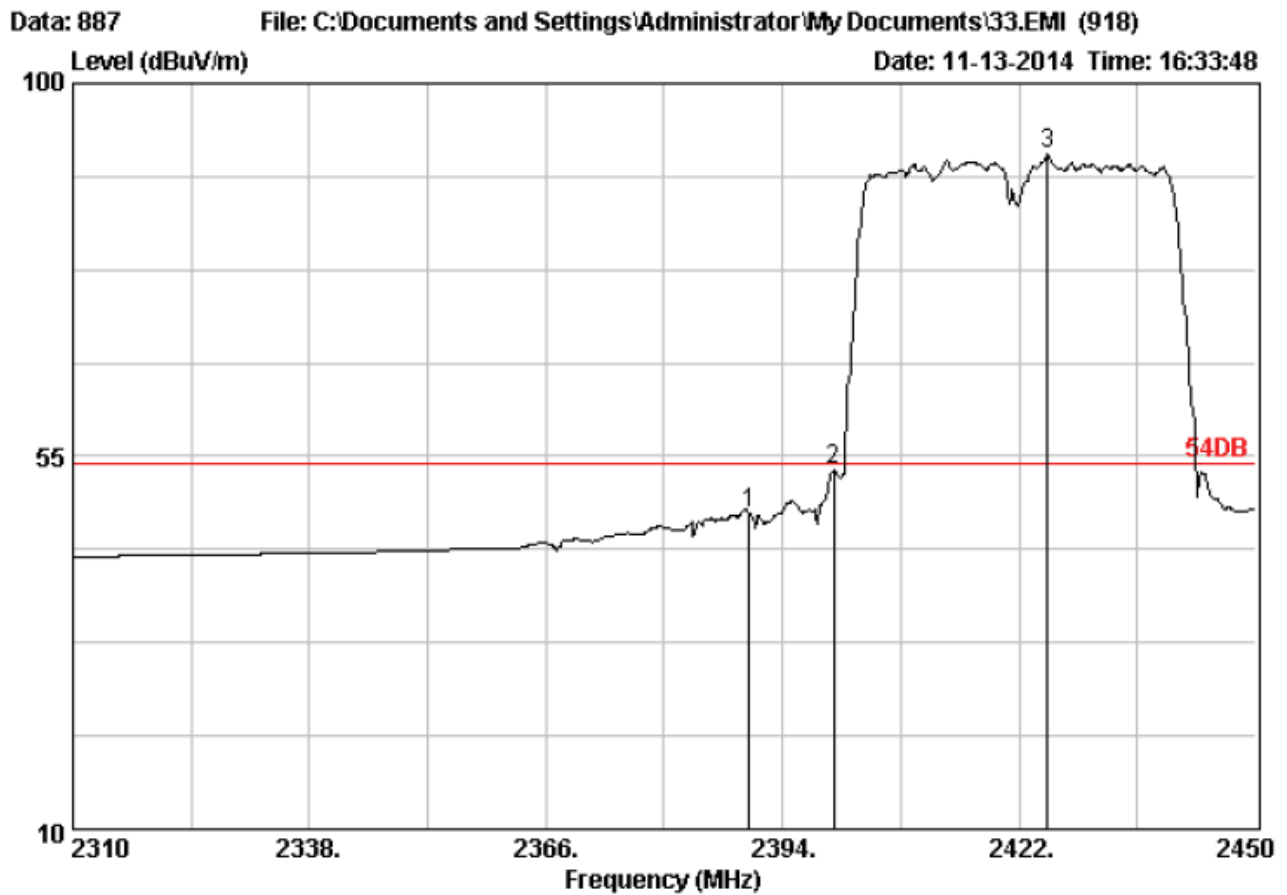

```

Site no.      : 3m Chamber           Data no. : 887
Dis. / Ant.   : 3m DRH-118         Ant. pol. : VERTICAL
Limit        : 54DB
Env. / Ins.   : 23*C/54%
Engineer     :
EUT          :
Power        :
M/N         :
Test Mode    :
    
```

	Ant.		Cable		Emission			Remark
	Freq. (MHz)	Factor (dB)	Loss (dB)	Reading (dBuV)	Level (dBuV/m)	Limits (dBuV/m)	Margin (dB)	
1	2390.00	28.78	4.61	50.18	48.21	54.00	5.79	Average
2	2400.00	28.78	4.61	55.22	53.25	54.00	0.75	Average
3	2425.36	28.84	4.64	93.42	91.54	54.00	-37.54	Average

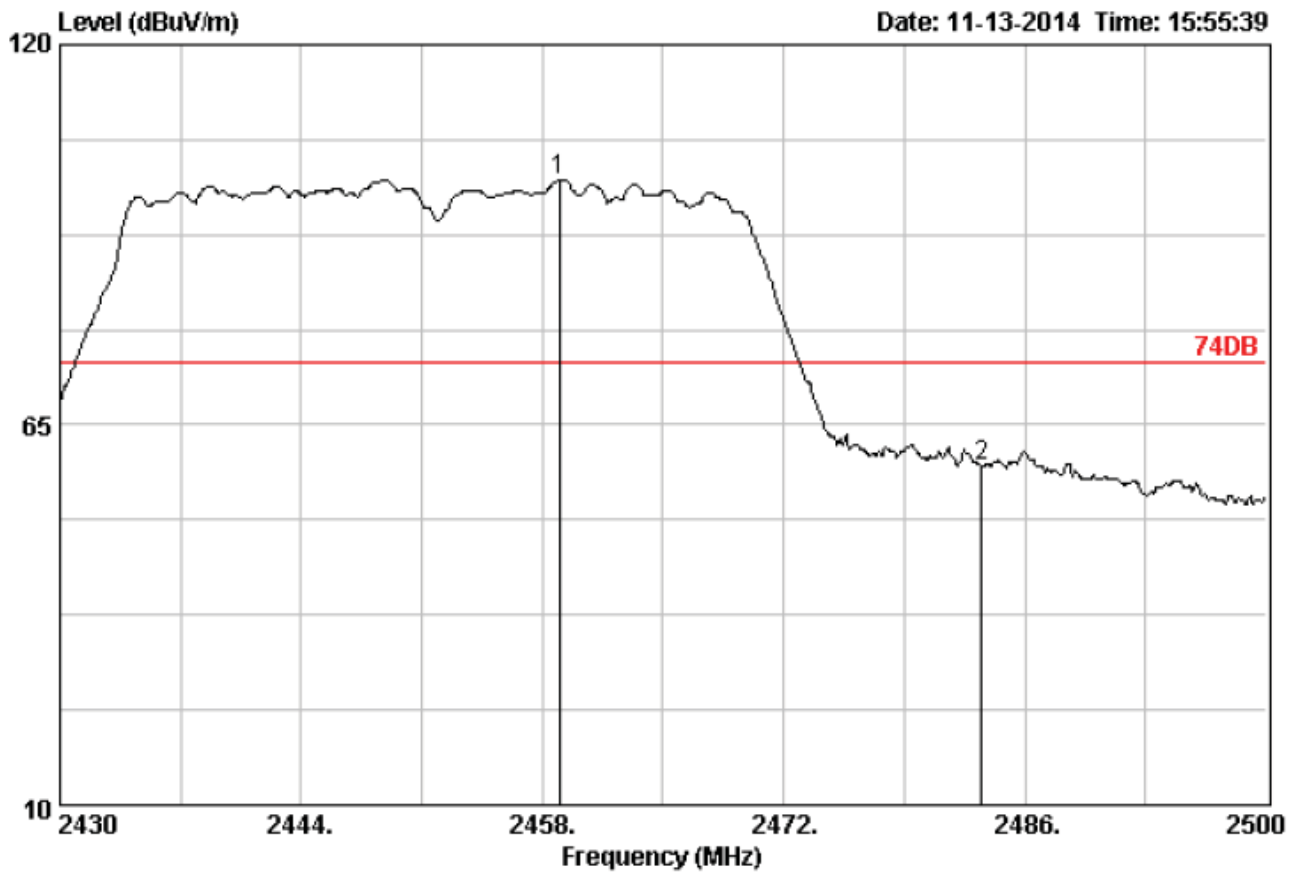

Site no. : 3m Chamber Data no. : 878  
 Dis. / Ant. : 3m DRH-118 Ant. pol. : HORIZONTAL  
 Limit : 74DB  
 Env. / Ins. : 23°C/54%  
 Engineer :  
 EUT :  
 Power :  
 M/N :  
 Test Mode :

	Freq. (MHz)	Ant. Factor (dB)	Cable Loss (dB)	Emission				Remark
				Reading (dBuV)	Level (dBuV/m)	Limits (dBuV/m)	Margin (dB)	
1	2458.98	28.90	4.68	102.28	100.49	74.00	-26.49	Peak
2	2483.50	28.93	4.70	60.75	59.00	74.00	15.00	Peak

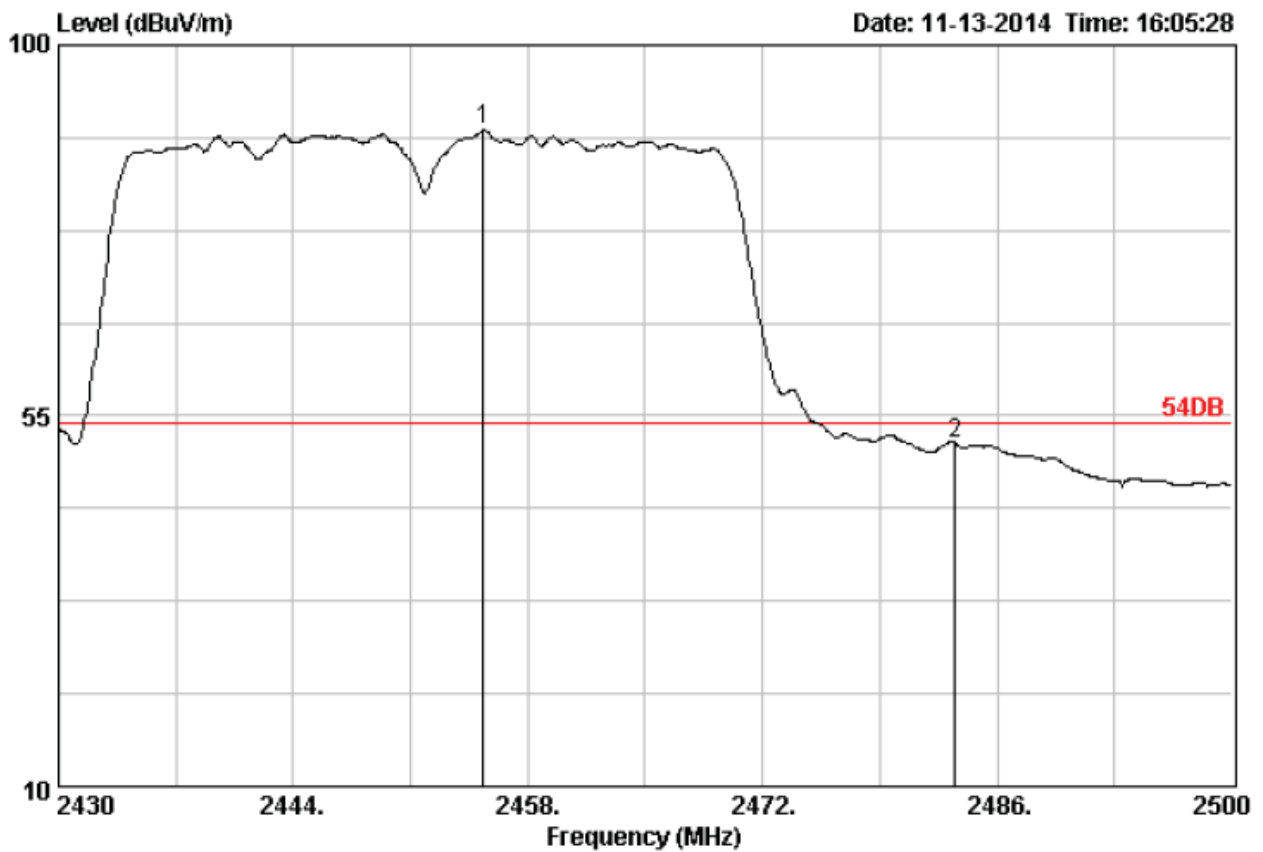

Site no. : 3m Chamber Data no. : 880  
 Dis. / Ant. : 3m DRH-118 Ant. pol. : HORIZONTAL  
 Limit : 54DB  
 Env. / Ins. : 23\*C/54%  
 Engineer :  
 EUT :  
 Power :  
 M/N :  
 Test Mode :

	Freq. (MHz)	Ant. Factor (dB)	Cable Loss (dB)	Reading (dBuV)	Emission Level (dBuV/m)	Limits (dBuV/m)	Margin (dB)	Remark
1	2455.34	28.90	4.68	91.46	89.67	54.00	-35.67	Average
2	2483.50	28.93	4.70	53.39	51.64	54.00	2.36	Average

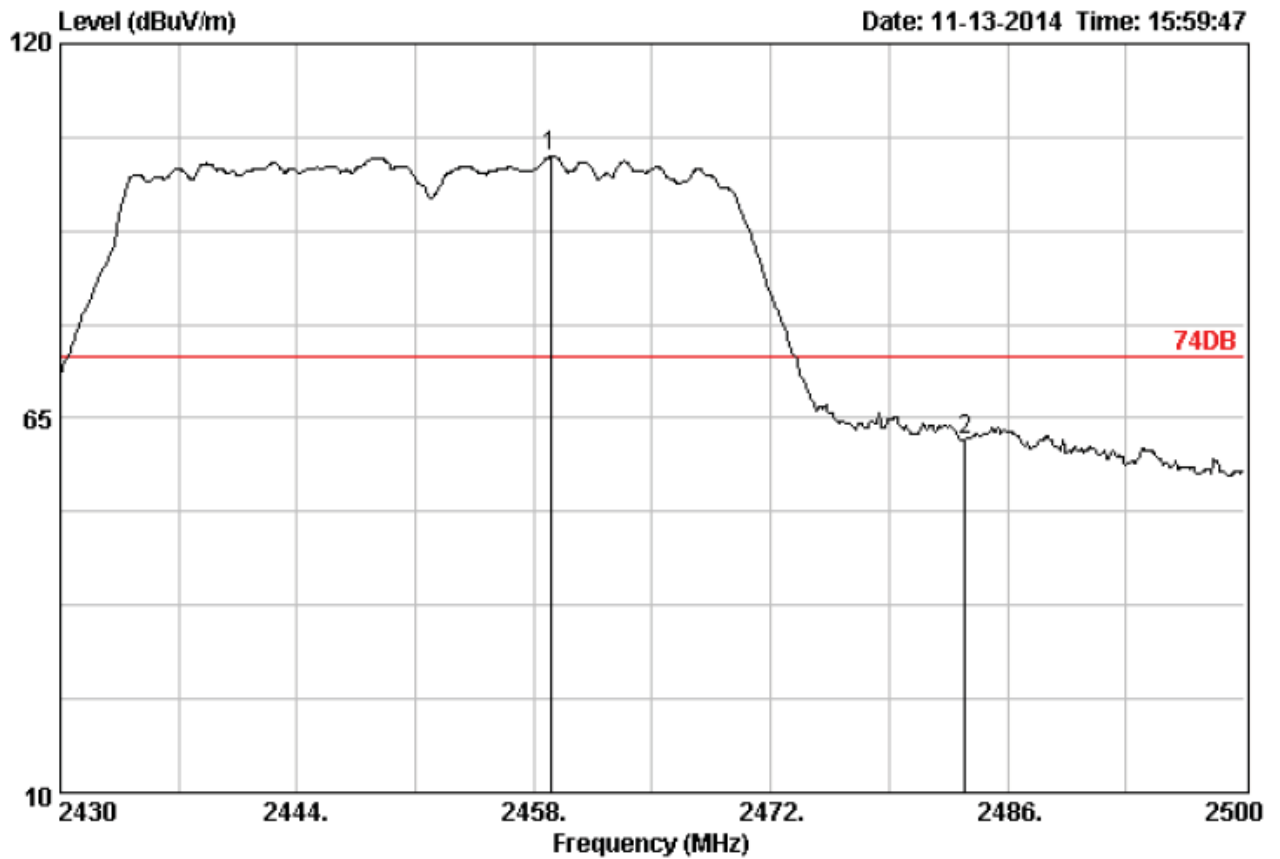

Site no. : 3m Chamber Data no. : 879  
 Dis. / Ant. : 3m DRH-118 Ant. pol. : VERTICAL  
 Limit : 74DB  
 Env. / Ins. : 23\*C/54%  
 Engineer :  
 EUT :  
 Power :  
 M/N :  
 Test Mode :

	Freq. (MHz)	Ant. Factor (dB)	Cable Loss (dB)	Reading (dBuV)	Emission		Margin (dB)	Remark
					Level (dBuV/m)	Limits (dBuV/m)		
1	2458.98	28.90	4.68	105.19	103.40	74.00	-29.40	Peak
2	2483.50	28.93	4.70	63.68	61.93	74.00	12.07	Peak



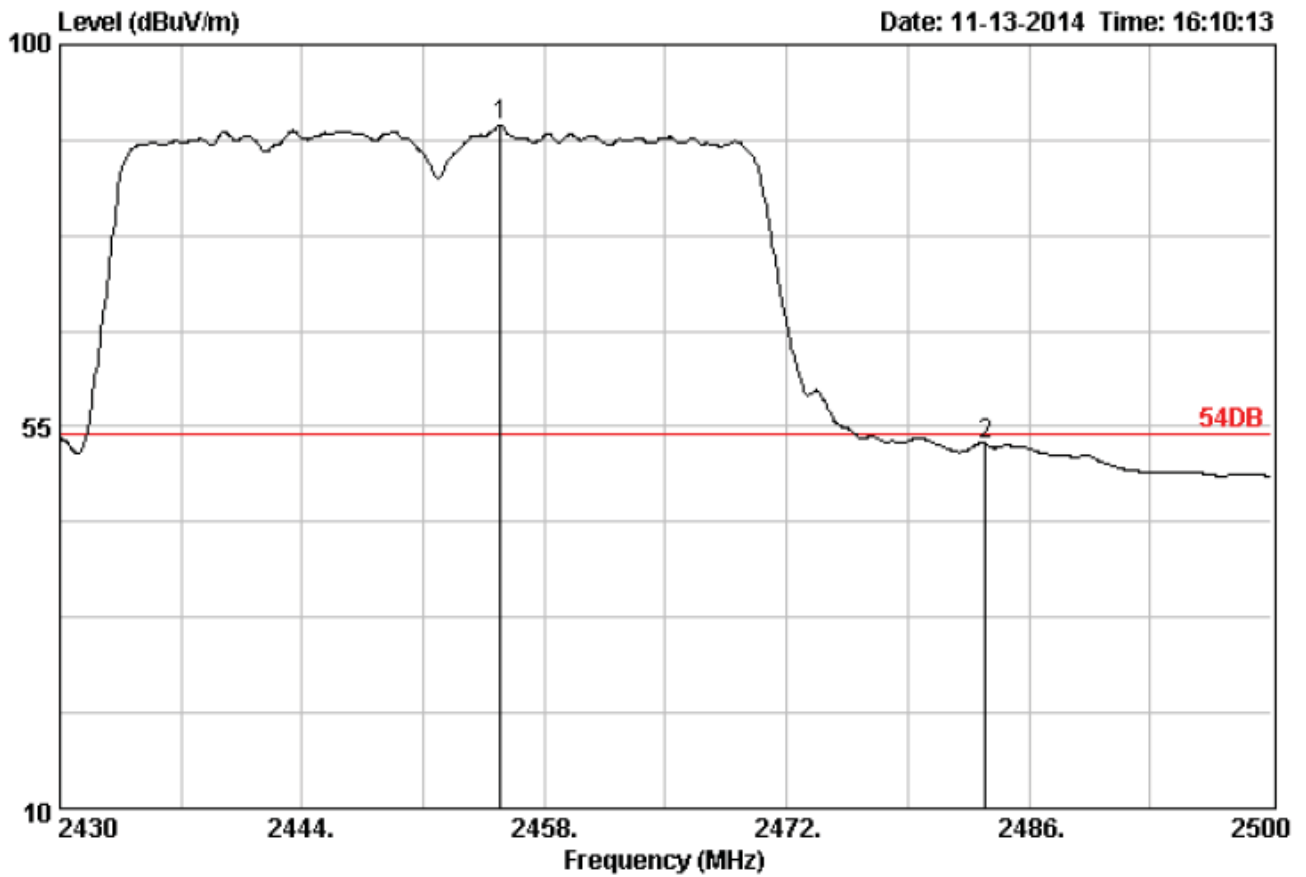

Site no. : 3m Chamber Data no. : 881  
 Dis. / Ant. : 3m DRH-118 Ant. pol. : VERTICAL  
 Limit : 54DB  
 Env. / Ins. : 23°C/54%  
 Engineer :  
 EUT :  
 Power :  
 M/N :  
 Test Mode :

	Freq. (MHz)	Ant. Factor (dB)	Cable Loss (dB)	Reading (dBuV)	Emission Level (dBuV/m)	Limits (dBuV/m)	Margin (dB)	Remark
1	2455.48	28.90	4.68	92.34	90.55	54.00	-36.55	Average
2	2483.50	28.93	4.70	54.67	52.92	54.00	1.08	Average

## 4.6. Power Spectral Density Measurement

### TEST CONFIGURATION

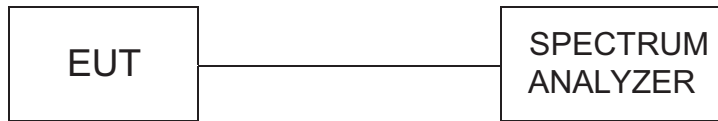

### TEST PROCEDURE

The EUT was tested according to KDB558074 D01 v03r02 for compliance to FCC 47CFR 15.247 requirements.

Set RBW= 3 kHz, VBW $\geq$ 10KHz, SPAN to 1.5 times greater than the EBW,.

### LIMIT

For digitally modulated systems, the power spectral density conducted from the intentional radiator to the antenna shall not be greater than 8 dBm in any 3 kHz band during any time interval of continuous transmission.

### TEST RESULTS

Channel	Channel Frequency (MHz)	PSD (dBm/3KHz)			Maximum limit (dBm/3KHz)	PASS / FAIL
		Ant1	Ant 2	Total		
1	2412	-8.391	-9.607	N/A	8	PASS
6	2437	-9.724	-9.251	N/A	8	PASS
11	2462	-9.070	-9.857	N/A	8	PASS
1	2412	-12.43	-13.17	N/A	8	PASS
6	2437	-12.72	-13.06	N/A	8	PASS
11	2462	-13.26	-12.97	N/A	8	PASS
1	2412	-13.96	-13.62	-10.78	8	PASS
6	2437	-13.77	-13.49	-10.62	8	PASS
11	2462	-13.68	-13.53	-10.59	8	PASS
3	2422	-16.12	-16.60	-13.34	8	PASS
6	2437	-17.13	-15.80	-13.40	8	PASS
9	2452	-16.45	-15.59	-12.99	8	PASS

For 802.11b Mode:

### CH1 @ANT 1

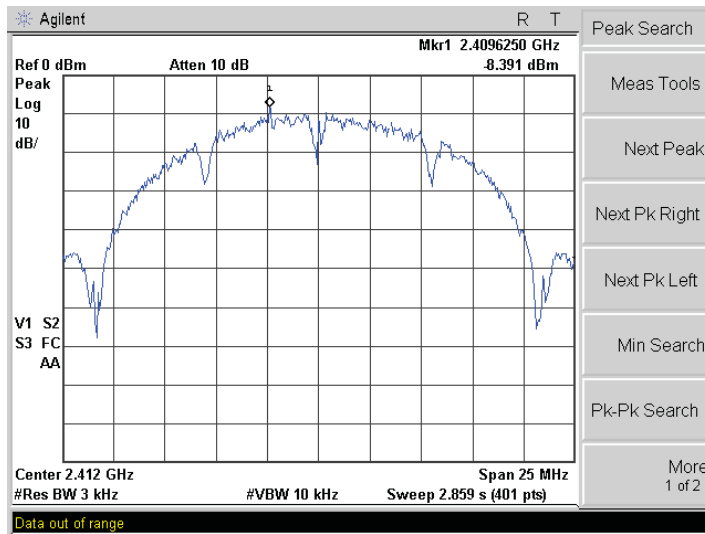

### CH1 @ANT 2

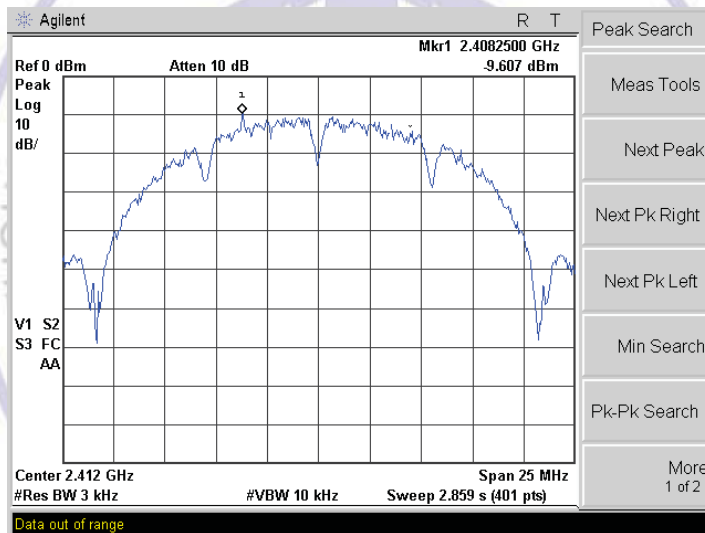

### CH6 @ANT 1

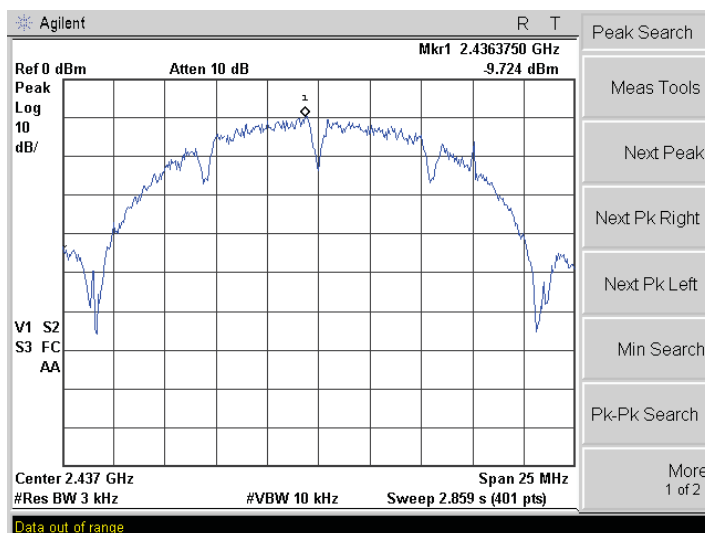

### CH6 @ANT 2

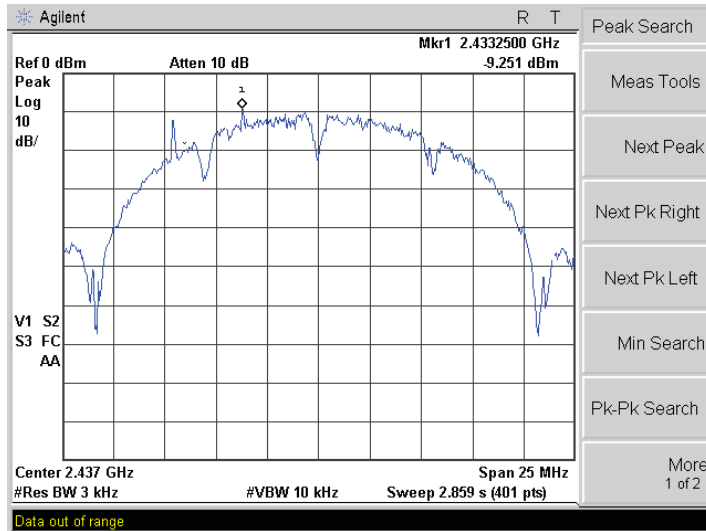

### CH11 @ANT 1

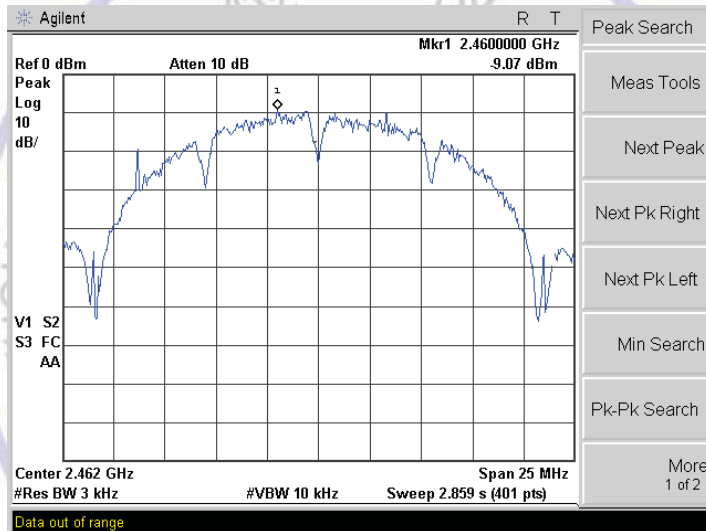

### CH11 @ANT 2

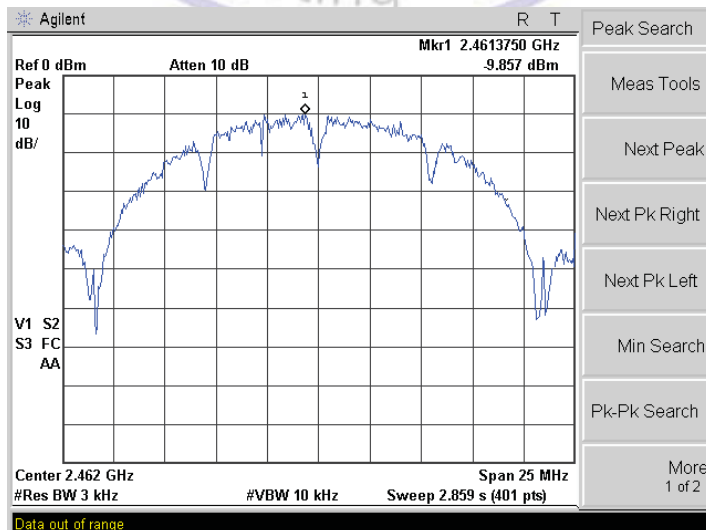

For 802.11g Mode:

### CH1 @ANT 1

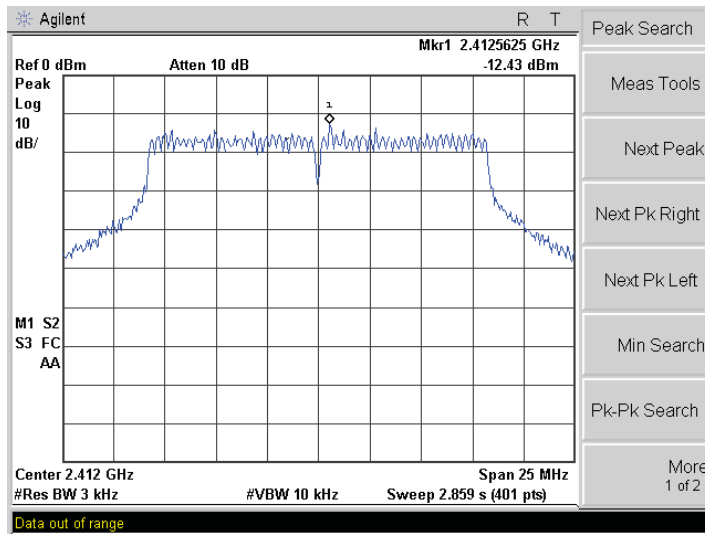

### CH1 @ANT 2

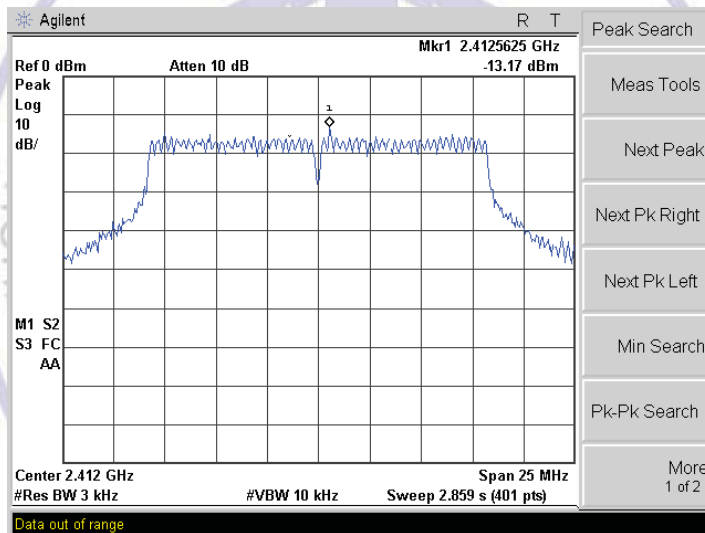

### CH6 @ANT 1

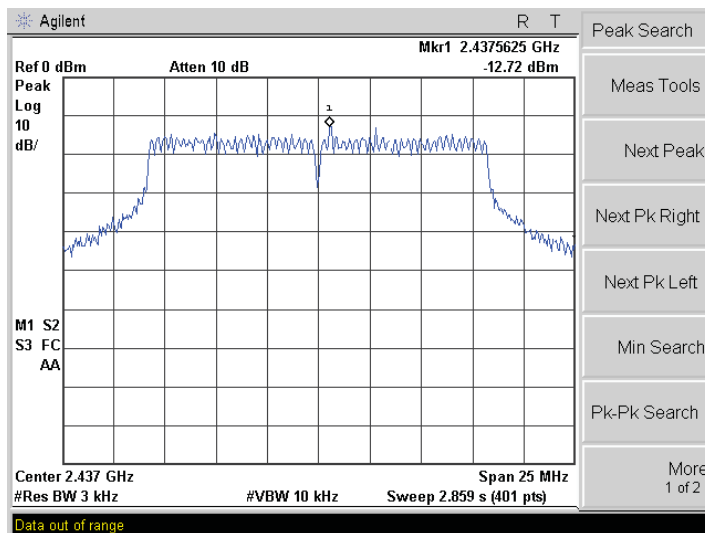

### CH6 @ANT 2

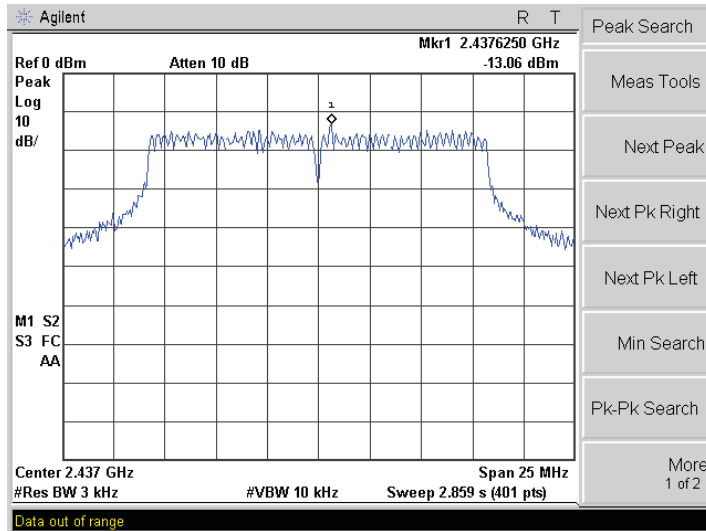

### CH11 @ANT 1

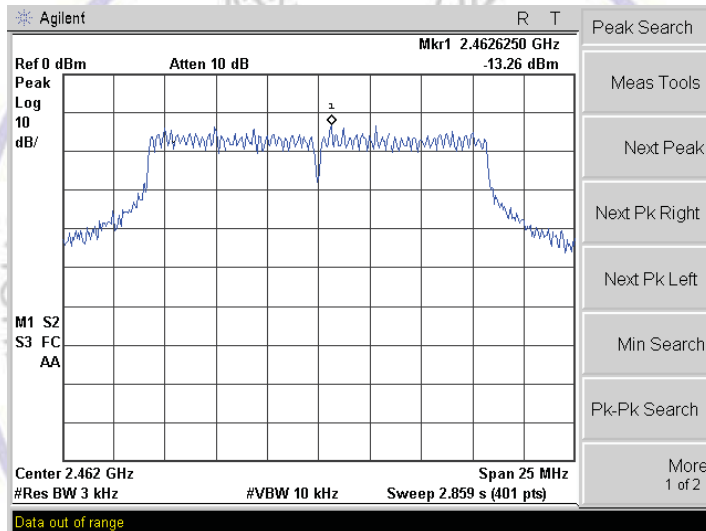

### CH11 @ANT 2

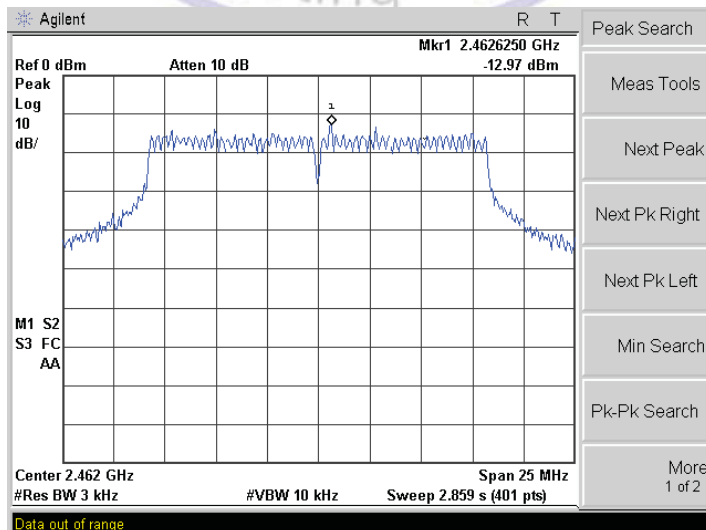

For 802.11n (20MHz) Mode:

### CH1 @ANT 1

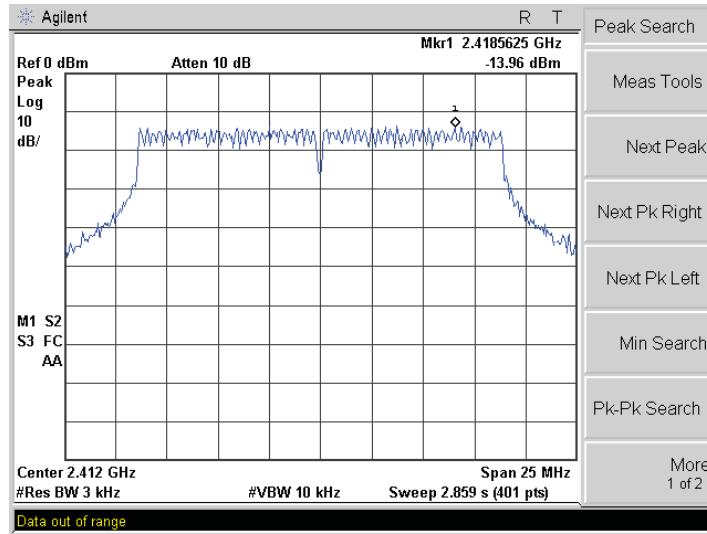

### CH1 @ANT 2

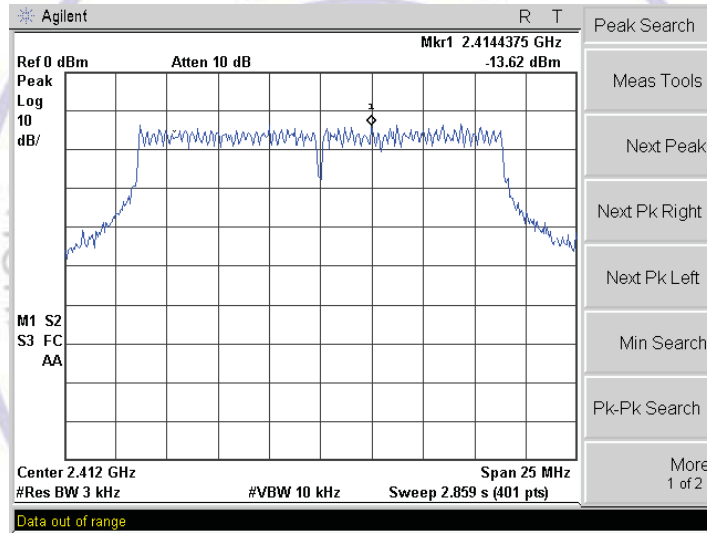

### CH6 @ANT 1

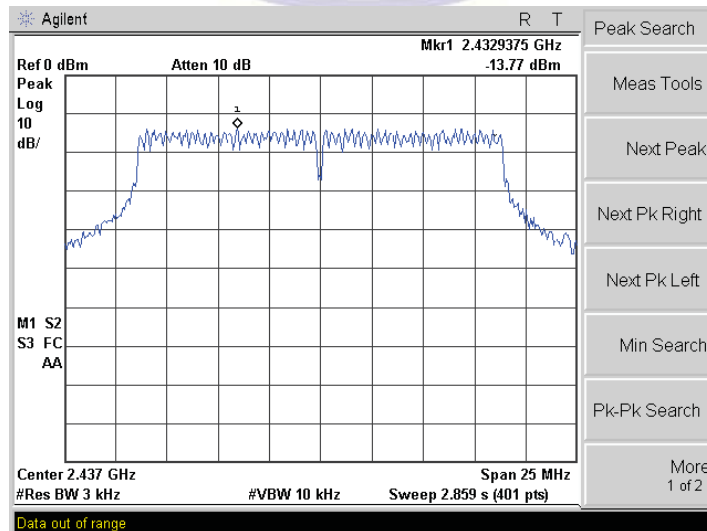

### CH6 @ANT 2

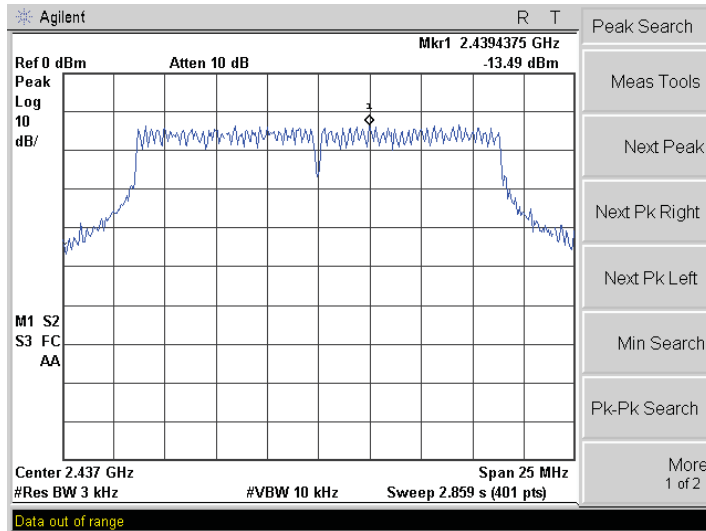

### CH11 @ANT 1

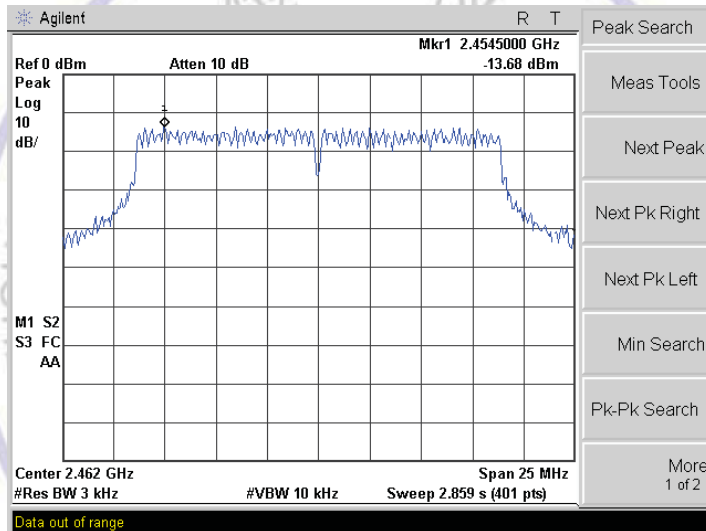

### CH11 @ANT 2

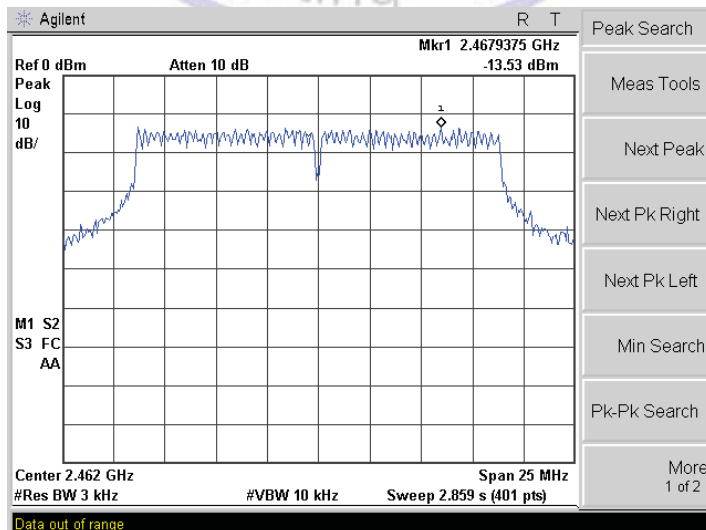



For 802.11n (40MHz) Mode:

### CH3 @ANT 1

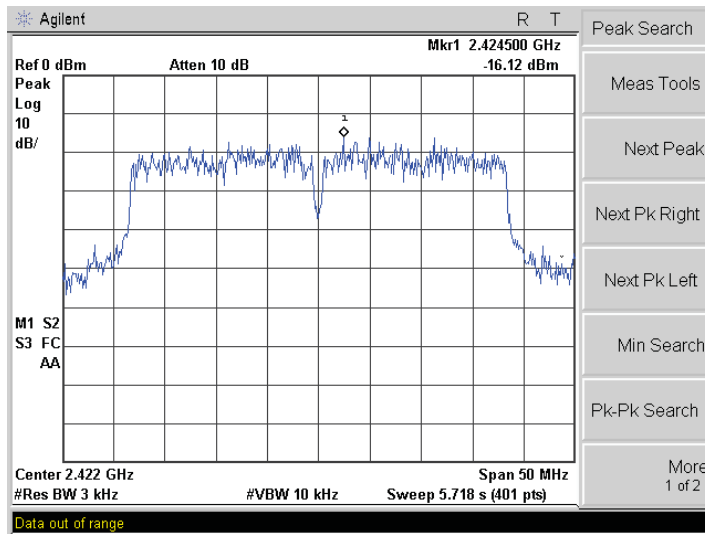

### CH3 @ANT 2

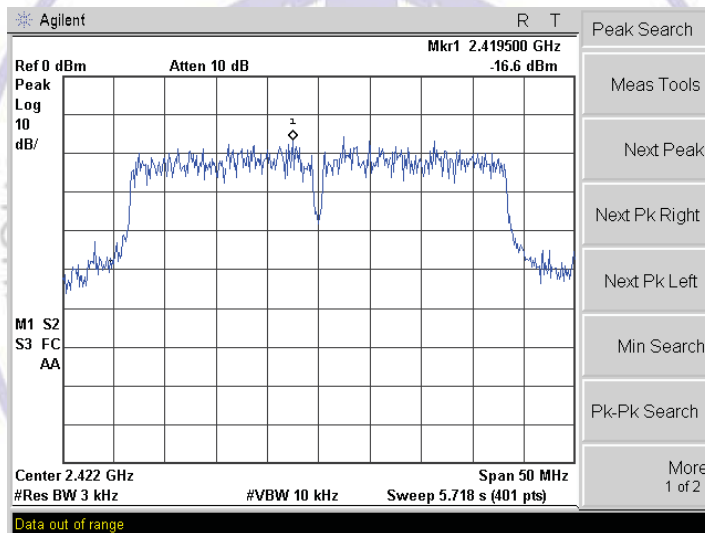

### CH6 @ANT 1

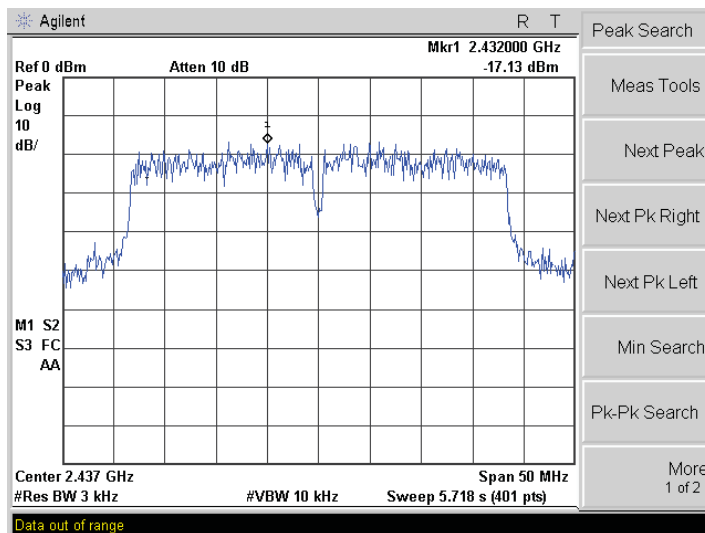

### CH6 @ANT 2

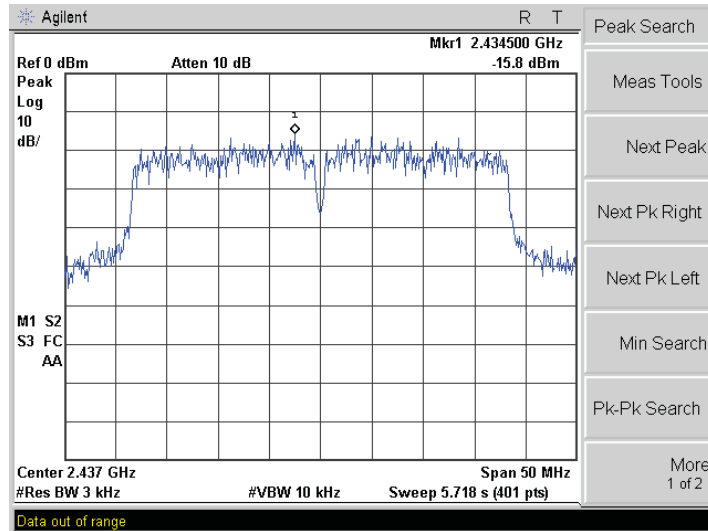

### CH9 @ANT 1

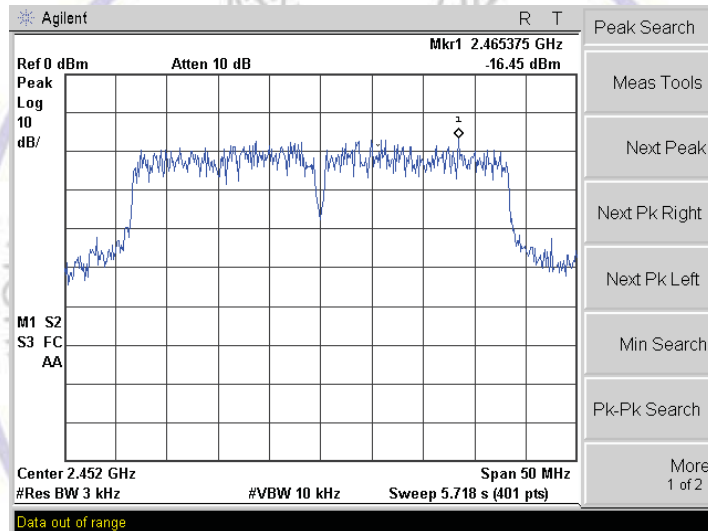

### CH9 @ANT 2

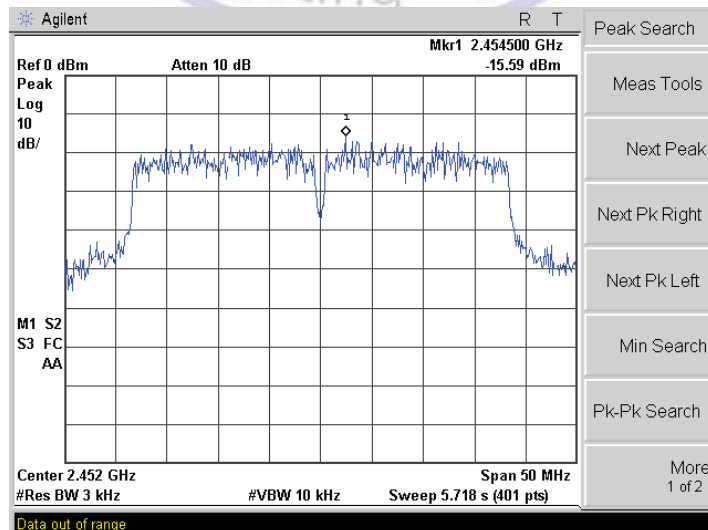

### 4.7. Spurious RF Conducted Emission

#### TEST CONFIGURATION

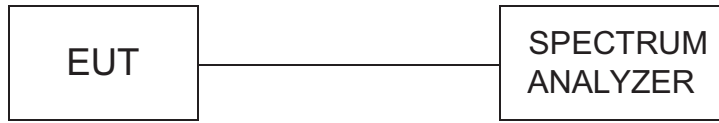

#### TEST PROCEDURE

The EUT was tested according to KDB558074 D01 v03r02 for compliance to FCC 47CFR 15.247 requirements.

The Spurious RF conducted emissions compliance of RF radiated emission should be measured by following the guidance in ANSI C63.10-2009 with respect to maximizing the emission by rotating the EUT, measuring the emission while the EUT is situated in three orthogonal planes (if appropriate), adjusting the measurement antenna height and polarization etc. Set RBW=100kHz and VBM= 300KHz to measure the peak field strength , and measure frequency range from 30MHz to 26.5GHz.

#### LIMIT

In any 100 kHz bandwidth outside the frequency band in which the spread spectrum or digitally modulated intentional radiator is operating, the radio frequency power that is produced by the intentional radiator shall be at least 20 dB below that in the 100 kHz bandwidth within the band that contains the highest level of the desired power, based on either an RF conducted or a radiated measurement, provided the transmitter demonstrates compliance with the peak conducted power limits.

#### TEST RESULTS

Photos of Spurious RF Conducted Emission Measurement

For 802.11b Mode:

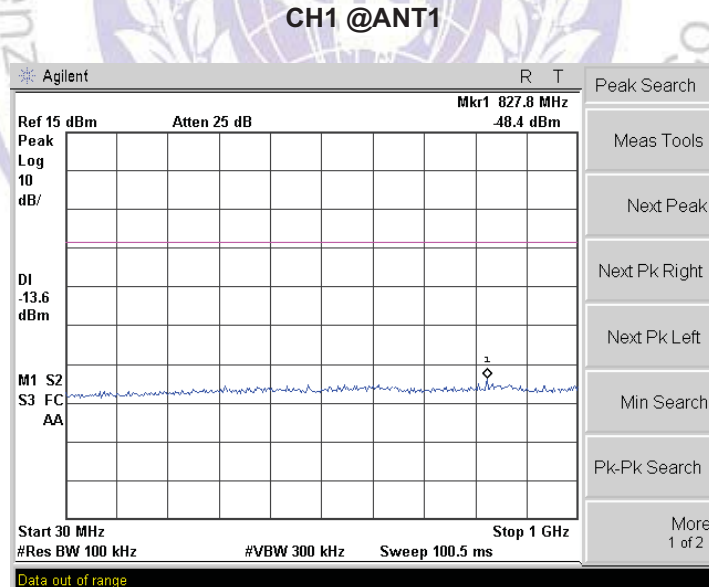

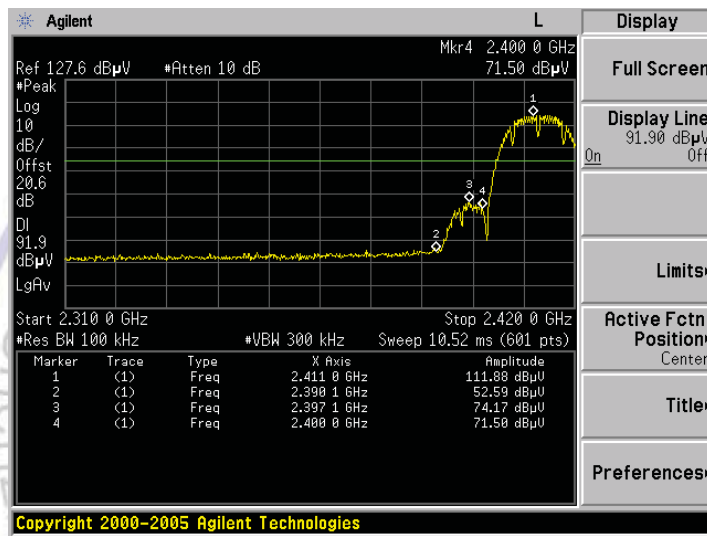
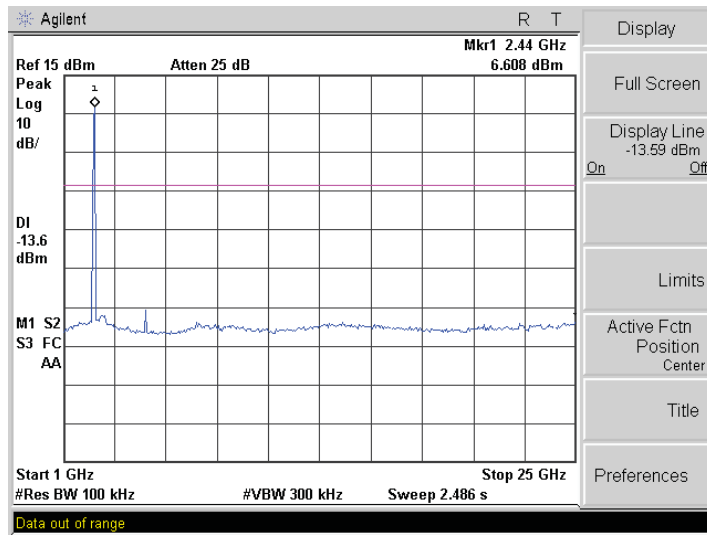

CH1 @ANT 2

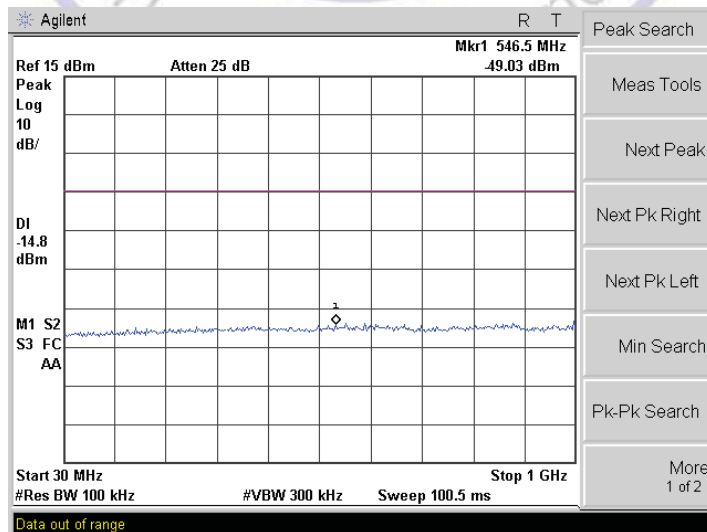

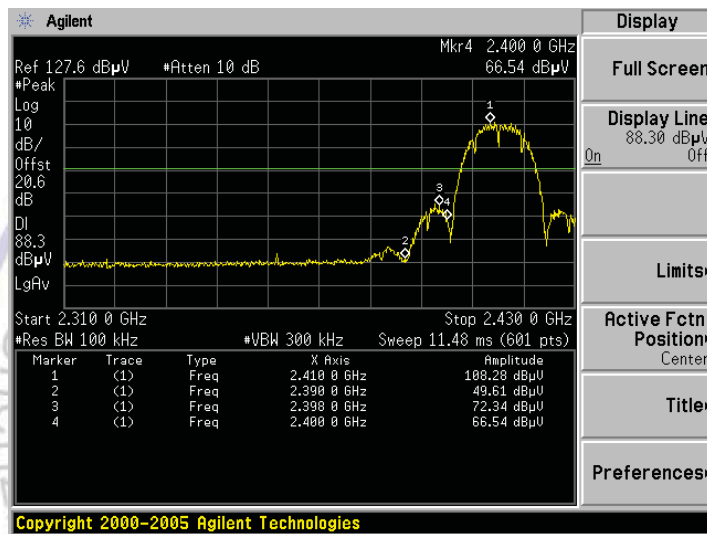
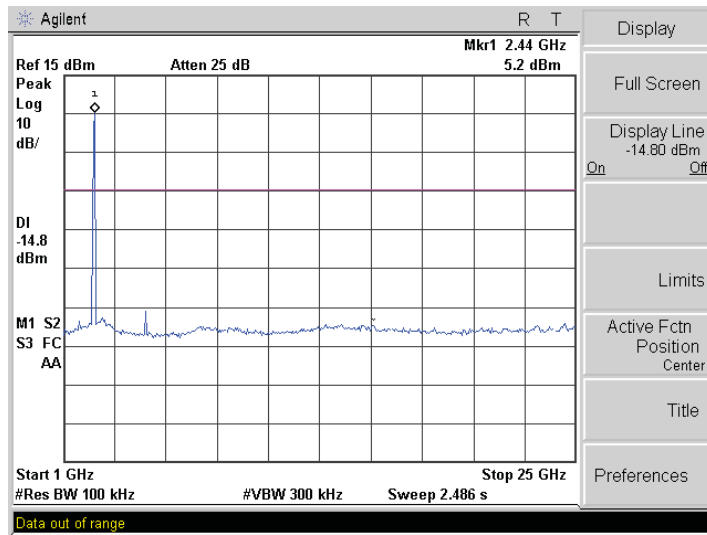

CH6 @ANT 1

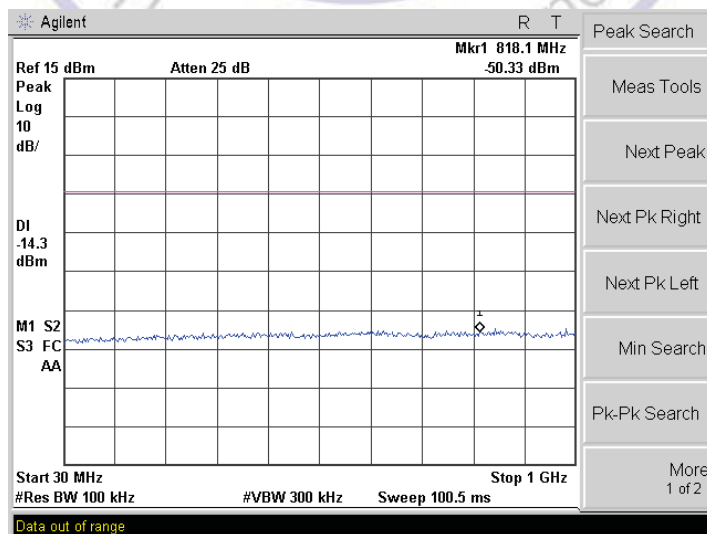

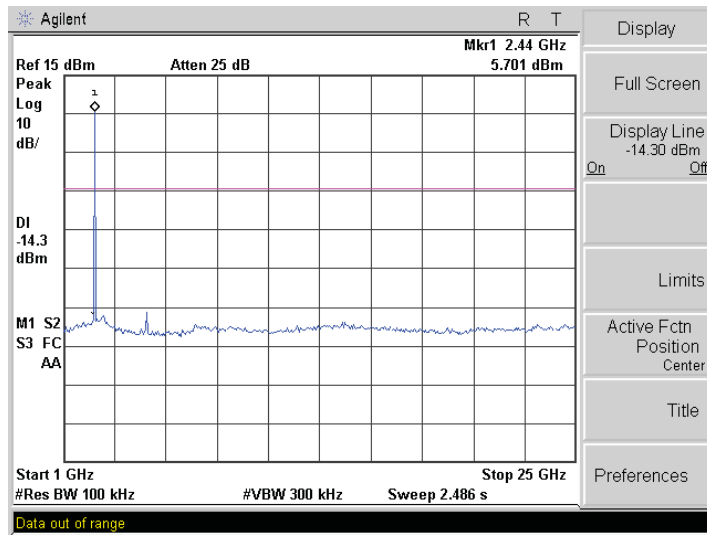

CH6 @ANT 2

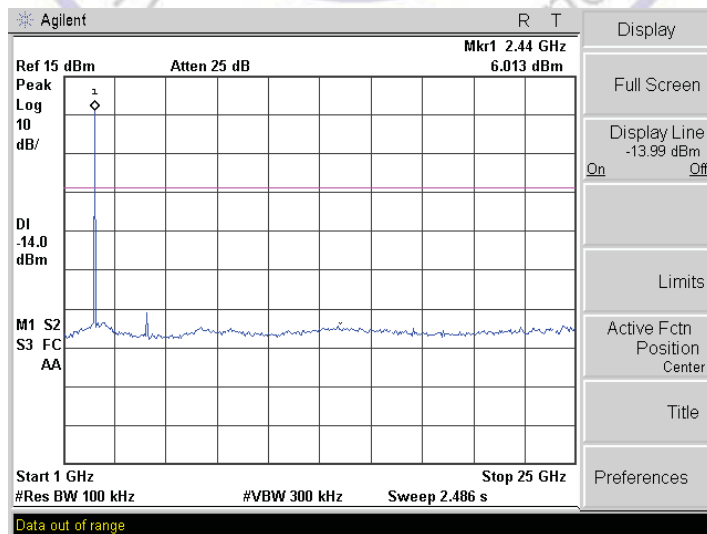
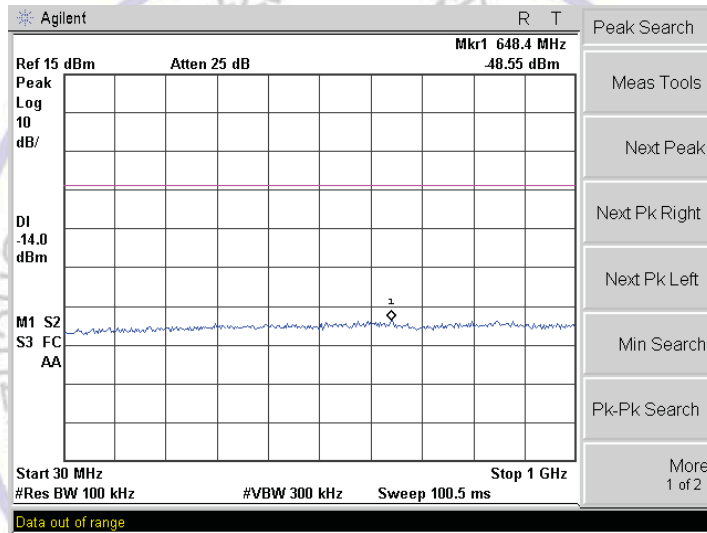

CH11 @ANT 1

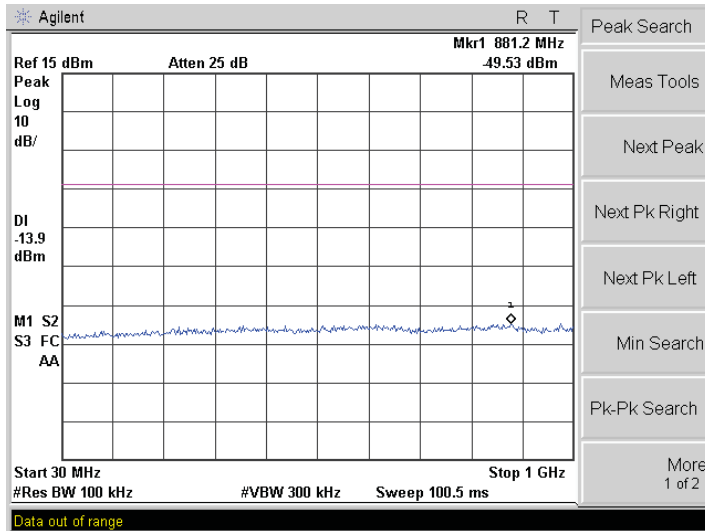

- Peak Search
- Meas Tools ▶
- Next Peak
- Next Pk Right
- Next Pk Left
- Min Search
- Pk-Pk Search
- More 1 of 2

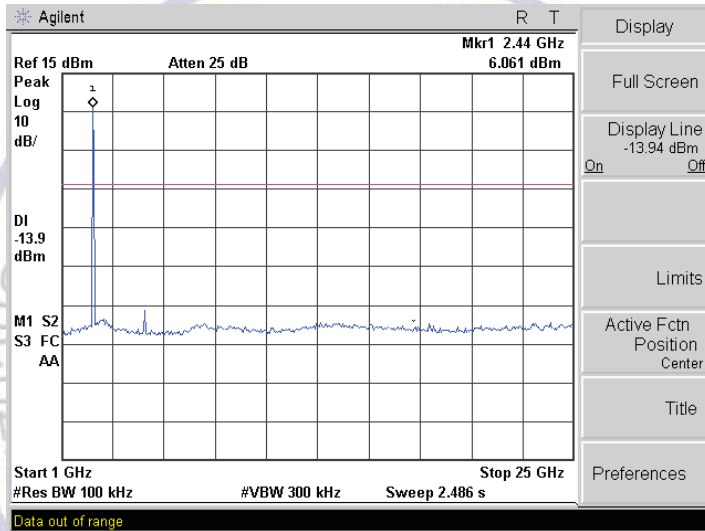

- Display
- Full Screen
- Display Line -13.94 dBm On Off
- Limits ▶
- Active Fctn Position ▶ Center
- Title ▶
- Preferences ▶

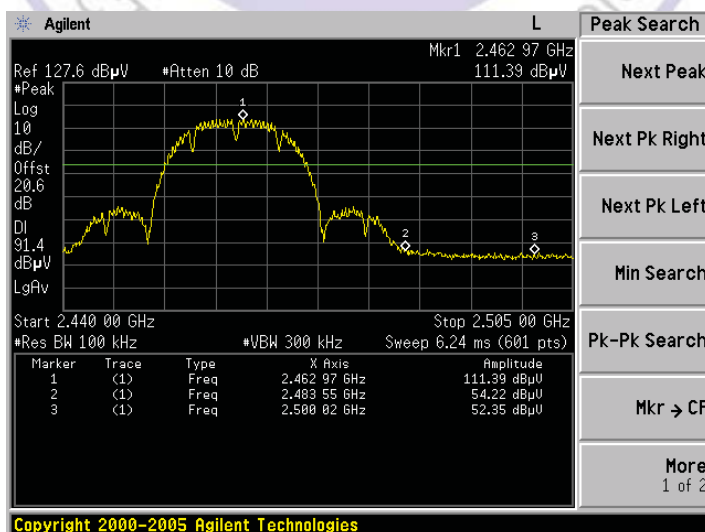

- Peak Search
- Next Peak
- Next Pk Right
- Next Pk Left
- Min Search
- Pk-Pk Search
- Mkr → CF
- More 1 of 2

CH11 @ANT 2

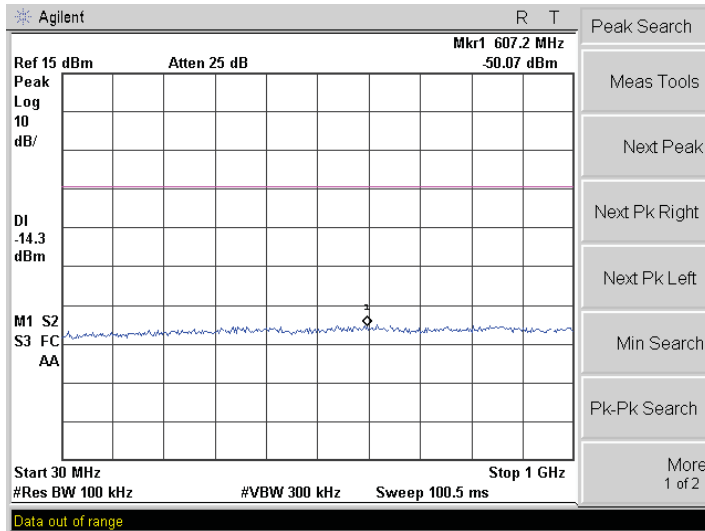

- Peak Search
- Meas Tools ▶
- Next Peak
- Next Pk Right
- Next Pk Left
- Min Search
- Pk-Pk Search
- More 1 of 2

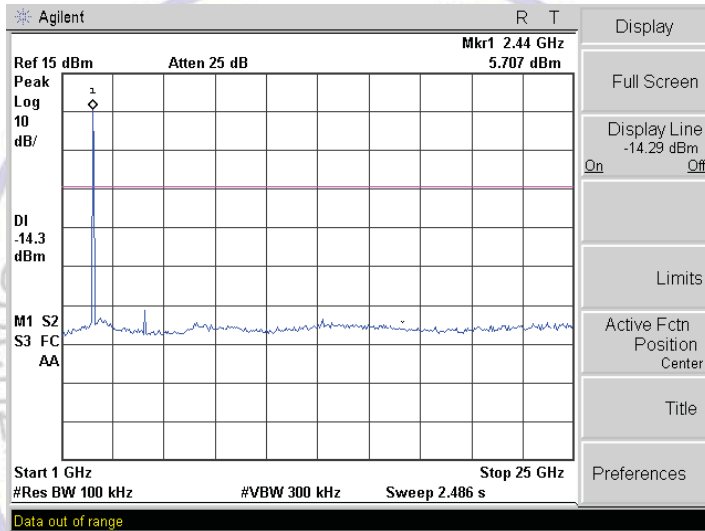

- Display
- Full Screen
- Display Line -14.29 dBm On Off
- Limits ▶
- Active Fctn Position ▶ Center
- Title ▶
- Preferences ▶



- Display
- Full Screen
- Display Line 88.50 dBμV On Off
- Limits ▶
- Active Fctn Position ▶ Center
- Title ▶
- Preferences ▶



For 802.11g Mode:

CH1 @ANT1

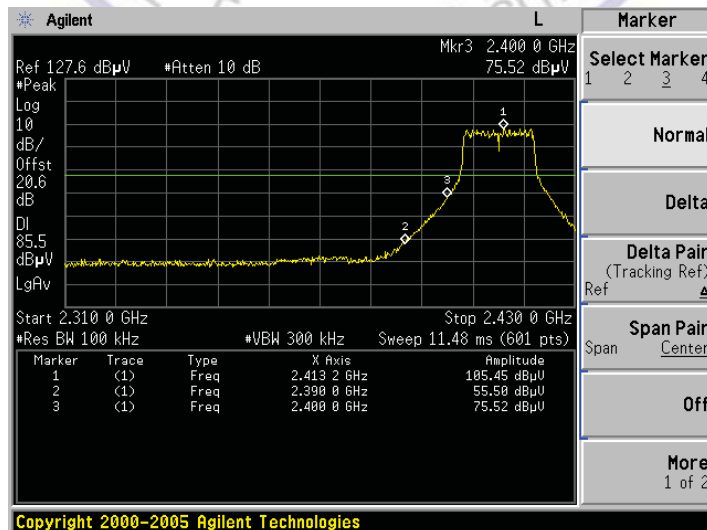
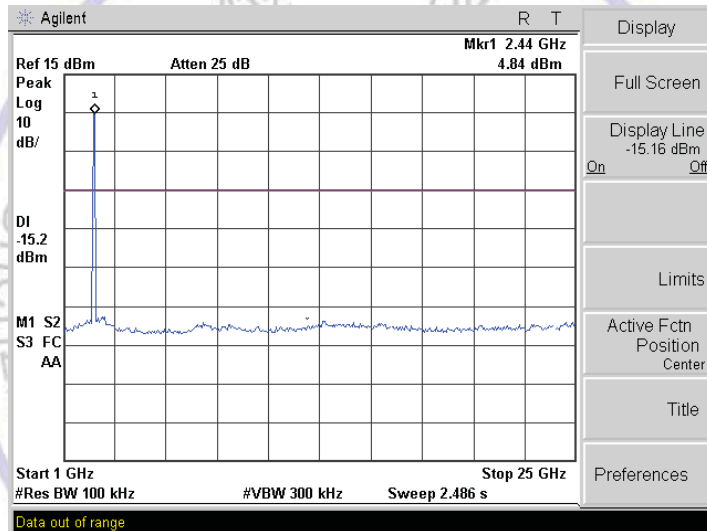
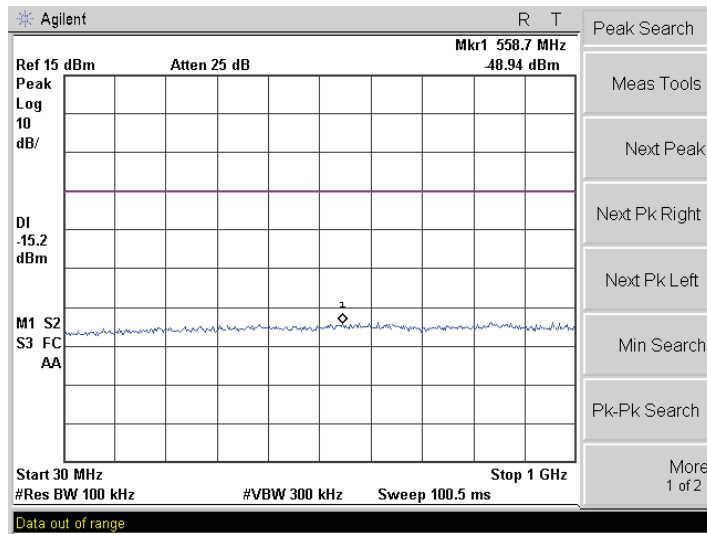

CH1 @ANT 2

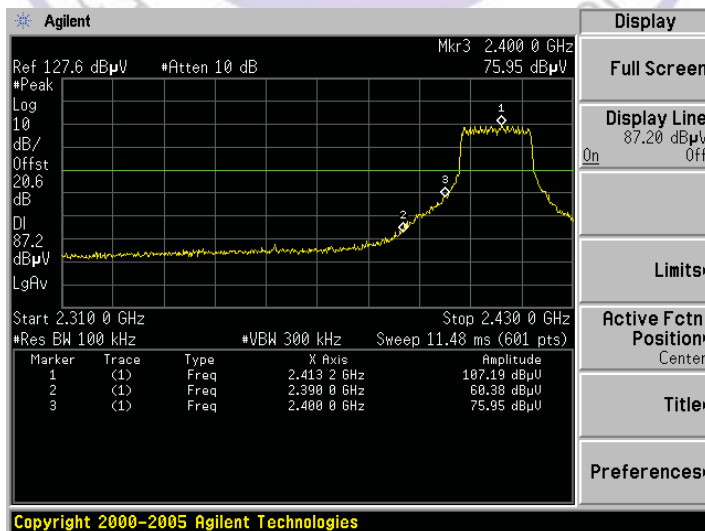
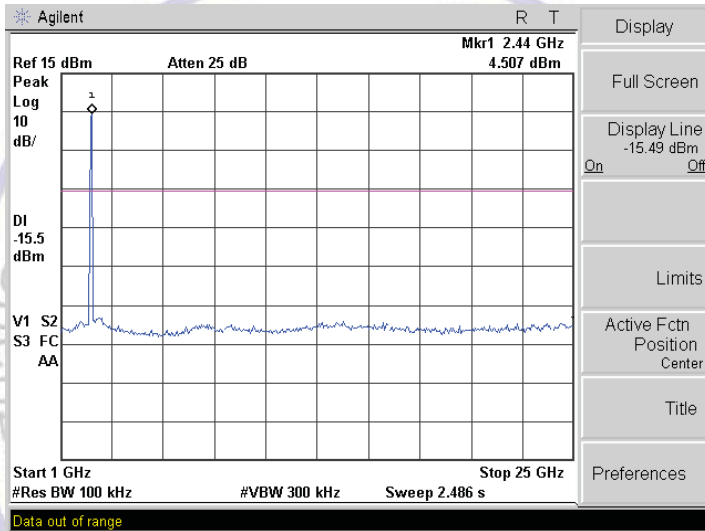
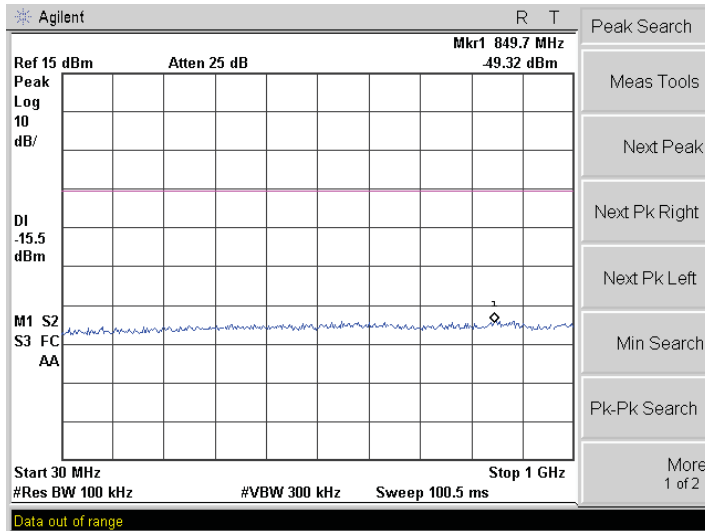

CH6 @ANT 1

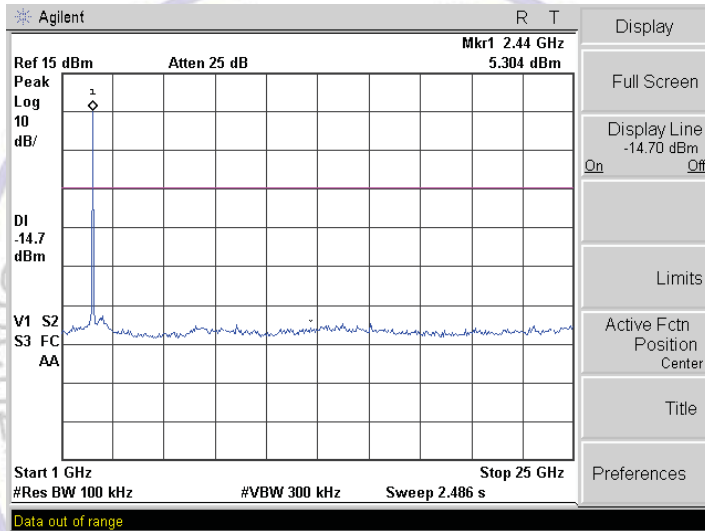
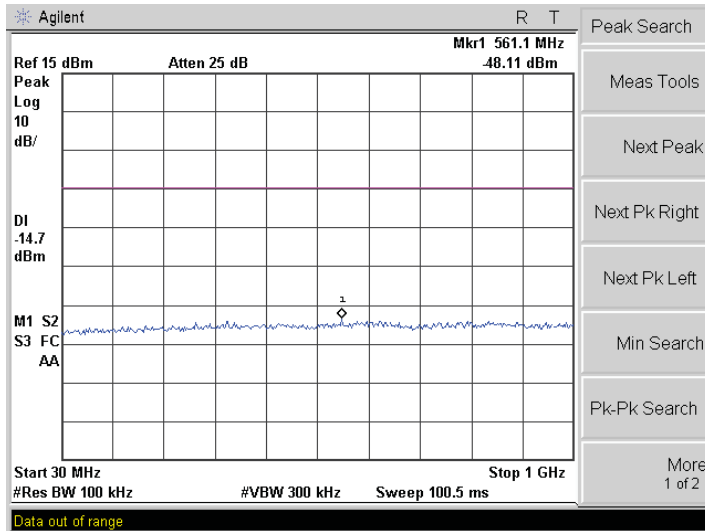

CH6 @ANT 2

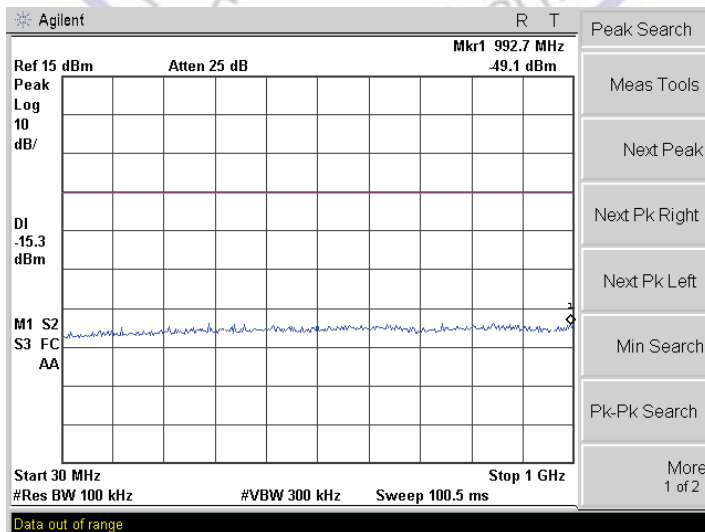

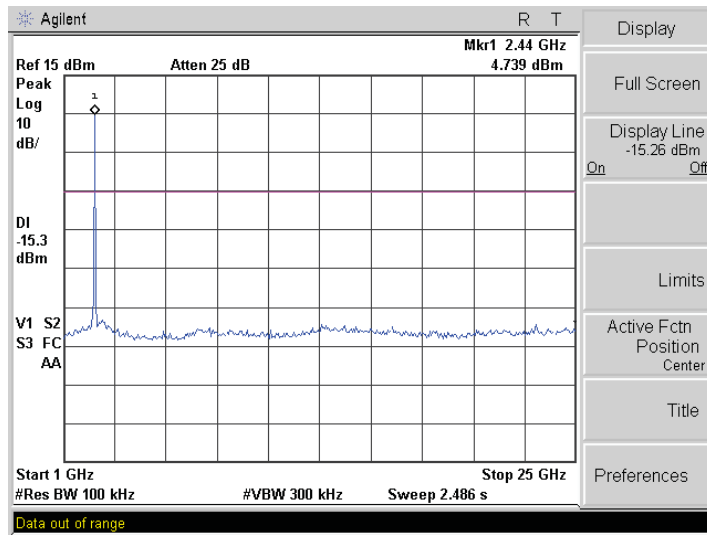

### CH11 @ANT 1

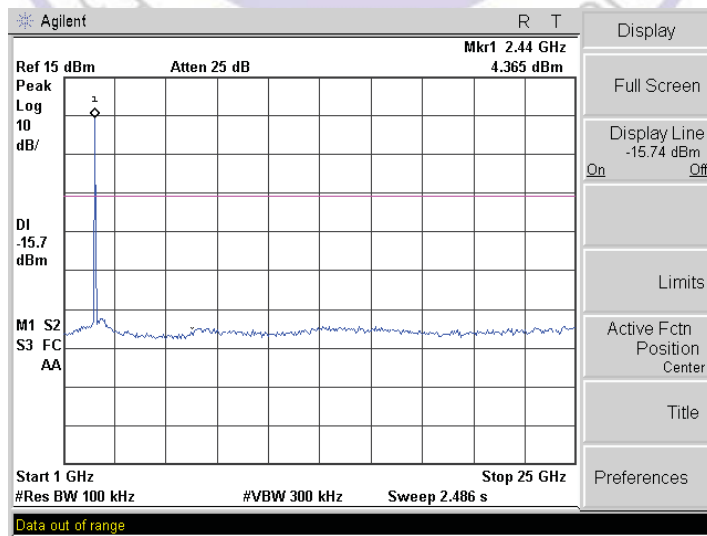
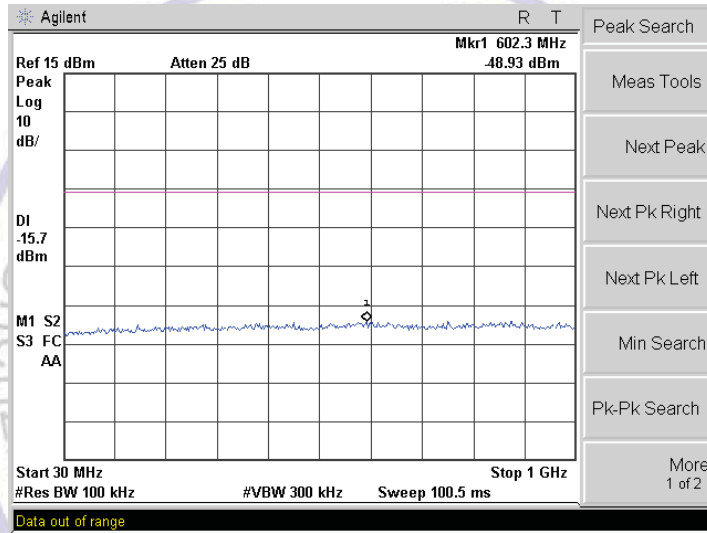

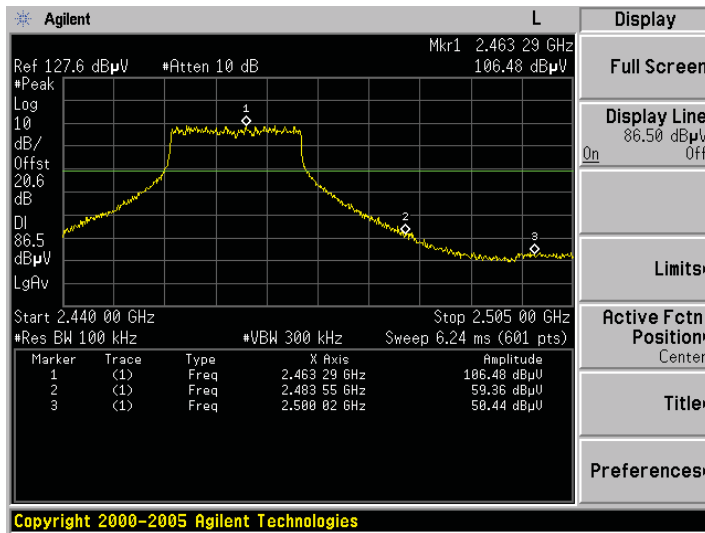

CH11 @ANT 2

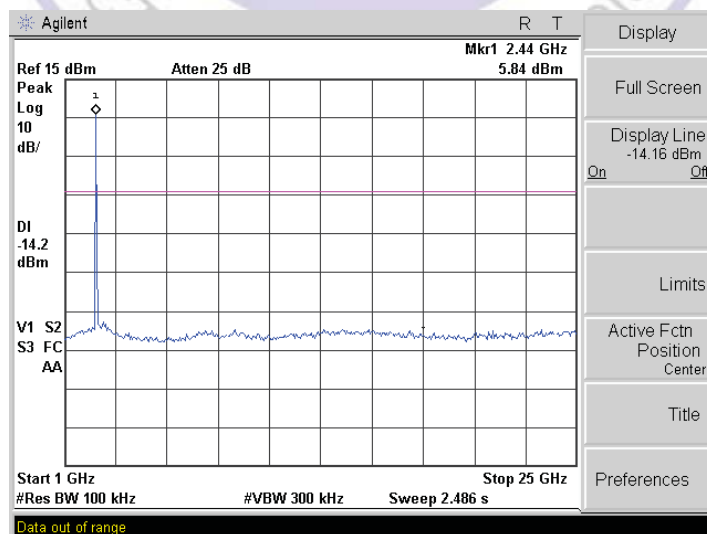
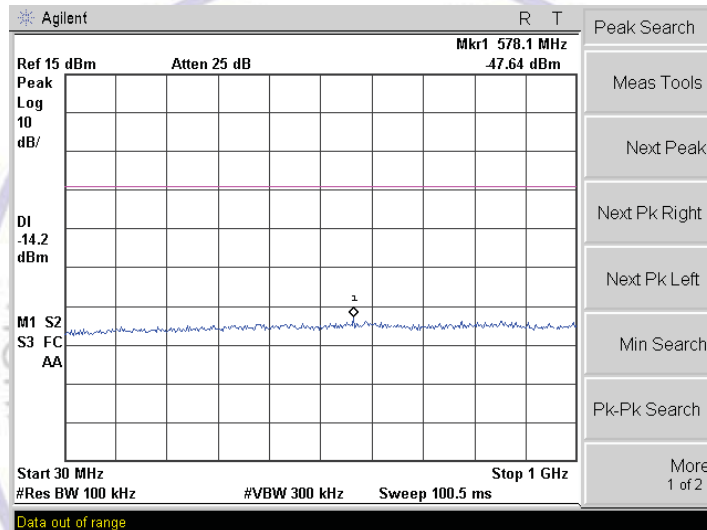

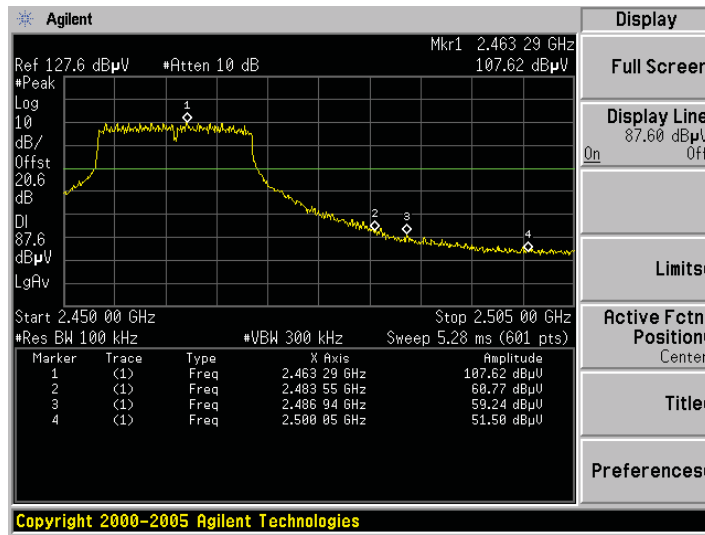

For 802.11n (20MHz) Mode:

CH1 @ANT1

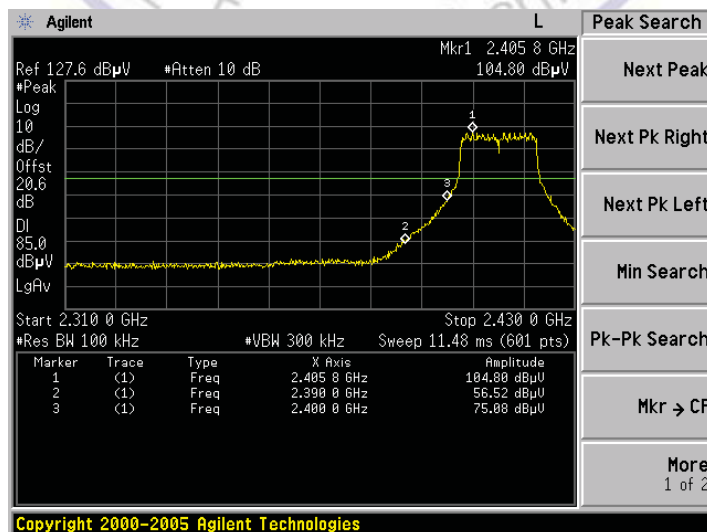
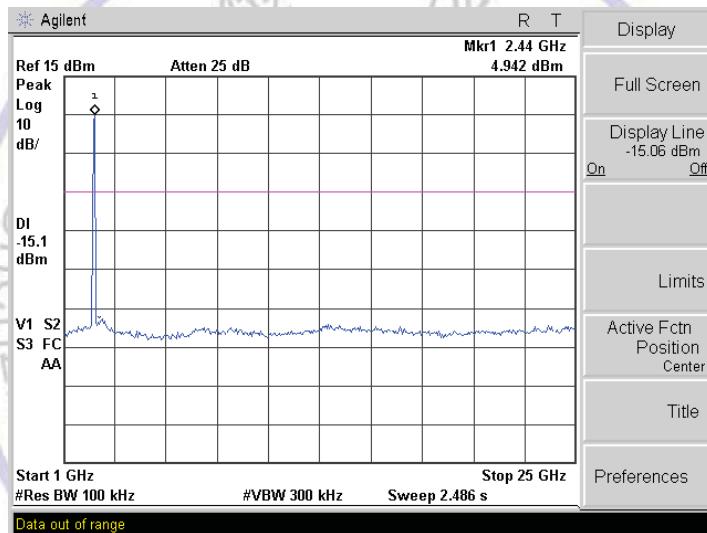
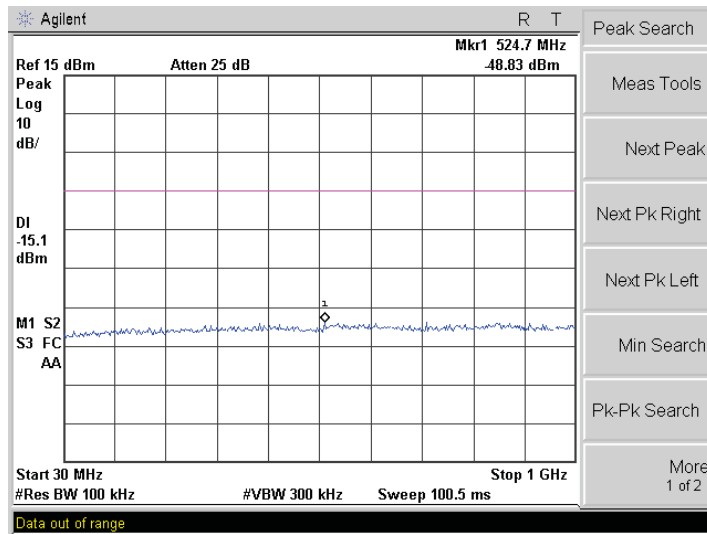

CH1 @ANT 2

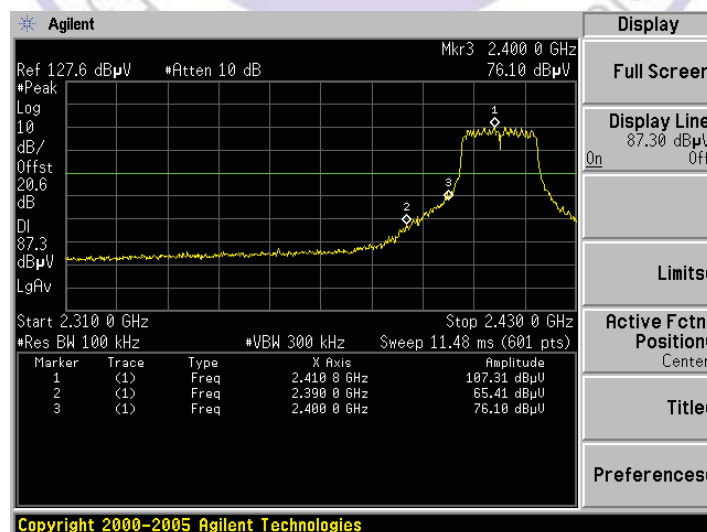
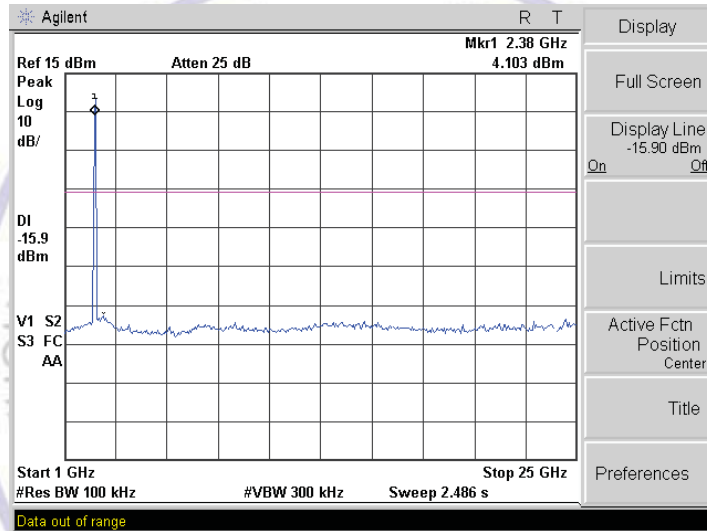
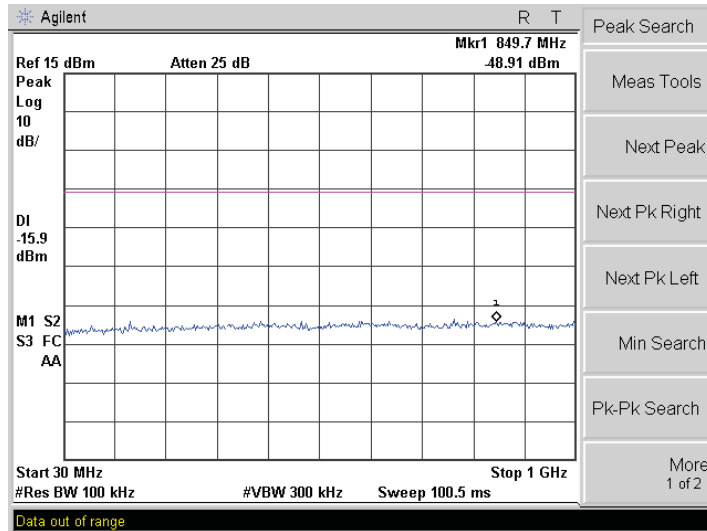



### CH6 @ANT 1

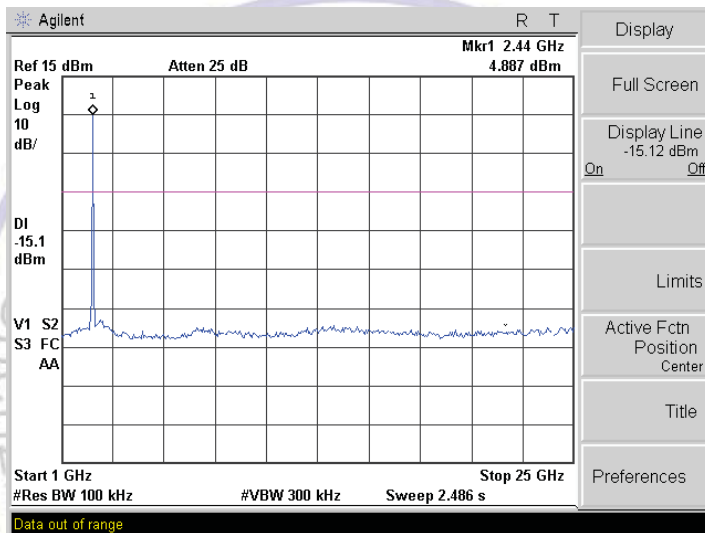
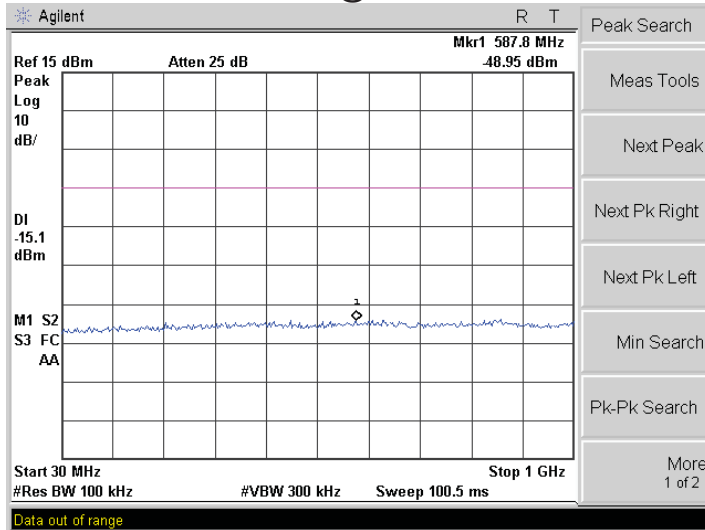

### CH6 @ANT 2

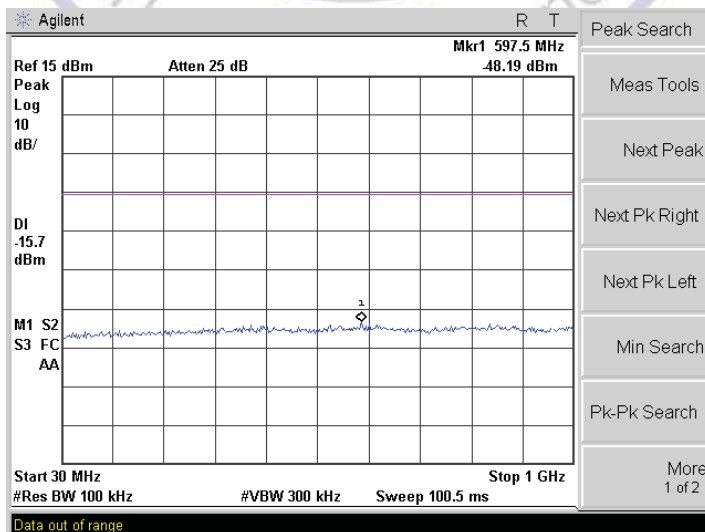

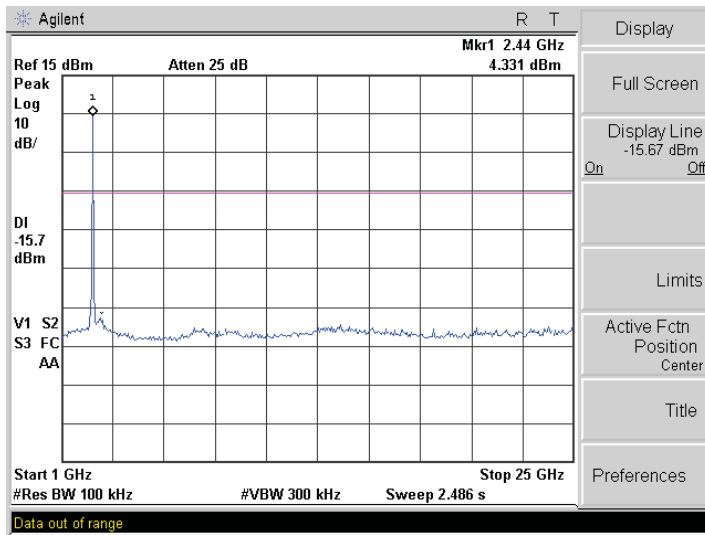

CH11 @ANT 1

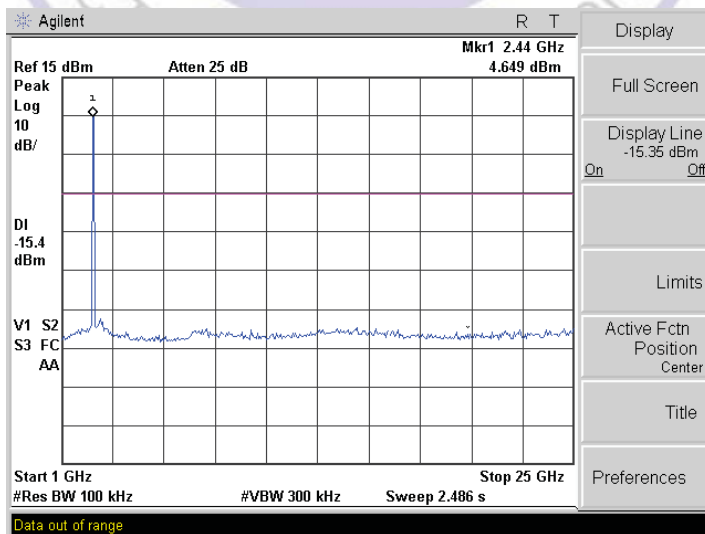
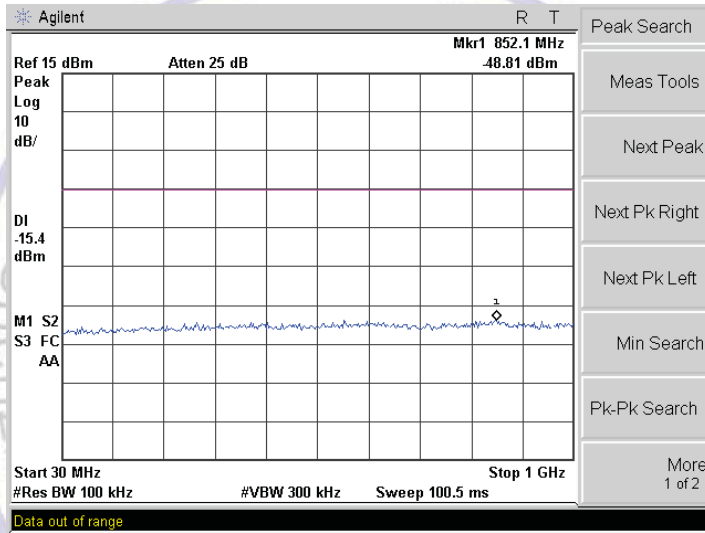

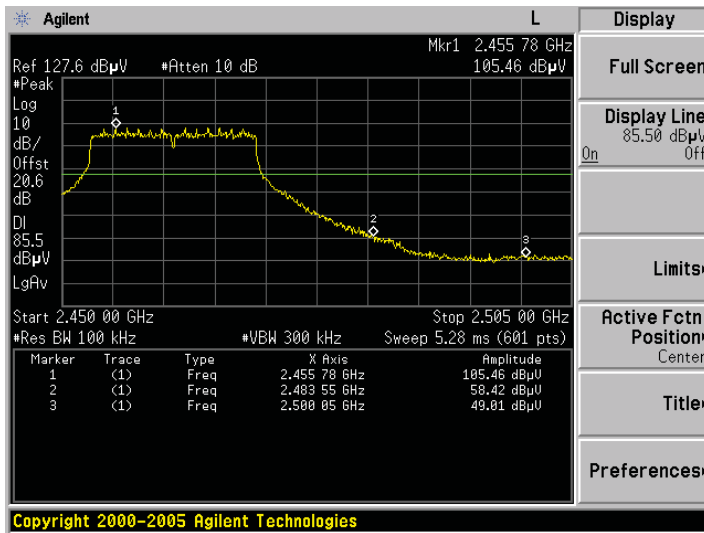

CH11 @ANT 2

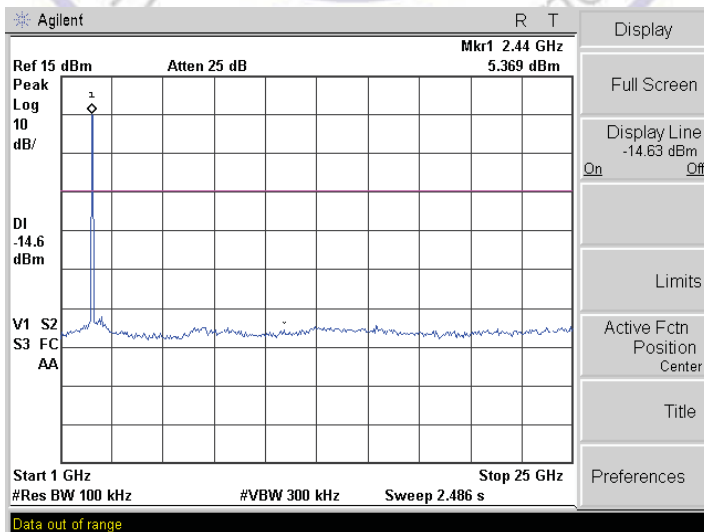
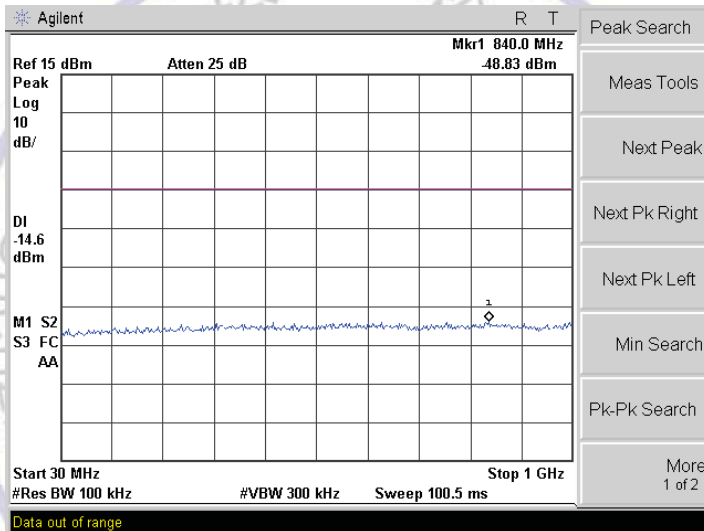

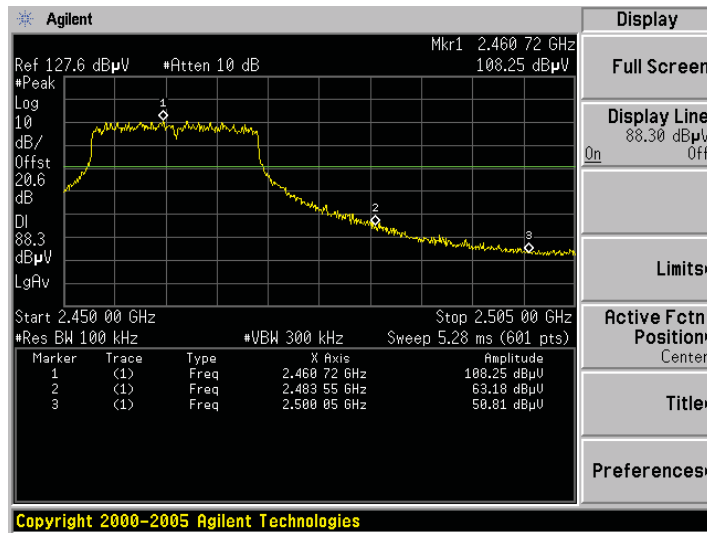

For 802.11n (40MHz) Mode:

CH3 @ANT1

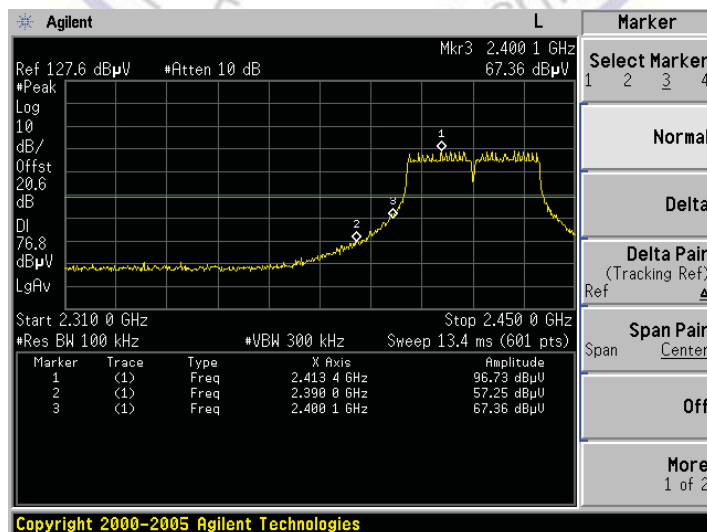
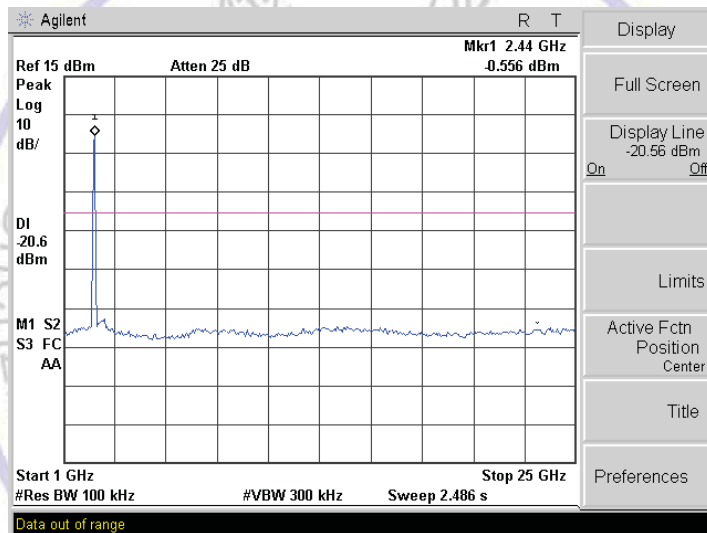
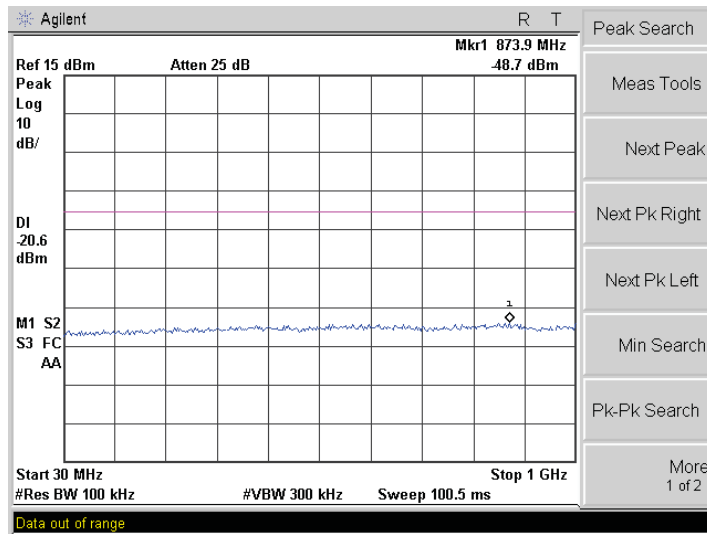

CH3 @ANT 2

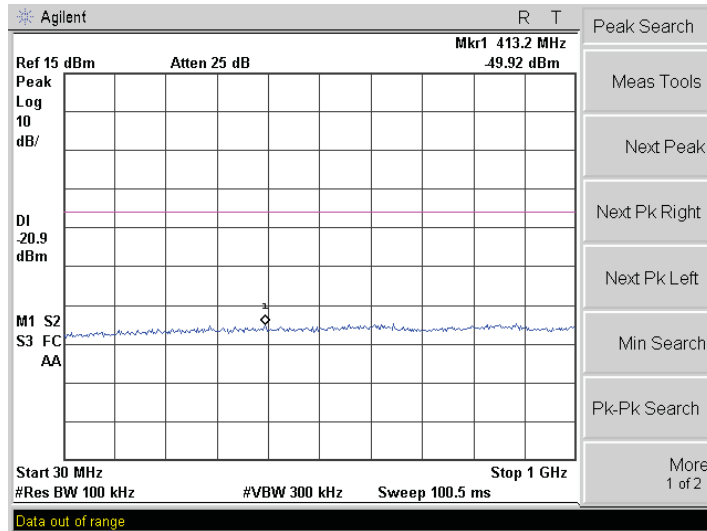

- Peak Search
- Meas Tools ▶
- Next Peak
- Next Pk Right
- Next Pk Left
- Min Search
- Pk-Pk Search
- More 1 of 2

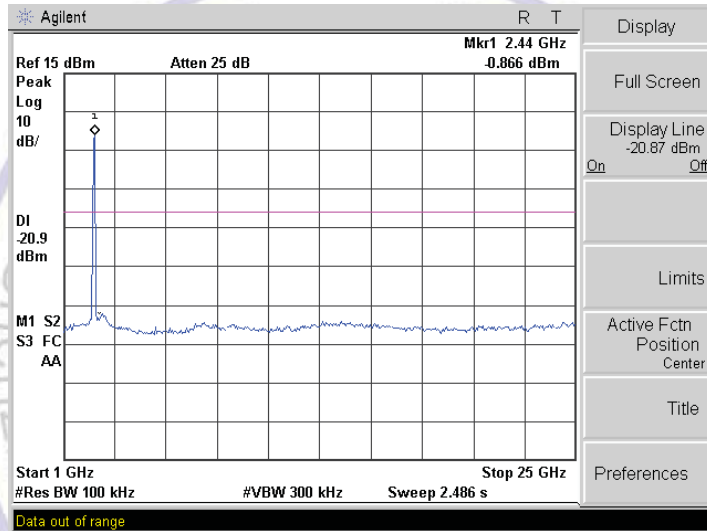

- Display
- Full Screen
- Display Line -20.87 dBm  
 On  Off
- Limits ▶
- Active Fctn Position ▶  
 Center
- Title ▶
- Preferences ▶

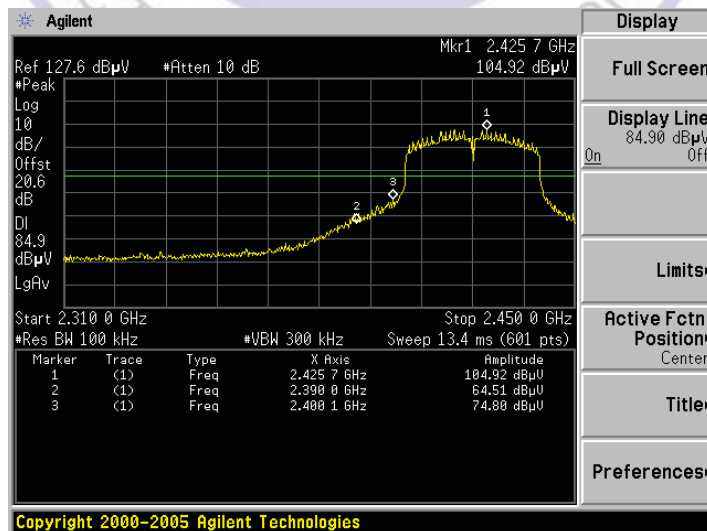

- Display
- Full Screen
- Display Line 84.90 dBµV  
 On  Off
- Limits ▶
- Active Fctn Position ▶  
 Center
- Title ▶
- Preferences ▶

### CH6 @ANT 1

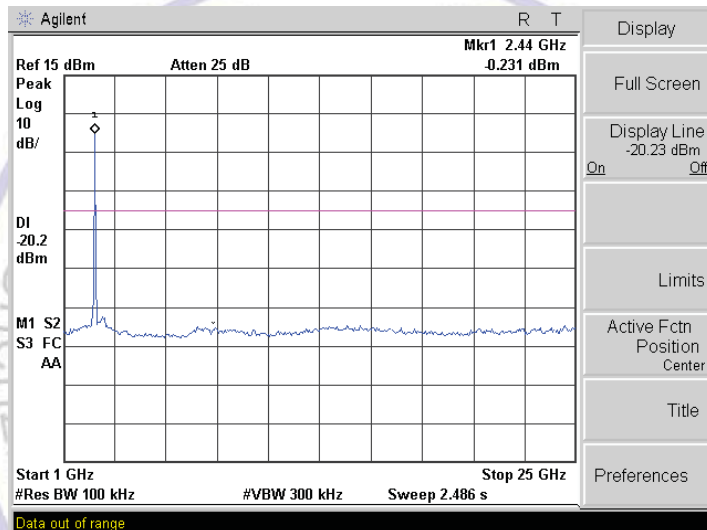
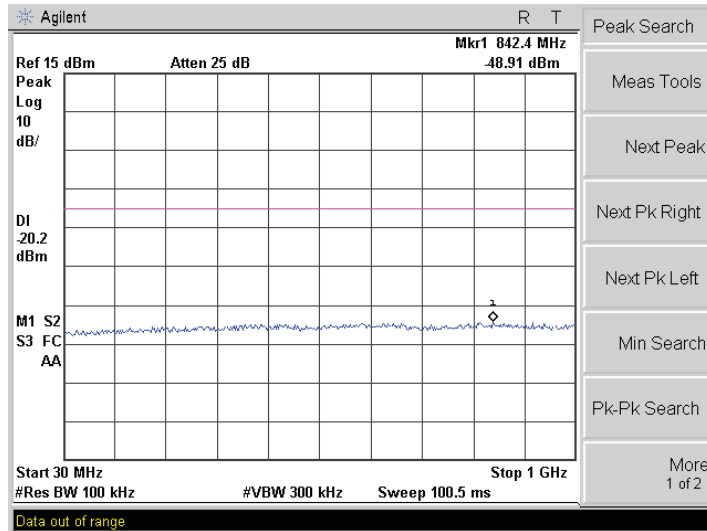

### CH6 @ANT 2

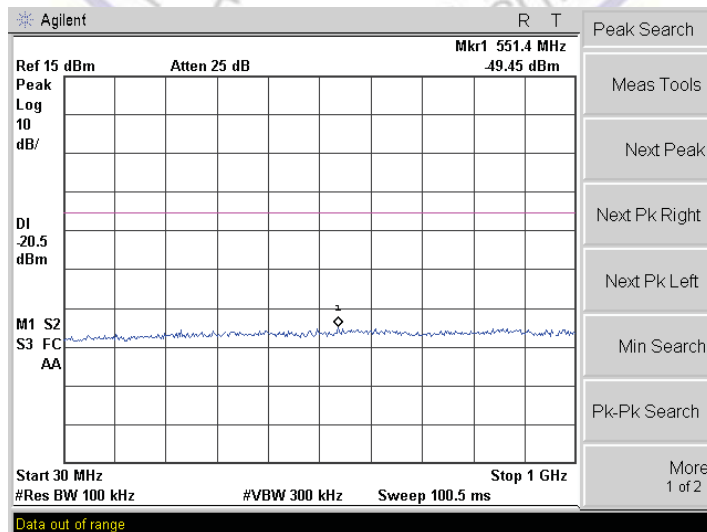

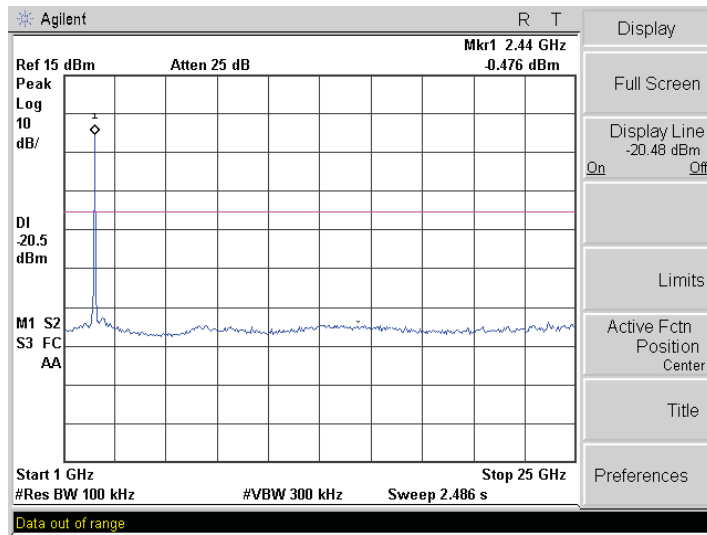

CH9 @ANT 1

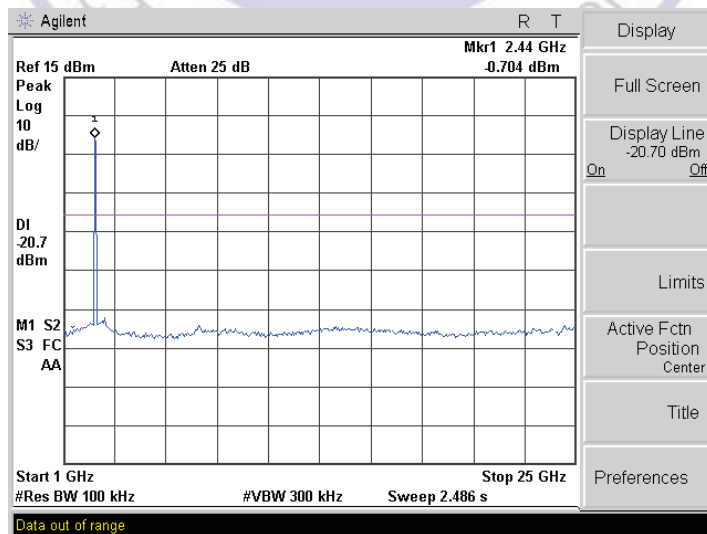
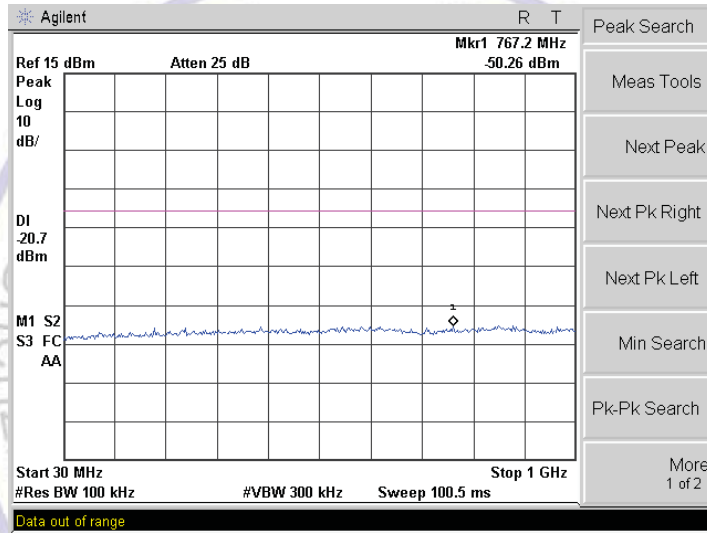



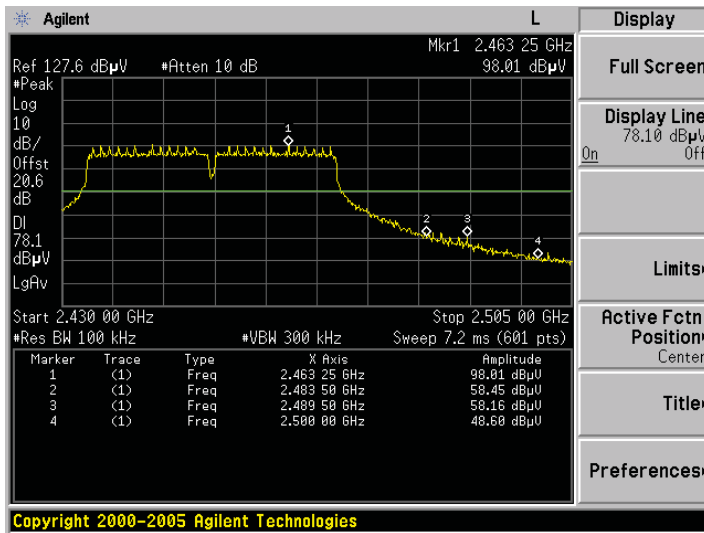

CH9 @ANT 2

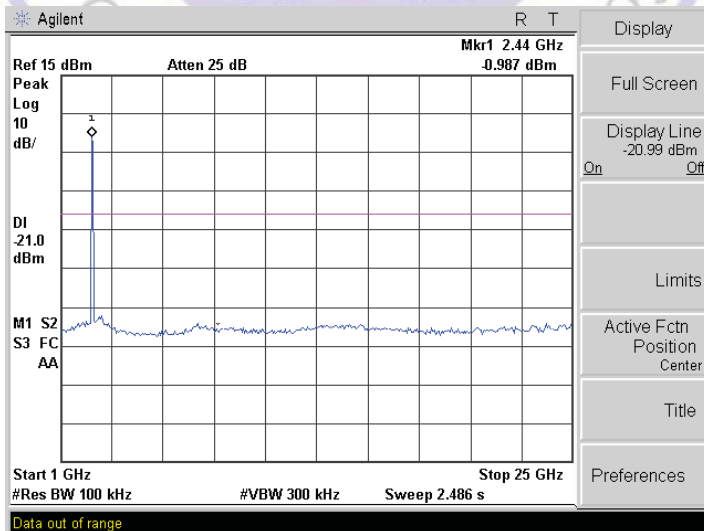
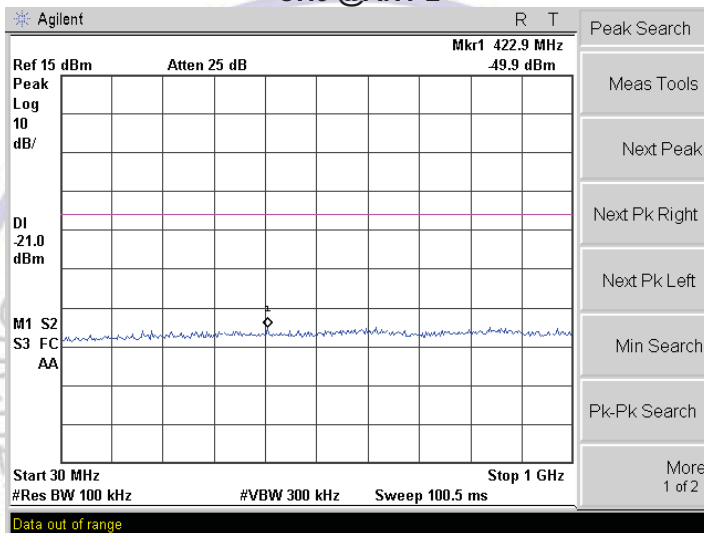

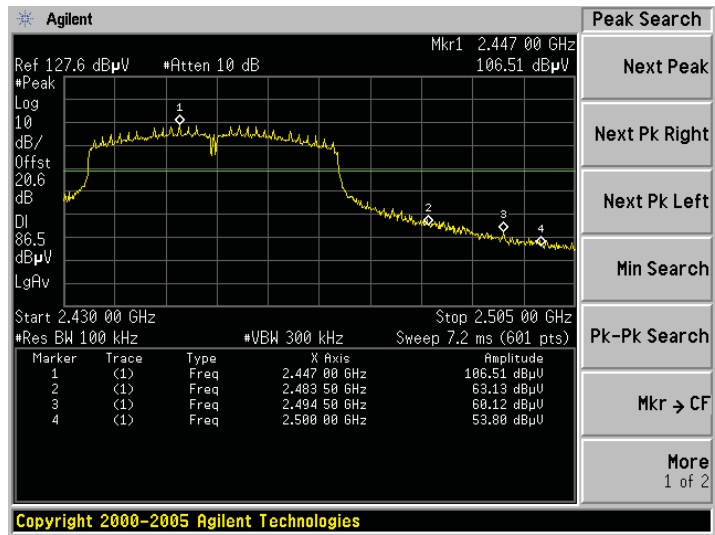

## 4.8. Antenna Requirement

### STANDARD APPLICABLE

For intentional device, according to FCC 47 CFR Section 15.203, an intentional radiator shall be designed to ensure that no antenna other than that furnished by the responsible party shall be used with the device.

And according to FCC 47 CFR Section 15.247 (c), if transmitting antennas of directional gain greater than 6dBi are used, the power shall be reduced by the amount in dB that the directional gain of the antenna exceeds 6dBi.

**Refer to statement below for compliance.**

The manufacturer may design the unit so that the user can replace a broken antenna, but the use of a standard antenna jack or electrical connector is prohibited. Further, this requirement does not apply to intentional radiators that must be professionally installed.

### ANTENNA CONNECTED CONSTRUCTION

The directional gains of antenna used for transmitting is 1.0 dBi, and the antenna connector is designed with permanent attachment and no consideration of replacement. Please see EUT photo for details.



### 5. Test Setup Photos of the EUT

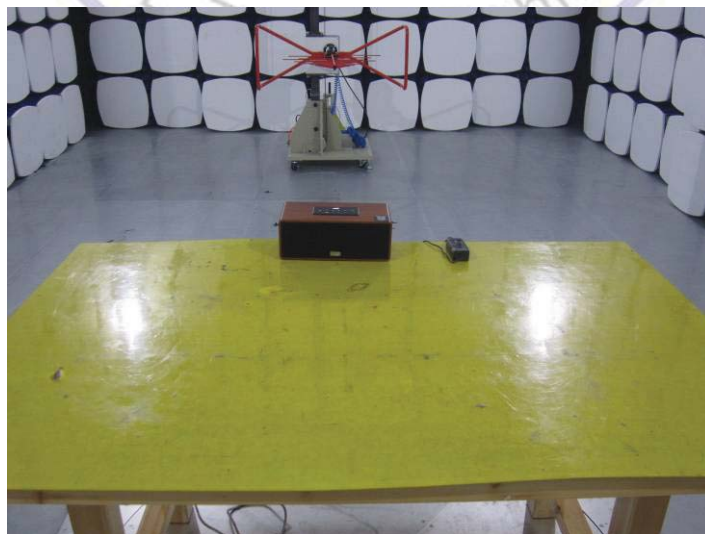
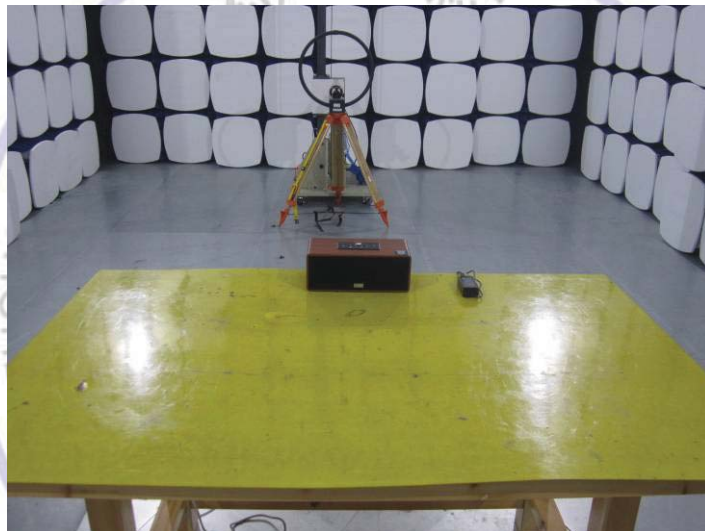

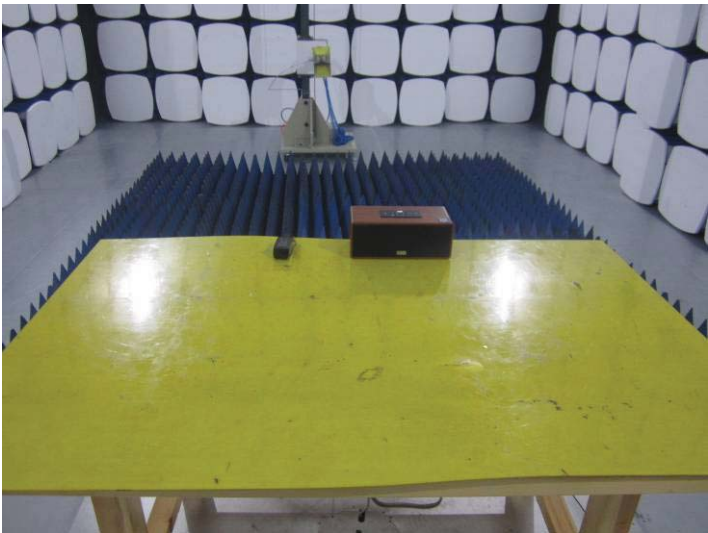

## 6. External and Internal Photos of the EUT

### External Photos of EUT









Internal Photos of EUT

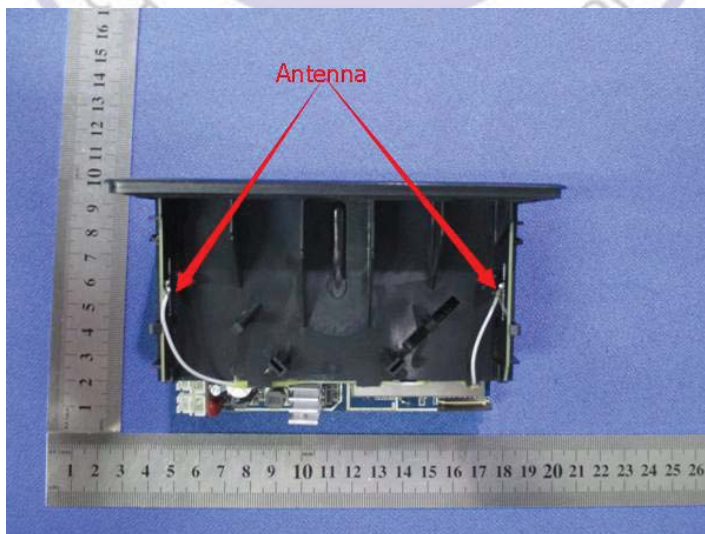
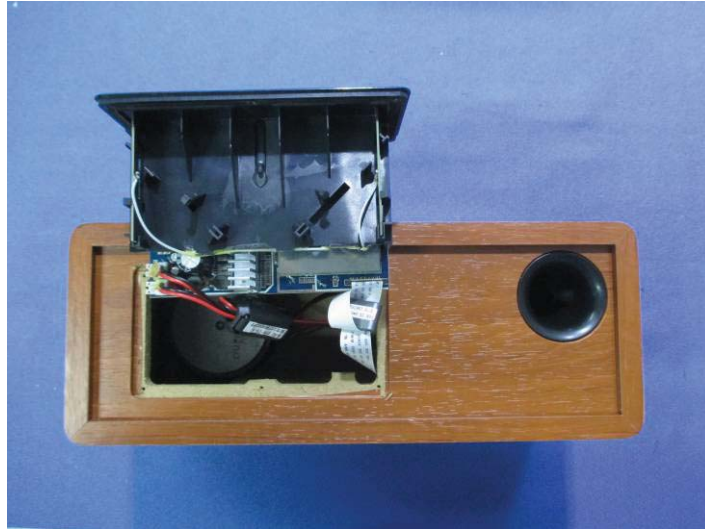

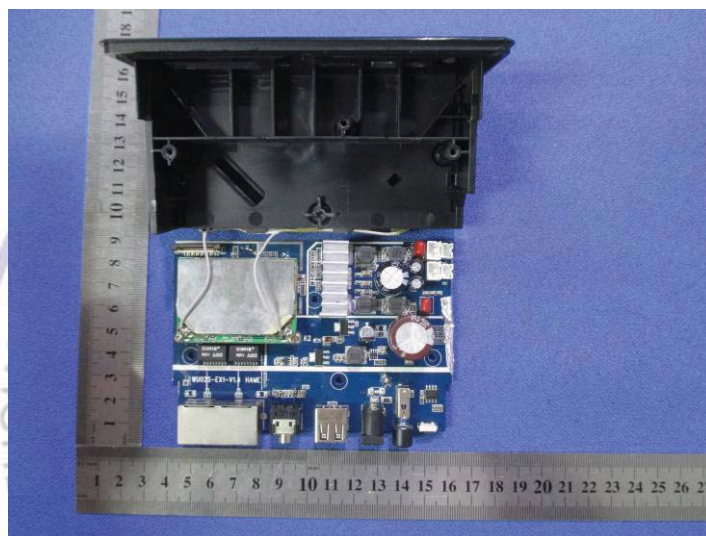
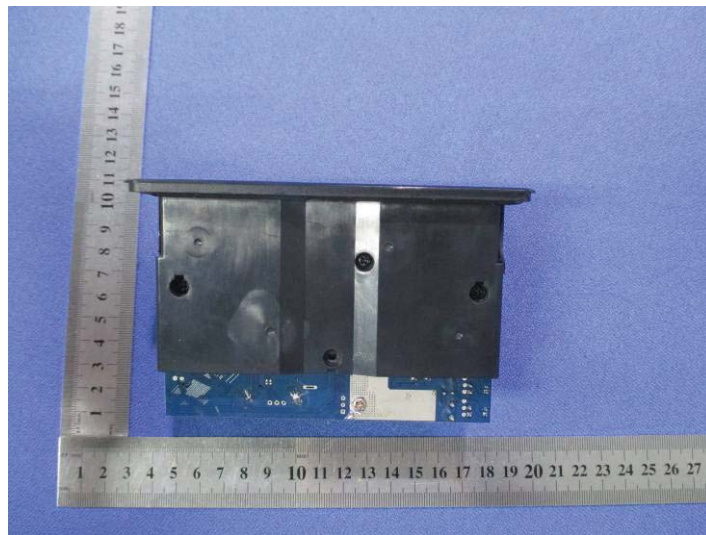

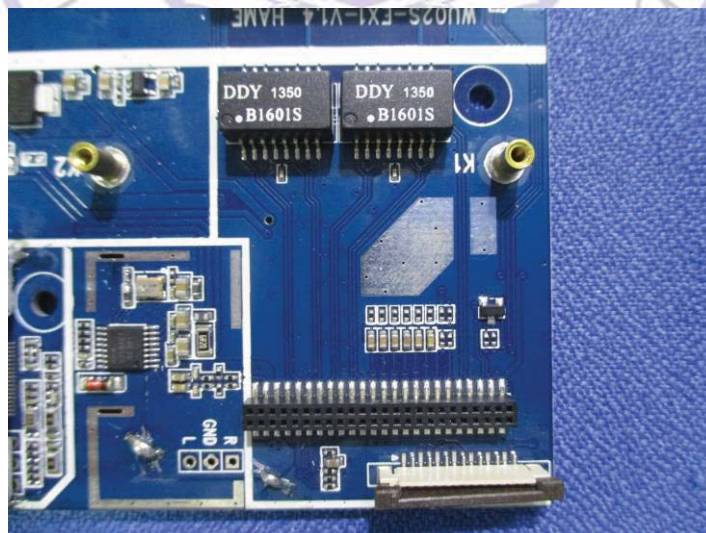
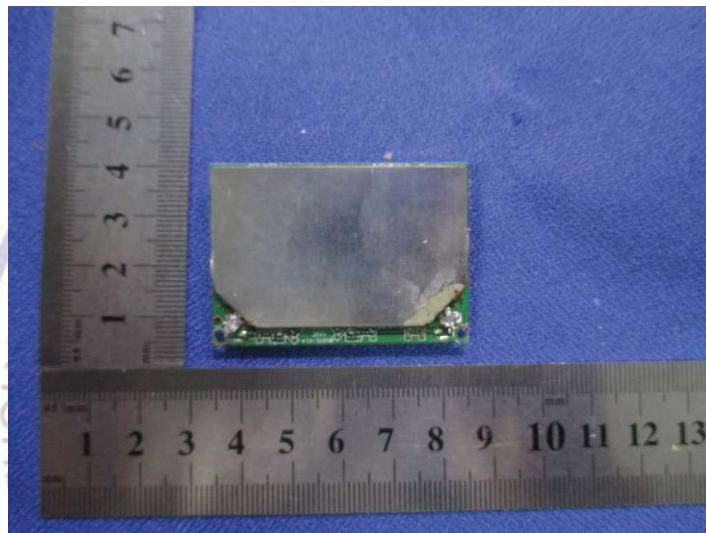
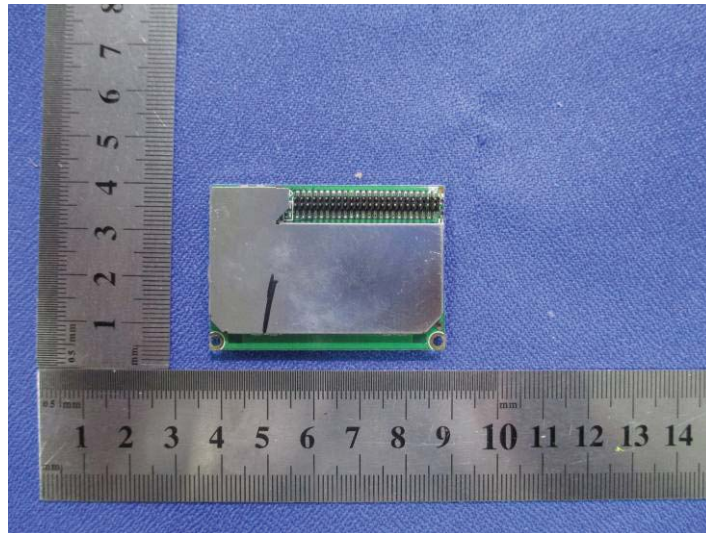

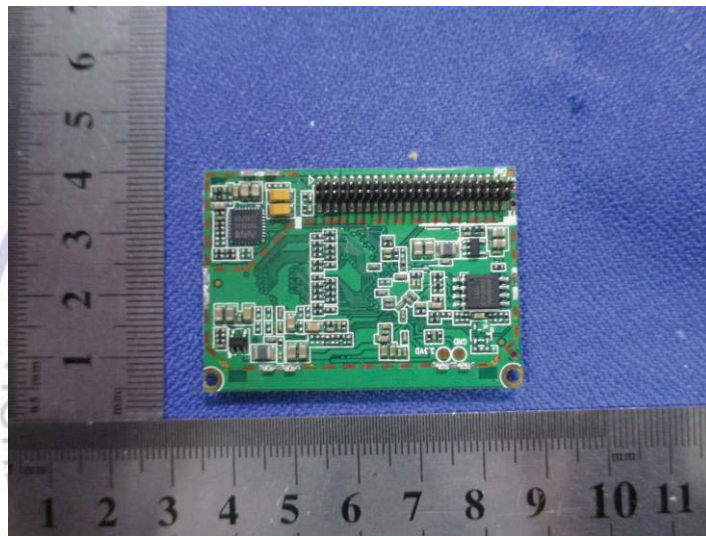
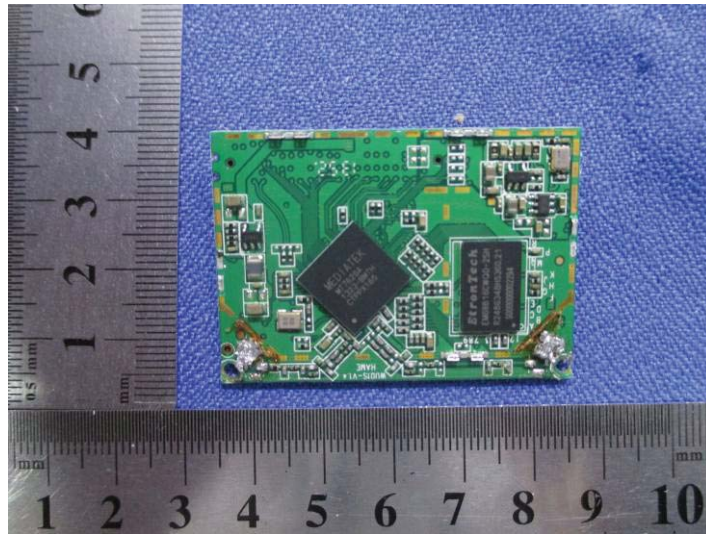

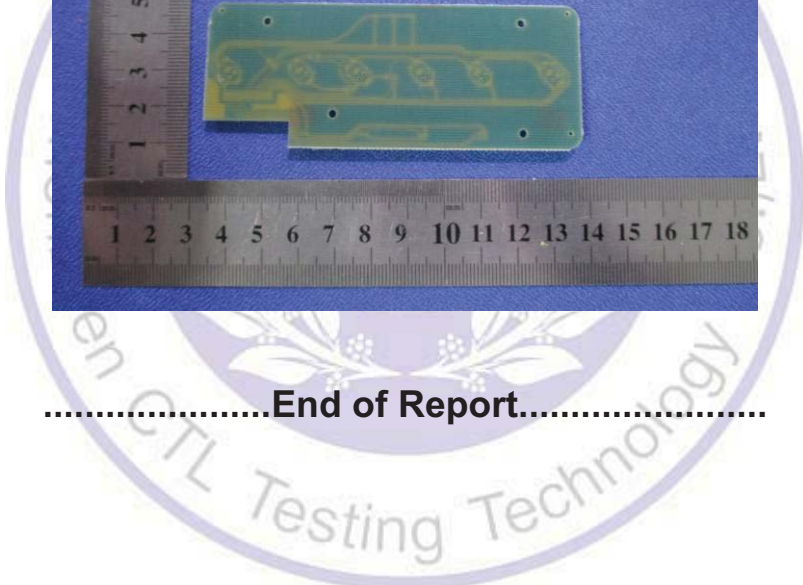
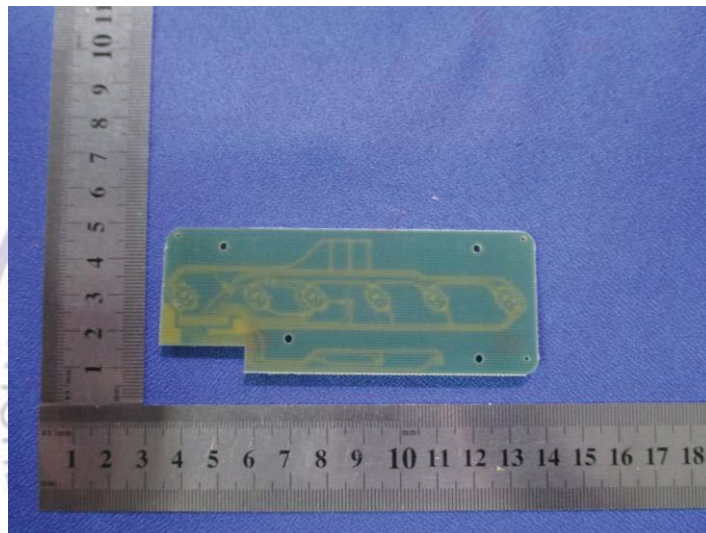
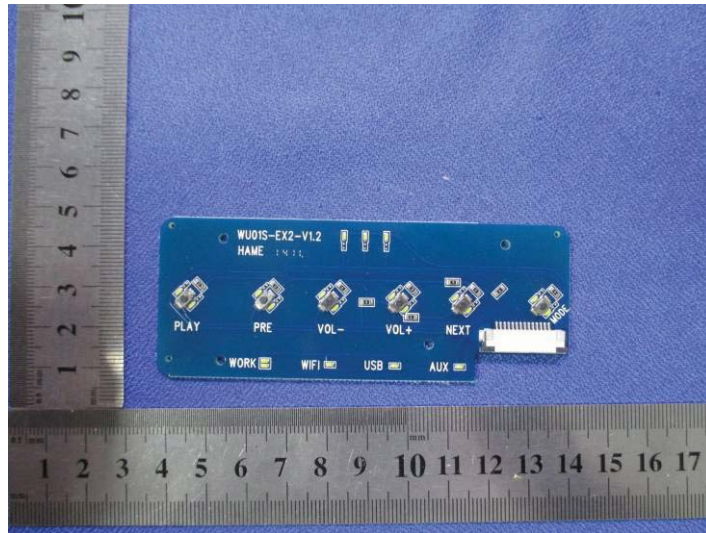

.....End of Report.....