



FCC PART 15 SUBPART C TEST REPORT

Report Reference No......: **CTL1411182761-WB01**

Compiled by

(position+printed name+signature)...: File administrators Jacky Chen

Name of the organization performing the tests

Test Engineer Tracy Qi

(position+printed name+signature)...:

Approved by

(position+printed name+signature)...: Manager Tracy Qi

Date of issue.....: Dec. 17, 2014

Test Firm.....: **Shenzhen CTL Testing Technology Co., Ltd.**

Address.....: Floor 1-A, Baisha Technology Park, No. 3011, Shahexi Road, Nanshan, Shenzhen 518055 China.

Applicant's name.....: **USA 111 INC.**

Address.....: 5885 Green Pointe Dr. Suite B Groveport OH, 43125 United States

Test specification:

Standard: **FCC Part 15.249:** Operation within the bands 920-928 MHz, 2400-2483.5 MHz, 5725-5850 MHz and 24.0 - 24.25 GHz

TRF Originator.....: Shenzhen CTL Testing Technology Co., Ltd.

Master TRF.....: Dated 2011-01

Shenzhen CTL Testing Technology Co., Ltd. All rights reserved.

This publication may be reproduced in whole or in part for non-commercial purposes as long as the Shenzhen CTL Testing Technology Co., Ltd. is acknowledged as copyright owner and source of the material. Shenzhen CTL Testing Technology Co., Ltd. takes no responsibility for and will not assume liability for damages resulting from the reader's interpretation of the reproduced material due to its placement and context.

Test item description : **Mobile phone**

FCC ID.....: **2ADOV-IRULUV1**

Trade Mark: iRULU

Model/Type reference.....: V1

GSM/WCDMA

Transmit: 2G:GSM 850: 824~849MHz, PCS 1900: 1850~1910MHz
3G:WCDMA Band II: 1850-1910MHz,
WCDMA Band V: 824~849MHz

Receive: 2G:GSM 850: 869~894MHz, PCS 1900: 1930~1990MHz
3G:WCDMA Band II: 1930~1990MHz,
WCDMA Band V: 869~894MHz

Release Version: 2G:R99

3G:Rel-6

Type of modulation.....: 2G: GMSK for GSM/GPRS

3G: QPSK

GPRS Type	Class B
GPRS Class	Class 12
GPS	
work frequency	1575.42MHz
Type of modulation	BPSK
Bluetooth	
Work frequency	2402~2480MHz
Version.....	V3.0, V4.0
Type of modulation	FHSS
Data Rate.....	1Mbps(GFSK), 2Mbps(Pi/4 DQPSK), 3Mbps(8DPSK)
Wi-Fi	
Work frequency	802.11b/g/n(20MHz): 2412~2462MHz 802.11n(40MHz): 2422~2452MHz
Type of modulation	802.11b DSSS, 802.11g/n: OFDM
Data Rate.....	802.11b: 1/2/5.5/11 Mbps 802.11g: 6/9/12/18/24/36/48/54 Mbps 802.11n: up to 150 Mbps
Antenna Gain	-2.0 dBi for GSM850 and WCDMA Band V -2.0 dBi for PCS1900 and WCDMA Band II -3.0 dBi for Bluetooth and Wi-Fi
Antenna type	Internal
IMEI	356878021568635/356878021568643
Hardware version	E2109_V1.1
Software version.....	Android 4.4.2
Result.....	Positive

TEST REPORT

Test Report No. : CTL1411182761-WB01	Dec. 17, 2014
	Date of issue

Equipment under Test : Mobile phone

Model /Type : V1

Applicant : USA111 INC.

Address : 5885 Green Pointe Dr. Suite B Groveport OH, 43125 United States

Manufacturer SHENZHEN GOTRON ELECTRONIC CO., LTD

Address Room 15C, Block C of Electronic& Technology Building,2070 Shennan Middle Road, Shenzhen 518000 P.R.China

Test Result according to the standards on page 5:	Positive
--	-----------------

The test report merely corresponds to the test sample. It is not permitted to copy extracts of these test result without the written permission of the test laboratory.

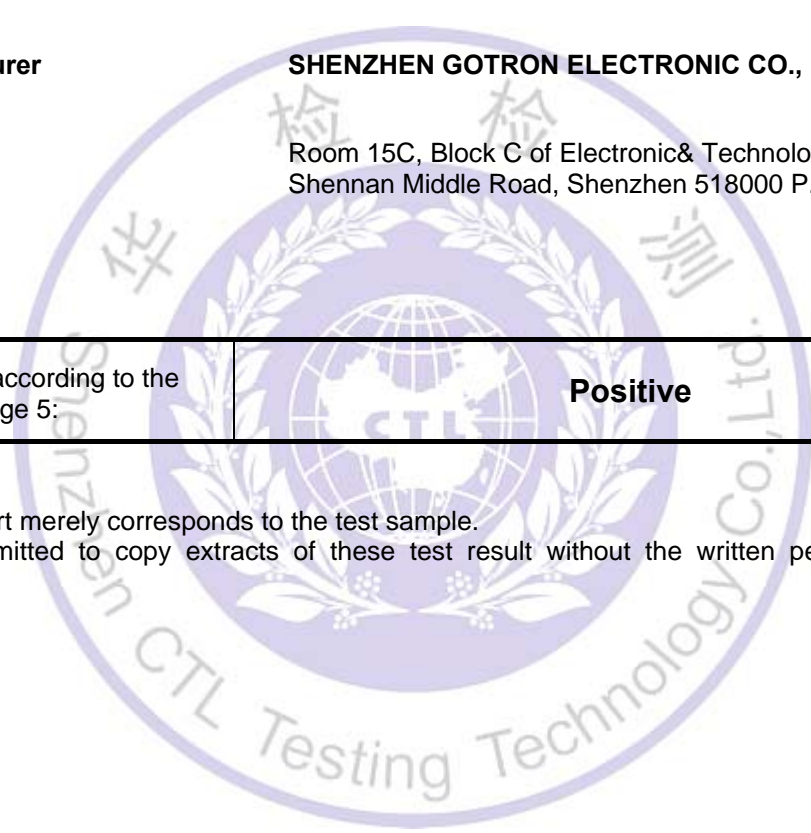

Contents

<u>1.</u>	<u>TEST STANDARDS</u>	<u>5</u>
<u>2.</u>	<u>SUMMARY</u>	<u>6</u>
2.1.	General Remarks	6
2.2.	Equipment Under Test	6
2.3.	Short description of the Equipment under Test (EUT)	6
2.4.	EUT operation mode	7
2.5.	EUT configuration	7
2.6.	Related Submittal(s) / Grant (s)	7
2.7.	Modifications	7
<u>3.</u>	<u>TEST ENVIRONMENT</u>	<u>8</u>
3.1.	Address of the test laboratory	8
3.2.	Test Facility	8
3.3.	Environmental conditions	8
3.4.	Configuration of Tested System	8
3.5.	Statement of the measurement uncertainty	9
3.6.	Equipments Used during the Test	10
<u>4.</u>	<u>TEST CONDITIONS AND RESULTS</u>	<u>11</u>
4.1.	Conducted Emissions Test	11
4.2.	Fundamental Emissions	14
4.3.	Transmitter Radiated Unwanted Emissions	15
4.4.	Band Edge Measurement	31
4.5.	Occupied Bandwidth Measurement	40
<u>5.</u>	<u>ANTENNA REQUIREMENT</u>	<u>45</u>
<u>6.</u>	<u>TEST SETUP PHOTOS OF THE EUT</u>	<u>46</u>
<u>7.</u>	<u>EXTERNAL AND INTERNAL PHOTOS OF THE EUT</u>	<u>48</u>

1. TEST STANDARDS

The tests were performed according to following standards:

[FCC Rules Part 15.249](#): Operation within the bands 902 - 928 MHz, 2400 - 2483.5 MHz, 5725 - 5875 MHz, and 24.0 - 24.25 GHz.

[ANSI C63.4-2009](#)



2. SUMMARY

2.1. General Remarks

Date of receipt of test sample : Nov. 22, 2014

Testing commenced on : Nov. 22, 2014

Testing concluded on : Dec. 17, 2014

2.2. Equipment Under Test

Power supply system utilised

Power supply voltage : 120V / 60 Hz 115V / 60Hz
 12 V DC 24 V DC
 Other (specified in blank below)

DC 3.7V from battery

2.3. Short description of the Equipment under Test (EUT)

The EUT is a **Mobile phone** work at 2402~2480 MHz support Bluetooth 3.0.
 Channel List:

Channel	Frequency (MHz)	Channel	Frequency (MHz)	Channel	Frequency (MHz)
00	2402	27	2429	54	2456
01	2403	28	2430	55	2457
02	2404	29	2431	56	2458
03	2405	30	2432	57	2459
04	2406	31	2433	58	2460
05	2407	32	2434	59	2461
06	2408	33	2435	60	2462
07	2409	34	2436	61	2463
08	2410	35	2437	62	2464
09	2411	36	2438	63	2465
10	2412	37	2439	64	2466
11	2413	38	2440	65	2467
12	2414	39	2441	66	2468
13	2415	40	2442	67	2469
14	2416	41	2443	68	2470
15	2417	42	2444	69	2471
16	2418	43	2445	70	2472
17	2419	44	2446	71	2473
18	2420	45	2447	72	2474
19	2421	46	2448	73	2475
20	2422	47	2449	74	2476
21	2423	48	2450	75	2477
22	2424	49	2451	76	2478
23	2425	50	2452	77	2479
24	2426	51	2453	78	2480
25	2427	52	2454		
26	2428	53	2455		

Modulation: 1Mbps(GFSK), 2Mbps(Pi/4 DQPSK), 3Mbps(8DPSK)

For more details, refer to the user's manual of the EUT.

Serial number: Prototype

2.4. EUT operation mode

Test Mode(TM)	Description	Remark
TM1	Bottom Channel Transmitting	/
TM2	Middle Channel Transmitting	/
TM3	Top Channel Transmitting	/

The field strength of radiation emission was measured in the following position: EUT stand-up position (Y axis), lie-down position (X, Z axis).

The following data show only with the worst case setup.

Data of the worst mode is reported by this report.

Remark: All modulation as 1Mbps(GFSK), 2Mbps(Pi/4 DQPSK), 3Mbps(8DPSK) all have been tested only the worst case GFSK is reported.

2.5. EUT configuration

The following peripheral devices and interface cables were connected during the measurement:

○ - supplied by the manufacturer

● - supplied by the lab

● AC adapter
 Manufacturer : SHENZHEN GOTRON ELECTRONIC CO., LTD

Model No. : JHD-AP006U-050100BB-2

● Earphone
 Manufacturer : SHENZHEN GOTRON ELECTRONIC CO., LTD

Model No. : ----

2.6. Related Submittal(s) / Grant (s)

This submittal(s) (test report) is intended for FCC ID: **2ADOV-IRULUV1** filing to comply with Section 15.249 of the FCC Part 15, Subpart C Rules.

2.7. Modifications

No modifications were implemented to meet testing criteria.

3. TEST ENVIRONMENT

3.1. Address of the test laboratory

Shenzhen CTL Testing Technology Co., Ltd.
 Floor 1-A, Baisha Technology Park, No. 3011, Shahexi Road, Nanshan, Shenzhen 518055 China

There is one 3m semi-anechoic chamber and two line conducted labs for final test. The Test Sites meet the requirements in documents ANSI C63.4 and CISPR 22/EN 55022 requirements.

3.2. Test Facility

The test facility is recognized, certified, or accredited by the following organizations:

IC Registration No.: 9618B

The 3m alternate test site of Shenzhen CTL Testing Technology Co., Ltd. EMC Laboratory has been registered by Certification and Engineer Bureau of Industry Canada for the performance of with Registration No.: 9618B on November 13, 2013.

FCC-Registration No.: 970318

Shenzhen CTL Testing Technology Co., Ltd. EMC Laboratory has been registered and fully described in a report filed with the (FCC) Federal Communications Commission. The acceptance letter from the FCC is maintained in our files. Registration 970318, December 19, 2013.

3.3. Environmental conditions

During the measurement the environmental conditions were within the listed ranges:

Temperature: 15-35 ° C

Humidity: 30-60 %

Atmospheric pressure: 950-1050mbar

3.4. Configuration of Tested System

Fig. 2-1 Configuration of Tested System

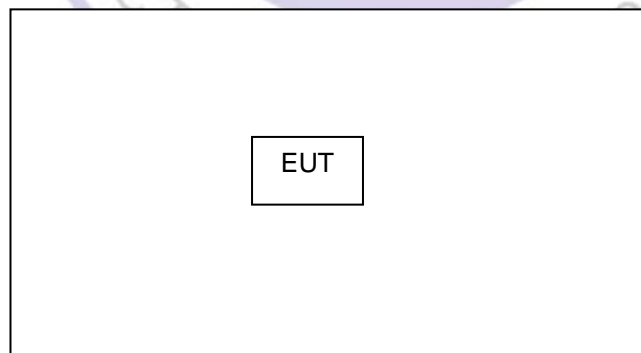

Cable List and Details

Cable Description	Length (M)	Shielded/Unshielded	With Core/Without Core
/			

3.5. Statement of the measurement uncertainty

The data and results referenced in this document are true and accurate. The reader is cautioned that there may be errors within the calibration limits of the equipment and facilities. The measurement uncertainty was calculated for all measurements listed in this test report acc. to CISPR 16 - 4 „Specification for radio disturbance and immunity measuring apparatus and methods – Part 4: Uncertainty in EMC Measurements“ and is documented in the Shenzhen CTL Testing Technology Co., Ltd. quality system acc. to DIN EN ISO/IEC 17025. Furthermore, component and process variability of devices similar to that tested may result in additional deviation. The manufacturer has the sole responsibility of continued compliance of the device.

Hereafter the best measurement capability for CTL laboratory is reported:

Test	Range	Measurement Uncertainty	Notes
Radiated Emission	30~1000MHz	4.10dB	(1)
Radiated Emission	1~26.5GHz	4.32dB	(1)
Conducted Disturbance	0.15~30MHz	3.20dB	(1)

- (1) This uncertainty represents an expanded uncertainty expressed at approximately the 95% confidence level using a coverage factor of k=2.



3.6. Equipments Used during the Test

Test Equipment	Manufacturer	Model No.	Serial No.	Calibration Date	Calibration Due Date
Bilog Antenna	Sunol Sciences Corp.	JB1	A061713	2014/07/12	2015/07/11
EMI Test Receiver	R&S	ESCI	103710	2014/07/10	2015/07/09
Spectrum Analyzer	Agilent	E4407B	MY45108355	2014/07/06	2015/07/05
Controller	EM Electronics	Controller EM 1000	N/A	2014/07/06	2015/07/05
Horn Antenna	Sunol Sciences Corp.	DRH-118	A062013	2014/07/12	2015/07/11
Horn Antenna	SCHWARZBECK	BBHA9170	1562	2014/07/12	2015/07/11
Active Loop Antenna	SCHWARZBECK	FMZB1519	1519-037	2014/07/12	2015/07/11
LISN	R&S	ENV216	101316	2014/07/10	2015/07/09
LISN	SCHWARZBECK	NSLK8127	8127687	2014/07/10	2015/07/09
Microwave Preamplifier	HP	8349B	3155A00882	2014/07/10	2015/07/09
Amplifier	HP	8447D	3113A07663	2014/07/10	2015/07/09
Transient Limiter	Com-Power	LIT-153	532226	2014/07/10	2015/07/09
Radio Communication Tester	R&S	CMU200	3655A03522	2014/07/06	2015/07/05
Temperature/Humidity Meter	zhicheng	ZC1-2	22522	2014/07/10	2015/07/09
SIGNAL GENERATOR	HP	8647A	3200A00852	2014/07/10	2015/07/09
Wideband Peak Power Meter	Anritsu	ML2495A	220.23.35	2014/07/06	2015/07/05
Climate Chamber	ESPEC	EL-10KA	A20120523	2014/07/06	2015/07/05
High-Pass Filter	K&L	9SH10-2700/X12750-O/O	/	2014/07/06	2015/07/05
High-Pass Filter	K&L	41H10-1375/U12750-O/O	/	2014/07/06	2015/07/05
RF Cable	HUBER+SUHNER	RG214	/	2014/07/09	2015/07/08

4. TEST CONDITIONS AND RESULTS

4.1. Conducted Emissions Test

TEST CONFIGURATION

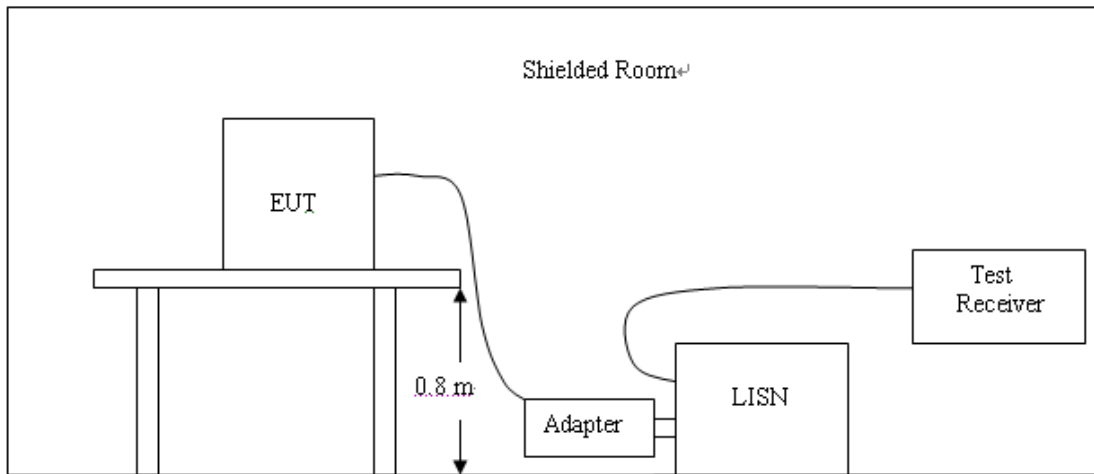

TEST PROCEDURE

- 1 The equipment was set up as per the test configuration to simulate typical actual usage per the user's manual. The EUT is a tabletop system, a wooden table with a height of 0.8 meters is used and is placed on the ground plane as per ANSI C63.4.
- 2 Support equipment, if needed, was placed as per ANSI C63.4.
- 3 All I/O cables were positioned to simulate typical actual usage as per ANSI C63.4.
- 4 If a EUT received DC power from the USB Port of Notebook PC, the PC's adapter received AC120V/60Hz power through a Line Impedance Stabilization Network (LISN) which supplied power source and was grounded to the ground plane.
- 5 All support equipments received AC power from a second LISN, if any.
- 6 The EUT test program was started. Emissions were measured on each current carrying line of the EUT using a spectrum Analyzer / Receiver connected to the LISN powering the EUT. The LISN has two monitoring points: Line 1 (Hot Side) and Line 2 (Neutral Side). Two scans were taken: one with Line 1 connected to Analyzer / Receiver and Line 2 connected to a 50 ohm load; the second scan had Line 1 connected to a 50 ohm load and Line 2 connected to the Analyzer / Receiver.
- 7 Analyzer / Receiver scanned from 150 KHz to 30MHz for emissions in each of the test modes.
- 8 During the above scans, the emissions were maximized by cable manipulation.

The RBW/VBW for 150KHz to 30MHz: 9KHz

CONDUCTED POWER LINE EMISSION LIMIT

For unintentional device, according to § 15.107(a) Line Conducted Emission Limits is as following :

Frequency (MHz)	Maximum RF Line Voltage (dBµV)			
	CLASS A		CLASS B	
	Q.P.	Ave.	Q.P.	Ave.
0.15 - 0.50	79	66	66-56*	56-46*
0.50 - 5.00	73	60	56	46
5.00 - 30.0	73	60	60	50

* Decreasing linearly with the logarithm of the frequency

For intentional device, according to §15.207(a) Line Conducted Emission Limit is same as above table.

TEST RESULTS

All the test modes (TM1, TM2, TM3) completed for test. The worst case is TM1; the test data of this mode was reported.

SCAN TABLE: "Voltage (9K-30M) FIN"
 Short Description: 150K-30M Voltage

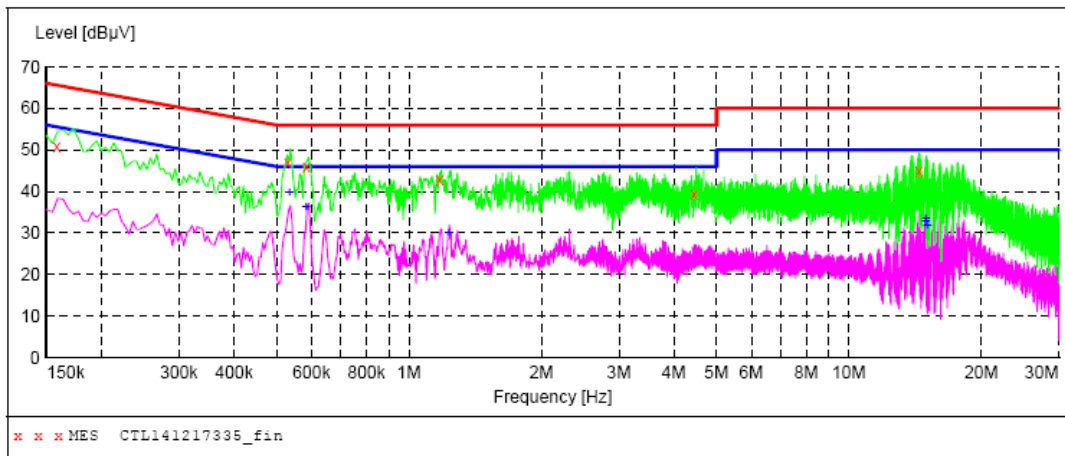

MEASUREMENT RESULT: "CTL141217335_fin"

12/17/2014 9:29AM

Frequency MHz	Level dBµV	Transd dB	Limit dBµV	Margin dB	Detector	Line	PE
0.158000	50.70	10.2	66	14.9	QP	L1	GND
0.530000	46.80	10.2	56	9.2	QP	L1	GND
0.584000	45.90	10.2	56	10.1	QP	L1	GND
1.172000	42.80	10.3	56	13.2	QP	L1	GND
4.442000	39.30	10.4	56	16.7	QP	L1	GND
14.414000	44.80	10.7	60	15.2	QP	L1	GND

MEASUREMENT RESULT: "CTL141217335_fin2"

12/17/2014 9:29AM

Frequency MHz	Level dBµV	Transd dB	Limit dBµV	Margin dB	Detector	Line	PE
0.536000	39.60	10.2	46	6.4	AV	L1	GND
0.584000	36.40	10.2	46	9.6	AV	L1	GND
1.232000	30.00	10.3	46	16.0	AV	L1	GND
14.954000	33.50	10.7	50	16.5	AV	L1	GND
14.960000	32.80	10.7	50	17.2	AV	L1	GND
15.062000	31.70	10.7	50	18.3	AV	L1	GND

SCAN TABLE: "Voltage (9K-30M) FIN"
 Short Description: 150K-30M Voltage

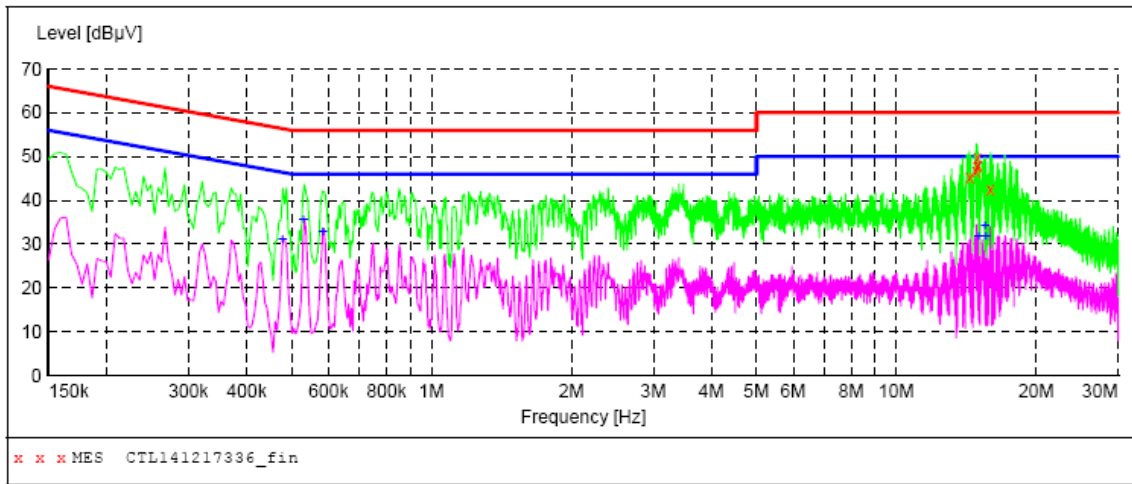

MEASUREMENT RESULT: "CTL141217336_fin"

12/17/2014 9:32AM

Frequency MHz	Level dBuV	Transd dB	Limit dBuV	Margin dB	Detector	Line	PE
14.372000	45.10	10.7	60	14.9	QP	N	GND
14.834000	46.60	10.7	60	13.4	QP	N	GND
14.900000	47.70	10.7	60	12.3	QP	N	GND
14.936000	49.60	10.7	60	10.4	QP	N	GND
14.990000	47.90	10.7	60	12.1	QP	N	GND
15.938000	42.40	10.7	60	17.6	QP	N	GND

MEASUREMENT RESULT: "CTL141217336_fin2"

12/17/2014 9:32AM

Frequency MHz	Level dBuV	Transd dB	Limit dBuV	Margin dB	Detector	Line	PE
0.478000	31.10	10.2	46	15.3	AV	N	GND
0.530000	35.40	10.2	46	10.6	AV	N	GND
0.584000	32.60	10.2	46	13.4	AV	N	GND
15.044000	31.70	10.7	50	18.3	AV	N	GND
15.524000	34.30	10.7	50	15.7	AV	N	GND
15.578000	31.90	10.7	50	18.1	AV	N	GND

4.2. Fundamental Emissions

TEST CONFIGURATION

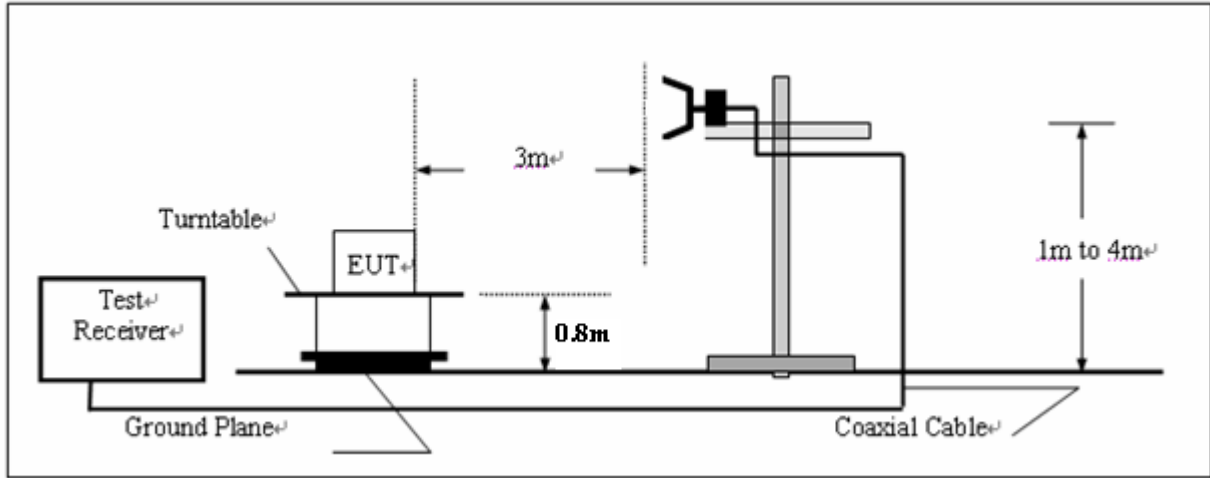

Fundamental Emissions Limit

2400-2483.5 MHz Band: 94 dBuV/m (average)

For the transmitter emissions shall be measured using following options below:

Remark:

RBW 1MHz, VBW 3MHz, PK Detector for PK value.

RBW 1MHz, VBW 10Hz, PK Detector for AV value.

TEST RESULTS

Field Strength of Fundamental Emissions Result					
Modulation	Frequency	Max.Fundamental	Margin	Limit	Type
Mode	(MHz)	(dBuV/m)@3m	(dB)	(dBuV/m)@3m	
GFSK	2402	92.76	21.24	114	peak
GFSK	2402	74.61	19.39	94	average
GFSK	2441	93.04	20.96	114	peak
GFSK	2441	73.96	20.04	94	average
GFSK	2480	93.14	20.86	114	peak
GFSK	2480	73.09	20.91	94	average

Note: Horizontal and Vertical polarity all have been tested, Vertical polarity is the worst case and reported.

4.3. Transmitter Radiated Unwanted Emissions

TEST CONFIGURATION

(A) Radiated Emission Test Set-Up, Frequency Below 30MHz

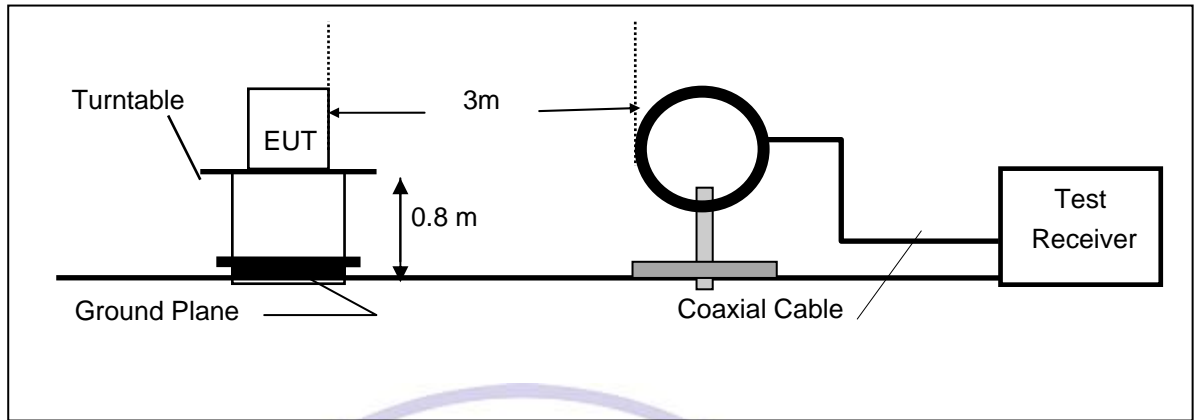

(B) Radiated Emission Test Set-Up, Frequency below 1000MHz

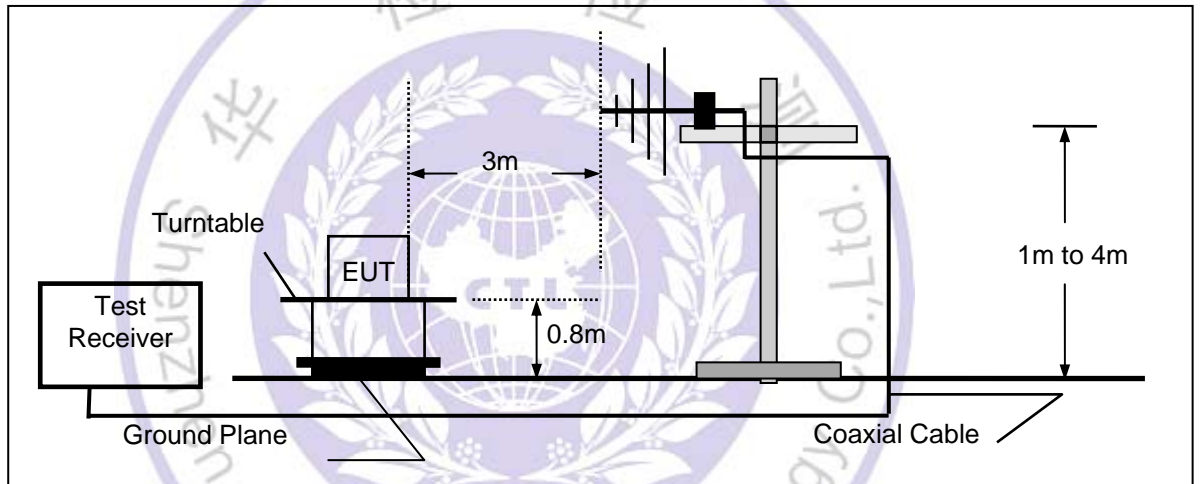

(C) Radiated Emission Test Set-Up, Frequency above 1000MHz

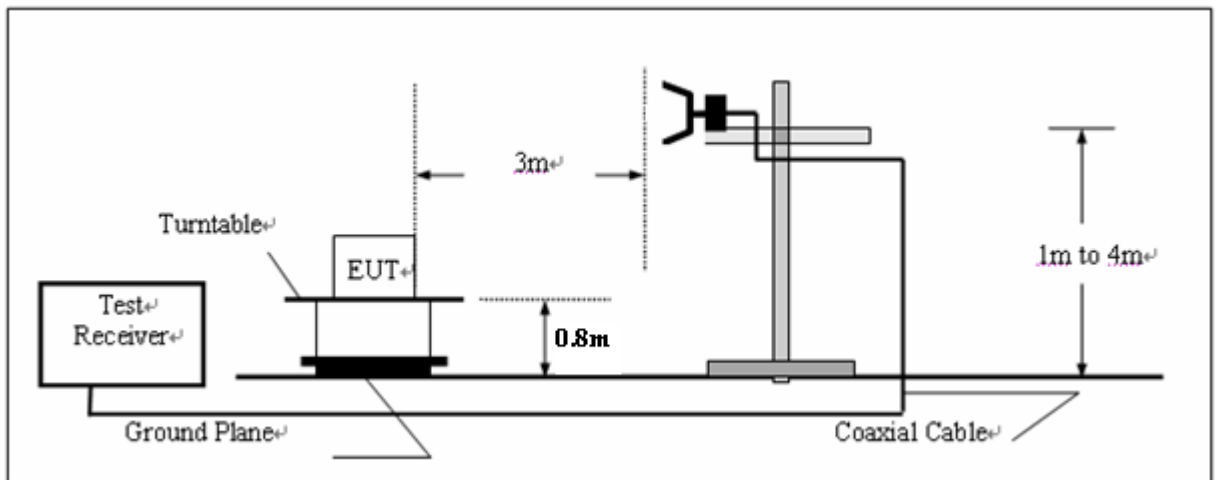

FIELD STRENGTH CALCULATION

The field strength is calculated by adding the Antenna Factor and Cable Factor and subtracting the Amplifier Gain and Duty Cycle Correction Factor(if any) from the measured reading. The basic equation with a sample calculation is as follows:

$$FS = RA + AF + CL - AG$$

Where FS = Field Strength	CL = Cable Attenuation Factor (Cable Loss)
RA = Reading Amplitude	AG = Amplifier Gain
AF = Antenna Factor	

RADIATION LIMIT

For unintentional device, according to § 15.109(a), except for Class A digital devices, the field strength of radiated emissions from unintentional radiators at a distance of 3 meters shall not exceed the following values:

Frequency (MHz)	Distance (Meters)	Radiated (dBµV/m)	Radiated (µV/m)
30-88	3	40.0	100
88-216	3	43.5	150
216-960	3	46.0	200
Above 960	3	54.0	500

For intentional device, according to § 15.209(a), the general requirement of field strength of radiated emissions from intentional radiators at a distance of 3 meters shall not exceed the above table.

TEST PROCEDURE

1. The EUT is placed on a turntable, which is 0.8m above ground plane.
2. The turntable shall be rotated for 360 degrees to determine the position of maximum emission level.
3. EUT is set 3m away from the receiving antenna, which is varied from 1m to 4m to find out the highest emissions.
4. Maximum procedure was performed on the six highest emissions to ensure EUT compliance.
5. And also, each emission was to be maximized by changing the polarization of receiving antenna both horizontal and vertical.
6. Repeat above procedures until the measurements for all frequencies are complete.
7. Based on the Frequency Generator in the device include 26MHz. The test frequency range from 9KHz to 25GHz per FCC PART 15.33(a).

Note:

Three axes are chosen for pretest, the Y axis is the worst mode for final test.

For battery operated equipment, the equipment tests shall be performed using a fully battery.

TEST RESULTS

All the test modes (TM1, TM2, TM3) completed for test. The worst case of Radiated Emission is TM1; the test data of this mode was reported.

Below 1GHz Test Results:

SWEEP TABLE: "test (30M-1G)"

Short Description:		Field Strength			
Start	Stop	Detector	Meas. Time	IF Bandw.	Transducer
Frequency	Frequency				
30.0 MHz	1.0 GHz	MaxPeak	300.0 ms	120 kHz	JB1

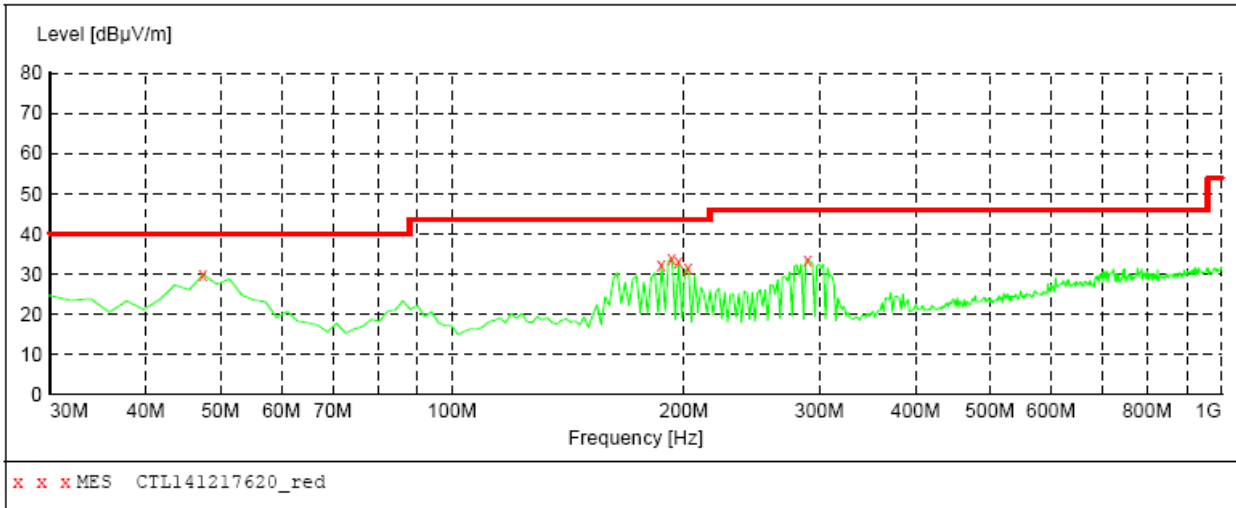

MEASUREMENT RESULT: "CTL141217620_red"

12/17/2014 8:57AM

Frequency MHz	Level dBuV/m	Transd dB	Limit dBuV/m	Margin dB	Det.	Height cm	Azimuth deg	Polarization
47.460000	29.90	9.1	40.0	10.1	---	0.0	0.00	VERTICAL
187.140000	32.10	13.4	43.5	11.4	---	0.0	0.00	VERTICAL
192.960000	33.80	13.5	43.5	9.7	---	0.0	0.00	VERTICAL
196.840000	33.00	13.8	43.5	10.5	---	0.0	0.00	VERTICAL
202.660000	31.30	14.4	43.5	12.2	---	0.0	0.00	VERTICAL
289.960000	33.50	15.4	46.0	12.5	---	0.0	0.00	VERTICAL

Remark:

- (1) Measuring frequencies from 9 KHz to the 1 GHz, Radiated emission test from 9KHz to 30MHz was verified, and no any emission was found except system noise floor.
- (2) * denotes emission frequency which appearing within the Restricted Bands specified in provision of 15.205, then the general radiated emission limits in 15.209 apply.
- (3) The IF bandwidth of EMI Test Receiver between 30MHz to 1GHz was 120KHz, 1 MHz for measuring above 1 GHz, below 30MHz was 10KHz.

SWEEP TABLE: "test (30M-1G)"

Short Description:		Field Strength			
Start	Stop	Detector	Meas. Time	IF Bandw.	Transducer
Frequency 30.0 MHz	Frequency 1.0 GHz	MaxPeak	300.0 ms	120 kHz	JB1

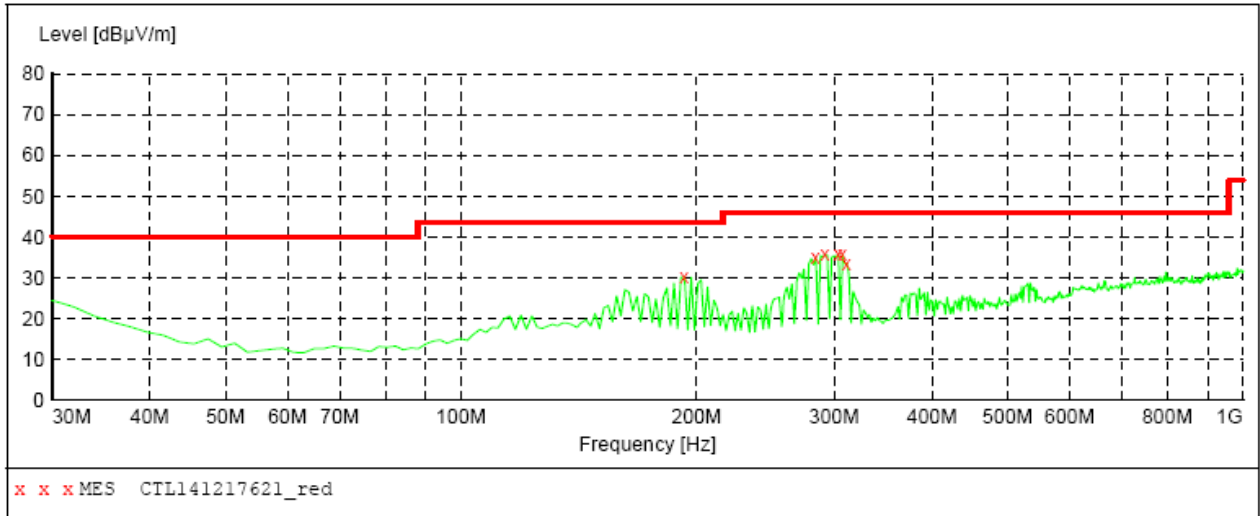

MEASUREMENT RESULT: "CTL141217621_red"

12/17/2014 8:59AM

Frequency MHz	Level dBµV/m	Transd dB	Limit dBµV/m	Margin dB	Det.	Height cm	Azimuth deg	Polarization
192.960000	30.20	13.5	43.5	13.3	---	0.0	0.00	HORIZONTAL
284.140000	34.90	15.4	46.0	11.1	---	0.0	0.00	HORIZONTAL
291.900000	35.70	15.4	46.0	10.3	---	0.0	0.00	HORIZONTAL
303.540000	35.80	15.5	46.0	10.2	---	0.0	0.00	HORIZONTAL
307.420000	35.70	15.6	46.0	10.3	---	0.0	0.00	HORIZONTAL
311.300000	33.50	15.7	46.0	12.5	---	0.0	0.00	HORIZONTAL

Remark:

- (1) Measuring frequencies from 9 KHz to the 1 GHz, Radiated emission test from 9KHz to 30MHz was verified, and no emission was found except system noise floor.
- (2) * denotes emission frequency which appearing within the Restricted Bands specified in provision of 15.205, then the general radiated emission limits in 15.209 apply.
- (3) The IF bandwidth of EMI Test Receiver between 30MHz to 1GHz was 120KHz, 1 MHz for measuring above 1 GHz, below 30MHz was 10KHz.

Above 1 GHz Test Results:

Bottom Channel (2402MHz):

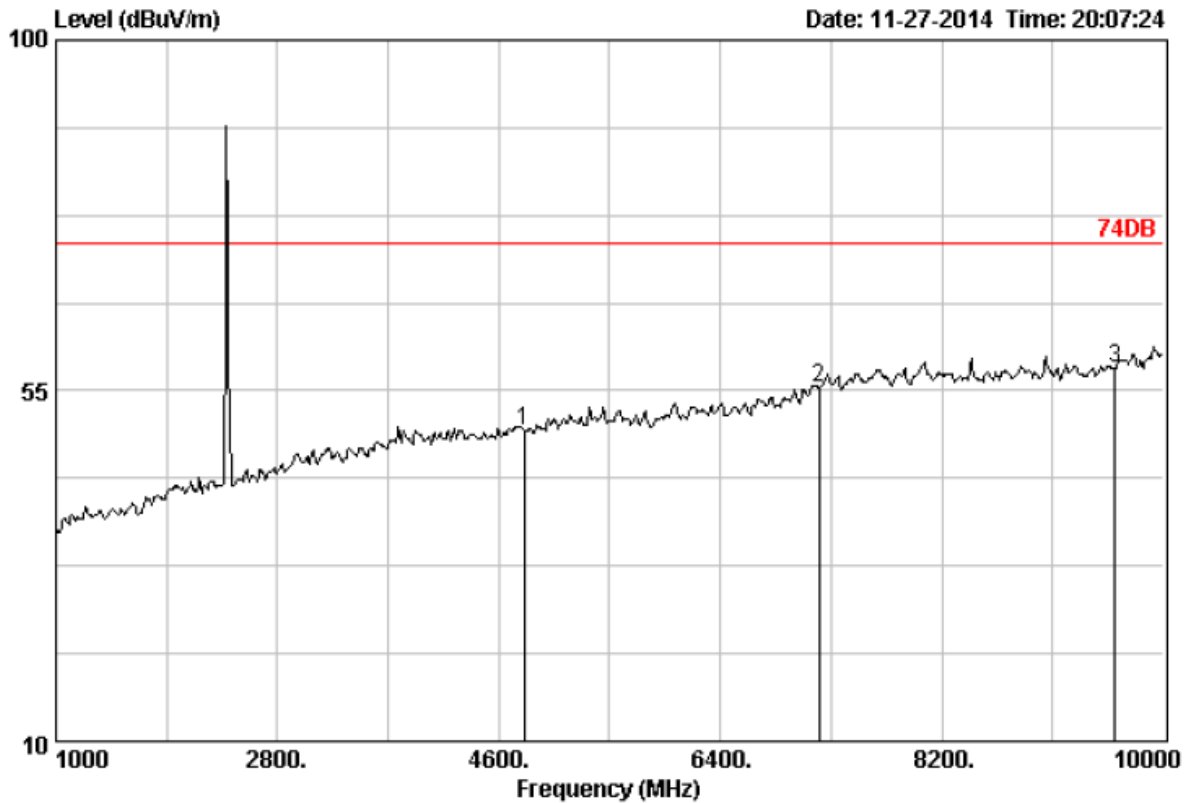

Site no. : 3m Chamber
 Dis. / Ant. : 3m DRH-118
 Limit : 74DB
 Env. / Ins. : 23*C/54%
 Engineer :
 EUT :
 Power :
 M/N :
 Test Mode :

Data no. : 979
 Ant. pol. : HORIZONTAL

	Freq. (MHz)	Ant. Factor (dB)	Cable Loss (dB)	Reading (dBuV)	Emission Level (dBuV/m)	Limits (dBuV/m)	Margin (dB)	Remark
1	4804.00	33.48	6.91	43.78	49.83	74.00	24.17	Peak
2	7206.00	36.92	9.18	44.39	55.46	74.00	18.54	Peak
3	9608.00	38.53	10.97	44.27	57.78	74.00	16.22	Peak

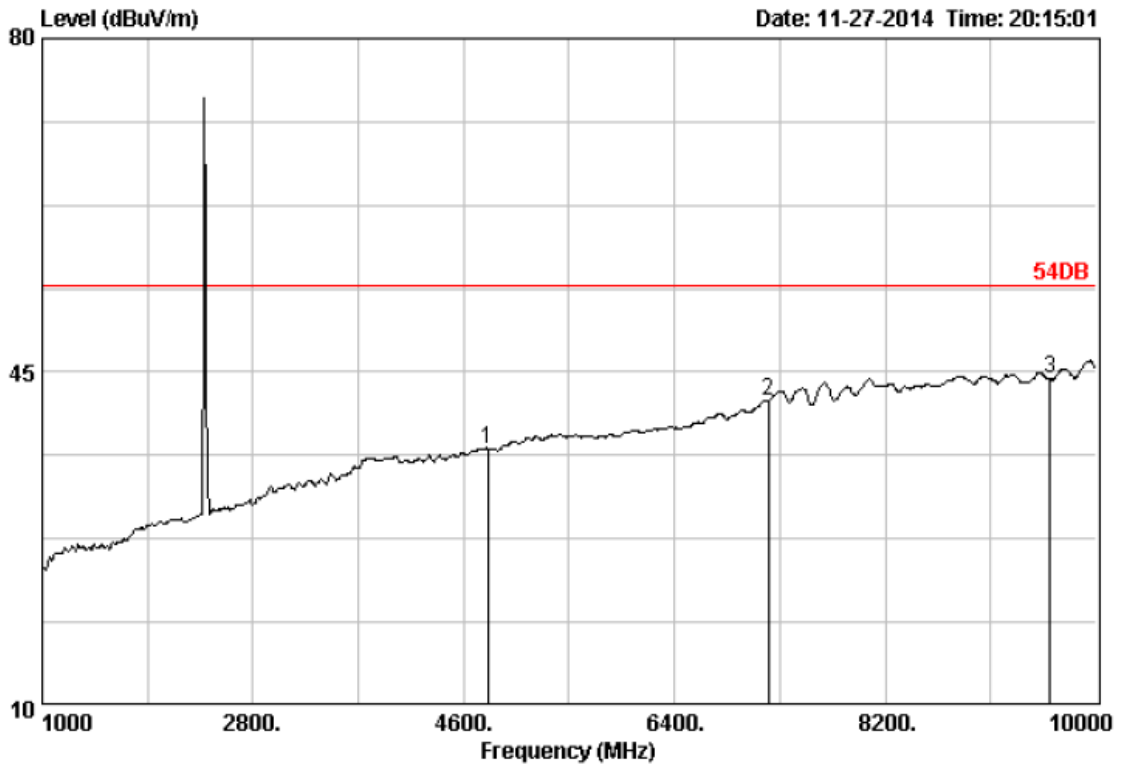

Site no. : 3m Chamber
 Dis. / Ant. : 3m DRH-118
 Limit : 54DB
 Env. / Ins. : 23*C/54%
 Engineer :
 EUT :
 Power :
 M/N :
 Test Mode :
 Data no. : 981
 Ant. pol. : HORIZONTAL

	Freq. (MHz)	Ant. Factor (dB)	Cable Loss (dB)	Reading (dBuV)	Emission			Remark
					Level (dBuV/m)	Limits (dBuV/m)	Margin (dB)	
1	4804.00	33.48	6.91	30.87	36.92	54.00	17.08	Average
2	7206.00	36.92	9.18	30.97	42.04	54.00	11.96	Average
3	9608.00	38.53	10.97	30.73	44.24	54.00	9.76	Average

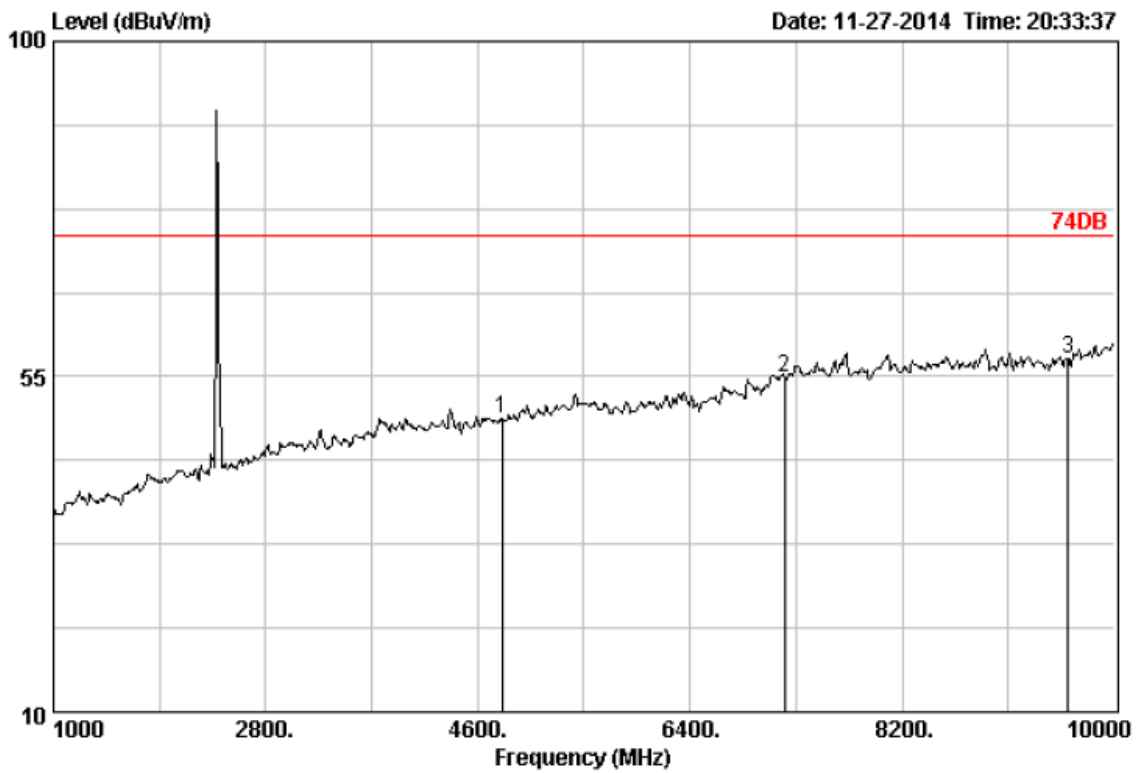

Site no. : 3m Chamber
 Dis. / Ant. : 3m DRH-118
 Limit : 74DB
 Env. / Ins. : 23°C/54%
 Engineer :
 EUT :
 Power :
 M/N :
 Test Mode :

Data no. : 984
 Ant. pol. : VERTICAL

	Freq. (MHz)	Ant. Factor (dB)	Cable Loss (dB)	Reading (dBuV)	Emission Level (dBuV/m)	Limits (dBuV/m)	Margin (dB)	Remark
1	4804.00	33.48	6.91	43.24	49.29	74.00	24.71	Peak
2	7206.00	36.92	9.18	43.81	54.88	74.00	19.12	Peak
3	9608.00	38.53	10.97	43.92	57.43	74.00	16.57	Peak

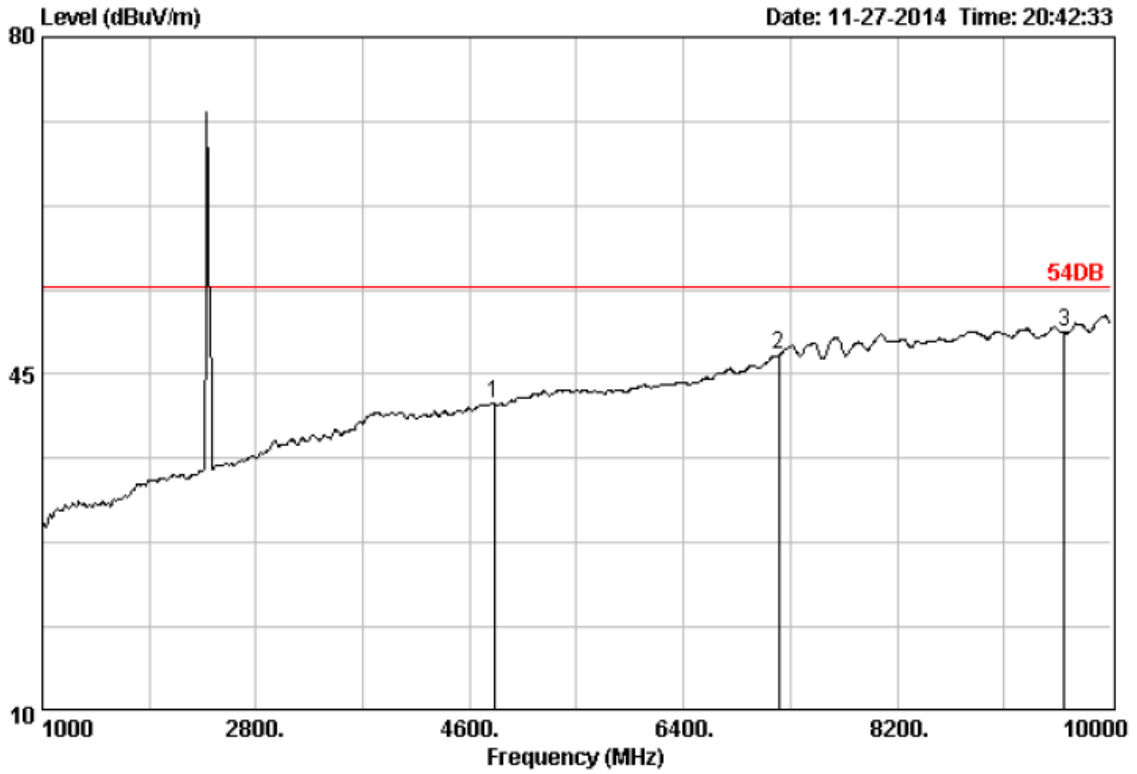

Site no. : 3m Chamber
 Dis. / Ant. : 3m DRH-118
 Limit : 54DB
 Env. / Ins. : 23*C/54%
 Engineer :
 EUT :
 Power :
 M/N :
 Test Mode :

Data no. : 986
 Ant. pol. : VERTICAL

Freq. (MHz)	Ant. Factor (dB)	Cable Loss (dB)	Reading (dBuV)	Emission			Remark
				Level (dBuV/m)	Limits (dBuV/m)	Margin (dB)	
1	33.48	6.91	35.87	41.92	54.00	12.08	Average
2	36.92	9.18	35.94	47.01	54.00	6.99	Average
3	38.53	10.97	35.78	49.29	54.00	4.71	Average

Middle Channel (2441 MHz):

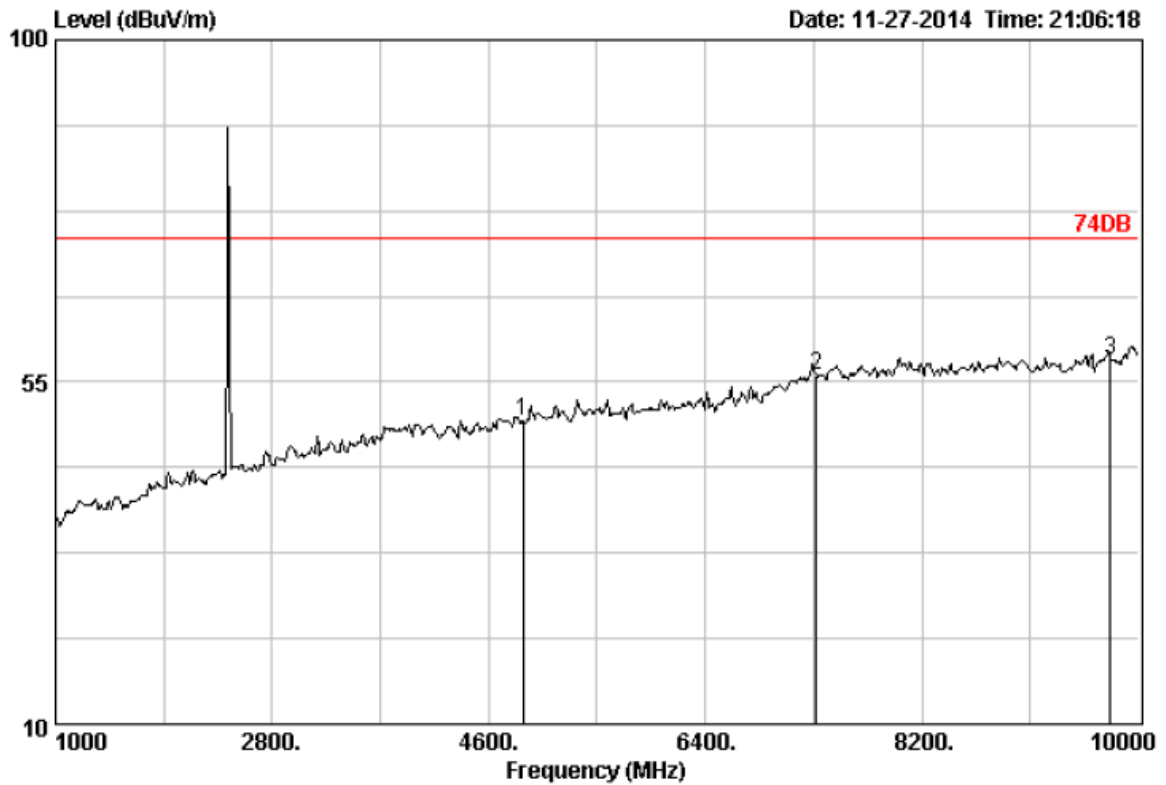

Site no. : 3m Chamber
 Dis. / Ant. : 3m DRH-118
 Limit : 74DB
 Env. / Ins. : 23°C/54%
 Engineer :
 EUT :
 Power :
 M/N :
 Test Mode :

Data no. : 990
 Ant. pol. : HORIZONTAL

	Freq. (MHz)	Ant. Factor (dB)	Cable Loss (dB)	Reading (dBuV)	Emission Level (dBuV/m)	Limits (dBuV/m)	Margin (dB)	Remark
1	4882.00	33.60	6.95	43.53	49.78	74.00	24.22	Peak
2	7323.00	37.46	9.23	44.22	55.91	74.00	18.09	Peak
3	9764.00	38.67	11.04	43.76	57.79	74.00	16.21	Peak

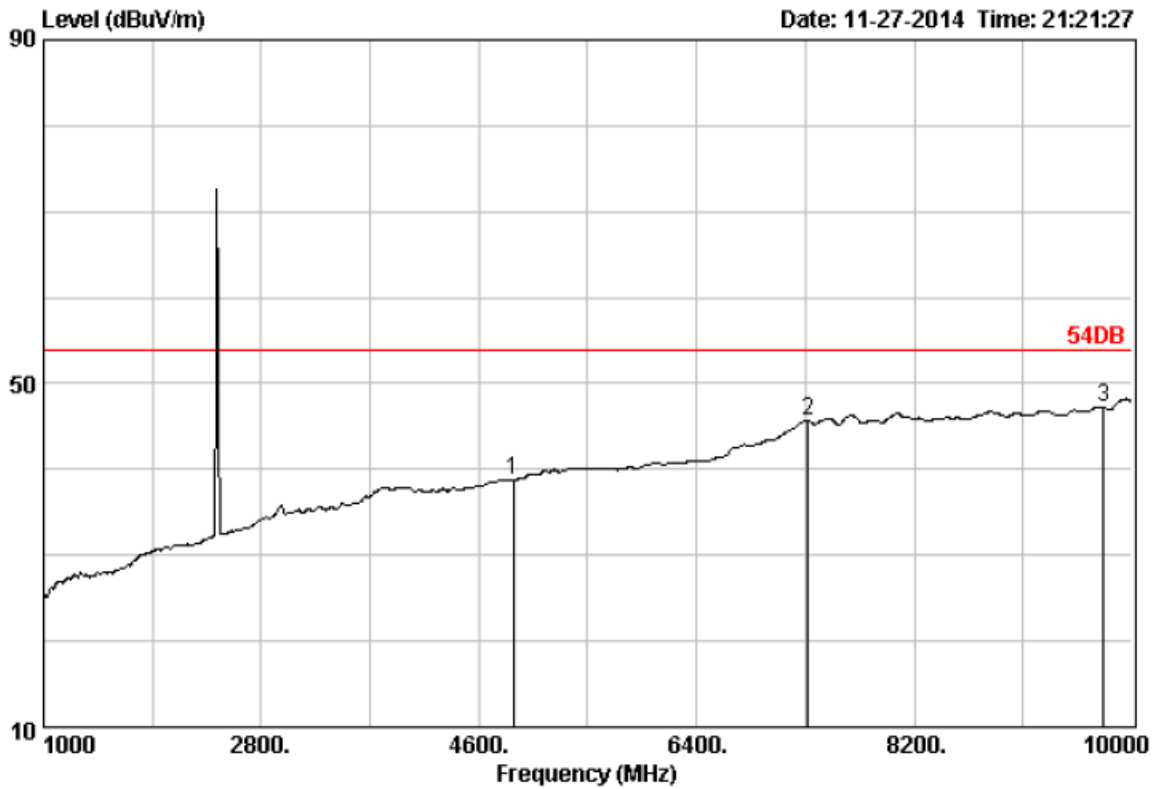

Site no. : 3m Chamber
 Dis. / Ant. : 3m DRH-118
 Limit : 54DB
 Env. / Ins. : 23*C/54%
 Engineer :
 EUT :
 Power :
 M/N :
 Test Mode :
 Data no. : 992
 Ant. pol. : HORIZONTAL

	Freq. (MHz)	Ant. Factor (dB)	Cable Loss (dB)	Reading (dBuV)	Emission			Remark
					Level (dBuV/m)	Limits (dBuV/m)	Margin (dB)	
1	4882.00	33.60	6.95	32.46	38.71	54.00	15.29	Average
2	7323.00	37.46	9.23	33.92	45.61	54.00	8.39	Average
3	9764.00	38.67	11.04	33.21	47.24	54.00	6.76	Average

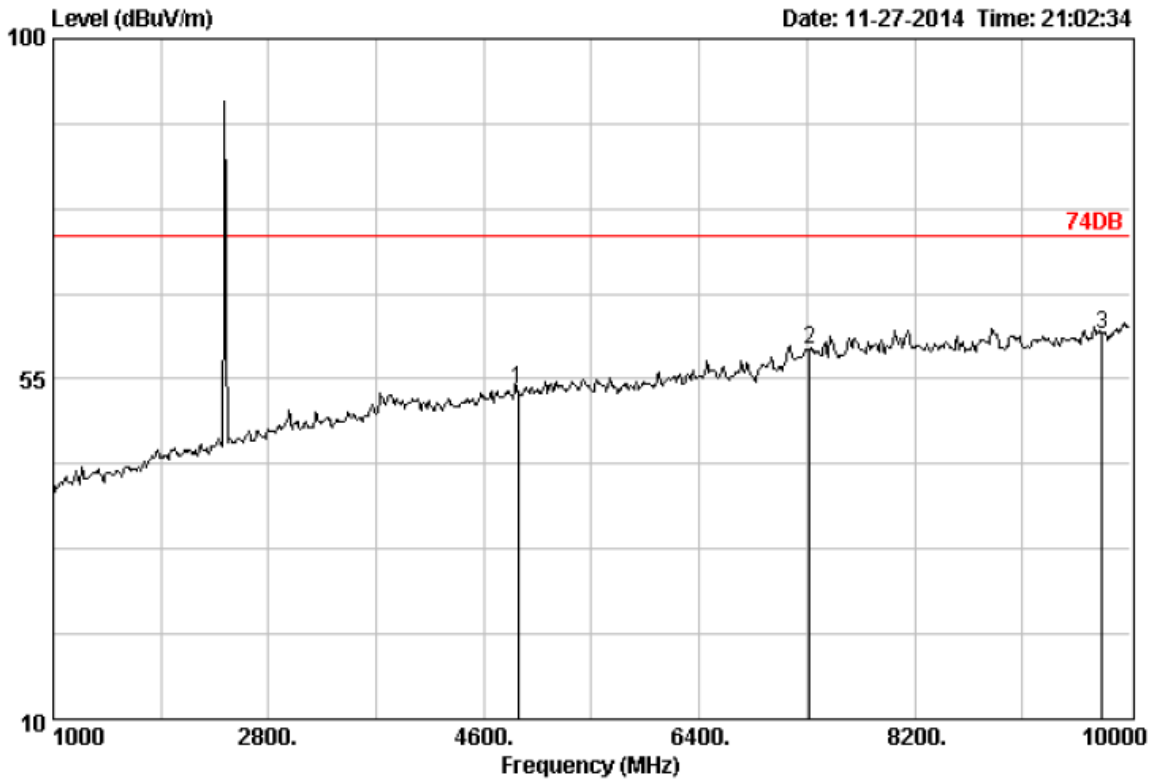

Site no. : 3m Chamber
 Dis. / Ant. : 3m DRH-118
 Limit : 74DB
 Env. / Ins. : 23*C/54%
 Engineer :
 EUT :
 Power :
 M/N :
 Test Mode :
 Data no. : 989
 Ant. pol. : VERTICAL

	Freq. (MHz)	Ant. Factor (dB)	Cable Loss (dB)	Reading (dBuV)	Emission Level (dBuV/m)	Limits (dBuV/m)	Margin (dB)	Remark
1	4882.00	33.60	6.95	47.33	53.58	74.00	20.42	Peak
2	7323.00	37.46	9.23	47.25	58.94	74.00	15.06	Peak
3	9764.00	38.67	11.04	46.93	60.96	74.00	13.04	Peak

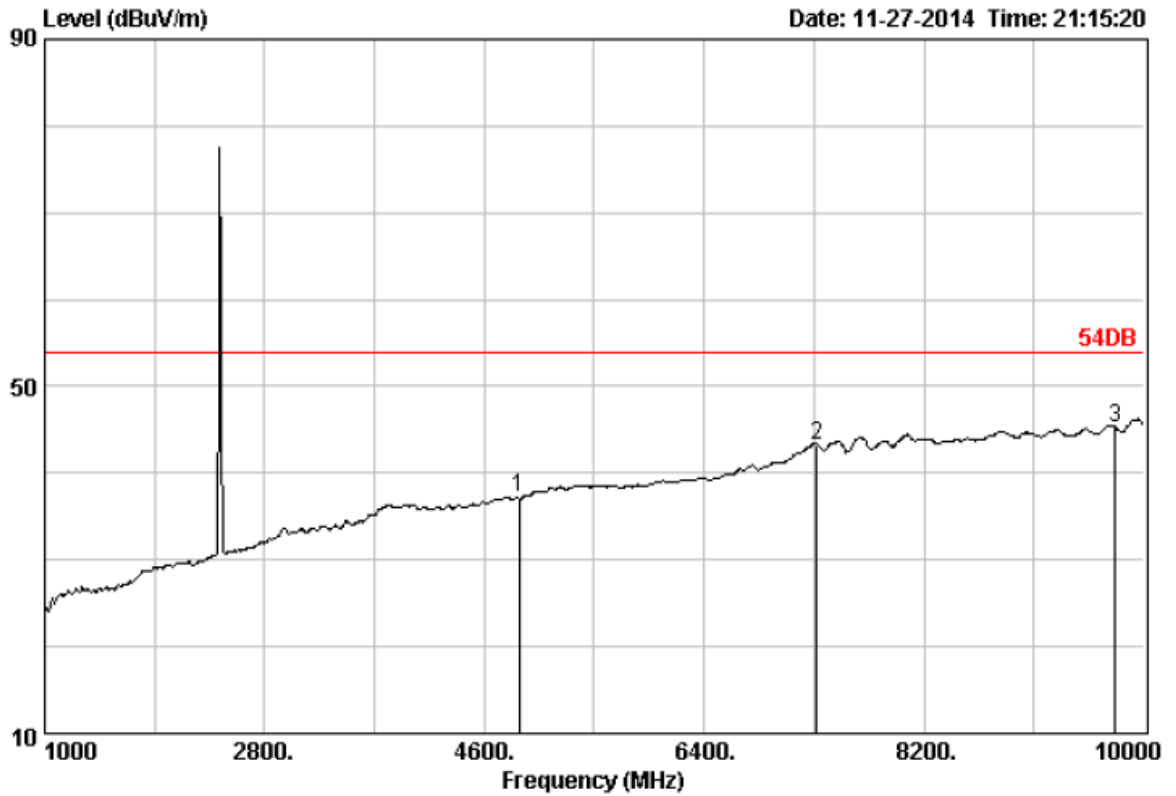

Site no. : 3m Chamber
 Dis. / Ant. : 3m DRH-118
 Limit : 54DB
 Env. / Ins. : 23*C/54%
 Engineer :
 EUT :
 Power :
 M/N :
 Test Mode :

Data no. : 991
 Ant. pol. : VERTICAL

	Freq. (MHz)	Ant. Factor (dB)	Cable Loss (dB)	Reading (dBuV)	Emission			Remark
					Level (dBuV/m)	Limits (dBuV/m)	Margin (dB)	
1	4882.00	33.60	6.95	30.83	37.08	54.00	16.92	Average
2	7323.00	37.46	9.23	31.60	43.29	54.00	10.71	Average
3	9764.00	38.67	11.04	31.22	45.25	54.00	8.75	Average

Top Channel (2480MHz):

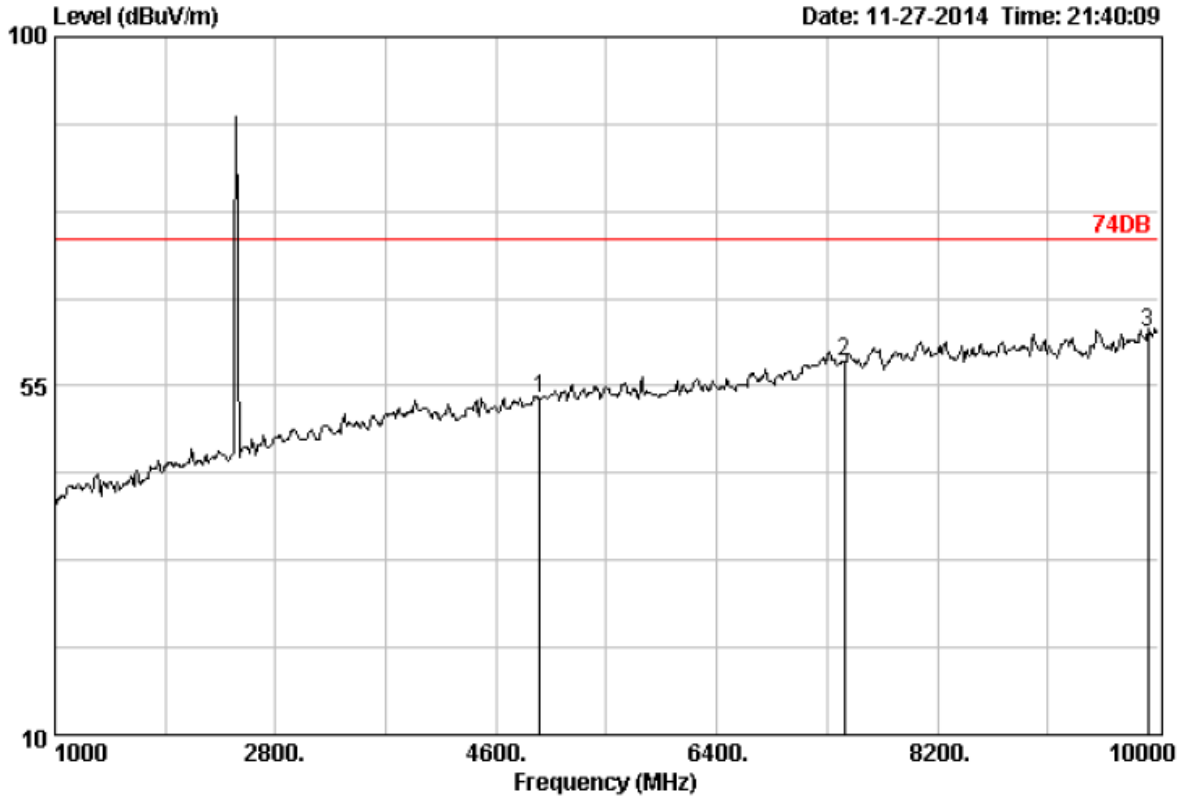

Site no. : 3m Chamber Data no. : 997
 Dis. / Ant. : 3m DRH-118 Ant. pol. : HORIZONTAL
 Limit : 74DB
 Env. / Ins. : 23*C/54%
 Engineer :
 EUT :
 Power :
 M/N :
 Test Mode :

	Freq. (MHz)	Ant. Factor (dB)	Cable Loss (dB)	Reading (dBuV)	Emission Level (dBuV/m)	Limits (dBuV/m)	Margin (dB)	Remark
1	4960.00	33.86	7.01	46.79	53.41	74.00	20.59	Peak
2	7440.00	37.64	9.28	46.28	58.23	74.00	15.77	Peak
3	9920.00	38.90	11.10	47.21	61.84	74.00	12.16	Peak

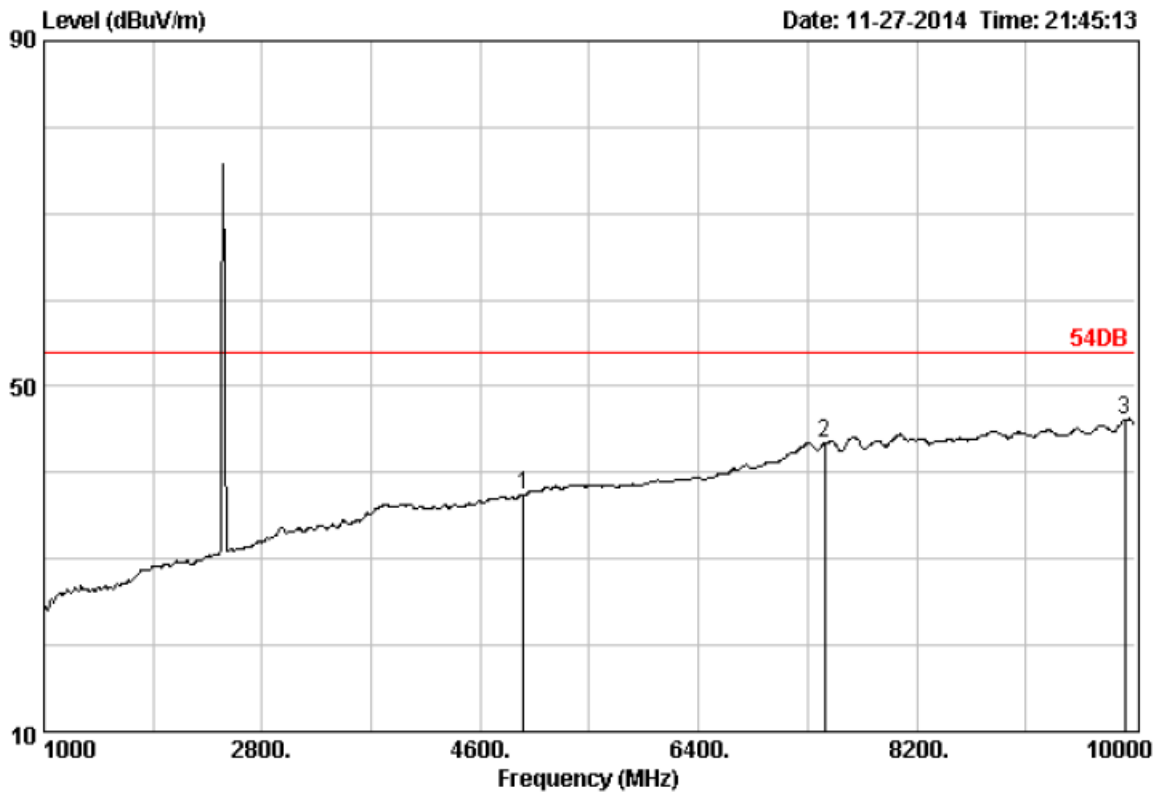

Site no. : 3m Chamber
 Dis. / Ant. : 3m DRH-118
 Limit : 54DB
 Env. / Ins. : 23°C/54%
 Engineer :
 EUT :
 Power :
 M/N :
 Test Mode :

Data no. : 999
 Ant. pol. : HORIZONTAL

	Freq. (MHz)	Ant. Factor (dB)	Cable Loss (dB)	Reading (dBuV)	Emission Level (dBuV/m)	Limits (dBuV/m)	Margin (dB)	Remark
1	4960.00	33.86	7.01	30.87	37.49	54.00	16.51	Average
2	7440.00	37.64	9.28	31.48	43.43	54.00	10.57	Average
3	9920.00	38.90	11.10	31.45	46.08	54.00	7.92	Average

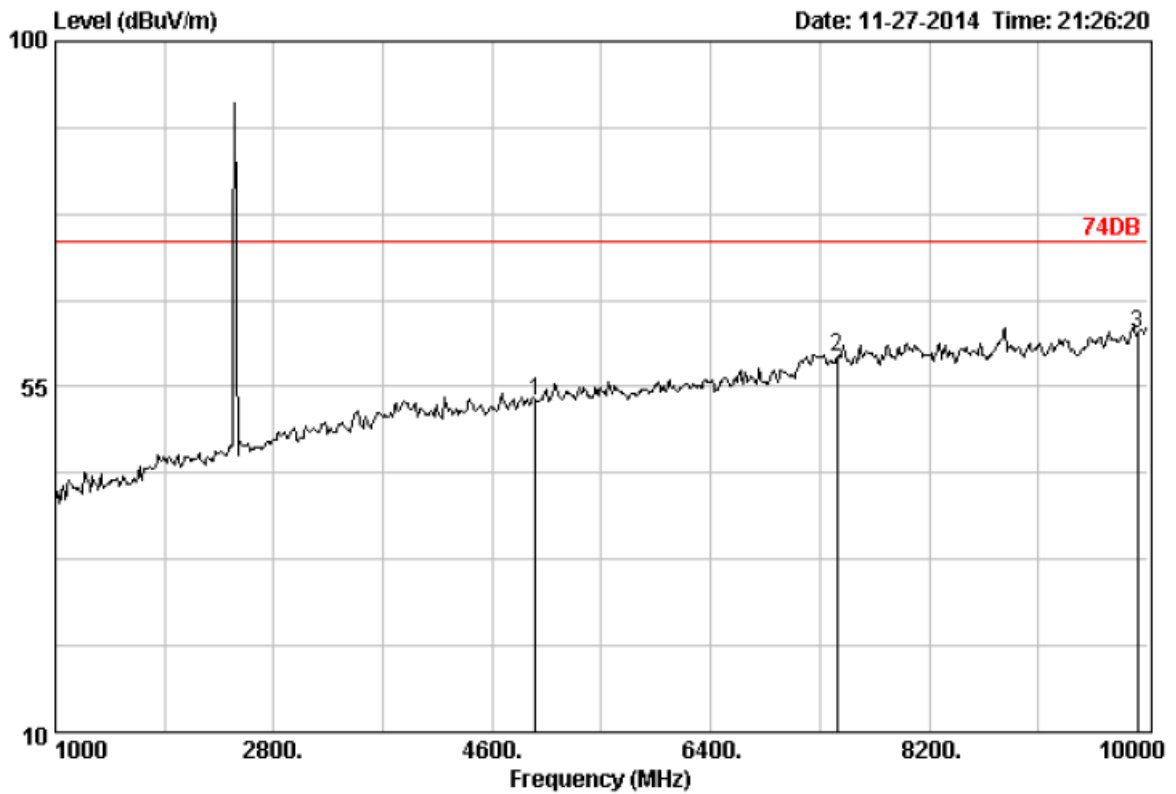

Site no. : 3m Chamber Data no. : 993
 Dis. / Ant. : 3m DRH-118 Ant. pol. : VERTICAL
 Limit : 74DB
 Env. / Ins. : 23*C/54%
 Engineer :
 EUT :
 Power :
 M/N :
 Test Mode :

	Freq. (MHz)	Ant. Factor (dB)	Cable Loss (dB)	Reading (dBuV)	Emission		Margin (dB)	Remark
					Level (dBuV/m)	Limits (dBuV/m)		
1	4960.00	33.86	7.01	46.62	53.24	74.00	20.76	Peak
2	7440.00	37.64	9.28	46.83	58.78	74.00	15.22	Peak
3	9920.00	38.90	11.10	47.35	61.98	74.00	12.02	Peak

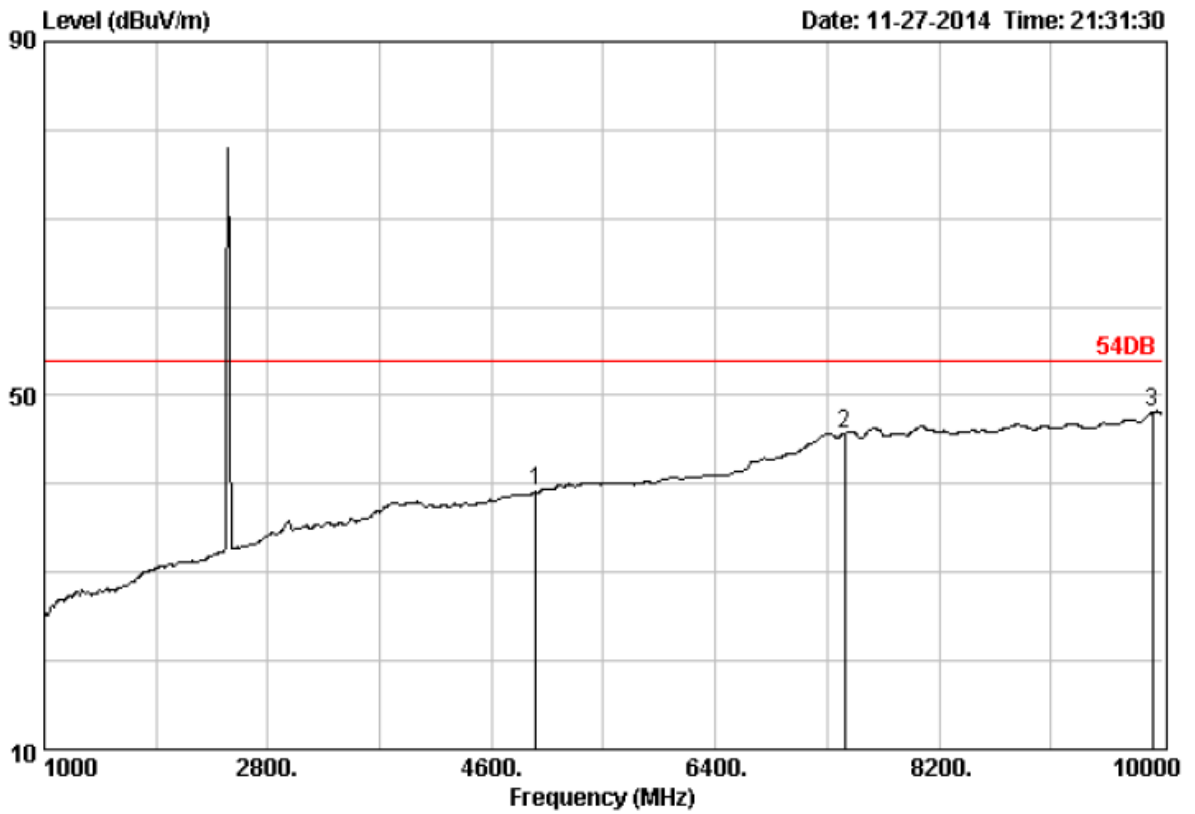

Site no. : 3m Chamber
 Dis. / Ant. : 3m DRH-118
 Limit : 54DB
 Env. / Ins. : 23°C/54%
 Engineer :
 EUT :
 Power :
 M/N :
 Test Mode :

Data no. : 995
 Ant. pol. : VERTICAL

	Freq. (MHz)	Ant. Factor (dB)	Cable Loss (dB)	Reading (dBuV)	Emission			Remark
					Level (dBuV/m)	Limits (dBuV/m)	Margin (dB)	
1	4960.00	33.86	7.01	32.46	39.08	54.00	14.92	Average
2	7440.00	37.64	9.28	33.81	45.76	54.00	8.24	Average
3	9920.00	38.90	11.10	33.45	48.08	54.00	5.92	Average

Note: above 10GHz up to 25GHz was verified, and no any emission was found except system noise floor.

4.4. Band Edge Measurement

TEST CONFIGURATION

Same as Section 4.2

TEST PROCEDURE

The band edge compliance of RF radiated emission should be measured by following the guidance in ANSI C63.4 with respect to maximizing the emission by rotating the EUT, measuring the emission while the EUT is situated in three orthogonal planes (if appropriate), adjusting the measurement antenna height and polarization etc. Set RBW to 1 MHz and VBM to 3MHz to measure the peak field strength and set RBW to 1MHz and VBW to 10Hz to measure the average radiated field strength.

PK detector is used for both AV and PK test.

LIMIT

FCC PART 15.249(d) Emissions radiated outside of the specified frequency bands, except for harmonics, shall be attenuated by at least 50 dB below the level of the fundamental or to the general radiated emission limits in §15.209, whichever is the lesser attenuation.

TEST RESULTS

See next pages.

Note:

For the band-edge measurement, both hopping-on mode and hopping-off mode measured. And the worst case (hopping-off) is recorded.



Radiated Test:

Operation Mode: TX on Bot Channel

Polarity: Hor.

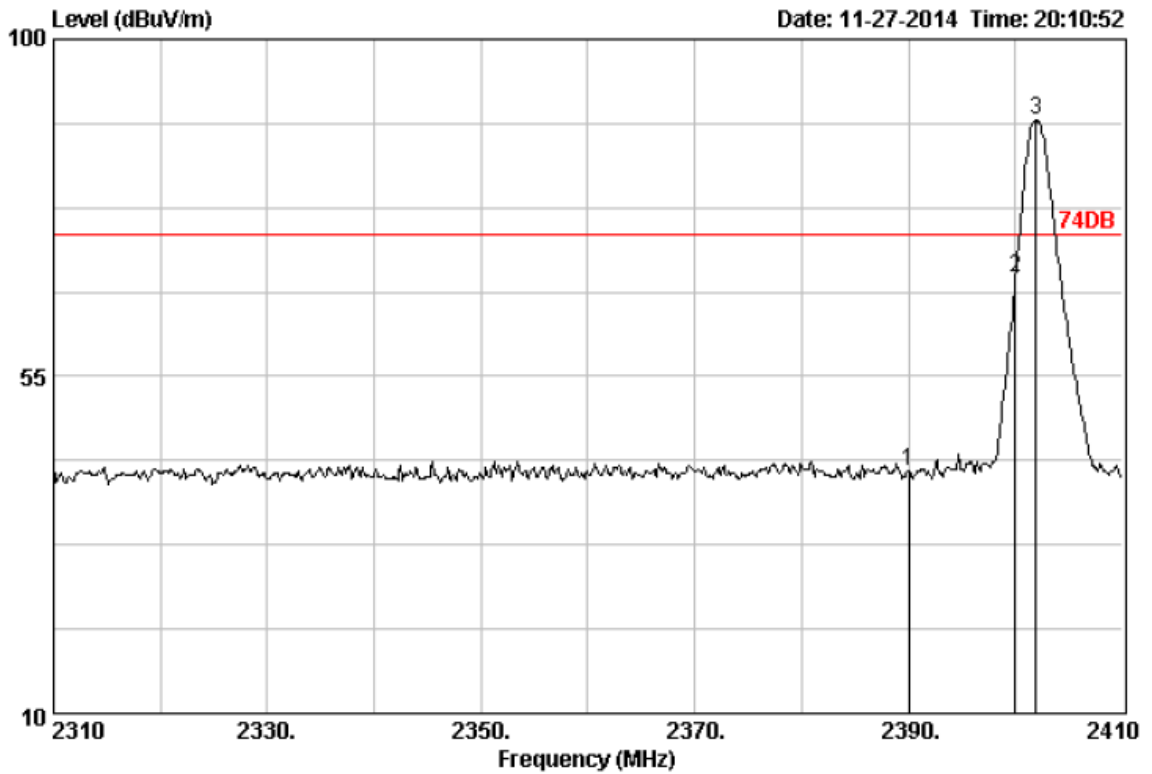

```

Site no.       : 3m Chamber                Data no. : 980
Dis. / Ant.   : 3m DRH-118              Ant. pol. : HORIZONTAL
Limit         : 74DB
Env. / Ins.   : 23*C/54%
Engineer      :
EUT           :
Power         :
M/N          :
Test Mode     :
  
```

	Freq. (MHz)	Ant. Factor (dB)	Cable Loss (dB)	Reading (dBuV)	Emission Level (dBuV/m)	Limits (dBuV/m)	Margin (dB)	Remark
1	2390.00	28.78	4.61	44.31	42.34	74.00	31.66	Peak
2	2400.00	28.78	4.61	70.06	68.09	74.00	5.91	Peak
3	2401.90	28.78	4.61	91.14	89.17	74.00	-15.17	Peak

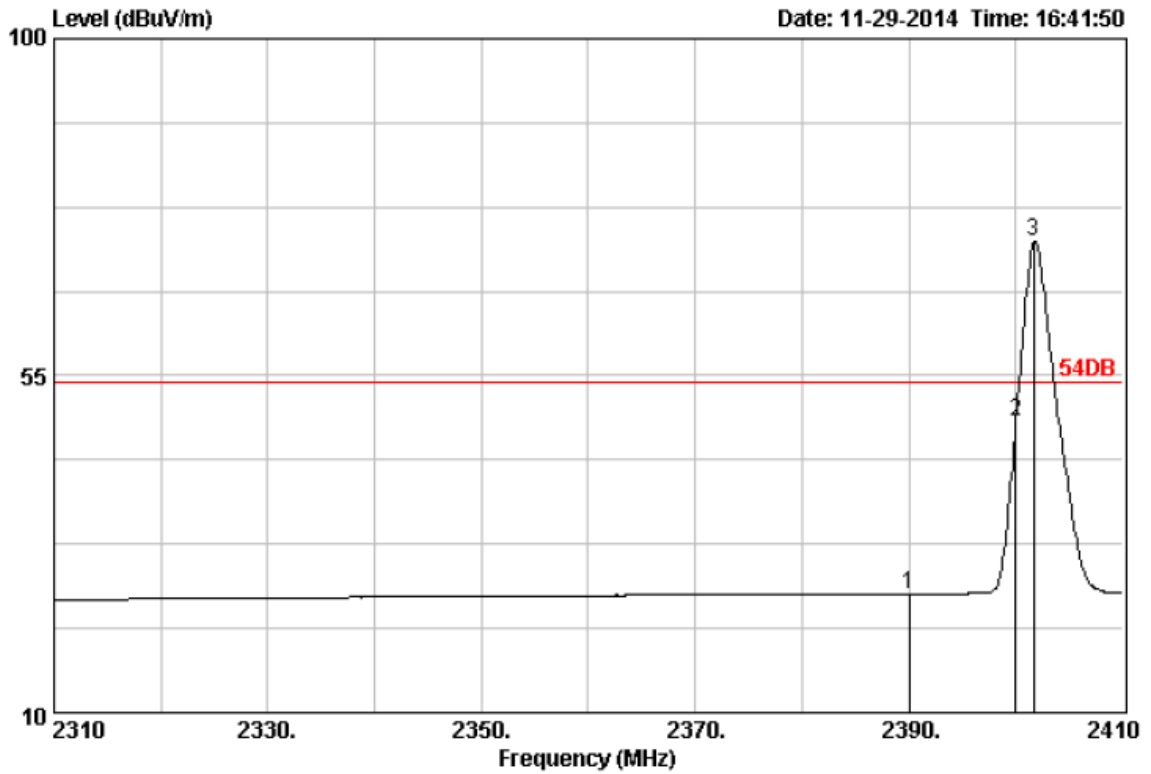

Site no. : 3m Chamber Data no. : 1024
 Dis. / Ant. : 3m DRH-118 Ant. pol. : HORIZONTAL
 Limit : 54DB
 Env. / Ins. : 23*C/54%
 Engineer :
 EUT :
 Power :
 M/N :
 Test Mode :

	Freq. (MHz)	Ant. Factor (dB)	Cable Loss (dB)	Reading (dBuV)	Emission Level (dBuV/m)	Limits (dBuV/m)	Margin (dB)	Remark
1	2390.00	28.78	4.61	27.83	25.86	54.00	28.14	Average
2	2400.00	28.78	4.61	50.76	48.79	54.00	5.21	Average
3	2401.70	28.78	4.61	74.95	72.98	54.00	-18.98	Average

Operation Mode: TX on Bot Channel

Polarity: Ver.

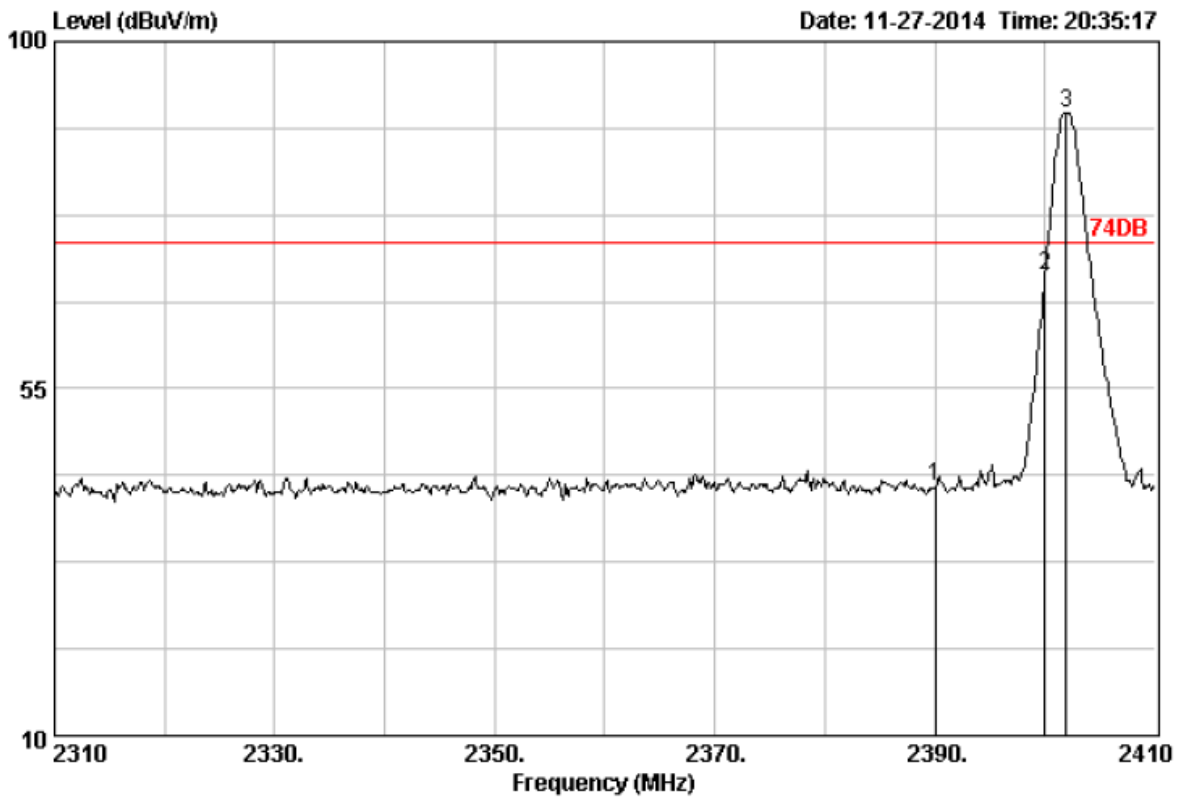

```

Site no.       : 3m Chamber           Data no. : 985
Dis. / Ant.   : 3m DRH-118          Ant. pol. : VERTICAL
Limit        : 74DB
Env. / Ins.   : 23*C/54%
Engineer     :
EUT          :
Power        :
M/N         :
Test Mode    :
    
```

	Freq. (MHz)	Ant. Factor (dB)	Cable Loss (dB)	Reading (dBuV)	Emission Level (dBuV/m)	Limits (dBuV/m)	Margin (dB)	Remark
1	2390.00	28.78	4.61	44.27	42.30	74.00	31.70	Peak
2	2400.00	28.78	4.61	71.73	69.76	74.00	4.24	Peak
3	2401.90	28.78	4.61	92.76	90.79	74.00	-16.79	Peak

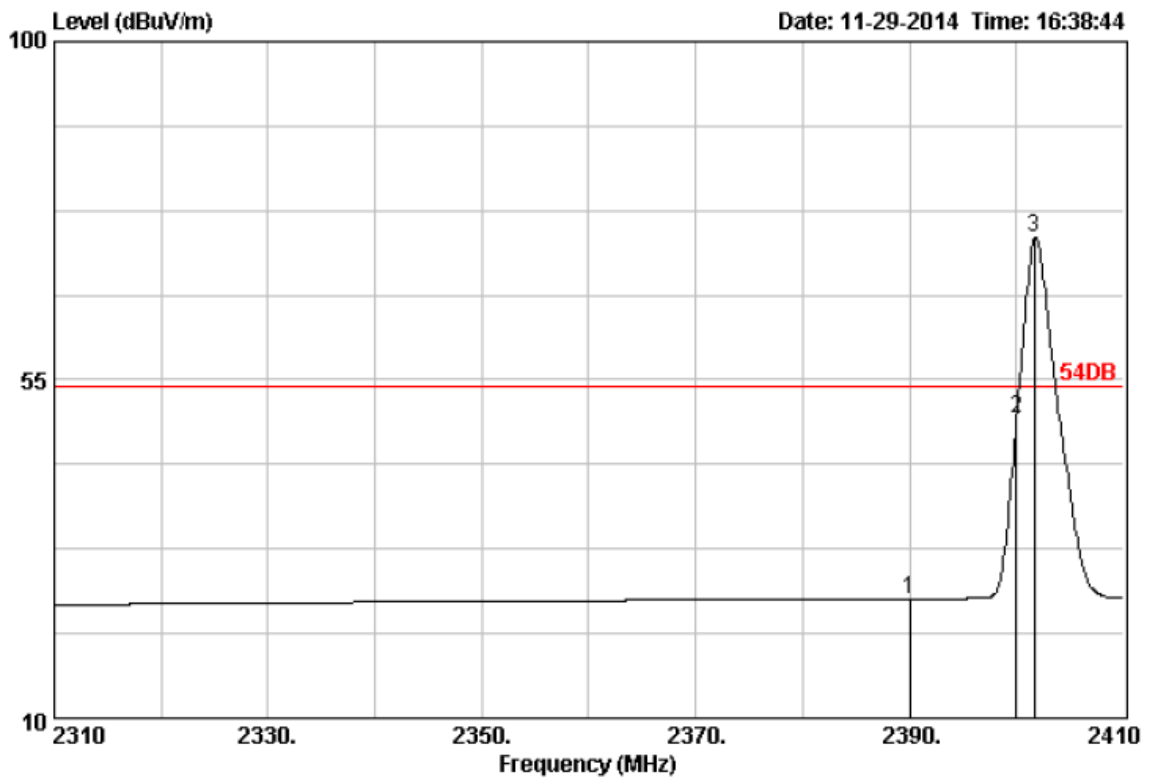

Site no. : 3m Chamber Data no. : 1023
 Dis. / Ant. : 3m DRH-118 Ant. pol. : VERTICAL
 Limit : 54DB
 Env. / Ins. : 23°C/54%
 Engineer :
 EUT :
 Power :
 M/N :
 Test Mode :

	Freq. (MHz)	Ant. Factor (dB)	Cable Loss (dB)	Reading (dBuV)	Emission		Margin (dB)	Remark
					Level (dBuV/m)	Limits (dBuV/m)		
1	2390.00	28.78	4.61	27.84	25.87	54.00	28.13	Average
2	2400.00	28.78	4.61	51.73	49.76	54.00	4.24	Average
3	2401.70	28.78	4.61	75.86	73.89	54.00	-19.89	Average

Note: The field strength of any emissions which appear outside of this band shall not exceed the general radiated emission limits in Section 15.209.

Operation Mode: TX on Top Channel

Polarity: Hor.

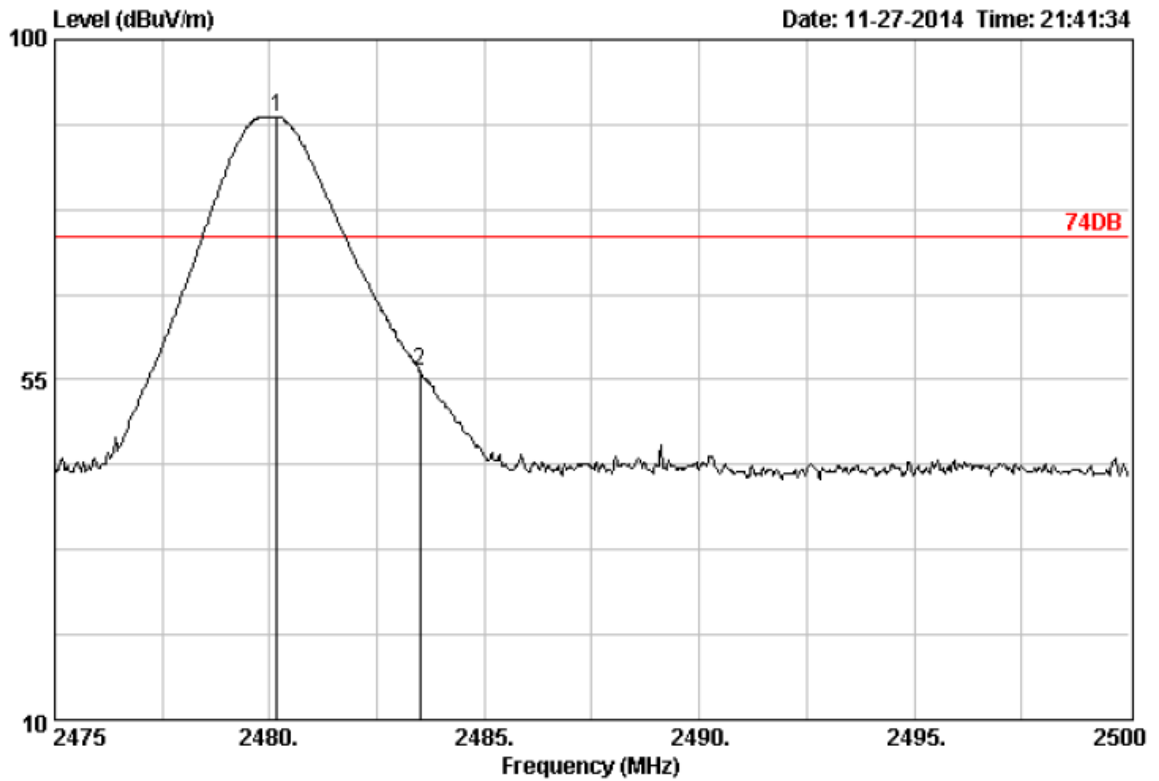

```

Site no.      : 3m Chamber                      Data no. : 998
Dis. / Ant.   : 3m DRH-118                    Ant. pol. : HORIZONTAL
Limit        : 74DB
Env. / Ins.   : 23*C/54%
Engineer     :
EUT          :
Power        :
M/N          :
Test Mode    :
    
```

	Freq. (MHz)	Ant. Cable		Emission				Remark
		Factor (dB)	Loss (dB)	Reading (dBuV)	Level (dBuV/m)	Limits (dBuV/m)	Margin (dB)	
1	2480.18	28.93	4.70	91.53	89.78	74.00	-15.78	Peak
2	2483.50	28.93	4.70	57.79	56.04	74.00	17.96	Peak

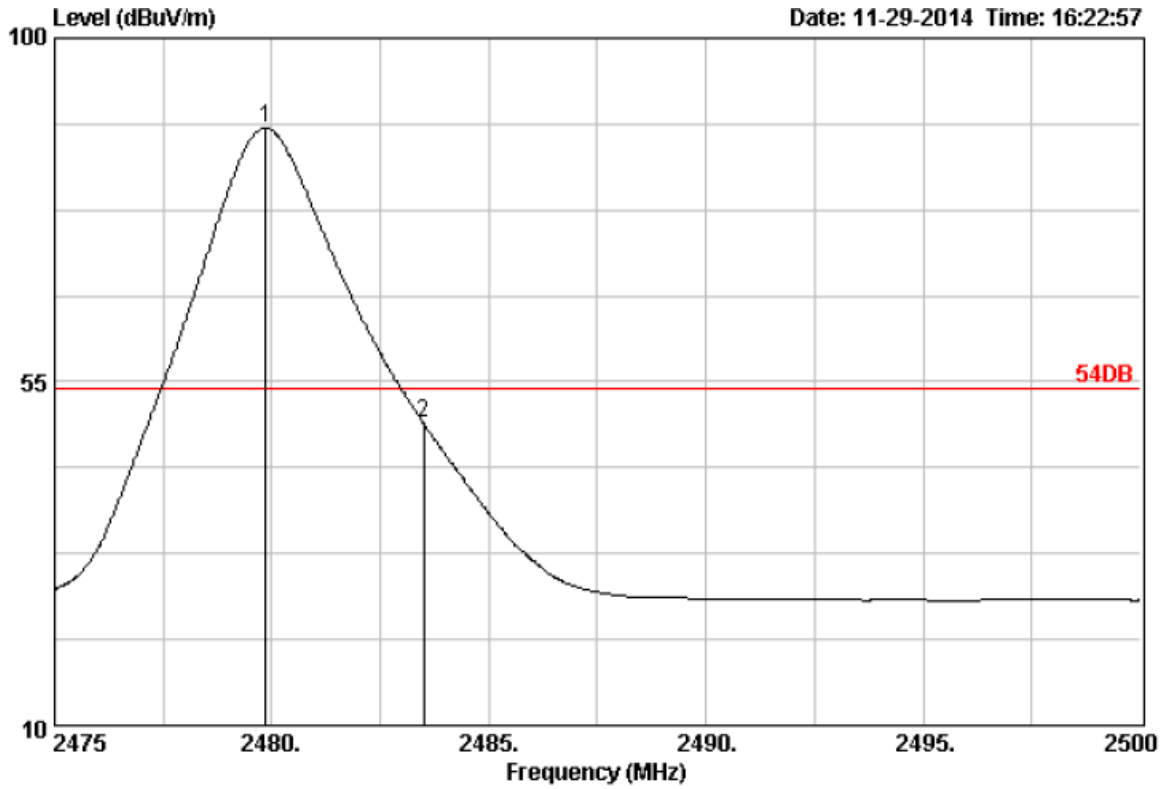

Site no. : 3m Chamber Data no. : 1022
 Dis. / Ant. : 3m DRH-118 Ant. pol. : HORIZONTAL
 Limit : 54DB
 Env. / Ins. : 23*C/54%
 Engineer :
 EUT :
 Power :
 M/N :
 Test Mode :

	Freq. (MHz)	Ant. Factor (dB)	Cable Loss (dB)	Reading (dBuV)	Emission Level (dBuV/m)	Limits (dBuV/m)	Margin (dB)	Remark
1	2479.85	28.93	4.70	90.01	88.26	54.00	-34.26	Average
2	2483.50	28.93	4.70	51.24	49.49	54.00	4.51	Average

Operation Mode: TX on Top Channel

Polarity: Ver.

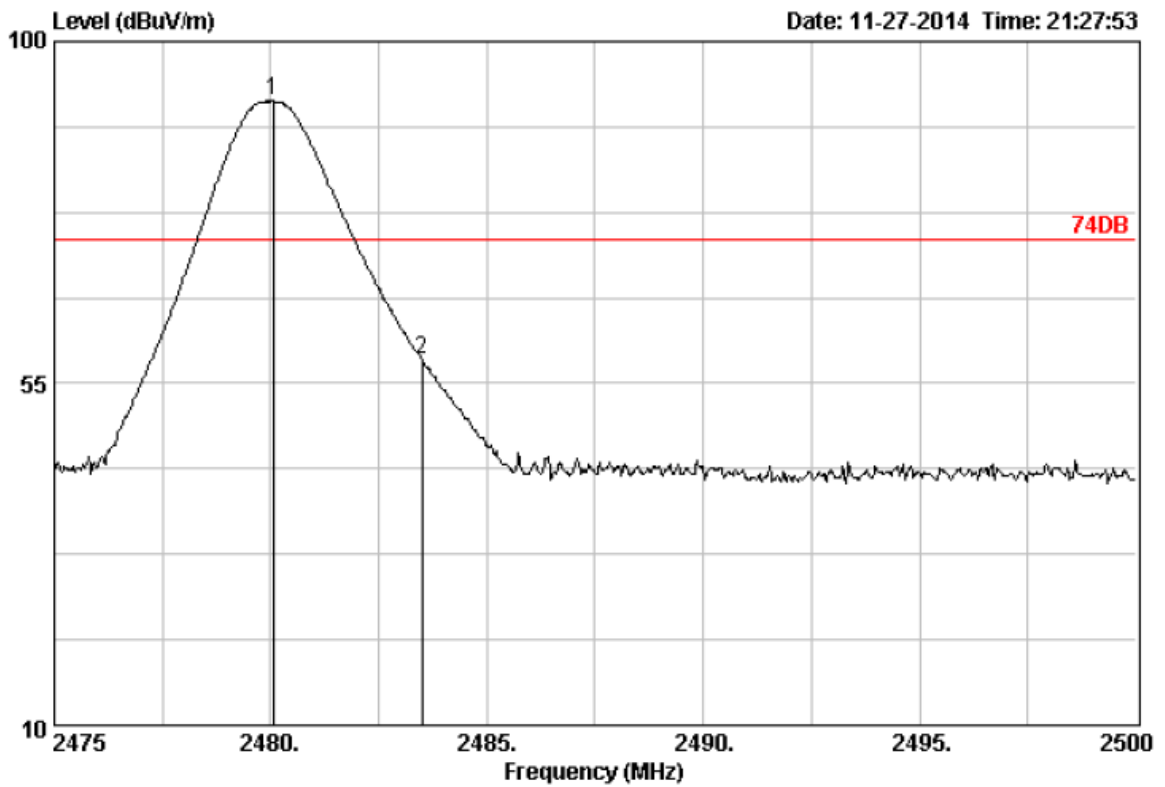

Site no.	: 3m Chamber	Data no.	: 994
Dis. / Ant.	: 3m DRH-118	Ant. pol.	: VERTICAL
Limit	: 74DB		
Env. / Ins.	: 23*C/54%		
Engineer	:		
EUT	:		
Power	:		
M/N	:		
Test Mode	:		

	Freq.	Ant.	Cable	Emission				Remark
	(MHz)	Factor	Loss	Reading	Level	Limits	Margin	
		(dB)	(dB)	(dBuV)	(dBuV/m)	(dBuV/m)	(dB)	
1	2480.05	28.93	4.70	93.90	92.15	74.00	-18.15	Peak
2	2483.50	28.93	4.70	59.80	58.05	74.00	15.95	Peak

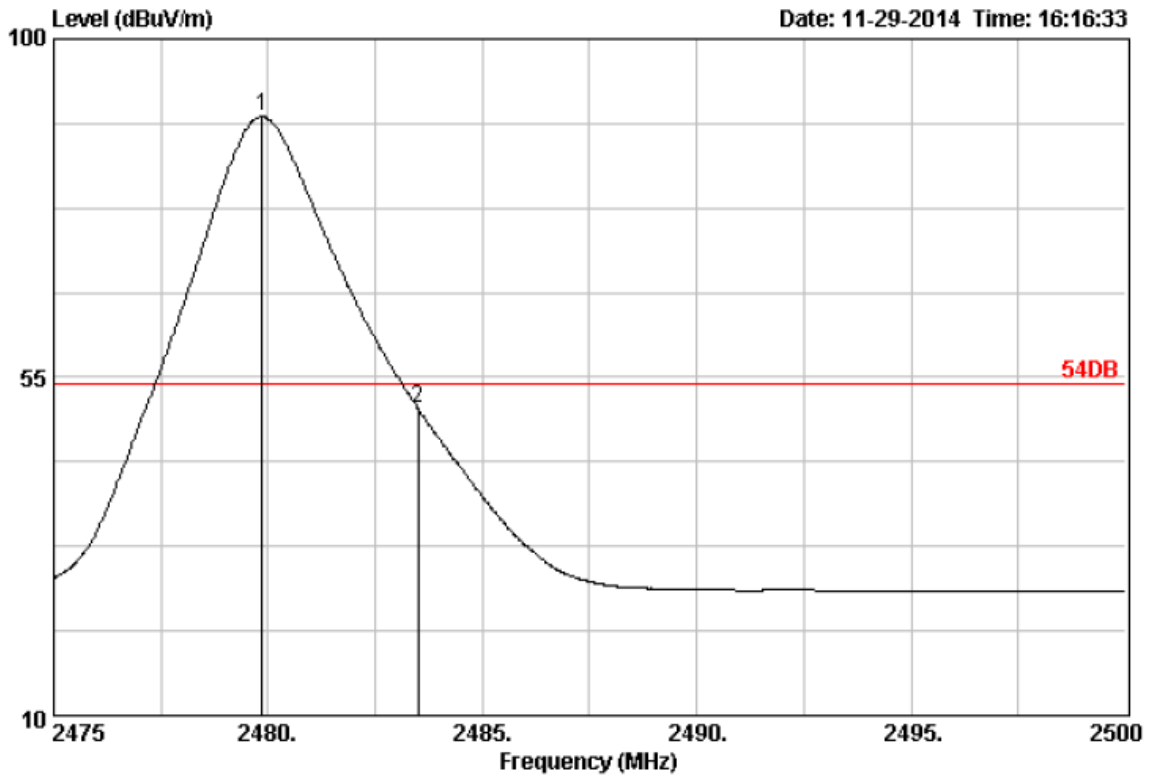

```

Site no.       : 3m Chamber                Data no. : 1021
Dis. / Ant.   : 3m DRH-118              Ant. pol. : VERTICAL
Limit         : 54DB
Env. / Ins.   : 23*C/54%
Engineer      :
EUT           :
Power         :
M/N           :
Test Mode     :
    
```

Freq. (MHz)	Ant. Factor (dB)	Cable Loss (dB)	Reading (dBuV)	Emission			Margin (dB)	Remark
				Level (dBuV/m)	Limits (dBuV/m)			
1	28.93	4.70	91.42	89.67	54.00	-35.67	Average	
2	28.93	4.70	52.55	50.80	54.00	3.20	Average	

Note: The field strength of any emissions which appear outside of this band shall not exceed the general radiated emission limits in Section 15.209.

4.5. Occupied Bandwidth Measurement

Measurement Procedure

1. Set EUT as normal operation.
2. Based on Public Notice-DA 00-705: $RBW \geq 1\%$ of the 20 dB bandwidth, $VBW \geq RBW$.
3. The useful radiated emission from the EUT was detected by the spectrum analyser with peak detector.

Test SET-UP (Block Diagram of Configuration)

Same as 4.2 Radiated Emission Measurement.

Measurement Equipment Used:

Same as 4.2 Radiated Emission Measurement.

Measurement Results

GFSK:

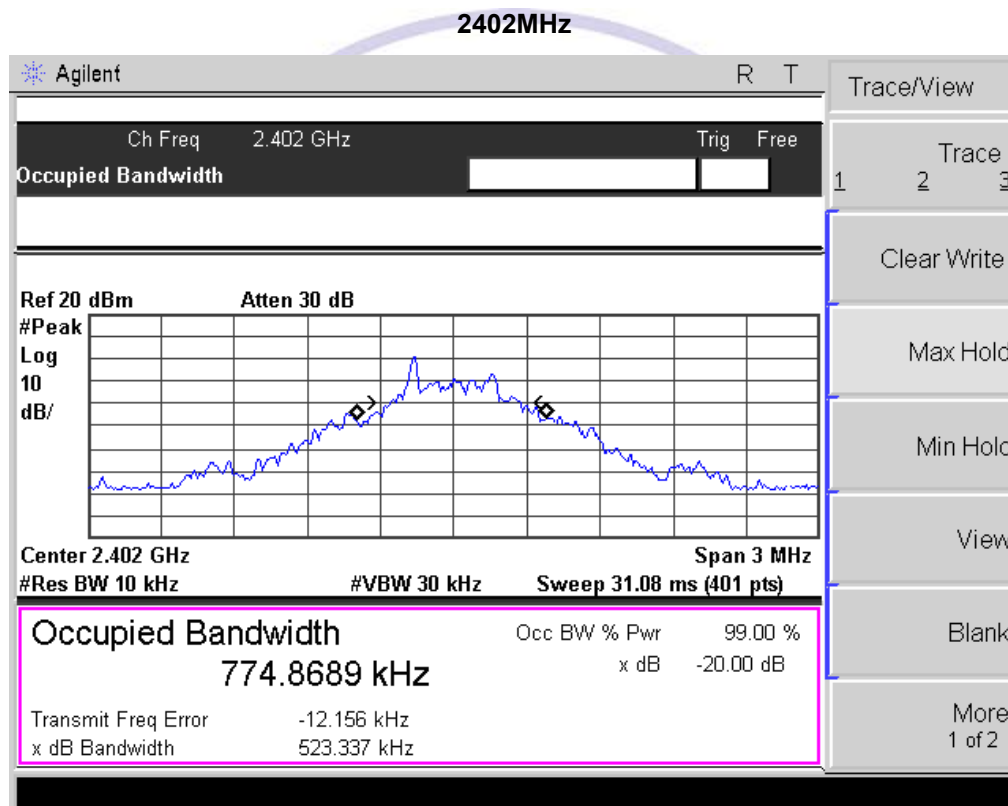

2441MHz

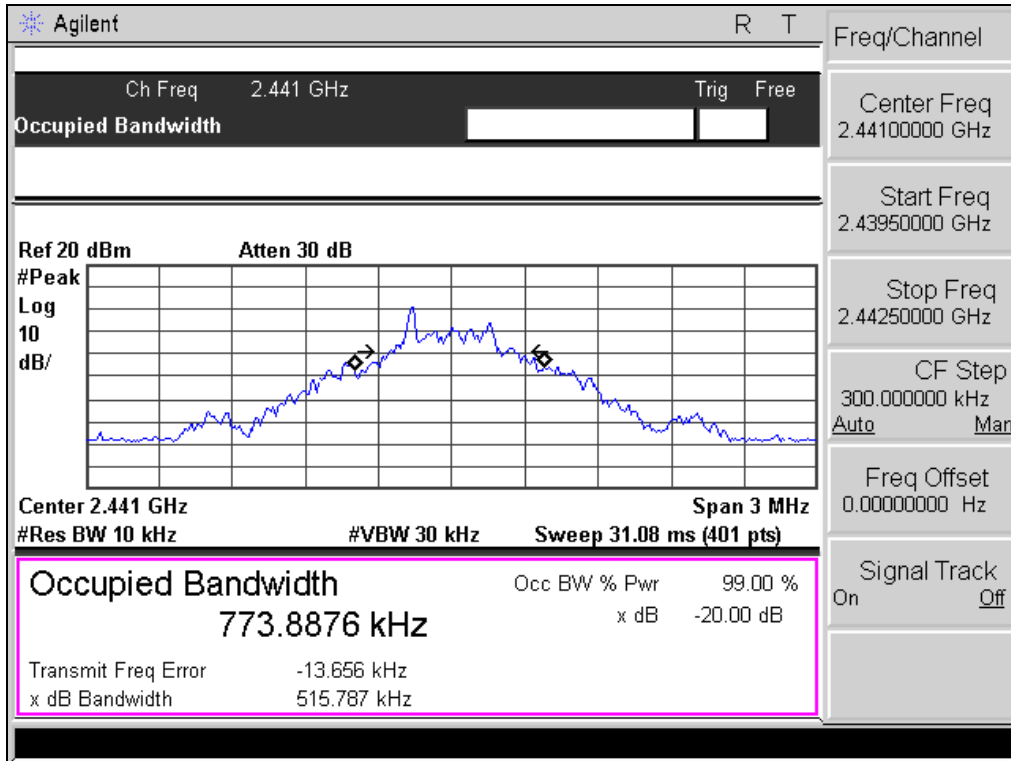

2480MHz

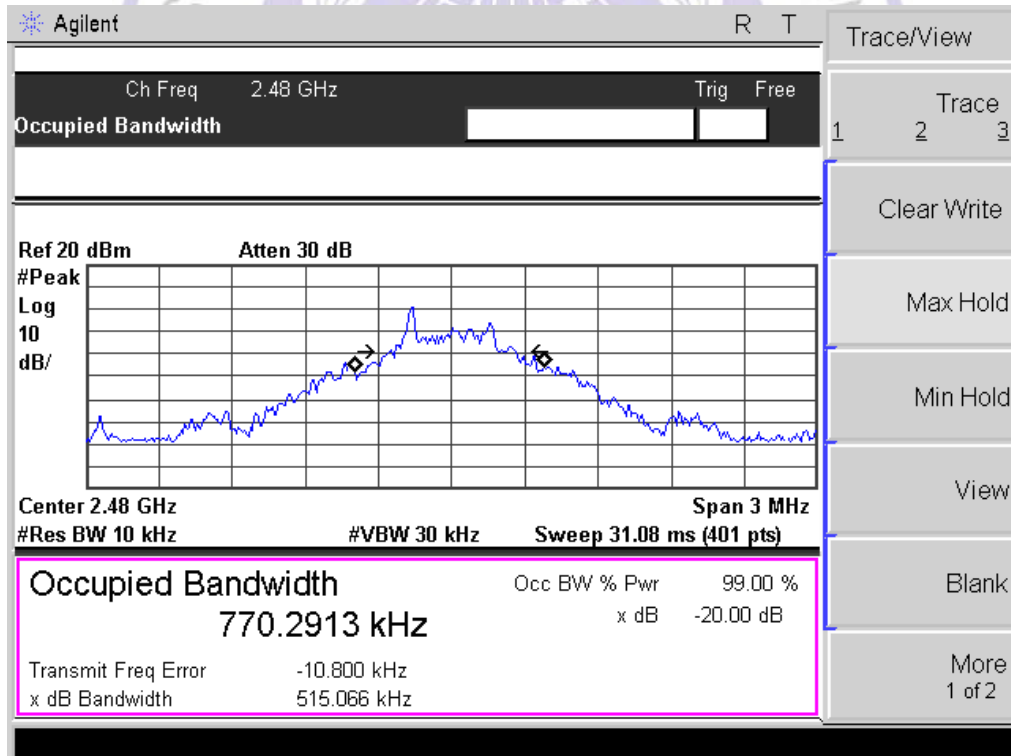

Pi/4 DQPSK:

2402MHz

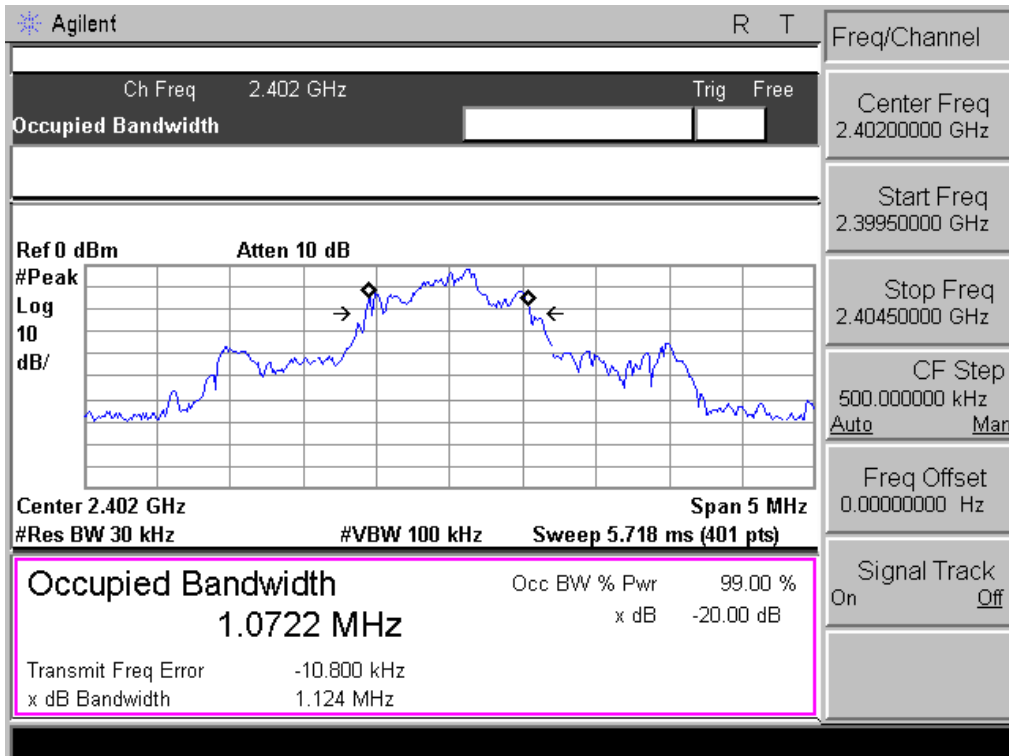

2441MHz

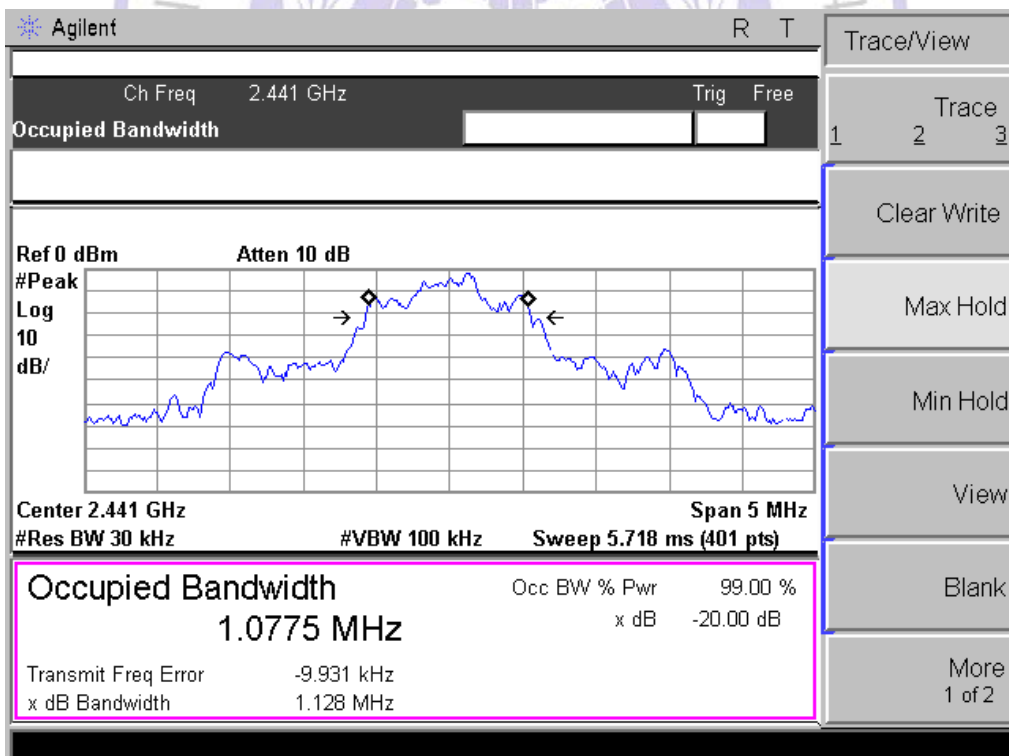

2480MHz

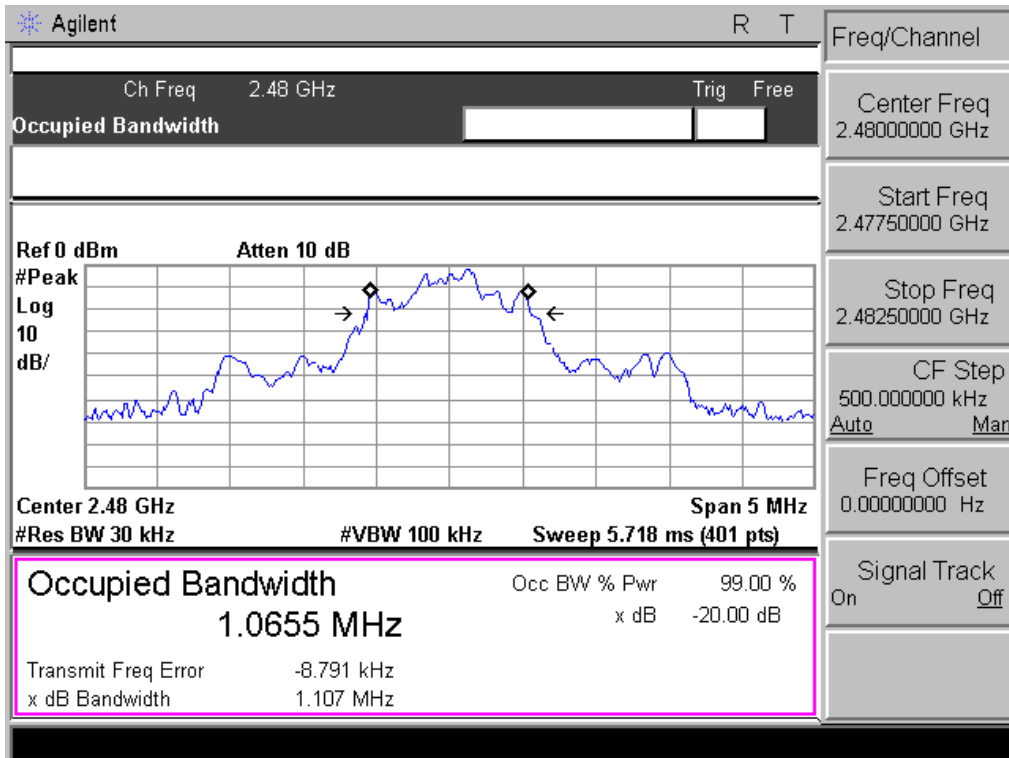

8DPSK:

2402MHz

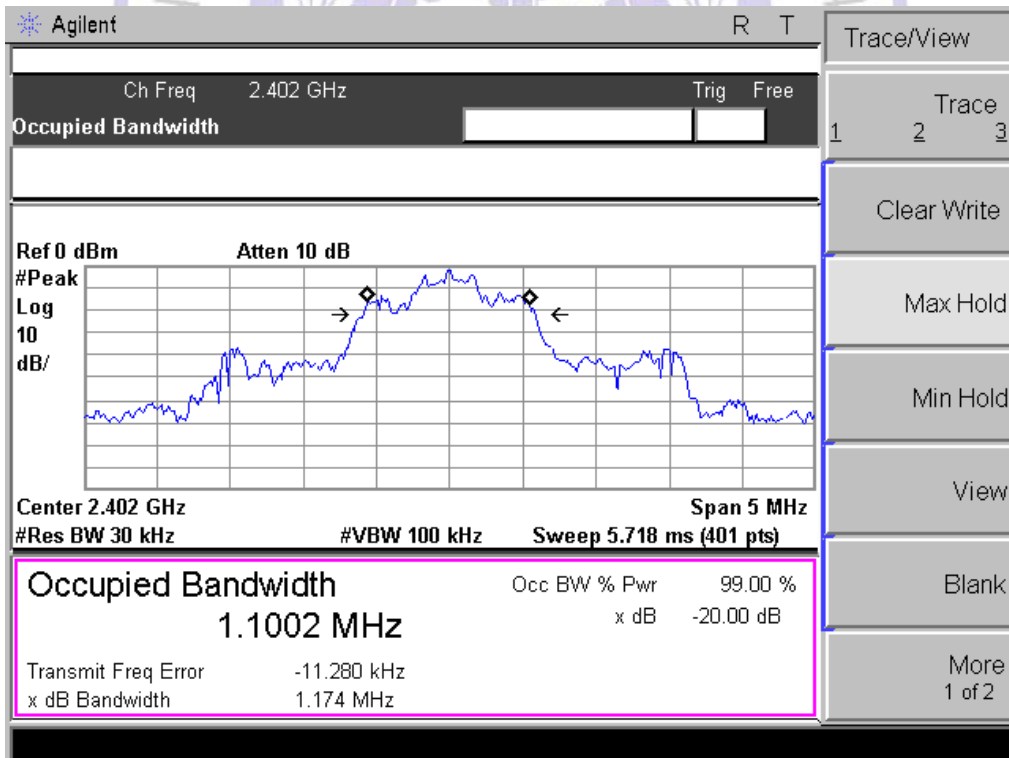

2441MHz

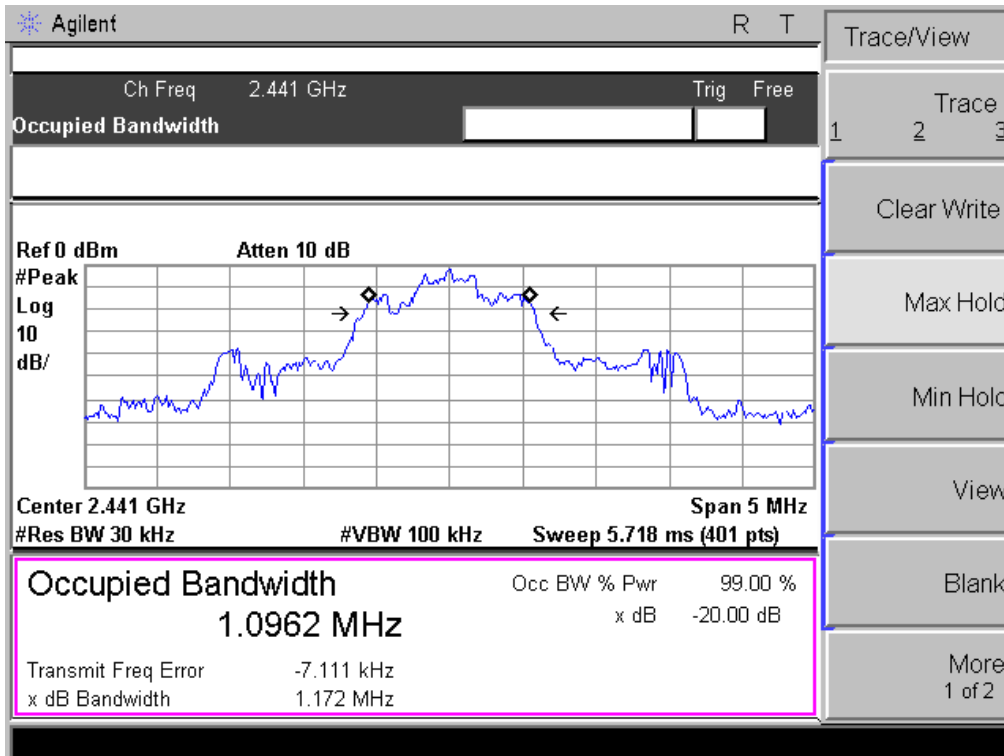

2480MHz

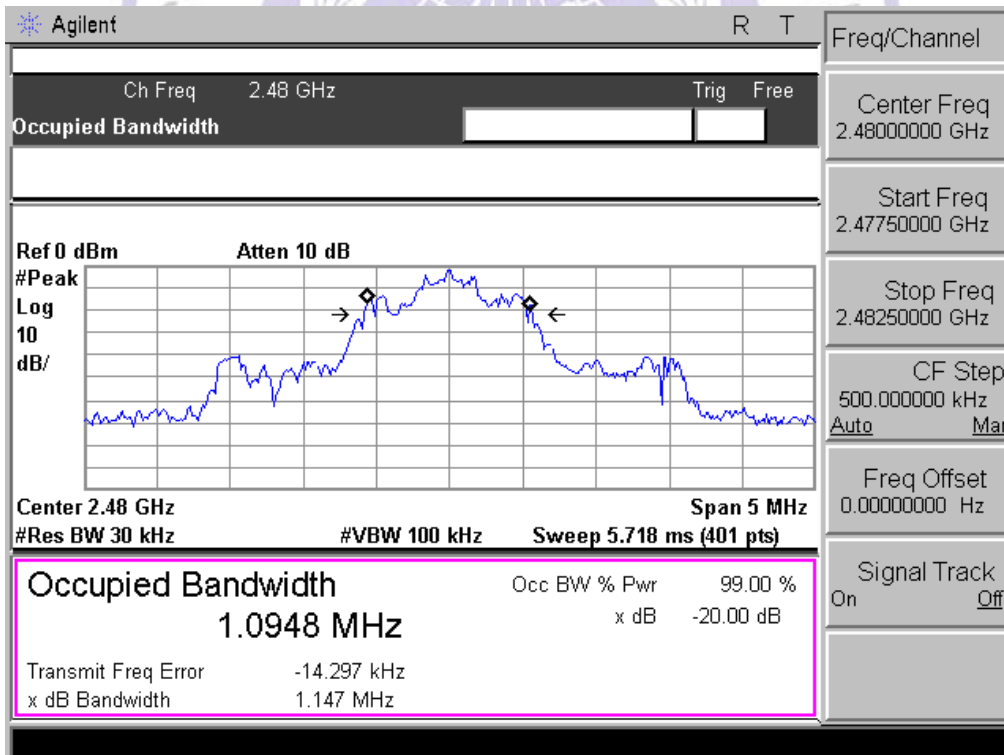

5. Antenna Requirement

Standard Applicable

For intentional device, according to FCC 47 CFR Section 15.203, an intentional radiator shall be designed to ensure that no antenna other than that furnished by the responsible party shall be used with the device.

And according to FCC 47 CFR Section 15.247 (c), if transmitting antennas of directional gain greater than 6dBi are used, the power shall be reduced by the amount in dB that the directional gain of the antenna exceeds 6dBi.

Refer to statement below for compliance.

The manufacturer may design the unit so that the user can replace a broken antenna, but the use of a standard antenna jack or electrical connector is prohibited. Further, this requirement does not apply to intentional radiators that must be professionally installed.

Antenna Connected Construction

The antenna used in this product is an internal Antenna, The directional gains of antenna used for transmitting is -3.0 dBi.



6. Test Setup Photos of the EUT

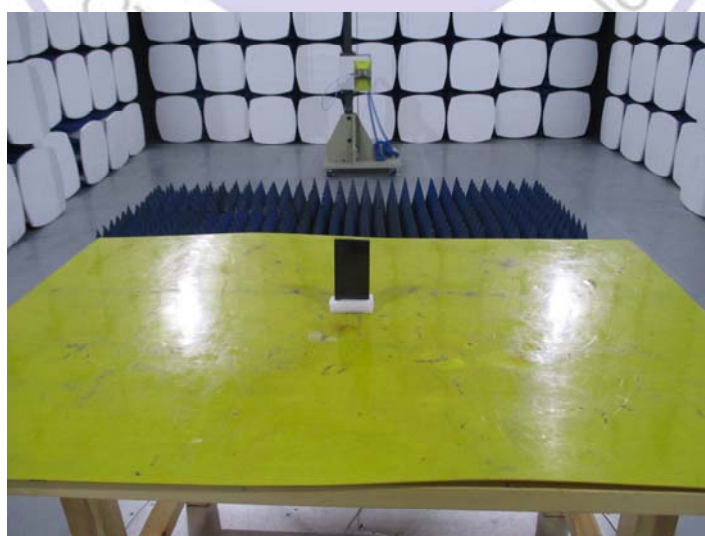
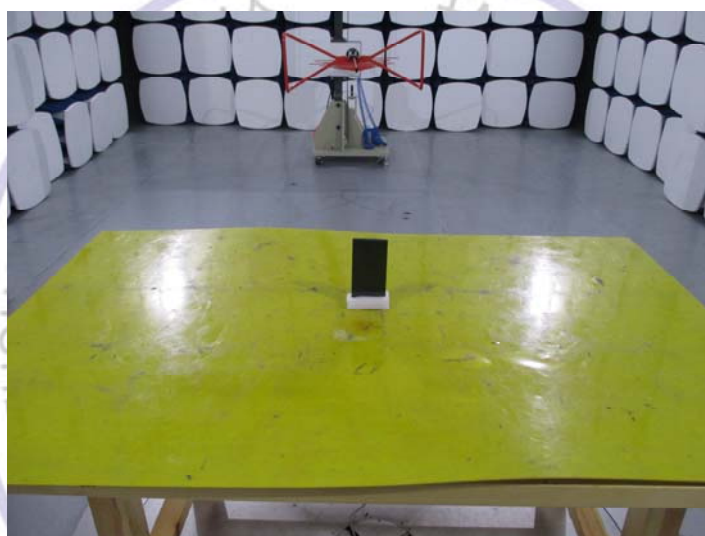
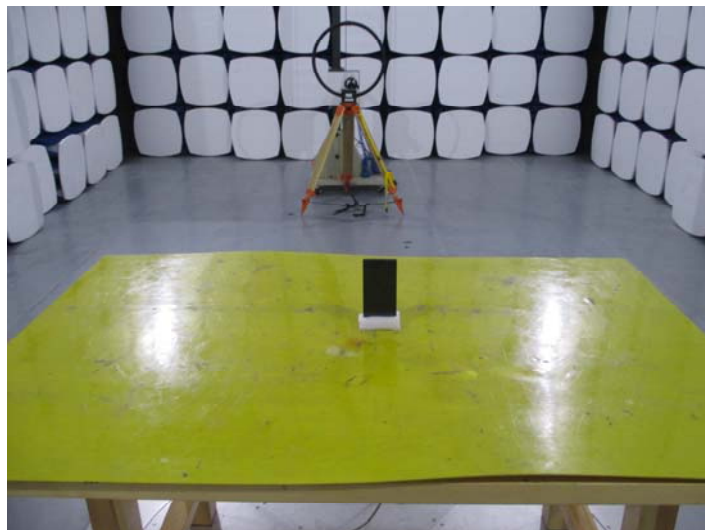



7. External and Internal Photos of the EUT

External Photos of EUT

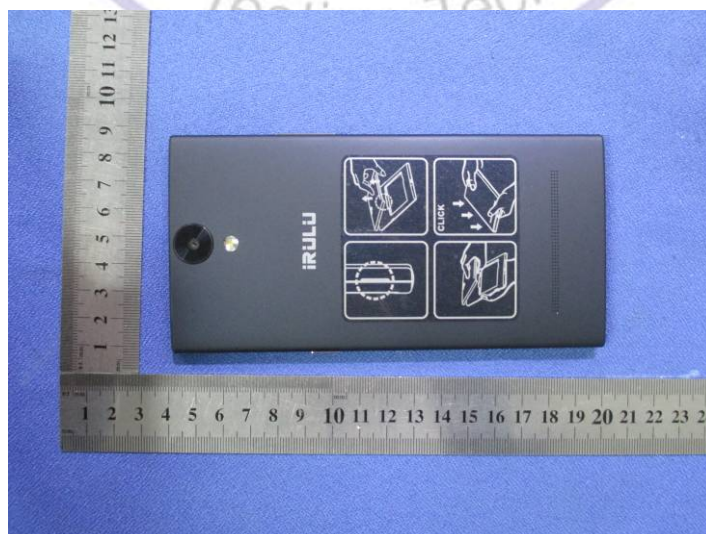





Internal Photos of EUT



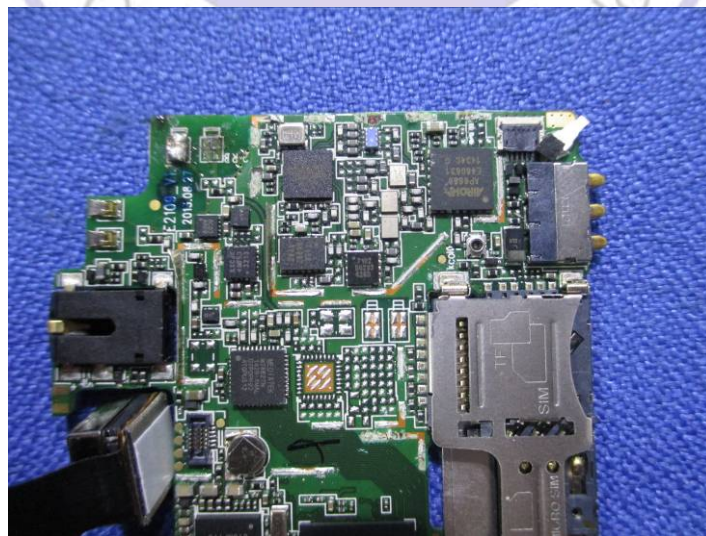
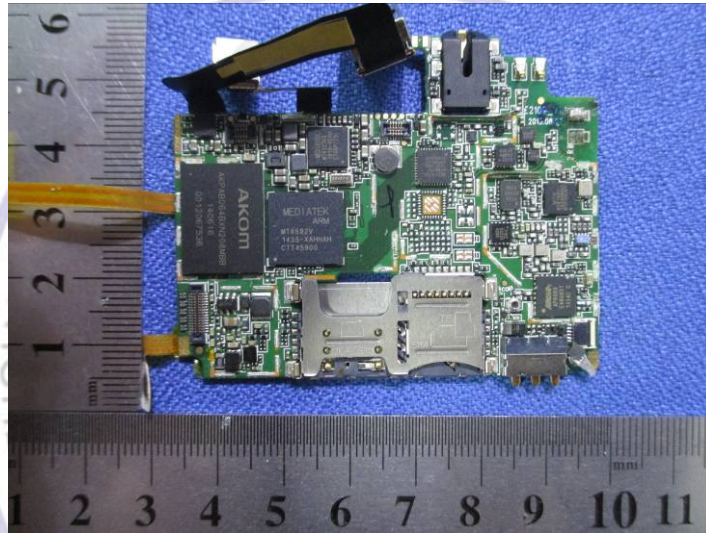
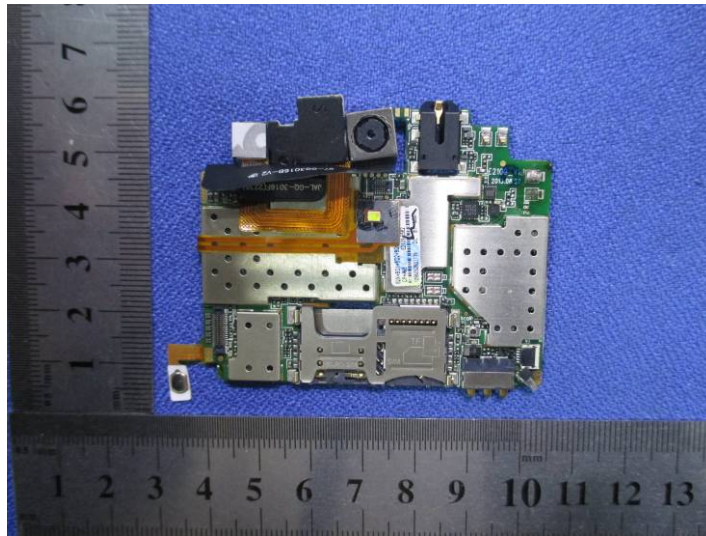

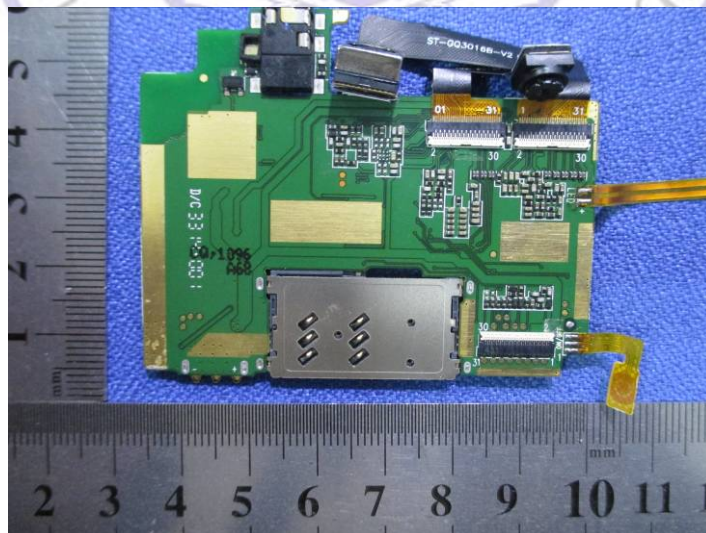
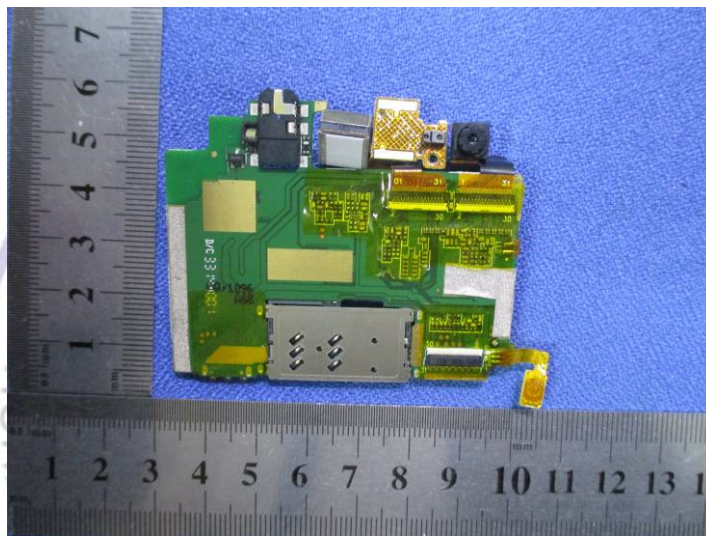

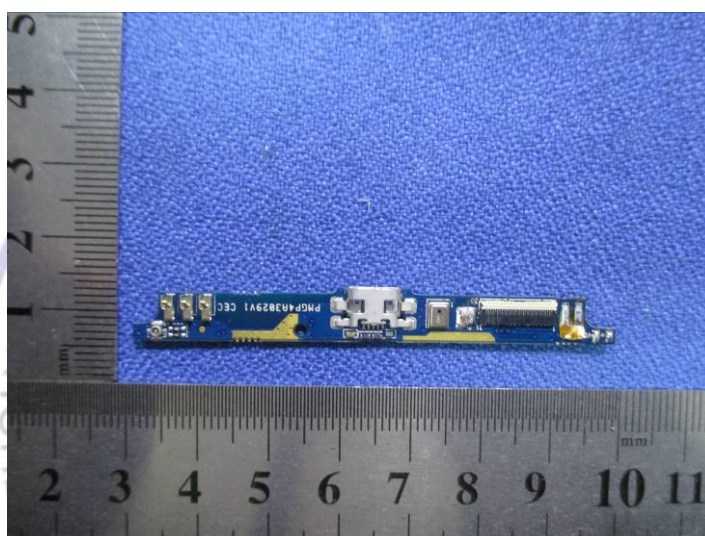
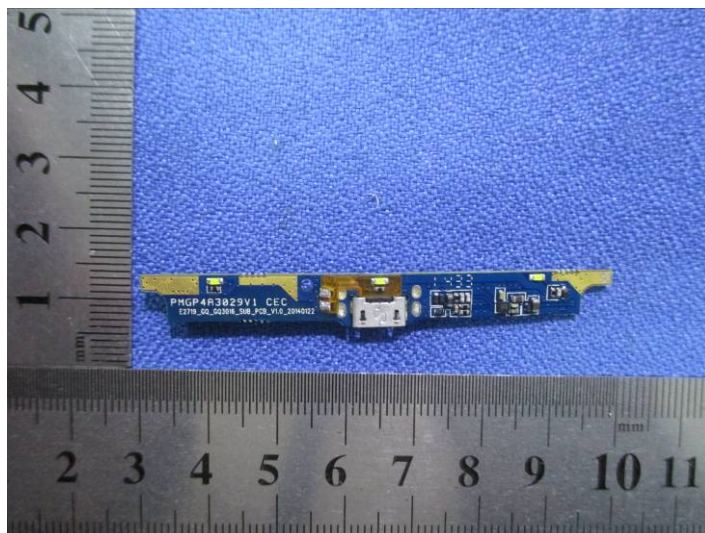

.....End of Report.....

