

T900

FCC ID: 2ADORRQT900

User Manual

Dear customer,

Thank you for purchasing the LED Light Bluetooth speaker T900. To ensure correct operation, please read this user manual carefully before operation.

Important Safety Instructions

- ◆ If you do not operate the speaker for a long time, please charge battery once a month, in order to prevent the lithium battery from being damaged.
- ◆ Do not use the speaker in special cold, hot, dusty or humid environments.
- ◆ Please avoid the speaker dropping or hitting with a hard object, it may cause damage to the inside battery or other hardware damage.
- ◆ When low battery, the indicator light will flash and voice guide the low battery, please charge battery in time.
- ◆ Keep speaker away from any source of heat/fire.

Features

1. Five Multi-colored LED Themes

Full spectrum light themes matching with your music

2. Bluetooth Music and Mobile Hands-free Function

Bluetooth stereo music playing, support mobile hands-free function.

3. NFC (Near Field Communication)

One touch easy pairing with your NFC Smartphone

4. Micro SD Card Music Playing

Support the entire MP3/WMA/WAV/APE/FLAC coding rate

5. Aux In

Work as the external speaker by connecting to the audio source of computer, mobile, PSP/MP3/MP4 etc.

Technical Data

Voltage: DC 5V

Aux in Jack: 3.5mm

Net Weight: 446g

Size: 184.7mm* 73.3mm* 81.0mm

Package Contents

Bluetooth Speaker, Micro USB Cable, User Manual, 3.5mm audio cable

Slot and Keys

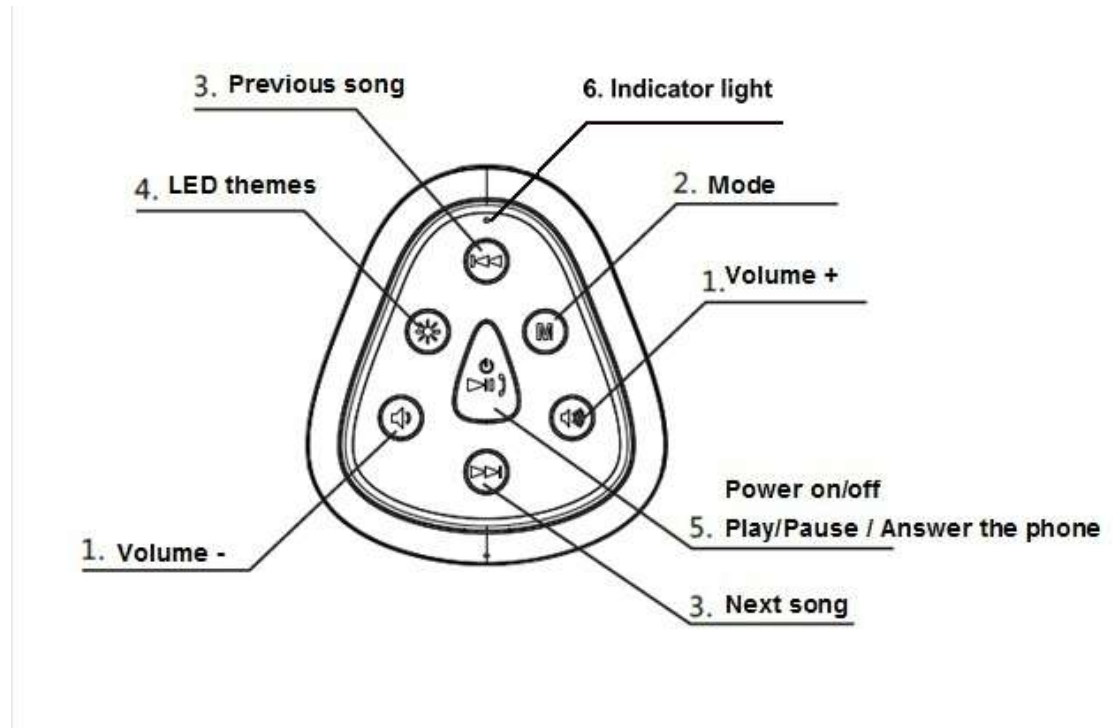

Micro USB Interface

AUX Jack

Micro SD Card Slot



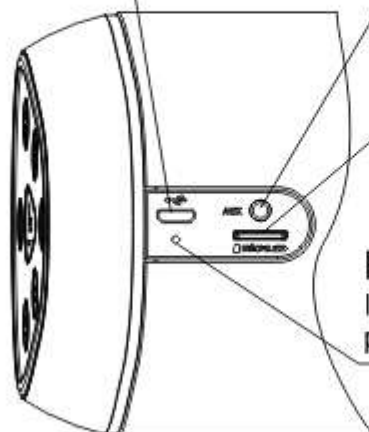

Reset

If speaker out of operation, please press this hole to reset the speaker



Quick Start



1. /



Short press the  /  buttons to decrease / increase the volume gradually. Long press the  /  buttons to decrease / increase the volume continuously.

2. **M**

Short press the **M** button to switch the mode of Bluetooth/ Mirco SD Card/AUX In

3. /



Under music playing mode, short press the  /  buttons to switch to the previous / next song.

Long press the  /  buttons for previous/next folder.

4.

Short press to switch the LED themes

5.

Long press the  button and hold for 2 seconds to power on the speaker, the Working Indicator Light will be blue. Long press the  button to power off the speaker.



Short press the  button to pause/play/mute/answer the phone/end up the phone

6. + /

Pressing the light and the volume buttons simultaneously, you can choose the level of illumination: no lighting, level 1, level 2 and level 3.

Instructions

1. Power On/Off

Long press the  button for 2 seconds to power on (Indicator turns blue); Long press the  button again to power off.

2. Bluetooth

(1) Bluetooth Paired

Press the **M** button to enter the Bluetooth mode, now please turn on the Bluetooth function of your mobile/other devices. And start to search for Bluetooth devices, the “**T900**” will be found, please connect it. (The speaker will voice “Device paired” when connecting).

(2) NFC Function (It requires the mobile has the NFC function and the speaker need under Bluetooth mode)

Turn on the mobile’s NFC function and make the mobile touch the speaker’s NFC area.

The mobile will remind you to pair with the Bluetooth device. Choose yes to complete the pairing.

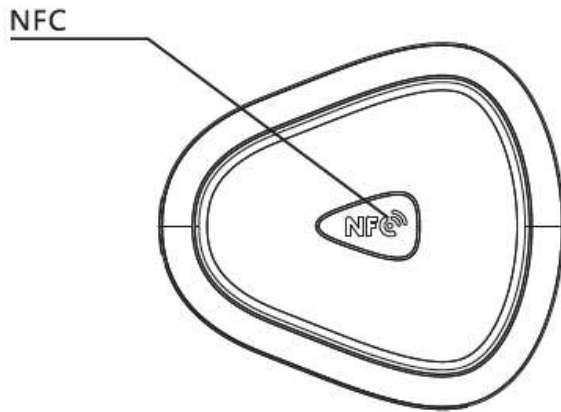



(3) Bluetooth Music

Please turn on the mobile or other devices' music player, and speaker will play the selected music.

(4) Mobile Hands-free

Under pairing, using phone to call, it can enter the Hands-free status.

When a mobile call comes in, short press the  button to pick up the phone, re-press the  button to end up the call. Press the  button twice and speaker will re-dial the last telephone number.

3. LED Themes

Short press the  to switch the LED themes, there are five different LED themes.



Club



Equalize



Groove



Rainbow



Meteor

Please note: The Club and Equalize themes only display when music playing

4. Gravity sensor

At Club and Equalize themes, the speaker can support gravity sensor.

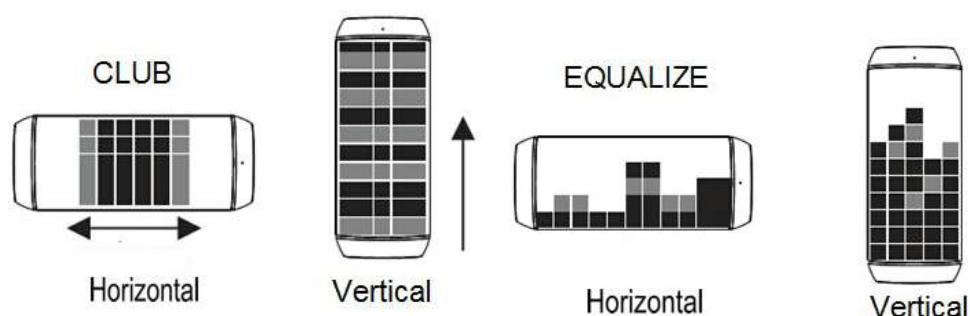

4. Micro SD Card Music Playing

Inserting the Micro SD Card into the speaker to enter the memory card mode, the speaker will play the Micro SD card music directly. (Speaker will voice “memory card mode”).

The speaker support music format at WAV,MP3,WMA,APE,FLAC.

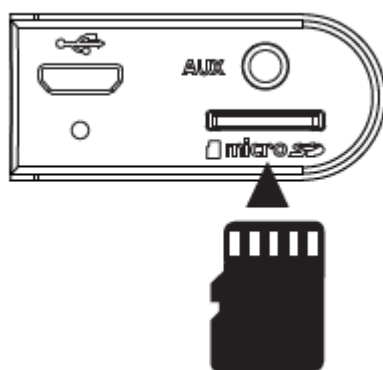

5. Aux In

Use the 3.5mm audio cable included to connect the speaker to an audio source (PC, MP3/MP4, mobile phone). Short press the **M** button to enter “**AUX IN**” mode (the speaker will voice “Aux in” mode). The speaker will play the music from the audio source.

Please note: Low battery will affect the music sound quality, please charge the speaker by adaptor soon.

6. Charging

The speaker with the built-in lithium battery, use the USB cable included to connect the speaker to the computer or a branded good quality 5V/1000mA adaptor to charge the battery. When charging, the LED indicator is orange, when finished charging, the LED indicator will turn blue.

Please note:(1) If low capacity, the indicator light will flash quickly, please charge immediately. (2)We recommend to charge the speaker by branded adaptor (5V 1A).

Troubleshooting

1. What should I do if the speaker can not pair with the Bluetooth device and play music accordingly?

Please check the specification/ the manual of the Bluetooth device (your mobile or computer), and check if the device can support the A2DP stereo audio transmission. If yes, please turn on the A2DP stereo mode.

2. What should I do if the Micro SD card can not work?

(1) Ensure that the Micro SD card is in good condition. Also check that the audio files are the correct formats - MP3/WMA/WAV/APE/FLAC.

(2) Besides the above case, the problem maybe the compatibility of the Micro SD card. We recommend you formatting the Micro SD Card to FAT32 file formats.

Fcc Statement:

Changes or modifications not expressly approved by the party responsible for compliance could void the user's authority to operate the equipment.

This device complies with Part 15 of the FCC Rules.

Operation is subject to the following two conditions:

(1) this device may not cause harmful interference, and

(2) this device must accept any interference received, including interference that may cause undesired operation.