

PCB-A

PCB-B

ISOUND-6770

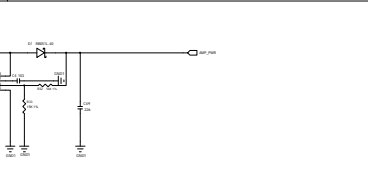

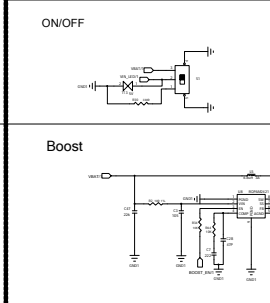
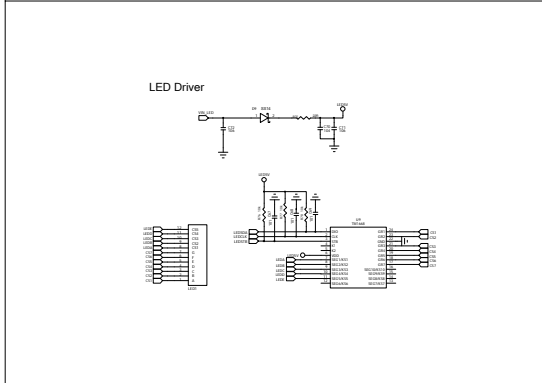
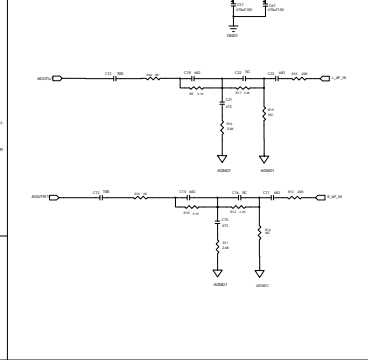
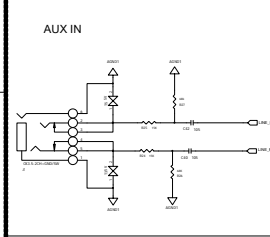
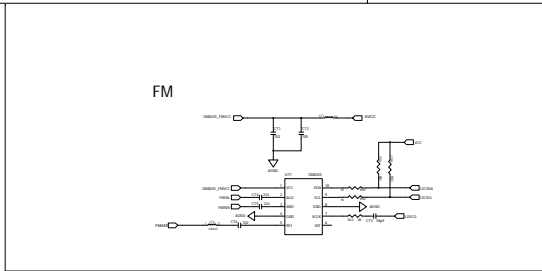
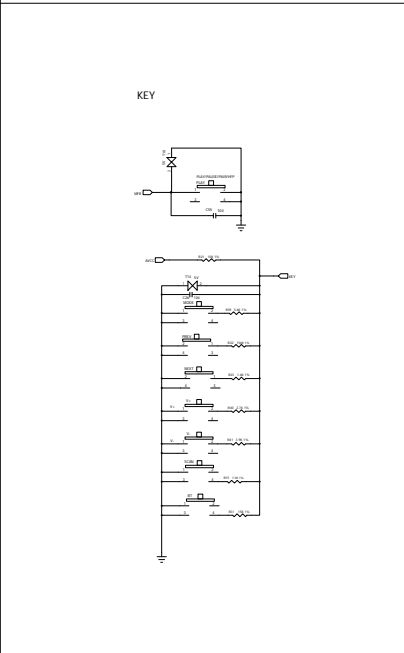
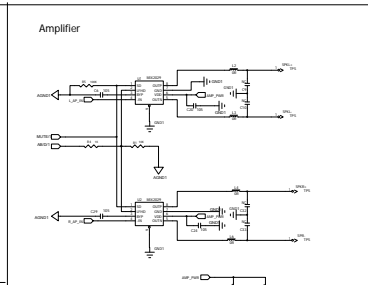
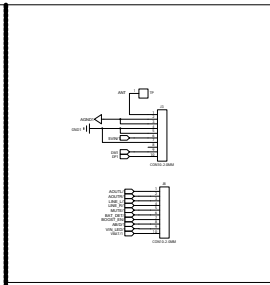
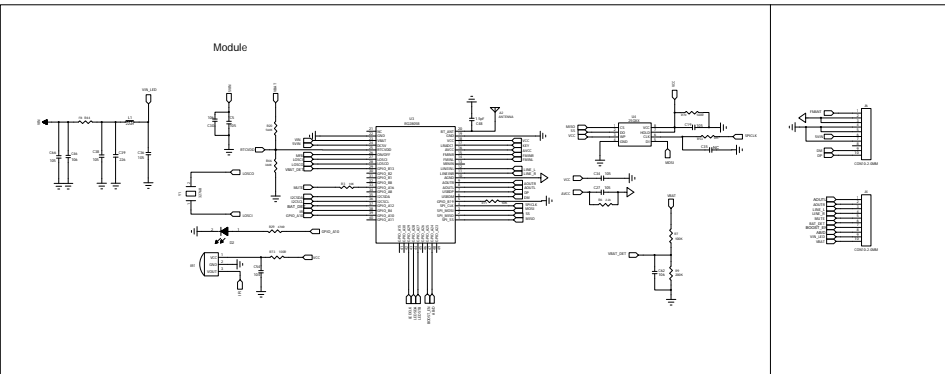
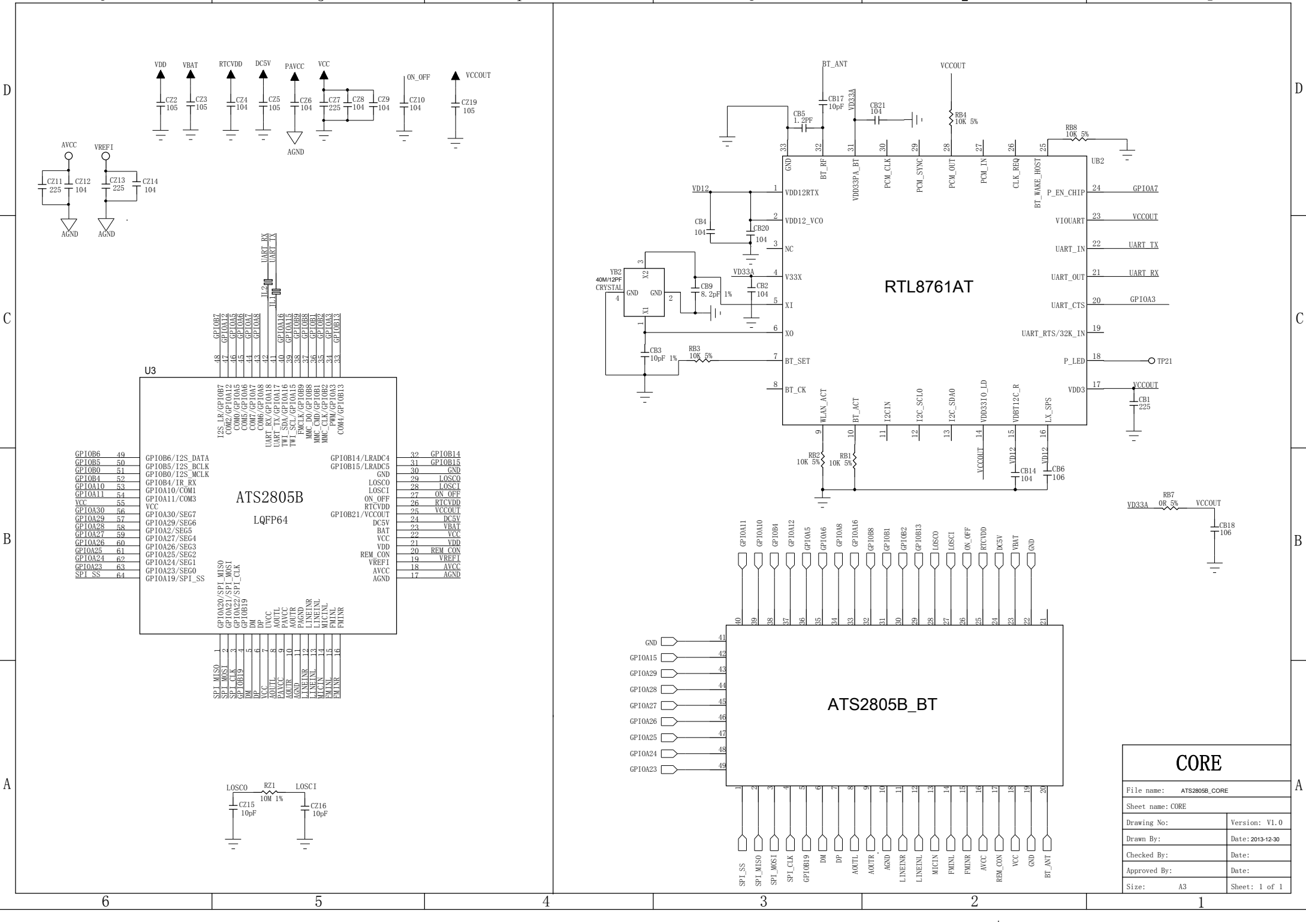

CORE	
File name:	AT2805B_CORE
Sheet name:	CORE
Drawing No:	Version: V1.0
Drawn By:	Date: 2013-12-30
Checked By:	Date:
Approved By:	Date:
Size:	A3 Sheet: 1 of 1