

ELECTROMAGNETIC EMISSIONS COMPLIANCE REPORT

INTENTIONAL RADIATOR CERTIFICATION TO FCC PART 15 SUBPART C REQUIREMENT

OF

Product Name: mobile phone

Brand Name: Hisense

Model No.: VH777

Model Difference: N/A

FCC ID: 2ADOBVH777

Report No.: ER/2015/10004

Issue Date: Jan. 30, 2015

FCC Rule Part: §15.247, Cat: DTS

Hisense International Co.,Ltd

Prepared for: Floor 22, Hisense Tower, 17 Donghai Xi Road, Qingdao

SGS Taiwan Ltd.
Electronics & Communication Laboratory

Prepared by: No.134, Wu Kung Road, New Taipei Industrial Park, Wuku District, New Taipei City, Taiwan 24803



Note: This report shall not be reproduced except in full, without the written approval of SGS Taiwan Ltd. This document may be altered or revised by SGS Taiwan Ltd. personnel only, and shall be noted in the revision section of the document.

Unless otherwise stated the results shown in this test report refer only to the sample(s) tested and such sample(s) are retained for 90 days only. 除非另有說明，此報告結果僅對測試之樣品負責，同時此樣品僅保留 90 天。本報告未經本公司書面許可，不可部份複製。

This document is issued by the Company subject to its General Conditions of Service printed overleaf, available on request or accessible at www.sgs.com/terms_and_conditions.htm and, for electronic format documents, subject to Terms and Conditions for Electronic Documents at www.sgs.com/terms_e-document.htm. Attention is drawn to the limitation of liability, indemnification and jurisdiction issues defined therein. Any holder of this document is advised that information contained hereon reflects the Company's findings at the time of its intervention only and within the limits of Client's instructions, if any. The Company's sole responsibility is to its Client and this document does not exonerate parties to a transaction from exercising all their rights and obligations under the transaction documents. This document cannot be reproduced except in full, without prior written approval of the Company. Any unauthorized alteration, forgery or falsification of the content or appearance of this document is unlawful and offenders may be prosecuted to the fullest extent of the law.

VERIFICATION OF COMPLIANCE

Applicant: Hisense International Co.,Ltd
 Floor 22, Hisense Tower, 17 Donghai Xi Road, Qingdao

Product Name: mobile phone

Brand Name: Hisense

Model No.: VH777

Model Difference: N/A

File Number: ER/2015/10004

FCC ID: 2ADOBVH777



Date of test: Jan. 05, 2015 ~ Jan. 30, 2015

Date of EUT Received: Jan. 05, 2015

We hereby certify that:

The above equipment was tested by SGS Taiwan Ltd. Electronics & Communication Laboratory The test data, data evaluation, test procedures, and equipment configurations shown in this report were made in accordance with the procedures given in ANSI C63.4:2009 the energy emitted by the sample EUT tested as described in this report is in compliance with conducted and radiated emission limits of FCC Rules Part 15.247.

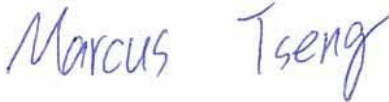
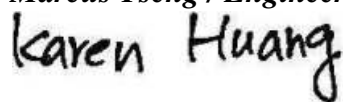
The test results of this report relate only to the tested sample identified in this report.

Test By:		Date:	Jan. 30, 2015
<i>Marcus Tseng / Engineer</i>			
Prepared By:		Date:	Jan. 30, 2015
<i>Karen Huang / Clerk</i>			
Approved By:		Date:	Jan. 30, 2015
<i>Jim Chang / Supervisor</i>			

Unless otherwise stated the results shown in this test report refer only to the sample(s) tested and such sample(s) are retained for 90 days only. 除非另有說明，此報告結果僅對測試之樣品負責，同時此樣品僅保留 90 天。本報告未經本公司書面許可，不可部份複製。

This document is issued by the Company subject to its General Conditions of Service printed overleaf, available on request or accessible at www.sgs.com/terms_and_conditions.htm and, for electronic format documents, subject to Terms and Conditions for Electronic Documents at www.sgs.com/terms_e-document.htm. Attention is drawn to the limitation of liability, indemnification and jurisdiction issues defined therein. Any holder of this document is advised that information contained hereon reflects the Company's findings at the time of its intervention only and within the limits of Client's instructions, if any. The Company's sole responsibility is to its Client and this document does not exonerate parties to a transaction from exercising all their rights and obligations under the transaction documents. This document cannot be reproduced except in full, without prior written approval of the Company. Any unauthorized alteration, forgery or falsification of the content or appearance of this document is unlawful and offenders may be prosecuted to the fullest extent of the law.

Version

Version No.	Date	Description
00	Jan. 30, 2015	Initial creation of document

Unless otherwise stated the results shown in this test report refer only to the sample(s) tested and such sample(s) are retained for 90 days only.
 除非另有說明，此報告結果僅對測試之樣品負責，同時此樣品僅保留 90 天。本報告未經本公司書面許可，不可部份複製。

This document is issued by the Company subject to its General Conditions of Service printed overleaf, available on request or accessible at www.sgs.com/terms_and_conditions.htm and, for electronic format documents, subject to Terms and Conditions for Electronic Documents at www.sgs.com/terms_e-document.htm. Attention is drawn to the limitation of liability, indemnification and jurisdiction issues defined therein. Any holder of this document is advised that information contained hereon reflects the Company's findings at the time of its intervention only and within the limits of Client's instructions, if any. The Company's sole responsibility is to its Client and this document does not exonerate parties to a transaction from exercising all their rights and obligations under the transaction documents. This document cannot be reproduced except in full, without prior written approval of the Company. Any unauthorized alteration, forgery or falsification of the content or appearance of this document is unlawful and offenders may be prosecuted to the fullest extent of the law.

Table of Contents

1	GENERAL INFORMATION.....	6
1.1	Product Description.....	6
1.2	Related Submittal(s) / Grant (s)	7
1.3	Test Methodology.....	7
1.4	Test Facility.....	7
1.5	Special Accessories	7
1.6	Equipment Modifications	7
2	SYSTEM TEST CONFIGURATION.....	8
2.1	EUT Configuration.....	8
2.2	EUT Exercise	8
2.3	Test Procedure	8
2.4	Configuration of Tested System	9
3	SUMMARY OF TEST RESULTS.....	10
4	DESCRIPTION OF TEST MODES.....	10
5	MEASUREMENT UNCERTAINTY	11
6	CONDUCTED EMISSION TEST	12
6.1	Standard Applicable:	12
6.2	Measurement Equipment Used:	12
6.3	EUT Setup:.....	12
6.4	Test SET-UP (Block Diagram of Configuration)	13
6.5	Measurement Procedure:.....	13
6.6	Measurement Result:.....	13
7.	PEAK OUTPUT POWER MEASUREMENT	16
7.1	Standard Applicable:	16
7.2	Measurement Equipment Used:	17
7.3	Test Set-up:.....	17
7.4	Measurement Procedure:.....	18
7.5	Measurement Result:.....	19
8	6dB BANDWIDTH.....	20
8.1	Standard Applicable:	20
8.2	Measurement Equipment Used:	20
8.3	Test Set-up:.....	20
8.4	Measurement Procedure:.....	20
8.5	Measurement Result:.....	21

Unless otherwise stated the results shown in this test report refer only to the sample(s) tested and such sample(s) are retained for 90 days only.
 除非另有說明，此報告結果僅對測試之樣品負責，同時此樣品僅保留 90 天。本報告未經本公司書面許可，不可部份複製。

This document is issued by the Company subject to its General Conditions of Service printed overleaf, available on request or accessible at www.sgs.com/terms_and_conditions.htm and, for electronic format documents, subject to Terms and Conditions for Electronic Documents at www.sgs.com/terms_e-document.htm. Attention is drawn to the limitation of liability, indemnification and jurisdiction issues defined therein. Any holder of this document is advised that information contained hereon reflects the Company's findings at the time of its intervention only and within the limits of Client's instructions, if any. The Company's sole responsibility is to its Client and this document does not exonerate parties to a transaction from exercising all their rights and obligations under the transaction documents. This document cannot be reproduced except in full, without prior written approval of the Company. Any unauthorized alteration, forgery or falsification of the content or appearance of this document is unlawful and offenders may be prosecuted to the fullest extent of the law.

9	BAND EDGES MEASUREMENT	24
9.1	Standard Applicable:	24
9.2	Measurement Equipment Used:	24
9.3	Test SET-UP:	25
9.4	Measurement Procedure:	26
9.5	Field Strength Calculation:	27
9.6	Measurement Result:	27
10	SPURIOUS RADIATED EMISSION TEST	31
10.1	Standard Applicable	31
10.2	Measurement Equipment Used:	31
10.3	Test SET-UP:	31
10.4	Measurement Procedure:	32
10.5	Field Strength Calculation	32
10.6	Measurement Result:	32
11	PEAK POWER SPECTRAL DENSITY	42
11.1	Standard Applicable:	42
11.2	Measurement Equipment Used:	42
11.3	Test Set-up:	42
11.4	Measurement Procedure:	42
11.5	Measurement Result:	43
12	ANTENNA REQUIREMENT	46
12.1	Standard Applicable:	46
12.2	Antenna Connected Construction:	46

Unless otherwise stated the results shown in this test report refer only to the sample(s) tested and such sample(s) are retained for 90 days only.
 除非另有說明，此報告結果僅對測試之樣品負責，同時此樣品僅保留 90 天。本報告未經本公司書面許可，不可部份複製。

This document is issued by the Company subject to its General Conditions of Service printed overleaf, available on request or accessible at www.sgs.com/terms_and_conditions.htm and, for electronic format documents, subject to Terms and Conditions for Electronic Documents at www.sgs.com/terms_e-document.htm. Attention is drawn to the limitation of liability, indemnification and jurisdiction issues defined therein. Any holder of this document is advised that information contained hereon reflects the Company's findings at the time of its intervention only and within the limits of Client's instructions, if any. The Company's sole responsibility is to its Client and this document does not exonerate parties to a transaction from exercising all their rights and obligations under the transaction documents. This document cannot be reproduced except in full, without prior written approval of the Company. Any unauthorized alteration, forgery or falsification of the content or appearance of this document is unlawful and offenders may be prosecuted to the fullest extent of the law.

1 GENERAL INFORMATION

1.1 Product Description

General:

Product Name:	mobile phone	
Brand Name:	Hisense	
Model No.:	VH777	
Model difference:	N/A	
Hardware Version:	V2.00	
Software Version:	L1051.4.01.02.US62	
Data Cable (USB):	Model No.: GT0211100, Supplier: WanLing	
Power Supply:	3.8Vdc Rechargeable Li-ion Battery or 5Vdc from AC/DC Adapter	
	Battery:	ModelNo.: LI38170J, Supplier: BAK
	Adapter:	Model No.: CYSK05-050100, Supplier: chenyanelec

Bluetooth 4.0:

Frequency Range:	2402 – 2480MHz
Bluetooth Version:	V4.0 (dual mode)
Channel number:	40 channels
Modulation type:	GFSK
Transmit Power:	0.29dBm (Peak)
Antenna Designation:	LDS Antenna, 1.71dBi

This test report applies for Bluetooth V4.0 function.

Unless otherwise stated the results shown in this test report refer only to the sample(s) tested and such sample(s) are retained for 90 days only. 除非另有說明，此報告結果僅對測試之樣品負責，同時此樣品僅保留 90 天。本報告未經本公司書面許可，不可部份複製。

This document is issued by the Company subject to its General Conditions of Service printed overleaf, available on request or accessible at www.sgs.com/terms_and_conditions.htm and, for electronic format documents, subject to Terms and Conditions for Electronic Documents at www.sgs.com/terms_e-document.htm. Attention is drawn to the limitation of liability, indemnification and jurisdiction issues defined therein. Any holder of this document is advised that information contained hereon reflects the Company's findings at the time of its intervention only and within the limits of Client's instructions, if any. The Company's sole responsibility is to its Client and this document does not exonerate parties to a transaction from exercising all their rights and obligations under the transaction documents. This document cannot be reproduced except in full, without prior written approval of the Company. Any unauthorized alteration, forgery or falsification of the content or appearance of this document is unlawful and offenders may be prosecuted to the fullest extent of the law.

1.2 Related Submittal(s) / Grant (s)

This submittal(s) (test report) is intended for **FCC ID: 2ADOBVH777** filing to comply with Section 15.247 of the FCC Part 15, Subpart C Rules. The composite system (digital device) is compliance with Subpart B is authorized under a DoC procedure.

1.3 Test Methodology

Both conducted and radiated testing was performed according to the procedures in ANSI C63.4:2009. Radiated testing was performed at an antenna to EUT distance 3 meters.

Tested in accordance with Jun 2014 KDB558074 V03r02 for compliance to FCC 47CFR 15.247 requirements.

1.4 Test Facility

The measurement facilities used to collect the 3m Radiated Emission and AC power line conducted data are located on the address of SGS Taiwan Ltd. Electronics & Communication Laboratory No.134, Wu Kung Road, New Taipei Industrial Park, Wuku District, New Taipei City, Taiwan which are constructed and calibrated to meet the FCC requirements in documents ANSI C63.4: 2009. FCC Registration Numbers are: 990257, Canada Registration Number: 4620A-4.

The 10 m Open Area Test Sites located on the address of SGS Taiwan Ltd. Electronics & Communication Laboratory No.2, Keji 1st Rd., Guishan Township, Taoyuan County, Taiwan, which is constructed and calibrated to meet the CISPR 22/EN 55022 requirements. SGS Site No. 1(3 &10 meters) and FCC Registration Number: 455997.

1.5 Special Accessories

There are no special accessories used while test was conducted.

1.6 Equipment Modifications

There was no modification incorporated into the EUT.

Unless otherwise stated the results shown in this test report refer only to the sample(s) tested and such sample(s) are retained for 90 days only.
除非另有說明，此報告結果僅對測試之樣品負責，同時此樣品僅保留 90 天。本報告未經本公司書面許可，不可部份複製。

This document is issued by the Company subject to its General Conditions of Service printed overleaf, available on request or accessible at www.sgs.com/terms_and_conditions.htm and, for electronic format documents, subject to Terms and Conditions for Electronic Documents at www.sgs.com/terms_e-document.htm. Attention is drawn to the limitation of liability, indemnification and jurisdiction issues defined therein. Any holder of this document is advised that information contained hereon reflects the Company's findings at the time of its intervention only and within the limits of Client's instructions, if any. The Company's sole responsibility is to its Client and this document does not exonerate parties to a transaction from exercising all their rights and obligations under the transaction documents. This document cannot be reproduced except in full, without prior written approval of the Company. Any unauthorized alteration, forgery or falsification of the content or appearance of this document is unlawful and offenders may be prosecuted to the fullest extent of the law.

2 SYSTEM TEST CONFIGURATION

2.1 EUT Configuration

The EUT configuration for testing is installed on RF field strength measurement to meet the Commissions requirement and operating in a manner which intends to maximize its emission characteristics in a continuous normal application.

2.2 EUT Exercise

An engineering test mode (software/firmware) that applicant provided was utilized to manipulate the EUT into transmit, selection of the test channel, and modulation scheme.

2.3 Test Procedure

2.3.1 Conducted Emissions

The EUT is a placed on as turn table which is 0.8 m above ground plane. According to the general criterion in Section 7.1 of ANSI C63.4:2009. Conducted emissions from the EUT measured in the frequency range between 0.15 MHz and 30MHz, and the measurement procedure 7.3 in ANSI 63.4:2009 is followed to carry out the test. The CISPR Quasi-Peak and Average detector mode is employed according to §15.107

2.3.2 Radiated Emissions

The EUT is a placed on as turn table which is 0.8 m above ground plane. The turn table shall rotate 360 degrees to determine the position of maximum emission level. EUT is set 3m away from the receiving antenna which varied from 1m to 4m to find out the highest emission. And also, each emission was to be maximized by changing the polarization of receiving antenna both horizontal and vertical. In order to find out the max. emission, the relative positions of this hand-held transmitter (EUT) was rotated through three orthogonal axes and measurement procedures for electric field radiated emissions above 1 GHz the EUT measurement is to be made "while keeping the antenna in the 'cone of radiation' from that area and pointed at the area both in azimuth and elevation, with polarization oriented for maximum response." is still within the 3dB illumination BW of the measurement antenna. according to the requirements in Section 8 and 13 and of ANSI C63.4:2009,.

Unless otherwise stated the results shown in this test report refer only to the sample(s) tested and such sample(s) are retained for 90 days only.
除非另有說明，此報告結果僅對測試之樣品負責，同時此樣品僅保留 90 天。本報告未經本公司書面許可，不可部份複製。

This document is issued by the Company subject to its General Conditions of Service printed overleaf, available on request or accessible at www.sgs.com/terms_and_conditions.htm and, for electronic format documents, subject to Terms and Conditions for Electronic Documents at www.sgs.com/terms_e-document.htm. Attention is drawn to the limitation of liability, indemnification and jurisdiction issues defined therein. Any holder of this document is advised that information contained hereon reflects the Company's findings at the time of its intervention only and within the limits of Client's instructions, if any. The Company's sole responsibility is to its Client and this document does not exonerate parties to a transaction from exercising all their rights and obligations under the transaction documents. This document cannot be reproduced except in full, without prior written approval of the Company. Any unauthorized alteration, forgery or falsification of the content or appearance of this document is unlawful and offenders may be prosecuted to the fullest extent of the law.

2.4 Configuration of Tested System

Fig. 2-1 Radiated & AC Power Line Conducted Emission Configuration



Fig. 2-2 Conducted (Antenna Port) Configuration

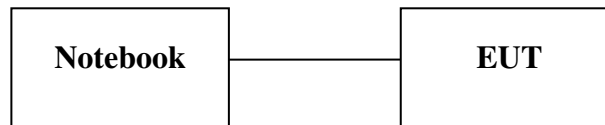

Table 2-1 Equipment Used in Tested System

Item	Equipment	Mfr/Brand	Model/Type No.	Series No.	Data Cable	Power Cord
1.	Notebook	Lenovo	L420	LR-7HXZA	shielded	unshielded
2.	BT Test Software	N/A	N/A	N/A	N/A	N/A

Unless otherwise stated the results shown in this test report refer only to the sample(s) tested and such sample(s) are retained for 90 days only.
 除非另有說明，此報告結果僅對測試之樣品負責，同時此樣品僅保留 90 天。本報告未經本公司書面許可，不可部份複製。

This document is issued by the Company subject to its General Conditions of Service printed overleaf, available on request or accessible at www.sgs.com/terms_and_conditions.htm and, for electronic format documents, subject to Terms and Conditions for Electronic Documents at www.sgs.com/terms_e-document.htm. Attention is drawn to the limitation of liability, indemnification and jurisdiction issues defined therein. Any holder of this document is advised that information contained hereon reflects the Company's findings at the time of its intervention only and within the limits of Client's instructions, if any. The Company's sole responsibility is to its Client and this document does not exonerate parties to a transaction from exercising all their rights and obligations under the transaction documents. This document cannot be reproduced except in full, without prior written approval of the Company. Any unauthorized alteration, forgery or falsification of the content or appearance of this document is unlawful and offenders may be prosecuted to the fullest extent of the law.

3 SUMMARY OF TEST RESULTS

FCC Rules	Description Of Test	Result
§15.207(a)	AC Power Line Conducted Emission	Compliant
§15.247(b) (3)	Peak Output Power	Compliant
§15.247(a)(2)	6dB Bandwidth	Compliant
§15.247(d)	100 KHz Bandwidth Of Frequency Band Edges	Compliant
§15.247(d)	Spurious Emission	Compliant
§15.247(e)	Peak Power Density	Compliant
§15.203	Antenna Requirement	Compliant

4 DESCRIPTION OF TEST MODES

The EUT has been tested under operating condition.

Test program used to control the EUT for staying in continuous transmitting and receiving mode is programmed.

Channel low (2402MHz)、mid (2442MHz) and high (2480MHz) with BT4.0 mode is chosen for full testing.

The field strength of radiation emission was measured as EUT stand-up position (H mode) and lie down position (E1, E2 mode) for BT4.0 mode Transmitter for channel Low, Mid and High, the worst case H position was reported.

Unless otherwise stated the results shown in this test report refer only to the sample(s) tested and such sample(s) are retained for 90 days only.
 除非另有說明，此報告結果僅對測試之樣品負責，同時此樣品僅保留 90 天。本報告未經本公司書面許可，不可部份複製。

This document is issued by the Company subject to its General Conditions of Service printed overleaf, available on request or accessible at www.sgs.com/terms_and_conditions.htm and, for electronic format documents, subject to Terms and Conditions for Electronic Documents at www.sgs.com/terms_e-document.htm. Attention is drawn to the limitation of liability, indemnification and jurisdiction issues defined therein. Any holder of this document is advised that information contained hereon reflects the Company's findings at the time of its intervention only and within the limits of Client's instructions, if any. The Company's sole responsibility is to its Client and this document does not exonerate parties to a transaction from exercising all their rights and obligations under the transaction documents. This document cannot be reproduced except in full, without prior written approval of the Company. Any unauthorized alteration, forgery or falsification of the content or appearance of this document is unlawful and offenders may be prosecuted to the fullest extent of the law.

5 MEASUREMENT UNCERTAINTY

Test Items	Uncertainty
AC Power Line Conducted Emission	+/- 2.586 dB
Peak Output Power	+/- 1.42 dB
6dB Bandwidth	+/- 123.36 Hz
100 KHz Bandwidth Of Frequency Band Edges	+/- 1.55 dB
Peak Power Density	+/- 1.55 dB
99% Power Bandwidth	+/- 123.36 Hz
Temperature	+/- 0.8 °C
Humidity	+/- 4.7 %
DC / AC Power Source	DC= +/- 1%, AC= +/- 0.2%

Radiated Spurious Emission:

Measurement uncertainty (Polarization : Vertical)	30MHz - 180MHz: +/- 3.37dB
	180MHz -417MHz: +/- 3.19dB
	0.417GHz-1GHz: +/- 3.19dB
	1GHz - 18GHz: +/- 4.04dB
	18GHz - 40GHz: +/- 4.04dB

Measurement uncertainty (Polarization : Horizontal)	30MHz - 167MHz: +/- 4.22dB
	167MHz -500MHz: +/- 3.44dB
	0.5GHz-1GHz: +/- 3.39dB
	1GHz - 18GHz: +/- 4.08dB
	18GHz - 40GHz: +/- 4.08dB

This uncertainty represents an expanded uncertainty expressed at approximately the 95% confidence level using a coverage factor of k=2.

Unless otherwise stated the results shown in this test report refer only to the sample(s) tested and such sample(s) are retained for 90 days only. 除非另有說明，此報告結果僅對測試之樣品負責，同時此樣品僅保留 90 天。本報告未經本公司書面許可，不可部份複製。

This document is issued by the Company subject to its General Conditions of Service printed overleaf, available on request or accessible at www.sgs.com/terms_and_conditions.htm and, for electronic format documents, subject to Terms and Conditions for Electronic Documents at www.sgs.com/terms_e-document.htm. Attention is drawn to the limitation of liability, indemnification and jurisdiction issues defined therein. Any holder of this document is advised that information contained hereon reflects the Company's findings at the time of its intervention only and within the limits of Client's instructions, if any. The Company's sole responsibility is to its Client and this document does not exonerate parties to a transaction from exercising all their rights and obligations under the transaction documents. This document cannot be reproduced except in full, without prior written approval of the Company. Any unauthorized alteration, forgery or falsification of the content or appearance of this document is unlawful and offenders may be prosecuted to the fullest extent of the law.

6 CONDUCTED EMISSION TEST

6.1 Standard Applicable:

According to §15.207, frequency range within 150 KHz to 30MHz shall not exceed the Limit table as below.

Frequency range MHz	Limits dB(uV)	
	Quasi-peak	Average
0.15 to 0.50	66 to 56	56 to 46
0.50 to 5	56	46
5 to 30	60	50

Note

- 1.The lower limit shall apply at the transition frequencies
- 2.The limit decreases linearly with the logarithm of the frequency in the range 0.15 MHz to 0.50 MHz.

6.2 Measurement Equipment Used:

Conducted Emission Test Site					
EQUIPMENT TYPE	MFR	MODEL NUMBER	SERIAL NUMBER	LAST CAL.	CAL DUE.
EMI Test Receiver	R&S	ESCI7	100760	05/26/2014	05/25/2015
LISN	Rolf-Heine	NNB-2/16Z	99012	03/26/2014	03/25/2015
LISN	FCC	FCC-LISN-50/250-25-2-01	04034	03/19/2014	03/18/2015
Coaxial Cables	N/A	WK CE Cable	N/A	11/26/2014	11/25/2015

6.3 EUT Setup:

1. The conducted emission tests were performed in the test site, using the setup in accordance with the ANSI C63.4-2009.
2. The AC/DC Power adaptor of EUT was plug-in LISN. The EUT was placed flushed with the rear of the table.
3. The LISN was connected with 120Vac/60Hz power source.

Unless otherwise stated the results shown in this test report refer only to the sample(s) tested and such sample(s) are retained for 90 days only.
除非另有說明，此報告結果僅對測試之樣品負責，同時此樣品僅保留 90 天。本報告未經本公司書面許可，不可部份複製。

This document is issued by the Company subject to its General Conditions of Service printed overleaf, available on request or accessible at www.sgs.com/terms_and_conditions.htm and, for electronic format documents, subject to Terms and Conditions for Electronic Documents at www.sgs.com/terms_e-document.htm. Attention is drawn to the limitation of liability, indemnification and jurisdiction issues defined therein. Any holder of this document is advised that information contained hereon reflects the Company's findings at the time of its intervention only and within the limits of Client's instructions, if any. The Company's sole responsibility is to its Client and this document does not exonerate parties to a transaction from exercising all their rights and obligations under the transaction documents. This document cannot be reproduced except in full, without prior written approval of the Company. Any unauthorized alteration, forgery or falsification of the content or appearance of this document is unlawful and offenders may be prosecuted to the fullest extent of the law.

6.4 Test SET-UP (Block Diagram of Configuration)

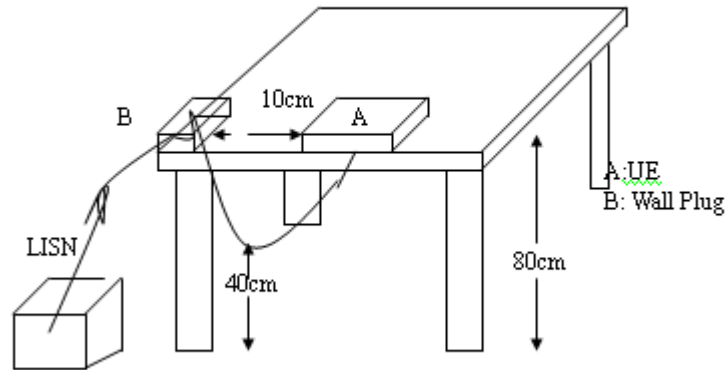

6.5 Measurement Procedure:

1. The EUT was placed on a table which is 0.8m above ground plane.
2. Maximum procedure was performed on the six highest emissions to ensure EUT compliance.
3. Repeat above procedures until all phases of power being supplied by given UE are completed

6.6 Measurement Result:

Note: Refer to next page for measurement data and plots.

Note2: The * reveals the worst-case results that closet to the limit

Unless otherwise stated the results shown in this test report refer only to the sample(s) tested and such sample(s) are retained for 90 days only.
 除非另有說明，此報告結果僅對測試之樣品負責，同時此樣品僅保留 90 天。本報告未經本公司書面許可，不可部份複製。

This document is issued by the Company subject to its General Conditions of Service printed overleaf, available on request or accessible at www.sgs.com/terms_and_conditions.htm and, for electronic format documents, subject to Terms and Conditions for Electronic Documents at www.sgs.com/terms_e-document.htm. Attention is drawn to the limitation of liability, indemnification and jurisdiction issues defined therein. Any holder of this document is advised that information contained hereon reflects the Company's findings at the time of its intervention only and within the limits of Client's instructions, if any. The Company's sole responsibility is to its Client and this document does not exonerate parties to a transaction from exercising all their rights and obligations under the transaction documents. This document cannot be reproduced except in full, without prior written approval of the Company. Any unauthorized alteration, forgery or falsification of the content or appearance of this document is unlawful and offenders may be prosecuted to the fullest extent of the law.

AC POWER LINE CONDUCTED EMISSION TEST DATA

Operation Mode:	Bluetooth Mode	Test Date:	Jan. 15, 2015
Temperature:	24 °C	Humidity:	66 %
		Test By:	Curry

Site: ConductionRoom	Phase: L1	Temperature: 24 °C
Limit: FCC Class B Conduction(QP)	Power: AC 120V/60Hz	Humidity: 66%
Mode: Operation		
Note: Adapter:CYSK05-050100		

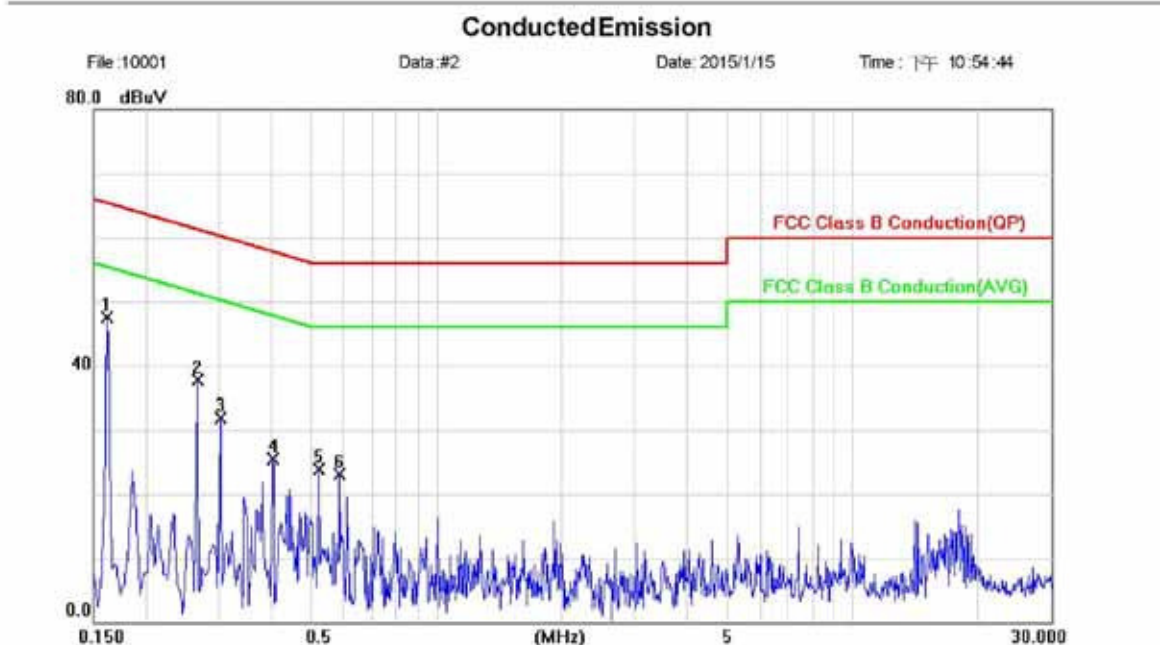

No.	Mk.	Freq. MHz	Reading Level dBuV	Correct Factor dB	Measure- ment dBuV	Limit dBuV	Over dB	Detector	Comment
1	*	0.1620	47.38	0.05	47.43	65.36	-17.93	peak	
2		0.2660	37.56	0.06	37.62	61.24	-23.62	peak	
3		0.3020	31.85	0.07	31.92	60.19	-28.27	peak	
4		0.4060	25.34	0.07	25.41	57.73	-32.32	peak	
5		0.5220	23.77	0.08	23.85	56.00	-32.15	peak	
6		0.5860	22.95	0.08	23.03	56.00	-32.97	peak	

Unless otherwise stated the results shown in this test report refer only to the sample(s) tested and such sample(s) are retained for 90 days only. 除非另有說明，此報告結果僅對測試之樣品負責，同時此樣品僅保留 90 天。本報告未經本公司書面許可，不可部份複製。

This document is issued by the Company subject to its General Conditions of Service printed overleaf, available on request or accessible at www.sgs.com/terms_and_conditions.htm and, for electronic format documents, subject to Terms and Conditions for Electronic Documents at www.sgs.com/terms_e-document.htm. Attention is drawn to the limitation of liability, indemnification and jurisdiction issues defined therein. Any holder of this document is advised that information contained hereon reflects the Company's findings at the time of its intervention only and within the limits of Client's instructions, if any. The Company's sole responsibility is to its Client and this document does not exonerate parties to a transaction from exercising all their rights and obligations under the transaction documents. This document cannot be reproduced except in full, without prior written approval of the Company. Any unauthorized alteration, forgery or falsification of the content or appearance of this document is unlawful and offenders may be prosecuted to the fullest extent of the law.

Site: ConductionRoom	Phase: N	Temperature: 24 °C
Limit: FCC Class B Conduction(QP)	Power: AC 120V/60Hz	Humidity: 66%
Mode: Operation		
Note: Adapter:CYSK05-050100		

Conducted Emission

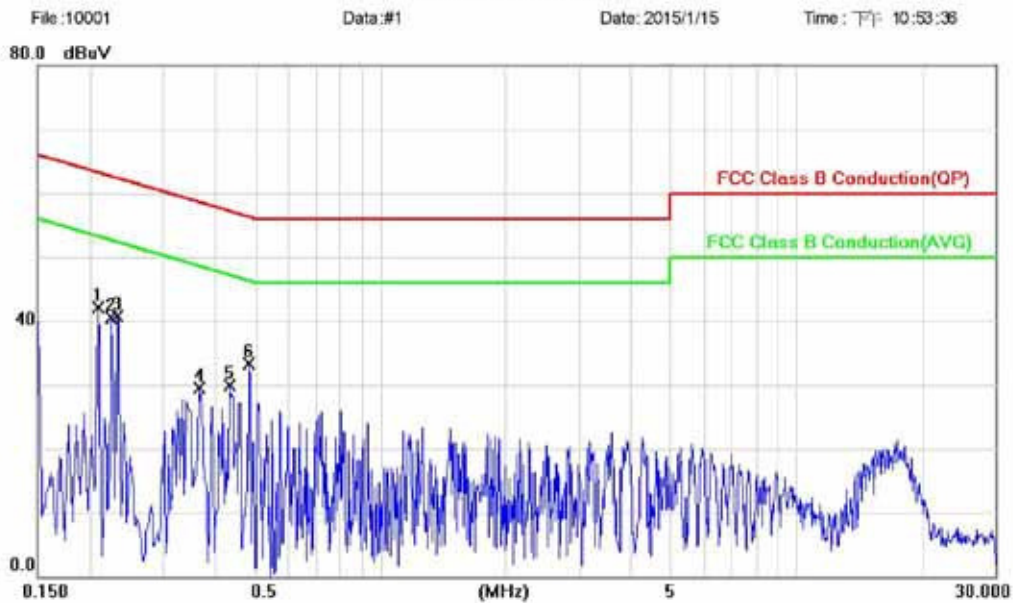

No.	Mk.	Freq.	Reading Level	Correct Factor	Measurement	Limit	Over	Detector	Comment
		MHz	dBuV	dB	dBuV	dBuV	dB		
1	*	0.2100	42.13	0.06	42.19	63.21	-21.02	peak	
2		0.2260	40.42	0.06	40.48	62.60	-22.12	peak	
3		0.2340	40.67	0.06	40.73	62.31	-21.58	peak	
4		0.3660	29.37	0.07	29.44	58.59	-29.15	peak	
5		0.4340	29.83	0.07	29.90	57.18	-27.28	peak	
6		0.4860	33.15	0.07	33.22	56.24	-23.02	peak	

Unless otherwise stated the results shown in this test report refer only to the sample(s) tested and such sample(s) are retained for 90 days only.

除非另有說明，此報告結果僅對測試之樣品負責，同時此樣品僅保留 90 天。本報告未經本公司書面許可，不可部份複製。

This document is issued by the Company subject to its General Conditions of Service printed overleaf, available on request or accessible at www.sgs.com/terms_and_conditions.htm and, for electronic format documents, subject to Terms and Conditions for Electronic Documents at www.sgs.com/terms_e-document.htm. Attention is drawn to the limitation of liability, indemnification and jurisdiction issues defined therein. Any holder of this document is advised that information contained hereon reflects the Company's findings at the time of its intervention only and within the limits of Client's instructions, if any. The Company's sole responsibility is to its Client and this document does not exonerate parties to a transaction from exercising all their rights and obligations under the transaction documents. This document cannot be reproduced except in full, without prior written approval of the Company. Any unauthorized alteration, forgery or falsification of the content or appearance of this document is unlawful and offenders may be prosecuted to the fullest extent of the law.

7. PEAK OUTPUT POWER MEASUREMENT

7.1 Standard Applicable:

According to §15.247 (b)

(3) For systems using digital modulation in the 902-928 MHz and 2400-2483.5 MHz bands: 1 Watt. As an alternative to a peak power measurement, compliance with the one Watt limit can be based on a measurement of the maximum conducted output power. Maximum Conducted Output Power is defined as the total transmit power delivered to all antennas and antenna elements averaged across all symbols in the signaling alphabet when the transmitter is operating at its maximum power control level. Power must be summed across all antennas and antenna elements. The average must not include any time intervals during which the transmitter is off or is transmitting at a reduced power level. If multiple modes of operation are possible (e.g., alternative modulation methods), the maximum conducted output power is the highest total transmit power occurring in any mode.

(4) The conducted output power limit specified in paragraph (b) of this section is based on the use of antennas with directional gains that do not exceed 6 dBi. Except as shown in paragraph (c) of this section, if transmitting antennas of directional gain greater than 6 dBi are used, the conducted output power from the intentional radiator shall be reduced below the stated values in paragraphs (b)(1), (b)(2), and (b)(3) of this section, as appropriate, by the amount in dB that the directional gain of the antenna exceeds 6 dBi.

Unless otherwise stated the results shown in this test report refer only to the sample(s) tested and such sample(s) are retained for 90 days only.
除非另有說明，此報告結果僅對測試之樣品負責，同時此樣品僅保留 90 天。本報告未經本公司書面許可，不可部份複製。

This document is issued by the Company subject to its General Conditions of Service printed overleaf, available on request or accessible at www.sgs.com/terms_and_conditions.htm and, for electronic format documents, subject to Terms and Conditions for Electronic Documents at www.sgs.com/terms_e-document.htm. Attention is drawn to the limitation of liability, indemnification and jurisdiction issues defined therein. Any holder of this document is advised that information contained hereon reflects the Company's findings at the time of its intervention only and within the limits of Client's instructions, if any. The Company's sole responsibility is to its Client and this document does not exonerate parties to a transaction from exercising all their rights and obligations under the transaction documents. This document cannot be reproduced except in full, without prior written approval of the Company. Any unauthorized alteration, forgery or falsification of the content or appearance of this document is unlawful and offenders may be prosecuted to the fullest extent of the law.

7.2 Measurement Equipment Used:

Conducted Emission Test Site					
EQUIPMENT TYPE	MFR	MODEL NUMBER	SERIAL NUMBER	LAST CAL.	CAL DUE.
Power Meter	Anritsu	ML2495A	1005007	12/20/2014	12/19/2015
Power Sensor	Anritsu	MA2411B	917032	12/20/2014	12/19/2015
Spectrum Analyzer	Agilent	E4446A	MY51100003	05/19/2014	05/18/2015
Spectrum Analyzer	Agilent	E4440A	MY45304525	03/08/2014	03/07/2015
DC Block	Mini-Circuits	BLK-18-S+	1	01/02/2015	01/01/2016
Low Loss Cable	HUBER+SUHNER	SUCOFLEX 104PEA	N/A	01/02/2015	01/01/2016
Attenuator	Mini-Circuit	BW-S10W2+	002	01/02/2015	01/01/2016
Splitter	Agilent	11636B	N/A	01/02/2015	01/01/2016

7.3 Test Set-up:

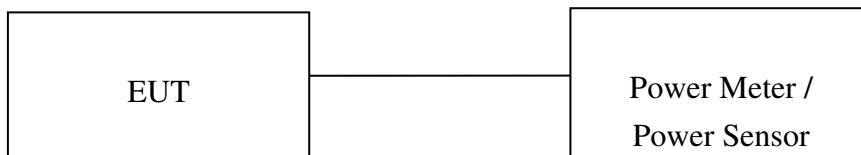

Unless otherwise stated the results shown in this test report refer only to the sample(s) tested and such sample(s) are retained for 90 days only. 除非另有說明，此報告結果僅對測試之樣品負責，同時此樣品僅保留 90 天。本報告未經本公司書面許可，不可部份複製。

This document is issued by the Company subject to its General Conditions of Service printed overleaf, available on request or accessible at www.sgs.com/terms_and_conditions.htm and, for electronic format documents, subject to Terms and Conditions for Electronic Documents at www.sgs.com/terms_e-document.htm. Attention is drawn to the limitation of liability, indemnification and jurisdiction issues defined therein. Any holder of this document is advised that information contained hereon reflects the Company's findings at the time of its intervention only and within the limits of Client's instructions, if any. The Company's sole responsibility is to its Client and this document does not exonerate parties to a transaction from exercising all their rights and obligations under the transaction documents. This document cannot be reproduced except in full, without prior written approval of the Company. Any unauthorized alteration, forgery or falsification of the content or appearance of this document is unlawful and offenders may be prosecuted to the fullest extent of the law.

7.4 Measurement Procedure:

1. Place the EUT on the table and set it in transmitting mode.
2. Remove the antenna from the EUT and then connect a low loss RF cable from the antenna port to the power meter or spectrum. (**Peak power setting on Spectrum:** Channel power function, RBW = 1MHz, VBW = 3MHz, Span: 30/60MHz, Detector =peak, Sweep = Auto.
(**Avg. power setting on Spectrum:** Channel power function, RBW = 1MHz, VBW = 3MHz, Span: 30/60MHz, Detector =Avg., Trace avg =100, Sweep = Auto, Setting on spectrum is adjusted based on the mandatory procedure in 9.2.2.4 of the KDB558074). Power Meter is used as the auxiliary test equipment to conduct the output power measurement. 9.2.3, option 3 in KDB558074 is followed.
3. Record the max. Reading as observed from Spectrum or Power Meter.
4. Repeat above procedures until all test default channel measured was complete.

Duty Factor:

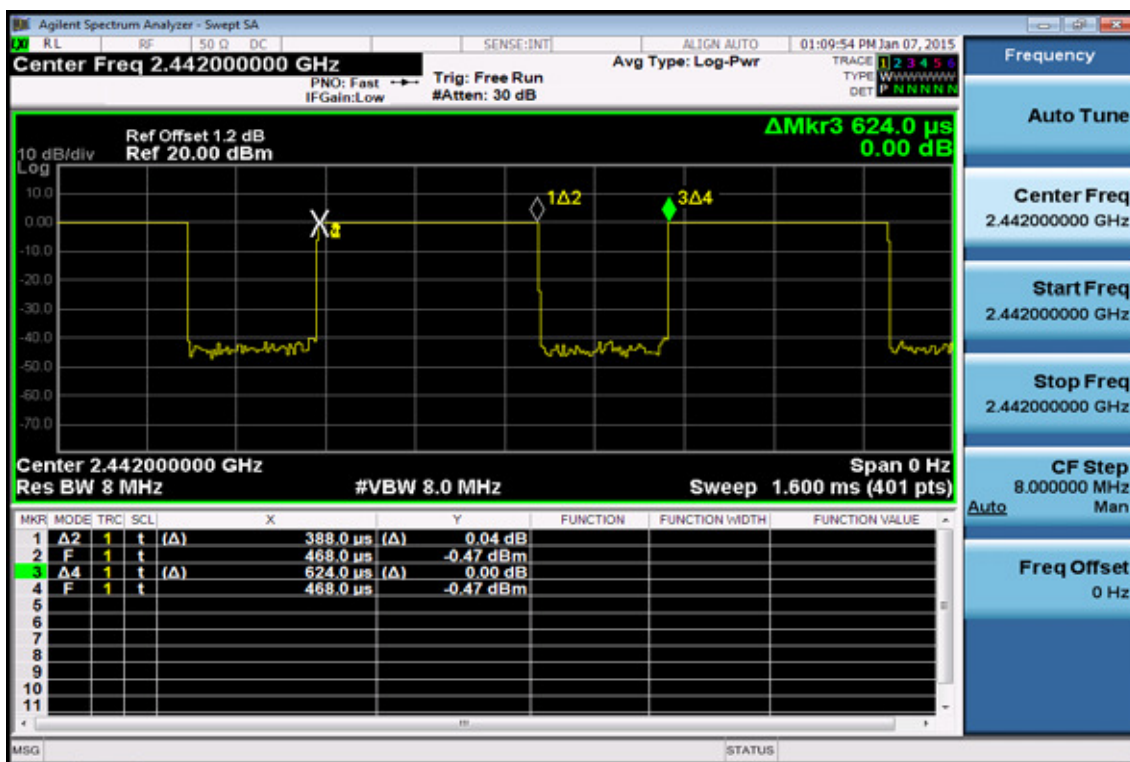

Unless otherwise stated the results shown in this test report refer only to the sample(s) tested and such sample(s) are retained for 90 days only. 除非另有說明，此報告結果僅對測試之樣品負責，同時此樣品僅保留 90 天。本報告未經本公司書面許可，不可部份複製。

This document is issued by the Company subject to its General Conditions of Service printed overleaf, available on request or accessible at www.sgs.com/terms_and_conditions.htm and, for electronic format documents, subject to Terms and Conditions for Electronic Documents at www.sgs.com/terms_e-document.htm. Attention is drawn to the limitation of liability, indemnification and jurisdiction issues defined therein. Any holder of this document is advised that information contained hereon reflects the Company's findings at the time of its intervention only and within the limits of Client's instructions, if any. The Company's sole responsibility is to its Client and this document does not exonerate parties to a transaction from exercising all their rights and obligations under the transaction documents. This document cannot be reproduced except in full, without prior written approval of the Company. Any unauthorized alteration, forgery or falsification of the content or appearance of this document is unlawful and offenders may be prosecuted to the fullest extent of the law.

7.5 Measurement Result:

BT4.0 mode:

CH	Frequency (MHz)	Peak Power Output(dBm)	Required Limit
0	2402	-0.92	1 Watt = 30 dBm
20	2442	0.29	1 Watt = 30 dBm
39	2480	-1.00	1 Watt = 30 dBm

CH	Frequency (MHz)	Average Power Output(dBm)	Required Limit
0	2402	-3.21	1 Watt = 30 dBm
20	2442	-2.01	1 Watt = 30 dBm
39	2480	-3.18	1 Watt = 30 dBm

**Note: Measured by power meter, cable loss as 1.2dB that offsets on the power meter in Peak*

**Note: Measured by power meter, as cable loss+ Duty cycle factor that offsets on the power meter*

Unless otherwise stated the results shown in this test report refer only to the sample(s) tested and such sample(s) are retained for 90 days only.
 除非另有說明，此報告結果僅對測試之樣品負責，同時此樣品僅保留 90 天。本報告未經本公司書面許可，不可部份複製。

This document is issued by the Company subject to its General Conditions of Service printed overleaf, available on request or accessible at www.sgs.com/terms_and_conditions.htm and, for electronic format documents, subject to Terms and Conditions for Electronic Documents at www.sgs.com/terms_e-document.htm. Attention is drawn to the limitation of liability, indemnification and jurisdiction issues defined therein. Any holder of this document is advised that information contained hereon reflects the Company's findings at the time of its intervention only and within the limits of Client's instructions, if any. The Company's sole responsibility is to its Client and this document does not exonerate parties to a transaction from exercising all their rights and obligations under the transaction documents. This document cannot be reproduced except in full, without prior written approval of the Company. Any unauthorized alteration, forgery or falsification of the content or appearance of this document is unlawful and offenders may be prosecuted to the fullest extent of the law.

8 6dB BANDWIDTH

8.1 Standard Applicable:

According to §15.247(a)(2), Systems using digital modulation techniques may operate in the 902 - 928 MHz and 2400 - 2483.5 MHz bands. The minimum 6 dB bandwidth shall be at least 500 kHz.

8.2 Measurement Equipment Used:

Refer to section 7.2 for details.

8.3 Test Set-up:

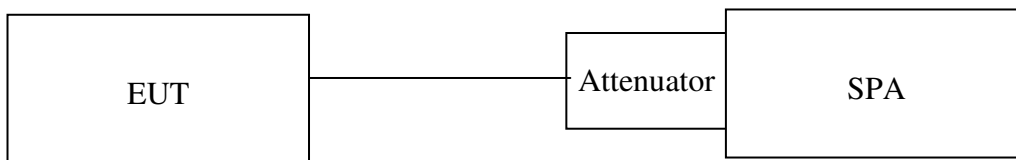

8.4 Measurement Procedure:

1. Place the EUT on the table and set it in transmitting mode.
2. Remove the antenna from the EUT and then connect a low loss RF cable from the antenna port to the spectrum analyzer.
3. Set the spectrum analyzer as RBW = 100 kHz, VBW = 3*RBW, Span = 5MHz, Detector=Peak, Sweep=auto, the setting on spectrum is adjusted based on the procedure as guide in 8.1 option 1 of KDB558074.
4. Mark the peak frequency and -6dB (upper and lower) frequency.
5. Repeat above procedures until all test default channel measured were complete.

Unless otherwise stated the results shown in this test report refer only to the sample(s) tested and such sample(s) are retained for 90 days only.
除非另有說明，此報告結果僅對測試之樣品負責，同時此樣品僅保留 90 天。本報告未經本公司書面許可，不可部份複製。

This document is issued by the Company subject to its General Conditions of Service printed overleaf, available on request or accessible at www.sgs.com/terms_and_conditions.htm and, for electronic format documents, subject to Terms and Conditions for Electronic Documents at www.sgs.com/terms_e-document.htm. Attention is drawn to the limitation of liability, indemnification and jurisdiction issues defined therein. Any holder of this document is advised that information contained hereon reflects the Company's findings at the time of its intervention only and within the limits of Client's instructions, if any. The Company's sole responsibility is to its Client and this document does not exonerate parties to a transaction from exercising all their rights and obligations under the transaction documents. This document cannot be reproduced except in full, without prior written approval of the Company. Any unauthorized alteration, forgery or falsification of the content or appearance of this document is unlawful and offenders may be prosecuted to the fullest extent of the law.

8.5 Measurement Result:

BT4.0 mode

Frequency (MHz)	Bandwidth (kHz)	Bandwidth (kHz)	Result
2402	679.7	> 500	PASS
2442	680.7	> 500	PASS
2480	683.4	> 500	PASS

* Cable loss as 1.2dB that offsets on the spectrum.

* Note: The arrow “->” reveals X decibel level

Note: Refer to next page for plots.

Unless otherwise stated the results shown in this test report refer only to the sample(s) tested and such sample(s) are retained for 90 days only.
 除非另有說明，此報告結果僅對測試之樣品負責，同時此樣品僅保留 90 天。本報告未經本公司書面許可，不可部份複製。

This document is issued by the Company subject to its General Conditions of Service printed overleaf, available on request or accessible at www.sgs.com/terms_and_conditions.htm and, for electronic format documents, subject to Terms and Conditions for Electronic Documents at www.sgs.com/terms_e-document.htm. Attention is drawn to the limitation of liability, indemnification and jurisdiction issues defined therein. Any holder of this document is advised that information contained hereon reflects the Company's findings at the time of its intervention only and within the limits of Client's instructions, if any. The Company's sole responsibility is to its Client and this document does not exonerate parties to a transaction from exercising all their rights and obligations under the transaction documents. This document cannot be reproduced except in full, without prior written approval of the Company. Any unauthorized alteration, forgery or falsification of the content or appearance of this document is unlawful and offenders may be prosecuted to the fullest extent of the law.

BT4.0 mode
6dB Band Width Test Data CH-Low

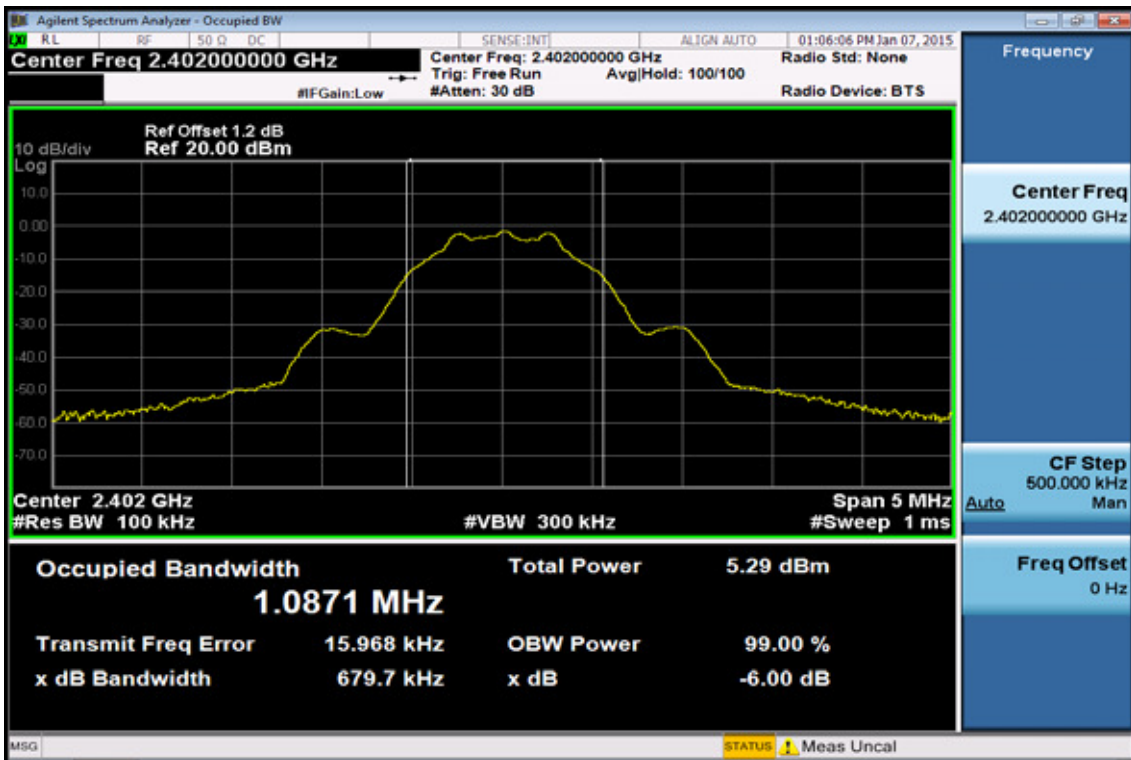

6dB Band Width Test Data CH-Mid

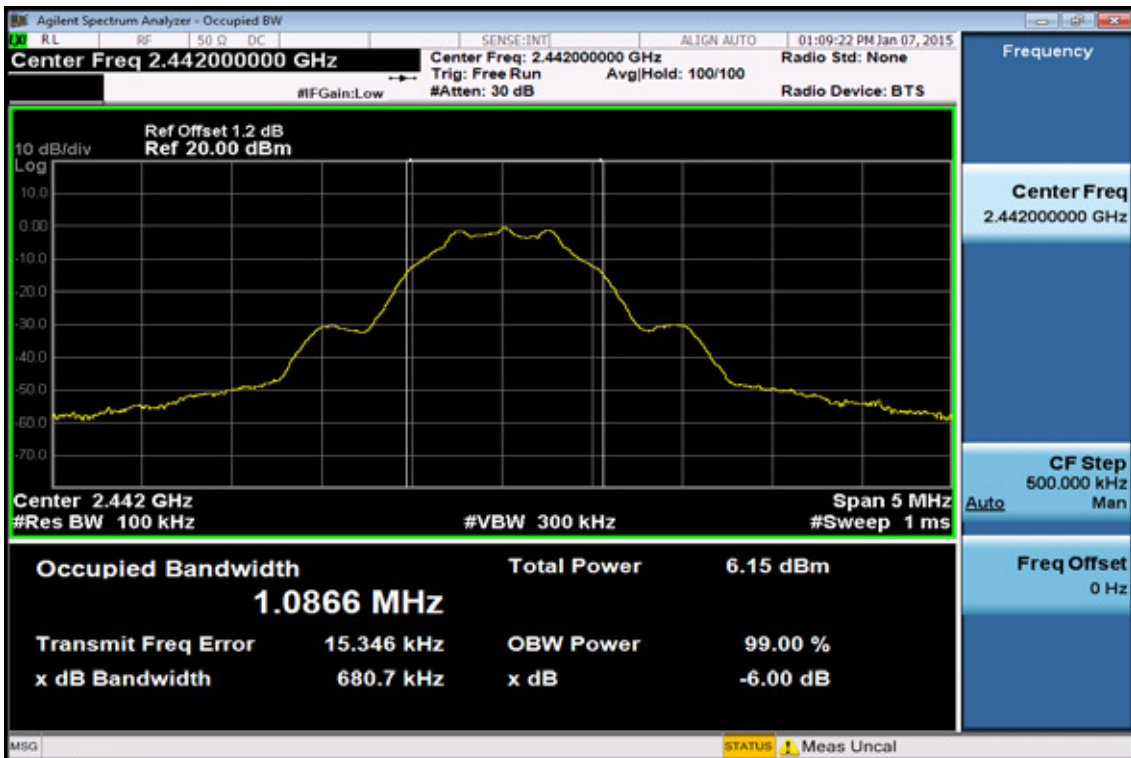

Unless otherwise stated the results shown in this test report refer only to the sample(s) tested and such sample(s) are retained for 90 days only.

除非另有說明，此報告結果僅對測試之樣品負責，同時此樣品僅保留 90 天。本報告未經本公司書面許可，不可部份複製。

This document is issued by the Company subject to its General Conditions of Service printed overleaf, available on request or accessible at www.sgs.com/terms_and_conditions.htm and, for electronic format documents, subject to Terms and Conditions for Electronic Documents at www.sgs.com/terms_e-document.htm. Attention is drawn to the limitation of liability, indemnification and jurisdiction issues defined therein. Any holder of this document is advised that information contained hereon reflects the Company's findings at the time of its intervention only and within the limits of Client's instructions, if any. The Company's sole responsibility is to its Client and this document does not exonerate parties to a transaction from exercising all their rights and obligations under the transaction documents. This document cannot be reproduced except in full, without prior written approval of the Company. Any unauthorized alteration, forgery or falsification of the content or appearance of this document is unlawful and offenders may be prosecuted to the fullest extent of the law.

6dB Band Width Test Data CH-High

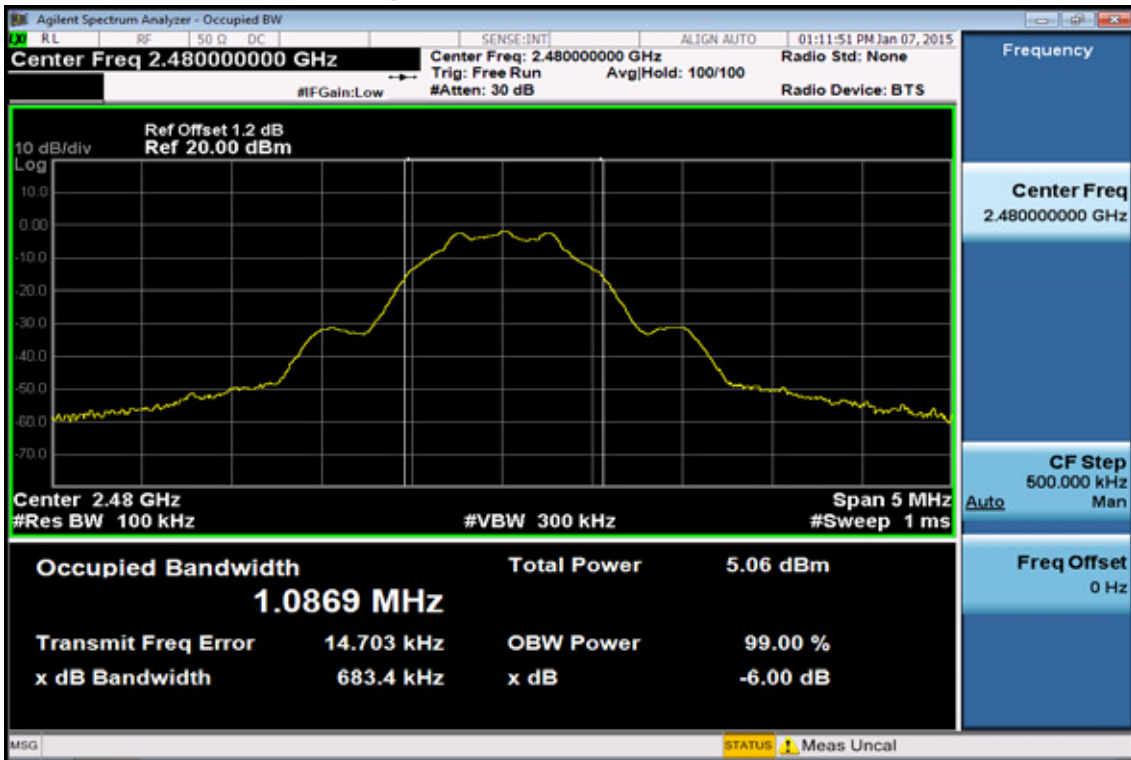

Unless otherwise stated the results shown in this test report refer only to the sample(s) tested and such sample(s) are retained for 90 days only. 除非另有說明，此報告結果僅對測試之樣品負責，同時此樣品僅保留 90 天。本報告未經本公司書面許可，不可部份複製。

This document is issued by the Company subject to its General Conditions of Service printed overleaf, available on request or accessible at www.sgs.com/terms_and_conditions.htm and, for electronic format documents, subject to Terms and Conditions for Electronic Documents at www.sgs.com/terms_e-document.htm. Attention is drawn to the limitation of liability, indemnification and jurisdiction issues defined therein. Any holder of this document is advised that information contained hereon reflects the Company's findings at the time of its intervention only and within the limits of Client's instructions, if any. The Company's sole responsibility is to its Client and this document does not exonerate parties to a transaction from exercising all their rights and obligations under the transaction documents. This document cannot be reproduced except in full, without prior written approval of the Company. Any unauthorized alteration, forgery or falsification of the content or appearance of this document is unlawful and offenders may be prosecuted to the fullest extent of the law.

9 BAND EDGES MEASUREMENT

9.1 Standard Applicable:

According to §15.247(c), in any 100 kHz bandwidth outside the frequency bands in which the spread spectrum intentional radiator is operating, the radio frequency power that is produced by the intentional radiator shall be at least 20dB below that in the 100kHz bandwidth within the band that contains the highest level of the desired power. In addition, radiated emissions which fall in the restricted bands, as defined in §15.205(a), must also comply with the radiated emission limits specified in 15.209(a).

9.2 Measurement Equipment Used:

9.2.1 Conducted Emission at antenna port:

Refer to section 7.2 for details.

9.2.2 Radiated emission:

966 Chamber					
EQUIPMENT TYPE	MFR	MODEL NUMBER	SERIAL NUMBER	LAST CAL.	CAL DUE.
EMI Test Receiver	R&S	ESC17	100760	05/26/2014	05/25/2015
Spectrum Analyzer	Agilent	E4446A	MY51100003	05/19/2014	05/18/2015
EXA Spectrum Analyzer	Agilent	N9010A	MY50420195	12/22/2014	12/21/2015
Spectrum Analyzer	R&S	FSV-30	101398	10/07/2014	10/06/2015
Loop Antenna	ETS.LINDGREN	6502	00148045	07/03/2014	07/02/2015
Bilog Antenna	SCHWAZBECK	VULB9168	378	12/23/2014	12/22/2015
Horn antenna	ETS.LINDGREN	3117	123995	05/19/2014	05/18/2015
Horn Antenna	Schwarzbeck	BBHA9170	184	01/23/2014	01/22/2015
Pre-Amplifier	Agilent	8447D	2944A07676	01/02/2015	01/01/2016
Pre-Amplifier	Agilent	8449B	3008A00578	01/02/2015	01/01/2016
Pre-Amplifier	EMC Instruments Corp.	EMC184045	980135	01/02/2015	01/01/2016
Filter 2400-2483.5 MHz	EWT	EWT-14-0166	M2	01/02/2015	01/01/2016
Attenuator	Mini-Circuit	BW-S10W2+	004	01/02/2015	01/01/2016
Turn Table	HD	DT420	N/A	N.C.R	N.C.R
Antenna Tower	HD	MA240-N	240/657	N.C.R	N.C.R
Controller	HD	HD100	N/A	N.C.R	N.C.R
Low Loss Cable	Huber Suhner	966_Rx	9	01/02/2015	01/01/2016
3m Site NSA	SGS	966 chamber	N/A	07/15/2014	07/14/2015

Note: N.C.R refers to Not Calibrated Required

Unless otherwise stated the results shown in this test report refer only to the sample(s) tested and such sample(s) are retained for 90 days only. 除非另有說明，此報告結果僅對測試之樣品負責，同時此樣品僅保留 90 天。本報告未經本公司書面許可，不可部份複製。

This document is issued by the Company subject to its General Conditions of Service printed overleaf, available on request or accessible at www.sgs.com/terms_and_conditions.htm and, for electronic format documents, subject to Terms and Conditions for Electronic Documents at www.sgs.com/terms_e-document.htm. Attention is drawn to the limitation of liability, indemnification and jurisdiction issues defined therein. Any holder of this document is advised that information contained hereon reflects the Company's findings at the time of its intervention only and within the limits of Client's instructions, if any. The Company's sole responsibility is to its Client and this document does not exonerate parties to a transaction from exercising all their rights and obligations under the transaction documents. This document cannot be reproduced except in full, without prior written approval of the Company. Any unauthorized alteration, forgery or falsification of the content or appearance of this document is unlawful and offenders may be prosecuted to the fullest extent of the law.

9.3 Test SET-UP:

9.3.1 Conducted Emission at antenna port:

Refer to section 8.3 for details.

9.3.2 Radiated emission:

(A) Radiated Emission Test Set-Up, Frequency Below 1000MHz

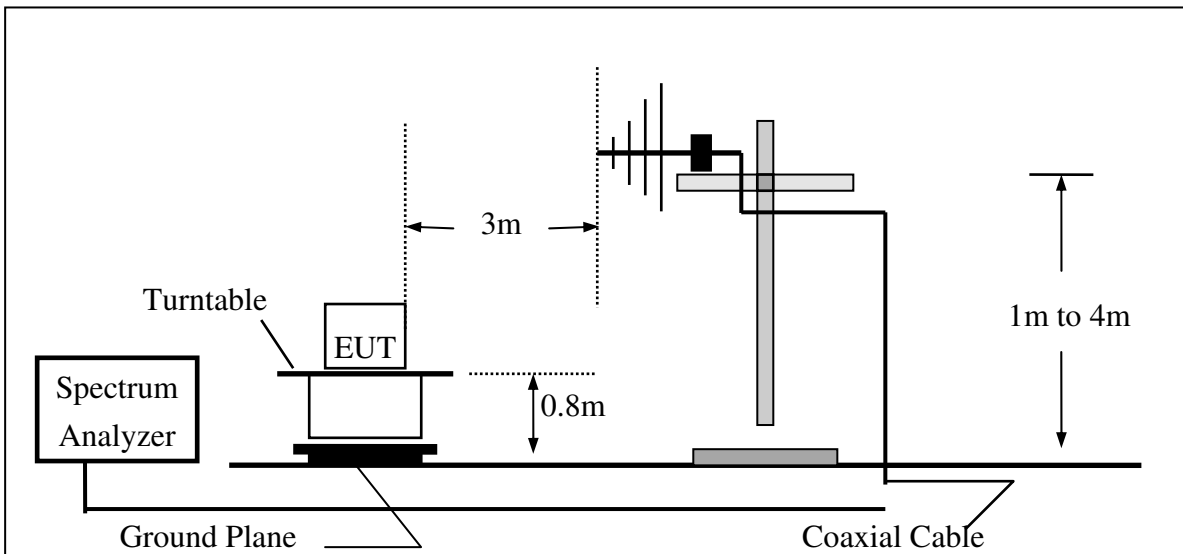

(B) Radiated Emission Test Set-UP Frequency Over 1 GHz

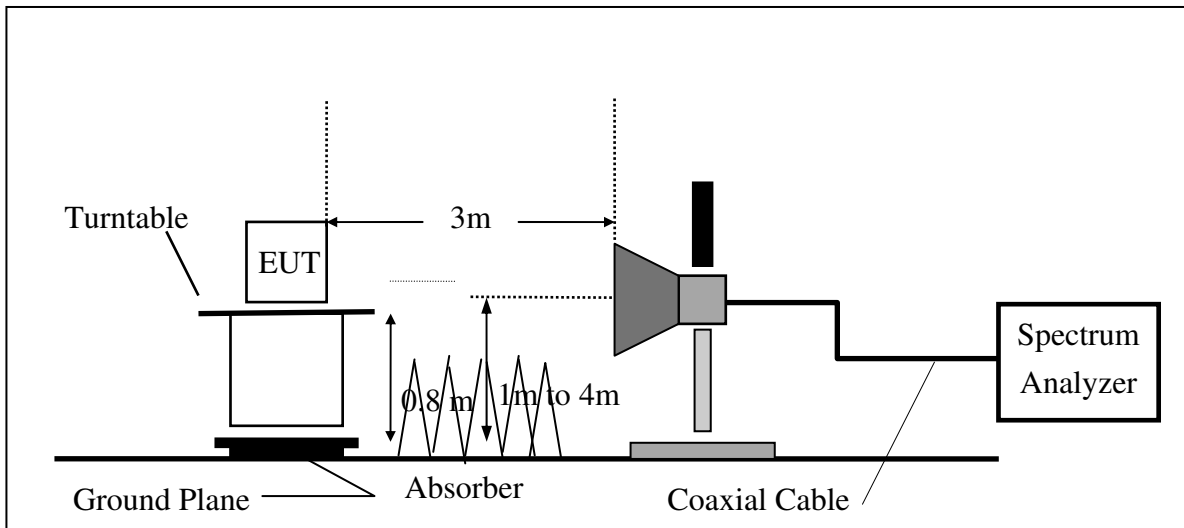

Unless otherwise stated the results shown in this test report refer only to the sample(s) tested and such sample(s) are retained for 90 days only. 除非另有說明，此報告結果僅對測試之樣品負責，同時此樣品僅保留 90 天。本報告未經本公司書面許可，不可部份複製。

This document is issued by the Company subject to its General Conditions of Service printed overleaf, available on request or accessible at www.sgs.com/terms_and_conditions.htm and, for electronic format documents, subject to Terms and Conditions for Electronic Documents at www.sgs.com/terms_e-document.htm. Attention is drawn to the limitation of liability, indemnification and jurisdiction issues defined therein. Any holder of this document is advised that information contained hereon reflects the Company's findings at the time of its intervention only and within the limits of Client's instructions, if any. The Company's sole responsibility is to its Client and this document does not exonerate parties to a transaction from exercising all their rights and obligations under the transaction documents. This document cannot be reproduced except in full, without prior written approval of the Company. Any unauthorized alteration, forgery or falsification of the content or appearance of this document is unlawful and offenders may be prosecuted to the fullest extent of the law.

9.4 Measurement Procedure:

Unwanted Emissions into Non-Restricted Frequency Bands, Measurement Procedure followed by 11.1 of KDB558074 D01

1. Place the EUT on the table and set it in transmitting mode.
2. Remove the antenna from the EUT and then connect a low loss RF cable from the antenna port to the spectrum analyzer.
3. Set start to edge frequency, and stop frequency of spectrum analyzer so as to encompass the spectrum to be examined.
4. Set the spectrum analyzer as RBW, VBW=300KHz, Detector = Peak, Sweep = auto
5. Mark the highest reading of the emission as the reference level measurement.
6. Set DL as the limit = reading on marker 1 – 20dBm
7. Marker on frequency, 2.3999GHz and 2.4836GHz, and examine shall 100 KHz immediately outside the authorized (2400~2483.5) be attenuated by 20dB at least relative to the maximum emission of power.
8. Repeat above procedures until all default test channel (low, middle, and high) was complete.

Unwanted Emission falling into Restricted Frequency Bands, Measurement Procedure followed by 12.1 of KDB558074 D01:

1. The EUT was placed on a turn table which is 0.8m above ground plane.
2. The turn table shall rotate 360 degrees to determine the position of maximum emission level.
3. EUT is set 3m away from the receiving antenna which varied from 1m to 4m to find out the highest emissions.
4. When measurement procedures for electric field radiated emissions above 1 GHz the EUT measurement is to be made “while keeping the antenna in the ‘cone of radiation’ from that area and pointed at the area both in azimuth and elevation, with polarization oriented for maximum response.” is still within the 3dB illumination BW of the measurement antenna.
5. Maximum procedure was performed on the six highest emissions to ensure EUT compliance.
6. And also, each emission was to be maximized by changing the polarization of receiving antenna both horizontal and vertical.
7. On spectrum, following 8.1.2, and RBW = 1MHz, VBW = 3MHz, & Marker 2390MHz, and 2483.5MHz (Peak Measurement). Average Measurement: following 8.2 with the modification span to 1MHz, & RBW = 1MHz, VBW = 3MHz and peak marker function to obtain the highest reading on 2390, and 2483.5MHz.

Repeat above procedures until all default test channel (low, middle, and high) was complete

Unless otherwise stated the results shown in this test report refer only to the sample(s) tested and such sample(s) are retained for 90 days only.
除非另有說明，此報告結果僅對測試之樣品負責，同時此樣品僅保留 90 天。本報告未經本公司書面許可，不可部份複製。

This document is issued by the Company subject to its General Conditions of Service printed overleaf, available on request or accessible at www.sgs.com/terms_and_conditions.htm and, for electronic format documents, subject to Terms and Conditions for Electronic Documents at www.sgs.com/terms_e-document.htm. Attention is drawn to the limitation of liability, indemnification and jurisdiction issues defined therein. Any holder of this document is advised that information contained hereon reflects the Company's findings at the time of its intervention only and within the limits of Client's instructions, if any. The Company's sole responsibility is to its Client and this document does not exonerate parties to a transaction from exercising all their rights and obligations under the transaction documents. This document cannot be reproduced except in full, without prior written approval of the Company. Any unauthorized alteration, forgery or falsification of the content or appearance of this document is unlawful and offenders may be prosecuted to the fullest extent of the law.



9.5 Field Strength Calculation:

The field strength is calculated by adding the Antenna Factor and Cable Factor and subtracting the Amplifier Gain and Duty Cycle Correction Factor (if any) from the measured reading. The basic equation with a sample calculation is as follows:

$$FS = RA + AF + CL - AG$$

Where	FS = Field Strength	CL = Cable Attenuation Factor (Cable Loss)
	RA = Reading Amplitude	AG = Amplifier Gain
	AF = Antenna Factor	

9.6 Measurement Result:

Note: Refer to next page spectrum analyzer data chart and tabular data sheets.

Unless otherwise stated the results shown in this test report refer only to the sample(s) tested and such sample(s) are retained for 90 days only.
除非另有說明，此報告結果僅對測試之樣品負責，同時此樣品僅保留 90 天。本報告未經本公司書面許可，不可部份複製。

This document is issued by the Company subject to its General Conditions of Service printed overleaf, available on request or accessible at www.sgs.com/terms_and_conditions.htm and, for electronic format documents, subject to Terms and Conditions for Electronic Documents at www.sgs.com/terms_e-document.htm. Attention is drawn to the limitation of liability, indemnification and jurisdiction issues defined therein. Any holder of this document is advised that information contained hereon reflects the Company's findings at the time of its intervention only and within the limits of Client's instructions, if any. The Company's sole responsibility is to its Client and this document does not exonerate parties to a transaction from exercising all their rights and obligations under the transaction documents. This document cannot be reproduced except in full, without prior written approval of the Company. Any unauthorized alteration, forgery or falsification of the content or appearance of this document is unlawful and offenders may be prosecuted to the fullest extent of the law.

BT4.0 mode Band Edges Test Data CH-Low

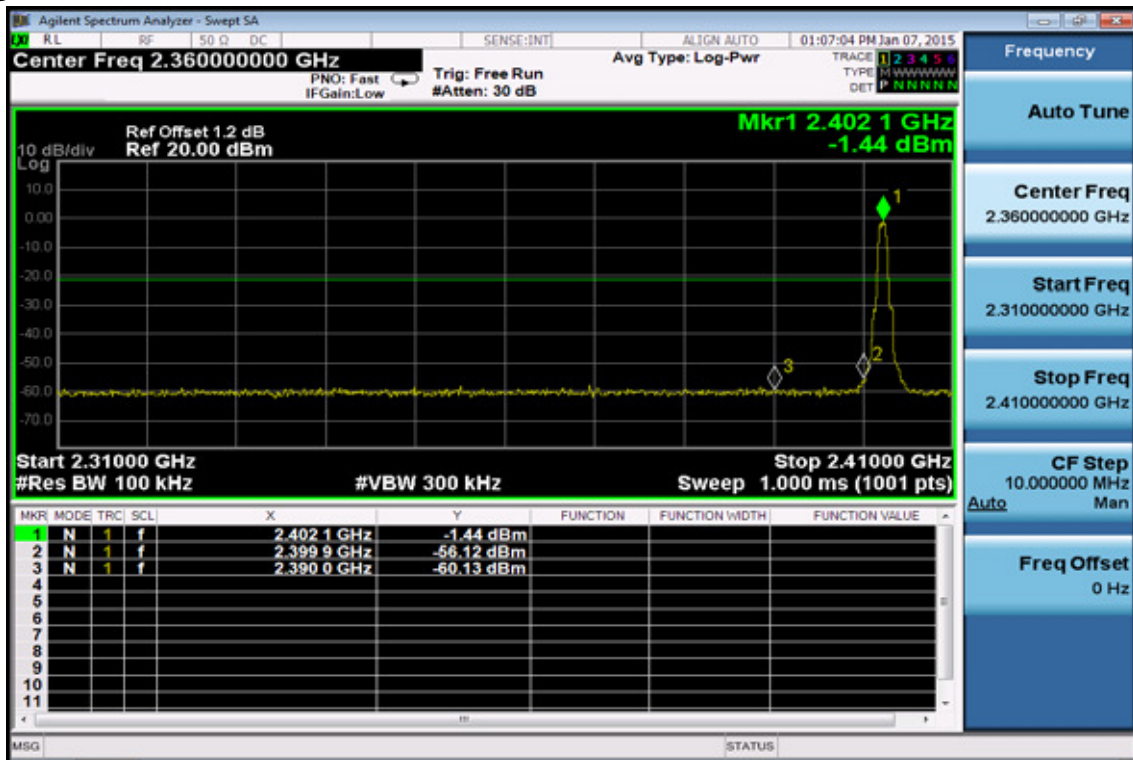

Band Edges Test Data CH-High

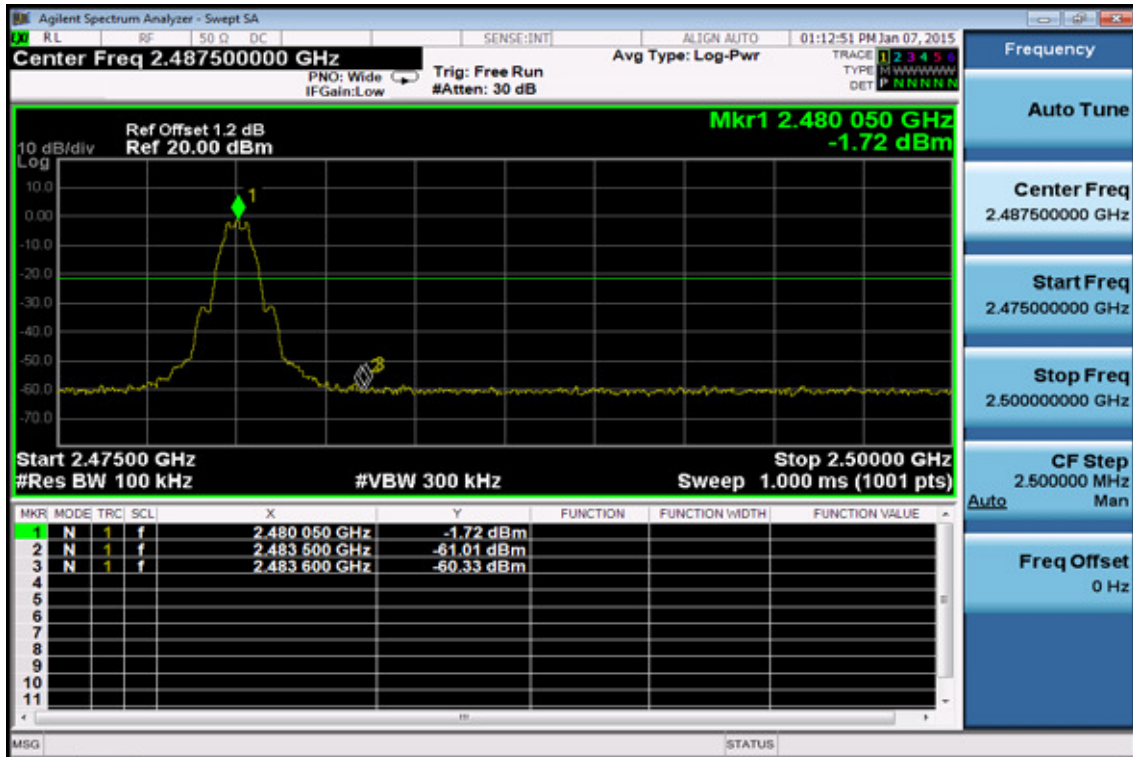

Unless otherwise stated the results shown in this test report refer only to the sample(s) tested and such sample(s) are retained for 90 days only.

除非另有說明，此報告結果僅對測試之樣品負責，同時此樣品僅保留 90 天。本報告未經本公司書面許可，不可部份複製。

This document is issued by the Company subject to its General Conditions of Service printed overleaf, available on request or accessible at www.sgs.com/terms_and_conditions.htm and, for electronic format documents, subject to Terms and Conditions for Electronic Documents at www.sgs.com/terms_e-document.htm. Attention is drawn to the limitation of liability, indemnification and jurisdiction issues defined therein. Any holder of this document is advised that information contained hereon reflects the Company's findings at the time of its intervention only and within the limits of Client's instructions, if any. The Company's sole responsibility is to its Client and this document does not exonerate parties to a transaction from exercising all their rights and obligations under the transaction documents. This document cannot be reproduced except in full, without prior written approval of the Company. Any unauthorized alteration, forgery or falsification of the content or appearance of this document is unlawful and offenders may be prosecuted to the fullest extent of the law.

Radiated Emission: BT4.0 mode

Operation Band	:BT 4.0	Test Date	:2015-01-19
Fundamental Frequency	:2402 MHz	Temp./Humi.	:23 deg_C / 63 RH
Operation Mode	:Band Edge LOW	Engineer	:Curry
EUT Pol.	:H Plane	Measurement Antenna Pol.	:VERTICAL

Freq.	Note	Detector Mode	Spectrum Reading Level	Factor	Actual FS	Limit @3m	Margin
MHz	F/H/E/S	PK/QP/AV	dBµV	dB	dBµV/ m	dBµV/ m	dB
2390.00	E	Average	30.36	2.48	32.84	54.00	-21.16
2390.00	E	Peak	44.40	2.48	46.88	74.00	-27.12

Operation Band	:BT 4.0	Test Date	:2015-01-19
Fundamental Frequency	:2402 MHz	Temp./Humi.	:23 deg_C / 63 RH
Operation Mode	:Band Edge LOW	Engineer	:Curry
EUT Pol.	:H Plane	Measurement Antenna Pol.	:HORIZONTAL

Freq.	Note	Detector Mode	Spectrum Reading Level	Factor	Actual FS	Limit @3m	Margin
MHz	F/H/E/S	PK/QP/AV	dBµV	dB	dBµV/ m	dBµV/ m	dB
2390.00	E	Average	30.30	2.48	32.78	54.00	-21.22
2390.00	E	Peak	44.13	2.48	46.61	74.00	-27.39

Actual FS(dBµ V/m) = SPA. Reading level(dBµ V) + Factor(dB)

Factor(dB) = Antenna Factor(dBµ V/m) + Cable Loss(dB) – Pre_Amplifier Gain(dB)

Note : “F” : denotes Fundamental Frequency. ; “H” : denotes Harmonic Frequency.

“E” : denotes Band Edge Frequency. ; “S” : denotes Spurious Frequency.

“---“ : denotes Noise Floor.

The trace on RE (radiation emission) plot is as colored blue, and the detection manner we’ve employed is peak detector.

Unless otherwise stated the results shown in this test report refer only to the sample(s) tested and such sample(s) are retained for 90 days only. 除非另有說明，此報告結果僅對測試之樣品負責，同時此樣品僅保留 90 天。本報告未經本公司書面許可，不可部份複製。

This document is issued by the Company subject to its General Conditions of Service printed overleaf, available on request or accessible at www.sgs.com/terms_and_conditions.htm and, for electronic format documents, subject to Terms and Conditions for Electronic Documents at www.sgs.com/terms_e-document.htm. Attention is drawn to the limitation of liability, indemnification and jurisdiction issues defined therein. Any holder of this document is advised that information contained hereon reflects the Company’s findings at the time of its intervention only and within the limits of Client’s instructions, if any. The Company’s sole responsibility is to its Client and this document does not exonerate parties to a transaction from exercising all their rights and obligations under the transaction documents. This document cannot be reproduced except in full, without prior written approval of the Company. Any unauthorized alteration, forgery or falsification of the content or appearance of this document is unlawful and offenders may be prosecuted to the fullest extent of the law.

Operation Band	:BT 4.0	Test Date	:2015-01-19
Fundamental Frequency	:2480 MHz	Temp./Humi.	:23 deg_C / 63 RH
Operation Mode	:Band Edge HIGH	Engineer	:Curry
EUT Pol.	:H Plane	Measurement Antenna Pol.	:VERTICAL

Freq.	Note	Detector Mode	Spectrum Reading Level	Factor	Actual FS	Limit @3m	Margin
MHz	F/H/E/S	PK/QP/AV	dBμV	dB	dBμV/ m	dBμV/ m	dB
2483.50	E	Average	30.36	2.84	33.20	54.00	-20.80
2483.50	E	Peak	44.16	2.84	47.00	74.00	-27.00

Operation Band	:BT 4.0	Test Date	:2015-01-19
Fundamental Frequency	:2480 MHz	Temp./Humi.	:23 deg_C / 63 RH
Operation Mode	:Band Edge HIGH	Engineer	:Curry
EUT Pol.	:H Plane	Measurement Antenna Pol.	:HORIZONTAL

Freq.	Note	Detector Mode	Spectrum Reading Level	Factor	Actual FS	Limit @3m	Margin
MHz	F/H/E/S	PK/QP/AV	dBμV	dB	dBμV/ m	dBμV/ m	dB
2483.50	E	Average	30.87	2.84	33.71	54.00	-20.29
2483.50	E	Peak	47.39	2.84	50.23	74.00	-23.77

Actual FS(dBμV/m) = SPA. Reading level(dBμV) + Factor(dB)

Factor(dB) = Antenna Factor(dBμV/m) + Cable Loss(dB) – Pre_Amplifier Gain(dB)

Note : “F” : denotes Fundamental Frequency. ; “H” : denotes Harmonic Frequency.

“E” : denotes Band Edge Frequency. ; “S” : denotes Spurious Frequency.

“---“ : denotes Noise Floor.

The trace on RE (radiation emission) plot is as colored blue, and the detection manner we’ve employed is peak detector.

Unless otherwise stated the results shown in this test report refer only to the sample(s) tested and such sample(s) are retained for 90 days only. 除非另有說明，此報告結果僅對測試之樣品負責，同時此樣品僅保留 90 天。本報告未經本公司書面許可，不可部份複製。

This document is issued by the Company subject to its General Conditions of Service printed overleaf, available on request or accessible at www.sgs.com/terms_and_conditions.htm and, for electronic format documents, subject to Terms and Conditions for Electronic Documents at www.sgs.com/terms_e-document.htm. Attention is drawn to the limitation of liability, indemnification and jurisdiction issues defined therein. Any holder of this document is advised that information contained hereon reflects the Company’s findings at the time of its intervention only and within the limits of Client’s instructions, if any. The Company’s sole responsibility is to its Client and this document does not exonerate parties to a transaction from exercising all their rights and obligations under the transaction documents. This document cannot be reproduced except in full, without prior written approval of the Company. Any unauthorized alteration, forgery or falsification of the content or appearance of this document is unlawful and offenders may be prosecuted to the fullest extent of the law.

10 SPURIOUS RADIATED EMISSION TEST

10.1 Standard Applicable

According to §15.247(d),

Emission at antenna port:

In any 100 kHz bandwidth outside the frequency band in which the spread spectrum or digitally modulated intentional radiator is operating, the radio frequency power that is produced by the intentional radiator shall be at least 20 dB below that in the 100 kHz bandwidth within the band that contains the highest level of the desired power, based on either an RF conducted or a radiated measurement, provided the transmitter demonstrates compliance with the peak conducted power limits. If the transmitter complies with the conducted power limits based on the use of RMS averaging over a time interval, as permitted under paragraph (b)(3) of this section, the attenuation required under this paragraph shall be 30 dB instead of 20 dB.

Radiated Spurious Emission

Attenuation below the general limits specified in § 15.209(a) is not required. In addition, radiated emissions which fall in the restricted bands, as defined in § 15.205(a), must also comply with the radiated emission limits specified in § 15.209(a) (see § 15.205(c)).

And according to §15.33(a) (1), for an intentional radiator operates below 10GHz, the frequency range of measurements: to the tenth harmonic of the highest fundamental frequency or to 40GHz, whichever is lower.

10.2 Measurement Equipment Used:

10.2.1 Conducted Emission at antenna port:

Refer to section 7.2 for details.

10.2.2 Radiated emission:

Refer to section 9.2.2 for details.

10.3 Test SET-UP:

10.3.1 Conducted Emission at antenna port:

Refer to section 8.3 for details.

10.3.2 Radiated emission:

Refer to section 9.3.2 for details.

Unless otherwise stated the results shown in this test report refer only to the sample(s) tested and such sample(s) are retained for 90 days only. 除非另有說明，此報告結果僅對測試之樣品負責，同時此樣品僅保留 90 天。本報告未經本公司書面許可，不可部份複製。

This document is issued by the Company subject to its General Conditions of Service printed overleaf, available on request or accessible at www.sgs.com/terms_and_conditions.htm and, for electronic format documents, subject to Terms and Conditions for Electronic Documents at www.sgs.com/terms_e-document.htm. Attention is drawn to the limitation of liability, indemnification and jurisdiction issues defined therein. Any holder of this document is advised that information contained hereon reflects the Company's findings at the time of its intervention only and within the limits of Client's instructions, if any. The Company's sole responsibility is to its Client and this document does not exonerate parties to a transaction from exercising all their rights and obligations under the transaction documents. This document cannot be reproduced except in full, without prior written approval of the Company. Any unauthorized alteration, forgery or falsification of the content or appearance of this document is unlawful and offenders may be prosecuted to the fullest extent of the law.

10.4 Measurement Procedure:

Radiated Emission:

1. The EUT was placed on a turn table which is 0.8m above ground plane.
2. The turn table shall rotate 360 degrees to determine the position of maximum emission level.
3. EUT is set 3m away from the receiving antenna which varied from 1m to 4m to find out the highest emissions.
4. When measurement procedures for electric field radiated emissions above 1 GHz the EUT measurement is to be made “while keeping the antenna in the ‘cone of radiation’ from that area and pointed at the area both in azimuth and elevation, with polarization oriented for maximum response.” is still within the 3dB illumination BW of the measurement antenna.
5. Maximum procedure was performed on the six highest emissions to ensure EUT compliance.
6. And also, each emission was to be maximized by changing the polarization of receiving antenna both horizontal and vertical. On spectrum, change spectrum mode in linear display mode, and reduce VBW = 10Hz if average reading is measured.
7. Repeat above procedures until all frequency measured were complete.

Conducted Emission:

1. To connect Antenna Port of EUT to Spectrum.
2. Set RBW = 100K & VBW = 300K on Spectrum.
3. Sweep the frequency to determine spurious emission as seen on spectrum from span of 30 to 3G, 3G to 8G, 8G to 13G, 13G to 18G and 18G to 26.5GHz
4. Via Software, combine 5 spans of frequency range into one plot
5. Repeat above procedures until all default test channel measured were complete.

10.5 Field Strength Calculation

The field strength is calculated by adding the Antenna Factor and Cable Factor and subtracting the Amplifier Gain and Duty Cycle Correction Factor (if any) from the measured reading. The basic equation with a sample calculation is as follows:

$$FS = RA + AF + CL - AG$$

Where	FS = Field Strength	CL = Cable Attenuation Factor (Cable Loss)
	RA = Reading Amplitude	AG = Amplifier Gain
	AF = Antenna Factor	

10.6 Measurement Result:

Note: Refer to next page spectrum analyzer data chart and tabular data sheets.

Unless otherwise stated the results shown in this test report refer only to the sample(s) tested and such sample(s) are retained for 90 days only. 除非另有說明，此報告結果僅對測試之樣品負責，同時此樣品僅保留 90 天。本報告未經本公司書面許可，不可部份複製。

This document is issued by the Company subject to its General Conditions of Service printed overleaf, available on request or accessible at www.sgs.com/terms_and_conditions.htm and, for electronic format documents, subject to Terms and Conditions for Electronic Documents at www.sgs.com/terms_e-document.htm. Attention is drawn to the limitation of liability, indemnification and jurisdiction issues defined therein. Any holder of this document is advised that information contained hereon reflects the Company's findings at the time of its intervention only and within the limits of Client's instructions, if any. The Company's sole responsibility is to its Client and this document does not exonerate parties to a transaction from exercising all their rights and obligations under the transaction documents. This document cannot be reproduced except in full, without prior written approval of the Company. Any unauthorized alteration, forgery or falsification of the content or appearance of this document is unlawful and offenders may be prosecuted to the fullest extent of the law.

Conducted Spurious Emission Measurement Result (BT4.0 mode) Ch Low 30MHz – 3GHz

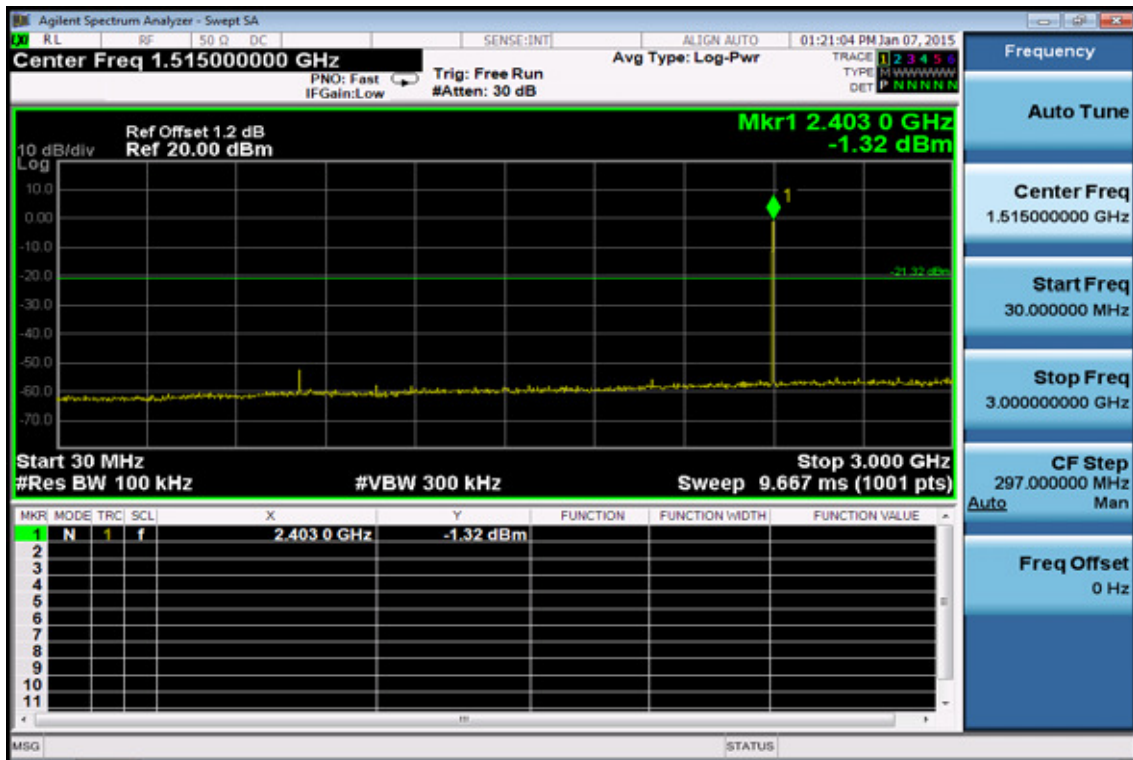

Ch Low 3GHz – 26.5GHz

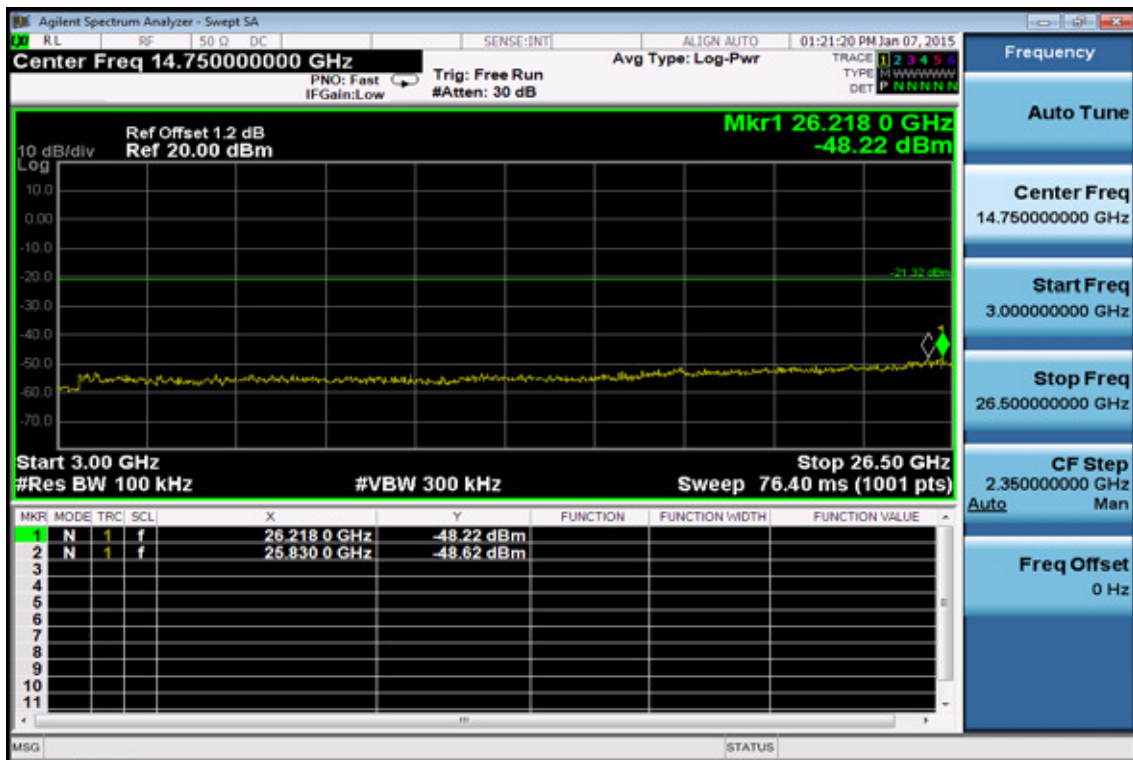

Unless otherwise stated the results shown in this test report refer only to the sample(s) tested and such sample(s) are retained for 90 days only.

除非另有說明，此報告結果僅對測試之樣品負責，同時此樣品僅保留 90 天。本報告未經本公司書面許可，不可部份複製。

This document is issued by the Company subject to its General Conditions of Service printed overleaf, available on request or accessible at www.sgs.com/terms_and_conditions.htm and, for electronic format documents, subject to Terms and Conditions for Electronic Documents at www.sgs.com/terms_e-document.htm. Attention is drawn to the limitation of liability, indemnification and jurisdiction issues defined therein. Any holder of this document is advised that information contained hereon reflects the Company's findings at the time of its intervention only and within the limits of Client's instructions, if any. The Company's sole responsibility is to its Client and this document does not exonerate parties to a transaction from exercising all their rights and obligations under the transaction documents. This document cannot be reproduced except in full, without prior written approval of the Company. Any unauthorized alteration, forgery or falsification of the content or appearance of this document is unlawful and offenders may be prosecuted to the fullest extent of the law.

Ch Mid 30MHz – 3GHz

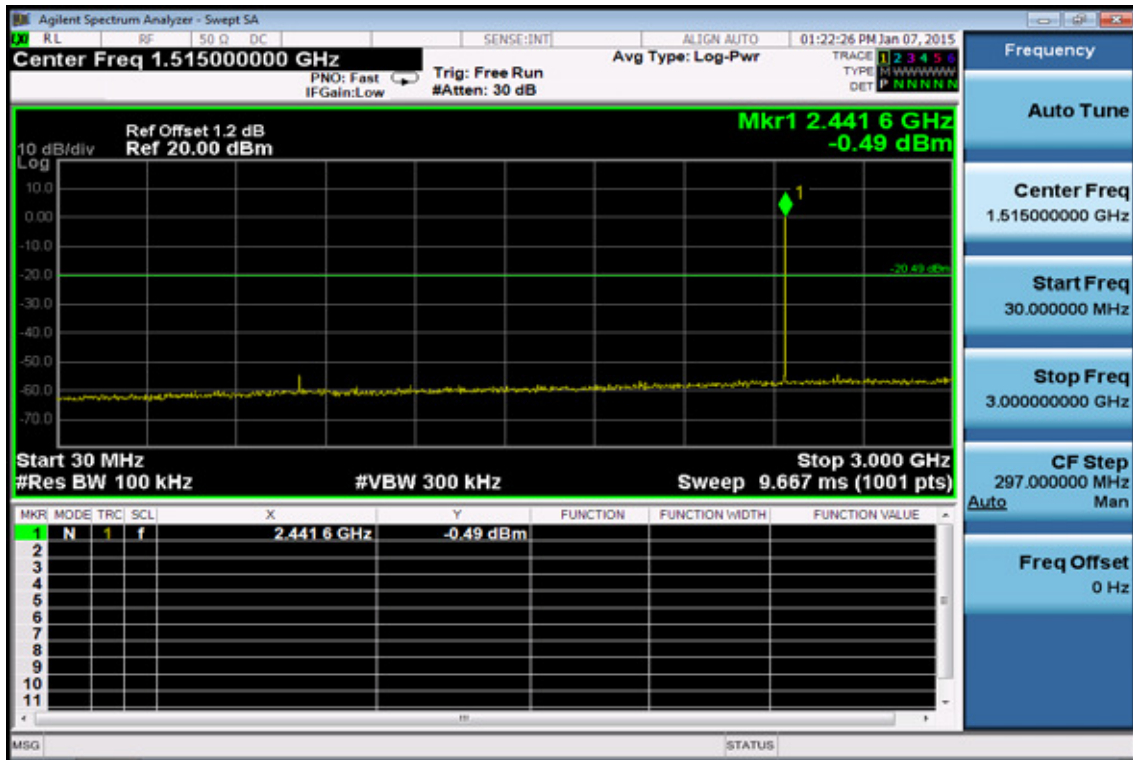

Ch Mid 3GHz – 26.5GHz

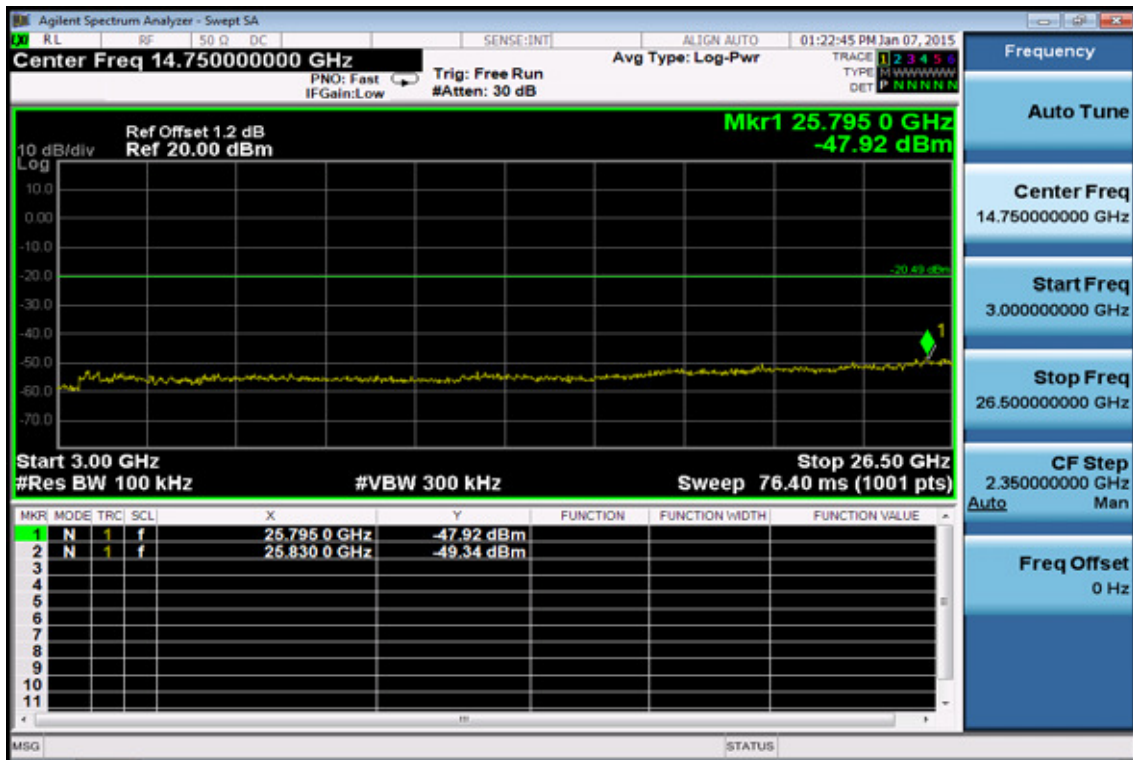

Unless otherwise stated the results shown in this test report refer only to the sample(s) tested and such sample(s) are retained for 90 days only.

除非另有說明，此報告結果僅對測試之樣品負責，同時此樣品僅保留 90 天。本報告未經本公司書面許可，不可部份複製。

This document is issued by the Company subject to its General Conditions of Service printed overleaf, available on request or accessible at www.sgs.com/terms_and_conditions.htm and, for electronic format documents, subject to Terms and Conditions for Electronic Documents at www.sgs.com/terms_e-document.htm. Attention is drawn to the limitation of liability, indemnification and jurisdiction issues defined therein. Any holder of this document is advised that information contained hereon reflects the Company's findings at the time of its intervention only and within the limits of Client's instructions, if any. The Company's sole responsibility is to its Client and this document does not exonerate parties to a transaction from exercising all their rights and obligations under the transaction documents. This document cannot be reproduced except in full, without prior written approval of the Company. Any unauthorized alteration, forgery or falsification of the content or appearance of this document is unlawful and offenders may be prosecuted to the fullest extent of the law.

Ch High 30MHz – 3GHz

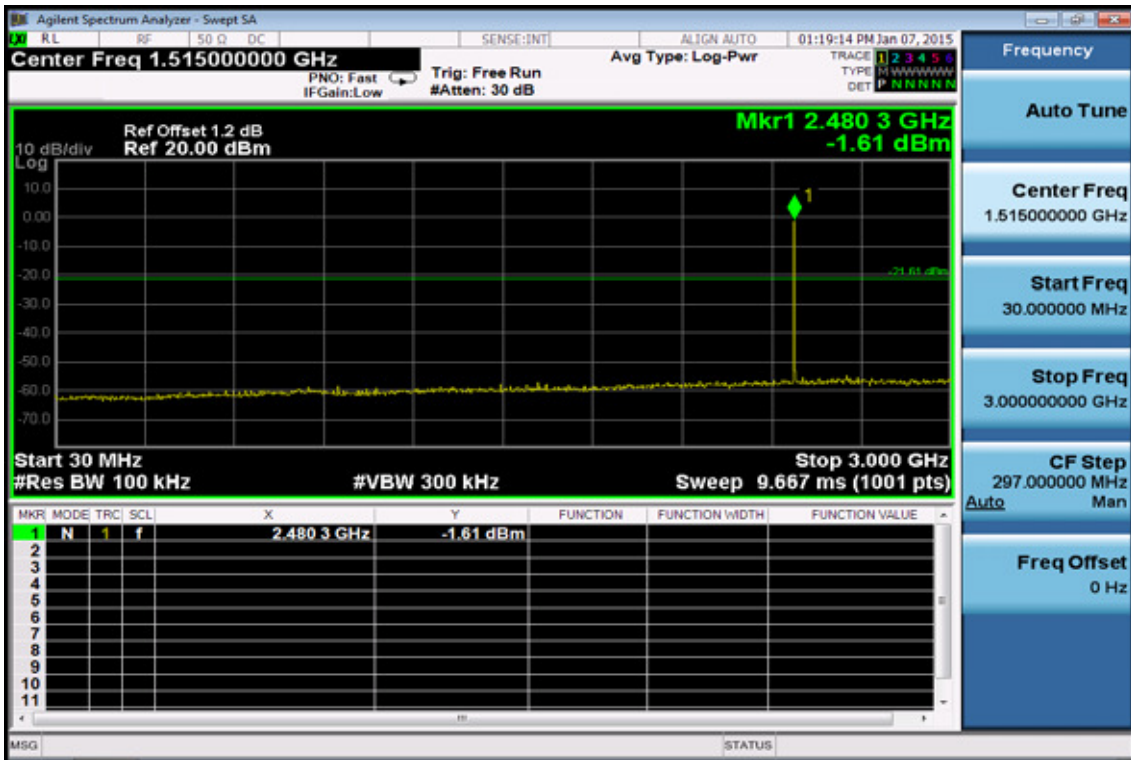

Ch High 3GHz – 26.5GHz

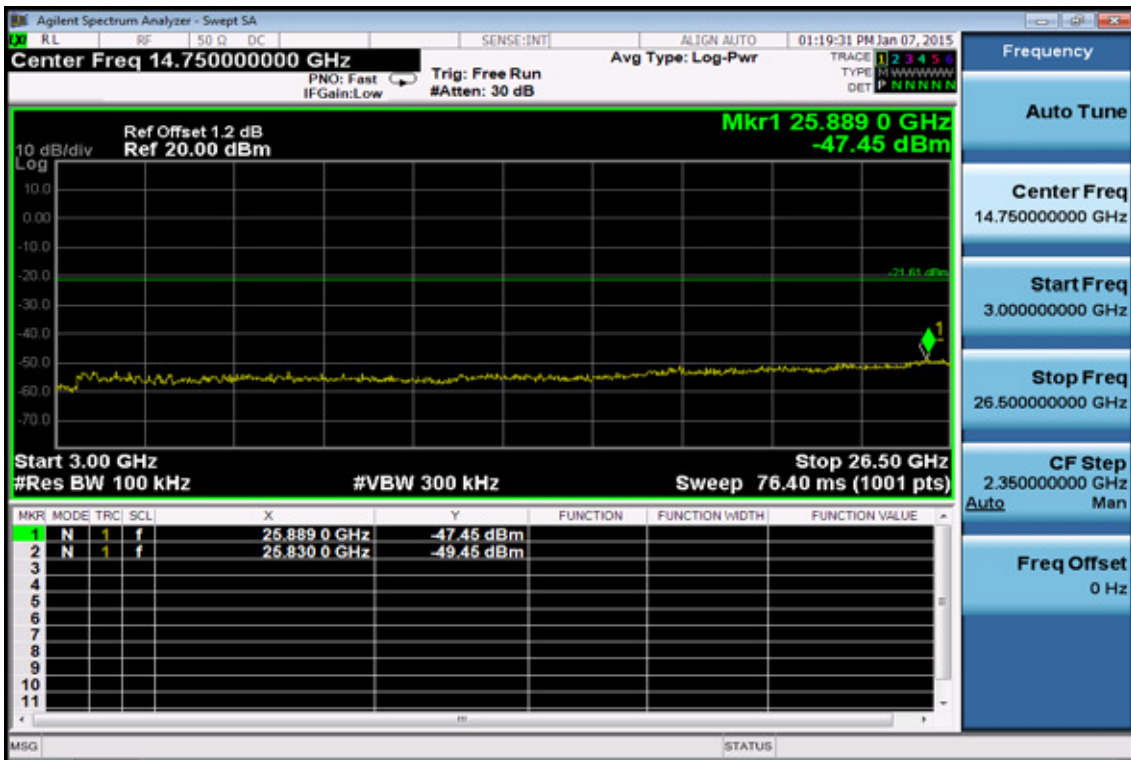

Unless otherwise stated the results shown in this test report refer only to the sample(s) tested and such sample(s) are retained for 90 days only.

除非另有說明，此報告結果僅對測試之樣品負責，同時此樣品僅保留 90 天。本報告未經本公司書面許可，不可部份複製。

This document is issued by the Company subject to its General Conditions of Service printed overleaf, available on request or accessible at www.sgs.com/terms_and_conditions.htm and, for electronic format documents, subject to Terms and Conditions for Electronic Documents at www.sgs.com/terms_e-document.htm. Attention is drawn to the limitation of liability, indemnification and jurisdiction issues defined therein. Any holder of this document is advised that information contained hereon reflects the Company's findings at the time of its intervention only and within the limits of Client's instructions, if any. The Company's sole responsibility is to its Client and this document does not exonerate parties to a transaction from exercising all their rights and obligations under the transaction documents. This document cannot be reproduced except in full, without prior written approval of the Company. Any unauthorized alteration, forgery or falsification of the content or appearance of this document is unlawful and offenders may be prosecuted to the fullest extent of the law.

Radiated Spurious Emission Measurement Result (BT4.0 mode)

Operation Band	:BT4.0	Test Date	:2015-01-19
Fundamental Frequency	:2402 MHz	Temp./Humi.	:23 deg_C / 63 RH
Operation Mode	:TX LOW	Engineer	:Curry
EUT Pol.	:H Plane	Measurement Antenna Pol.	:VERTICAL

Actual FS(dB μ V/ m) = SPA. Reading level(dB μ V) + Factor(dB)

Factor(dB) = Antenna Factor(dB μ V/ m) + Cable Loss(dB) – Pre_Amplifier Gain(dB)

Note : “F” : denotes Fundamental Frequency. ; “H” : denotes Harmonic Frequency.

“E” : denotes Band Edge Frequency. ; “S” : denotes Spurious Frequency.

“---” : denotes Noise Floor.

Freq. MHz	Note F/H/E/S	Detector Mode PK/QP/AV	Spectrum Reading Level dB μ V	Factor dB	Actual FS dB μ V/ m	Limit @3m dB μ V/ m	Margin dB
41.64	S	Peak	36.87	-13.42	23.45	40.00	-16.55
99.84	S	Peak	39.75	-17.96	21.79	43.50	-21.71
286.08	S	Peak	27.86	-11.51	16.35	46.00	-29.65
505.30	S	Peak	28.39	-7.37	21.02	46.00	-24.98
701.24	S	Peak	29.11	-4.00	25.11	46.00	-20.89
923.37	S	Peak	28.48	-0.20	28.28	46.00	-17.72
4804.00	H	Average	25.08	6.75	31.83	54.00	-22.17
4804.00	H	Peak	37.34	6.75	44.09	74.00	-29.91
7206.00	H	---					
9608.00	H	---					
12010.00	H	---					
14412.00	H	---					
16814.00	H	---					
19216.00	H	---					
21618.00	H	---					
24020.00	H	---					

Unless otherwise stated the results shown in this test report refer only to the sample(s) tested and such sample(s) are retained for 90 days only. 除非另有說明，此報告結果僅對測試之樣品負責，同時此樣品僅保留 90 天。本報告未經本公司書面許可，不可部份複製。

This document is issued by the Company subject to its General Conditions of Service printed overleaf, available on request or accessible at www.sgs.com/terms_and_conditions.htm and, for electronic format documents, subject to Terms and Conditions for Electronic Documents at www.sgs.com/terms_e-document.htm. Attention is drawn to the limitation of liability, indemnification and jurisdiction issues defined therein. Any holder of this document is advised that information contained hereon reflects the Company's findings at the time of its intervention only and within the limits of Client's instructions, if any. The Company's sole responsibility is to its Client and this document does not exonerate parties to a transaction from exercising all their rights and obligations under the transaction documents. This document cannot be reproduced except in full, without prior written approval of the Company. Any unauthorized alteration, forgery or falsification of the content or appearance of this document is unlawful and offenders may be prosecuted to the fullest extent of the law.

Operation Band	:BT4.0	Test Date	:2015-01-19
Fundamental Frequency	:2402 MHz	Temp./Humi.	:23 deg_C / 63 RH
Operation Mode	:TX LOW	Engineer	:Curry
EUT Pol.	:H Plane	Measurement Antenna Pol.	:HORIZONTAL

Actual FS(dB μ V/ m) = SPA. Reading level(dB μ V) + Factor(dB)

Factor(dB) = Antenna Factor(dB μ V/ m) + Cable Loss(dB) – Pre_Amplifier Gain(dB)

Note : “F” : denotes Fundamental Frequency. ; “H” : denotes Harmonic Frequency.

“E” : denotes Band Edge Frequency. ; “S” : denotes Spurious Frequency.

“---” : denotes Noise Floor.

Freq. MHz	Note F/H/E/S	Detector Mode PK/QP/AV	Spectrum Reading Level dB μ V	Factor dB	Actual FS dB μ V/ m	Limit @3m dB μ V/ m	Margin dB
160.95	S	Peak	27.02	-12.39	14.63	43.50	-28.87
307.42	S	Peak	28.14	-10.97	17.17	46.00	-28.83
463.59	S	Peak	28.89	-7.85	21.04	46.00	-24.96
676.99	S	Peak	28.25	-3.77	24.48	46.00	-21.52
753.62	S	Peak	28.73	-2.49	26.24	46.00	-19.76
923.37	S	Peak	28.14	-0.20	27.94	46.00	-18.06
4804.00	H	Average	25.02	6.75	31.77	54.00	-22.23
4804.00	H	Peak	37.28	6.75	44.03	74.00	-29.97
7206.00	H	---					
9608.00	H	---					
12010.00	H	---					
14412.00	H	---					
16814.00	H	---					
19216.00	H	---					
21618.00	H	---					
24020.00	H	---					

Unless otherwise stated the results shown in this test report refer only to the sample(s) tested and such sample(s) are retained for 90 days only.
除非另有說明，此報告結果僅對測試之樣品負責，同時此樣品僅保留 90 天。本報告未經本公司書面許可，不可部份複製。

This document is issued by the Company subject to its General Conditions of Service printed overleaf, available on request or accessible at www.sgs.com/terms_and_conditions.htm and, for electronic format documents, subject to Terms and Conditions for Electronic Documents at www.sgs.com/terms_e-document.htm. Attention is drawn to the limitation of liability, indemnification and jurisdiction issues defined therein. Any holder of this document is advised that information contained hereon reflects the Company's findings at the time of its intervention only and within the limits of Client's instructions, if any. The Company's sole responsibility is to its Client and this document does not exonerate parties to a transaction from exercising all their rights and obligations under the transaction documents. This document cannot be reproduced except in full, without prior written approval of the Company. Any unauthorized alteration, forgery or falsification of the content or appearance of this document is unlawful and offenders may be prosecuted to the fullest extent of the law.

Radiated Spurious Emission Measurement Result

Operation Band	:BT4.0	Test Date	:2015-01-19
Fundamental Frequency	:2442 MHz	Temp./Humi.	:23 deg_C / 63 RH
Operation Mode	:TX MID	Engineer	:Curry
EUT Pol.	:H Plane	Measurement Antenna Pol.	:VERTICAL

Actual FS(dBμV/ m) = SPA. Reading level(dBμV) + Factor(dB)

Factor(dB) = Antenna Factor(dBμV/ m) + Cable Loss(dB) – Pre_Amplifier Gain(dB)

Note : “F” : denotes Fundamental Frequency. ; “H” : denotes Harmonic Frequency.

“E” : denotes Band Edge Frequency. ; “S” : denotes Spurious Frequency.

“---” : denotes Noise Floor.

Freq. MHz	Note F/H/E/S	Detector Mode PK/QP/AV	Spectrum Reading Level dBμV	Factor dB	Actual FS dBμV/ m	Limit @3m dBμV/ m	Margin dB
41.64	S	Peak	37.06	-13.42	23.64	40.00	-16.36
99.84	S	Peak	39.15	-17.96	21.19	43.50	-22.31
286.08	S	Peak	28.27	-11.51	16.76	46.00	-29.24
486.87	S	Peak	27.98	-7.58	20.40	46.00	-25.60
682.81	S	Peak	28.44	-3.63	24.81	46.00	-21.19
936.95	S	Peak	27.80	0.08	27.88	46.00	-18.12
4884.00	H	Average	24.93	6.94	31.87	54.00	-22.13
4884.00	H	Peak	37.97	6.94	44.91	74.00	-29.09
7326.00	H	---					
9768.00	H	---					
12210.00	H	---					
14652.00	H	---					
17094.00	H	---					
19536.00	H	---					
21978.00	H	---					
24420.00	H	---					

Unless otherwise stated the results shown in this test report refer only to the sample(s) tested and such sample(s) are retained for 90 days only. 除非另有說明，此報告結果僅對測試之樣品負責，同時此樣品僅保留 90 天。本報告未經本公司書面許可，不可部份複製。

This document is issued by the Company subject to its General Conditions of Service printed overleaf, available on request or accessible at www.sgs.com/terms_and_conditions.htm and, for electronic format documents, subject to Terms and Conditions for Electronic Documents at www.sgs.com/terms_e-document.htm. Attention is drawn to the limitation of liability, indemnification and jurisdiction issues defined therein. Any holder of this document is advised that information contained hereon reflects the Company's findings at the time of its intervention only and within the limits of Client's instructions, if any. The Company's sole responsibility is to its Client and this document does not exonerate parties to a transaction from exercising all their rights and obligations under the transaction documents. This document cannot be reproduced except in full, without prior written approval of the Company. Any unauthorized alteration, forgery or falsification of the content or appearance of this document is unlawful and offenders may be prosecuted to the fullest extent of the law.

Operation Band	:BT4.0	Test Date	:2015-01-19
Fundamental Frequency	:2442 MHz	Temp./Humi.	:23 deg_C / 63 RH
Operation Mode	:TX MID	Engineer	:Curry
EUT Pol.	:H Plane	Measurement Antenna Pol.	:HORIZONTAL

Actual FS(dBμV/m) = SPA. Reading level(dBμV) + Factor(dB)

Factor(dB) = Antenna Factor(dBμV/m) + Cable Loss(dB) – Pre_Amplifier Gain(dB)

Note : “F” : denotes Fundamental Frequency. ; “H” : denotes Harmonic Frequency.

“E” : denotes Band Edge Frequency. ; “S” : denotes Spurious Frequency.

“---” : denotes Noise Floor.

Freq.	Note	Detector Mode	Spectrum Reading Level	Factor	Actual FS	Limit @3m	Margin
MHz	F/H/E/S	PK/QP/AV	dBμV	dB	dBμV/m	dBμV/m	dB
155.13	S	Peak	28.11	-12.51	15.60	43.50	-27.90
286.08	S	Peak	27.94	-11.51	16.43	46.00	-29.57
382.11	S	Peak	27.67	-9.43	18.24	46.00	-27.76
588.72	S	Peak	27.77	-5.00	22.77	46.00	-23.23
741.01	S	Peak	29.25	-2.90	26.35	46.00	-19.65
914.64	S	Peak	28.63	-0.37	28.26	46.00	-17.74
4884.00	H	Average	24.88	6.94	31.82	54.00	-22.18
4884.00	H	Peak	37.26	6.94	44.20	74.00	-29.80
7326.00	H	---					
9768.00	H	---					
12210.00	H	---					
14652.00	H	---					
17094.00	H	---					
19536.00	H	---					
21978.00	H	---					
24420.00	H	---					

Unless otherwise stated the results shown in this test report refer only to the sample(s) tested and such sample(s) are retained for 90 days only.

除非另有說明，此報告結果僅對測試之樣品負責，同時此樣品僅保留 90 天。本報告未經本公司書面許可，不可部份複製。

This document is issued by the Company subject to its General Conditions of Service printed overleaf, available on request or accessible at www.sgs.com/terms_and_conditions.htm and, for electronic format documents, subject to Terms and Conditions for Electronic Documents at www.sgs.com/terms_e-document.htm. Attention is drawn to the limitation of liability, indemnification and jurisdiction issues defined therein. Any holder of this document is advised that information contained hereon reflects the Company's findings at the time of its intervention only and within the limits of Client's instructions, if any. The Company's sole responsibility is to its Client and this document does not exonerate parties to a transaction from exercising all their rights and obligations under the transaction documents. This document cannot be reproduced except in full, without prior written approval of the Company. Any unauthorized alteration, forgery or falsification of the content or appearance of this document is unlawful and offenders may be prosecuted to the fullest extent of the law.

Radiated Spurious Emission Measurement Result

Operation Band	:BT4.0	Test Date	:2015-01-19
Fundamental Frequency	:2480 MHz	Temp./Humi.	:23 deg_C / 63 RH
Operation Mode	:TX HIGH	Engineer	:Curry
EUT Pol.	:H Plane	Measurement Antenna Pol.	:VERTICAL

Actual FS(dBμV/m) = SPA. Reading level(dBμV) + Factor(dB)

Factor(dB) = Antenna Factor(dBμV/m) + Cable Loss(dB) – Pre_Amplifier Gain(dB)

Note : “F” : denotes Fundamental Frequency. ; “H” : denotes Harmonic Frequency.

“E” : denotes Band Edge Frequency. ; “S” : denotes Spurious Frequency.

“---” : denotes Noise Floor.

Freq.	Note	Detector Mode	Spectrum Reading Level	Factor	Actual FS	Limit @3m	Margin
MHz	F/H/E/S	PK/QP/AV	dBμV	dB	dBμV/m	dBμV/m	dB
40.67	S	Peak	38.19	-13.49	24.70	40.00	-15.30
99.84	S	Peak	39.15	-17.96	21.19	43.50	-22.31
164.83	S	Peak	28.66	-12.62	16.04	43.50	-27.46
508.21	S	Peak	27.70	-7.34	20.36	46.00	-25.64
736.16	S	Peak	27.98	-3.22	24.76	46.00	-21.24
943.74	S	Peak	28.03	0.19	28.22	46.00	-17.78
4960.00	H	Average	24.35	7.08	31.43	54.00	-22.57
4960.00	H	Peak	37.33	7.08	44.41	74.00	-29.59
7440.00	H	---					
9920.00	H	---					
12400.00	H	---					
14880.00	H	---					
17360.00	H	---					
19840.00	H	---					
22320.00	H	---					
24800.00	H	---					

Unless otherwise stated the results shown in this test report refer only to the sample(s) tested and such sample(s) are retained for 90 days only.

除非另有說明，此報告結果僅對測試之樣品負責，同時此樣品僅保留 90 天。本報告未經本公司書面許可，不可部份複製。

This document is issued by the Company subject to its General Conditions of Service printed overleaf, available on request or accessible at www.sgs.com/terms_and_conditions.htm and, for electronic format documents, subject to Terms and Conditions for Electronic Documents at www.sgs.com/terms_e-document.htm. Attention is drawn to the limitation of liability, indemnification and jurisdiction issues defined therein. Any holder of this document is advised that information contained hereon reflects the Company's findings at the time of its intervention only and within the limits of Client's instructions, if any. The Company's sole responsibility is to its Client and this document does not exonerate parties to a transaction from exercising all their rights and obligations under the transaction documents. This document cannot be reproduced except in full, without prior written approval of the Company. Any unauthorized alteration, forgery or falsification of the content or appearance of this document is unlawful and offenders may be prosecuted to the fullest extent of the law.

Operation Band	:BT4.0	Test Date	:2015-01-19
Fundamental Frequency	:2480 MHz	Temp./Humi.	:23 deg_C / 63 RH
Operation Mode	:TX HIGH	Engineer	:Curry
EUT Pol.	:H Plane	Measurement Antenna Pol.	:HORIZONTAL

Actual FS(dB μ V/ m) = SPA. Reading level(dB μ V) + Factor(dB)

Factor(dB) = Antenna Factor(dB μ V/ m) + Cable Loss(dB) – Pre_Amplifier Gain(dB)

Note : “F” : denotes Fundamental Frequency. ; “H” : denotes Harmonic Frequency.

“E” : denotes Band Edge Frequency. ; “S” : denotes Spurious Frequency.

“---” : denotes Noise Floor.

Freq. MHz	Note F/H/E/S	Detector Mode PK/QP/AV	Spectrum Reading Level dB μ V	Factor dB	Actual FS dB μ V/ m	Limit @3m dB μ V/ m	Margin dB
159.98	S	Peak	26.80	-12.33	14.47	43.50	-29.03
286.08	S	Peak	28.64	-11.51	17.13	46.00	-28.87
525.67	S	Peak	28.25	-7.33	20.92	46.00	-25.08
590.66	S	Peak	29.54	-5.02	24.52	46.00	-21.48
733.25	S	Peak	28.36	-3.42	24.94	46.00	-21.06
915.61	S	Peak	28.70	-0.35	28.35	46.00	-17.65
4960.00	H	Average	24.35	7.08	31.43	54.00	-22.57
4960.00	H	Peak	37.72	7.08	44.80	74.00	-29.20
7440.00	H	---					
9920.00	H	---					
12400.00	H	---					
14880.00	H	---					
17360.00	H	---					
19840.00	H	---					
22320.00	H	---					
24800.00	H	---					

Unless otherwise stated the results shown in this test report refer only to the sample(s) tested and such sample(s) are retained for 90 days only.
除非另有說明，此報告結果僅對測試之樣品負責，同時此樣品僅保留 90 天。本報告未經本公司書面許可，不可部份複製。

This document is issued by the Company subject to its General Conditions of Service printed overleaf, available on request or accessible at www.sgs.com/terms_and_conditions.htm and, for electronic format documents, subject to Terms and Conditions for Electronic Documents at www.sgs.com/terms_e-document.htm. Attention is drawn to the limitation of liability, indemnification and jurisdiction issues defined therein. Any holder of this document is advised that information contained hereon reflects the Company's findings at the time of its intervention only and within the limits of Client's instructions, if any. The Company's sole responsibility is to its Client and this document does not exonerate parties to a transaction from exercising all their rights and obligations under the transaction documents. This document cannot be reproduced except in full, without prior written approval of the Company. Any unauthorized alteration, forgery or falsification of the content or appearance of this document is unlawful and offenders may be prosecuted to the fullest extent of the law.

11 PEAK POWER SPECTRAL DENSITY

11.1 Standard Applicable:

According to §15.247(e) For digitally modulated systems, the power spectral density conducted from the intentional radiator to the antenna shall not be greater than 8 dBm in any 3 kHz band during any time interval of continuous transmission. This power spectral density shall be determined in accordance with the provisions of paragraph (b) of this section. The same method of determining the conducted output power shall be used to determine the power spectral density.

11.2 Measurement Equipment Used:

Refer to section 7.2 for details.

11.3 Test Set-up:

Refer to section 8.3 for details.

11.4 Measurement Procedure:

1. Place the EUT on the table and set it in transmitting mode.
2. Remove the antenna from the EUT and then connect a low loss RF cable from the antenna port to the spectrum analyzer.
3. Set the spectrum analyzer as RBW = 3kHz, VBW = 10kHz, Span = 1.5MHz, Sweep=100s
4. Record the max. reading.
5. Repeat above procedures until all frequency measured were complete.

Unless otherwise stated the results shown in this test report refer only to the sample(s) tested and such sample(s) are retained for 90 days only.
除非另有說明，此報告結果僅對測試之樣品負責，同時此樣品僅保留 90 天。本報告未經本公司書面許可，不可部份複製。

This document is issued by the Company subject to its General Conditions of Service printed overleaf, available on request or accessible at www.sgs.com/terms_and_conditions.htm and, for electronic format documents, subject to Terms and Conditions for Electronic Documents at www.sgs.com/terms_e-document.htm. Attention is drawn to the limitation of liability, indemnification and jurisdiction issues defined therein. Any holder of this document is advised that information contained hereon reflects the Company's findings at the time of its intervention only and within the limits of Client's instructions, if any. The Company's sole responsibility is to its Client and this document does not exonerate parties to a transaction from exercising all their rights and obligations under the transaction documents. This document cannot be reproduced except in full, without prior written approval of the Company. Any unauthorized alteration, forgery or falsification of the content or appearance of this document is unlawful and offenders may be prosecuted to the fullest extent of the law.

11.5 Measurement Result:

BT4.0 mode

Frequency MHz	RF Power Density	Maximum Limit	Result
	Reading (dBm)	(dBm)	
2402	-16.18	8	PASS
2442	-15.35	8	PASS
2480	-16.40	8	PASS

NOTE: cable loss as 1.2dB that offsets in the spectrum

Note: Refer to next page for plots.

Unless otherwise stated the results shown in this test report refer only to the sample(s) tested and such sample(s) are retained for 90 days only.
 除非另有說明，此報告結果僅對測試之樣品負責，同時此樣品僅保留 90 天。本報告未經本公司書面許可，不可部份複製。

This document is issued by the Company subject to its General Conditions of Service printed overleaf, available on request or accessible at www.sgs.com/terms_and_conditions.htm and, for electronic format documents, subject to Terms and Conditions for Electronic Documents at www.sgs.com/terms_e-document.htm. Attention is drawn to the limitation of liability, indemnification and jurisdiction issues defined therein. Any holder of this document is advised that information contained hereon reflects the Company's findings at the time of its intervention only and within the limits of Client's instructions, if any. The Company's sole responsibility is to its Client and this document does not exonerate parties to a transaction from exercising all their rights and obligations under the transaction documents. This document cannot be reproduced except in full, without prior written approval of the Company. Any unauthorized alteration, forgery or falsification of the content or appearance of this document is unlawful and offenders may be prosecuted to the fullest extent of the law.

BT4.0 mode

Power Spectral Density Test Plot (CH-Low)

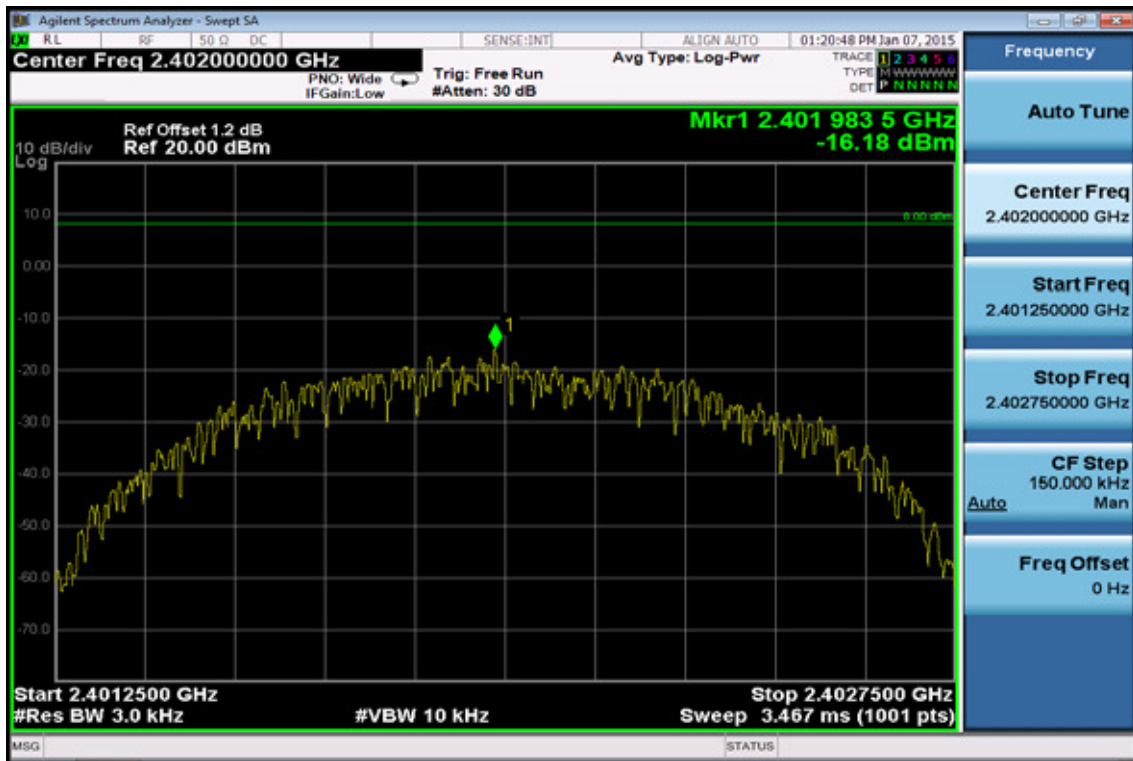

Power Spectral Density Test Plot (CH-Mid)

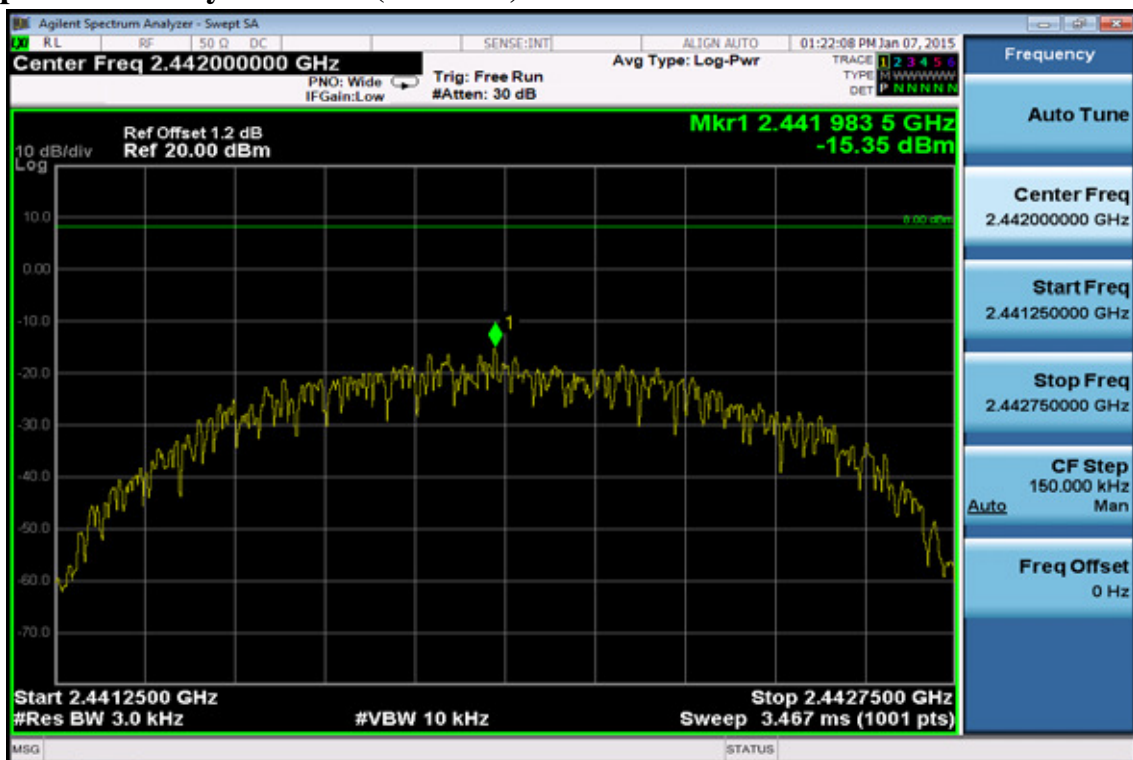

Unless otherwise stated the results shown in this test report refer only to the sample(s) tested and such sample(s) are retained for 90 days only.

除非另有說明，此報告結果僅對測試之樣品負責，同時此樣品僅保留 90 天。本報告未經本公司書面許可，不可部份複製。

This document is issued by the Company subject to its General Conditions of Service printed overleaf, available on request or accessible at www.sgs.com/terms_and_conditions.htm and, for electronic format documents, subject to Terms and Conditions for Electronic Documents at www.sgs.com/terms_e-document.htm. Attention is drawn to the limitation of liability, indemnification and jurisdiction issues defined therein. Any holder of this document is advised that information contained hereon reflects the Company's findings at the time of its intervention only and within the limits of Client's instructions, if any. The Company's sole responsibility is to its Client and this document does not exonerate parties to a transaction from exercising all their rights and obligations under the transaction documents. This document cannot be reproduced except in full, without prior written approval of the Company. Any unauthorized alteration, forgery or falsification of the content or appearance of this document is unlawful and offenders may be prosecuted to the fullest extent of the law.

Power Spectral Density Test Plot (CH-High)

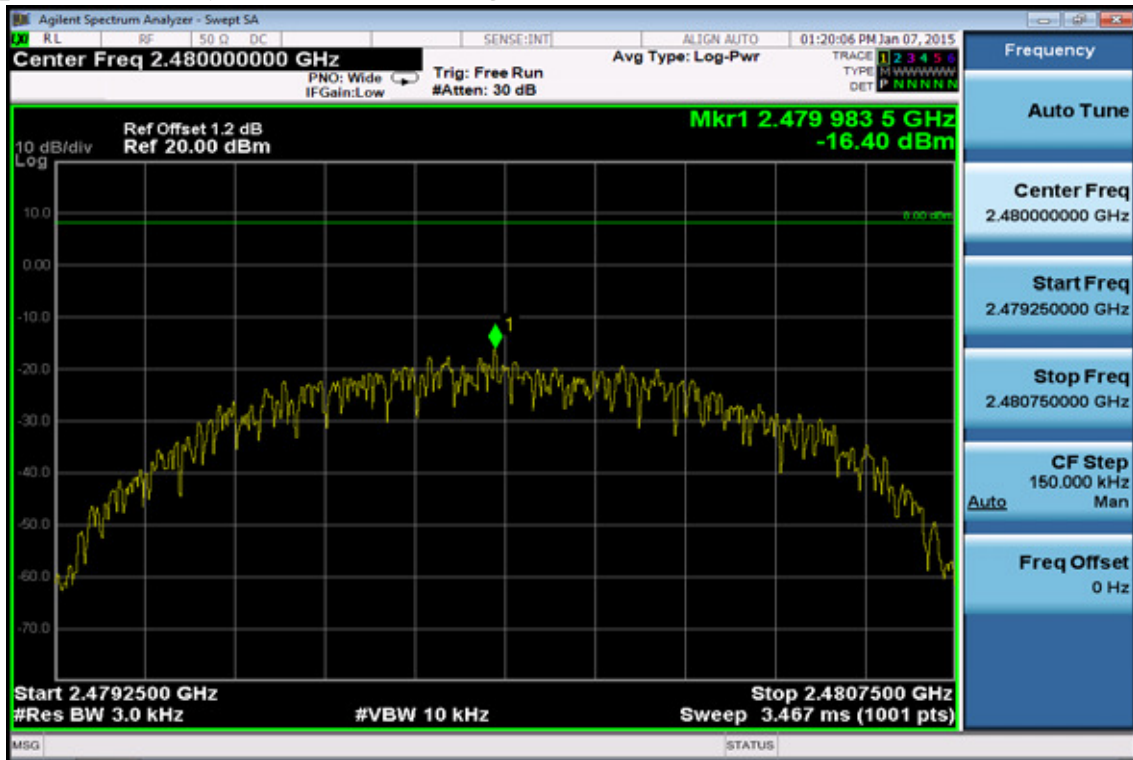

Unless otherwise stated the results shown in this test report refer only to the sample(s) tested and such sample(s) are retained for 90 days only.

除非另有說明，此報告結果僅對測試之樣品負責，同時此樣品僅保留 90 天。本報告未經本公司書面許可，不可部份複製。

This document is issued by the Company subject to its General Conditions of Service printed overleaf, available on request or accessible at www.sgs.com/terms_and_conditions.htm and, for electronic format documents, subject to Terms and Conditions for Electronic Documents at www.sgs.com/terms_e-document.htm. Attention is drawn to the limitation of liability, indemnification and jurisdiction issues defined therein. Any holder of this document is advised that information contained hereon reflects the Company's findings at the time of its intervention only and within the limits of Client's instructions, if any. The Company's sole responsibility is to its Client and this document does not exonerate parties to a transaction from exercising all their rights and obligations under the transaction documents. This document cannot be reproduced except in full, without prior written approval of the Company. Any unauthorized alteration, forgery or falsification of the content or appearance of this document is unlawful and offenders may be prosecuted to the fullest extent of the law.

12 ANTENNA REQUIREMENT

12.1 Standard Applicable:

For intentional device, according to §15.203, an intentional radiator shall be designed to ensure that no antenna other than furnished by the responsible party shall be used with the device.

12.2 Antenna Connected Construction:

The directional gains of antenna used for transmitting is 1.71dBi, and the antenna connector is designed with unique type RF connector and no consideration of replacement. Please see EUT photo and antenna spec. for details.

~ End of Report ~

Unless otherwise stated the results shown in this test report refer only to the sample(s) tested and such sample(s) are retained for 90 days only.
除非另有說明，此報告結果僅對測試之樣品負責，同時此樣品僅保留 90 天。本報告未經本公司書面許可，不可部份複製。

This document is issued by the Company subject to its General Conditions of Service printed overleaf, available on request or accessible at www.sgs.com/terms_and_conditions.htm and, for electronic format documents, subject to Terms and Conditions for Electronic Documents at www.sgs.com/terms_e-document.htm. Attention is drawn to the limitation of liability, indemnification and jurisdiction issues defined therein. Any holder of this document is advised that information contained hereon reflects the Company's findings at the time of its intervention only and within the limits of Client's instructions, if any. The Company's sole responsibility is to its Client and this document does not exonerate parties to a transaction from exercising all their rights and obligations under the transaction documents. This document cannot be reproduced except in full, without prior written approval of the Company. Any unauthorized alteration, forgery or falsification of the content or appearance of this document is unlawful and offenders may be prosecuted to the fullest extent of the law.