

NO.	REVISION DESCRIPTION	DRAWN	APPROVED	DATE
A				
B				

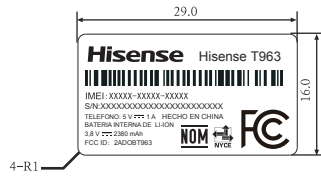

NO.	DESCRIPTION	MAT'L	DRAWING NO.	QTY	REMARK
			TITLE HANDSET Label		
			DRAWING NO.		SHEET
			A4-		
			Hisense		REV.
	JIANG Yimin				

NO.	REVISION DESCRIPTION	DRAWN	APPROVED	DATE

IMPORTADOR:
Pegaso PCS S.A. DE C.V.
Avenida Prolongación Paseo de la
Reforma No. 1200, Piso 14, Col. Cruz
Manca,
Municipio o Demarcación Territorial
Cuajimalpa de Morelos,
Ciudad de México, C. P. 05349 ,
R.F.C. PPC980624U16

MARCA: HISENSE
MODELO: Hisense T963

CARACTERISTICAS ELECTRICAS:
TELEFONO: 5 V --- 1 A
BATERIA RECARGABLE
3.8 V --- 2380 mAh
HECHO EN CHINA



6 941785 708115

INCLUYE:
ADAPTADOR
MARCA: HISENSE
MODELO: A31-501000
ENT: 100-240 V ~ 50/60 Hz 0,15 A
SAL: 5,0 V --- 1 A



BATERIA RECARGABLE
MARCA: HISENSE
MODELO: LW38238
3.8 V --- 2380 mAh

El equipo provisto por Movistar que usted está
adquiriendo se encuentra bloqueado, y solamente
puede ser utilizado en la red de Movistar. Recibe
información gratuita sobre su desbloqueo en tu
Centro de Atención a Clientes Movistar más cercano.



S/N: 1MH75BA9MX10D0XXXXXXXXXX
IMEI:XXXXXXXXXXXXXXX

Hisense
Hisense T963 Color: Negro
FCC ID: 2AD0BT963

Hisense Communications Co., Ltd.

Modelo: Hisense T963 Color: Negro



IMEI: XXXX-XXXX-XXXX

Modelo: Hisense T963 Color: Negro



IMEI: XXXX-XXXX-XXXX

Modelo: Hisense T963 Color: Negro



IMEI: XXXX-XXXX-XXXX

NO.	DESCRIPTION	MAT'L	DRAWING NO.	Q'TY	REMARK
MAT'L			Giftbox Label		
FINISH					
SCALE	DATE	UNIT	A4-		DRAWING NO.
		mm			
DRAWN	CHECKED	APPROVED	Hisense		REV.
JIANG Yimin					

NO.	REVISION DESCRIPTION	DRAWN	APPROVED	DATE
A				
B				

IMPORTADOR:
Pegaso PCS S.A. DE C.V.
Avenida Prolongación Paseo de la
Reforma No. 1200, Piso 14, Col. Cruz
Manca,
Municipio o Demarcación Territorial
Cuajimalpa de Morelos,
Ciudad de México, C. P. 05349 ,
R.F.C. PPC980624U16

MARCA: HISENSE
MODELO: Hisense T963

CARACTERISTICAS ELECTRICAS:
TELEFONO: 5 V \Rightarrow 1 A
BATERIA RECARGABLE
3.8 V \Rightarrow 2380 mAh
HECHO EN CHINA



6 | 941785 | 708122

INCLUYE:
ADAPTADOR
MARCA: HISENSE
MODELO: A31-501000
ENT: 100-240 V ~ 50/60 Hz 0,15 A
SAL: 5,0 V \Rightarrow 1 A

BATERIA RECARGABLE
MARCA: HISENSE
MODELO: LW38238
3.8 V \Rightarrow 2380 mAh

El equipo provisto por Movistar que usted está
adquiriendo se encuentra bloqueado, y solamente
puede ser utilizado en la red de Movistar. Recibe
información gratuita sobre su desbloqueo en tu
Centro de Atención a Clientes Movistar más cercano.



S/N: 1MH75BA9MX1Z60XXXXXXXXXX
IMEI:XXXXXXXXXXXXXXX

Hisense
Hisense T963 Color:Dorado
FCC ID: 2AD0BT963



Modelo:Hisense T963 Color:Dorado



IMEI: XXXX-XXXX-XXXX

Modelo:Hisense T963 Color:Dorado



IMEI: XXXX-XXXX-XXXX

Modelo:Hisense T963 Color:Dorado



IMEI: XXXX-XXXX-XXXX

























NO.	DESCRIPTION	MAT'L	DRAWING NO.	Q'TY	REMARK
MAT'L		TITLE Giftbox Label			
FINISH					
SCALE	DATE	UNIT	DRAWING NO.		SHEET
		mm	A4-		
DRAWN	CHECKED	APPROVED	Hisense		REV.
JIANG Yimin					

NO.	REVISION DESCRIPTION	DRAWN	APPROVED	DATE
A				
B				

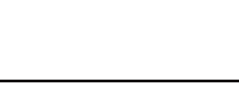
Hisense Modelo: Hisense T963 Color: Dorado
 Ctd: 20 PZS Hecho en China

Peso Neto: KG
 Dimensiones: 43.0×35.6×22.8 CM

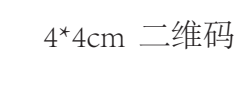
Caja ID: T963XXXXXXXXXX

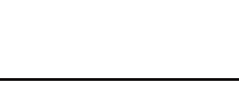
4*4cm 二维码

SIZE:TBD

NO.	DESCRIPTION	MAT'L	DRAWING NO.	QTY	REMARK
			TITLE Carton Box Label		
			DRAWING NO.		SHEET
			A4-		
			Hisense		REV.
	JIANG Yimin				

NO.	REVISION DESCRIPTION	DRAWN	APPROVED	DATE
A				
B				











Hisense Modelo: Hisense T963 Color: Negro
 Ctd: 20 PZS Hecho en China













Peso Neto: KG
 Dimensiones: 43.0×35.6×22.8 CM

Caja ID: T963XXXXXXXXXX



6 | 941785 | 708115

	
	
	
	
	<div style="border: 1px solid black; padding: 10px; width: 150px; margin: 0 auto;"> 4*4cm 二维码 </div>
	
	
	
	

SIZE:TBD

NO.	DESCRIPTION	MAT'L	DRAWING NO.	QTY	REMARK
			TITLE Carton Box Label		
			DRAWING NO.		SHEET
			A4-		
			Hisense		REV.
	JIANG Yimin				

8LE`L18`81AH

版本号

V0.00

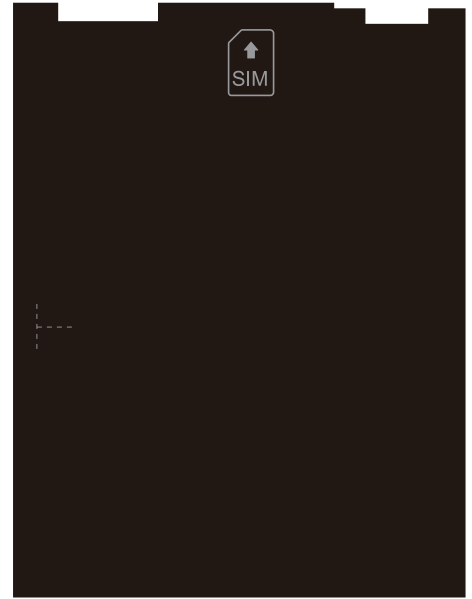
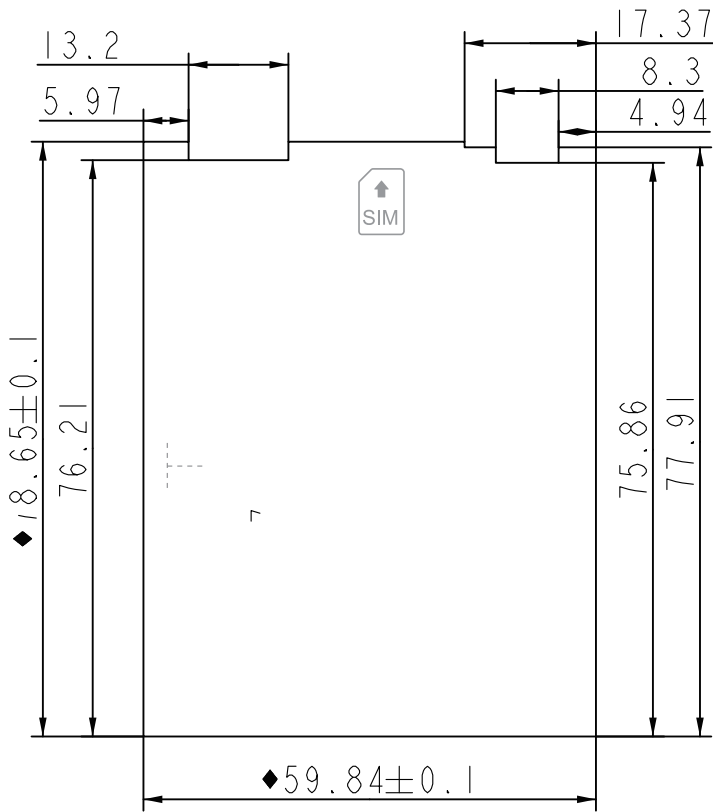

技术要求

1. 材料：黑色PC片材，表面带纹理，1860B，背面附胶Tesa 4972(T=0.048mm)，总厚度T=0.15±0.02mm；
2. 未注尺寸公差参照公差表；
"◆"标识尺寸为重点管控尺寸(共 2 处)，关键尺寸CPK≥1.33；
3. 印刷内容要求另见制版稿文件；
4. 包装符合海信移动技术公司QHYTE J07 017-2015《移动电话产品结构件包装要求》；
5. 用于制造该零件的材料中的有害物质不能超过ROHS 2011/65/EU指令及REACH No.1907/2006法规规定的限值要求 欧盟豁免项除外
6. 样品经设计人员确认后方可量产。

公差表

尺寸	≤20	>20~60	>60
公差值	±0.10	±0.15	±0.20

媒体编号

镀涂

视角表示

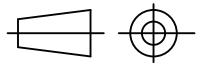

旧底图总号

电池仓标贴

HYT8.817.378

更改标记数量 更改单号 签名 日期

阶段标记 质量 比例

设计
审核
工艺

1:1

日期 签名

第 1 张 共 1 张

标准
批准

见技术要求



海信移动技术公司

格式(1)

制图:

描图:

幅面: A4





























NO.	REVISION DESCRIPTION	DRAWN	APPROVED	DATE
				
				

Hisense





N° TARIMA: 78700000001

CLIENTE: Telefonica
 N° ORDEN: 100XXXXXXX
 MODELO: Hisense T963
 COLOR: Negro
 CANTIDAD: 600 PZS
 PESO: KGS

 675000001001	 675000001016
 675000001002	 675000001017
 675000001003	 675000001018
 675000001004	 675000001019
 675000001005	 675000001020
 675000001006	 675000001021
 675000001007	 675000001022
 675000001008	 675000001023
 675000001009	 675000001024
 675000001010	 675000001025
 675000001011	 675000001026
 675000001012	 675000001027
 675000001013	 675000001028
 675000001014	 675000001029
 675000001015	 675000001030

SIZE: TBD

NO.	DESCRIPTION	MAT'L	DRAWING NO.	QTY	REMARK
MAT'L		TITLE Pallet Label			
FINISH					
SCALE	DATE	UNIT	DRAWING NO.		SHEET
		mm	A4-		
DRAWN	CHECKED	APPROVED	Hisense		REV.
JIANG Yimin					













NO.	REVISION DESCRIPTION	DRAWN	APPROVED	DATE
				
				

Hisense



N° TARIMA: 78700000001

CLIENTE: Telefonica
 N° ORDEN: 100XXXXXXX
 MODELO: Hisense T963
 COLOR: Dorado
 CANTIDAD: 600 PZS
 PESO: KGS

 675000001001	 675000001016
 675000001002	 675000001017
 675000001003	 675000001018
 675000001004	 675000001019
 675000001005	 675000001020
 675000001006	 675000001021
 675000001007	 675000001022
 675000001008	 675000001023
 675000001009	 675000001024
 675000001010	 675000001025
 675000001011	 675000001026
 675000001012	 675000001027
 675000001013	 675000001028
 675000001014	 675000001029
 675000001015	 675000001030

SIZE: TBD

NO.	DESCRIPTION	MAT'L	DRAWING NO.	QTY	REMARK
			Pallet Label		
			A4-		SHEET
			Hisense		REV.
JIANG Yimin					