TEST REPORT FOR RF TESTING

Report No.: SRTC2021-9004(F)-21090301(C)

Product Name: Mobile phone

Product Model: HLTE228E.20

Applicant: Hisense International Co., Ltd.

Manufacturer: Hisense Communications Co., Ltd.

Specification: FCC Part 2, Part 24E, Part 22H, Part 27 (2019)

FCC ID: 2ADOBLTE228E20

The State Radio_monitoring_center Testing Center (SRTC)

15th Building, No.30, Shixing Street, Shijingshan District,

Beijing, P.R.China

Tel: 86-10-57996183 Fax: 86-10-57996388

CONTENTS

1. GENERAL INFORMATION	2
1.1 Notes of the test report	2
1.2 Information about the testing laboratory	2
1.3 Applicant’s details	2
1.4 Manufacturer’s details	2
1.5 Test Environment.....	3
2 DESCRIPTION OF THE EQUIPMENT UNDER TEST	4
2.1 Final Equipment Build Status	4
2.2 Support Equipment	5
2.3 Summary table.....	6
3 REFERENCE SPECIFICATION	8
4 KEY TO NOTES AND RESULT CODES	8
5 RESULT SUMMARY.....	9
6 TEST RESULT	10
6.1 RF Power Output	10
6.2 Effective Radiated Power and Effective Isotropic Radiated Power	11
6.3 Occupied Bandwidth	14
6.4 Emission Bandwidth.....	15
6.5 Peak-Average Ratio	16
6.6 Spurious Emissions at antenna terminal	17
6.7 Band Edges Compliance	18
6.8 Frequency Stability	20
6.9 Radiated Spurious Emissions	21
7 MEASUREMENT UNCERTAINTIES.....	23
8 TEST EQUIPMENTS.....	24
APPENDIX A – TEST DATA OF CONDUCTED EMISSION.....	24
APPENDIX B – TEST DATA OF RADIATED EMISSION	24

1. GENERAL INFORMATION

1.1 Notes of the test report

The test report may only be reproduced or published in full. Reproduction or publication of extracts from the report requires the prior written permission of The State Radio_monitoring_center Testing Center (SRTC). The test results relate only to individual items of the samples which have been tested. The certification and accreditation identifiers used in this report shall not be applicable to the tested or calibrated samples thereof. The manufacturer shall not mark the tested samples or items (or a separate part of the item) with the identifiers of certification and accreditation to mislead relevant parties about the tested samples or items.

1.2 Information about the testing laboratory

Company:	The State Radio_monitoring_center Testing Center (SRTC)
Address:	15th Building, No.30 Shixing Street, Shijingshan District, P.R.China
City:	Beijing
Country or Region:	P.R.China
Contacted person:	Liu Jia
Tel:	+86 10 57996183
Fax:	+86 10 57996388
Email:	liujiaf@srtc.org.cn

1.3 Applicant's details

Company:	Hisense International Co., Ltd.
Address:	Floor 22, Hisense Tower, 17 Donghai Xi Road, Qingdao, 266071, China
City:	Qingdao
Country or Region:	China
Contacted person:	Geng Ruifeng
Tel:	+86-532-80877742
Fax:	---
Email:	gengruifeng@hisense.com

1.4 Manufacturer's details

Company:	Hisense Communications Co., Ltd.
Address:	218 Qianwangang Road, Qingdao Economic & Technological Development Zone, Qingdao, China
City:	Qingdao
Country or Region:	P.R. China
Contacted person:	Deng Tingting
Tel:	+86-532-55753708
Fax:	---
Email:	dengtingting@hisense.com

1.5 Test Environment

Date of Receipt of test sample at SRTC:	2021.09.03
Testing Start Date:	2021.09.05
Testing End Date:	2021.09.16

Environmental Data:	Temperature (°C)	Humidity (%)
Ambient	25	30
Maximum Extreme	55	---
Minimum Extreme	-20	---

Normal Supply Voltage (V d.c.):	3.50
Maximum Extreme Supply Voltage (V d.c.):	3.85
Minimum Extreme Supply Voltage (V d.c.):	4.40

2 DESCRIPTION OF THE EQUIPMENT UNDER TEST

2.1 Final Equipment Build Status

Frequency Range	LTE Band 2: Tx:1850~1910MHz Rx:1930~1990MHz LTE Band 4: Tx:1710~1755MHz Rx:2110~2155MHz LTE Band 5: Tx:824~849 MHz Rx:869 ~894MHz LTE Band 7: Tx:2500~2570MHz Rx:2620~2690MHz LTE Band 12: Tx:699~716MHz Rx:729~746MHz LTE Band 26: Tx:824~849 MHz Rx:869 ~894MHz LTE Band 66: Tx:1710~1780MHz Rx: 2110~2200MHz
Modulation Type	QPSK/16QAM
Antenna Type	Fixed Internal Antenna
Antenna Gain	LTE Band2:-0.42dBi LTE Band4:-0.41dBi LTE Band5:-0.72dBi LTE Band7:-0.6dBi LTE Band12:-1.25dBi LTE Band26:-0.81dBi LTE Band66:-0.41dBi
Power Supply	Battery/Charger
Hardware Version	FS180V0.5
Software Version	Hisense_HLTE228E_20_S03_01_01_MX06
IMEI	868508050000572

Main and Secondary supply is different on the supplier of Camera and Battery.

Main Supply

Part Name	Model Name	supplier	Remark
battery	LPN440450	ShenzhenAerospaceElectronicCo.,Ltd	
CAM	LH-CFKS228BA	SHENZHEN Imaging TECHNOLOGY CO.,LTD	

Secondary Supply

Part Name	Model Name	supplier	Remark
battery	LPN440450	DONGGUANG MILEY ElectronicCo.,Ltd	
CAM	H9B13-KS230BA	Hunan Kingcome Optoelectronic Co., Ltd	

Note: The test results of variant product derive from original product Report No.: SRTC2020-9004(F)-20102601(C).

2.2 Support Equipment

The following support equipment was used to exercise the DUT during testing:

Equipment	Battery 1
Manufacturer	ShenzhenAerospaceElectronicCo.,Ltd
Model Number	LPN440450

Equipment	Battery 2
Manufacturer	DONGGUANG MILEY ElectronicCo.,Ltd
Model Number	LPN440450

Equipment	Charger
Manufacturer	SHENZHENTIANYIN ELECTRONICS CO., LTD.
Model Number	TPA-46050200UU

Equipment	Headset
Manufacturer	kelinDongguan Keling Electronic Technology Co., Ltd
Model Number	KLKS228A

Equipment	USB Cable
Manufacturer	kelinDongguan Keling Electronic Technology Co., Ltd
Model Number	KLKS816A

2.3 Summary table

FCC Rule Part	Frequency Range(MHz)	EIRP/ERP (W)	Frequency Tolerance (ppm)	Emission Designator	Emission Bandwidth (MHz)	Measured 26dBC Bandwidth (MHz)	Communication Type
LTE BAND2							
24E	1850.7-1909.3	0.208	0.039	1M08G7D	1.4M	1.233	QPSK
	1850.7-1909.3	0.182	0.039	1M08D7W	1.4M	1.221	16QAM
	1851.5-1908.5	0.209	0.034	2M70G7D	3M	3.029	QPSK
	1851.5-1908.5	0.182	0.034	2M70D7W	3M	3.024	16QAM
	1852.5-1907.5	0.208	0.038	4M47G7D	5M	4.891	QPSK
	1852.5-1907.5	0.182	0.038	4M48D7W	5M	4.905	16QAM
	1855-1905	0.209	0.039	8M97G7D	10M	9.822	QPSK
	1855-1905	0.183	0.039	8M97D7W	10M	9.708	16QAM
	1857.5-1902.5	0.209	0.037	13M4G7D	15M	14.58	QPSK
	1857.5-1902.5	0.182	0.037	13M5D7W	15M	14.63	16QAM
1860-1900	0.211	0.039	17M9G7D	20M	19.45	QPSK	
1860-1900	0.185	0.039	17M9D7W	20M	19.41	16QAM	
LTE BAND4							
27	1710.7-1754.3	0.205	0.582	1M08G7D	1.4M	1.234	QPSK
	1710.7-1754.3	0.166	0.582	1M09D7W	1.4M	1.240	16QAM
	1711.5-1753.5	0.219	0.570	2M68G7D	3M	3.009	QPSK
	1711.5-1753.5	0.165	0.570	2M70D7W	3M	2.983	16QAM
	1712.5-1752.5	0.206	0.058	4M47G7D	5M	4.884	QPSK
	1712.5-1752.5	0.142	0.058	4M48D7W	5M	4.906	16QAM
	1715-1750	0.206	0.023	8M99G7D	10M	9.682	QPSK
	1715-1750	0.196	0.023	8M94D7W	10M	9.682	16QAM
	1717.5-1747.5	0.202	0.021	13M4G7D	15M	14.65	QPSK
	1717.5-1747.5	0.196	0.021	13M4D7W	15M	14.71	16QAM
	1720-1745	0.202	0.021	17M9G7D	20M	19.36	QPSK
	1720-1745	0.183	0.021	17M9D7W	20M	19.36	16QAM
LTE BAND66							
27	1710.7-1779.3	0.170	-0.018	1M08G7D	1.4M	1.228	QPSK
	1710.7-1779.3	0.156	-0.018	1M09D7W	1.4M	1.228	16QAM
	1711.5-1778.5	0.182	0.548	2M68G7D	3M	2.983	QPSK
	1711.5-1778.5	0.154	0.548	2M68D7W	3M	2.996	16QAM
	1712.5-1777.5	0.171	-0.017	4M47G7D	5M	4.884	QPSK
	1712.5-1777.5	0.144	-0.017	4M47D7W	5M	4.906	16QAM
	1715-1775	0.170	-0.014	8M99G7D	10M	9.768	QPSK
	1715-1775	0.163	-0.014	8M94D7W	10M	9.682	16QAM
	1717.5-1772.5	0.170	0.014	13M4G7D	15M	14.65	QPSK
	1717.5-1772.5	0.163	0.014	13M4D7W	15M	14.72	16QAM
	1720-1770	0.167	0.017	17M9G7D	20M	19.36	QPSK
	1720-1770	0.152	0.017	17M9D7W	20M	19.36	16QAM

LTE BAND5							
22H	824.7-848.3	0.120	0.033	1M08G7D	1.4M	1.221	QPSK
	824.7-848.3	0.099	0.033	1M08D7W	1.4M	1.222	16QAM
	825.5-847.5	0.119	0.037	2M69G7D	3M	3.022	QPSK
	825.5-847.5	0.099	0.037	2M70D7W	3M	3.025	16QAM
	826.5-846.5	0.120	0.035	4M47G7D	5M	4.908	QPSK
	826.5-846.5	0.099	0.035	4M47D7W	5M	4.908	16QAM
	829-844	0.121	0.034	8M96G7D	10M	9.634	QPSK
	829-844	0.100	0.034	8M93D7W	10M	9.807	16QAM
LTE BAND7							
27	2502.5-2567.5	0.178	0.040	4M47G7D	5M	4.937	QPSK
	2502.5-2567.5	0.166	0.040	4M47D7W	5M	4.899	16QAM
	2505-2565	0.178	0.040	8M94G7D	10M	9.764	QPSK
	2505-2565	0.165	0.040	8M95D7W	10M	9.851	16QAM
	2507.5-2562.5	0.179	0.031	13M5G7D	15M	14.60	QPSK
	2507.5-2562.5	0.167	0.031	13M4D7W	15M	14.58	16QAM
	2510-2560	0.182	0.034	17M9G7D	20M	19.46	QPSK
	2510-2560	0.168	0.034	17M9D7W	20M	19.57	16QAM
LTE BAND12							
27	699.7-715.3	0.097	0.038	1M08G7D	1.4M	1.222	QPSK
	699.7-715.3	0.083	0.038	1M08D7W	1.4M	1.216	16QAM
	700.5-714.5	0.097	0.039	2M70G7D	3M	3.029	QPSK
	700.5-714.5	0.083	0.039	2M70D7W	3M	3.036	16QAM
	701.5-713.5	0.097	0.040	4M48G7D	5M	4.899	QPSK
	701.5-713.5	0.082	0.040	4M48D7W	5M	4.892	16QAM
	704-711	0.098	0.032	8M97G7D	10M	9.799	QPSK
	704-711	0.084	0.032	8M96D7W	10M	9.802	16QAM
LTE BAND26							
22H	824.7-848.3	0.113	0.038	1M08G7D	1.4M	1.220	QPSK
	824.7-848.3	0.100	0.038	1M08D7W	1.4M	1.221	16QAM
	825.5-847.5	0.113	0.033	2M71G7D	3M	3.028	QPSK
	825.5-847.5	0.100	0.033	2M70D7W	3M	3.015	16QAM
	826.5-846.5	0.113	-0.037	4M48G7D	5M	4.911	QPSK
	826.5-846.5	0.100	-0.037	4M48D7W	5M	4.885	16QAM
	829-844	0.113	0.036	8M96G7D	10M	9.747	QPSK
	829-844	0.099	0.036	8M95D7W	10M	9.682	16QAM
	831.5-841.5	0.115	0.040	13M4G7D	15M	14.50	QPSK
	831.5-841.5	0.101	0.040	13M4D7W	15M	14.48	16QAM

3 REFERENCE SPECIFICATION

Specification	Version	Title
FCC Part 2	2019	Frequency allocations and radio treaty matters; general rules and regulations
FCC Part 22	2019	Public mobile services
FCC Part 24	2019	Personal communications services
FCC Part 27	2019	Miscellaneous wireless communications services
ANSI C63.26	2015	American national standard for compliance testing of transmitters used in licensed radio services
KDB 971168 D01	April 9, 2018	Measurement guidance for certification of licensed digital transmitters
TIA-603-E-2016	March 2016	Land Mobile FM or PM Communications Equipment Measurement and Performance Standards



4 KEY TO NOTES AND RESULT CODES

The following are the definition of the test result.

Code	Meaning
PASS	Test result shows that the requirements of the relevant specification have been met.
FAIL	Test result shows that the requirements of the relevant specification have not been met.
NT	Normal Temperature
NV	Nominal voltage
HV	High voltage
LV	Low voltage

5 RESULT SUMMARY

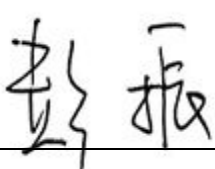
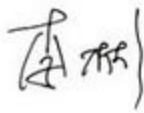
No.	Test case	FCC reference	Verdict
1	RF Power Output	2.1046	Pass
2	Effective Radiated Power and Effective Isotropic Radiated Power	22.913(a)(5), 24.232(c), 27.50(b)(10), 27.50(c)(10), 27.50(h)(2), 27.50(d)(4), 27.50(a)(3)	Pass
3	Occupied Bandwidth	2.1049	Pass
4	Peak-Average Ratio	24.232(d), 27.50(d)(5)	Pass
5	Emission Bandwidth	2.1049	Pass
6	Spurious Emissions at antenna terminals	2.1051, 22.917(a), 24.238(a), 27.53(c), 27.53(g), 27.53(h), 27.53(m), 27.53(a)	Pass
7	Band Edges Compliance	2.1051, 22.917(a), 24.238(a), 27.53(c), 27.53(g), 27.53(h), 27.53(m), 27.53(a)	Pass
8	Frequency Stability	2.1055, 22.355, 24.235, 27.54	Pass
9	Radiated Spurious Emissions	2.1053, 22.917(a), 24.238(a), 27.53(c), 27.53(g), 27.53(h), 27.53(f), 27.53(a), 27.53(m)	Pass

This Test Report Is Issued by: Mr. Peng Zhen 	Checked by: Mr. Li Bin 
Tested by: Miss Jin Wanqing 	Issued date: 20210924

6 TEST RESULT

6.1 RF Power Output

Rule Part(s)
 FCC: 2.1046

Ambient condition:

Temperature	Relative humidity	Pressure
25°C	30%	101.9kPa

Test Setup:

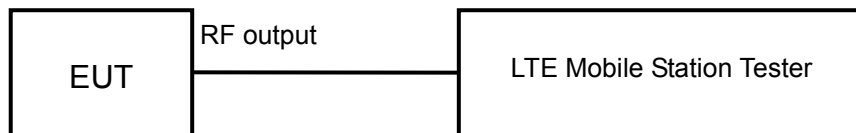

Test procedure:

After a radio link has been established between EUT and Tester, the output power of the cell signal of the testing equipment will be decreased until the output power of the EUT reach a maximum value. Then the test data can be read at the tester screen. The loss between RF output port of the EUT and the input port of the tester will be taken into consideration.

Limits: No RF Power Output requirements in part 2.1046.

Test result:

The test results are shown in Appendix A.

6.2 Effective Radiated Power and Effective Isotropic Radiated Power

Rule Part(s)

FCC: 22.913(a) (5), 24.232(c), 27.50(b) (10), 27.50(c) (10), 27.50(h) (2), 27.50(d) (4),
27.50(a) (3)

Ambient condition:

Temperature	Relative humidity	Pressure
25°C	30%	101.9kPa

Test setup:

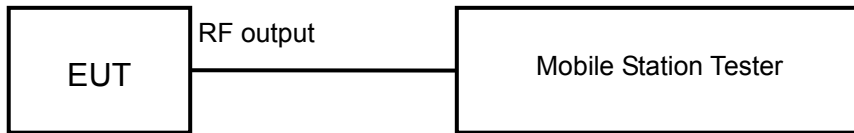

Test procedure:

KDB 971168 D01 v03r01 – Section 5.6

Test Settings

Subclause 5.2.5.5 of ANSI C63.26-2015 is applicable, along with the following provisions. For personal/portable radios utilizing an integral antenna, the factor LC is typically negligible. However, in a fixed station transmit system that utilizes a long cable run between the transmitter and the transmitting antenna, this factor can be significant. The minimum cable loss should be used in this equation.

The relevant equation for determining the ERP or EIRP from the conducted RF output power measured is:

$$\text{ERP/EIRP} = \text{PMeas} - \text{LC} + \text{GT}$$

Where:

ERP/EIRP = effective or equivalent radiated power, respectively (expressed in the same units as PMeas, typically dBW or dBm)

PMeas = measured transmitter output power or PSD, in dBW or dBm

LC = signal attenuation in the connecting cable between the transmitter and antenna in dB

GT = gain of the transmitting antenna, in dBd (ERP) or dBi (EIRP)

ERP/EIRP LIMIT

This value is EIRP since the measurement is calibrated using an antenna of known gain (2.15dB) and known input power. ERP can be calculated from EIRP by subtracting the gain of the dipole, $\text{ERP} = \text{EIRP} - 2.15 \text{ (dB)}$.

22.913(a) (5)

The ERP of mobile transmitters and auxiliary test transmitters must not exceed 7 watts.

24.232(c)

Mobile and portable stations are limited to 2 watts EIRP and the equipment must employ a means for limiting power to the minimum necessary for successful communications.

27.50(b) (10)

Portable stations (hand-held devices) transmitting in the 746-757 MHz, 776-788 MHz, and 805-806 MHz bands are limited to 3 watts ERP.

27.50(c) (10)

Portable stations (hand-held devices) in the 600 MHz uplink band and the 698-746 MHz band, and fixed and mobile stations in the 600 MHz uplink band are limited to 3 watts ERP.

27.50(h) (2)

Mobile and other user stations. Mobile stations are limited to 2.0 watts EIRP. All user stations are limited to 2.0 watts transmitter output power.

27.50(d) (4)

Fixed, mobile, and portable (hand-held) stations operating in the 1710-1755 MHz band and mobile and portable stations operating in the 1695-1710 MHz and 1755-1780 MHz bands are limited to 1 watt EIRP. Fixed stations operating in the 1710-1755 MHz band are limited to a maximum antenna height of 10 meters above ground. Mobile and portable stations operating in these bands must employ a means for limiting power to the minimum necessary for successful communications.

27.50(a) (3)

Mobile and portable stations (i) For mobile and portable stations transmitting in the 2305-2315 MHz band or the 2350-2360 MHz band, the average EIRP must not exceed 50 milliwatts within any 1 megahertz of authorized bandwidth, except that for mobile and portable stations compliant with 3GPP LTE standards or another advanced mobile broadband protocol that avoids concentrating energy at the edge of the operating band the

average EIRP must not exceed 250 milliwatts within any 5 megahertz of authorized bandwidth but may exceed 50 milliwatts within any 1 megahertz of authorized bandwidth.

Test result:

The test results are shown in Appendix B.

6.3 Occupied Bandwidth

Rule Part(s)
 FCC: 2.1049

Ambient condition:

Temperature	Relative humidity	Pressure
25°C	30%	101.9kPa

Test Setup:

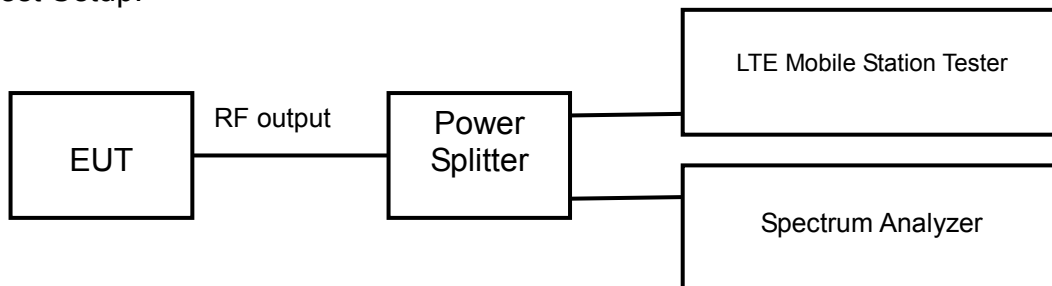

Test procedure:
 KDB 971168 D01 v03r01 – Section 4.2

Test Setting:

1. The signal analyzer’s automatic bandwidth measurement capability was used to perform the 99% occupied bandwidth. The bandwidth measurement was not influenced by any intermediate power nulls in the fundamental emission.
2. RBW = 1 – 5% of the expected OBW
3. VBW ≥ 3 x RBW
4. Detector = Peak
5. Trace mode = max hold
6. Sweep = auto couple
7. The trace was allowed to stabilize
8. If necessary, steps 2 – 7 were repeated after changing the RBW such that it would be within 1 – 5% of the 99% occupied bandwidth observed in Step 7

Limits: No specific occupied bandwidth requirements in part 2.1049

Test result:

The test results are shown in Appendix A.

6.4 Emission Bandwidth

Rule Part(s)
 FCC: 2.1049

Ambient condition:

Temperature	Relative humidity	Pressure
25°C	30%	101.9kPa

Test Setup:

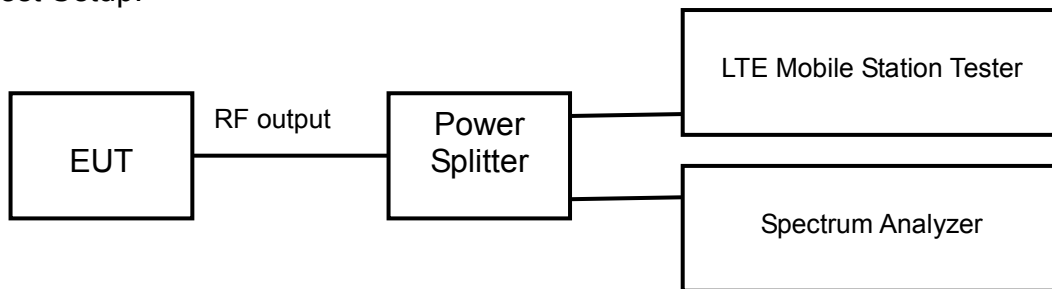

Test procedure:
 KDB 971168 D01 v03r01 – Section 4.2

Test Setting:

1. The signal analyzer's automatic bandwidth measurement capability was used to perform the 26dB bandwidth. The bandwidth measurement was not influenced by any intermediate power nulls in the fundamental emission.
2. RBW = 1 – 5% of the expected OBW
3. VBW ≥ 3 x RBW
4. Detector = Peak
5. Trace mode = max hold
6. Sweep = auto couple
7. The trace was allowed to stabilize
8. If necessary, steps 2 – 7 were repeated after changing the RBW such that it would be within 1 – 5% of 26dB bandwidth observed in Step 7

Limits: No specific emission bandwidth requirements in part 2.1049.

Test result:
 The test results are shown in Appendix A.

6.5 Peak-Average Ratio

Rule Part(s)

FCC: 24.232(d), 27.50(d) (5)

Ambient condition:

Temperature	Relative humidity	Pressure
25°C	30%	101.9kPa

Test Setup:

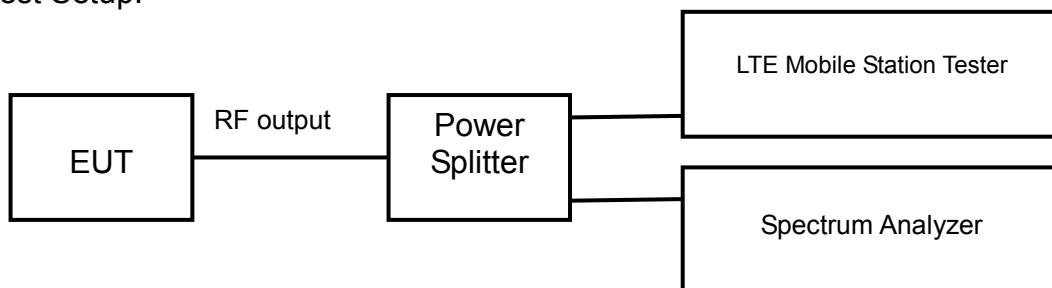

Test procedure:

KDB 971168 D01 v03r01 – Section 5.7.1

Test Setting:

1. The signal analyzer's CCDF measurement profile is enabled
2. Frequency = carrier center frequency
3. Measurement BW ≥ OBW or specified reference bandwidth
4. The signal analyzer was set to collect one million samples to generate the CCDF curve
5. The measurement interval was set depending on the type of signal analyzed. For continuous signals (>98% duty cycle), the measurement interval was set to 1ms. For burst transmissions, the spectrum analyzer is set to use an internal "RF Burst" trigger that is synced with an incoming pulse and the measurement interval is set to less than the duration of the "on time" of one burst to ensure that energy is only captured during a time in which the transmitter is operating at maximum power

Limits

24.232(d), 27.50(d) (5)

In measuring transmissions in this band using an average power technique, the peak-to-average ratio (PAR) of the transmission may not exceed 13 dB.

Test result:

The test results are shown in Appendix A.

6.6 Spurious Emissions at antenna terminal

Rule Part(s)

FCC: 2.1051, 22.917(a), 24.238(a), 27.53(c), 27.53(g), 27.53(h), 27.53(m), 27.53(a)

Ambient condition:

Temperature	Relative humidity	Pressure
25°C	30%	101.9kPa

Test Setup:

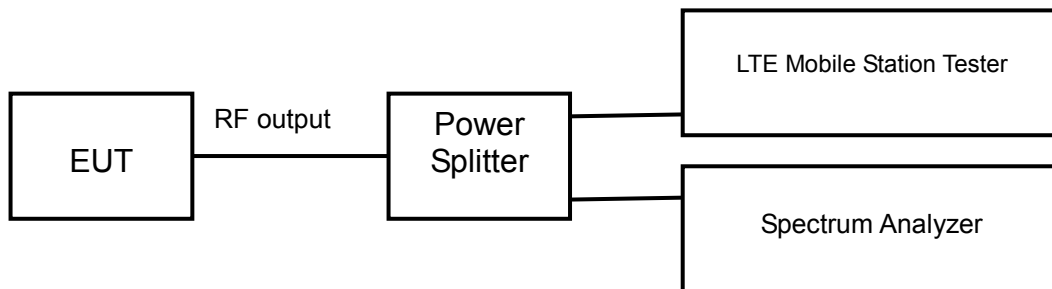

Test procedure:

KDB 971168 D01 v03r01 – Section 6.0

Test Setting:

1. Start frequency was set to 30MHz and stop frequency was set to at least 10 * the fundamental frequency
2. Detector = RMS
3. RBW=1MHz
4. VBW=3MHz
5. Trace mode = trace average for continuous emissions, max hold for pulse emissions
6. Sweep time = auto couple
7. The trace was allowed to stabilize

Limits

The minimum permissible attenuation level of any spurious emission is $43 + \log_{10}(P)$ (P [Watts]), where P is the transmitter power in Watts.

For Band 30, the minimum permissible attenuation level of any spurious emission <2288MHz and >2365MHz is $70 + \log_{10}(P)$ (P [Watts]).

For Band 7 and 41, the minimum permissible attenuation level of any spurious emission is $55 + \log_{10}(P)$ (P [Watts]).

Test result:

The test results are shown in Appendix A.

6.7 Band Edges Compliance

Rule Part(s)

FCC: 2.1051, 22.917(a), 24.238(a), 27.53(c), 27.53(g), 27.53(h), 27.53(m), 27.53(a)

Ambient condition:

Temperature	Relative humidity	Pressure
25°C	30%	101.9kPa

Test Setup:

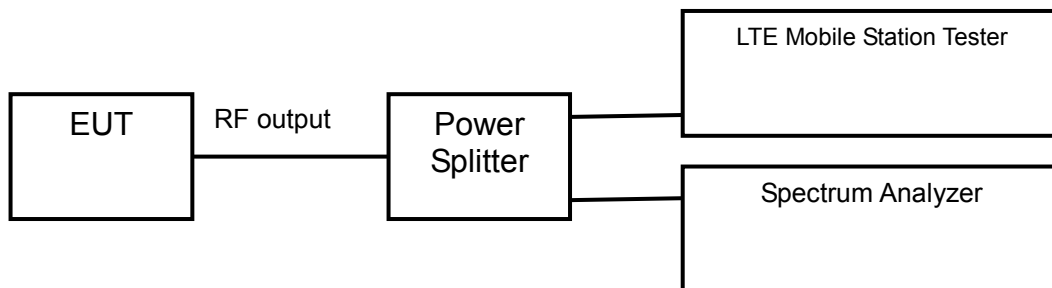

Test procedure:

KDB 971168 D01 v03r01 – Section 6.0

Test Setting:

1. Start and stop frequency were set such that the band edge would be placed in the center of the plot
2. Span was set large enough so as to capture all out of band emissions near the band edge
3. RBW > 1% of the emission bandwidth
4. VBW > 3 x RBW
5. Detector = RMS
6. Number of sweep points $\geq 2 \times \text{Span/RBW}$
7. Trace mode = trace average for continuous emissions, max hold for pulse emissions
8. Sweep time = auto couple
9. The trace was allowed to stabilize

Limits

The minimum permissible attenuation level of any spurious emission is $43 + \log_{10}(P)$ [Watts], where P is the transmitter power in Watts.

The minimum permissible attenuation level for Band 30 is $> 43 + 10\log_{10}(P)$ [Watts] at 2300-2305MHz & 2345-2360MHz, $> 55 + 10\log_{10}(P)$ [Watts] at 2320-2324MHz & 2341-2345MHz, $> 61 + 10\log_{10}(P)$ [Watts] at 2324-2328MHz & 2337-2341MHz, $> 67 + 10\log_{10}(P)$ [Watts] at 2288-2292MHz & 2328- 2337MHz, and $> 70 + 10\log_{10}(P)$ [Watts] at frequencies $< 2288\text{MHz}$ & $> 2365\text{MHz}$.

Per 22.917(b) 24.238(a) 27.53(h) in the 1 MHz bands immediately outside and adjacent to the frequency block a resolution bandwidth of at least one percent of the emission bandwidth of the fundamental emission of the transmitter may be employed to demonstrate compliance with the out-of-band emissions limit. The emission bandwidth is defined as the

width of the signal between two points, one below the carrier center frequency and one above the carrier center frequency, outside of which all emission are attenuated at least 26 dB below the transmitter power.

Per 27.53(g) for operations in the 698-746 MHz band, in the 100 kHz bands immediately outside and adjacent to the frequency block a resolution bandwidth of at least 30 kHz may be employed to demonstrate compliance with the out-of-band emissions limit.

Per 27.53(c)(5) for operations in the 776-788 MHz band, in the 100 kHz bands immediately outside and adjacent to the frequency block a resolution bandwidth of at least 30 kHz may be employed to demonstrate compliance with the out-of-band emissions limit.

For all plots showing emissions in the 763 – 775MHz and 793 – 805MHz band, the FCC limit per 27.53(c)(4) is $65 + 10\log_{10}(P) = -35\text{dBm}$ in a 6.25kHz bandwidth.

Per 27.53(a)(5) in the 1 MHz bands immediately outside and adjacent to the channel blocks at 2305, 2310, 2315, 2320, 2345, 2350, 2355, and 2360 MHz, a resolution bandwidth of at least 1 percent of the emission bandwidth of the fundamental emission of the transmitter may be employed. A narrower resolution bandwidth is permitted in all cases to improve measurement accuracy provided the measured power is integrated over the full required measurement bandwidth (i.e., 1 MHz). The emission bandwidth is defined as the width of the signal between two points, one below the carrier center frequency and one above the carrier center frequency, outside of which all emissions are attenuated at least 26 dB below the transmitter power.

Per 27.53(m) for operations in the BRS/EBS bands, the attenuation factor shall be not less than $40 + 10 \log (P)$ dB on all frequencies between the channel edge and 5 megahertz from the channel edge, $43 + 10 \log (P)$ dB on all frequencies between 5 megahertz and X megahertz from the channel edge, and $55 + 10 \log (P)$ dB on all frequencies more than X megahertz from the channel edge, where X is the greater of 6 megahertz or the actual emission bandwidth. In addition, the attenuation factor shall not be less that $43 + 10 \log (P)$ dB on all frequencies between 2490.5 MHz and 2496 MHz and $55 + 10 \log (P)$ dB at or below 2490.5MHz.

Test result:

The test results are shown in Appendix A.

6.8 Frequency Stability

Rule Part(s)

FCC: 2.1055, 22.355, 24.235, 27.54

Ambient condition:

Temperature	Relative humidity	Pressure
25°C	30%	101.9kPa

Test setup:

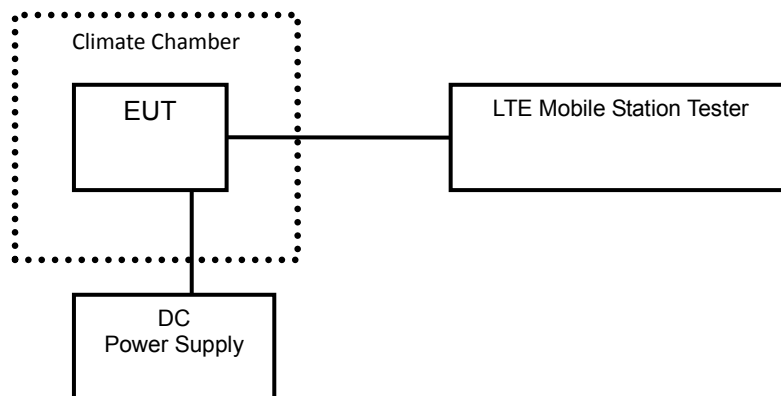

Test Procedure:

ANSI/TIA-603-E-2016

Test Settings

1. The carrier frequency of the transmitter is measured at room temperature (20°C to provide a reference).
2. The equipment is turned on in a “standby” condition for fifteen minutes before applying power to the transmitter. Measurement of the carrier frequency of the transmitter is made within one minute after applying power to the transmitter.
3. Frequency measurements are made at 10°C intervals ranging from -30°C to +50°C (The temperature range can be declared by the manufacturer). A period of at least one half-hour is provided to allow stabilization of the equipment at each temperature level.

Limits: For Part 22, the frequency stability of the transmitter shall be maintained within $\pm 0.00025\%$ (± 2.5 ppm) of the center frequency. For Part 24, Part 27, the frequency stability shall be sufficient to ensure that the fundamental emission stays within the authorized frequency block.

Test result:

The test results are shown in Appendix A.

6.9 Radiated Spurious Emissions

Rule Part(s)

FCC: 2.1053, 22.917(a), 24.238(a), 27.53(c), 27.53(g), 27.53(h), 27.53(f), 27.53(a), 27.53(m)

Ambient condition:

Temperature	Relative humidity	Pressure
25°C	30%	101.9kPa

Test Setup:

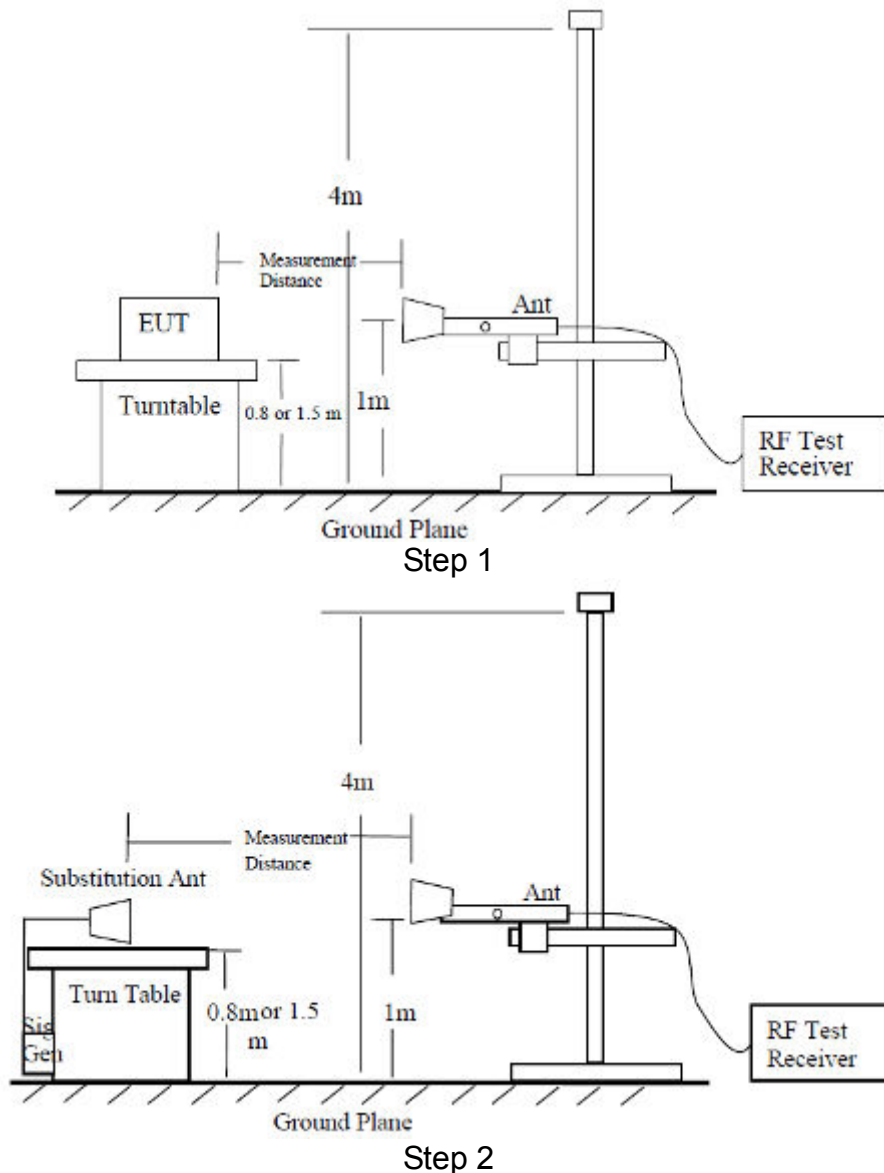

Test procedure:

The measurements procedures in TIA-603-E-2016 are used.

The spectrum was scanned from 30MHz to the 10th harmonic of the highest frequency generated within the equipment.

Step 1:

The measurement is carried out in the chamber. EUT was placed on a 0.8m (f<1GHz)/ 1.5m (f>1GHz) high non-conductive table at a 3 meters test distance from the test receive antenna. A receiving antenna was placed on the antenna mast 3 meters from the EUT. The height of receiving antenna from 1m to 4m and varies in certain range to find the maximum power value. A radio link shall be established between EUT and Tester. The output power of the cell signal of the tester will be decreased until the output power of the EUT reach a maximum value. A peak detector is used and RBW is set to 100 kHz (f<1GHz)/1MHz (f>1GHz). The antenna shall be performed under horizontal and vertical polarization. The turn table shall be rotated from 0 to 360 degrees for detecting the maximum power value on spectrum analyzer or receiver. The spectrum analyzer scans from 30MHz to 10th harmonic of the carrier. A notch filter is necessary in the band near to the carrier frequency. A high pass filter is needed to avoid the distortion of the testing equipment in the band above the carrier frequency.

Step 2:

A log-periodic antenna or double-ridged waveguide horn antenna shall be substituted in place of the EUT. The log-periodic antenna will be driven by a signal generator and the level will be adjusted till the same power value on the spectrum analyzer or receiver. The level of the spurious emissions can be calculated through the level of the signal generator, cable loss, the gain of the substitution antenna and the reading of the spectrum analyzer or receiver.

A power (P_{mea}) is applied to the input of the substitution antenna, and adjusts the level of the signal generator output until the value of the receiver reach the previously recorded (P_r). The power of signal source (P_{mea}) is recorded. The test should be performed by rotating the test item and adjusting the receiving antenna polarization.

A "reference path loss" should be calculated after test. The attenuation of "reference path loss" is the cable loss between the Signal Source with the Substitution Antenna (P_{ca}) and the Substitution Antenna Gain (G_a).

Calculation procedure:

The data of cable loss and antenna gain has been calibrated in full testing frequency range before the testing.

The power of the Radiated Spurious Emissions is calculated by adding the cable loss and antenna gain. The basic equation with a sample calculation is as followed:

$$\text{Power (EIRP)} = P_{\text{mea}} + P_{\text{ca}} + G_{\text{a}}$$

This value is EIRP since the measurement is calibrated using an antenna of known gain (2.15dB) and known input power. ERP can be calculated from EIRP by subtracting the gain of the dipole, ERP = EIRP – 2.15 (dB).

Assumed the power of signal source record is -20dBm. A cable loss of -30dB, and an antenna gain of 11dB are added.

$$P = P_{\text{mea}} + P_{\text{ca}} + G_{\text{a}} = (-20\text{dBm}) + (-30\text{dB}) + (11\text{dB}) = -39\text{dBm}$$

Test result:

The test results are shown in Appendix B.

7 MEASUREMENT UNCERTAINTIES

Items	Uncertainty	
RF Power Output	0.6 dB	
Occupied Bandwidth	3 kHz	
Spurious Emissions	30MHz~1GHz	2.83 dB
	1GHz~12.75GHz	2.50 dB
	12.75GHz~25GHz	2.75 dB
Band Edges Compliance	1.2dB	
Frequency Stability	4 Hz	

8 TEST EQUIPMENTS

No.	Name/Model	Manufacturer	S/N	Calibration Date	Calibration Due Date
1	MT8820C Mobile Station Tester	Anritsu	6201300660	2020.08.20	2021.08.19
2	FSV40 Spectrum Analyzer	R&S	101065	2020.08.20	2021.08.19
2	N9020A Spectrum Analyzer	Agilent	MY48010771	2020.08.20	2021.08.19
3	6007 Power Divider	Weinschel	6007-GJ-1	2020.08.20	2021.08.19
4	DC Power Supply E3645A	Agilent	MY40000741	2020.03.01	2021.02.28
5	Temperature chamber SH241	ESPEC	92013758	2020.08.20	2021.08.19
6	12.65m×8.03m×7.50m Fully-Anechoic Chamber	FRANKONIA	----	----	----
7	23.18m×16.88m×9.60m Semi-Anechoic Chamber	FRANKONIA	---	----	----
8	Turn table Diameter:1m	FRANKONIA	----	----	----
9	Turn table Diameter:5m	FRANKONIA	----	----	----
10	Antenna master FAC(MA4.0)	MATURO	----	----	----
11	Antenna master SAC(MA4.0)	MATURO	----	----	----
12	9.080m×5.255m×3.525m Shielding room	FRANKONIA	----	----	----
13	HF 907 Double-Ridged Waveguide Horn Antenna	R&S	100512	2020.08.20	2021.08.19
14	HF 907 Double-Ridged Waveguide Horn Antenna	R&S	100513	2020.08.20	2021.08.19
15	HL562 Ultra log antenna	R&S	100016	2020.08.20	2021.08.19
16	3160-09 Receive antenna	SCHWARZ-BECK	002058-002	2020.08.20	2021.08.19
17	ESI 40 EMI test receiver	R&S	100015	2020.08.20	2021.08.19
18	ESCS30 EMI test receiver	R&S	100029	2020.08.20	2021.08.19
19	HL562 Receive antenna	R&S	100167	2020.08.20	2021.08.19
20	ENV216 AMN	R&S	3560.6550.12	2020.08.20	2021.08.19

APPENDIX A – TEST DATA OF CONDUCTED EMISSION

Please refer to the attachment.

APPENDIX B – TEST DATA OF RADIATED EMISSION

Please refer to the attachment.